

'AMC and GM to Part-ATS — Issue 1, Amendment 2'

Annex IV to Decision 2017/001/R is amended as follows:

The text of the amendment is arranged to show deleted text, new or amended text as shown below:

- (a) deleted text is ~~struck through~~;
- (b) new or amended text is highlighted in **blue**;
- (c) an ellipsis [...] indicates that the rest of the text is unchanged.

GM1 Annex IV (Part-ATS)

GENERAL

In the context of the AMC and GM to Part-ATS, the terms listed below have the following meaning:

- 'accepting air traffic controller (ATCO)' refers to the air traffic controller next to take control of an aircraft;
- 'accepting control unit' refers to the air traffic control unit next to take control of an aircraft;
- 'advisory airspace' refers to an airspace of defined dimensions, or designated route, within which air traffic advisory service is available;
- 'advisory route' refers to a designated route along which air traffic advisory service is available;
- 'airborne collision avoidance system (ACAS)' refers to an aircraft system based on secondary surveillance radar (SSR) transponder signals which operates independently of ground-based equipment to provide advice to the pilot on potential conflicting aircraft that are equipped with SSR transponders;
- 'aircraft address' refers to a unique combination of 24 bits available for assignment to an aircraft for the purpose of air-ground communications, navigation and surveillance;
- 'air-taxiing' refers to the movement of a helicopter/vertical take-off and landing (VTOL) aircraft above the surface of an aerodrome, normally in ground effect and at a ground speed normally less than 37 km/h (20 kt). The actual height may vary, and some helicopters may require air-taxiing above 8 m (25 ft) above ground level (AGL) to reduce ground effect turbulence or provide clearance for cargo slingloads;
- 'air traffic' refers to all aircraft in flight or operating on the manoeuvring area of an aerodrome;
- 'approach sequence' refers to the order in which two or more aircraft are cleared to approach to land at the aerodrome;
- 'base turn' refers to a turn executed by the aircraft during the initial approach between the end of the outbound track and the beginning of the intermediate or final approach track. The tracks are not reciprocal. Base turns may be designated as being made either in level flight or while descending, according to the circumstances of each individual procedure;
- 'change-over point' refers to the point at which an aircraft navigating on an ATS route segment defined by reference to very high-frequency omnidirectional radio ranges is expected to transfer its primary navigational reference from the facility behind the aircraft to the next facility ahead of the aircraft. Change-over points are established to provide the optimum balance in respect of signal strength and quality between facilities at all levels to be used and to ensure a common source of azimuth guidance for all aircraft operating along the same portion of a route segment;
- 'common point' refers to a point on the surface of the earth common to the tracks of two aircraft, used as a basis for the application of separation (e.g. significant point, waypoint, navigation aid, fix);

- ‘controller-pilot’ refers to in different contexts the interaction between air traffic controllers and pilots;
- ‘cruise climb’ refers to an aeroplane cruising technique resulting in a net increase in altitude as the aeroplane mass decreases;
- ‘decision altitude (DA) or decision height (DH)’ refers to a specified altitude or height in a 3D instrument approach operation at which a missed approach must be initiated if the required visual reference to continue the approach has not been established. DA is referenced to mean sea level, and DH is referenced to the threshold elevation. The required visual reference is that section of the visual aids or of the approach area which should have been in view for sufficient time for the pilot to have made an assessment of the aircraft position and rate of change of position, in relation to the desired flight path. In Category III operations with a DH, the required visual reference is that specified for the particular procedure and operation;
- ‘discrete code’ refers to a four-digit SSR code with the last two digits not being ‘00’;
- ‘emergency phase’ refers to a generic term meaning, as the case may be, uncertainty phase, alert phase or distress phase;
- ‘estimated elapsed time’ refers to the estimated time required to proceed from one significant point to another;
- ‘expected approach time’ refers to the time at which air traffic control (ATC) expects that an arriving aircraft, following a delay, will leave the holding fix to complete its approach for a landing. The actual time of leaving the holding fix will depend upon the approach clearance;
- ‘filed flight plan’ refers to the flight plan as filed with an air traffic services unit by the pilot or a designated representative, without any subsequent changes. When the word ‘message’ is used as a suffix to this term, it denotes the content and format of the filed flight plan data as transmitted;
- ‘flight path monitoring’ refers to the use of ATS surveillance systems for the purpose of providing aircraft with information and advice relative to significant deviations from nominal flight path, including deviations from the terms of their ATC clearances;
- ‘ground effect’ refers to a condition of improved performance (lift) due to the interference of the surface with the airflow pattern of the rotor system when a helicopter or other VTOL aircraft is operating near the ground. Rotor efficiency is increased by ground effect to a height of about one rotor diameter for most helicopters;
- ‘initial approach segment’ refers to that segment of an instrument approach procedure between the initial approach fix and the intermediate approach fix or, where applicable, the final approach fix or point;
- ‘landing area’ refers to that part of a movement area intended for the landing or take-off of aircraft;
- ‘minimum fuel’ is a term to be used to describe a situation in which an aircraft’s fuel supply has reached a state where the flight is committed to land at a specific aerodrome and no additional delay can be accepted;

- ‘multilateration (MLAT) system’ refers to a group of equipment configured to provide position derived from the SSR transponder signals (replies or squitters) primarily using time difference of arrival (TDOA) techniques. Additional information, including identification, can be extracted from the received signals);
- ‘normal operating zone (NOZ)’ refers to airspace of defined dimensions extending to either side of a published instrument approach procedure final approach course or track. Only that half of the NOZ adjacent to a no transgression zone (NTZ) is taken into account in independent parallel approaches;
- ‘no transgression zone (NTZ)’ refers to, in the context of independent parallel approaches, a corridor of airspace of defined dimensions located centrally between the two extended runway centre lines, where a penetration by an aircraft requires an air traffic controller intervention to manoeuvre any threatened aircraft on the adjacent approach;
- ‘obstacle clearance altitude (OCA)’ refers to the lowest altitude above the elevation of the relevant runway threshold or the aerodrome elevation as applicable, used in establishing compliance with appropriate obstacle clearance criteria. The OCA is referenced to mean sea level;
- ‘obstacle clearance height (OCH)’ refers to the lowest height above the elevation of the relevant runway threshold or the aerodrome elevation as applicable, used in establishing compliance with appropriate obstacle clearance criteria. OCH is referenced to the threshold elevation or in the case of non-precision approach procedures to the aerodrome elevation or the threshold elevation if that is more than 2 m (7 ft) below the aerodrome elevation. An OCH for a circling approach procedure is referenced to the aerodrome elevation;
- ‘onward clearance time’ refers to the time at which an aircraft can expect to leave the fix at which it is being held;
- ‘procedural ATC service’ refers to a term that is used to indicate that information derived from an ATS surveillance system is not required for the provision of air traffic control service;
- ‘procedural separation’ refers to the separation used when providing the procedural air traffic control service;
- ‘procedure turn’ refers to a manoeuvre in which a turn is made away from a designated track followed by a turn in the opposite direction to permit the aircraft to intercept and proceed along the reciprocal of the designated track. Procedure turns are designated ‘left’ or ‘right’ according to the direction of the initial turn. Procedure turns may be designated as being made either in level flight or while descending, according to the circumstances of each individual procedure;
- ‘PSR blip’ refers to the visual indication, in a non-symbolic form, on a situation display, of the position of an aircraft obtained by primary radar;
- ‘radar approach’ refers to an approach in which the final approach phase is executed under the direction of an air traffic controller using radar;
- ‘radar clutter’ refers to the visual indication, on a situation display, of unwanted signals;
- ‘radar contact’ refers to the situation which exists when the radar position of a particular aircraft is seen and identified on a situation display;

- ‘reporting point’ refers to a specified geographical location in relation to which the position of an aircraft can be reported;
- ‘runway-holding position’ refers to a designated position intended to protect a runway, an obstacle limitation surface, or an instrument landing system (ILS)/microwave landing system (MLS) critical/sensitive area at which taxiing aircraft and vehicles shall stop and hold unless otherwise authorised by the aerodrome control tower. In radiotelephony phraseologies, the expression ‘holding point’ is used to designate the runway-holding position;
- ‘runway incursion’ refers to any occurrence at an aerodrome involving the incorrect presence of an aircraft, vehicle or person on the protected area of a surface designated for the landing and take-off of aircraft;
- ‘runway strip’ refers to a defined area including the runway and stopway, if provided, intended to:
 - (a) reduce the risk of damage to aircraft running off a runway; and
 - (b) protect aircraft flying over it during take-off or landing operations;
- ‘segregated parallel operations’ refers to simultaneous operations on parallel or near-parallel instrument runways in which one runway is used exclusively for approaches and the other runway is used exclusively for departures;
- ‘SSR response’ refers to the visual indication, in a non-symbolic form, on a situation display, of a response from an SSR transponder in reply to an interrogation;
- ‘stopway’ refers to a defined rectangular area on the ground at the end of take-off run available, prepared as a suitable area in which an aircraft can be stopped in the case of an abandoned take-off;
- ‘total estimated elapsed time’ refers to, for IFR flights, the estimated time required from take-off to arrive over that designated point, defined by reference to navigation aids, from which it is intended that an instrument approach procedure will be commenced, or, if no navigation aid is associated with the destination aerodrome, to arrive over the destination aerodrome. For VFR flights, it refers to the estimated time required from take-off to arrive over the destination aerodrome;
- ‘touchdown’ refers to the point where the nominal glide path intercepts the runway. ‘Touchdown’ as defined above is only a datum and is not necessarily the actual point at which the aircraft will touch the runway;
- ‘touchdown zone’ refers to the portion of a runway, beyond the threshold, intended as the first point of contact between landing aircraft and the runway;
- ‘visual surveillance system’ refers to an electro-optical system providing an electronic visual presentation of traffic and any other information necessary to maintain situational awareness at an aerodrome and its vicinity.

AMC1 ATS.OR.110 Coordination between aerodrome operators and air traffic services providers

ESTABLISHMENT AND IDENTIFICATION OF STANDARD TAXI ROUTES

- (a) The air traffic services provider, in coordination with the aerodrome operator, should assess the necessity for establishing standard routes for taxiing aircraft on an aerodrome between runways, aprons and maintenance areas.
- (b) When established, such routes should be direct, simple and, where practicable, designed to avoid traffic conflicts.
- (c) Standard routes for taxiing aircraft should be identified by designators distinctively different from those of the runways and ATS routes.

AMC2 ATS.OR.110 Coordination between aerodrome operators and air traffic services providers

INFORMATION EXCHANGE ON THE AERODROME CONDITIONS AND OPERATIONAL STATUS OF AERODROME FACILITIES

The air traffic services provider should establish arrangements with the aerodrome operator for the exchange of information regarding the aerodrome conditions, in particular the operational conditions of the movement area, including the existence of temporary hazards, and the operational status of any associated facilities at the aerodrome(s) with which they are concerned.

AMC3 ATS.OR.110 Coordination between aerodrome operators and air traffic services providers

APRON MANAGEMENT SERVICES

The air traffic services provider should establish arrangements, including a coordination procedure, with the aerodrome operator and, when applicable, with the other organisation(s) providing apron management services. The coordination procedure between the provider(s) of apron management services and the air traffic services provider should contain at least the following:

- (a) the boundaries of the respective areas of responsibilities as described according to ADR.OPS.D.005 of Regulation (EU) No 139/2014;
- (b) the handover points between apron and manoeuvring area;
- (c) the holding areas;
- (d) the means of guidance for the aircraft taxiing;
- (e) the operational information to be exchanged between both parties; and
- (f) the push back operations, when interfering with the manoeuvring area.

AMC4 ATS.OR.110 Coordination between aerodrome operators and air traffic services providers**COORDINATION FOR LOW-VISIBILITY OPERATIONS**

The air traffic services provider should establish arrangements with the aerodrome operator and, where established, with the apron management services provider(s) for the relevant aspects and the definition of the respective responsibilities in conducting low-visibility operations (LVOs), in addition to those established in ATS.TR.265(b).

AMC5 ATS.OR.110 Coordination between aerodrome operators and air traffic services providers**COORDINATION FOR RUNWAYS INSPECTIONS**

The air traffic services provider should coordinate with the aerodrome operator the conduct of routine and non-routine runway inspections.

AMC6 ATS.OR.110 Coordination between aerodrome operators and air traffic services providers**INFORMATION ON THE SAFE USE OF THE MANOEUVRING AREA**

When a not previously notified condition pertaining to the safe use by aircraft of the manoeuvring area is reported to or observed by the aerodrome air traffic controllers or by aerodrome flight information services (AFIS) officers, the air traffic services provider should inform the aerodrome operator, and should ensure that operations on that part of the manoeuvring area are terminated until otherwise advised by the aerodrome operator.

GM1 ATS.OR.110 Coordination between aerodrome operators and air traffic services providers**COORDINATION FOR THE AERODROME MANUAL**

The air traffic services provider should establish close coordination with the aerodrome operator to participate in the development of the elements of the aerodrome manual pertaining to the services it provides.

GM1 ATS.OR.125(a) Coordination between aeronautical information services and air traffic services providers**PUBLICATION OF REDUCED RUNWAY SEPARATION MINIMA**

The air traffic services provider should arrange to publish all applicable procedures related to the application of reduced runway separation minima as in AMC9 ATS.TR.210(c)(2)(i) in the aeronautical information publication (AIP) and to include them also in the local ATC instructions.

GM2 ATS.OR.125(a) Coordination between aeronautical information services and air traffic services providers

PROMULGATION OF INFORMATION ON AFIS

The air traffic services provider should arrange to report information regarding the availability of AFIS and related procedures for its inclusion in the relevant parts of the AIP in the same manner as in the case of aerodromes provided with air traffic control service, in accordance with Appendix I to Annex VI (Part-AIS). The information includes but is not limited to the following:

- (a) identification of the aerodrome;
- (b) location and identification of the AFIS unit;
- (c) hours of operation of the AFIS unit. For aerodromes where there is an alternation of the air traffic control service and AFIS provision, hours of operation of both services;
- (d) lateral and vertical limits of the associated airspace;
- (e) language(s) used;
- (f) detailed description of the services provided, including alerting service and, if applicable, use of direction-finding;
- (g) special procedures for application by pilots; and
- (h) any other pertinent information.

GM1 ATS.OR.125(c) Coordination between aeronautical information services and air traffic services providers

ORIGIN OF AERONAUTICAL INFORMATION

Information to be reported by the air traffic services provider to the AIS provider for the purpose of air traffic services may originate also from other entities, such as the aerodrome operator, the apron management services provider, CNS service providers, etc.

GM1 ATS.OR.125(d) Coordination between aeronautical information services and air traffic services providers

Of particular importance are changes to aeronautical information that affect charts and/or computer-based navigation systems which qualify to be notified by the aeronautical information regulation and control (AIRAC) system, as stipulated in AIS.OR.505 and AIS.TR.505.

GM1 ATS.OR.135 Contingency arrangements

The various circumstances surrounding each ATS contingency situation preclude the establishment of exact detailed procedures to be followed.

GM2 ATS.OR.135 Contingency arrangements**RADIO COMMUNICATION CONTINGENCIES IN AIR TRAFFIC CONTROL SERVICE****(a) General**

Air traffic control contingencies related to communications, i.e. circumstances preventing an air traffic controller from communicating with aircraft under control, may be caused by either a failure of ground radio equipment, a failure of airborne equipment, or by the control frequency being inadvertently blocked by an aircraft or a ground transmitter, or any unauthorised use. The duration of such events may be for prolonged periods and appropriate action to ensure that the safety of aircraft is not affected should therefore be taken immediately.

(b) Complete ground radio failure

(1) In the event of complete failure of the ground radio equipment used for air traffic control service, the air traffic controller should:

- (i) attempt to establish radio communications on the emergency frequency 121.500 MHz;
- (ii) without delay inform all adjacent control positions or air traffic control units, as applicable, of the failure;
- (iii) apprise such positions or units of the current traffic situation;
- (iv) request their assistance, in respect of aircraft which may establish communications with those positions or units, in establishing and maintaining separation between such aircraft; and
- (v) instruct adjacent control positions or air traffic control units to hold or re-route all controlled flights outside the area of responsibility of the position or air traffic control unit that has experienced the failure until such time that the provision of normal services can be resumed,

unless able to continue to provide air traffic services by means of other available communication channels.

(2) In order to reduce the impact of complete ground radio equipment failure on the safety of air traffic, the air traffic services provider should establish contingency procedures to be followed by control positions and air traffic control units in the event of such failures. Where agreed between affected air traffic services providers, such contingency procedures should provide for the delegation of control to an adjacent control position or air traffic control unit in order to permit a minimum level of services to be provided as soon as possible, following the ground radio failure and until normal operations can be resumed.

(c) Blocked frequency

In the event that the control frequency is inadvertently blocked by an aircraft transmitter, the following additional steps should be taken:

- (1) attempt to identify the aircraft concerned;

- (2) if the aircraft blocking the frequency is identified, attempts should be made to establish communication with that aircraft, e.g. on the emergency frequency 121.500 MHz, by SELCAL, through the aircraft operator's company frequency if applicable, on any VHF frequency designated for air-to-air use by flight crews or any other communication means or, if the aircraft is on the ground, by direct contact; and
- (3) if communication is established with the aircraft concerned, the flight crew should be instructed to take immediate action to stop inadvertent transmissions on the affected control frequency.

(d) Unauthorised use of ATC frequency

Instances of false and deceptive transmissions on air traffic control frequencies which may impair the safety of aircraft can occasionally occur. In the event of such occurrences, the air traffic control unit concerned should:

- (1) correct any false or deceptive instructions or clearances which have been transmitted;
- (2) advise all aircraft on the affected frequency(ies) that false and deceptive instructions or clearances are being transmitted;
- (3) instruct all aircraft on the affected frequency(ies) to verify instructions and clearances before taking action to comply;
- (4) if practical, instruct aircraft to change to another frequency; and
- (5) if possible, advise all aircraft affected when the false and deceptive instructions or clearances are no longer being transmitted.

GM3 ATS.OR.135 Contingency arrangements

CONTINGENCY PROCEDURES FOR AIR TRAFFIC SERVICES UNITS WHEN A VOLCANIC ASH CLOUD IS REPORTED OR FORECAST

If a volcanic ash cloud is reported or forecast in the airspace for which the air traffic services unit is responsible, the following actions should be taken, as appropriate:

- (a) relay pertinent information immediately to flight crews whose aircraft could be affected to ensure that they are aware of the ash cloud's current and forecast position and the flight levels affected;
- (b) accommodate requests for re-routing or level changes to the extent practicable;
- (c) suggest re-routing to avoid or exit areas of reported or forecast ash clouds when requested by the pilot or deemed necessary by the air traffic controller; and
- (d) when practicable, request a special air-report when the route of flight takes the aircraft into or near the forecast ash cloud and provide such special air-reports to the appropriate agencies.

GM4 ATS.OR.135 Contingency arrangements

Guidance on contingency planning for air navigation services providers, including air traffic services providers, may be found in:

- (a) ICAO Annex 11 - Attachment C 'Material relating to contingency planning'; and
- (b) the 'EUROCONTROL Guidelines for Contingency Planning of Air Navigation Services (including Service Continuity)' Edition 2.0 of 06/04/2009, available at:

<https://www.eurocontrol.int/sites/default/files/article/content/documents/nm/safety/safety-guidelines-contingency-planning-ans-2009.pdf>,

and in its complementary document named 'Reference Guide to EUROCONTROL Guidelines for Contingency Planning of Air Navigation Services (including Service Continuity)' Edition 2.0 of 06/04/2009, available at:

<https://www.eurocontrol.int/publication/eurocontrol-guidelines-contingency-planning-air-navigation-services>.

GM1 ATS.OR.140 Failure and irregularity of systems and equipment

ATS.OR.140 is complementary to the existing requirements on reporting stemming from Regulation (EU) No 376/2014 and on the reporting arrangements that ATM/ANS providers have to establish in accordance with principles and requirements on the management system set in ATM/ANS.OR.B.005 in Annex III to Regulation (EU) 2017/373. However, the primary objective of ATS.OR.140 is the timely dissemination of information needed for the safe and efficient air traffic control service and flight information service provision (e.g. information on changes in the availability of radio navigation services). The arrangements should also support the timely issuance of NOTAMs concerning the relevant information to be disseminated, in accordance with the applicable requirements in ATM/ANS.OR.A.085 in Annex III to Regulation (EU) 2017/373.

AMC1 ATS.OR.145 Operation of air traffic control service

PRESENTATION AND UPDATING OF FLIGHT PLAN AND CONTROL DATA AND OTHER RELEVANT INFORMATION FOR THE AIR TRAFFIC CONTROL SERVICE PROVISION

- (a) The air traffic services provider should ensure that sufficient information and data are presented in such a manner as to enable the air traffic controller to have a complete representation of the current air traffic situation within the air traffic controller's area of responsibility and, when relevant, movements on the manoeuvring area of aerodromes.
- (b) The presentation should be updated in accordance with the progress of aircraft in order to facilitate the timely detection and resolution of conflicts as well as to facilitate and provide a record of coordination with adjacent air traffic services units and control sectors.
- (c) An appropriate representation of the airspace configuration, including significant points and information related to such points, should be provided.

- (d) Data to be presented should include relevant information from flight plans and position reports as well as clearance and coordination data.
- (e) The information display may be generated and updated automatically, or the data may be entered and updated by authorised personnel.
- (f) Data generated automatically should be presented to the air traffic controller in a timely manner. The presentation of information and data for individual flights should continue until such time as the data is no longer required for the purpose of providing control, including conflict detection and the coordination of flights, or until terminated by the air traffic controller.
- (g) All information and data as in point (a), including data related to individual aircraft, should be presented in a manner minimising the potential for misinterpretation or misunderstanding.

GM1 ATS.OR.145 Operation of air traffic control service

PRESENTATION AND UPDATING OF FLIGHT PLAN AND CONTROL DATA AND OTHER RELEVANT INFORMATION FOR THE AIR TRAFFIC CONTROL SERVICE PROVISION

Human factors principles should be considered when establishing the provisions and procedures stipulated in ATS.OR.145. The SESAR Joint Undertaking has developed a project titled 'Human Performance in Automation Support' (Project Nr. 16.05), which addressed the subject. The relevant final Project Report may be found at https://www.sesarju.eu/sites/default/files/DEL_16.05-D09-Final_Project_Report_00.01.00.pdf.

GM2 ATS.OR.145 Operation of air traffic control service

PRESENTATION AND UPDATING OF FLIGHT PLAN AND CONTROL DATA AND OTHER RELEVANT INFORMATION FOR THE AIR TRAFFIC CONTROL SERVICE PROVISION

Other information required or desirable for the air traffic control service provision may be but is not limited to:

- (a) relevant meteorological information;
- (b) NOTAMs;
- (c) airspace-related information;
- (d) status of radio navigation services and visual aids;
- (e) aerodrome conditions and the operational status of associated facilities, where appropriate;
- (f) unmanned free balloons; and
- (g) others.

GM3 ATS.OR.145 Operation of air traffic control service

PRESENTATION AND UPDATING OF FLIGHT PLAN AND CONTROL DATA AND OTHER RELEVANT INFORMATION FOR THE AIR TRAFFIC CONTROL SERVICE PROVISION

- (a) The required flight plan and control data may be presented through the use of paper flight progress strips or electronic flight progress strips, by other electronic presentation forms or by a combination of presentation methods.

- (b) The air traffic services provider should specify the procedures for annotating data and provisions specifying the types of data to be entered on flight progress strips, including the use of symbols.

GM1 ATS.OR.150 Transfer of responsibility for control and transfer of communications

GUIDANCE ON LETTERS OF AGREEMENT BETWEEN AIR TRAFFIC SERVICES UNITS

Guidance on the drafting of operational Letters of Agreement between air traffic services units may be found in the EUROCONTROL Guidelines 'Common Format Letter of Agreement Between Air Traffic Services Units' Edition 5.0 of 15.10.2019, available at <https://www.eurocontrol.int/publication/common-format-letter-agreement-between-air-traffic-services-units>.

GM2 ATS.OR.150 Transfer of responsibility for control and transfer of communications

TRANSFER OF COMMUNICATION

- (a) Except when separation minima based on ATS surveillance systems specified in AMC1 ATS.TR.210(c)(2), AMC6 ATS.TR.220 and point (d) of AMC7 ATS.TR.220 are being applied, the transfer of air-ground communications of an aircraft from the transferring to the accepting control unit should be made 5 minutes before the time at which the aircraft is estimated to reach the common control area boundary unless otherwise agreed between the two air traffic control units concerned.
- (b) Between two air traffic services units applying separation minima based on ATS surveillance systems specified in AMC1 ATS.TR.210(c)(2), AMC6 ATS.TR.220 and point (d) of AMC7 ATS.TR.220 at the time of transfer of control, the transfer of air-ground communications of an aircraft from the transferring to the accepting control unit should be made immediately after the accepting control unit has agreed to assume control.
- (c) The transfer of air-ground communications to the aerodrome air traffic controller should be effected at such a point, level, or time, that clearance to land or alternative instructions, as well as information on essential local traffic, can be issued in a timely manner.
- (d) The accepting control unit should notify the transferring unit in the event that communication with the aircraft is not established as expected.
- (e) In cases where a portion of a control area is so situated that the time taken by aircraft to traverse it is of a limited duration, agreement should be reached to provide for direct transfer of communication between the units responsible for the adjacent control areas, provided that the intermediate unit is fully informed of such traffic. The intermediate unit should retain responsibility for coordination and for ensuring that separation is maintained between all traffic within its area of responsibility.
- (f) An aircraft may be permitted to communicate temporarily with a control unit other than the unit controlling the aircraft.

AMC2 ATS.OR.205(b)(4) Safety assessment and assurance of changes to the functional system

RISK MITIGATION

When the risk evaluation results show that the safety criteria cannot be satisfied, then the air traffic services provider should either abandon the change or propose additional means of mitigating the risk. If risk mitigation is proposed, then the air traffic services provider should ensure that it identifies:

- (a) all of the elements of the functional system, e.g. training, procedures that need to be reconsidered; and
- (b) for each part of the amended change, those parts of the safety assessment (from (a)1) to (f)6) listed in ATS.OR.205(b)) that need to be repeated in order to demonstrate that the safety criteria will be satisfied.

GM1 ATS.OR.400(a) Aeronautical mobile service (air-ground communications) — general

RELIABILITY AND AVAILABILITY OF RADIO COMMUNICATIONS AND NAVIGATION AIDS

When providing ATS surveillance service, the air traffic services provider should ensure that the levels of reliability and availability of communication systems are such that the possibility of system failures or significant degradations is very remote, and that adequate backup facilities are provided.

Guidance material and information pertaining to system reliability and availability may be found in ICAO Annex 10 Volume I, and in particular in Attachment F 'Guidance material concerning reliability and availability of radio communications and navigation aids' thereto.

GM1 ATS.OR.405 Use and availability of the VHF emergency frequency

LISTENING WATCH OF THE VHF EMERGENCY CHANNEL

Requirements for air traffic services units to maintain continuous guard on the emergency frequency 121.500 MHz are specified in SERA.14080(b) of Regulation (EU) No 923/2012.

GM1 ATS.OR.405(a)(3) Use and availability of the VHF emergency frequency

USE OF VHF EMERGENCY CHANNEL IN CASE OF HANDLING OF DISTRESS TRAFFIC

The use of the frequency 121.500 MHz for the purpose outlined in point (a)(3) of ATS.OR.405 is to be avoided if it interferes in any way with the efficient handling of distress traffic.

GM1 ATS.OR.405(b) Use and availability of the VHF emergency frequency**VHF EMERGENCY CHANNEL**

Where two or more of the air traffic services units listed in point (b) of ATS.OR.405 are co-located, provision of the frequency 121.500 MHz at one would meet the requirement.

GM1 ATS.OR.410(a) Aeronautical mobile service (air-ground communications) — flight information service

Whenever practicable, air-ground communication facilities for flight information service should permit direct, rapid, continuous and static-free two-way communications.

AMC1 ATS.OR.415 Aeronautical mobile service (air-ground communications) — area control service

Whenever practicable, air-ground communication facilities for area control service should permit direct, rapid, continuous and static-free two-way communications.

GM1 ATS.OR.415 Aeronautical mobile service (air-ground communications) — area control service

Where air-ground voice communication channels are used for area control service by air-ground communicators, suitable arrangements should be made to permit direct pilot-controller voice communications, as and when required.

GM1 ATS.OR.425(b) Aeronautical mobile service (air-ground communications) — aerodrome control service

Guidance on the establishment of communication channels for the control of traffic operating on the manoeuvring area may be found in Appendix A to Chapter 8, Section 2 of ICAO Doc 9426 'Air Traffic Services Planning Manual'.

GM1 ATS.OR.430(a) Aeronautical fixed service (ground-ground communications) — general

Indication by time of the speed with which the communication should be established is provided as a guide to communication services, particularly to determine the types of communication channels required, e.g. that 'instantaneous' is intended to refer to communications which effectively provide for immediate access between air traffic controllers; '15 seconds' to accept switchboard operation and '5 minutes' to mean methods involving retransmission.

GM1 ATS.OR.430(b) Aeronautical fixed service (ground-ground communications) — general**FAILURE OF AUTOMATED COORDINATION**

In case of failure of the automated coordination, the air traffic controller should facilitate the required coordination using prescribed alternative methods, as established by the air traffic services provider in operation manuals.

GM1 ATS.OR.435(a) Aeronautical fixed service (ground-ground communications) — communication within a flight information region**PROCEDURES FOR DIRECT-SPEECH COMMUNICATIONS**

An air traffic services provider should develop appropriate procedures for direct-speech communications to permit immediate connections to be made for very urgent calls concerning the safety of aircraft, and the interruption, if necessary, of less urgent calls in progress at the time.

GM1 ATS.OR.435(a);(b) Aeronautical fixed service (ground-ground communications) — communication within a flight information region**SUPPLEMENTARY FACILITIES TO THOSE PRESCRIBED FOR COMMUNICATION**

The communication facilities in points (a) and (b) of ATS.OR.435 could be supplemented, as and where necessary, by facilities for other forms of visual or audio communications; for example, closed-circuit television or separate information processing systems.

GM1 ATS.OR.435(c)(4) Aeronautical fixed service (ground-ground communications) — communication within a flight information region**FACILITY FOR DIRECT SPEECH**

The facility for direct speech does not necessarily refer to permanently dedicated point-to-point telephone lines.

GM1 ATS.OR.440(d) Aeronautical fixed service (ground-ground communications) — communication between flight information regions

Special circumstances may be due to traffic density, types of aircraft operations and/or the manner in which the airspace is organised and may exist even if the control areas and/or control zones are not contiguous or have not (yet) been established.

GM1 ATS.OR.445(a) Communications for the control or management of vehicles other than aircraft on manoeuvring areas at aerodromes

SYSTEM OF VISUAL SIGNALS FOR COMMUNICATION BETWEEN AERODROME AIR TRAFFIC SERVICES UNITS AND VEHICLES ON THE MANOEUVRING AREA

(a) When communications by a system of visual signals is deemed to be adequate, or in the case of radio communication failure, the signals given hereunder should have the meaning indicated in the table below.

LIGHTS SIGNAL FROM AERODROME CONTROL	MEANING
Green flashes	Permission to cross landing area or to move onto taxiway
Steady red	Stop
Red flashes	Move off the landing area or taxiway and watch out for aircraft
White flashes	Vacate manoeuvring area in accordance with local instructions

(b) In emergency conditions or if the signals in point (a) are not observed, the signal given hereunder should be used for runways or taxiways equipped with a lighting system and should have the meaning indicated in the table below.

LIGHT SIGNAL	MEANING
Flashing runway or taxiway lights	Vacate the runway and observe the tower for light signal

GM1 ATS.OR.450 Automatic recording of surveillance data

RECORDING OF VISUAL SURVEILLANCE SYSTEM DATA

'Other systems' include also visual surveillance systems utilised in the remote provision of aerodrome air traffic services.

GM1 ATS.OR.505(a) Meteorological information for flight information centres and area control centres

INFORMATION CONCERNING WEATHER DETERIORATION

Certain changes in meteorological conditions are construed as deterioration in a weather element, although they are not ordinarily considered as such. An increase in temperature may, for example, adversely affect the operation of certain types of aircraft.

GM1 ATS.OR.525(a) Information on the operational status of navigation services

PROVISION OF INFORMATION WITH RESPECT TO VISUAL AND NON-VISUAL NAVIGATION AIDS

Guidance material regarding the provision of information to air traffic services units with respect to visual and non-visual navigation aids is contained in ICAO Doc 9426 'Air Traffic Services Planning Manual' (Appendix A to Chapter 10, Part I).

AMC1 ATS.OR.525(b) Information on the operational status of navigation services

PROVISION OF INFORMATION WITH RESPECT TO GNSS

The air traffic services provider should establish formal arrangements with the European Satellite Service Provider (ESSP) and, when feasible, with other providers of satellite services operating within the area of responsibility of the air traffic services provider.

GM1 ATS.OR.525(b) Information on the operational status of navigation services

PROVISION OF INFORMATION WITH RESPECT TO GNSS

Service providers of satellite-based augmentation systems should be considered as CNS providers within the scope of Regulation (EU) 2017/373, hence they should be duly certified. The ESSP has been certified and is overseen by EASA; as such, this provider is obliged to comply with the requirement in ATM/ANS.OR.B.005(f) in Annex III and to conclude appropriate agreements with the air navigation service (including air traffic services) providers concerned. Currently, these arrangements are stipulated in accordance with Section 9.3 of Attachment D to ICAO Annex 10, Volume I. When these arrangements are established, the ESSP provides information on the availability of its services to the relevant air navigation services providers.

~~**GM1 ATS.TR.100(b) Working methods and operating procedures for providers of air traffic services**~~

~~**SPECIAL AND ALTERNATIVE CONDITIONS AND OPERATING PROCEDURES FOR ATS PROVIDERS PROVIDING SERVICES TO FLIGHT TESTS**~~

- ~~(a) While flight tests are regularly conducted in compliance with the standards and the provision specified in ATS.TR.100 (a), some of them need to follow specific additional or alternative conditions and procedures approved by the competent authority to meet the needs of flight tests carried out during the flight. This is also the case for flight tests involving more than one aircraft in the same flight test. These special provisions will not jeopardise the safety of the other airspace users and the population in the area overflown.~~
- ~~(b) In order to ensure safe operations within the provision of air traffic service for flight tests control, the air traffic controllers providing these services may need to have specific knowledge of flight tests and/or be briefed, depending on the specificities of the flight profiles.~~

- ~~(c) — Air traffic controllers that provide air traffic services to flight tests (flight test ATCOs) may need to obtain their specific competence through a dedicated training as specified in Commission Regulation (EU) 2015/340.~~
- ~~(d) — Air traffic services for flight test should be provided through dedicated and specific procedures. These procedures should address:~~
- ~~(1) — Compatibility with other airspace users~~
- ~~(i) — In order to ensure the compatibility of the flight test with other airspace users and to ensure safe operations and an acceptable rate of success of flight test, the air traffic services provider should ensure proper coordination at all levels, including strategic, pre-tactical and real-time coordination.~~
- ~~(ii) — An air traffic services unit providing services to flight test is responsible for ensuring compatibility of their activities with other airspace users.~~
- ~~(2) — Flight plan~~
- ~~The air traffic services unit should obtain all the necessary details related to flight tests (e.g. from the design organisation or the entity wishing to carry out the flight test).~~
- ~~(3) — Flight tests with limited manoeuvrability~~
- ~~During certain phases of the flight test, the capability to normally perform manoeuvres may only be possible after a necessary period of time (e.g. for the flight crew to get into a configuration that allows the execution of these manoeuvres).~~
- ~~The air traffic services provider should obtain the necessary information about the phases of flight and the duration if known.~~
- ~~For the conduct of these flights, the use of a temporarily reserved area is preferred. If unable, after prior coordination with the relevant air traffic services units neighbouring the flight tests, the use of a transponder should be mandated.~~
- ~~This real-time information does not relieve the air traffic services unit responsible for providing services to the flight tests from the obligation to ensure traffic separation and assure compatibility with all airspace users.~~
- ~~(e) — The above-mentioned procedures are not exhaustive and additional provisions may be necessary to meet the needs of flight tests. The paramount principle is anyhow to make provisions without contradicting the standards and the provision specified in ATS.TR.100(a).~~

AMC1 ATS.TR.105(b) Divisions of the air traffic services

AIR TRAFFIC ADVISORY SERVICE IMPLEMENTATION

Class F airspace should only be implemented where the air traffic services are inadequate for the provision of air traffic control service and the limited advice on collision hazards otherwise provided by flight information service is not adequate. Where air traffic advisory service is implemented, this should be considered as a temporary measure only until such time as it can be replaced by air traffic control service or, in cases where the traffic situation changes such that advisory service is no longer required, replaced by flight information service.

AMC2 ATS.TR.105(b) Divisions of the air traffic services COORDINATION IN RESPECT OF THE AIR TRAFFIC ADVISORY SERVICE PROVISION

Air traffic services units providing air traffic advisory service should apply the coordination procedures in ATS.TR.230 and ATS.OR.150 with respect to such aircraft having elected to use this type of service.

GM1 ATS.TR.105(b) Divisions of the air traffic services AIR TRAFFIC ADVISORY SERVICE

- (a) The air traffic advisory service within airspace class F should be provided with the objective of making information on collision hazards more effective than it would be in the mere flight information service provision.
- (b) The air traffic advisory service may be provided to aircraft conducting instrument flight rules (IFR) flights in advisory airspace or on advisory routes (class F airspace), specified by the State concerned.
- (c) Air traffic advisory service does not afford the degree of safety and cannot assume the same responsibilities as air traffic control service in respect of the avoidance of collisions, since information regarding the disposition of traffic in the area concerned available to the unit providing air traffic advisory service may be incomplete.
- (d) The efficiency of air traffic advisory service will depend largely on the procedures and practices in use. Its establishment in line with the organisation, procedures and equipment of area control service, taking into account the basic differences of the two services, will help to ensure a high degree of efficiency and promote uniformity in the various provisions of air traffic advisory service. For example, exchange of information by the units concerned on the progress of an aircraft from one advisory area into an adjacent control area or terminal control area (TMA), and vice versa, will help to relieve pilots from repeating details of their flight plans already filed; also, use of standard ATC phraseology, preceded by the verbs 'suggest' or 'advise', will facilitate the pilot's understanding of air traffic advisory service intelligence.
- (e) Air traffic services units providing air traffic advisory service:
 - (1) advise the aircraft to depart at the time specified and to cruise at the levels indicated in the flight plan if they do not foresee any conflict with other known traffic;
 - (2) suggest to aircraft a course of action by which a potential hazard may be avoided, giving priority to an aircraft already in advisory airspace over other aircraft desiring to enter such advisory airspace; and
 - (3) pass on to aircraft traffic information comprising the same information as that prescribed for area control service.
- (f) The criteria used as a basis for action under points (e)(2) and (e)(3) should be at least those laid down for aircraft operating in controlled airspace and should take into account the limitations inherent in the provision of air traffic advisory service, navigation facilities and air-ground communications prevailing in the region.

GM1 ATS.TR.110(b) Establishment of the units providing air traffic services

ATS REPORTING OFFICE

The reference to an ATS reporting office denotes the functions to be performed by such an office. When addressing the provision of air traffic services, Member States should ensure that the functions of an ATS reporting office are fully implemented by:

- (a) establishing physical offices; and/or
- (b) assigning the duties to any air traffic services unit; and/or
- (c) agreeing with one or more Member State(s) to provide a joint service; and/or
- (d) establishing proper arrangements for the provision of the service by an external agency or external agencies.

GM1 ATS.TR.115(b)(9);(10) Identification of air traffic services units

NAMING OF FLIGHT INFORMATION CENTRE AND AFIS UNIT

Particular attention should be paid when naming flight information centres and AFIS units providing services in contiguous portions of airspace, in order to avoid duplications which could lead to misunderstandings. In this case, the names attached to the respective suffixes of the two units should be different. In this way, compliance with point (a) of ATS.TR.115 concerning unambiguous identification of air traffic services units is ensured.

GM1 ATS.TR.130 Determination of the transition level

DETERMINATION OF A COMMON TRANSITION LEVEL FOR TWO OR MORE AERODROMES

Where a common transition altitude has been established for two or more aerodromes which are so closely located as to require coordinated procedures, the appropriate air traffic services units should establish a common transition level to be used at any given time in the vicinity of the aerodrome and, when relevant, in the TMA concerned.

GM1 ATS.TR.130(b) Determination of the transition level

EXPLANATION FOR THE CONSISTENT NEED FOR THE TERM 'NOMINAL' IN EU REGULATORY MATERIAL

(a) Introduction

ICAO Doc 4444 'PANS ATM' Section 5.3.2 stipulates that the 'vertical separation minimum shall be a 'nominal' 300 m (1 000 ft) below Flight Level 290'. However, the term 'nominal' is used inconsistently in ICAO provisions which relate to the vertical separation minimum. An example of such inconsistency may be found in ICAO Doc 7030 'EUR Regional Supplementary Procedures' Chapter 6.3.1.2 (transposed with some modifications as point (b) of ATS.TR.130) which states that 'the transition level shall be located at least 300 m (1 000 ft) above the transition altitude to permit the transition altitude and the transition level to be used concurrently in cruising flight, with vertical separation ensured'.

In transposing ICAO provisions into the EU regulatory framework, it is considered that consistent descriptions should be used in relation to the determination of the transition level, in order to ensure that the flexibility permitted by ICAO through the use of the term 'nominal' is maintained.

(b) History of the vertical separation minimum

The advent in the early 1950s of commercial turbo jet aircraft operating at high levels necessitated a re-evaluation of the vertical separation minimum and thus, in June 1954, ICAO established the Vertical Separation Minima Panel. Based on the work of this Panel, the use of 1 000 ft vertical separation minimum between IFR traffic below 29 000 ft was agreed by ICAO at the 1958 RAC/SAR Divisional Meeting and incorporated within PANS ATM Section 5.3.2 as highlighted above.

Although ICAO does not define 'nominal', when transposing ICAO provisions into EU legislation, it is necessary to have clear and consistent understanding of the terms in relation to the establishment of a transition level. Accordingly, the Agency notes the following factors relating to the use of the term 'nominal':

- (1) 300 m is equal to 984.3 ft, whilst 1 000ft is equal to 304.8 m;
- (2) the vertical distance between flights at two altitudes or two flight levels, for example FL 090 and FL 100, will only be 300 m (1 000 ft) under conditions where the ICAO Standard Atmosphere (ISA) — ICAO Doc 7488 'Manual of the ICAO Standard Atmosphere' prevails. When conditions in the atmosphere differ from the ICAO ISA, the vertical distance will be greater/less than 300 m (1 000 ft) respectively.

Moreover, in addition to the equivalence between 300 m and 1 000 ft, other factors including variances between aircraft altimeter settings, aircraft total vertical error (TVE) and the dimensions of an aircraft above and below its static pressure source are encompassed within the term 'nominal'.

(c) Determination of the transition level

The transition level is a function of the transition altitude of the aerodrome concerned and the difference between the aerodrome QNH altimeter setting value and the standard pressure setting. Regarding the relationship between pressure and height, the following is to be noted:

- (1) The relationship between height and pressure is non-linear. The specification of the ISA is set out in ICAO Doc 7488 'Manual of the ICAO Standard Atmosphere'.
- (2) The real atmosphere is rarely consistent with the ISA. Consequently, variations in the conditions specified in the ISA generate differences in the vertical distances between surfaces of equal atmospheric pressure, dependent upon an aircraft's level within a particular column of air.
- (3) Altimeters are calibrated against the ISA as defined in ICAO Doc 7488.
- (4) The standard pressure setting is 1013.25 hPa as defined in ICAO Doc 7488.

In those instances where an aerodrome QNH of 1 013 hPa¹ exists, a vertical difference of 6.8 ft exists between 1 013 hPa and 1 013.25 hPa (equivalent to a vertical distance of 27.3 ft per 1 hPa at mean sea level in accordance with the ISA). Where a transition altitude of 6 000 ft exists, this would result in a transition level of FL 75 as detailed below:

(1) Transition altitude 6 000 ft + 1 000 ft (ICAO Doc 7030 EUR Chapter 6.3.1.2) = 7 000 ft

(2) (1 013.25 hPa – 1 013 hPa) x 27.3 ft = 6.825 ft = 7 ft

(3) Transition level = 7 000 ft + 7 ft rounded up to nearest 500 ft increment = FL 75

Consequently, in those instances when the reported aerodrome QNH is 1 013 hPa, a flight level is 'lost' through the need to 'round up' by 493 ft; thus providing a vertical separation of 1 493 ft between aircraft cruising concurrently at the transition altitude and the transition level. In high-density/high-complexity airspace, the loss of airspace capacity that this represents, coupled with the second order effect of increased controller workload, is considered to have a significant impact by industry.

Through the application of a vertical separation minimum of 300 m and considering the 'nominal' equivalence between 300 m and 1 000 ft, ICAO implicitly endorses a vertical separation of only 984.3 ft. Continuing the example given above, the inclusion of the term 'nominal' would permit the transition level to be FL 70, resulting in a vertical separation of 993 ft between aircraft cruising concurrently at the transition altitude and the transition level; a value which remains within the 300 m/984.3 ft equivalence. In this instance, the practical safety effect of a 7 ft reduction in the vertical distance between aircraft is considered to be operationally insignificant.

GM1 ATS.TR.135(b) Minimum cruising level for IFR flights

The lowest usable flight level is that flight level which corresponds to, or is immediately above, the established minimum flight altitude.

GM1 ATS.TR.140(c) Provision of altimeter setting information

The transition level may be included in the approach clearances or provided when requested by the pilot.

GM2 ATS.TR.140(c) Provision of altimeter setting information

The provision of transition level may be accomplished by voice communications, ATIS broadcast or data link.

¹ In accordance with procedures set out in ICAO Annex 3, Appendix 3, para 4.7.3 (transposed as MET.TR.205(g)).

GM1 ATS.TR.145 Suspension of visual flight rules operations on and in the vicinity of an aerodrome

All such suspensions of VFR operations should be accomplished through or notified to the aerodrome control tower.

AMC1 ATS.TR.150 Aeronautical ground lights PROCEDURES FOR THE OPERATION OF AERONAUTICAL GROUND LIGHTS

- (a) Except as provided in point (b), all aeronautical ground lights should be operated:
- (1) continuously during the hours of darkness or during the time the centre of the sun's disc is more than 6 degrees below the horizon, whichever requires the longer period of operation, unless otherwise provided hereafter or otherwise required for the control of air traffic; and
 - (2) at any other time when their use, based on meteorological conditions, is considered desirable for the safety of air traffic.
- (b) Lights on and in the vicinity of aerodromes that are not intended for en-route navigation purposes may be turned off, subject to further provisions hereafter, if no likelihood of either regular or emergency operation exists, provided that they can be again brought into operation at least one hour before the expected arrival of an aircraft.
- (c) At aerodromes equipped with lights of variable intensity, a table of intensity settings, based on conditions of visibility and ambient light, should be provided for the guidance of air traffic services personnel in effecting adjustment of these lights to suit the prevailing conditions. When so requested by an aircraft, further adjustment of the intensity should be made whenever possible.
- (d) In addition to point (a), approach lighting should also be operated:
- (1) by day when requested by an approaching aircraft; and
 - (2) when the associated runway lighting is operated.
- (e) The lights of a visual approach slope indicator system should be operated during the hours of daylight as well as of darkness and irrespective of the visibility conditions when the associated runway is being used.
- (f) Runway lighting should not be operated if that runway is not in use for landing, take-off or taxiing purposes unless required for runway inspections or maintenance.
- (g) If runway lighting is not operated continuously, lighting following a take-off should be provided as specified below:
- (1) at aerodromes where air traffic control service is provided and where lights are centrally controlled, the lights of one runway should remain lighted after take-off as long as is considered necessary for the return of the aircraft due to an emergency occurring during or immediately after take-off;

- (2) at aerodromes without air traffic control service or without centrally controlled lights, the lights of one runway should remain lighted until such time as would normally be required to reactivate the lights in the likelihood of the departing aircraft returning for an emergency landing, and in any case not less than 15 minutes after take-off.
- (h) Stopway lights should be operated whenever the associated runway lights are operated.
- (i) Where required to provide taxi guidance, taxiway lighting should be turned on in such order that a continuous indication of the taxi path is presented to taxiing aircraft. Taxiway lighting or any portion thereof may be turned off when no longer needed.
- (j) Stop bars should be switched on to indicate that all traffic shall stop, and switched off to indicate that traffic may proceed.
- (k) Obstacle lighting associated with the approach to or departure from a runway or channel, where the obstacle does not project through the inner horizontal surface, as described in the applicable aerodrome design specifications, may be turned off and on simultaneously with the runway or channel lights.
- (l) Unserviceability lights should not be turned off as permitted under point (k) while the aerodrome is open.
- (m) ATS personnel should make use of automatic monitoring facilities, when provided, to ascertain whether the lighting is in good order and functioning according to selection.
- (n) In the absence of an automatic monitoring system or to supplement such a system, air traffic services personnel should visually observe such lighting as can be seen from the aerodrome control tower and use information from other sources such as visual inspections or reports from aircraft to maintain awareness of the operational status of the visual aids.
- (o) On receipt of information indicating a lighting fault, air traffic services personnel should take such action as is warranted to safeguard any affected aircraft or vehicles, and initiate action to have the fault rectified.

GM1 to AMC1 ATS.TR.150 Aeronautical ground lights

OPERATION OF AERONAUTICAL GROUND LIGHTS

- (a) Approach lighting includes such lights as simple approach lighting systems, precision approach lighting systems, visual approach slope indicator systems, circling guidance lights, approach light beacons and runway alignment indicators.
- (b) Runway lighting includes such lights as edge, threshold, centre line, end, touchdown zone and wing bar lights.
- (c) Where obstacle lighting is operated simultaneously with runway lighting as provided in point (k) of AMC1 ATS.TR.150, particular care should be taken to ensure that it is not turned off until no longer required by the aircraft.
- (d) Taxiway lighting includes such lights as edge lights, centre line lights, stop bars and clearance bars.

- (e) Stop bars, which are used exclusively when aerodrome control service is provided, are located across taxiways at the point where it is desired that traffic stop, and consist of lights, showing red, spaced across the taxiway.
- (f) Obstacle lighting includes such lights as obstacle and unserviceability lights and hazard beacons.

GM1 ATS.TR.155 ATS surveillance services

USE OF INFORMATION DERIVED FROM ATS SURVEILLANCE SYSTEMS FOR AIR TRAFFIC CONTROL SERVICE PURPOSES

Information derived from ATS surveillance systems, including safety-related alerts and warnings such as conflict alert and minimum safe altitude warning, should be used to the extent possible in the air traffic control service provision in order to improve capacity and efficiency as well as to enhance safety.

AMC1 ATS.TR.155(a) ATS surveillance services

FUNCTIONS OF THE ATS SURVEILLANCE SYSTEMS IN AIR TRAFFIC SERVICES PROVISION

(a) Functions in the area control service and approach control service

The information provided by ATS surveillance systems and presented on a situation display may be used to perform one or more of the following functions in the provision of area control service or approach control service:

- (1) provide ATS surveillance services as necessary in order to improve airspace utilisation, reduce delays, provide for direct routings and more optimum flight profiles, as well as to enhance safety;
- (2) provide vectoring to departing aircraft for the purpose of facilitating an expeditious and efficient departure flow and expediting climb to cruising level;
- (3) provide vectoring to aircraft for the purpose of resolving potential conflicts;
- (4) provide vectoring to arriving aircraft for the purpose of establishing an expeditious and efficient approach sequence;
- (5) provide vectoring to assist pilots in their navigation, e.g. to or from a radio navigation aid, away from or around areas of adverse weather;
- (6) provide separation and maintain normal traffic flow when an aircraft experiences communication failure within the area of coverage;
- (7) maintain flight path monitoring of air traffic;
- (8) when applicable, maintain a watch on the progress of air traffic, in order to provide a procedural air traffic controller with:
 - (i) improved position information regarding aircraft under control;
 - (ii) supplementary information regarding other traffic; and

- (iii) information regarding any significant deviations by aircraft from the terms of their respective ATC clearances, including their cleared routes as well as levels, when appropriate.

(b) Additional functions in the approach control service

In addition to the functions listed in point (a), the position indications presented on a situation display may be used to perform one or more of the following functions in the provision of approach control service:

- (1) provide vectoring of arriving traffic on to pilot-interpreted final approach aids;
- (2) provide flight path monitoring of parallel ILS approaches and instruct aircraft to take appropriate action in the event of possible or actual penetrations of the no transgression zone (NTZ);
- (3) provide vectoring of arriving traffic to a point from which a visual approach can be completed;
- (4) provide vectoring of arriving traffic to a point from which a surveillance radar approach can be made;
- (5) provide flight path monitoring of other pilot-interpreted instrument approach procedure;
- (6) in accordance with prescribed procedures, conduct surveillance radar approaches; and
- (7) provide separation between:
 - (i) succeeding departing aircraft;
 - (ii) succeeding arriving aircraft; and
 - (iii) a departing aircraft and a succeeding arriving aircraft.

(c) Functions in the aerodrome control service

- (1) When authorised and subject to procedures and conditions prescribed by the air traffic services provider, ATS surveillance systems may be used in the provision of aerodrome control service to perform the following functions:
 - (i) flight path monitoring of aircraft on final approach;
 - (ii) flight path monitoring of other aircraft in the vicinity of the aerodrome;
 - (iii) establishing an appropriate longitudinal and/or distance-based separation based on ATS surveillance systems in between succeeding departing aircraft;
 - (iv) maintaining separation between succeeding aircraft on the same final approach; and
 - (v) providing navigation assistance to VFR flights
- (2) In prescribing conditions and procedures for the use of ATS surveillance systems in the provision of aerodrome control service, the air traffic services provider should ensure that the availability and use of an ATS surveillance system will not be detrimental to visual observation of aerodrome traffic.

(d) Functions in the flight information service

The information presented on a situation display may be used to provide identified aircraft with information:

- (1) regarding any aircraft observed to be on a conflicting path with the identified aircraft and suggestions or advice regarding avoiding action;
- (2) on the position of significant weather and, as practicable, advice to the aircraft on how best to circumnavigate any such areas of adverse weather. When doing so, attention is to be paid to the fact that under certain circumstances the most active area of adverse weather may not be displayed; and
- (3) to assist the aircraft in its navigation.

GM1 ATS.TR.155(a) ATS surveillance services**ATS SURVEILLANCE SERVICES PROVISION IN PRESENCE OF CONTROLLED BUT UNIDENTIFIED AIRCRAFT**

In the event that the air traffic controller has been notified of a controlled flight entering or about to enter the airspace within which a separation minimum based on ATS surveillance systems is applied, but has not identified the aircraft, the air traffic controller may, if so prescribed by the air traffic services provider, continue to provide ATS surveillance services to identified aircraft, provided that:

- (a) reasonable assurance exists that the unidentified controlled flight will be identified using SSR and/or ADS-B and/or MLAT or the flight is being operated by an aircraft of a type which may be expected to give an adequate return on primary radar in the airspace within which the separation is applied; and
- (b) the separation is maintained between identified flights and any other observed ATS surveillance system position indications until either the unidentified controlled flight has been identified or procedural separation has been established.

GM1 ATS.TR.155(b)(1) ATS surveillance services**ATS SURVEILLANCE SYSTEM — PERFORMANCE CHECKS**

- (a) The air traffic controller, FIS officer, and AFIS officer that utilise ATS surveillance systems should adjust the situation display(s) and carry out adequate checks on the accuracy thereof, in accordance with the technical instructions prescribed by the air traffic services provider.
- (b) The air traffic controller, FIS officer, and AFIS officer that utilise ATS surveillance systems should be satisfied that the available functional capabilities of the ATS surveillance system as well as the information presented on the situation display(s) are adequate for the functions to be performed.

GM2 ATS.TR.155(b)(1) ATS surveillance services**ATS SURVEILLANCE SYSTEM — PERFORMANCE REQUIREMENTS**

Performance requirements for ATS surveillance systems and their constituents are specified in Regulation (EU) No 1207/2011.

AMC1 ATS.TR.155(b)(2)(i) ATS surveillance services**FACTORS DETERMINING THE NUMBER OF AIRCRAFT SIMULTANEOUSLY PROVIDED WITH AIR TRAFFIC CONTROL SERVICE USING ATS SURVEILLANCE SYSTEMS**

When determining the number of aircraft simultaneously provided with ATS surveillance services, the air traffic services provider should take into account, as a minimum:

- (a) the structural complexity of the control area or sector concerned;
- (b) the functions to be performed within the control area or sector concerned;
- (c) assessments of air traffic controller workloads, taking into account different aircraft capabilities, and sector capacity; and
- (d) the degree of technical reliability and availability of the primary and backup communications, navigation and surveillance systems, both in the aircraft and on the ground.

AMC1 ATS.TR.155(c)(1) ATS surveillance services**METHODS OF IDENTIFICATION**

Identification of aircraft should be established by at least one of the following methods:

(a) ADS-B identification procedures

Where ADS-B is used for identification, aircraft may be identified by one or more of the following procedures:

- (1) direct recognition of the aircraft identification in an ADS-B label;
- (2) transfer of ADS-B identification; and
- (3) observation of compliance with an instruction to 'TRANSMIT ADS-B IDENT'.

(b) SSR and/or MLAT identification procedures

(1) Where SSR and/or MLAT is used for identification, aircraft may be identified by one or more of the following procedures:

- (i) recognition of the aircraft identification in an SSR and/or MLAT label, in accordance with Article 4 of Regulation (EU) No 1206/2011;
- (ii) recognition of an assigned discrete code, the setting of which has been verified, in an SSR and/or MLAT label, in accordance with Article 4 of Regulation (EU) No 1206/2011;
- (iii) direct recognition of the aircraft identification of a Mode S-equipped aircraft in an SSR and/or MLAT label, in accordance with Article 4 of Regulation (EU) No 1206/2011;
- (iv) by transfer of identification;
- (v) observation of compliance with an instruction to set a specific code; and
- (vi) observation of compliance with an instruction to squawk 'IDENT'.

- (2) When a discrete code has been assigned to an aircraft, a check should be made at the earliest opportunity to ensure that the code set by the pilot is identical to that assigned for the flight. Only after this check has been made, the discrete code should be used as a basis for identification.

(c) PSR identification procedures

- (1) Where PSR is used for identification, aircraft may be identified by one or more of the following procedures:
- (i) by correlating a particular radar position indication with an aircraft reporting its position over, or as bearing and distance from, a point shown on the situation display, and by ascertaining that the track of the particular radar position is consistent with the aircraft path or reported heading;
 - (ii) by correlating an observed radar position indication with an aircraft which is known to have just departed, provided that the identification is established within 2 km (1 NM) from the end of the runway used. Particular care should be taken to avoid confusion with aircraft holding over or overflying the aerodrome, or with aircraft departing from or making a missed approach over adjacent runways;
 - (iii) by transfer of identification;
 - (iv) when air traffic control service is provided, by ascertaining the aircraft heading, if circumstances require, and following a period of track observation:
 - (A) instructing the pilot to execute one or more changes of heading of 30 degrees or more and correlating the movements of one particular radar position indication with the aircraft's acknowledged execution of the instructions given; or
 - (B) correlating the movements of a particular radar position indication with manoeuvres currently executed by an aircraft having so reported.
- (2) When using these methods, the air traffic controller/FIS officer/AFIS officer, as appropriate, should:
- (i) verify that the movements of not more than one radar position indication correspond with those of the aircraft; and
 - (ii) ensure that the manoeuvre(s) will not carry the aircraft outside the coverage of the radar or the situation display.

(d) Additional identification method

When two or more position indications are observed in close proximity, or are observed to be making similar movements at the same time, or when doubt exists as to the identity of a position indication for any other reason, the identification procedure in point (c)(1)(iv) should be used (only in case of air traffic control service provision), or additional methods of identification should be employed, until all risk of error in identification is eliminated.

AMC2 ATS.TR.155(c)(1) ATS surveillance services**METHODS OF IDENTIFICATION — USE OF ATS SURVEILLANCE SYSTEMS IN SURFACE MOVEMENT CONTROL OR MANAGEMENT**

Where an ATS surveillance system is used in surface movement control or management, the air traffic controller/AFIS officer may identify aircraft by one or more of the following procedures:

- (a) correlating a particular position indication with an:
 - (1) aircraft position visually observed by the air traffic controller/AFIS officer; or
 - (2) aircraft position reported by the pilot; or
 - (3) identified position indication displayed on a situation display;
- (b) transfer of identification when authorised by the competent authority; and
- (c) automated identification procedures when authorised by the competent authority.

AMC3 ATS.TR.155(c)(1) ATS surveillance services**METHODS OF IDENTIFICATION — TRANSFER OF IDENTIFICATION**

- (a) Transfer of identification from one air traffic controller/FIS officer/AFIS officer to another should only be attempted when it is considered that the aircraft is within the accepting air traffic controller's/FIS officer's/AFIS officer's surveillance coverage.
- (b) Transfer of identification should be effected by one of the following methods:
 - (1) designation of the position indication by automated means, provided that only one position indication is thereby indicated and there is no possible doubt of correct identification;
 - (2) notification of the aircraft's discrete SSR code;
 - (3) notification of the automated or system-to-system aircraft address;
 - (4) notification that the aircraft is SSR Mode S-equipped with an aircraft identification feature when SSR Mode S coverage is available;
 - (5) notification that the aircraft is ADS-B-equipped with an aircraft identification feature when compatible ADS-B coverage is available;
 - (6) direct designation (pointing with the finger) of the position indication if the two situation displays are adjacent or if a common 'conference' type of situation display is used;
 - (7) designation of the position indication by reference to, or in terms of bearing and distance from, a geographical position or navigational facility accurately indicated on both situation displays, together with the track of the observed position indication if the route of the aircraft is not known to both air traffic controllers/FIS officers/AFIS officers;
 - (8) where applicable, issuance of an instruction to the aircraft by the transferring air traffic controller/FIS officer/AFIS officer to change SSR code and the observation of the change by the accepting air traffic controller/FIS officer/AFIS officer; or

- (9) issuance of an instruction to the aircraft by the transferring air traffic controller/FIS officer/AFIS officer to squawk/transmit IDENT and observation of this response by the accepting air traffic controller/FIS officer/AFIS officer.

GM1 to AMC3 ATS.TR.155(c)(1) ATS surveillance services

METHODS OF IDENTIFICATION — TRANSFER OF IDENTIFICATION

- (a) When applying the identification method described in point (b)(6) of AMC3 ATS.TR.155(c)(1), attention is to be paid to any errors which might occur due to parallax effects.
- (b) When applying the identification method described in point (b)(7) of AMC3 ATS.TR.155(c)(1), caution is to be exercised before transferring identification using this method, particularly if other position indications are observed on similar headings and in close proximity to the aircraft to which air traffic services are provided. Inherent radar deficiencies, such as inaccuracies in bearing and distance of the radar position indications displayed on individual situation displays and parallax errors, may cause the indicated position of an aircraft in relation to the known point to differ between the two situation displays. The air traffic services provider may therefore prescribe additional conditions for the application of this method, e.g.:
- (1) a maximum distance from the common reference point used by the affected air traffic controller(s)/FIS officer(s)/AFIS officer(s), as applicable; and
 - (2) a maximum distance between the position indication as observed by the accepting air traffic controller/FIS officer/AFIS officer and the one stated by the transferring air traffic controller/FIS officer/AFIS officer.
- (c) The use of procedures in points (b)(8) and (b)(9) of AMC3 ATS.TR.155(c)(1) requires prior coordination between the air traffic controllers/FIS officers/AFIS officers, since the indications to be observed by the accepting air traffic controller/FIS officer/AFIS officer are of short duration.

GM1 ATS.TR.155(c)(1) ATS surveillance services

METHODS OF IDENTIFICATION — SSR AND/OR MLAT IDENTIFICATION PROCEDURES

When applying this method of identification, the air traffic controller/FIS officer/AFIS officer should consider that some aircraft equipped with first generation ADS-B avionics do not have the capability of squawking IDENT while the emergency and/or urgency mode is selected.

GM2 ATS.TR.155(c)(1) ATS surveillance services

METHODS OF IDENTIFICATION — PSR IDENTIFICATION PROCEDURE

- (a) Caution is to be exercised when employing this method since a position reported in relation to a point may not coincide precisely with the radar position indication of the aircraft on the situation display. The air traffic services provider may, therefore, prescribe additional conditions for the application of this method, e.g.
- (1) a level or levels above which this method may not be applied in respect of specified navigation aids; or

(2) a distance from the radar site beyond which this method may not be applied.

(b) The term 'a point' refers to a geographical point suitable for the purposes of identification. It is normally a reporting point defined by reference to a radio navigation aid or aids.

AMC1 ATS.TR.155(c)(2) ATS surveillance services

POSITION INFORMATION

(a) An aircraft provided with ATS surveillance services should be informed of its position in the following circumstances:

(1) upon identification, except when the identification is established:

(i) based on the pilot's report of the aircraft position or within one nautical mile of the runway upon departure and the observed position on the situation display is consistent with the aircraft's time of departure; or

(ii) by use of ADS-B aircraft identification, Mode S aircraft identification or assigned discrete SSR codes and the location of the observed position indication is consistent with the current flight plan of the aircraft; or

(iii) by transfer of identification;

(2) when the pilot requests this information;

(3) when a pilot's estimate differs significantly from the air traffic controller's estimate based on the observed position;

(4) unless otherwise prescribed by the competent authority, when the pilot is instructed by the air traffic controller to resume own navigation after vectoring if the current instructions had diverted the aircraft from a previously assigned route; and

(5) when air traffic control service is provided, immediately before termination of ATS surveillance services if the aircraft is observed to deviate from its intended route.

(b) Position information should be passed on to aircraft in one of the following forms:

(1) as a well-known geographical position;

(2) magnetic track and distance to a significant point, an en-route navigation aid, or an approach aid;

(3) direction (using points of the compass) and distance from a known position;

(4) distance to touchdown if the aircraft is on final approach; or

(5) distance and direction from the centre line of an ATS route.

(c) Whenever practicable, position information should relate to positions or routes pertinent to the navigation of the aircraft concerned and shown on the situation display map.

AMC1 ATS.TR.155(c)(3) ATS surveillance services**VECTORING INSTRUCTIONS IN AIR TRAFFIC CONTROL SERVICE PROVISION — GENERAL**

- (a) When vectoring an aircraft, an air traffic controller should comply with the following:
- (1) when an aircraft is given its initial vector diverting it from a previously assigned route, the pilot should be informed what the vector is to accomplish, and, the limit of the vector should be specified when the assigned heading is such that a loss of communications may result in a safety risk (e.g. to ... position, for ... approach);
 - (2) except when transfer of control is to be effected, aircraft should not be vectored closer than 4.6 km (2.5 NM) or, where the minimum permissible separation is greater than 9.3 km (5 NM), a distance equivalent to one-half of the prescribed separation minimum, from the limit of the airspace for which the air traffic controller is responsible, unless local arrangements have been made to ensure that separation will exist with aircraft operating in adjoining areas;
 - (3) controlled flights should not be vectored into uncontrolled airspace except in the case of emergency or in order to circumnavigate adverse meteorological conditions (in which case the pilot should be so informed), or at the specific request of the pilot; and
 - (4) when an aircraft has reported unreliable directional instruments, the pilot should be requested, prior to the issuance of manoeuvring instructions, to make all turns at an agreed rate and to carry out the instructions immediately upon receipt.
- (b) Special VFR flights should not be vectored unless special circumstances, such as emergencies, dictate otherwise.
- (c) In terminating vectoring of an aircraft, the air traffic controller should instruct the pilot to resume own navigation, giving the pilot the aircraft's position and appropriate instructions, as necessary, in the form prescribed in point (b)(2) of AMC1 ATS.TR.155(c)(2), if the current instructions had diverted the aircraft from a previously assigned route.

GM1 to AMC1 ATS.TR.155(c)(3) ATS surveillance services**VECTORING INSTRUCTIONS IN AIR TRAFFIC CONTROL SERVICE PROVISION — GENERAL**

- (a) Vectoring is achieved by issuing to the pilot specific headings which will enable the aircraft to maintain the desired track.
- (b) Whenever practicable, air traffic controllers should vector aircraft along tracks on which the pilot can monitor the aircraft position with reference to pilot-interpreted navigation aids; this will minimise the amount of navigational assistance required and alleviate the consequences resulting from an ATS surveillance system failure.
- (c) Air traffic controllers should exercise caution when vectoring VFR flights so as to ensure that the aircraft concerned does not inadvertently enter instrument meteorological conditions (IMC).

GM2 to AMC1 ATS.TR.155(c)(3) ATS surveillance services**VECTERING INSTRUCTIONS IN AIR TRAFFIC CONTROL SERVICE PROVISION — GENERAL**

With reference to point (a)(2) of AMC1 ATS.TR.155(c)(3): the establishment of a limit of the airspace beyond which aircraft should not be vectored is to ensure that the prescribed separation minimum is achieved between controlled flights within adjoining volumes of controlled airspace without the need to effect coordination. Where a volume of controlled airspace is adjacent to uncontrolled airspace, there is no requirement to apply such a limit. However, competent authorities may set a limit beyond which aircraft should not be vectored in order to mitigate the risk of collision resulting from airspace infringement and the likelihood of ACAS nuisance alerting against aircraft operating close to the airspace boundary in uncontrolled airspace.

GM3 to AMC1 ATS.TR.155(c)(3) ATS surveillance services**VECTERING INSTRUCTIONS IN AIR TRAFFIC CONTROL SERVICE PROVISION — GENERAL**

- (a) With reference to point (a)(2) of AMC1 ATS.TR.155(c)(3): When a controlled flight has been vectored into uncontrolled airspace in an emergency or in order to circumnavigate adverse meteorological conditions, air traffic controllers may provide advice or issue clearances to the extent necessary to:
- (1) assist the aircraft in a state of emergency; or
 - (2) to permit the aircraft to rejoin controlled airspace once clear of the adverse meteorological conditions.
- (b) When an aircraft has been cleared to follow own navigation or accepts a vector in order to avoid adverse meteorological conditions, it should be requested to report when able to return its current flight plan.

AMC2 ATS.TR.155(c)(3) ATS surveillance services**VECTERING FOR APPROACH CONTROL**

- (a) Prior to, or upon commencement of, vectoring for approach, the air traffic controller should advise the pilot of the type of approach as well as the runway to be used.
- (b) The air traffic controller should advise the pilot of an aircraft being vectored for an instrument approach of its position at least once prior to commencement of final approach.
- (c) When giving distance information, the air traffic controller should specify the point or navigation aid to which the information refers.
- (d) Aircraft vectored for final approach should be given a heading or a series of headings calculated to close with the final approach track. The final vector should enable the aircraft to be established on the final approach track prior to intercepting the specified or nominal glide path of the approach procedure from below, and should provide an intercept angle with the final approach track of 45 degrees or less.
- (e) Whenever an aircraft is assigned a vector which will take it through the final approach track, it should be advised accordingly, stating the reason for the vector.

- (f) When an aircraft is vectored to a pilot-interpreted final approach aid:
- (1) the aircraft should be instructed to report when established on the final approach track;
 - (2) the transfer of communications to the aerodrome air traffic controller should be effected at such a point or time that clearance to land or alternative instructions can be issued to the aircraft in a timely manner.
- (g) When an aircraft is vectored for visual approach:
- (1) the reported ceiling is to be above the minimum altitude applicable to vectoring and meteorological conditions such that, with reasonable assurance, a visual approach and landing can be completed; and
 - (2) clearance for visual approach is to be issued after the pilot has reported the aerodrome or the preceding aircraft in sight, at which time vectoring would normally be terminated.

GM1 ATS.TR.155(c)(3) ATS surveillance services

VECTERING — DEFINITION OF INITIAL AND INTERMEDIATE APPROACH PHASES

The initial and intermediate approach phases of an approach executed under the direction of an air traffic controller comprise those parts of the approach from the time vectoring is initiated for the purpose of positioning the aircraft for a final approach until the aircraft is on final approach and:

- (a) established on the final approach path of a pilot-interpreted aid; or
- (b) reports that it is able to complete a visual approach; or
- (c) ready to commence a surveillance radar approach.

GM1 to AMC2 ATS.TR.155(c)(3) ATS surveillance services

VECTERING TO PILOT-INTERPRETED FINAL APPROACH AIDS

- (a) The air traffic controller should issue the clearance for the approach prior to the time the aircraft reports are established unless circumstances preclude the issuance of the clearance at such time. Vectoring will normally terminate at the time the aircraft leaves the last assigned heading to intercept the final approach track.
- (b) When clearance for the approach is issued, the aircraft is expected to maintain the last assigned level until intercepting the specified or nominal glide path of the approach procedure. If the air traffic controller requires an aircraft to intercept the glide path at a level other than a level flight segment depicted on the instrument approach chart, the air traffic controller should instruct the pilot to maintain the particular level until established on the glide path.
- (c) The approach air traffic controller is normally responsible for maintaining separation based on ATS surveillance systems between succeeding aircraft on the same final approach, except that the responsibility may be transferred to the aerodrome air traffic controller in accordance with procedures prescribed by the air traffic services provider, and provided an ATS surveillance system is available to the aerodrome air traffic controller.

GM2 to AMC2 ATS.TR.155(c)(3) ATS surveillance services**PROCEDURES FOR RADAR APPROACHES**

- (a) During the period that an air traffic controller is engaged in giving surveillance radar approaches, he or she should not be responsible for any duties other than those directly connected with such approaches.
- (b) Air traffic controllers conducting radar approaches should be provided with information regarding the OCAs/OCHs established for the types of approach to be conducted.
- (c) Prior to commencement of a radar approach, the air traffic controller should inform the aircraft of the:
 - (1) runway to be used;
 - (2) applicable OCA/OCH;
 - (3) angle of the nominal glide path and the approximate rate of descent to be maintained; and
 - (4) procedure to be followed in the event of radio communication failure unless the procedure has been published in AIPs.
- (d) When a radar approach cannot be continued due to any circumstance, the aircraft should be immediately informed that a radar approach or continuation thereof is not possible. The approach should be continued if this is possible using non-radar facilities or if the pilot reports that the approach can be completed visually; otherwise, an alternative clearance should be given.
- (e) Aircraft making a radar approach should be reminded, when on final approach, to check that the wheels are down and locked.
- (f) Unless otherwise prescribed by the air traffic services provider, the air traffic controller conducting the approach should notify the aerodrome air traffic controller or, when applicable, the procedural air traffic controller when an aircraft making a radar approach is approximately 15 km (8 NM) from touchdown. If landing clearance is not received at this time, a subsequent notification should be made at approximately 8 km (4 NM) from touchdown and landing clearance requested.
- (g) Clearance to land or any alternative clearance received from the aerodrome air traffic controller or, when applicable, the procedural air traffic controller should normally be passed on to the aircraft before it reaches a distance of 4 km (2 NM) from touchdown.
- (h) An aircraft making a radar approach should:
 - (1) be directed to execute a missed approach in the following circumstances:
 - (i) when the aircraft appears to be dangerously positioned on final approach; or
 - (ii) for reasons involving traffic conflicts; or
 - (iii) if no clearance to land has been received from the procedural air traffic controller by the time the aircraft reaches a distance of 4 km (2 NM) from touchdown or such other distance as has been agreed with the aerodrome control tower; or

(iv) on instructions by the aerodrome air traffic controller;

or

(2) be advised to consider executing a missed approach in the following circumstances:

(i) when the aircraft reaches a position from which it appears that a successful approach cannot be completed; or

(ii) if the aircraft is not visible on the situation display for any significant interval during the last 4 km (2 NM) of the approach; or

(iii) if the position or identification of the aircraft is in doubt during any portion of the final approach.

In all such cases, the reason for the instruction or the advice should be given to the pilot.

(i) Unless otherwise required by exceptional circumstances, radar instructions concerning a missed approach should be in accordance with the prescribed missed approach procedure and should include the level to which the aircraft is to climb and heading instructions to keep the aircraft within the missed approach area during the missed approach procedure.

GM3 to AMC2 ATS.TR.155(c)(3) ATS surveillance services

FINAL APPROACH PROCEDURES — SURVEILLANCE RADAR APPROACH

(a) A surveillance radar approach should only be performed with equipment suitably sited and a situation display specifically marked to provide information on position relative to the extended centre line of the runway to be used and distance from touchdown, and which is specifically approved for the purpose by the competent authority.

(b) When conducting a surveillance radar approach, the air traffic controller should comply with the following:

(1) at or before the commencement of the final approach, the aircraft should be informed of the point at which the surveillance radar approach will be terminated;

(2) the aircraft should be informed when it is approaching the point at which it is computed that descent should begin, and just before reaching that point it should be informed of the OCA/OCH and instructed to descend and check the applicable minima;

(3) azimuth instructions should be given as follows:

(i) the pilot should be informed at regular intervals of the aircraft's position in relation to the extended centre line of the runway. Heading corrections should be given as necessary to bring the aircraft back on to the extended centre line;

(ii) in the case of azimuth deviations, the pilot should not take corrective action unless specifically instructed to do so;

(4) except as provided in point (c), information on distance from touchdown should normally be passed on at every 2 km (each NM);

- (5) pre-computed levels through which the aircraft should be passing to maintain the glide path should also be transmitted at every 2 km (each NM) at the same time as the distance; and
- (6) the surveillance radar approach should be terminated:
 - (i) at a distance of 4 km (2 NM) from touchdown, except as provided in point (c); or
 - (ii) before the aircraft enters an area of continuous radar clutter; or
 - (iii) when the pilot reports that a visual approach can be effected, whichever is the earliest.
- (c) When, as determined by the competent authority, the accuracy of the radar equipment permits, surveillance radar approaches may be continued to the threshold of the runway, or to a prescribed point less than 4 km (2 NM) from touchdown, in which case:
 - (1) distance and level information should be given at each km (each half NM);
 - (2) transmission should not be interrupted for intervals of more than 5 seconds while the aircraft is within a distance of 8 km (4 NM) from touchdown; and
 - (3) the air traffic controller should not be responsible for any duties other than those directly connected with a particular approach.
- (d) Levels through which the aircraft should pass to maintain the required glide path, and the associated distances from touchdown, should be pre-computed and displayed in such a manner as to be readily available to the air traffic controller concerned.

AMC1 ATS.TR.155(c)(4) ATS surveillance services

NAVIGATION ASSISTANCE

An identified aircraft observed to deviate significantly from its intended route or designated holding pattern should be advised accordingly. Appropriate action should also be taken if, in the opinion of the air traffic controller such deviation is likely to affect the service being provided.

GM1 ATS.TR.155(c)(5) ATS surveillance services

INFORMATION REGARDING ADVERSE WEATHER

- (a) Information that an aircraft appears likely to penetrate an area of adverse weather should be issued in sufficient time to permit the pilot to decide on an appropriate course of action, including that of requesting advice on how best to circumnavigate the adverse weather area, if so desired.
- (b) Depending on the capabilities of the ATS surveillance system, areas of adverse weather may not be presented on the situation display. An aircraft's weather radar will normally provide better detection and definition of adverse weather than radar sensors in use by air traffic services.
- (c) In vectoring an aircraft for circumnavigating any area of adverse weather, the air traffic controller should ascertain that the aircraft can be returned to its intended or assigned flight path within the coverage of the ATS surveillance system and, if this does not appear possible, inform the pilot of the circumstances.

AMC1 ATS.TR.155(c)(6) ATS surveillance services**ATS SURVEILLANCE SERVICES — PROCEDURES FOR TRANSFER OF CONTROL**

- (a) Where ATS surveillance services are being provided, transfer of control should be effected, whenever practicable, so as to enable the uninterrupted provision of ATS surveillance services.
- (b) Where SSR and/or ADS-B and/or MLAT is (are) used and the display of position indications with associated labels is provided for, transfer of control of aircraft between adjacent control positions or between adjacent air traffic control units may be effected without prior coordination, provided that:
- (1) updated flight plan information on the aircraft about to be transferred, including the discrete assigned SSR code or, with respect to Mode S and ADS-B, the aircraft identification, is provided to the accepting air traffic controller prior to transfer;
 - (2) the ATS surveillance system coverage provided to the accepting air traffic controller is such that the aircraft concerned is presented on the situation display before the transfer is effected and is identified on, but preferably before, receipt of the initial call;
 - (3) when the air traffic controllers are not physically adjacent, two-way direct-speech facilities, which permit communications to be established instantaneously, are available between them at all times;
 - (4) the transfer point or points and all other conditions of application, such as direction of flight, specified levels, transfer of communication points, and especially an agreed minimum separation between aircraft, including that applicable to succeeding aircraft on the same route, about to be transferred as observed on the situation display, have been made the subject of specific instructions (for intra-unit transfer) or of a specific letter of agreement between two adjacent air traffic control units;
 - (5) the instructions or letter of agreement specify explicitly that the application of this type of transfer of control may be terminated at any time by the accepting air traffic controller, normally with an agreed advance notice; and
 - (6) the accepting air traffic controller is informed of any level, speed or vectoring instructions given to the aircraft prior to its transfer and which modify its anticipated flight progress at the point of transfer.
- (c) The minimum agreed separation between aircraft about to be transferred (see point (b)(4)) and the advance notice (see point (b)(5)) should be determined taking into account all relevant technical, operational and other circumstances. If circumstances arise in which these agreed conditions can no longer be satisfied, air traffic controllers should revert to the procedure in point (d) until the situation is resolved.
- (d) Where primary radar is being used, and where another type of ATS surveillance system is employed but the provisions in point (b) are not applied, the transfer of control of aircraft between adjacent control positions or between two adjacent air traffic services units may be effected, provided that:
- (1) identification has been transferred to or has been established directly by the accepting air traffic controller;

- (2) when the air traffic controllers are not physically adjacent, two-way direct-speech facilities which permit communications to be established instantaneously between them are available at all times;
- (3) separation from other controlled flights conforms to the minima authorised for use during transfer of control between the sectors or units concerned;
- (4) the accepting air traffic controller is informed of any level, speed or vectoring instructions applicable to the aircraft at the point of transfer; and
- (5) radio communication with the aircraft is retained by the transferring air traffic controller until the accepting air traffic controller has agreed to assume responsibility for providing the ATS surveillance services to the aircraft. Thereafter, the aircraft should be instructed to change over to the appropriate channel, and from that point the responsibility is that of the accepting air traffic controller.

GM1 to AMC1 ATS.TR.155(c)(6) ATS surveillance services

ATS SURVEILLANCE SERVICES — PROCEDURES FOR TRANSFER OF CONTROL

Transfer of control based on the procedures specified in AMC1 ATS.TR.155(c)(6) may be carried out without systematic use of the bidirectional speech facilities available between the adjacent units concerned, provided that:

- (a) the detailed conditions applicable for the transfer are the subject of a bilateral agreement; and
- (b) the minimum distance between successive aircraft during the period of transfer is agreed as one of the following values:
 - (1) 19 km (10 NM) when SSR information is used in accordance with the provisions of AMC1 ATS.TR.155(c)(6), provided that an overlapping radar coverage of at least 56 km (30 NM) between units involved exists; or
 - (2) 9.3 km (5 NM) when the conditions of point (b)(1) apply and both units involved possess electronic aids for immediate recognition of release and acceptance of aircraft under radar transfer.

GM1 ATS.TR.155(c)(6) ATS surveillance services

PROCEDURES FOR TRANSFER OF CONTROL IN ATS SURVEILLANCE SERVICES

Guidance on procedures for transfer of control in the ATS surveillance services provision may be found in the EUROCONTROL document titled 'Guidelines for the Application of European Coordination and Transfer Procedures' Edition 1.0 of 25 October 2012, which is available at: <https://www.eurocontrol.int/publication/guidelines-application-european-coordination-and-transfer-procedures>.

GM1 ATS.TR.155(c)(7) ATS surveillance services

PROCEDURES FOR AIR TRAFFIC CONTROL SERVICE IN CASE OF ATS SURVEILLANCE SYSTEM FAILURE

In the event of complete failure of the ATS surveillance system, where air-ground communications remain, the air traffic controllers should plot the positions of all aircraft already identified, take the

necessary action to establish procedural separation between the aircraft and, if necessary, limit the number of aircraft permitted to enter the area.

GM2 ATS.TR.155(c)(7) ATS surveillance services

SEPARATION APPLICATION IN CASE OF ATS SURVEILLANCE SYSTEM FAILURE

As an emergency measure, in the event of complete failure of the ATS surveillance system, where air-ground communications remain, the use of flight levels spaced by half the applicable vertical separation minimum may be resorted to temporarily if standard procedural separation cannot be provided immediately.

GM3 ATS.TR.155(c)(7) ATS surveillance services

ATS SURVEILLANCE SYSTEM FAILURE — DATA DEGRADATION

In order to reduce the impact of a degradation of aircraft position source data (for example, a receiver autonomous integrity monitoring (RAIM) outage for GNSS), the air traffic services provider should establish contingency procedures to be followed by air traffic services units in the event of data degradation.

GM1 ATS.TR.155(c)(9) ATS surveillance services

DISPLAY OF ATS SURVEILLANCE-BASED SAFETY-RELATED ALERTS AND WARNINGS

ATS surveillance systems should provide for the display of safety-related alerts and warnings, including conflict alert, conflict prediction, minimum safe altitude warning and unintentionally duplicated SSR codes and aircraft identification.

GM2 ATS.TR.155(c)(9) ATS surveillance services

SHORT-TERM CONFLICT ALERT (STCA) PROCEDURES

The generation of STCAs is a function based on surveillance data, integrated into an air traffic control system. The objective of the STCA function is to assist the air traffic controller in preventing collision between aircraft by generating, in a timely manner, an alert of a potential or actual infringement of separation minima. Procedures and related instructions concerning the use of the STCA function should specify, inter alia:

- (a) the types of flight which are eligible for generation of alerts;
- (b) the sectors or areas of airspace within which the STCA function is implemented;
- (c) the method of displaying the STCA to the air traffic controller;
- (d) in general terms, the parameters for generation of alerts as well as alert warning time;
- (e) the volumes of airspace within which STCA can be selectively inhibited and the conditions under which this will be permitted;
- (f) conditions under which specific alerts may be inhibited for individual flights; and
- (g) procedures applicable in respect of volume of airspace or flights for which STCA or specific alerts have been inhibited.

GM3 ATS.TR.155(c)(9) ATS surveillance services

MINIMUM SAFE ALTITUDE WARNING (MSAW) PROCEDURES

The generation of MSAWs is a function of an ATS surveillance data-processing system. The objective of the MSAW function is to assist in the prevention of controlled flight into terrain accidents by generating, in a timely manner, a warning of the possible infringement of a minimum safe altitude. Procedures and related instructions concerning the use of the MSAW function should specify, inter alia:

- (a) the types of flight which are eligible for generation of MSAW;
- (b) the sectors or areas of airspace for which MSAW minimum safe altitudes have been defined and within which the MSAW function is implemented;
- (c) the values of the defined MSAW minimum safe altitudes;
- (d) the method of displaying the MSAW to the air traffic controller;
- (e) the parameters for generation of a MSAW as well as warning time; and
- (f) conditions under which the MSAW function may be inhibited for individual aircraft tracks as well as procedures applicable in respect of flights for which MSAW has been inhibited.

AMC1 ATS.TR.155(c)(10) ATS surveillance services

INTERRUPTION OR TERMINATION OF ATS SURVEILLANCE SERVICES

An aircraft which has previously been informed that it is provided with an ATS surveillance service should immediately be informed when, for any reason, the service is interrupted or terminated.

AMC1 ATS.TR.155(e) ATS surveillance services

INFORMATION REGARDING TRAFFIC ON A CONFLICTING PATH

- (a) Information regarding traffic on a conflicting path should be given, whenever practicable, in the following form:
 - (1) relative bearing of the conflicting traffic in terms of the 12-hour clock;
 - (2) distance from the conflicting traffic in kilometres or nautical miles;
 - (3) direction in which the conflicting traffic appears to be proceeding; and
 - (4) level and type of aircraft or, if unknown, relative speed of the conflicting traffic, e.g. slow or fast.
- (b) Pressure-altitude-derived level information, even when unverified, should be used in the provision of collision hazard information because such information, particularly if available from an otherwise unknown aircraft (e.g. a VFR flight) and given to the pilot of a known aircraft, could facilitate the location of a collision hazard.
- (c) If the level information has not been verified, the accuracy of the information should be considered uncertain and the pilot should be informed accordingly.

GM1 to AMC1 ATS.TR.155(e) ATS surveillance services**INFORMATION REGARDING TRAFFIC ON A CONFLICTING PATH**

With reference to point (a)(1) of AMC1 ATS.TR.155(e): In cases where using the terms of the 12-hour clock is not practicable, like when the aircraft is turning, the direction of the unknown aircraft may be given by compass points, e.g. northwest, south, etc.

GM2 to AMC1 ATS.TR.155(e) ATS surveillance services**INFORMATION REGARDING TRAFFIC ON A CONFLICTING PATH**

With reference to point (a)(4) of AMC1 ATS.TR.155(e): The level may be described either as a flight level, altitude or height, or as a relative vertical distance from the aircraft provided with traffic information (e.g. 1 000 ft above or 1 000 ft below).

AMC1 ATS.TR.155(f) ATS surveillance services**TOLERANCE VALUE FOR PRESSURE-ALTITUDE-DERIVED LEVEL INFORMATION**

The tolerance value used to determine that the pressure-altitude-derived level information displayed to the air traffic controller is accurate should be ± 60 m (± 200 ft) in RVSM airspace. In other airspace, it should be ± 90 m (± 300 ft), except that the competent authority may specify a smaller criterion, but not less than ± 60 m (± 200 ft), if this is found to be more practical.

AMC2 ATS.TR.155(f) ATS surveillance services**VERIFICATION OF PRESSURE-ALTITUDE-DERIVED LEVEL INFORMATION**

The verification should be effected by simultaneous comparison with altimeter-derived level information received from the same aircraft by radiotelephony. Geometric height information should not be used to determine if altitude differences exist.

GM1 ATS.TR.155(f) ATS surveillance services**ERRONEOUS LEVEL INFORMATION IN AIR TRAFFIC CONTROL SERVICE PROVISION**

- (a) If the displayed level information is not within the approved tolerance value or when a discrepancy in excess of the approved tolerance value is detected subsequent to verification, the pilot should be advised accordingly and requested to check the pressure setting and confirm the aircraft's level.
- (b) If, following confirmation of the correct pressure setting, the discrepancy continues to exist, the following actions should be taken by the air traffic controller according to circumstances:
 - (1) request the pilot to stop Mode C or ADS-B altitude data transmission, provided this does not cause the loss of position and identity information, and notify the next control positions or air traffic control unit concerned with the aircraft of the action taken; or
 - (2) inform the pilot of the discrepancy and request that the relevant operation continue in order to prevent loss of position and identity information of the aircraft and, when so prescribed by the local instructions, override the label-displayed level information with

the reported level. In addition, the air traffic control unit should notify the next control position or air traffic control unit concerned with the aircraft of the action taken.

- (c) It should be highlighted that the airborne collision avoidance system (ACAS) will accept Mode C replies that are erroneous, and it is possible to issue a resolution advisory (RA) based on these inputs. When the measures described in point (b)(1) cannot be implemented, the air traffic controller should take into account the likelihood of generating ACAS RA in the air traffic services provision.

GM2 ATS.TR.155(f) ATS surveillance services

ERRONEOUS LEVEL INFORMATION IN FLIGHT INFORMATION SERVICE PROVISION

The procedures for the verification of pressure-altitude-derived displayed information in the provision of flight information service should be established taking into consideration GM1 ATS.TR.155(f), and approved by the competent authority.

AMC1 ATS.TR.155(g) ATS surveillance services

VERIFICATION OF LEVEL OCCUPANCY

- (a) In accordance with AMC1 ATS.TR.155(f), the criterion which should be used to determine that a specific level is occupied by an aircraft should be ± 60 m (± 200 ft) in RVSM airspace. In other airspace, this criterion should be ± 90 m (± 300 ft), except that the competent authority may specify a smaller criterion, but not less than ± 60 m (± 200 ft), if this is found to be more practical.

- (b) Aircraft maintaining a level

An aircraft should be considered to be maintaining its assigned level as long as the pressure-altitude-derived level information indicates that it is within the appropriate tolerances of the assigned level, as specified in point (a).

- (c) Aircraft vacating a level

An aircraft cleared to leave a level should be considered to have commenced its manoeuvre and vacated the previously occupied level when the pressure-altitude-derived level information indicates a change of more than 90 m (300 ft) in the anticipated direction from its previously assigned level.

- (d) Aircraft passing a level in climb or descent

An aircraft in climb or descent should be considered to have crossed a level when the pressure-altitude-derived level information indicates that it has passed this level in the required direction by more than 90 m (300 ft).

- (e) Aircraft reaching a level

An aircraft should be considered to have reached the level to which it has been cleared when the elapsed time of three display updates, three sensor updates or 15 seconds, whichever is the greater, has passed since the pressure-altitude-derived level information has indicated that it is within the appropriate tolerances of the assigned level, as specified in point (a).

GM1 ATS.TR.160 Provision of air traffic services for flight testing

SPECIAL AND ALTERNATIVE CONDITIONS AND OPERATING PROCEDURES FOR AIR TRAFFIC SERVICES PROVIDERS PROVIDING SERVICES TO FLIGHT TESTS

- (a) While flight tests are regularly conducted in compliance with the standards and the provisions specified in Subpart B of Annex IV, some of them need to follow specific additional or alternative conditions and procedures approved by the competent authority to meet the needs of flight tests carried out during the flight. This is also the case for flight tests involving more than one aircraft in the same flight test. These special provisions will not jeopardise the safety of the other airspace users and the population in the area overflown.
- (b) In order to ensure safe operations within the provision of air traffic service for flight tests control, the air traffic controllers, FIS officers and AFIS officers providing these services may need to have specific knowledge of flight tests and/or be briefed, depending on the specificities of the flight profiles.
- (c) Air traffic controllers that provide air traffic services to flight tests (flight test air traffic controllers) may need to obtain their specific competence through a dedicated training as specified in Commission Regulation (EU) 2015/340.
- (d) Air traffic services for flight tests should be provided through dedicated and specific procedures. These procedures should address the following:
- (1) Compatibility with other airspace users
 - (i) In order to ensure the compatibility of the flight test with other airspace users and to ensure safe operations and an acceptable rate of success of the flight test, the air traffic services provider should ensure proper coordination at all levels, including strategic, pre-tactical and real-time coordination.
 - (ii) The air traffic services unit providing services to flight tests is responsible for ensuring compatibility of their activities with other airspace users.
 - (2) Flight plan

The air traffic services unit should obtain all the necessary details related to flight tests (e.g. from the design organisation or the entity wishing to carry out the flight test).
 - (3) Flight tests with limited manoeuvrability
 - (i) During certain phases of the flight test, the capability to normally perform manoeuvres may only be possible after a necessary period of time (e.g. for the flight crew to get into a configuration that allows the execution of these manoeuvres).
 - (ii) The air traffic services provider should obtain the necessary information about the phases of flight and the duration if known.
 - (iii) For the conduct of these flights, the use of a temporarily reserved area is preferred. If unable, after prior coordination with the relevant air traffic services units neighbouring the flight tests, the use of a transponder should be mandated.

(iv) The real-time information on the development of the flight test as described in points (i)(ii)(iii) above does not relieve the air traffic services unit responsible for providing services to the flight tests from the obligation, when applicable, to ensure traffic separation and assure compatibility with all airspace users.

(e) The above-mentioned procedures are not exhaustive and additional provisions may be necessary to meet the needs of flight tests. The paramount principle is anyhow to make provisions without contradicting the standards and the provisions specified in Subpart B of Annex IV.

AMC1 ATS.TR.205 Provision of air traffic control service

SECTORS AND WORKING POSITIONS AT AIR TRAFFIC CONTROL UNITS

The air traffic services provider should:

- (a) determine the area of responsibility for individual control sectors within an air traffic control unit, when applicable;
- (b) where there is more than one air traffic controller working position within a unit or sector, define the duties and responsibilities of the individual working positions.

GM1 ATS.TR.205 Provision of air traffic control service

PROVISION OF APPROACH CONTROL SERVICE

Approach control service may be provided by a unit co-located with an area control centre (ACC), or by a control sector within an ACC.

AMC1 ATS.TR.205(c) Provision of air traffic control service

FUNCTIONS OF AERODROME CONTROL TOWERS

- (a) Aerodrome control towers should issue information, instructions and clearances to aircraft under their control to achieve a safe, orderly and expeditious flow of air traffic on and in the vicinity of an aerodrome with the objective of preventing collision(s) between:
 - (1) aircraft flying within the designated area of responsibility of the control tower, including the aerodrome traffic circuits;
 - (2) aircraft operating on the manoeuvring area;
 - (3) aircraft landing and taking off;
 - (4) aircraft and vehicles operating on the manoeuvring area; and
 - (5) aircraft on the manoeuvring area and obstructions on that area.
- (b) Control of all flight operations on and in the vicinity of an aerodrome, as well as of vehicles and personnel on the manoeuvring area, should be continuously maintained by:
 - (1) visual observation, which can be achieved directly by out-of-the-window observation or through the use of a visual surveillance system; and
 - (2) an ATS surveillance system where available, in accordance with ATS.TR.245.

- (c) If there are other aerodromes within a control zone, traffic at all aerodromes within such a zone should be coordinated so that traffic circuits do not conflict.

GM1 to AMC1 ATS.TR.205(c) Provision of air traffic control service USE OF A VISUAL SURVEILLANCE SYSTEM IN AERODROME AIR TRAFFIC SERVICES

- (a) A visual surveillance system will normally consist of a number of integrated elements, including sensor(s), data transmission links, data processing systems and situation displays.
- (b) Visual surveillance systems used in the provision of aerodrome control services shall have an appropriate level of reliability, availability and integrity. The possibility of system failures or significant system degradations which may cause complete or partial interruptions of service should be assessed and taken into account in the definition of the level of service provided in order to ensure that there is no degradation in the safety level of the services provided. Backup facilities or alternative operational procedures should be provided.
- (c) Visual surveillance systems should be capable of receiving, processing and displaying, in an integrated manner, data from all connected resources.
- (d) Further information on visual surveillance systems in aerodrome air traffic services may be found in EASA ED Decision 2019/004/R, at <https://www.easa.europa.eu/document-library/agency-decisions/ed-decision-2019004r>.

GM1 ATS.TR.205(c) Provision of air traffic control service POSITIONS AT THE AERODROME CONTROL TOWER

- (a) The functions of an aerodrome control tower may be performed by different control or working positions, such as:
- (1) aerodrome air traffic controller, normally responsible for operations on the runway and aircraft flying within the area of responsibility of the aerodrome control tower;
 - (2) ground air traffic controller, normally responsible for traffic on the manoeuvring area with the exception of runways; and
 - (3) clearance delivery position, normally responsible for delivery of start-up and ATC clearances to departing IFR flights.
- (b) Where parallel or near-parallel runways are used for simultaneous operations, individual aerodrome air traffic controllers should be responsible for operations on each of the runways.

AMC1 ATS.TR.210(a)(3) Operation of air traffic control service HORIZONTAL SPEED CONTROL INSTRUCTIONS — GENERAL

- (a) In order to facilitate a safe and orderly flow of traffic, aircraft may, subject to conditions specified by the air traffic services provider, be instructed to adjust speed in a specified manner.
- (b) Flight crews should be given adequate notice of planned speed control.
- (c) Speed control instructions should remain in effect unless explicitly cancelled or amended by the air traffic controller.

- (d) Speed control should not be applied to aircraft entering or established in a holding pattern.
- (e) Speed adjustments should, as far as practicable, be limited to those necessary to establish and/or maintain a desired separation minimum or spacing. Instructions involving frequent changes of speed, including alternate speed increases and decreases, should be avoided.
- (f) When the flight crew inform the air traffic control unit concerned that they are unable to comply with a speed instruction, the air traffic controller should apply an alternative method to achieve the desired spacing between the aircraft concerned.
- (g) Except where otherwise approved by the competent authority, at levels at or above 7 600 m (FL 250), speed adjustments should be expressed in multiples of 0.01 Mach; at levels below 7 600 m (FL 250), speed adjustments should be expressed in multiples of 20 km/h (10 kt) based on indicated airspeed (IAS).
- (h) The air traffic controller should advise the flight crew when a speed control restriction is no longer required.

GM1 to AMC1 ATS.TR.210(a)(3) Operation of air traffic control service

HORIZONTAL SPEED CONTROL INSTRUCTIONS — GENERAL

- (a) In order to establish a desired spacing between two or more successive aircraft, the air traffic controller should first either reduce the speed of the last aircraft, or increase the speed of the leading aircraft, then adjust the speed(s) of the other aircraft in order.
- (b) In order to maintain a desired spacing using speed control techniques, specific speeds need to be assigned to all the aircraft concerned.
- (c) The true airspeed (TAS) of an aircraft will decrease during descent when maintaining a constant IAS. When two descending aircraft maintain the same IAS, and the leading aircraft is at the lower level, the TAS of the leading aircraft will be lower than that of the following aircraft. The distance between the two aircraft will thus be reduced unless a sufficient speed differential is applied. For the purpose of calculating a desired speed differential between two succeeding aircraft, 11 km/h (6 kt) IAS per 300 m (1 000 ft) height difference may be used as a general rule. At levels below 2 450 m (FL 80), the difference between IAS and TAS is negligible for speed control purposes.
- (d) The time and distance required to achieve a desired spacing will increase with higher levels, higher speeds, and when the aircraft is in a clean configuration (see point (b) of GM1 to AMC2 ATS.TR.210(a)(3)).

GM2 to AMC1 ATS.TR.210(a)(3) Operation of air traffic control service

HORIZONTAL SPEED CONTROL INSTRUCTIONS — AIRCRAFT PERFORMANCE AT HIGH LEVEL

When an aircraft is heavily loaded and at a high level, its ability to change speed may, in some cases, be very limited.

GM3 to AMC1 ATS.TR.210(a)(3) Operation of air traffic control service

CANCELLATION OF HORIZONTAL SPEED INSTRUCTION

Cancellation of any speed control instruction does not relieve the flight crew of compliance with speed limitations associated with airspace classifications as specified in SERA.6001 'Classification of airspaces' of and in Appendix 4 to Regulation (EU) No 923/2012.

AMC2 ATS.TR.210(a)(3) Operation of air traffic control service

HORIZONTAL SPEED CONTROL INSTRUCTIONS — DESCENDING AND ARRIVING AIRCRAFT

- (a) The air traffic controller should only apply speed reductions to less than 460 km/h (250 kt) IAS for turbojet aircraft during initial descent from cruising level with the concurrence of the flight crew.
- (b) The air traffic controller should use only minor speed adjustments not exceeding plus/minus 40 km/h (20 kt) IAS for aircraft on intermediate and final approach.
- (c) The air traffic controller should not apply speed control to aircraft after passing a point 7 km (4 NM) from the threshold on final approach.

GM1 to AMC2 ATS.TR.210(a)(3) Operation of air traffic control service

HORIZONTAL SPEED CONTROL INSTRUCTIONS — DESCENDING AND ARRIVING AIRCRAFT

- (a) The air traffic controller should, when practicable, authorise an aircraft to absorb a period of notified terminal delay by cruising at a reduced speed for the latter portion of its flight.
- (b) The air traffic controller may instruct an aircraft to maintain its 'maximum speed', 'minimum clean speed', 'minimum speed', a specified speed or a speed equal to or less/more than a specified speed. 'Minimum clean speed' signifies the minimum speed at which an aircraft can be flown in a clean configuration, i.e. without deployment of lift-augmentation devices, speed brakes or landing gear.
- (c) The air traffic controller should avoid issuing instructions for an aircraft to simultaneously maintain a high rate of descent and reduce its speed, as such manoeuvres are normally not compatible. Any significant speed reduction during descent may require the aircraft to temporarily level off to reduce speed before continuing descent.
- (d) The air traffic controller should permit arriving aircraft to operate in a clean configuration for as long as possible. Below 4 550 m (FL 150), speed reductions for turbojet aircraft to not less than 410 km/h (220 kt) IAS, which will normally be very close to the minimum speed of turbojet aircraft in a clean configuration, may be used.

AMC3 ATS.TR.210(a)(3) Operation of air traffic control service**VERTICAL SPEED CONTROL INSTRUCTIONS — GENERAL**

- (a) In order to facilitate a safe and orderly flow of traffic, the air traffic controller may instruct aircraft to adjust rate of climb or rate of descent. The air traffic controller may apply vertical speed control between two or more climbing aircraft or two or more descending aircraft in order to establish or maintain a specific vertical separation minimum.
- (b) The air traffic controller should, as far as practicable, limit vertical speed adjustments to those necessary to establish and/or maintain a desired separation minimum, and should avoid instructions involving frequent changes of climb/descent rates.
- (c) When the flight crew inform the air traffic control unit concerned that they are unable to comply with a specified rate of climb or descent, the air traffic controller should apply an alternative method to achieve an appropriate separation minimum between aircraft, without delay.
- (d) The air traffic controller should advise aircraft when a rate of climb/descent restriction is no longer required.

GM1 to AMC3 ATS.TR.210(a)(3) Operation of air traffic control service**VERTICAL SPEED CONTROL INSTRUCTIONS — GENERAL**

- (a) The air traffic controller may instruct an aircraft to expedite climb or descent as appropriate to or through a specified level, or to reduce its rate of climb or rate of descent.
- (b) The air traffic controller may instruct climbing aircraft to maintain a specified rate of climb, a rate of climb equal to or greater than a specified value or a rate of climb equal to or less than a specified value.
- (c) The air traffic controller may instruct descending aircraft to maintain a specified rate of descent, a rate of descent equal to or greater than a specified value or a rate of descent equal to or less than a specified value.
- (d) In applying vertical speed control, the air traffic controller should ascertain to which level(s) climbing aircraft can sustain a specified rate of climb or, in the case of descending aircraft, the specified rate of descent which can be sustained.
- (e) Air traffic controllers should be aware of aircraft performance characteristics and limitations in relation to a simultaneous application of horizontal and vertical speed limitations.

AMC4 ATS.TR.210(a)(3) Operation of air traffic control service**HOLDING CLEARANCE AND INSTRUCTIONS**

When delay is expected, the ACC should clear aircraft to the holding fix, and:

- (a) include holding instructions; and
- (b) communicate in such clearances an expected approach time or onward clearance time, as applicable.

GM1 to AMC4 ATS.TR.210(a)(3) Operation of air traffic control service

HOLDING CLEARANCE AND INSTRUCTIONS

- (a) In the event of extended delays, aircraft should be advised of the anticipated delay as early as possible and, when practicable, be instructed or given the option to reduce speed en-route in order to absorb the delay.
- (b) Holding and holding pattern entry should be accomplished in accordance with procedures published in AIPs. If entry and holding procedures have not been published or if the procedures are not known to a flight crew, the appropriate air traffic control unit should specify the designator of the location or aid to be used, the inbound track, radial or bearing, direction of turn in the holding pattern as well as the time of the outbound leg or the distances between which to hold.
- (c) Air traffic services units should normally hold aircraft at a designated holding fix.
- (d) For the purpose of maintaining a safe and orderly flow of traffic, an aircraft may be instructed to orbit at its present or at any other position, provided the required obstacle clearance is ensured.

AMC5 ATS.TR.210(a)(3) Operation of air traffic control service

APPROACH SEQUENCE

- (a) The approach sequence should be established in a manner which will facilitate the arrival of the maximum number of aircraft with the least average delay. Priority in the approach sequence should be given to:
 - (1) an aircraft which anticipates being compelled to land because of factors affecting the safe operation of the aircraft (engine failure, below minimum fuel state, etc.);
 - (2) hospital aircraft or aircraft carrying any sick or seriously injured person requiring urgent medical attention;
 - (3) aircraft engaged in search and rescue operations; and
 - (4) other aircraft as may be determined by the competent authority.
- (b) Succeeding aircraft should be cleared for approach when:
 - (1) the preceding aircraft has reported that it is able to complete its approach without encountering IMC; or
 - (2) the preceding aircraft is in communication with and sighted by the aerodrome control tower, and reasonable assurance exists that a normal landing can be accomplished; or
 - (3) timed approaches are used, the preceding aircraft has passed the defined point inbound, and reasonable assurance exists that a normal landing can be accomplished; or
 - (4) the use of an ATS surveillance system confirms that the required longitudinal spacing between succeeding aircraft has been established.

GM1 to AMC5 ATS.TR.210(a)(3) Operation of air traffic control service

APPROACH SEQUENCE — SEQUENCING AND SPACING OF INSTRUMENT APPROACHES

(a) Timed approach procedures

- (1) The following procedure should be utilised as necessary to expedite the approaches of a number of arriving aircraft:
 - (i) a suitable point on the approach path, which shall be capable of being accurately determined by the pilot, should be specified, to serve as a checkpoint in timing successive approaches;
 - (ii) aircraft should be given a time at which to pass the specified point inbound, which time should be determined with the aim of achieving the desired interval between successive landings on the runway while respecting the applicable separation minima at all times, including the period of runway occupancy.
- (2) The time at which aircraft shall pass the specified point should be determined by the unit providing approach control service and notified to the aircraft sufficiently in advance to permit the pilot to arrange the flight path accordingly.
- (3) Each aircraft in the approach sequence should be cleared to pass the specified point inbound at the previously notified time, or any revision thereof, after the preceding aircraft has reported passing the point inbound.

(b) Interval between successive approaches

In determining the time interval or longitudinal distance to be applied between successive approaching aircraft, the relative speeds between succeeding aircraft, the distance from the specified point to the runway, the need to apply wake turbulence separation, runway occupancy times, the prevailing meteorological conditions as well as any condition which may affect runway occupancy times should be considered. When an ATS surveillance system is used to establish an approach sequence, the minimum distance to be established between succeeding aircraft should be specified in local instructions. Local instructions should additionally specify the circumstances under which any increased longitudinal distance between approaches may be required as well as the minima to be used under such circumstances.

AMC6 ATS.TR.210(a)(3) Operation of air traffic control service

EXPECTED APPROACH TIME

- (a) The appropriate air traffic services unit should determine an expected approach time for an arriving aircraft that will be subjected to a delay of 10 minutes or more.
- (b) The expected approach time should be transmitted to the aircraft as soon as practicable and preferably not later than at the commencement of its initial descent from cruising level.
- (c) A revised expected approach time should be transmitted to the aircraft without delay whenever it differs from that previously transmitted by 5 minutes or more, or such lesser period of time

as has been established by the competent authority or agreed between the air traffic services units concerned.

- (d) An expected approach time should be transmitted to the aircraft by the most expeditious means whenever it is anticipated that the aircraft will be required to hold for 30 minutes or more.
- (e) The holding fix to which an expected approach time relates should be identified together with the expected approach time whenever circumstances are such that this would not otherwise be evident to the pilot.

AMC7 ATS.TR.210(a)(3) Operation of air traffic control service

ONWARD CLEARANCE TIME

In the event that an aircraft is held en-route or at a location or aid other than the initial approach fix (IAF), the appropriate air traffic services unit should, as soon as practicable, give the aircraft concerned an expected onward clearance time from the holding fix. The aircraft should also be advised if further holding at a subsequent holding fix is expected.

AMC8 ATS.TR.210(a)(3) Operation of air traffic control service

INSTRUMENT APPROACH

- (a) The approach control unit should specify the instrument approach procedure to be used by arriving aircraft. When a flight crew requests an alternative instrument approach procedure, the approach control unit should clear it accordingly, if circumstances permit.
- (b) If a pilot reports or it is clearly apparent to the air traffic control unit that the pilot is not familiar with an instrument approach procedure, the initial approach level, the point (in minutes from the appropriate reporting point) at which base turn or procedure turn will be started, the level at which the procedure turn is to be carried out and the final approach track should be specified, except that only the last-mentioned need be specified if the aircraft is to be cleared for a straight-in approach. The frequency(-ies) of the navigation aid(s) to be used as well as the missed approach procedure should also be specified when deemed necessary.

GM1 to AMC8 ATS.TR.210(a)(3) Operation of air traffic control service

INSTRUMENT APPROACH

If visual reference to terrain is established before completion of the approach procedure, the entire procedure should nevertheless be executed unless the aircraft requests and is cleared for a visual approach.

AMC9 ATS.TR.210(a)(3) Operation of air traffic control service

VISUAL APPROACH

- (a) Subject to the conditions described in point (b), clearance for an IFR flight to execute a visual approach may be requested by a flight crew or initiated by the air traffic controller. In the latter case, the concurrence of the flight crew should be required.

- (b) An IFR flight should only be cleared to execute a visual approach, provided the pilot can maintain visual reference to the terrain and:
- (1) the reported ceiling is at or above the level of the beginning of the initial approach segment for the aircraft so cleared; or
 - (2) the pilot reports at the level of the beginning of the initial approach segment or at any time during the instrument approach procedure that the meteorological conditions are such that with reasonable assurance a visual approach and landing can be completed.
- (c) Except between aircraft performing successive visual approaches as described in point (d), separation should be provided between an aircraft cleared to execute a visual approach and other arriving and departing aircraft.
- (d) For successive visual approaches, separation should be maintained by the air traffic controller until the pilot of a succeeding aircraft reports having the preceding aircraft in sight. The aircraft should then be instructed to follow and maintain own separation from the preceding aircraft.
- (e) In case of aircraft performing successive visual approaches and instructed to maintain own separation as in point (d), and the distance between such aircraft is less than the appropriate wake turbulence minimum, the air traffic controller should issue a caution of possible wake turbulence.

GM1 to AMC9 ATS.TR.210(a)(3) Operation of air traffic control service

VISUAL APPROACH

Air traffic controllers should exercise caution in initiating a visual approach when there is a reason to believe that the flight crew concerned is not familiar with the aerodrome and its surrounding terrain. Air traffic controllers should also take into consideration the prevailing traffic and meteorological conditions when initiating visual approaches. The responsibility of the pilot to inform the air traffic control unit, if an ATC clearance is not satisfactory, is specified in point (b)(2) of SERA.8015 of Regulation (EU) 923/2012.

AMC10 ATS.TR.210(a)(3) Operation of air traffic control service

INFORMATION FOR ARRIVING AIRCRAFT

- (a) As early as practicable after an aircraft has established communication with the unit providing approach control service, the following elements of information, in the order listed, should be transmitted to the aircraft, with the exception of such elements which are known to have been already received by the aircraft:
- (1) Type of approach and runway-in-use
 - (2) Meteorological information, as follows:
 - (i) surface wind direction and speed, including significant variations therein;
 - (ii) visibility and, when applicable, runway visual range (RVR);
 - (iii) present weather;

- (iv) cloud below 1 500 m (5 000 ft) or below the highest minimum sector altitude, whichever is greater; cumulonimbus; if the sky is obscured, vertical visibility when available;
 - (v) air temperature;
 - (vi) dew point temperature, inclusion determined on the basis of a regional air navigation agreement;
 - (vii) altimeter setting(s);
 - (viii) any available information on significant meteorological phenomena in the approach area; and
 - (ix) trend-type landing forecast, when available.
- (3) Current runway surface conditions, in case of precipitants or other temporary hazards
 - (4) Changes in the operational status of visual and non-visual aids essential for approach and landing
- (b) At the commencement of final approach, the following information should be transmitted to aircraft:
- (1) significant changes in the mean surface wind direction and speed;
 - (2) the latest information, if any, on wind shear and/or turbulence in the final approach area; and
 - (3) the current visibility representative of the direction of approach and landing or, when provided, the current RVR value(s) and the trend.
- (c) During final approach, the following information should be transmitted without delay:
- (1) the sudden occurrence of hazards (e.g. unauthorised traffic on the runway);
 - (2) significant variations in the current surface wind, expressed in terms of minimum and maximum values;
 - (3) significant changes in runway surface conditions;
 - (4) changes in the operational status of required visual or non-visual aids; and
 - (5) changes in observed RVR value(s), in accordance with the reported scale in use, or changes in the visibility representative of the direction of approach and landing.

GM1 to AMC10 ATS.TR.210(a)(3) Operation of air traffic control service

INFORMATION FOR ARRIVING AIRCRAFT

Significant variations are specified in point (a)(3) of MET.TR.205 of Annex V. However, if the air traffic controller possesses wind information in the form of components, the significant changes are:

- (a) mean headwind component: 19 km/h (10 kt);
- (b) mean tailwind component: 4 km/h (2 kt); and

- (c) mean crosswind component: 9 km/h (5 kt).

AMC11 ATS.TR.210(a)(3) Operation of air traffic control service

START-UP TIME PROCEDURES

- (a) Start-up time procedures should be implemented where necessary to avoid congestion and excessive delays on the manoeuvring area or when necessary to comply with applicable air traffic flow management (ATFM) regulations. Start-up time procedures should be contained in local instructions and should specify the criteria and conditions for determining when and how start-up times should be calculated and issued to departing flights.
- (b) When so requested by the pilot prior to engine start, the aerodrome control tower should give an expected take-off time, unless engine start-up time procedures are employed.
- (c) A start-up clearance should only be withheld under circumstances or conditions specified by the air traffic services provider.
- (d) If a start-up clearance is withheld, the aerodrome control tower should advise the flight crew of the reason.

AMC12 ATS.TR.210(a)(3) Operation of air traffic control service

INFORMATION TO AIRCRAFT BY AERODROME CONTROL TOWERS — AERODROME AND METEOROLOGICAL INFORMATION

- (a) Prior to taxiing for take-off, the aerodrome control tower should advise aircraft of the following elements of information, in the order listed, with the exception of such elements which are known to have been already received by the aircraft:
- (1) the runway to be used;
 - (2) the surface wind direction and speed, including significant variations therein;
 - (3) the QNH altimeter setting and, either on a regular basis in accordance with local arrangements or if so requested by the aircraft, the QFE altimeter setting;
 - (4) the air temperature for the runway to be used, in the case of turbine-engined aircraft;
 - (5) the visibility representative of the direction of take-off and initial climb, if less than 10 km, or, when applicable, the RVR value(s) for the runway to be used; and
 - (6) the correct time.
- (b) Prior to take-off, the aerodrome control tower should advise aircraft of:
- (1) any significant changes in the surface wind direction and speed, the air temperature, and the visibility or RVR value(s) given in accordance with point (a); and
 - (2) significant meteorological conditions in the take-off and climb-out area, except when it is known that the information has already been received by the aircraft.
- (c) Prior to entering the traffic circuit or commencing its approach to land, the relevant air traffic controller unit should provide aircraft with the following elements of information, in the order

listed, with the exception of such elements which are known to have been already received by the aircraft:

- (1) the runway to be used;
- (2) the surface wind direction and speed, including significant variations therein;
- (3) the QNH altimeter setting and, either on a regular basis in accordance with local arrangements or if so requested by the aircraft, the QFE altimeter setting; and
- (4) changes in observed RVR value(s), in accordance with the reported scale in use, or changes in the visibility representative of the direction of approach and landing.

GM1 to AMC12 ATS.TR.210(a)(3) Operation of air traffic control service

SIGNIFICANT METEOROLOGICAL CONDITIONS IN THE TAKE-OFF AND CLIMB-OUT AREA

Significant meteorological conditions include the occurrence or expected occurrence of cumulonimbus or thunderstorm, moderate or severe turbulence, wind shear, hail, moderate or severe icing, severe squall line, freezing precipitation, severe mountain waves, sandstorm, dust storm, blowing snow, tornado or waterspout in the take-off and climb-out area.

AMC13 ATS.TR.210(a)(3) Operation of air traffic control service

TAXI CLEARANCE

- (a) Prior to issuing a taxi clearance, the air traffic controller should determine where the aircraft concerned is parked. Taxi clearances should contain concise instructions and adequate information so as to assist the flight crew in following the correct taxi routes, in avoiding collision with other aircraft or objects and in minimising the potential for the aircraft inadvertently entering an active runway.
- (b) When a taxi clearance contains a taxi limit beyond a runway, it should contain an explicit clearance to cross or an instruction to hold short of that runway at a corresponding holding point.

GM1 to AMC13 ATS.TR.210(a)(3) Operation of air traffic control service

TAXI CLEARANCE

Where standard taxi routes have not been published, the air traffic controller should, whenever possible, describe a taxi route, for example, by use of taxiway and runway designators or alternative identifiers. Other relevant information, such as an aircraft to follow or give way to, should also be provided to a taxiing aircraft.

GM2 to AMC13 ATS.TR.210(a)(3) Operation of air traffic control service

HELICOPTER TAXI OPERATIONS

- (a) The provisions in points (b) to (f) may be considered and applied when wheeled helicopters or vertical take-off and landing (VTOL) aircraft taxi on the surface.
- (b) Ground taxiing uses less fuel than air-taxiing and minimises air turbulence. However, under certain conditions, such as rough, soft or uneven terrain, it may become necessary to air-taxi for safety considerations. Helicopters with articulating rotors (usually designs with three or more main rotor blades) are subject to 'ground resonance' and may, on rare occasions, suddenly lift off the ground to avoid severe damage or destruction.
- (c) When it is requested or necessary for a helicopter to proceed at a slow speed above the surface, normally below 37 km/h (20 kt) and in ground effect, air-taxiing may be authorised.
- (d) Instructions which require small aircraft or helicopters to taxi in close proximity to taxiing helicopters should be avoided and consideration should be given to the effect of turbulence from taxiing helicopters on arriving and departing light aircraft.
- (e) A frequency change should not be issued to single-pilot helicopters hovering or air-taxiing. Whenever possible, control instructions from the next air traffic services unit should be relayed as necessary until the pilot is able to change frequency.
- (f) Most light helicopters are flown by one pilot and require the constant use of both hands and feet to maintain control during low-altitude/low-level flight. Although flight control friction devices assist the pilot, changing frequency near the ground could result in inadvertent ground contact and consequent loss of control.

GM3 to AMC13 ATS.TR.210(a)(3) Operation of air traffic control service

TAXI CLEARANCE ACROSS A RUNWAY-IN-USE

When issuing a crossing instruction of a runway-in-use to a taxiing aircraft, air traffic controllers should ensure that the crossing instruction is issued on the same frequency as that utilised for the issuing of take-off and landing clearances on that runway. Any subsequent instruction to change frequency should be issued to the taxiing aircraft after it has vacated the runway.

AMC14 ATS.TR.210(a)(3) Operation of air traffic control service

TAXIING ON A RUNWAY-IN-USE

- (a) For the purpose of expediting air traffic, aircraft may be permitted to taxi on the runway-in-use, provided no delay or risk to other aircraft will result. Where control of taxiing aircraft is provided by a ground air traffic controller and the control of runway operations by an aerodrome air traffic controller, a clearance to taxi on the runway-in-use should be issued by the aerodrome air traffic controller once direct two-way communications between the pilot and the aerodrome air traffic controller have been established. Any subsequent instruction to change frequency

should be issued by the aerodrome air traffic controller to the taxiing aircraft after it has vacated the runway.

- (b) If the aerodrome air traffic controller is unable to determine, either visually or via an ATS surveillance system, that a vacating or crossing aircraft has cleared the runway, the aircraft should be requested to report when it has vacated the runway. The report should be made when the entire aircraft is beyond the relevant runway-holding position.

AMC15 ATS.TR.210(a)(3) Operation of air traffic control service

USE OF RUNWAY-HOLDING POSITIONS

- (a) The air traffic controller should not hold aircraft closer to a runway-in-use than at a runway-holding position, except as in cases specified in point (b).
- (b) Aircraft should not be permitted to line up and hold on the approach end of a runway-in-use whenever another aircraft is effecting a landing, until the landing aircraft has passed the point of intended holding.

GM1 to AMC15 ATS.TR.210(a)(3) Operation of air traffic control service

RUNWAY-HOLDING POSITIONS

The locations of runway-holding positions in relation to runways are specified in CS ADR-DSN.D.335 'Holding bays, runway-holding positions, intermediate holding positions, and road-holding positions' and in CS ADR-DSN.D.340 'Location of holding bays, runway-holding positions, intermediate holding positions, and road-holding positions' of EASA ED Decision 2014/013/R 'Certification Specifications and Guidance Material For Aerodromes Design', as last amended.

AMC16 ATS.TR.210(a)(3) Operation of air traffic control service

RUNWAY INCURSION OR OBSTRUCTED RUNWAY

In the event that the aerodrome air traffic controller, after a take-off clearance or a landing clearance has been issued, becomes aware of a runway incursion or the imminent occurrence thereof, or the existence of any obstruction on or in close proximity to the runway likely to impair the safety of an aircraft taking off or landing, he or she should take appropriate action as follows:

- (a) cancel the take-off clearance for a departing aircraft;
- (b) instruct a landing aircraft to execute a go-around or missed approach; and
- (c) in all cases inform the aircraft of the runway incursion or obstruction and its location in relation to the runway.

GM1 to AMC16 ATS.TR.210(a)(3) Operation of air traffic control service

RUNWAY INCURSION OR OBSTRUCTED RUNWAY

Animals and flocks of birds may constitute an obstruction with regard to runway operations. In addition, an aborted take-off or a go-around executed after touchdown may expose the aeroplane to the risk of overrunning the runway. Moreover, a low-altitude missed approach may expose the aeroplane to the risk of a tail strike. Pilots may therefore have to exercise their judgement, in accordance with SERA.2015 in Regulation (EU) No 923/2012, concerning the authority of the pilot-in-command of an aircraft.

GM2 to AMC16 ATS.TR.210(a)(3) Operation of air traffic control service

CANCELLING A TAKE-OFF CLEARANCE FOR DEPARTING AIRCRAFT

- (a) If a take-off clearance has to be cancelled before the take-off run has commenced, the pilot should be instructed to hold position and to acknowledge the instruction.
- (b) In certain circumstances, the aerodrome air traffic controller may consider that it is necessary to cancel a take-off clearance after the aircraft has commenced the take-off run. In this event, the pilot should be instructed to stop immediately and to acknowledge the instruction.
- (c) The cancellation of a take-off clearance after an aircraft has commenced its take-off run should only occur when the aircraft will be in serious and imminent danger should it continue. Air traffic controllers should be aware of the potential for an aircraft to overrun the end of the runway if the take-off is abandoned at a late stage; this is particularly so with large aircraft or those operating close to their performance limit, such as at maximum take-off mass, in high ambient temperatures or when the runway braking action may be adversely affected. Because of this risk, even if a take-off clearance is cancelled, the pilot-in-command may consider it safer to continue the take-off than to attempt to stop the aircraft.
- (d) Air traffic controllers should also be aware of the possibility that an aircraft that abandons its take-off may suffer overheated brakes or another abnormal situation and should be prepared to declare the appropriate category of emergency or to provide other suitable assistance.

AMC17 ATS.TR.210(a)(3) Operation of air traffic control service

AERODROME CONTROL — TAKE-OFF CLEARANCE

- (a) The aerodrome control tower may issue a take-off clearance to an aircraft when there is reasonable assurance that the separation for departing aircraft as in AMC7 ATS.TR.210(c)(2)(i), or the separation prescribed in accordance with AMC9 ATS.TR.210(c)(2)(i) for reduced runway separation minima between aircraft using the same runway, will exist when the aircraft commences take-off.
- (b) When an ATC clearance is required prior to take-off, the aerodrome control tower should not issue the take-off clearance until the ATC clearance has been transmitted to and acknowledged by the aircraft concerned. The ATC clearance should be forwarded to the aerodrome control

tower with the least possible delay after receipt of a request made by the tower or prior to such request if practicable.

- (c) Subject to point (b), the take-off clearance should be issued when the aircraft is ready for take-off and at or approaching the departure runway, and the traffic situation permits. To reduce the potential for misunderstanding, the take-off clearance should include the designator of the departure runway.

GM1 AMC17 ATS.TR.210(a)(3) Operation of air traffic control service

AERODROME CONTROL — CLEARANCE FOR IMMEDIATE TAKE-OFF

In the interest of expediting traffic, a clearance for immediate take-off may be issued to an aircraft before it enters the runway.

AMC18 ATS.TR.210(a)(3) Operation of air traffic control service

AERODROME CONTROL — CLEARANCE TO LAND

The aerodrome control tower may clear an aircraft to land when there is reasonable assurance that the separation established in AMC8 ATS.TR.210(c)(2)(i), or the separation prescribed in accordance with AMC9 ATS.TR.210(c)(2)(i) for reduced runway separation minima between aircraft using the same runway, will exist when the aircraft crosses the runway threshold, provided that a clearance to land should not be issued until a preceding landing aircraft has crossed the runway threshold. To reduce the potential for misunderstanding, the landing clearance should include the designator of the landing runway.

AMC19 ATS.TR.210(a)(3) Operation of air traffic control service

AERODROME CONTROL — PRIORITY FOR LANDING

In the provision of aerodrome control service, priority for landing should be given to:

- (a) an aircraft which anticipates being compelled to land because of factors affecting the safe operation of the aircraft (e.g. engine failure, shortage of fuel, etc.);
- (b) hospital aircraft or aircraft carrying any sick or seriously injured persons requiring urgent medical attention;
- (c) aircraft engaged in search and rescue operations; and
- (d) other aircraft as may be determined by the competent authority.

GM1 to AMC19 ATS.TR.210(a)(3) Operation of air traffic control service

AERODROME CONTROL — PRIORITY FOR LANDING

- (a) An aircraft landing or in the final stages of an approach to land should normally have priority over an aircraft intending to depart from the same or an intersecting runway.

- (b) If an aircraft enters an aerodrome traffic circuit without proper authorisation, it should be permitted to land if its actions indicate that it so desires. If circumstances warrant, aircraft which are in contact with the air traffic controller may be instructed to give way so as to remove as soon as possible the hazard introduced by such unauthorised operation. In no case should permission to land be withheld indefinitely.
- (c) In cases of emergency, it may be necessary, in the interest of safety, for an aircraft to enter a traffic circuit and effect a landing without proper authorisation. Air traffic controllers should recognise the possibilities of emergency action and render all assistance possible.

AMC20 ATS.TR.210(a)(3) Operation of air traffic control service

VISUAL DEPARTURE

- (a) An IFR flight may be cleared to execute a visual departure:
- (1) when requested by the pilot; or
 - (2) prior to take-off, when initiated by the air traffic controller and accepted by the pilot by a read-back of the ATC clearance.
- (b) When implemented, visual departure should be applied under the following conditions:
- (1) the meteorological conditions in the direction of take-off and the following climb-out are such that they do not impair the procedure up to the established altitude published in the AIP, e.g. minimum flight altitude (MFA) or minimum sector altitude (MSA);
 - (2) the procedure is to be applied during the daytime;
 - (3) the pilot is responsible for maintaining obstacle clearance until the specified altitude. Further clearance (route, heading, point) should be specified by the air traffic controller; and
 - (4) separation is provided between an aircraft cleared to execute a visual departure and other aircraft, in accordance with the airspace classification.
- (c) Any additional local restrictions should be agreed upon in consultation between the air traffic services provider and operators.

GM1 to AMC20 ATS.TR.210(a)(3) Operation of air traffic control service

VISUAL DEPARTURE

If the aircraft is in or may enter airspace class D during the application of the visual departure, attention is drawn to the requirement to provide timely VFR traffic information deemed relevant for the aircraft executing the visual departure. Flight crews should be made aware when the application of the visual departure may lead the departing aircraft to enter airspace classes E, F or G.

GM2 to AMC20 ATS.TR.210(a)(3) Operation of air traffic control service

FLIGHT CREW ACCEPTANCE OF VISUAL DEPARTURE

Flight crew acceptance of the clearance for visual departure will indicate that the aircraft take-off performance characteristics allow an early turn after take-off.

AMC21 ATS.TR.210(a)(3) Operation of air traffic control service

MISSED APPROACHES INSTRUCTIONS

When issuing instructions for a missed approach to a flight conducting an instrument approach procedure, the air traffic controller should adhere to the published missed approach procedure. The air traffic controller should issue modifications to the published missed approach procedure only in presence of safety reasons.

GM1 ATS.TR.210(a)(3) Operation of air traffic control service

AERODROME CONTROL — CLEARANCES IN THE TRAFFIC CIRCUIT

- (a) The clearance to enter the traffic circuit should be issued to an aircraft whenever it is desired that the aircraft approach the landing area in accordance with current traffic circuits but traffic conditions do not yet allow a landing clearance to be issued. Depending on the circumstances and traffic conditions, an aircraft may be cleared to join at any position in the traffic circuit.
- (b) When so instructed by the air traffic controller, pilots should obtain approval prior to turning on to any of the aerodrome traffic circuit legs. When extending an aerodrome traffic circuit leg, pilots should report to the air traffic control unit as soon as there is a risk that visual contact with the runway cannot be maintained.
- (c) An arriving aircraft executing an instrument approach should normally be cleared to land straight in unless visual manoeuvring to the landing runway is required.

GM2 ATS.TR.210(a)(3) Operation of air traffic control service

AERODROME CONTROL — INSTRUCTIONS FOR LANDING AND ROLL-OUT MANOEUVRES

- (a) When necessary or desirable in order to expedite traffic, the aerodrome control tower may request a landing aircraft to:
 - (1) hold short of an intersecting runway after landing;
 - (2) land beyond the touchdown zone of the runway;
 - (3) vacate the runway at a specified exit taxiway; and
 - (4) expedite vacating the runway.
- (b) In requesting a landing aircraft to perform a specific landing and/or roll-out manoeuvre, the type of aircraft, runway length, location of exit taxiways, reported braking action on runway and taxiway, and prevailing meteorological conditions should be considered. A HEAVY aircraft should not be requested to land beyond the touchdown zone of a runway.

- (c) When necessary or desirable, e.g. due to low-visibility conditions, a landing or a taxiing aircraft may be instructed to report when a runway has been vacated. The report should be made when the entire aircraft is beyond the relevant runway-holding position.

GM3 ATS.TR.210(a)(3) Operation of air traffic control service

FORMULATION OF INSTRUCTIONS AND INFORMATION TO AIRCRAFT ON THE GROUND

As the view from the flight deck of an aircraft is normally restricted, the air traffic controller should ensure that instructions and information which require the flight crew to employ visual detection, recognition and observation are phrased in a clear, concise and complete manner.

GM4 ATS.TR.210(a)(3) Operation of air traffic control service

INFORMATION ON JET BLAST AND PROPELLER SLIPSTREAM

- (a) In issuing clearances or instructions, air traffic controllers should take into account the hazards caused by jet blast and propeller slipstream to taxiing aircraft, to aircraft taking off or landing, particularly when intersecting runways are being used, and to vehicles and personnel operating on the aerodrome.
- (b) Jet blast and propeller slipstream can produce localised wind velocities of sufficient strength to cause damage to other aircraft, vehicles and personnel operating within the affected area.

GM5 ATS.TR.210(a)(3) Operation of air traffic control service

DESIGNATED POSITIONS OF AIRCRAFT IN THE AERODROME TRAFFIC AND TAXI CIRCUIT IN RELATION TO AERODROME CONTROL TOWER CLEARANCES

The following positions of aircraft in the traffic and taxi circuits, as shown in Figure 1, are the positions where aircraft normally receive aerodrome control tower clearances. Aircraft should be watched closely as they approach these positions so that proper clearances may be issued without delay. Where practicable, all clearances should be issued without waiting for aircraft to initiate the call.

- Position 1. Aircraft initiates call to taxi for departing flight. Runway-in-use information and taxi clearances given.
- Position 2. If there is conflicting traffic, the departing aircraft will be held at this position. Engine run-up will, when required, normally be performed here.
- Position 3. Take-off clearance is issued here if not practicable at position 2.
- Position 4. Clearance to land is issued here as practicable.
- Position 5. Clearance to taxi to apron is issued here.
- Position 6. Parking information is issued here if necessary.

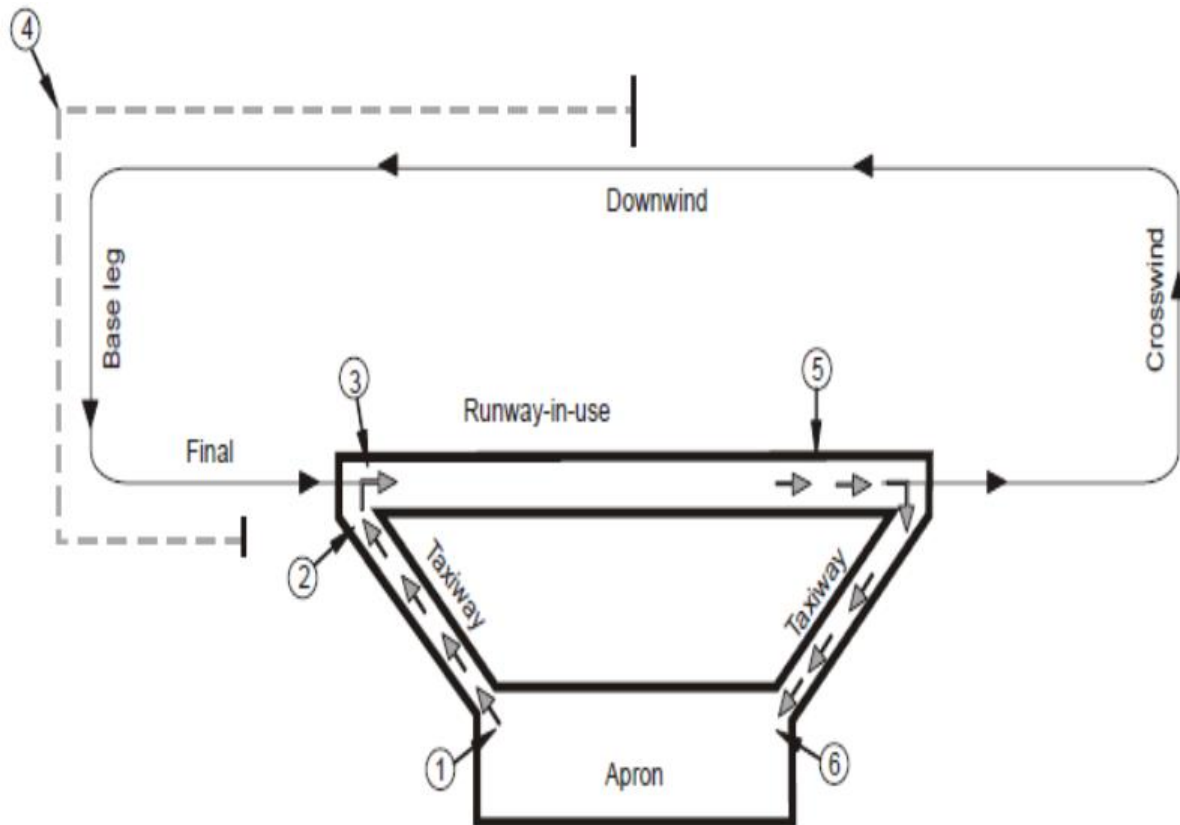
Figure 1

GM6 ATS.TR.210(a)(3) Operation of air traffic control service AERODROME CONTROL — PRIORITY FOR DEPARTURE

Departures should normally be cleared in the order in which aircraft are ready for take-off, except that deviations may be made from this order of priority to facilitate the maximum number of departures with the least average delay. Factors which should be considered in relation to the departure sequence include, inter alia:

- (a) types of aircraft and their relative performance;
- (b) routes to be followed after take-off;
- (c) any specified minimum departure interval between take-offs;
- (d) need to apply wake turbulence separation minima;
- (e) aircraft which should be afforded priority; and
- (f) aircraft subject to ATFM requirements.

GM7 ATS.TR.210(a)(3) Operation of air traffic control service**AERODROME CONTROL — PRIORITY FOR DEPARTURE AND ATFM MEASURES**

For aircraft subject to ATFM requirements, it is the responsibility of the pilot and the operator to ensure that the aircraft is ready to taxi in time to meet any required departure time, bearing in mind that once a departure sequence is established on the taxiway system, it can be difficult, and sometimes impossible, to change the order.

GM1 ATS.TR.210(b) Operation of air traffic control service**CLEARANCES TO FLY MAINTAINING OWN SEPARATION WHILE IN VISUAL METEOROLOGICAL CONDITIONS**

- (a) If there is a possibility that flight under visual meteorological conditions (VMC) may become impracticable, an IFR flight should be provided with alternative instructions to be complied with in the event that flight in VMC cannot be maintained for the term of the clearance.
- (b) The pilot of an IFR flight, on observing that conditions are deteriorating and considering that operation in VMC will become impossible, should inform the air traffic control unit before entering instrumental meteorological conditions (IMC) and should proceed in accordance with the alternative instructions given.

GM2 ATS.TR.210(b) Operation of air traffic control service**CLEARANCES TO FLY MAINTAINING OWN SEPARATION WHILE IN VISUAL METEOROLOGICAL CONDITIONS**

- (a) The provision of vertical or horizontal separation by an air traffic unit is not applicable in respect of any specified portion of a flight cleared subject to maintaining own separation and remaining in VMC. It is for the aircraft so cleared to ensure, for the duration of the clearance, that it is not operated in such proximity to other flights as to create a collision hazard.
- (b) It is axiomatic that a VFR flight must remain in VMC at all times. Accordingly, the issuance of a clearance to a VFR flight to fly subject to maintaining own separation and remaining in VMC has no other object than to signify that, for the duration of the clearance, separation from other aircraft by air traffic control unit is not provided.
- (c) It should be noted that the objectives of the air traffic control service as prescribed in ATS.TR.100 do not include prevention of collision with terrain. Pilots are responsible for ensuring that any clearances issued by air traffic control units are safe in this respect. When vectoring or assigning a direct routing not included in the flight plan, which takes an IFR flight off published ATS route or instrument procedure, the procedures in point (a)(5) of ATS.TR.235 apply.

AMC1 ATS.TR.210(c) Operation of air traffic control service**EMERGENCY SEPARATION APPLICATION**

- (a) If, during an emergency situation, it is not possible to ensure that the applicable horizontal separation can be maintained, emergency separation of half the applicable vertical separation minimum may be used, i.e. a nominal 150 m (500 ft) between aircraft in airspace where a

vertical separation minimum of 300 m (1 000 ft) is applied, and a nominal 300 m (1 000 ft) between aircraft in airspace where a 600 m (2 000 ft) vertical separation minimum is applied.

- (b) When emergency separation is applied, the flight crews concerned should be advised that emergency separation is being applied, and informed of the actual minimum used. Additionally, all flight crews concerned should be provided with essential traffic information.

GM1 to AMC1 ATS.TR.210(c) Operation of air traffic control service SEPARATION APPLICATION IN CASE OF ATS SURVEILLANCE SYSTEM FAILURE

As an emergency measure, in the event of complete failure of the ATS surveillance system where air-ground communications remain, the use of flight levels spaced by half the applicable vertical separation minimum may be resorted to temporarily if standard procedural separation cannot be provided immediately.

GM2 ATS.TR.210(c) Operation of air traffic control service PROCEDURAL SEPARATION — APPLICATION OF LARGER SEPARATION MINIMA UNDER SPECIFIC CIRCUMSTANCES

Larger separations than the specified minima should be applied whenever exceptional circumstances such as unlawful interference or navigational difficulties call for extra precautions. This should be done with due regard to all relevant factors so as to avoid impeding the flow of air traffic by the application of excessive separations.

AMC1 ATS.TR.210(c)(1) Operation of air traffic control service PROCEDURAL SEPARATION — SEPARATION OF AIRCRAFT HOLDING IN FLIGHT

- (a) Aircraft established in adjacent holding patterns should, except when lateral separation between the holding areas exists as determined by the air traffic services provider and approved by the competent authority, be separated by the applicable vertical separation minimum.
- (b) Except when lateral separation exists, the air traffic controller should apply vertical separation between aircraft holding in flight and other aircraft, whether arriving, departing or en-route, whenever the other aircraft concerned are within 5 minutes flying time of the holding area or within a distance established by the air traffic services provider and approved by the competent authority (see Figure 2).

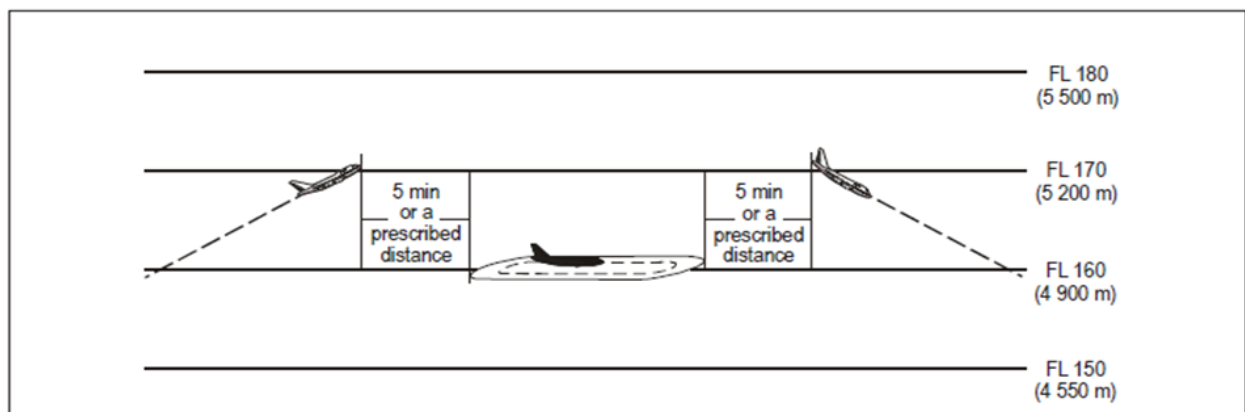

Figure 2: Separation between holding aircraft and en-route aircraft**GM1 to AMC1 ATS.TR.210(c)(1) Operation of air traffic control service****SEPARATION OF AIRCRAFT HOLDING IN FLIGHT**

Criteria and procedures for the simultaneous use of adjacent holding patterns should be prescribed in local instructions.

GM1 ATS.TR.210(c)(1) Operation of air traffic control service**VERTICAL SEPARATION APPLICATION**

Vertical separation is obtained by requiring aircraft using prescribed altimeter setting procedures to operate at different levels expressed in terms of flight levels or altitudes, in accordance with the provisions in ATS.TR.125, ATS.TR.130, ATS.TR.135 and ATS.TR.140.

GM2 ATS.TR.210(c)(1) Operation of air traffic control service**APPLICATION OF VERTICAL SEPARATION DURING CLIMB OR DESCENT**

(a) An aircraft may be cleared to a level previously occupied by another aircraft after the latter has reported vacating it, except when:

- (1) severe turbulence is known to exist;
- (2) the higher aircraft is effecting a cruise climb; or
- (3) the difference in aircraft performance is such that less than the applicable separation minimum may result;

in which case such clearance should be withheld until the aircraft vacating the level has reported at or passing another level separated by the required minimum.

(b) When the aircraft concerned are entering or established in the same holding pattern, consideration should be given to aircraft descending at markedly different rates and, if necessary, additional measures such as specifying a maximum descent rate for the higher aircraft and a minimum descent rate for the lower aircraft should be applied to ensure that the required separation is maintained.

GM3 ATS.TR.210(c)(1) Operation of air traffic control service**GEOMETRIC HEIGHT INFORMATION**

Geometric height information is generated by airborne systems such as, for instance, GPS or radio altimeters.

AMC1 ATS.TR.210(c)(2) Operation of air traffic control service**HORIZONTAL SEPARATION MINIMA BASED ON ATS SURVEILLANCE SYSTEM**

- (a) Unless otherwise prescribed in accordance with point (b), or AMC6 ATS.TR.220, or point (d) of AMC7 ATS.TR.220, or ATS.TR.255, the horizontal separation minimum based on radar and/or ADS-B and/or MLAT systems should be 9.3 km (5.0 NM).
- (b) If so established by the air traffic services provider and approved by the competent authority, the separation minimum in point (a) may be reduced but not below:
- (1) 5.6 km (3.0 NM) when radar and/or ADS-B and/or MLAT systems' capabilities at a given location so permit; and
 - (2) 4.6 km (2.5 NM) between succeeding aircraft which are established on the same final approach track within 18.5 km (10 NM) of the runway threshold. A reduced separation minimum of 4.6 km (2.5 NM) may be applied, provided:
 - (i) the average runway occupancy time of landing aircraft is proven, by means such as data collection and statistical analysis and methods based on a theoretical model, not to exceed 50 seconds;
 - (ii) braking action is reported as good and runway occupancy times are not adversely affected by runway contaminants such as slush, snow or ice;
 - (iii) an ATS surveillance system with appropriate azimuth and range resolution and an update rate of 5 seconds or less is used in combination with suitable displays;
 - (iv) the aerodrome air traffic controller is able to observe, visually or by means of surface movement radar (SMR), MLAT system or a surface movement guidance and control system (SMGCS), the runway-in-use and associated exit and entry taxiways;
 - (v) wake turbulence separation minima in AMC6 ATS.TR.220 or in point (d) of AMC7 ATS.TR.220, or as may be prescribed by the air traffic services provider and approved by the competent authority (e.g. for specific aircraft types), do not apply;
 - (vi) aircraft approach speeds are closely monitored by the air traffic controller and when necessary adjusted so as to ensure that separation is not reduced below the minimum;
 - (vii) aircraft operators and pilots have been made fully aware of the need to exit the runway in an expeditious manner whenever the reduced separation minimum on final approach is applied; and
 - (viii) procedures concerning the application of the reduced minimum are published in AIPs.

GM1 to AMC1 ATS.TR.210(c)(2) Operation of air traffic control service

CRITERIA FOR APPLICATION OF HORIZONTAL SEPARATION BASED ON RADAR AND/OR ADS-B AND/OR MLAT SYSTEMS

- (a) The separation minimum or minima based on radar and/or ADS-B and/or MLAT systems to be applied should be prescribed by the air traffic services provider and approved by the competent authority according to the capability of the particular ATS surveillance system or sensor to

accurately identify the aircraft position in relation to the centre of a position symbol, PSR blip, SSR response and taking into account factors which may affect the accuracy of the ATS surveillance system-derived information, such as aircraft range from the radar site and the range scale of the situation display in use.

- (b) Separation based on the use of ADS-B, SSR and/or MLAT, and/or PSR position symbols and/or PSR blips should be applied so that the distance between the centres of the position symbols and/or PSR blips, representing the positions of the aircraft concerned, is never less than a prescribed minimum.
- (c) Separation based on the use of PSR blips and SSR responses should be applied so that the distance between the centre of the PSR blip and the nearest edge of the SSR response (or centre, when authorised by the competent authority) is never less than a prescribed minimum.
- (d) Separation based on the use of ADS-B position symbols and SSR responses should be applied so that the distance between the centre of the ADS-B position symbol and the nearest edge of the SSR response (or the centre, when authorised by the competent authority) is never less than a prescribed minimum.
- (e) Separation based on the use of SSR responses should be applied so that the distance between the closest edges of the SSR responses (of the centres, when authorised by the competent authority) is never less than a prescribed minimum.
- (f) In no circumstances should the edges of the position indications touch or overlap unless vertical separation is applied between the aircraft concerned, irrespective of the type of position indication displayed and separation minimum applied.

AMC2 ATS.TR.210(c)(2) Operation of air traffic control service

SPECIFIC CONDITIONS AND LIMITATIONS FOR THE APPLICATION OF SEPARATION MINIMA BASED ON ATS SURVEILLANCE SYSTEM

- (a) The separation minima based on ATS surveillance systems specified in AMC1 ATS.TR.210(c)(2), AMC6 ATS.TR.220 and point (d) of AMC7 ATS.TR.220 may be applied between an aircraft taking off and a preceding departing aircraft or other identified traffic, provided there is reasonable assurance that the departing aircraft will be identified within 2 km (1 NM) from the end of the runway, and that, at the time, the required separation will exist.
- (b) The separation minima specified based on ATS surveillance systems should not be applied between aircraft holding over the same holding fix.

AMC3 ATS.TR.210(c)(2) Operation of air traffic control service

PROCEDURAL SEPARATION — REDUCTION IN LATERAL AND LONGITUDINAL SEPARATION MINIMA

- (a) Provided that prior consultation with airspace users is undertaken and that an appropriate safety assessment has shown that an acceptable level of safety is maintained, the lateral and longitudinal separation minima established in:
 - AMC1 ATS.TR.210(c)(2)(i);
 - AMC2 ATS.TR.210(c)(2)(i);

- AMC3 ATS.TR.210(c)(2)(i);
- AMC4 ATS.TR.210(c)(2)(i);
- AMC5 ATS.TR.210(c)(2)(i);
- AMC6 ATS.TR.210(c)(2)(i); and
- AMC1 ATS.TR.210(c)(2)(ii)

may be reduced in the following circumstances:

- (1) when special electronic or other aids enable the pilot-in-command of an aircraft to determine accurately the aircraft's position and when adequate communication facilities exist for that position to be transmitted without delay to the appropriate air traffic control unit; or
- (2) when, in association with rapid and reliable communication facilities, information of an aircraft's position, derived from an ATS surveillance system, is available to the appropriate air traffic control unit; or
- (3) when RNAV-equipped aircraft operate within the coverage of electronic aids that provide the necessary updates to maintain navigation accuracy.

(b) In addition to the circumstances mentioned in point (a), the lateral and longitudinal separation minima established in:

- AMC1 ATS.TR.210(c)(2)(i);
- AMC2 ATS.TR.210(c)(2)(i);
- AMC3 ATS.TR.210(c)(2)(i);
- AMC4 ATS.TR.210(c)(2)(i);
- AMC5 ATS.TR.210(c)(2)(i);
- AMC6 ATS.TR.210(c)(2)(i); and
- AMC1 ATS.TR.210(c)(2)(ii)

may be reduced in the vicinity of aerodromes if:

- (1) adequate separation can be provided by the aerodrome air traffic controller when each aircraft is continuously visible to this air traffic controller; or
- (2) each aircraft is continuously visible to flight crews of the other aircraft concerned and the pilots thereof report that they can maintain their own separation; or
- (3) in the case of one aircraft following another, the flight crew of the succeeding aircraft reports that the other aircraft is in sight and separation can be maintained.

GM1 ATS.TR.210(c)(2)(i) Operation of air traffic control service

PROCEDURAL SEPARATION — LONGITUDINAL SEPARATION APPLICATION

(a) Longitudinal separation should be applied so that the spacing between the estimated positions of the aircraft being separated is never less than a prescribed minimum. Longitudinal separation

between aircraft following the same or diverging tracks may be maintained by application of speed control, including the Mach number technique. When applicable, use of the Mach number technique should be prescribed on the basis of a regional air navigation agreement.

- (b) Longitudinal separation between supersonic aircraft during the transonic acceleration and supersonic phases of flight should normally be established by appropriate timing of the start of transonic acceleration rather than by the imposition of speed restrictions in supersonic flight.
- (c) Time-based separation applied in accordance with AMC1 ATS.TR.210(c)(2)(i), AMC2 ATS.TR.210(c)(2)(i) and AMC5 ATS.TR.210(c)(2)(i) may be based on position information and estimates derived from voice reports, controller-pilot data link communications (CPDLC) or ADS-C.
- (d) For the purpose of application of longitudinal separation, the terms 'same track', 'reciprocal tracks' and 'crossing tracks' have the following meanings:

- (1) Same track (see Figure 3)

Same direction tracks and intersecting tracks or portions thereof, the angular difference of which is less than 45 degrees or more than 315 degrees, and whose protected airspaces overlap

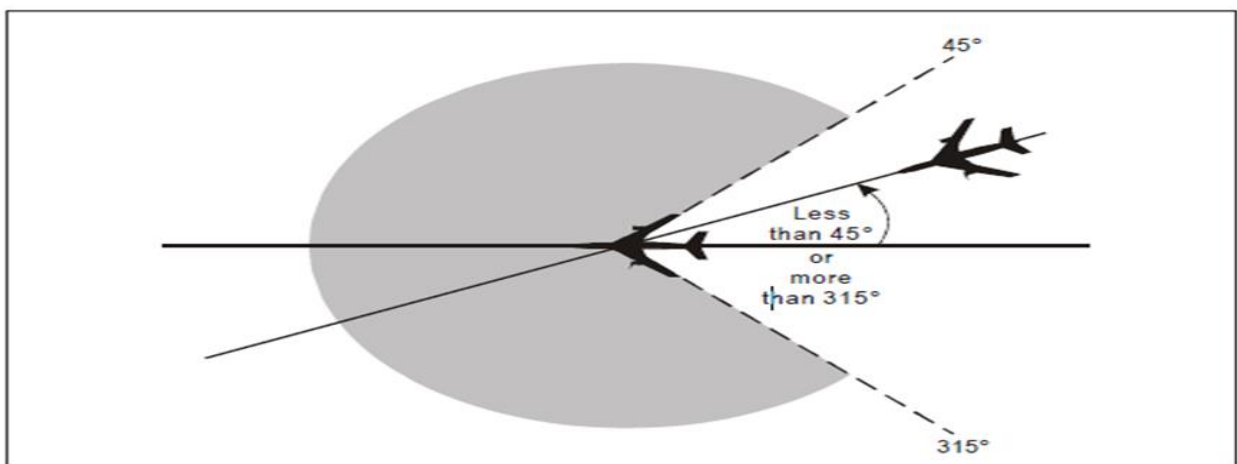

Figure 3: Aircraft on same track

- (2) Reciprocal tracks (see Figure 4)

Opposite tracks and intersecting tracks or portions thereof, the angular difference of which is more than 135 degrees but less than 225 degrees, and whose protected airspaces overlap

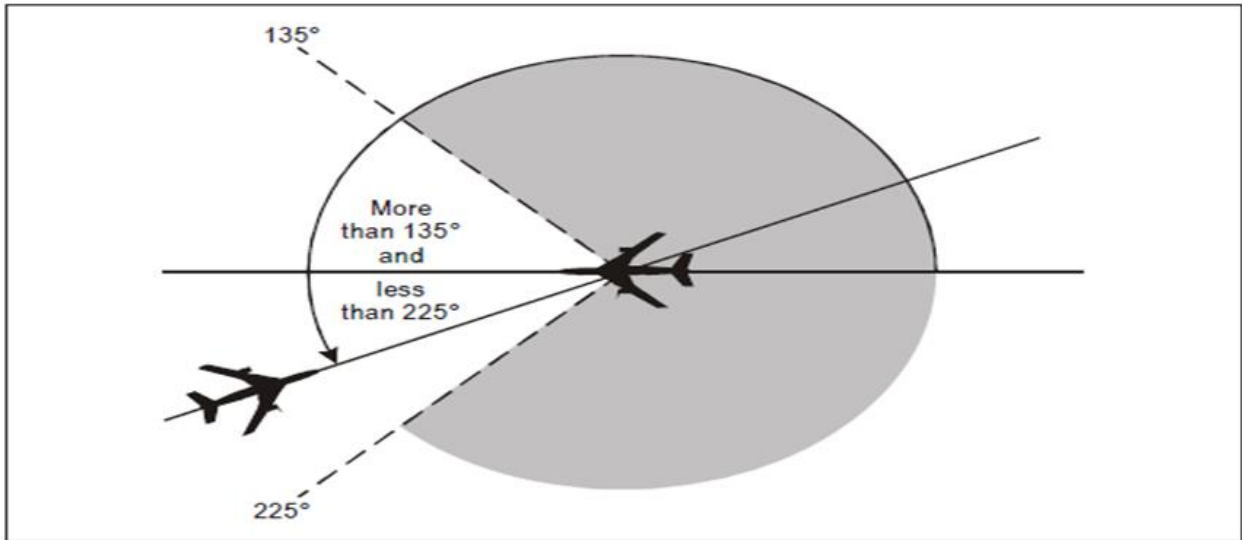

Figure 4: Aircraft on reciprocal tracks

(3) Crossing tracks (see Figure 5)

Intersecting tracks or portions thereof other than those specified in points (1) and (2)

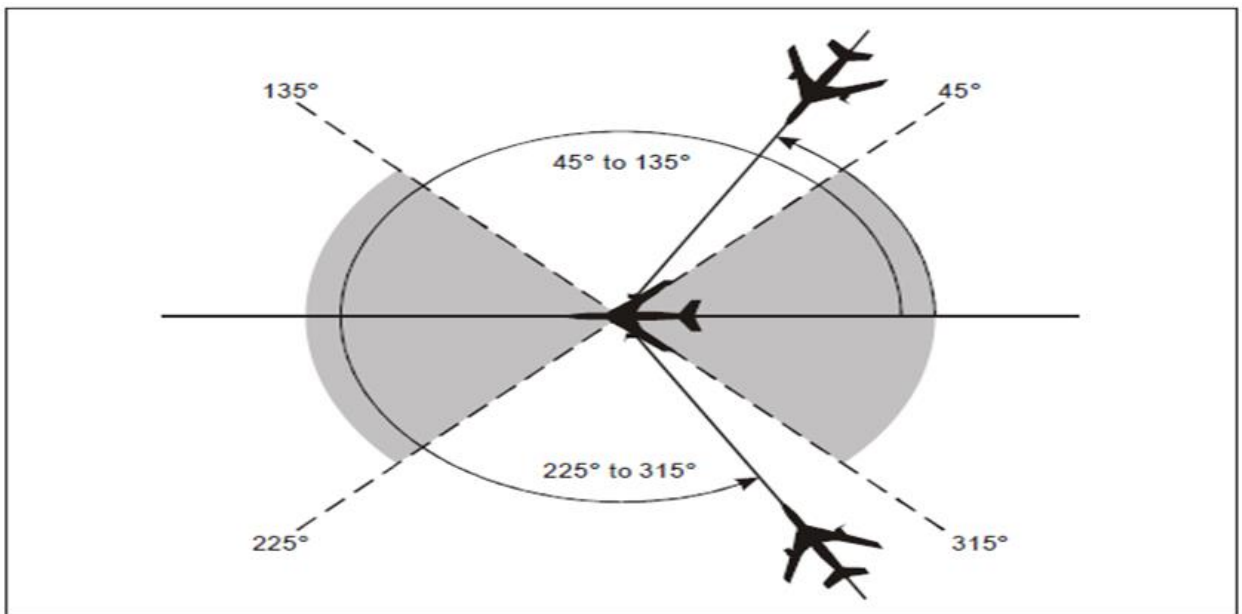

Figure 5: Aircraft on crossing tracks

**AMC1 ATS.TR.210(c)(2)(i) Operation of air traffic control service
PROCEDURAL SEPARATION — LONGITUDINAL SEPARATION MINIMA BASED ON TIME — AIRCRAFT
MAINTAINING THE SAME LEVEL**

For aircraft flying at the same level, the longitudinal separation minima based on time should be one of the following:

(a) Aircraft flying on the same track and same level

(1) 15 minutes (see Figure 6); or

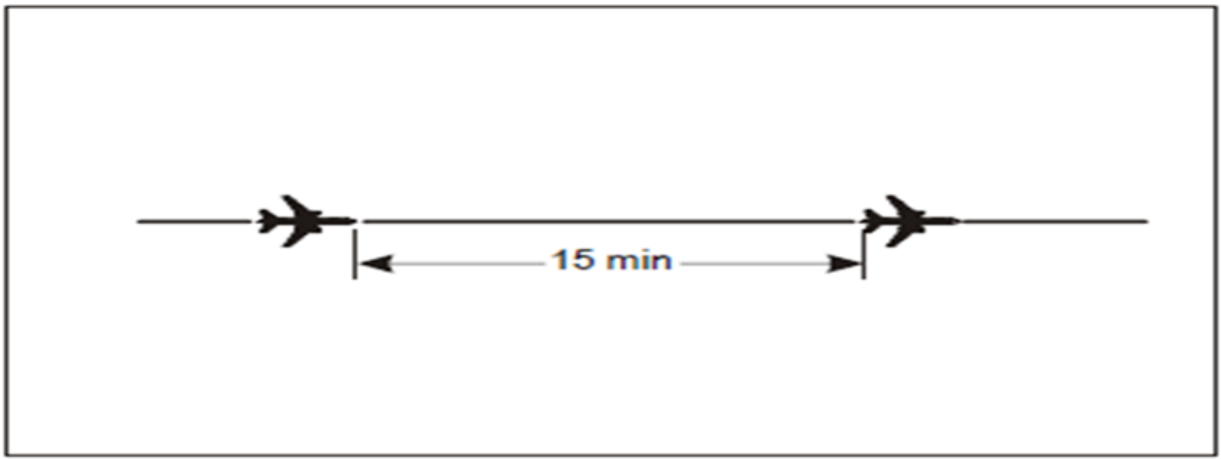

Figure 6: 15-minute separation between aircraft on the same track and same level

- (2) 10 minutes if navigation aids permit frequent determination of position and speed (see Figure 7); or

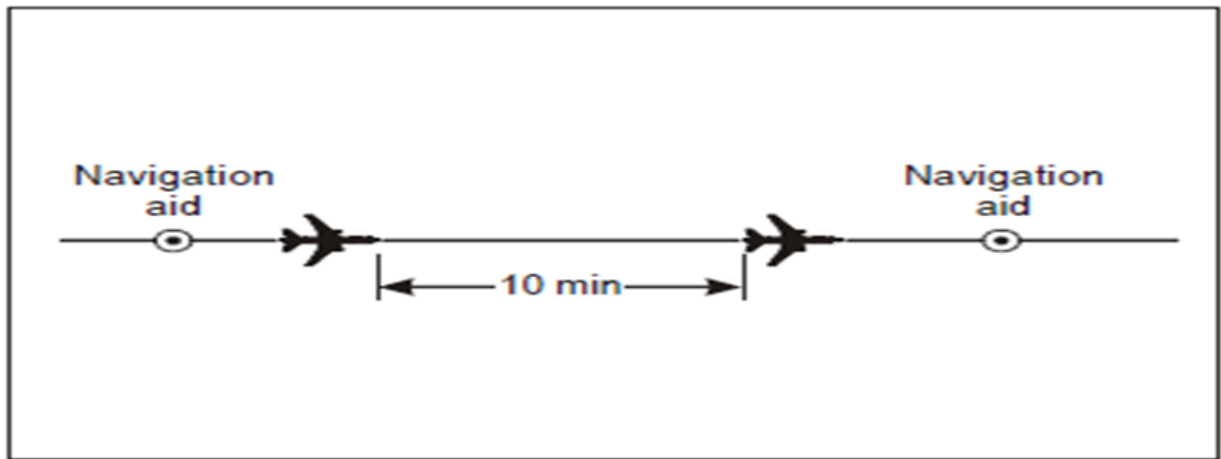

Figure 7: 10-minute separation between aircraft on the same track and same level

- (3) 5 minutes in the following cases, provided that in each case the preceding aircraft is maintaining a TAS of 37 km/h (20 kt) or more faster than the succeeding aircraft (see Figure 8)

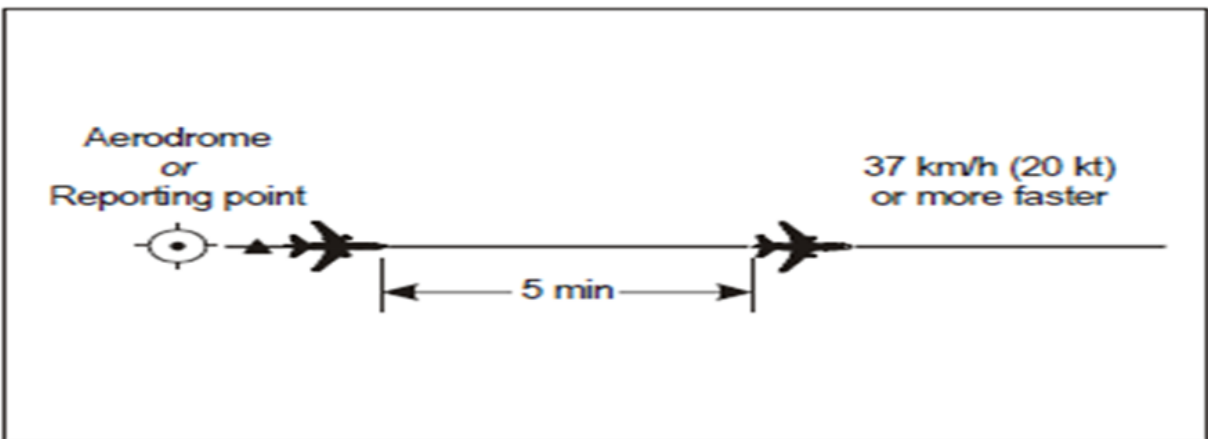

Figure 8: 5-minute separation between aircraft on the same track and same level

- (i) between aircraft that have departed from the same aerodrome;
 - (ii) between en-route aircraft that have reported over the same exact significant point;
 - (iii) between departing and en-route aircraft after the en-route aircraft has reported over a fix that it is so located in relation to the departure point as to ensure that 5-minute separation can be established at the point the departing aircraft will join the air route; or
- (4) 3 minutes in the cases listed under point (a)(3), provided that in each case the preceding aircraft is maintaining a TAS of 74 km/h (40 kt) or more faster than the succeeding aircraft (see Figure 9)

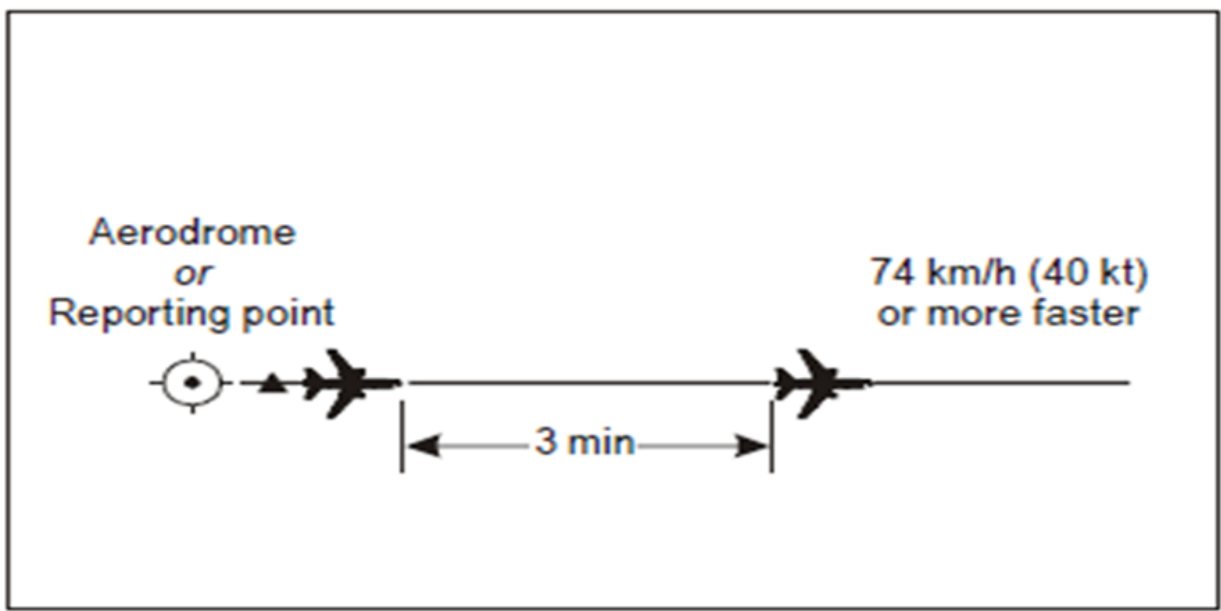

Figure 9: 3-minute separation between aircraft on the same track and same level

(b) Aircraft flying on crossing tracks

- (1) 15 minutes at the point of intersection of the tracks (see Figure 10); or

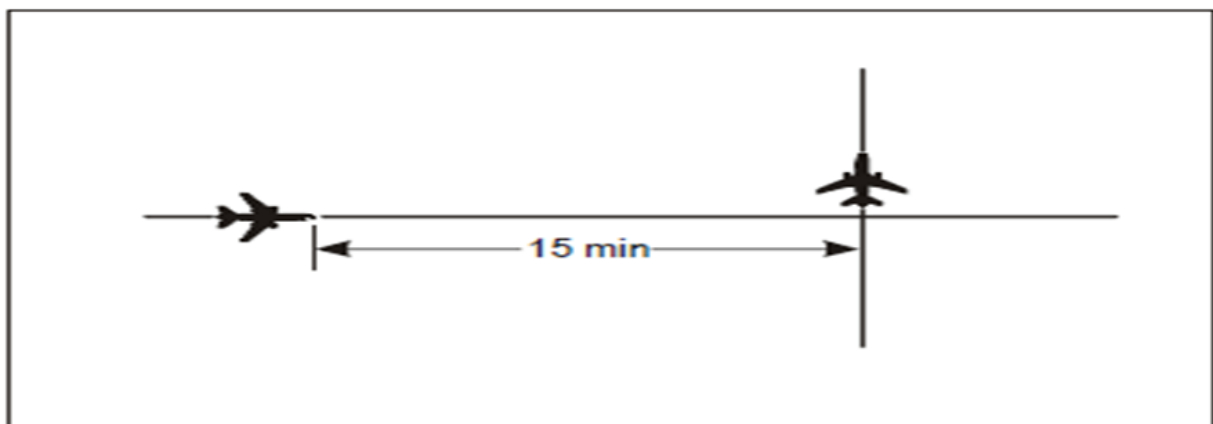

Figure 10: 15-minute separation between aircraft on crossing tracks and same level

- (2) 10 minutes if navigation aids permit frequent determination of position and speed (see Figure 11).

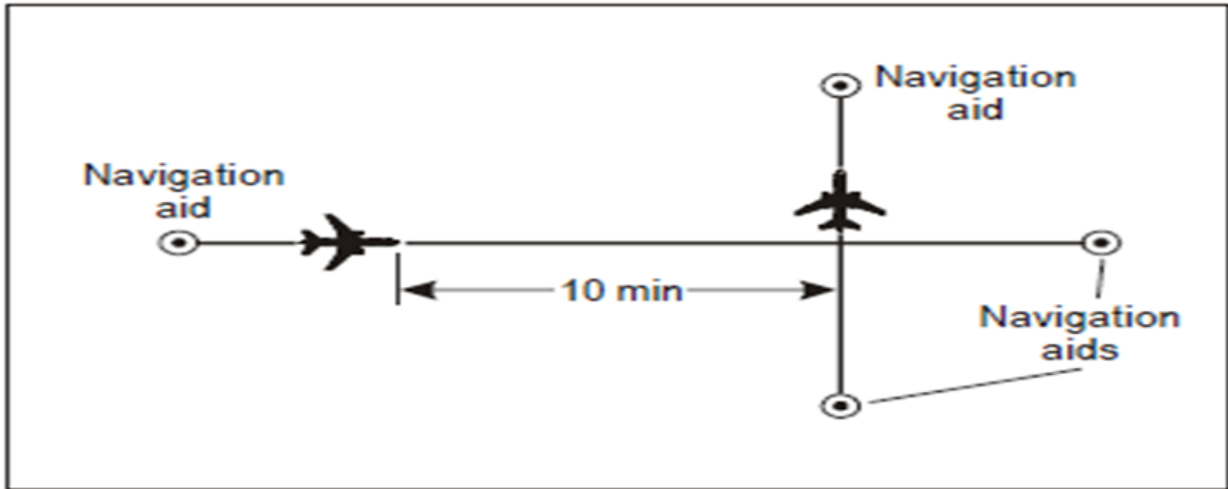

Figure 11: 10-minute separation between aircraft on crossing tracks and same level

AMC2 ATS.TR.210(c)(2)(i) Operation of air traffic control service PROCEDURAL SEPARATION — LONGITUDINAL SEPARATION MINIMA BASED ON TIME — AIRCRAFT CLIMBING OR DESCENDING

For aircraft climbing or descending, the longitudinal separation minima based on time should be one of the following:

(a) Aircraft on the same track

When an aircraft will pass through the level of another aircraft on the same track, the following minimum longitudinal separation should be provided:

- (1) 15 minutes while vertical separation does not exist (see Figures 12 and 13); or

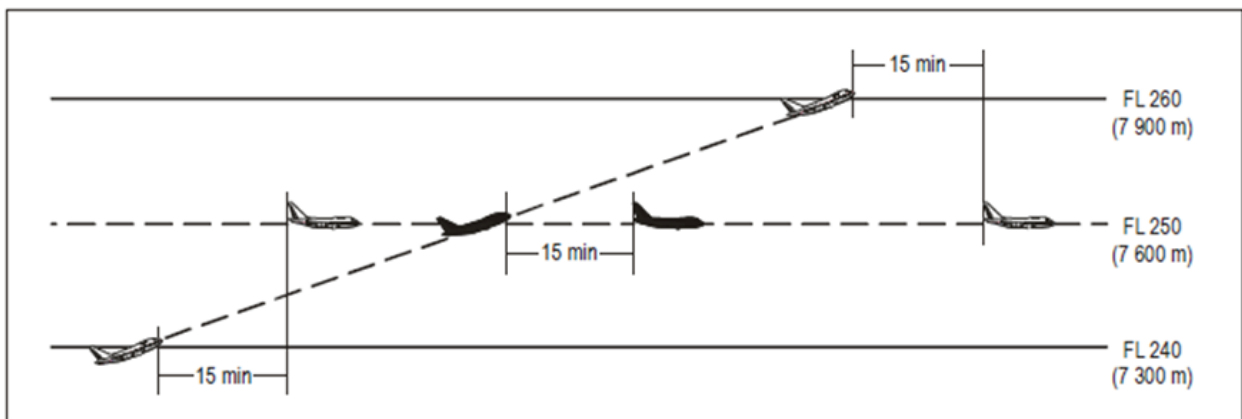

Figure 12: 15-minute separation between aircraft climbing and on the same track

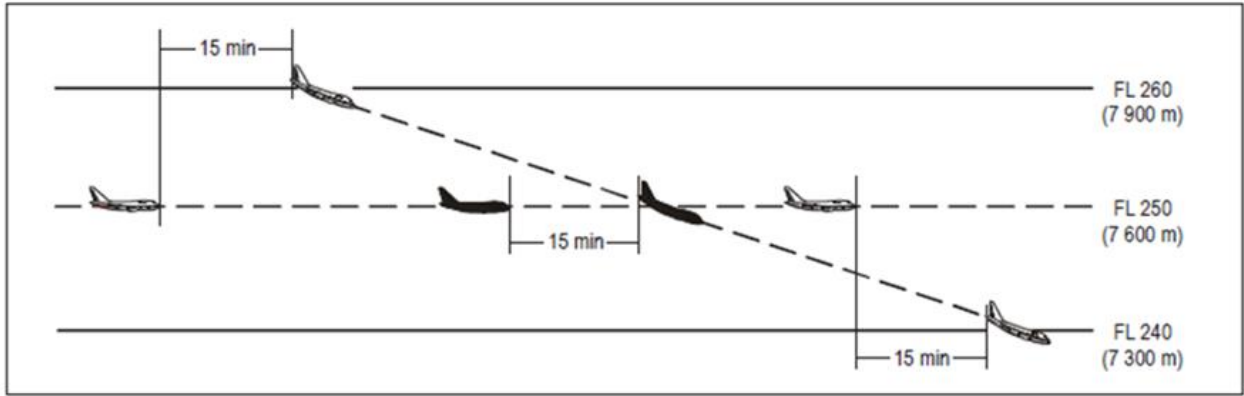

Figure 13: 15-minute separation between aircraft descending and on the same track

- (2) 10 minutes while vertical separation does not exist, provided that such separation is authorised only where ground-based navigation aids or GNSS permit frequent determination of position and speed (see Figures 14 and 15); or

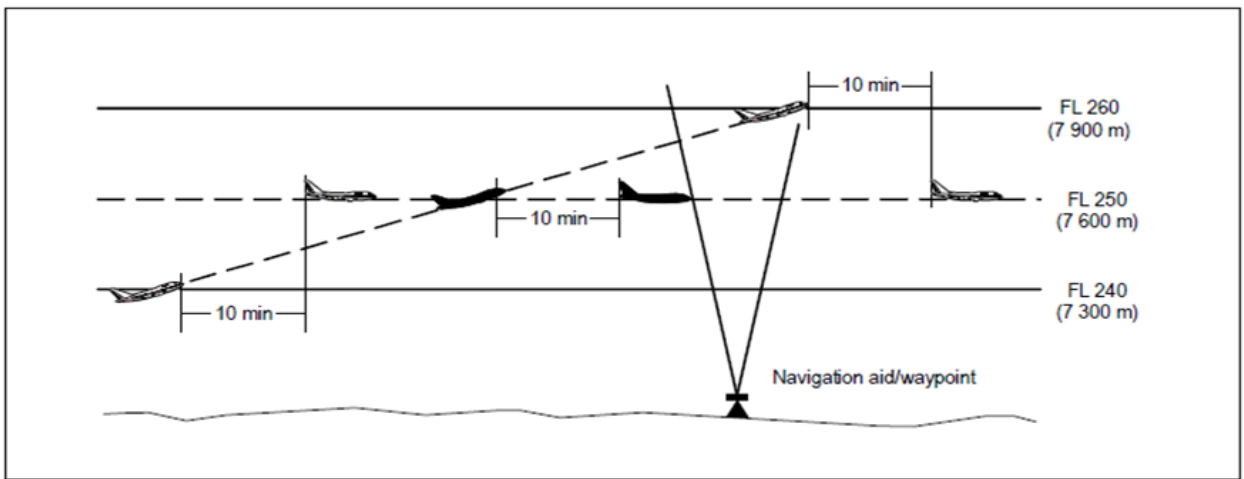

Figure 14: 10-minute separation between aircraft climbing and on the same track

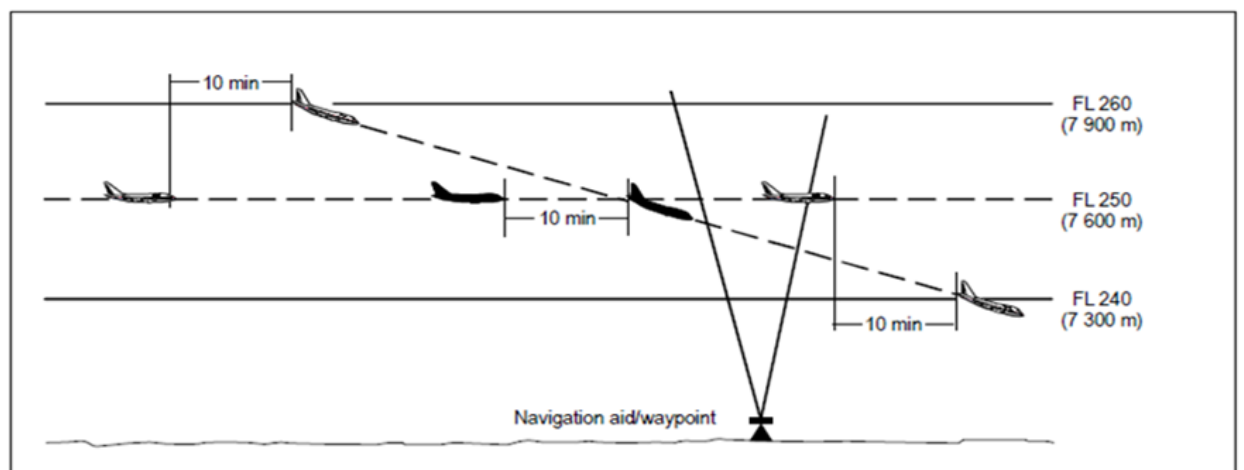

Figure 15: 10-minute separation between aircraft descending and on the same track

- (3) 5 minutes while vertical separation does not exist, provided that:

- (i) the level change is commenced within 10 minutes of the time the second aircraft has reported over a common point which should be derived from ground-based navigation aids or by GNSS; and
- (ii) when issuing the clearance through third-party communication or CPDLC, a restriction should be added to the clearance to ensure that the 10-minute condition is satisfied (see Figures 16 and 17).

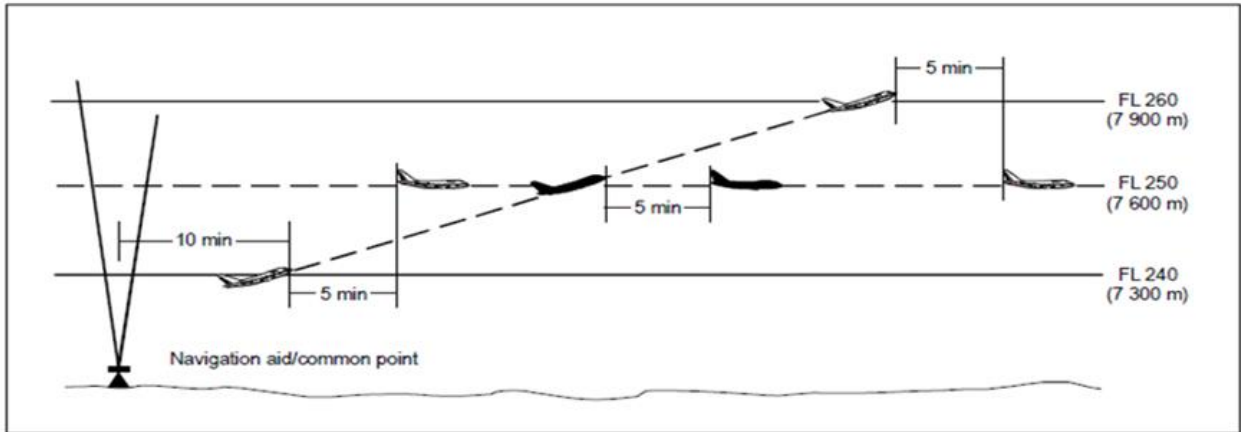

Figure 16: 5-minute separation between aircraft climbing and on the same track

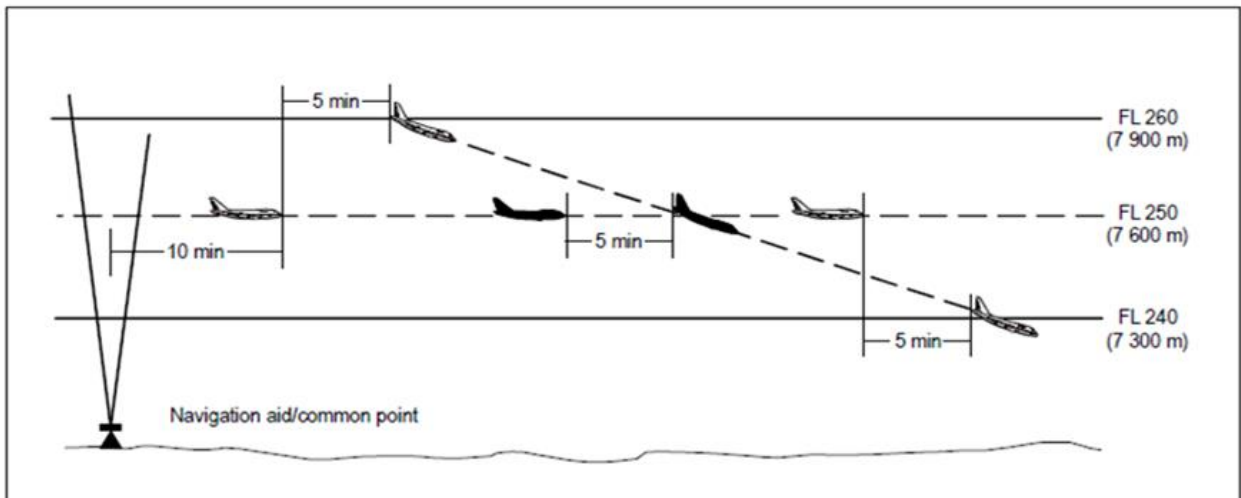

Figure 17: 5-minute separation between aircraft descending and on the same track

(b) Aircraft on crossing tracks

- (1) 15 minutes while vertical separation does not exist (see Figures 18 and 19); or

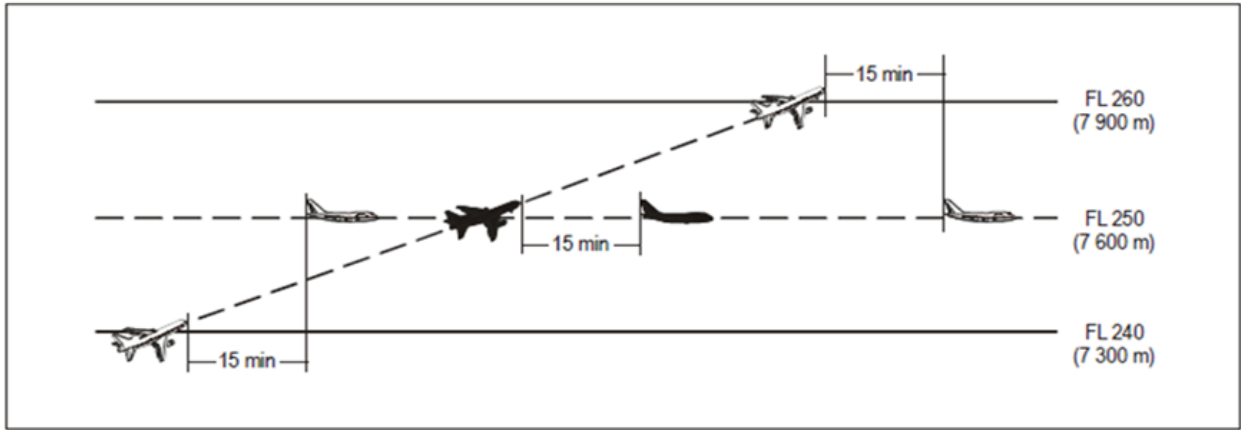

Figure 18: 15-minute separation between aircraft climbing and on crossing tracks

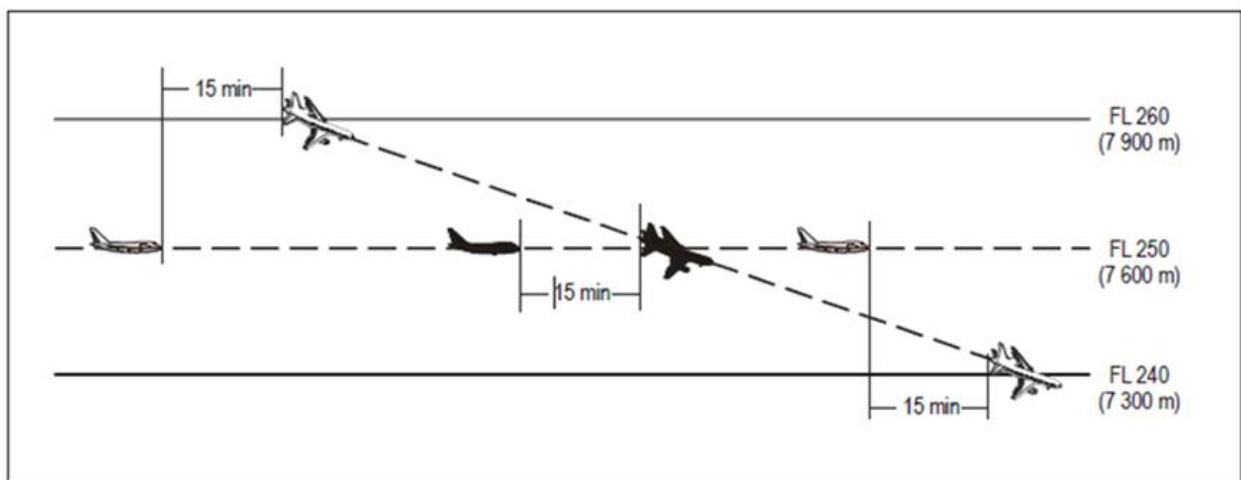

Figure 19: 15-minute separation between aircraft descending and on crossing tracks

- (2) 10 minutes while vertical separation does not exist if navigation aids permit frequent determination of position and speed (see Figures 20 and 21).

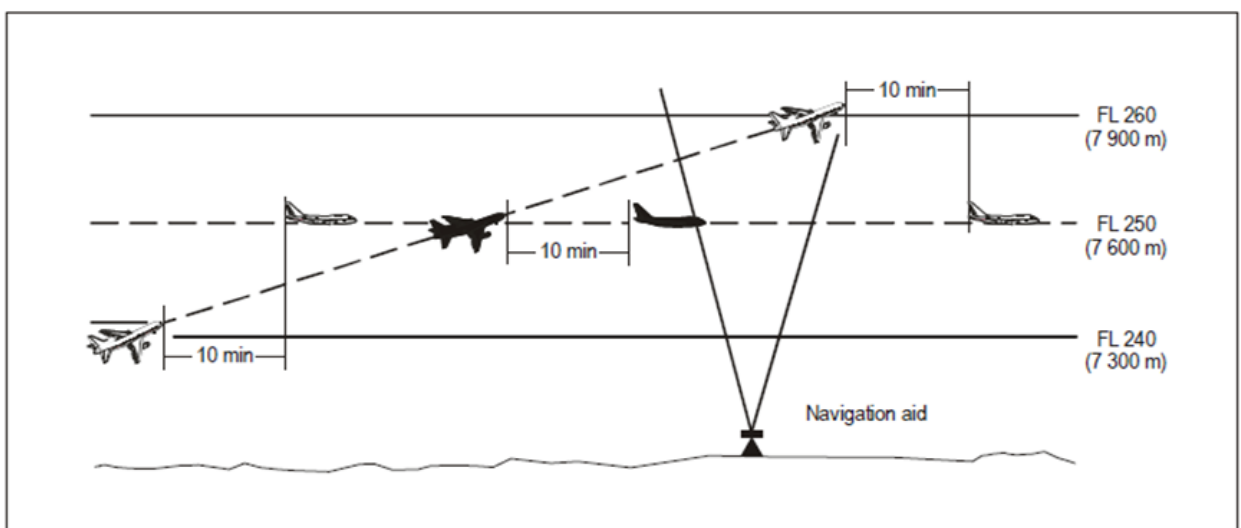

Figure 20: 10-minute separation between aircraft climbing and on crossing tracks

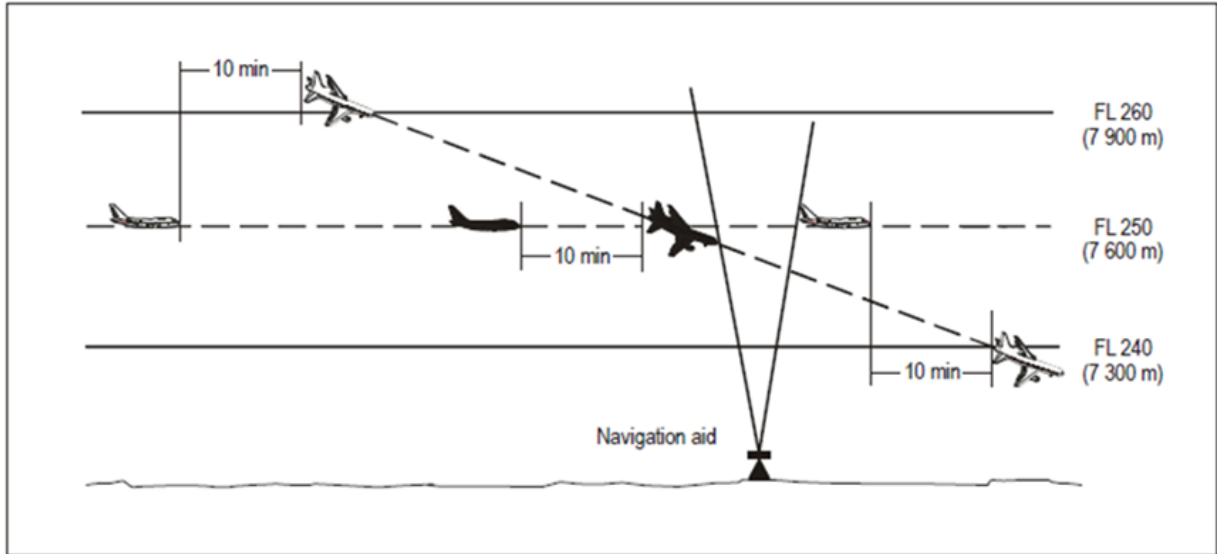

Figure 21: 10-minute separation between aircraft descending and on crossing tracks

(c) Aircraft on reciprocal tracks

Where lateral separation is not provided, vertical separation should be provided for at least 10 minutes prior to and after the time the aircraft are estimated to pass, or are estimated to have passed (see Figure 22). Provided it has been determined that the aircraft have passed each other, this minimum need not apply.

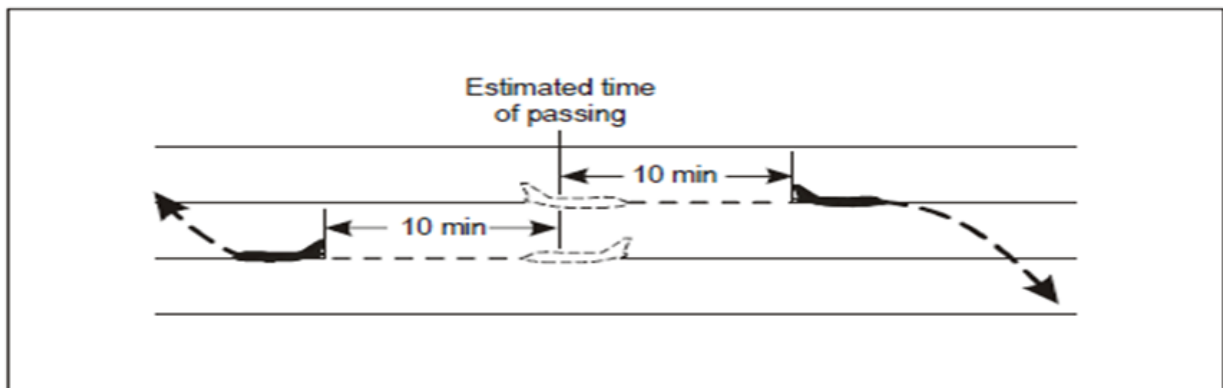

Figure 22: 10-minute separation between aircraft on reciprocal tracks

AMC3 ATS.TR.210(c)(2)(i) Operation of air traffic control service
PROCEDURAL SEPARATION — LONGITUDINAL SEPARATION MINIMA BASED ON DISTANCE USING DISTANCE MEASURING EQUIPMENT (DME) AND/OR GNSS — AIRCRAFT AT THE SAME CRUISING LEVEL

Longitudinal separation minima based on distance using distance measuring equipment (DME) and/or GNSS should be established between aircraft at the same cruising level, as follows:

(a) Aircraft on the same track

- (1) 37 km (20 NM), provided:
 - (i) each aircraft utilises:

- (A) the same 'on-track' DME station when both aircraft are utilising DME; or
 - (B) an 'on-track' DME station and a collocated waypoint when one aircraft is utilising DME and the other is utilising GNSS; or
 - (C) the same waypoint when both aircraft are utilising GNSS; and
- (ii) separation is checked by obtaining simultaneous DME and/or GNSS readings from the aircraft at frequent intervals to ensure that the minimum will not be infringed (see Figure 23);

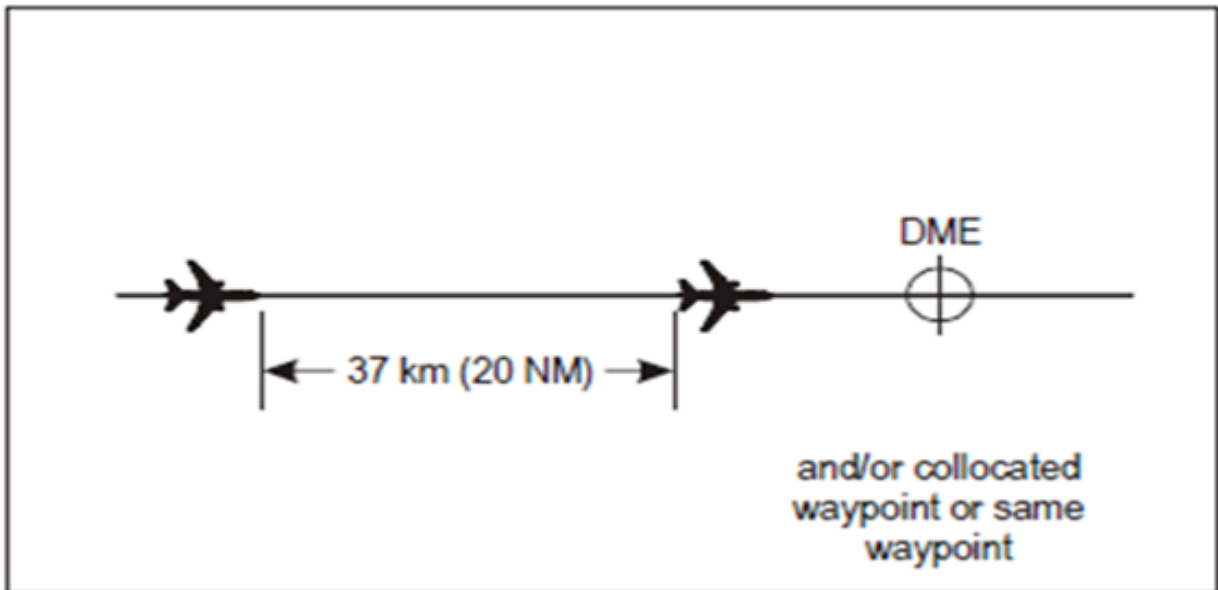

Figure 23: 37 km (20 NM) DME and/or GNSS-based separation between aircraft on the same track and same level

- (2) 19 km (10 NM), provided:
- (i) the leading aircraft maintains a TAS of 37 km/h (20 kt) or more faster than the succeeding aircraft;
 - (ii) each aircraft utilises:
 - (A) the same 'on-track' DME station when both aircraft are utilising DME; or
 - (B) an 'on-track' DME station and a collocated waypoint when one aircraft is utilising DME and the other is utilising GNSS; or
 - (C) the same waypoint when both aircraft are utilising GNSS; and
 - (iii) separation is checked by obtaining simultaneous DME and/or GNSS readings from the aircraft at such intervals as are necessary to ensure that the minimum is established and will not be infringed (see Figure 24).

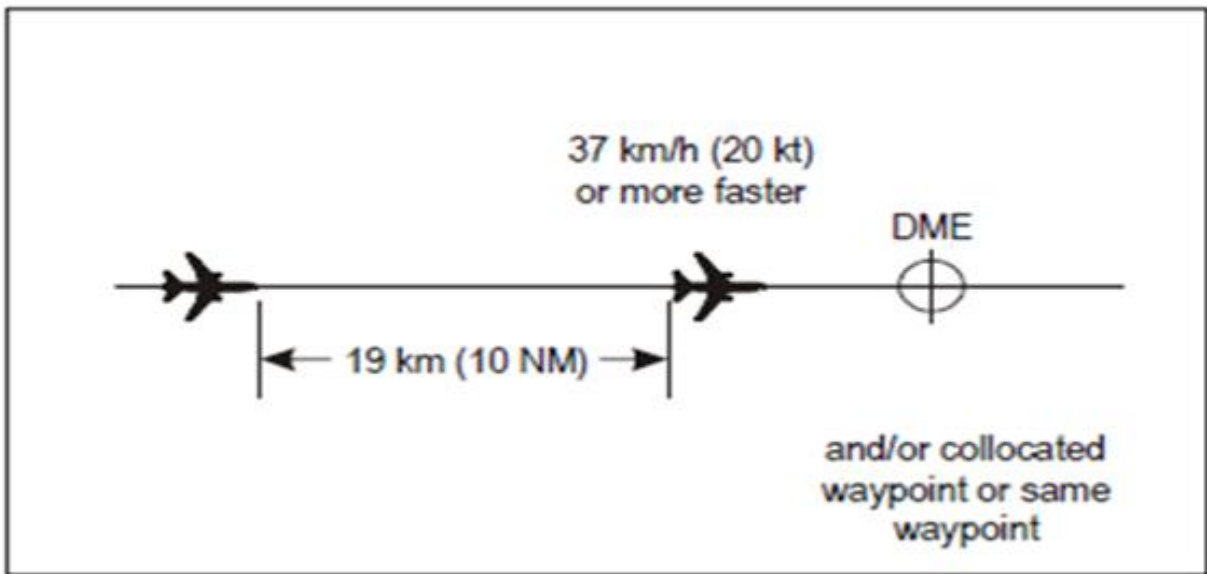

Figure 24: 19 km (10 NM) DME and/or GNSS-based separation between aircraft on the same track and same level

(b) Aircraft on crossing tracks

The longitudinal separation prescribed in point (a) should also apply, provided each aircraft reports distance from the DME station and/or collocated waypoint or same waypoint located at the crossing point of the tracks and that the relative angle between the tracks is less than 90 degrees (see Figures 25 and 26).

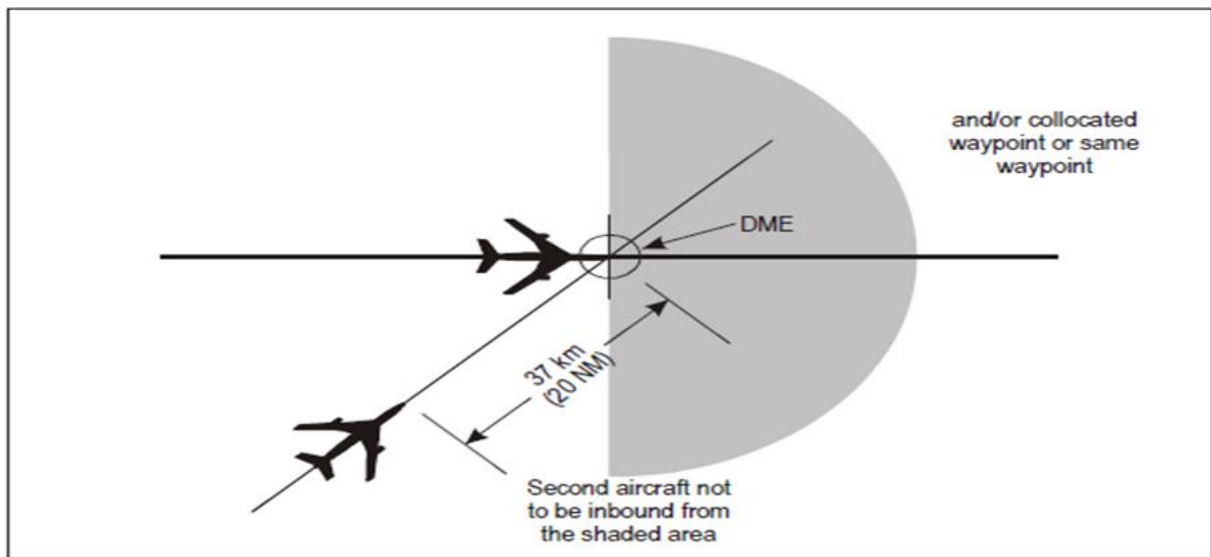

Figure 25: 37 km (20 NM) DME and/or GNSS-based separation between aircraft on crossing tracks and the same level

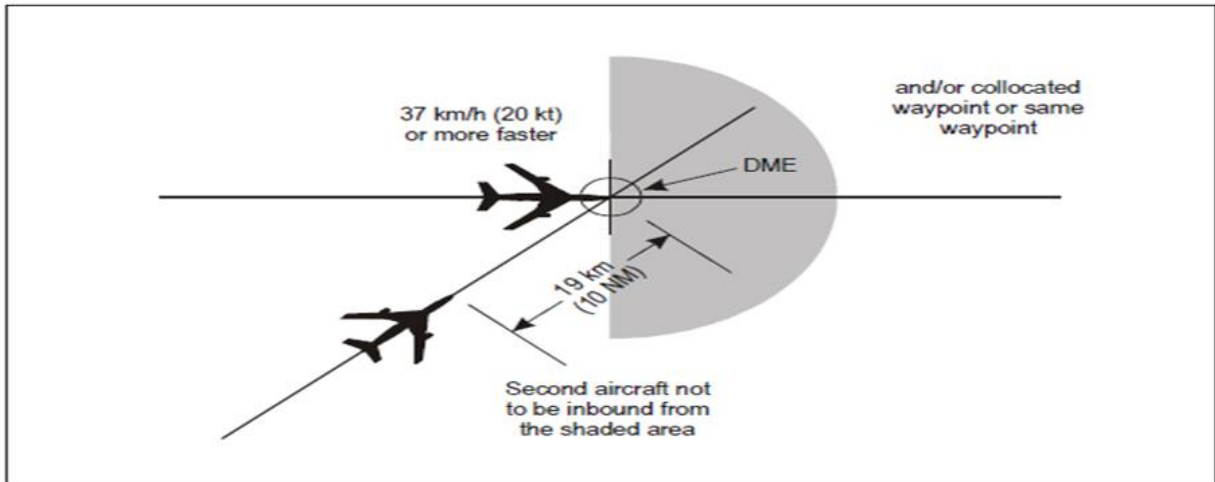

Figure 26: 19 km (10 NM) DME and/or GNSS-based separation between aircraft on crossing tracks and the same level

AMC4 ATS.TR.210(c)(2)(i) Operation of air traffic control service
PROCEDURAL SEPARATION — LONGITUDINAL SEPARATION MINIMA BASED ON DISTANCE USING DISTANCE MEASURING EQUIPMENT (DME) AND/OR GNSS — AIRCRAFT CLIMBING OR DESCENDING

Longitudinal separation minima based on distance using distance measuring equipment (DME) AND/OR GNSS should be established between aircraft climbing or descending, as follows:

(a) Aircraft on the same track

19 km (10 NM) while vertical separation does not exist, provided:

- (1) each aircraft utilises:
 - (i) the same 'on-track' DME station when both aircraft are utilising DME; or
 - (ii) an 'on-track' DME station and a collocated waypoint when one aircraft is utilising DME and the other is utilising GNSS; or
 - (iii) the same waypoint when both aircraft are utilising GNSS; and
- (2) one aircraft maintains a level while vertical separation does not exist; and
- (3) separation is established by obtaining simultaneous DME and/or GNSS readings from the aircraft (see Figures 27 and 28).

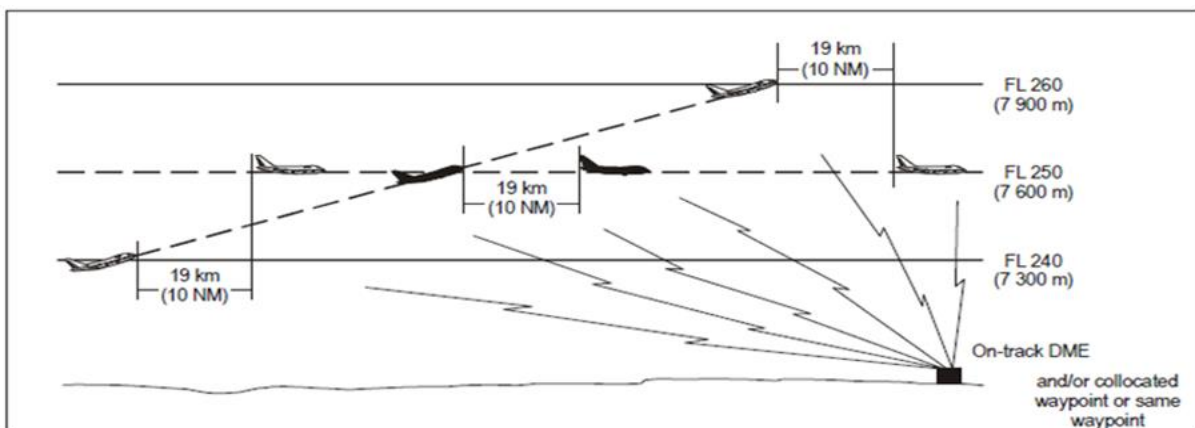

Figure 27: 19 km (10 NM) DME and/or GNSS-based separation between aircraft climbing and on the same track

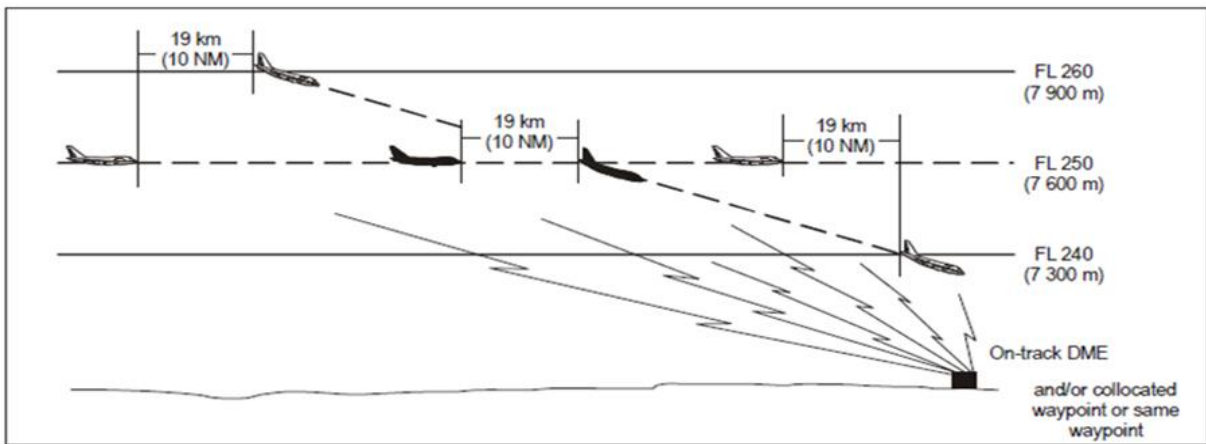

Figure 28: 19 km (10 NM) DME and/or GNSS-based separation between aircraft descending and on the same track

(b) Aircraft on reciprocal tracks

Aircraft utilising on-track DME and/or collocated waypoint or same waypoint may be cleared to climb or descend through the levels occupied by other aircraft utilising on-track DME and/or collocated waypoint or same waypoint, provided that it has been positively established that the aircraft have passed each other and are at least 10 NM apart, or such other value determined by the air traffic services provider and approved by the competent authority.

GM1 to AMC3 ATC.TR.210(c)(2)(i) and AMC4 ATC.TR.210(c)(2)(i) Operation of air traffic control service

PROCEDURAL SEPARATION — LONGITUDINAL SEPARATION MINIMA BASED ON DISTANCE USING DISTANCE MEASURING EQUIPMENT (DME) AND/OR GNSS — APPLICATION

- (a) Where the term 'on track' is used in the provisions relating to the application of longitudinal separation minima using DME and/or GNSS, it means that the aircraft is flying either directly inbound to or directly outbound from the station/waypoint.
- (b) Separation should be established by maintaining not less than the specified distance(s) between aircraft positions as reported by reference to DME in conjunction with other appropriate navigation aids and/or GNSS. This type of separation should be applied between two aircraft using DME, or two aircraft using GNSS, or one aircraft using DME and one aircraft using GNSS. Direct controller-pilot VHF voice communication should be maintained while such separation is used.
- (c) For the purpose of applying GNSS-based separation minimum, a distance derived from an integrated navigation system incorporating GNSS input is regarded as equivalent to GNSS distance.
- (d) When applying these separation minima between any aircraft with area navigation capability, air traffic controllers should specifically request GNSS-derived distance.

**AMC5 ATS.TR.210(c)(2)(i) Operation of air traffic control service
PROCEDURAL SEPARATION — LONGITUDINAL SEPARATION MINIMA WITH MACH NUMBER
TECHNIQUE BASED ON TIME**

When the Mach number technique is applied and provided that:

- (a) the aircraft concerned have reported over the same common point and follow the same track or continuously diverging tracks until some other form of separation is provided; or
- (b) if the aircraft have not reported over the same common point and it is possible to ensure, by radar, ADS-B or other means, that the appropriate time interval will exist at the common point from which they either follow the same track or continuously diverging tracks,

minimum longitudinal separation between turbojet aircraft on the same track, whether in level, climbing or descending flight should be:

- (1) 10 minutes. In this case, the preceding aircraft should maintain a true Mach number equal to or greater than that maintained by the following aircraft; or
- (2) between 9 and 5 minutes inclusive, provided that the preceding aircraft is maintaining a true Mach number greater than the following aircraft in accordance with the following:
 - (i) 9 minutes if the preceding aircraft is Mach 0.02 faster than the following aircraft;
 - (ii) 8 minutes if the preceding aircraft is Mach 0.03 faster than the following aircraft;
 - (iii) 7 minutes if the preceding aircraft is Mach 0.04 faster than the following aircraft;
 - (iv) 6 minutes if the preceding aircraft is Mach 0.05 faster than the following aircraft;
 - (v) 5 minutes if the preceding aircraft is Mach 0.06 faster than the following aircraft.

**AMC6 ATS.TR.210(c)(2)(i) Operation of air traffic control service
PROCEDURAL SEPARATION — LONGITUDINAL SEPARATION MINIMA WITH MACH NUMBER
TECHNIQUE BASED ON DISTANCE USING RNAV**

- (a) The air traffic controller should not apply RNAV distance-based separation minima after having received pilot advice indicating navigation equipment deterioration or failure.
- (b) A 150 km (80 NM) RNAV distance-based separation minimum with Mach number technique may be used on same-direction tracks in lieu of a 10-minute longitudinal separation minimum with Mach number technique, provided that:
 - (1) each aircraft reports its distance to or from the same 'on-track' common point;
 - (2) separation between aircraft at the same level is checked by obtaining simultaneous RNAV distance readings from the aircraft at frequent intervals to ensure that the minimum will not be infringed (see Figure 29);

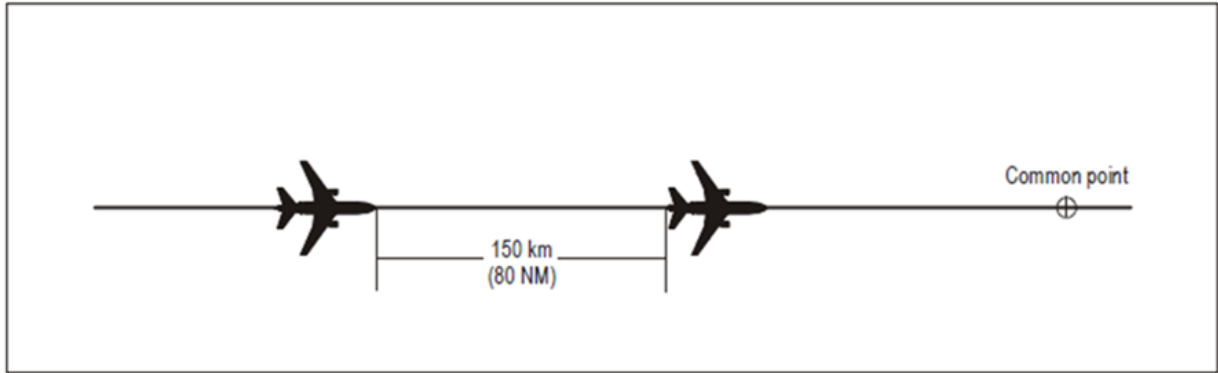

Figure 29: 150 km (80 NM) RNAV-based separation between aircraft at the same level

(3) separation between aircraft climbing or descending is established by obtaining simultaneous RNAV distance readings from the aircraft (see Figures 30 and 31); and

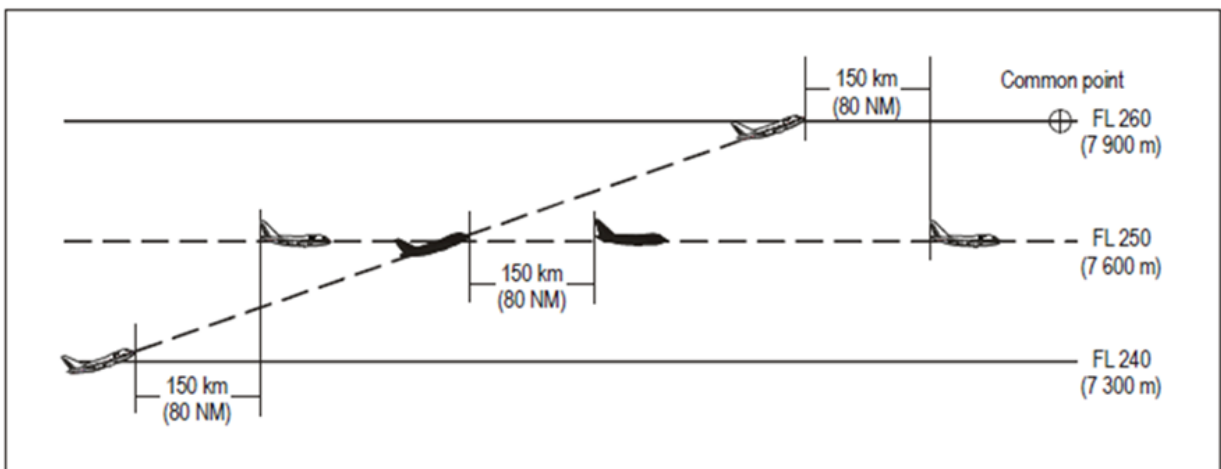

Figure 30: 150 km (80 NM) RNAV-based separation between aircraft climbing and on the same track

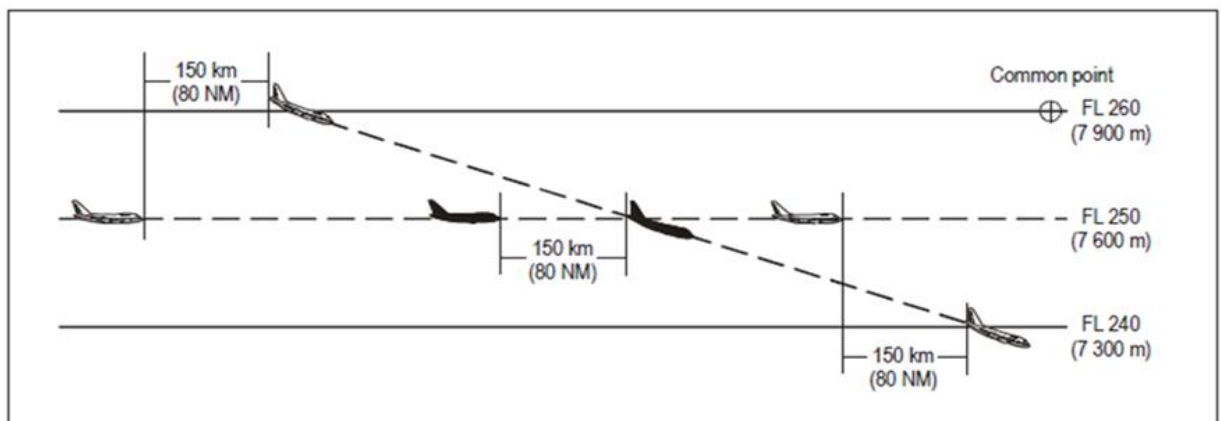

Figure 31: 150 km (80 NM) RNAV-based separation between aircraft descending and on the same track

(4) in the case of aircraft climbing or descending, one aircraft maintains a level while vertical separation does not exist.

(c) Aircraft on reciprocal tracks

Aircraft utilising RNAV may be cleared to climb or descend to or through the levels occupied by other aircraft utilising RNAV, provided it has been positively established by simultaneous RNAV distance readings to or from the same 'on-track' common point that the aircraft have passed each other and are at least 150 km (80 NM) apart (see Figure 32).

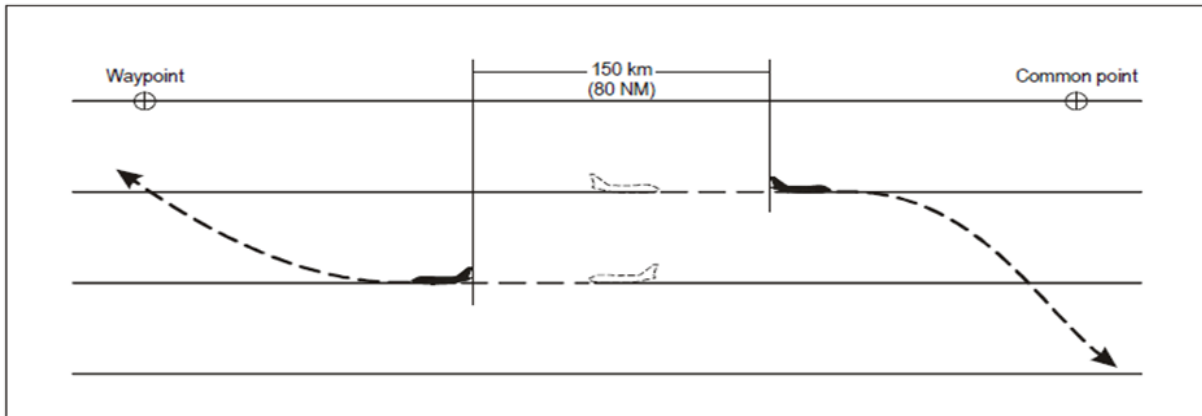

Figure 32: 150 km (80 NM) RNAV-based separation between aircraft on reciprocal tracks

GM1 to AMC5 ATS.TR.210(c)(2)(i) and AMC6 ATS.TR.210(c)(2)(i) Operation of air traffic control service PROCEDURAL SEPARATION — LONGITUDINAL SEPARATION MINIMA WITH MACH NUMBER TECHNIQUE

Guidance on the application of the Mach number technique for separation of subsonic aircraft is available in ICAO Doc 9426 'Air Traffic Services Planning Manual'.

GM1 to AMC6 ATS.TR.210(c)(2)(i) Operation of air traffic control service LONGITUDINAL SEPARATION MINIMA WITH MACH NUMBER TECHNIQUE BASED ON DISTANCE USING RNAV — APPLICATION

- (a) Separation should be established by maintaining not less than the specified distance between aircraft positions as reported by reference to RNAV equipment. Direct controller-pilot communications should be maintained, while such separation is used. Where high-frequency or general-purpose extended-range VHF air-ground communication channels are used for area control service and are worked by air-ground communicators, suitable arrangements should be made to permit direct controller-pilot communications, or monitoring by the air traffic controller of all air-ground communications.
- (b) To assist pilots to readily provide the required RNAV distance information, such position reports should, wherever possible, be referenced to a common waypoint ahead of both aircraft.
- (c) RNAV distance-based separation may be applied between RNAV-equipped aircraft when operating on designated RNAV routes or on ATS routes defined by VOR.

- (d) To facilitate application of the procedure where a considerable change of level is involved, a descending aircraft may be cleared to some convenient level above the lower aircraft, or a climbing aircraft to some convenient level below the higher aircraft, to permit a further check on the separation that will be obtained while vertical separation does not exist.

AMC7 ATS.TR.210(c)(2)(i) Operation of air traffic control service
RUNWAY SEPARATION MINIMA BETWEEN DEPARTING AIRCRAFT AND OTHER AIRCRAFT USING THE SAME RUNWAY

Except as provided in AMC9 ATS.TR.210(c)(2)(i) as regards reduced runway separation minima between aircraft using the same runway, and in ATS.TR.220 as regards time-based wake turbulence separation minima, the aerodrome control tower should not permit a departing aircraft to commence take-off until:

- (a) the preceding departing aircraft has crossed the end of the runway-in-use; or
- (b) the preceding departing aircraft has started a turn; or
- (c) all preceding landing aircraft are clear of the runway-in-use (see Figure 33).

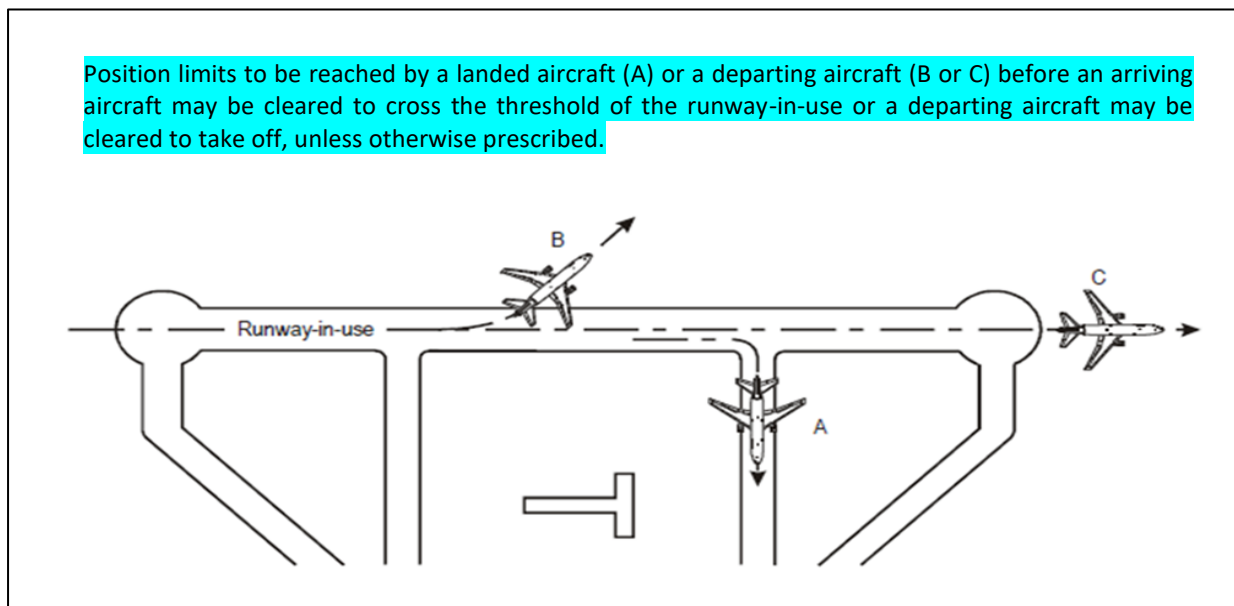

Figure 33: Separation between departing and arriving aircraft

AMC8 ATS.TR.210(c)(2)(i) Operation of air traffic control service RUNWAY SEPARATION OF LANDING AIRCRAFT AND PRECEDING LANDING AND DEPARTING AIRCRAFT USING THE SAME RUNWAY

Except as provided AMC9 ATS.TR.210(c)(2)(i) as regards reduced runway separation minima between aircraft using the same runway, and in ATS.TR.220 as regards time-based wake turbulence separation minima, the aerodrome control tower should not permit a landing aircraft to cross the runway threshold on its final approach until:

- (a) the preceding departing aircraft has crossed the end of the runway-in-use; or
- (b) the preceding departing aircraft has started a turn; or
- (c) all preceding landing aircraft are clear of the runway-in-use (see Figure 33).

AMC9 ATS.TR.210(c)(2)(i) Operation of air traffic control service REDUCED RUNWAY SEPARATION MINIMA BETWEEN AIRCRAFT USING THE SAME RUNWAY

- (a) The air traffic services provider may prescribe lower minima than those established in AMC7 ATS.TR.210(c)(2)(i) concerning separation of departing aircraft, and in AMC8 ATS.TR.210(c)(2)(i) concerning separation of landing aircraft and preceding landing and departing aircraft using the same runway, after consultation with the operators. The safety assessment to be performed in support of the application of reduced separation minima should be carried out for each runway for which the reduced minima are intended, taking into account factors such as:
 - (1) runway length;
 - (2) aerodrome layout; and
 - (3) types/categories of aircraft involved.
- (b) Reduced runway separation minima should only be applied during the hours of daylight from 30 minutes after local sunrise to 30 minutes before local sunset.
- (c) For the purpose of reduced runway separation, aircraft should be classified as follows:
 - (1) Category 1 aircraft: single-engine propeller aircraft with a maximum certificated take-off mass (MCTOM) of 2 000 kg or less;
 - (2) Category 2 aircraft: single-engine propeller aircraft with a maximum certificated take-off mass of more than 2 000 kg but less than 7 000 kg; and twin-engine propeller aircraft with a maximum certificated take-off mass of less than 7 000 kg; and
 - (3) Category 3 aircraft: all other aircraft.
- (d) Reduced runway separation minima should not apply between a departing aircraft and a preceding landing aircraft.
- (e) Reduced runway separation minima should be subject to the following conditions:
 - (1) wake turbulence separation minima should be applied;
 - (2) visibility should be at least 5 km and ceiling shall not be lower than 300 m (1 000 ft);

- (3) tailwind component should not exceed 5 kt;
 - (4) there should be available means, such as suitable landmarks, to assist the air traffic controller in assessing the distances between aircraft. A surface movement ATIS surveillance system that provides the air traffic controller with position information on aircraft may be utilised, provided that approval for operational use of such equipment includes a safety assessment to ensure that all requisite operational and performance requirements are met;
 - (5) minimum separation continues to exist between two departing aircraft immediately after take-off of the second aircraft;
 - (6) traffic information should be provided to the flight crew of the succeeding aircraft concerned; and
 - (7) the braking action should not be adversely affected by runway contaminants such as ice, slush, snow and water.
- (f) Reduced runway separation minima which may be applied at an aerodrome should be determined for each separate runway. The separation to be applied should in no case be less than the following minima:
- (1) landing aircraft:
 - (i) a succeeding landing Category 1 aircraft may cross the runway threshold when the preceding aircraft is a Category 1 or 2 aircraft which either:
 - (A) has landed and has passed a point at least 600 m from the threshold of the runway, is in motion and will vacate the runway without backtracking; or
 - (B) is airborne and has passed a point at least 600 m from the threshold of the runway;
 - (ii) a succeeding landing Category 2 aircraft may cross the runway threshold when the preceding aircraft is a Category 1 or 2 aircraft which either:
 - (A) has landed and has passed a point at least 1 500 m from the threshold of the runway, is in motion and will vacate the runway without backtracking; or
 - (B) is airborne and has passed a point at least 1 500 m from the threshold of the runway;
 - (iii) a succeeding landing aircraft may cross the runway threshold when a preceding Category 3 aircraft:
 - (A) has landed and has passed a point at least 2 400 m from the threshold of the runway, is in motion and will vacate the runway without backtracking; or
 - (B) is airborne and has passed a point at least 2 400 m from the threshold of the runway;
 - (2) departing aircraft:

- (i) a Category 1 aircraft may be cleared for take-off when the preceding departing aircraft is a Category 1 or 2 aircraft which is airborne and has passed a point at least 600 m from the position of the succeeding aircraft;
- (ii) a Category 2 aircraft may be cleared for take-off when the preceding departing aircraft is a Category 1 or 2 aircraft which is airborne and has passed a point at least 1 500 m from the position of the succeeding aircraft; and
- (iii) an aircraft may be cleared for take-off when a preceding departing Category 3 aircraft is airborne and has passed a point at least 2 400 m from the position of the succeeding aircraft.

AMC10 ATS.TR.210(c)(2)(i) Operation of air traffic control service PROCEDURAL CONTROL — MINIMUM SEPARATION BETWEEN DEPARTING AIRCRAFT

(a) The aerodrome air traffic controller should apply a 1-minute separation if aircraft are to fly on tracks diverging by at least 45 degrees immediately after take-off so that lateral separation is provided (see Figure 34).

(b) When:

- (1) aircraft are using parallel runways; or
- (2) in a context of operations on diverging runways which do not cross, the pilot has accepted a take-off direction which is not into the wind, in accordance with the procedure described in point (b) of GM1 ATS.TR.260,

this minimum may be reduced, provided instructions covering the procedure have been established by the air traffic services provider and approved by the competent authority and lateral separation is effected immediately after take-off.

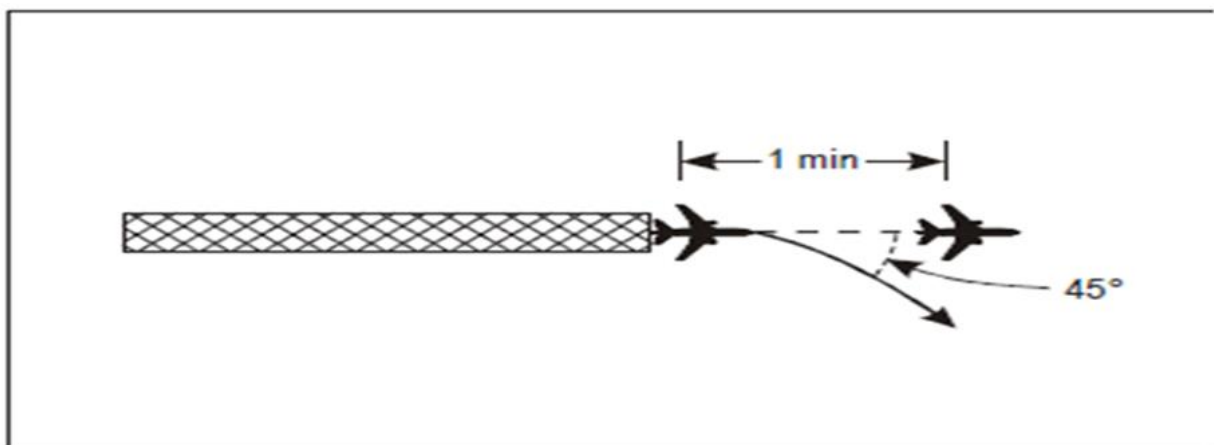

Figure 34: 1-minute separation between departing aircraft following tracks diverging by at least 45 degrees

(c) The air traffic controller should apply a 2-minute separation between take-offs when the preceding aircraft is 74 km/h (40 kt) or more faster than the succeeding aircraft and both aircraft will follow the same track (see Figure 35).

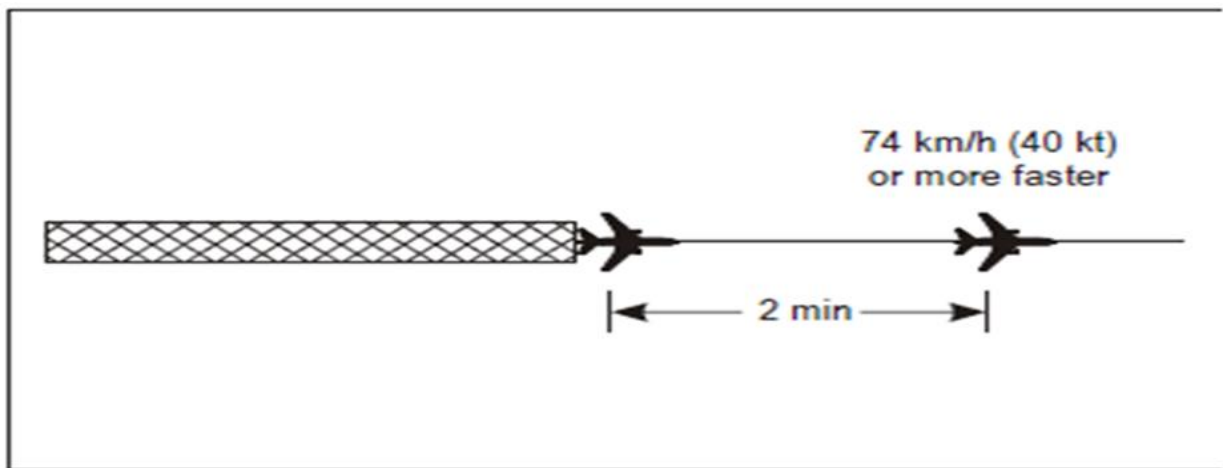

Figure 35: 2-minute separation between aircraft following the same track

- (d) The air traffic controller should apply a 5-minute separation while vertical separation does not exist if a departing aircraft will be flown through the level of a preceding departing aircraft and both aircraft propose to follow the same track (see Figure 36). The air traffic controller should take action to ensure that the 5-minute separation will be maintained or increased while vertical separation does not exist.

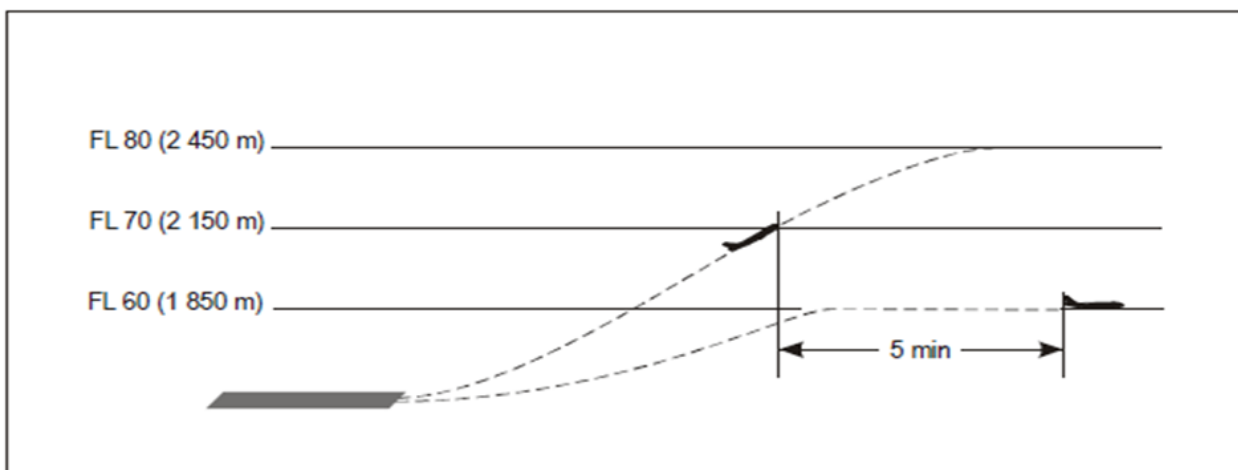

Figure 36: 5-minute separation of departing aircraft following the same track

AMC11 ATS.TR.210(c)(2)(i) Operation of air traffic control service PROCEDURAL CONTROL — SEPARATION OF DEPARTING AIRCRAFT FROM ARRIVING AIRCRAFT

The following separation should be applied when take-off clearance is based on the position of an arriving aircraft:

- (a) If an arriving aircraft is making a complete instrument approach, a departing aircraft may take off:
- (1) in any direction until an arriving aircraft has started its procedure turn or base turn leading to final approach;
 - (2) in a direction which is different by at least 45 degrees from the reciprocal of the direction of approach after the arriving aircraft has started procedure turn or base turn leading to

final approach, provided that the take-off will be made at least 3 minutes before the arriving aircraft is estimated to be over the beginning of the instrument runway (see Figure 37).

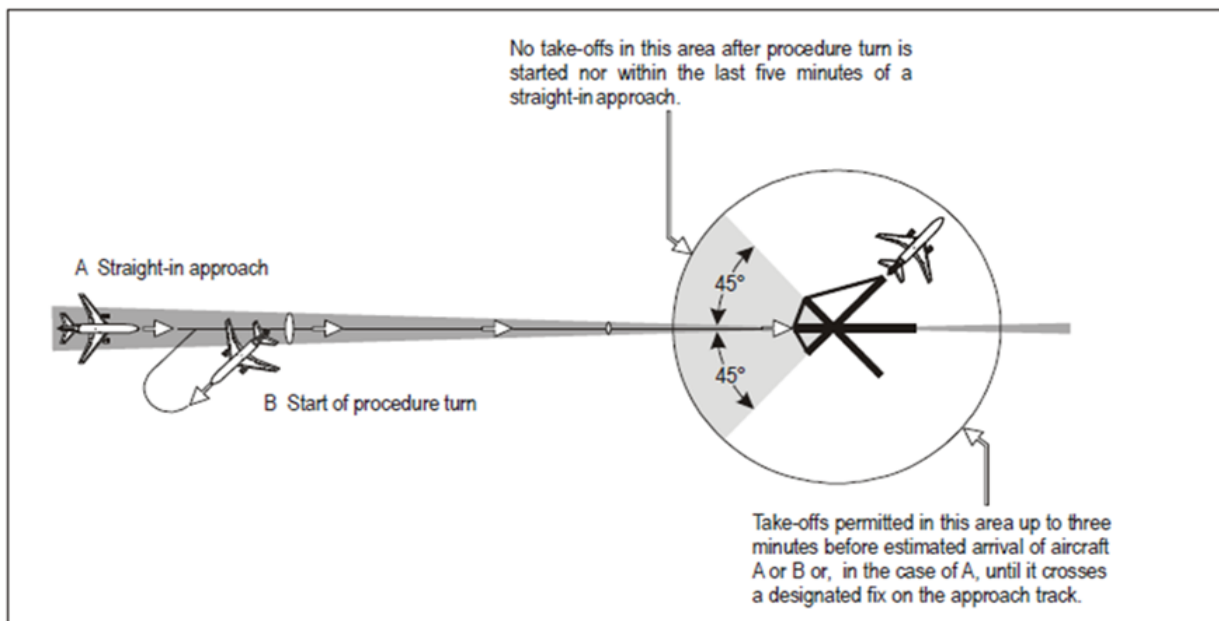

Figure 37: Separation of departing aircraft from arriving aircraft

- (b) If an arriving aircraft is making a straight-in approach, a departing aircraft may take off:
- (1) in any direction until 5 minutes before the arriving aircraft is estimated to be over the instrument runway;
 - (2) in a direction which is different by at least 45 degrees from the reciprocal of the direction of approach of the arriving aircraft:
 - (i) until 3 minutes before the arriving aircraft is estimated to be over the beginning of the instrument runway (see Figure 37); or
 - (ii) before the arriving aircraft crosses a designated fix on the approach track; the location of such fix should be determined by the air traffic services provider after consultation with the operators, and approved by the competent authority.

AMC1 ATS.TR.210(c)(2)(ii) Operation of air traffic control service PROCEDURAL CONTROL — LATERAL SEPARATION CRITERIA AND MINIMA

Lateral separation should be applied by one of the following means:

(a) By reference to the same or different geographic locations

By position reports which positively indicate that the aircraft are over different geographic locations as determined visually or by reference to a navigation aid (see Figure 38).

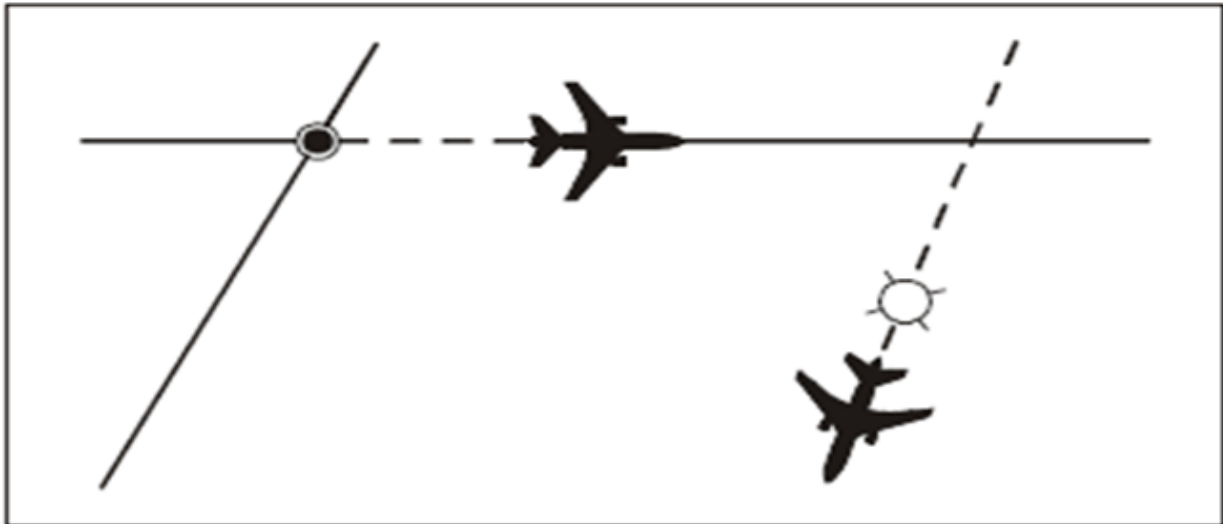

Figure 38: Using same or different geographic locations

(b) By use of NDB, VOR or GNSS on intersecting tracks or ATS routes

By requiring aircraft to fly on specified tracks which are separated by a minimum amount appropriate to the navigation aid employed. Lateral separation between two aircraft exists when:

- (1) **(VOR)** both aircraft are established on radials diverging by at least 15 degrees and at least one aircraft is at a distance of 28 km (15 NM) or more from the facility (see Figure 39);

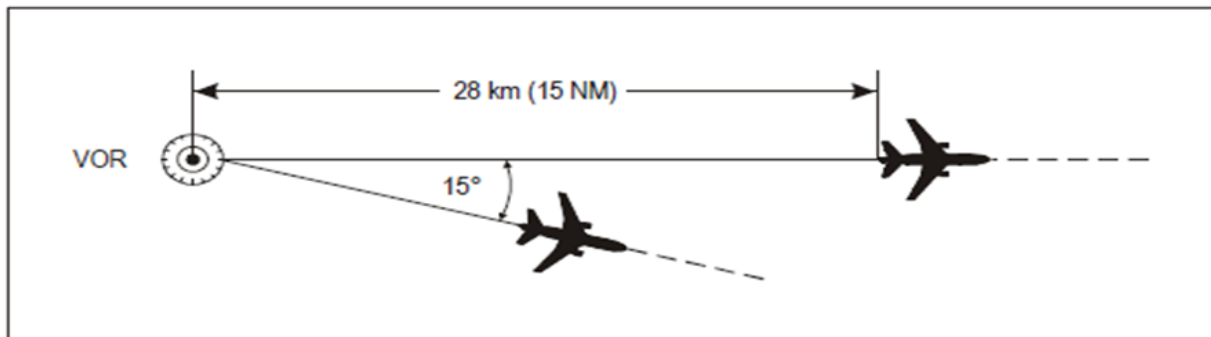

Figure 39: Separation using the same VOR

- (2) **(NDB)** both aircraft are established on tracks to or from the NDB which are diverging by at least 30 degrees and at least one aircraft is at a distance of 28 km (15 NM) or more from the facility (see Figure 40);

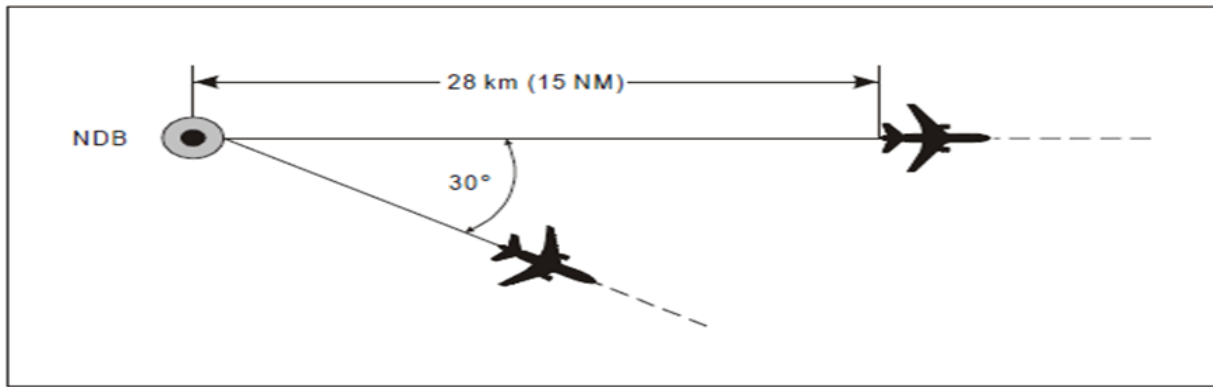

Figure 40: Separation using the same NDB

- (3) (GNSS/GNSS) each aircraft is confirmed to be established on a track with zero offset between two waypoints and at least one aircraft is at a minimum distance from a common point as specified in Table 1 below; or
- (4) (VOR/GNSS) the aircraft using VOR is established on a radial to or from the VOR and the other aircraft using GNSS is confirmed to be established on a track with zero offset between two waypoints and at least one aircraft is at a minimum distance from a common point as specified in the table below.

Angular difference between tracks measured at the common point (degrees)	Aircraft 1: VOR or GNSS Aircraft 2: GNSS	
	FL010-FL090 Distance from a common point	FL200-FL600 Distance from a common point
15-135	27.8 km (15 NM)	43 km (23 NM)

The distances in the table are ground distances. States must take into account the distance (slant range) from the source of a DME signal to the receiving antenna when DME is being utilised to provide range information.

(c) By use of different navigation aids or methods

Lateral separation between aircraft using different navigation aids, or when one aircraft is using RNAV equipment, should be established by ensuring that the derived protected airspaces for the navigation aid(s) or RNP do not overlap.

(d) Lateral separation of aircraft on published instrument flight procedures for arrivals and departures

Lateral separation of departing and/or arriving aircraft, using instrument flight procedures, will exist where:

- (1) the distance between any combination of RNAV 1 with RNAV 1, or RNP 1, RNP APCH or RNP AR APCH tracks is not less than 13 km (7 NM); or
- (2) the distance between any combination of RNP 1, RNP APCH or RNP AR APCH tracks is not less than 9.3 km (5 NM); or

- (3) the protected areas of tracks designed using obstacle clearance criteria do not overlap and provided operational error is considered.

(e) RNAV operations where RNP is specified on parallel tracks or ATS routes

Within designated airspace or on designated routes, where RNP is specified, lateral separation between RNAV-equipped aircraft may be obtained by requiring aircraft to be established on the centre lines of parallel tracks or ATS routes spaced at a distance which ensures that the protected airspace of the tracks or ATS routes does not overlap.

(f) Transitioning into airspace where a greater lateral separation minimum applies

Lateral separation will exist when aircraft are established on specified tracks which:

- (1) are separated by an appropriate minimum; and
- (2) diverge by at least 15 degrees until the applicable lateral separation minimum is established,

provided that it is possible to ensure, by means approved by the competent authority, that aircraft have the navigation capability necessary to ensure accurate track guidance.

GM1 to AMC1 ATS.TR.210(c)(2)(ii) Operation of air traffic control service

PROCEDURAL CONTROL — LATERAL SEPARATION OF AIRCRAFT ON PUBLISHED INSTRUMENT FLIGHT PROCEDURES FOR ARRIVALS AND DEPARTURES

ICAO Circular 324 'Guidelines for Lateral Separation of Arriving and Departing Aircraft on Published Adjacent Instrument Flight Procedures' contains information on separation of arrival and departure tracks using non-overlapping protected areas based on obstacle clearance criteria, as provided for in ICAO Doc 8168 'Procedures for Air Navigation Services — Aircraft Operations, Volume II — Construction of Visual and Instrument Flight Procedures'.

GM1 ATS.TR.210(c)(2)(ii) Operation of air traffic control service

PROCEDURAL CONTROL — LATERAL SEPARATION APPLICATION

- (a) Lateral separation should be applied so that the distance between those portions of the intended routes for which the aircraft are to be laterally separated is never less than an established distance to account for navigational inaccuracies plus a specified buffer. This buffer should be determined by the air traffic services provider and approved by the competent authority and included in the lateral separation minima as an integral part thereof.
- (b) Lateral separation of aircraft is obtained by requiring operation on different routes or in different geographical locations as determined by visual observation, by the use of navigation aids or by the use of RNAV equipment.
- (c) Where a route flown by an aircraft involves a specified turn which will result in the minimum lateral separation being infringed, another type of separation or another minimum shall be established prior to the aircraft commencing the turn (see Figures 41 and 42).

- (d) For flyover waypoints, aircraft are required to first fly over the waypoint before executing the turn. After the turn, the aircraft may either navigate to join the route immediately after the turn or navigate to the next defined waypoint before rejoining the route. This will require additional lateral separation on the overflow side of the turn (See Figure 41).

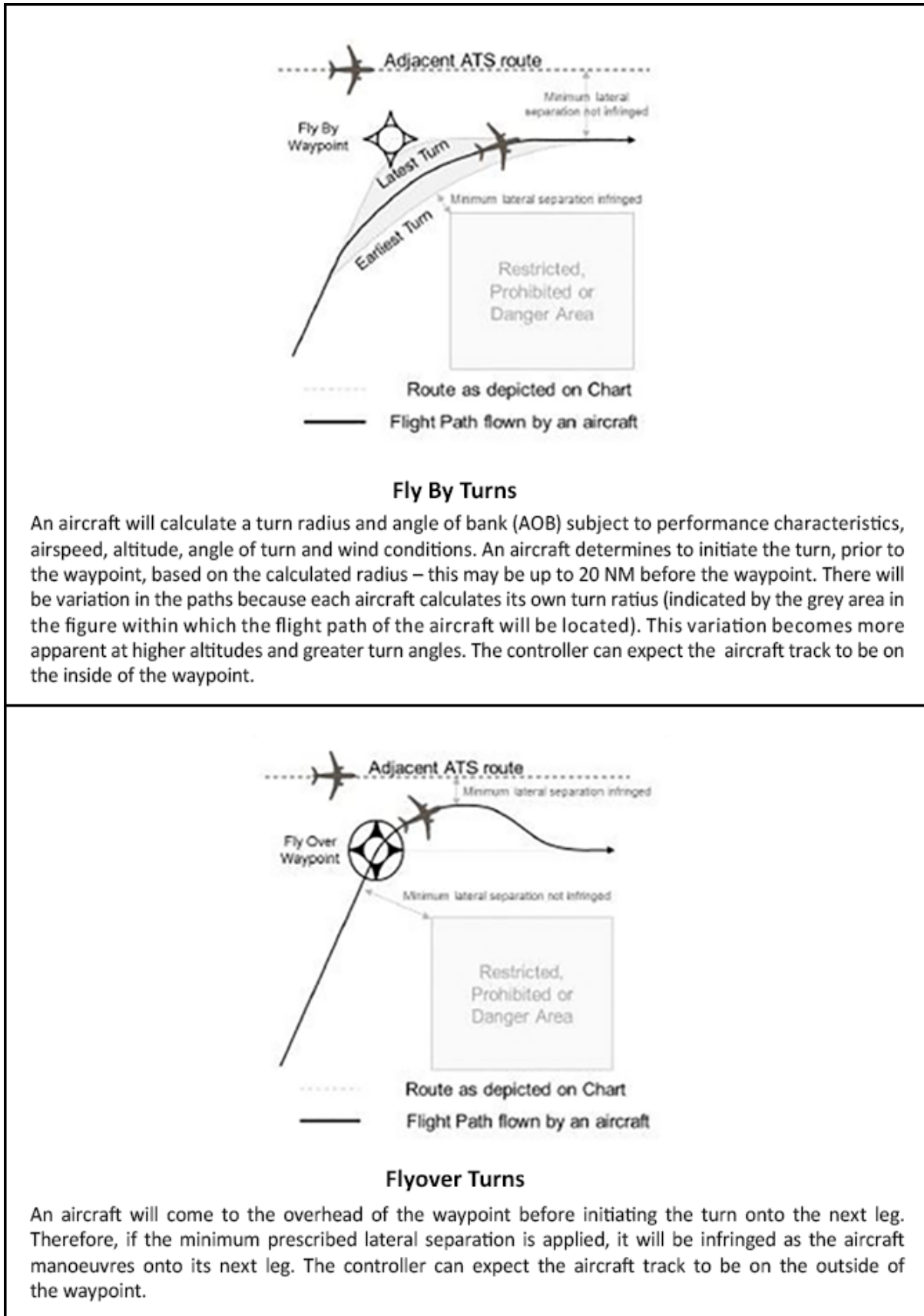

Figure 41: Turn over flyover waypoint and turn at fly-by waypoint

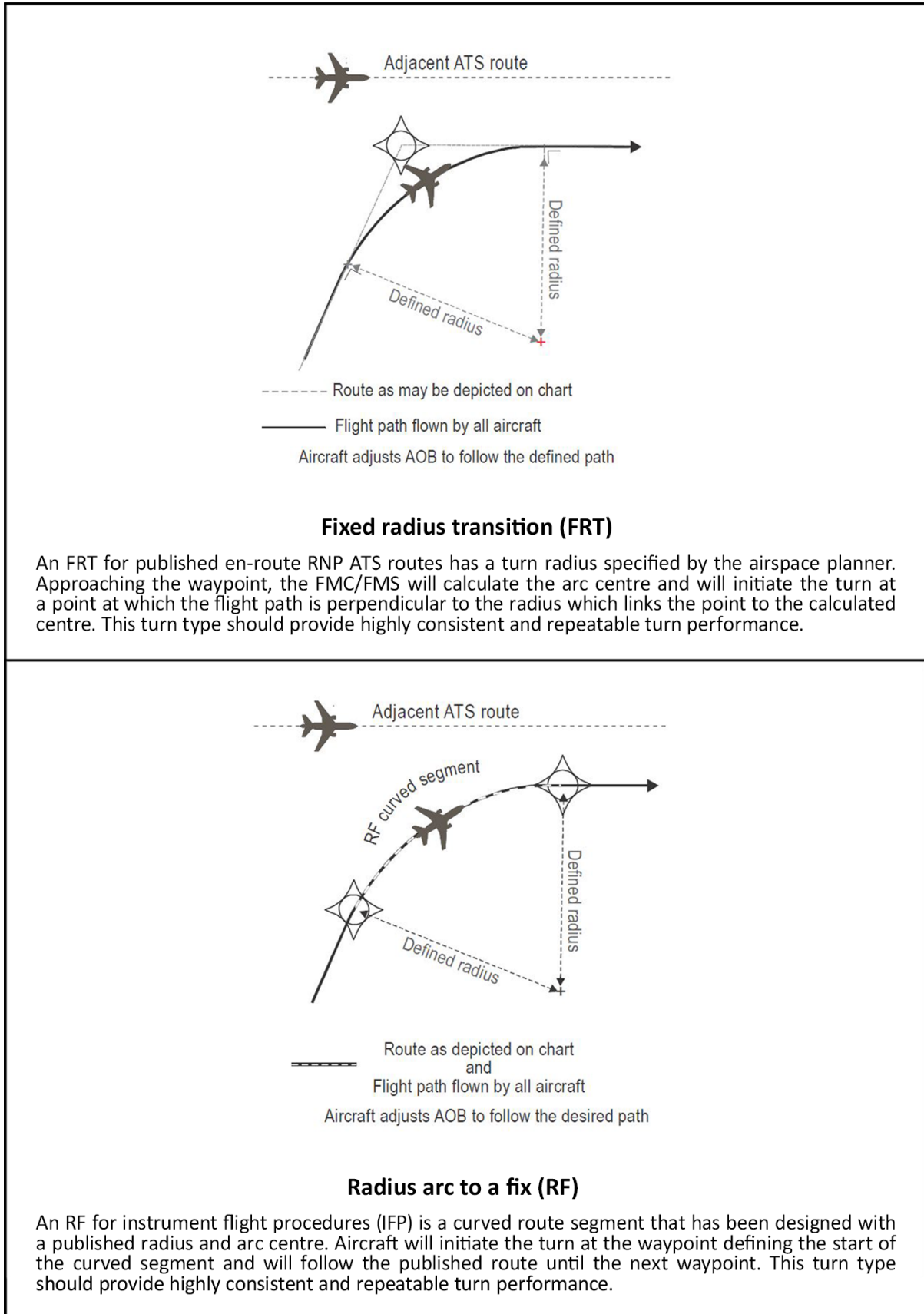

Figure 42: Fixed radius transition (FRT) and radius arc to a Fix (RF) turn

GM1 ATS.TR.210(d) Operation of air traffic control service**APPLICATION OF SEPARATION MINIMA TO IDENTIFIED AIRCRAFT**

- (a) When the control of an identified aircraft is to be transferred to a control sector that will provide the aircraft with procedural separation, the transferring air traffic controller should ensure that appropriate procedural separation is established between that aircraft and any other controlled aircraft before the transfer is effected.
- (b) When the control of an identified aircraft is to be transferred to a control sector that will provide the aircraft with procedural separation, such separation should be established by the transferring air traffic controller before the aircraft reaches the limits of the transferring air traffic controller's area of responsibility, or before the aircraft leaves the relevant area of surveillance coverage.

AMC1 ATS.TR.220 Application of wake turbulence separation**CATEGORISATION OF AIRCRAFT FOR THE PURPOSES OF WAKE TURBULENCE SEPARATION MINIMA APPLICATION**

Wake turbulence separation minima should be based on a grouping of aircraft types into four categories according to the maximum certificated take-off mass as follows:

- (a) SUPER (S) if so identified by the competent authority;
- (b) HEAVY (H) — all aircraft types of 136 000 kg or more;
- (c) MEDIUM (M) — aircraft types less than 136 000 kg but more than 7 000 kg; and
- (d) LIGHT (L) — aircraft types of 7 000 kg or less.

GM1 to AMC1 ATS.TR.220 Application of wake turbulence separation

For the Airbus A380-800 aircraft, with a maximum take-off mass in the order of 560 000 kg, it is recommended to apply an increase of the wake turbulence separation minima associated with the HEAVY category.

AMC2 ATS.TR.220 Application of wake turbulence separation**TIME-BASED WAKE TURBULENCE LONGITUDINAL SEPARATION MINIMA — ARRIVING AIRCRAFT**

Except for arriving VFR flights, and for arriving IFR flights executing visual approach, the following separation minima should be applied to aircraft landing behind a SUPER, a HEAVY or a MEDIUM aircraft:

- (a) MEDIUM aircraft behind SUPER aircraft: 3 minutes;
- (b) MEDIUM aircraft behind HEAVY aircraft: 2 minutes;
- (c) LIGHT aircraft behind SUPER aircraft: 4 minutes; and
- (d) LIGHT aircraft behind a HEAVY or MEDIUM aircraft: 3 minutes.

AMC3 ATS.TR.220 Application of wake turbulence separation

TIME-BASED WAKE TURBULENCE LONGITUDINAL SEPARATION MINIMA — DEPARTING AIRCRAFT

- (a) A separation minimum of 3 minutes should be applied for a LIGHT or MEDIUM aircraft and 2 minutes for a HEAVY aircraft taking off behind a SUPER aircraft when the aircraft are using:
- (1) the same runway;
 - (2) parallel runways separated by less than 760 m (2 500 ft);
 - (3) crossing runways if the projected flight path of the second aircraft will cross the projected flight path of the first aircraft at the same altitude or less than 300 m (1 000 ft) below; and
 - (4) parallel runways separated by 760 m (2 500 ft) or more if the projected flight path of the second aircraft will cross the projected flight path of the first aircraft at the same altitude or less than 300 m (1 000 ft) below.
- (b) A separation minimum of 4 minutes should be applied for a LIGHT or MEDIUM aircraft when taking off behind an SUPER aircraft from:
- (1) an intermediate part of the same runway; or
 - (2) an intermediate part of a parallel runway separated by less than 760 m (2 500 ft).
- (c) A separation minimum of 2 minutes should be applied between a LIGHT or MEDIUM aircraft taking off behind a HEAVY aircraft or a LIGHT aircraft taking off behind a MEDIUM aircraft when the aircraft are using:
- (1) the same runway (see Figure 43);
 - (2) parallel runways separated by less than 760 m (2 500 ft) (see Figure 43);
 - (3) crossing runways if the projected flight path of the second aircraft will cross the projected flight path of the first aircraft at the same altitude or less than 300 m (1 000 ft) below (see Figure 44); and
 - (4) parallel runways separated by 760 m (2 500 ft) or more if the projected flight path of the second aircraft will cross the projected flight path of the first aircraft at the same altitude or less than 300 m (1 000 ft) below (see Figure 44).

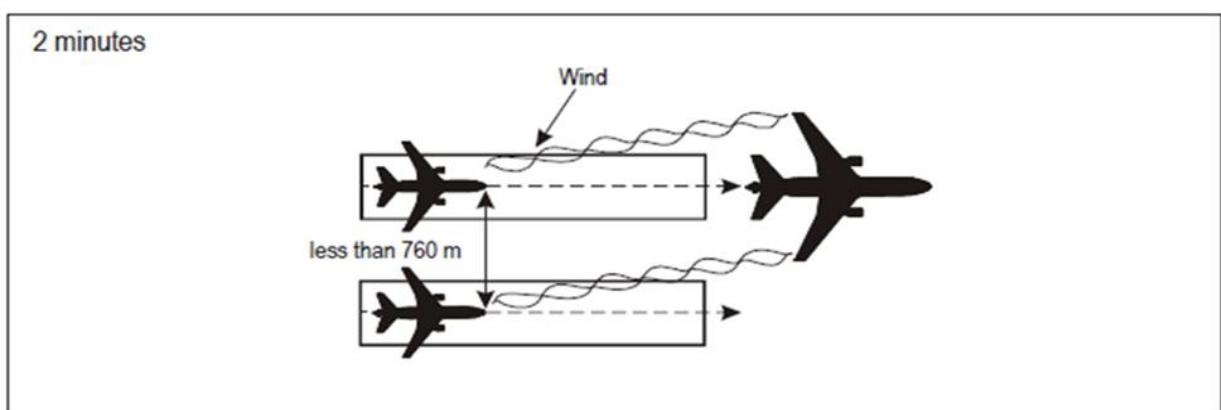

Figure 43: 2-minute separation for following aircraft

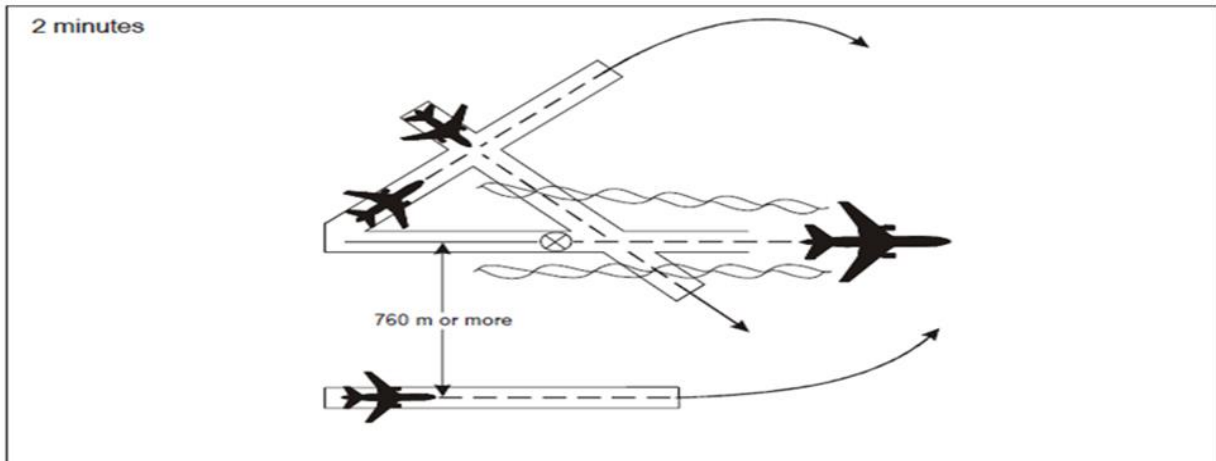

Figure 44: 2-minute wake turbulence separation for crossing aircraft

- (d) A separation minimum of 3 minutes should be applied (see Figure 45) between a LIGHT or MEDIUM aircraft when taking off behind a HEAVY aircraft or a LIGHT aircraft when taking off behind a MEDIUM aircraft from:
- (1) an intermediate part of the same runway; or
 - (2) an intermediate part of a parallel runway separated by less than 760 m (2 500 ft).

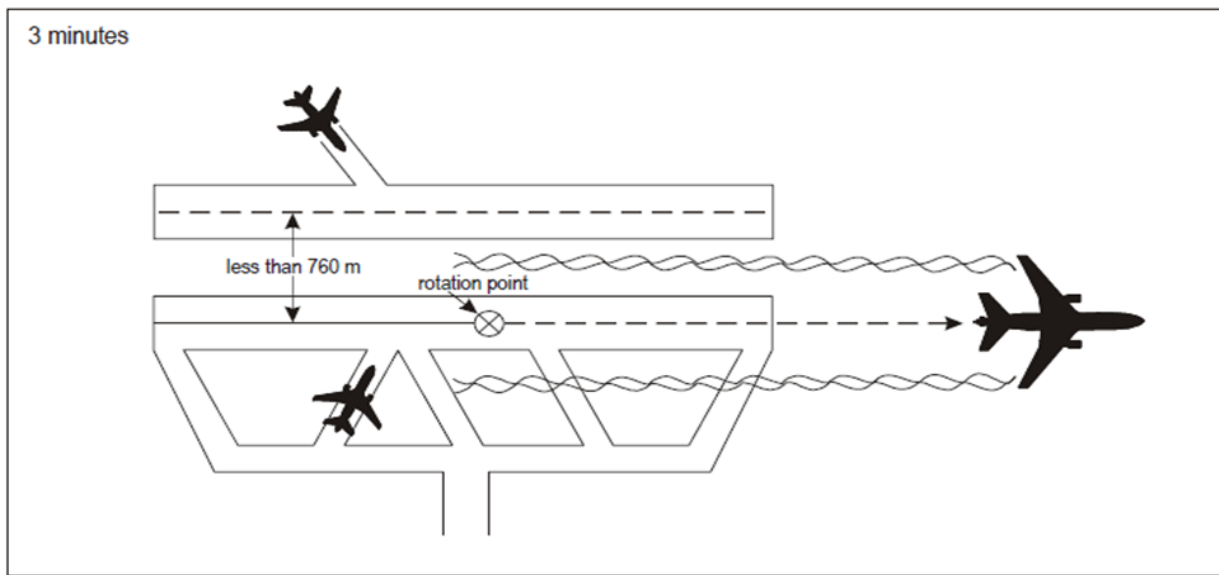

Figure 45: 3-minute wake turbulence separation for following aircraft

AMC4 ATS.TR.220 Application of wake turbulence separation

TIME-BASED WAKE TURBULENCE LONGITUDINAL SEPARATION MINIMA — DISPLACED LANDING THRESHOLD

- (a) A separation minimum of 3 minutes should be applied between a LIGHT or MEDIUM aircraft and a SUPER aircraft when operating on a runway with a displaced landing threshold when:
- (1) a departing LIGHT or MEDIUM aircraft follows a SUPER aircraft arrival; or

(2) an arriving LIGHT or MEDIUM aircraft follows a SUPER aircraft departure, if the projected flight paths are expected to cross.

(b) A separation minimum of 2 minutes should be applied between a LIGHT or MEDIUM aircraft and a HEAVY aircraft and between a LIGHT aircraft and a MEDIUM aircraft when operating on a runway with a displaced landing threshold when:

(1) a departing LIGHT or MEDIUM aircraft follows a HEAVY aircraft arrival and a departing LIGHT aircraft follows a MEDIUM aircraft arrival; or

(2) an arriving LIGHT or MEDIUM aircraft follows a HEAVY aircraft departure and an arriving LIGHT aircraft follows a MEDIUM aircraft departure,

if the projected flight paths are expected to cross.

AMC5 ATS.TR.220 Application of wake turbulence separation

TIME-BASED WAKE TURBULENCE LONGITUDINAL SEPARATION MINIMA — OPPOSITE DIRECTION

(a) A separation minimum of 3 minutes should be applied between a LIGHT or MEDIUM aircraft and a SUPER aircraft when the SUPER aircraft is making a low or missed approach and the LIGHT or MEDIUM aircraft is:

(1) utilising an opposite-direction runway for take-off; or

(2) landing on the same runway in the opposite direction, or on a parallel opposite-direction runway separated by less than 760 m (2 500 ft).

(b) A separation minimum of 2 minutes should be applied between a LIGHT or MEDIUM aircraft and a HEAVY aircraft and between a LIGHT aircraft and a MEDIUM aircraft when the heavier aircraft is making a low or missed approach and the lighter aircraft is:

(1) utilising an opposite-direction runway for take-off (see Figure 46); or

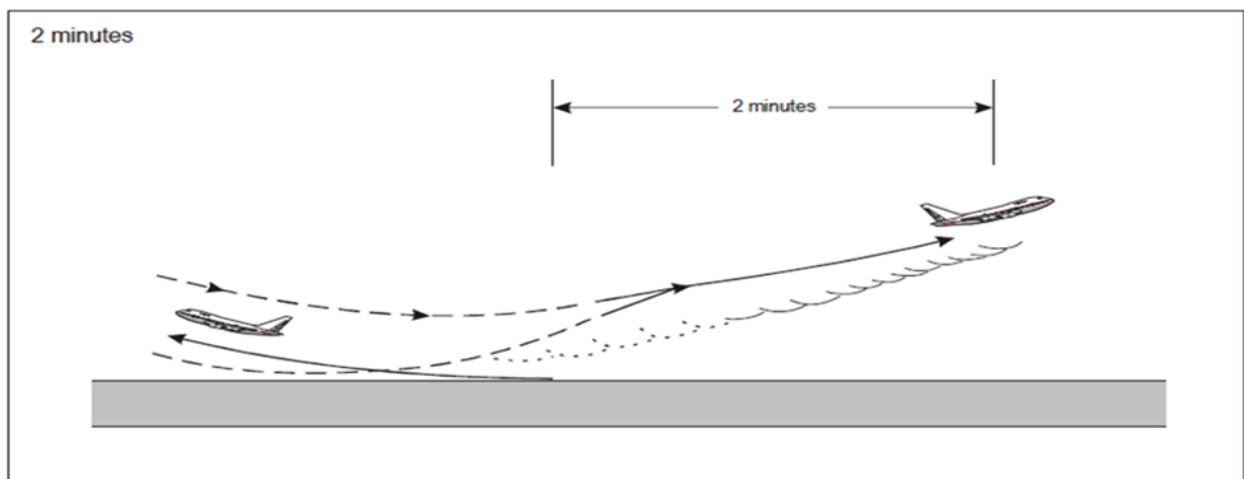

Figure 46: 2-minute wake turbulence separation for opposite-direction take-off

(2) landing on the same runway in the opposite direction, or on a parallel opposite-direction runway separated by less than 760 m (2 500 ft) (see Figure 47).

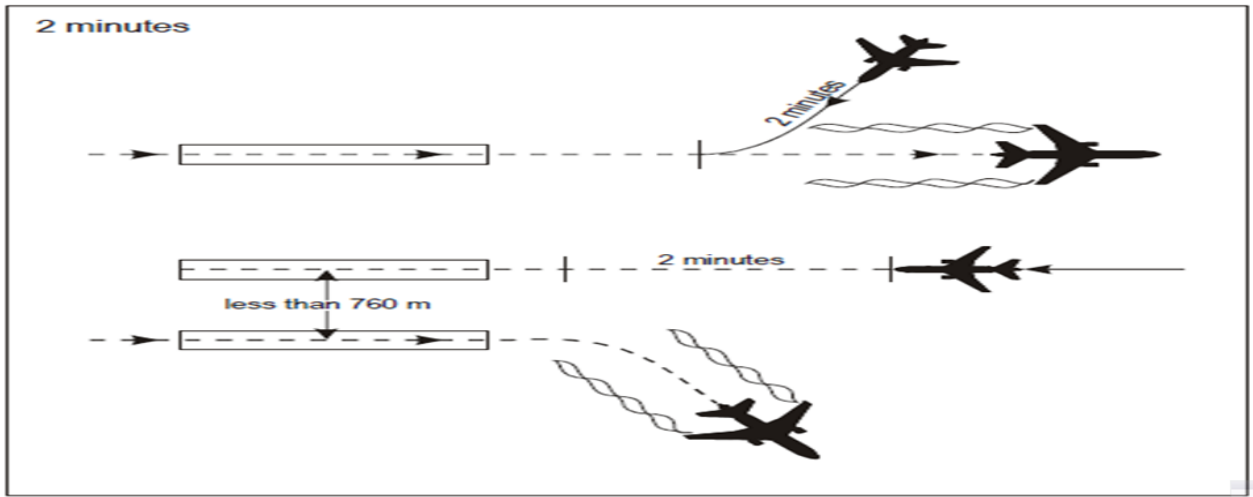

Figure 47: 2-minute wake turbulence separation for opposite-direction landing

AMC6 ATS.TR.220 Application of wake turbulence separation

DISTANCE-BASED WAKE TURBULENCE SEPARATION MINIMA BASED ON ATS SURVEILLANCE SYSTEM

The following distance-based wake turbulence separation minima should be applied to aircraft being provided with an ATS surveillance service in the approach and departure phases:

PRECEDING AIRCRAFT	SUCCEEDING AIRCRAFT	WAKE TURBULENCE RADAR SEPARATION MINIMA
SUPER or HEAVY	SUPER	Not required. In this case, separation reverts to radar separation minima as established by the air traffic services provider and approved by the competent authority.
SUPER	HEAVY	11.1 km (6.0 NM)
SUPER	MEDIUM	13.0 km (7.0 NM)
SUPER	LIGHT	14.8 km (8.0 NM)
HEAVY	HEAVY	7.4 km (4.0 NM)
HEAVY	MEDIUM	9.3 km (5.0 NM)
HEAVY	LIGHT	11.1 km (6.0 NM)
MEDIUM	LIGHT	9.3 km (5 NM)

GM1 to AMC6 ATS.TR.220 Application of wake turbulence separation

Figures 48 and 49 illustrate the application of the separation minima between HEAVY, MEDIUM and LIGHT aircraft prescribed in AMC6 ATS.TR.220.

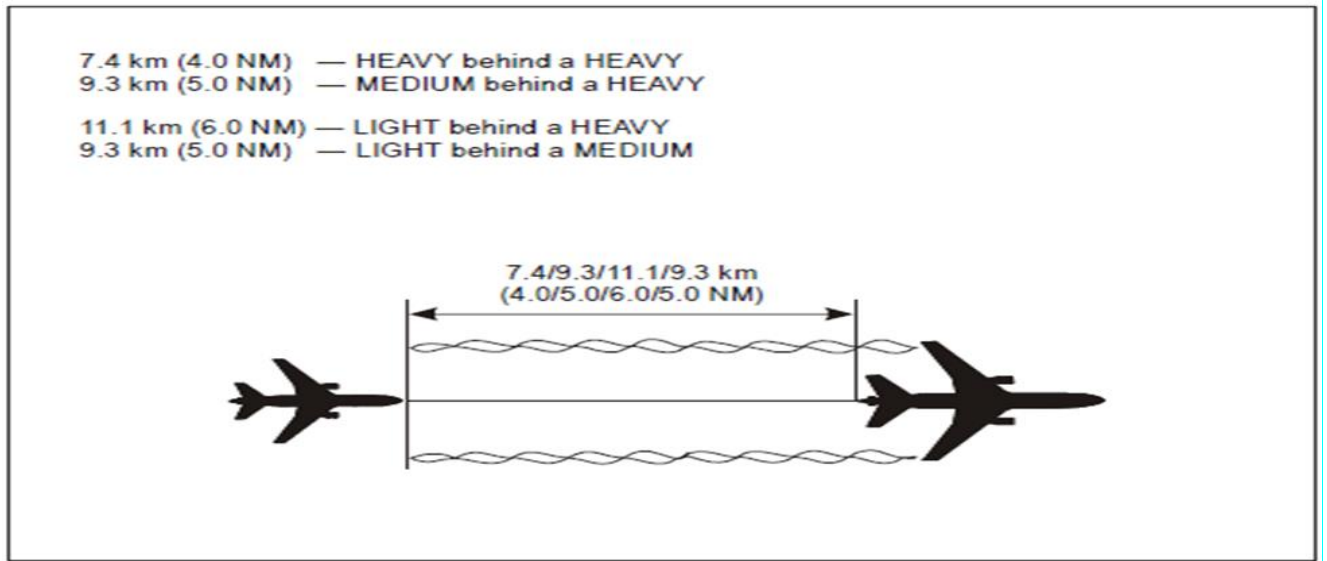
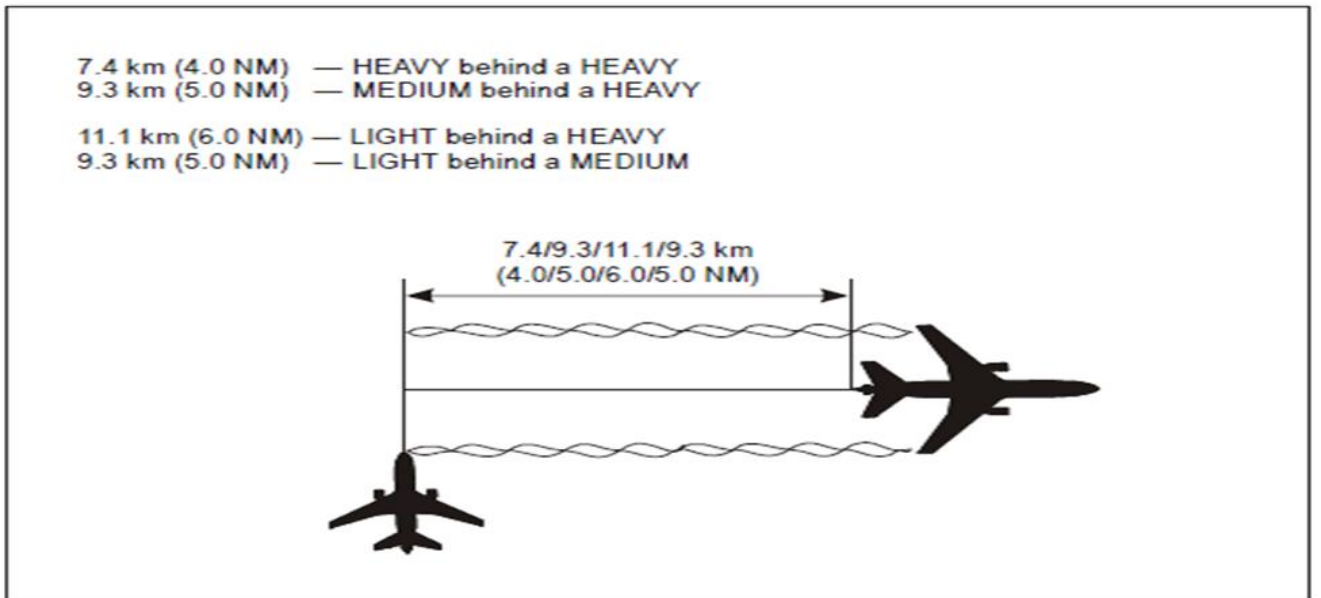
Figure 48: Operating directly behind

Figure 49: Crossing behind

AMC7 ATS.TR.220 Application of wake turbulence separation**RECAT-EU WAKE TURBULENCE SEPARATION MINIMA**

- (a) As an alternative to the wake turbulence separation minima prescribed in AMC1 to AMC6 ATS.TR.220, an air traffic services provider may decide to implement RECAT-EU or parts thereof, subject to the approval of the competent authority.
- (b) The following wake vortex aircraft groupings, based on the allocation of aircraft types to six categories according to both maximum certificated take-off mass and wingspan, and associated separation minima should be used when applying RECAT-EU:
- (1) 'SUPER HEAVY' — all aircraft types of 100 000 kg or more, and a wingspan between 72 m and 80 m;
 - (2) 'UPPER HEAVY' — all aircraft types of 100 000 kg or more, and a wingspan between 60 m and 72 m;
 - (3) 'LOWER HEAVY' — all aircraft types of 100 000 kg or more, and a wingspan below 52 m;
 - (4) 'UPPER MEDIUM' — aircraft types less than 100 000 kg but more than 15 000 kg, and a wingspan above 32 m;
 - (5) 'LOWER MEDIUM' — aircraft types less than 100 000 kg but more than 15 000 kg, and a wingspan below 32 m;
 - (6) 'LIGHT' — all aircraft types of 15 000 kg or less (without wingspan criterion).
- (c) Aircraft types with maximum certificated take-off mass of 100 000 kg or more, and wingspan between 52 m and 60 m are included in one of the above categories on the basis of specific analyses.
- (d) RECAT-EU wake turbulence distance-based separation minima for arriving and departing aircraft when ATS surveillance service is provided should be:

RECAT-EU Scheme Leader	Follower					
	Super Heavy	Upper Heavy	Lower Heavy	Upper Medium	Lower Medium	Light
Super Heavy	3 NM	4 NM	5 NM	5 NM	6 NM	8 NM
Upper Heavy	(*)	3 NM	4 NM	4 NM	5 NM	7 NM
Lower Heavy	(*)	(*)	3 NM	3 NM	4 NM	6 NM
Upper Medium	(*)	(*)	(*)	(*)	(*)	5 NM
Lower Medium	(*)	(*)	(*)	(*)	(*)	4 NM
Light	(*)	(*)	(*)	(*)	(*)	3 NM

(*) means that the separation minimum to be applied is the horizontal separation minimum based on an ATS surveillance system (established in accordance with AMC1 ATS.TR.210(c)(2)), and should remain compatible with runway capacity.

- (e) RECAT-EU wake turbulence time-based separation minima between departing aircraft should be:

RECAT-EU scheme		Super Heavy	Upper Heavy	Lower Heavy	Upper Medium	Lower Medium	Light
Leader / Follower		A	B	C	D	E	F
"Super Heavy"	A		100s	120s	140s	160s	180s
"Upper Heavy"	B				100s	120s	140s
"Lower Heavy"	C				80s	100s	120s
"Upper Medium"	D						120s
"Lower Medium"	E						100s
"Light"	F						80s

- (f) Wake turbulence time-based separation minima between departing aircraft should be applied by determining airborne times between successive aircraft.
- (g) An additional 60 seconds should be applied to all the wake turbulence time-based separation minima above when taking off from:
- (1) an intermediate part of the same runway; or
 - (2) an intermediate part of a parallel runway separated by less than 760 m (2 500 ft).

GM1 to AMC7 ATS.TR.220 Application of wake turbulence separation

APPLICATION OF RECAT-EU WAKE TURBULENCE SEPARATION SCHEME

- (a) The implementation of RECAT-EU or parts thereof is considered to be a change to the air traffic services provider functional system and, as such, is supported by a safety assessment, in accordance with ATS.OR.205. Any such implementation should provide clear operational benefits.
- (b) While the ICAO flight plan remains unchanged, the RECAT-EU wake vortex aircraft grouping should be displayed to air traffic controllers using the associated aircraft type information available in the flight data processing system.
- (c) A list of aircraft types for each RECAT-EU aircraft grouping, in particular with respect to new aircraft types, is maintained by EASA and is available at <https://www.easa.europa.eu/easa-and-you/air-traffic-management#group-easa-downloads>.

GM1 ATS.TR.220 Application of wake turbulence separation

WAKE TURBULENCE EFFECTS INDUCED BY HELICOPTERS

- (a) Helicopters should be kept well clear of light aircraft when hovering or while air-taxiing.
- (b) Helicopters produce vortices when in flight and there is some evidence that, per kilogramme of gross mass, their vortices are more intense than those of fixed-wing aircraft. When hovering in ground effect or air taxiing, helicopters generate downwash producing high-velocity outwash vortices to a distance approximately three times the diameter of the rotor.

AMC1 ATS.TR.230 Transfer of responsibility for control

COORDINATION IN RESPECT OF THE AIR TRAFFIC CONTROL SERVICE PROVISION — GENERAL

Agreements between air traffic control units or sectors and local instructions concerning coordination and transfer of control of flights should cover the following, as applicable:

- (a) definition of areas of responsibility and common interest, airspace structure and airspace classification(s);
- (b) any delegation of responsibility for the provision of air traffic services;
- (c) procedures for the exchange of flight plan and control data, including use of automated and/or verbal coordination messages;
- (d) means of communication;
- (e) requirements and procedures for approval requests;
- (f) significant points, levels or times for transfer of control;
- (g) significant points, levels or times for transfer of communication;
- (h) conditions applicable to the transfer and acceptance of control, such as specified altitudes/flight levels, specific separation minima or spacing to be established at the time of transfer, and the use of automation;

- (i) ATS surveillance system coordination procedures;
- (j) SSR code assignment procedures;
- (k) procedures for departing traffic;
- (l) designated holding fixes and procedures for arriving traffic;
- (m) applicable contingency procedures; and
- (n) any other provisions or information relevant to the coordination and transfer of control of flights.

GM1 ATS.TR.230 Transfer of responsibility for control

COORDINATION IN RESPECT OF THE AIR TRAFFIC CONTROL SERVICE PROVISION — GENERAL

- (a) The coordination and transfer of control of a flight between successive air traffic control units and control sectors should be effected by a dialogue comprising the following stages:
 - (1) notification of the flight in order to prepare for coordination, as necessary;
 - (2) coordination of conditions of transfer of control by the transferring air traffic control unit;
 - (3) coordination, if necessary, and acceptance of conditions of transfer of control by the accepting control unit; and
 - (4) transfer of control to the accepting control unit or control sector.
- (b) Air traffic control units should, to the extent possible, establish and apply standardised procedures for the coordination and transfer of control of flights, in order, inter alia, to reduce the need for verbal coordination. Such coordination procedures should be specified in letters of agreement and local instructions, as applicable.

GM2 ATS.TR.230 Transfer of responsibility for control

LETTERS OF AGREEMENT AND OPERATION MANUALS

Relevant information contained in letters of agreement should be included in the operation manual of the air traffic services units concerned.

AMC1 ATS.TR.230(a) Transfer of responsibility for control

COORDINATION BETWEEN AIR TRAFFIC CONTROL UNITS PROVIDING AIR TRAFFIC SERVICE WITHIN CONTIGUOUS CONTROL AREAS — TRANSFER OF CONTROL

- (a) The responsibility for the control of an aircraft should be transferred from the air traffic control unit to the next unit at the time of crossing the common control area boundary as determined by the unit having control of the aircraft or at such other point or time as has been agreed between the two units.
- (b) Where specified in letters of agreement between the air traffic control units concerned, and when transferring an aircraft, the transferring unit should notify the accepting control unit that the aircraft is in position to be transferred, and specify that the responsibility for control should be assumed by the accepting control unit forthwith at the time of crossing the control boundary

or other transfer control point specified in letters of agreement between the air traffic control units or at such other point or time coordinated between the two units.

- (c) If the transfer of control time or point is other than forthwith, the accepting control unit should not alter the clearance of the aircraft prior to the agreed transfer of control time or point without the approval of the transferring unit.
- (d) If transfer of communication is used to transfer an aircraft to an accepting control unit, responsibility for control should not be assumed until the time of crossing the control area boundary or other transfer of control point specified in letters of agreement between the air traffic control units.

GM1 ATS.TR.230(a)(2) Transfer of responsibility for control

DIVISION OF CONTROL BETWEEN A UNIT PROVIDING AREA CONTROL SERVICE AND A UNIT PROVIDING APPROACH CONTROL SERVICE

- (a) Except when otherwise specified in letters of agreement or local instructions, or by the ACC concerned in individual cases, a unit providing approach control service may issue clearances to any aircraft released to it by an ACC without reference to the ACC. However, when an approach has been missed, the ACC should, if affected by the missed approach, be advised immediately and subsequent action should be coordinated between the ACC and the unit providing approach control service as necessary.
- (b) An ACC may, after coordination with the unit providing approach control service, release aircraft directly to aerodrome control towers if the entire approach will be made under VMC.

GM1 ATS.TR.230(a)(3) Transfer of responsibility for control

DIVISION OF CONTROL BETWEEN A UNIT PROVIDING APPROACH CONTROL SERVICE AND A UNIT PROVIDING AERODROME CONTROL SERVICE

- (a) A unit providing approach control service should retain control of arriving aircraft until such aircraft have been transferred to the aerodrome control tower and are in communication with the aerodrome control tower. Letters of agreement or local instructions, appropriate to the airspace structure, terrain, meteorological conditions and air traffic services facilities available, should establish rules for the transfer of arriving aircraft.
- (b) A unit providing approach control service may authorise an aerodrome control tower to release an aircraft for take-off subject to the discretion of the aerodrome control tower with respect to arriving aircraft.
- (c) Aerodrome control towers should, when so prescribed in letters of agreement or local instructions, obtain approval from the unit providing approach control service prior to authorising operation of special VFR flights.

GM2 ATS.TR.230(a)(3) Transfer of responsibility for control

TRANSFER OF FLIGHTS BETWEEN ACC AND AERODROME CONTROL TOWER

Even though there is an approach control unit, control of certain flights may be transferred directly from an ACC to an aerodrome control tower and vice versa, subject to prior arrangement between

the units concerned for the relevant part of approach control service to be provided by the ACC or the aerodrome control tower, as applicable.

GM1 ATS.TR.230(a)(3)(i) Transfer of responsibility for control

COORDINATION OF STANDARD CLEARANCES FOR ARRIVING AIRCRAFT

- (a) Wherever possible, the air traffic services providers concerned should establish standardised procedures for transfer of control between the air traffic control units concerned and standard clearances for arriving aircraft.
- (b) Where standard clearances for arriving aircraft are in use and, provided no terminal delay is expected, clearance to follow the appropriate standard instrumental arrival (STAR) will normally be issued by the ACC without prior coordination with or approval from the approach control unit or the aerodrome control tower, as applicable.
- (c) Prior coordination of clearances should be required only in the event that a variation to the standard clearance or the standardised transfer of control procedures is necessary or desirable for operational reasons.
- (d) Provision should be made to:
 - (1) ensure that the approach control unit is at all times kept informed of the sequence of aircraft following the same STAR; and
 - (2) display the designators of assigned STARs to the ACC, the approach control unit and/or the aerodrome control tower, as applicable.

GM1 ATS.TR.230(a)(3)(ii) Transfer of responsibility for control

COORDINATION OF STANDARD CLEARANCES FOR DEPARTING AIRCRAFT

- (a) Wherever possible, the air traffic services providers concerned should establish standardised procedures for transfer of control between the air traffic control units concerned and standard clearances for departing aircraft.
- (b) Where standard clearances for departing aircraft have been agreed to between the units concerned, the aerodrome control tower will normally issue the appropriate standard clearance without prior coordination with or approval from the approach control unit or ACC.
- (c) Prior coordination of clearances should be required only in the event that a variation to the standard clearance or the standardised transfer of control procedures is necessary or desirable for operational reasons; for example, in the case of a change on the cleared initial flight level.
- (d) Provision should be made to:
 - (1) ensure that the approach control unit at all times is kept informed of the sequence in which aircraft will depart as well as the runway to be used; and
 - (2) display the designators of assigned standard instrumental departures (SIDs) to the aerodrome control tower, the approach control unit and/or the ACC as applicable.

AMC1 ATS.TR.230(a)(4) Transfer of responsibility for control**COORDINATION BETWEEN CONTROL POSITIONS WITHIN THE SAME UNIT**

Appropriate flight plan and control information should be exchanged between control positions within the same air traffic control unit, in respect of:

- (a) all aircraft for which responsibility for control will be transferred from one control position to another;
- (b) aircraft operating in such close proximity to the boundary between control sectors that control of traffic within an adjacent sector may be affected;
- (c) all aircraft for which responsibility for control has been delegated by an air traffic controller using procedural methods to an air traffic controller using an ATS surveillance system, as well as other aircraft affected.

AMC1 ATS.TR.230(b)(2) Transfer of responsibility for control**COORDINATION BETWEEN AIR TRAFFIC CONTROL UNITS PROVIDING AIR TRAFFIC SERVICES WITHIN CONTIGUOUS CONTROL AREAS — GENERAL**

- (a) Air traffic control units should forward from unit to unit, as the flight progresses, necessary flight plans and control information. When so required by agreement between air traffic services providers concerned, flight plans and flight progress information for flights along specified routes or portions of routes in close proximity to flight information region (FIR) boundaries should also be provided to the air traffic control units in charge of the FIRs adjacent to such routes or portions of routes.
- (b) The flight plan and control information in point (b) of ATS.TR.230 should be transmitted in sufficient time to permit reception and analysis of the data by the receiving unit(s) and necessary coordination between the units concerned.

AMC2 ATS.TR.230(b)(2) Transfer of responsibility for control**EXCHANGE OF MOVEMENT AND CONTROL DATA BETWEEN A UNIT PROVIDING AREA CONTROL SERVICE AND A UNIT PROVIDING APPROACH CONTROL SERVICE**

- (a) The unit providing approach control service should keep the ACC promptly advised of pertinent data on controlled traffic.
- (b) The ACC should keep the unit providing approach control service promptly advised of pertinent data on controlled traffic.
- (c) The ACC should normally forward to the unit providing approach control service information on arriving aircraft not less than 15 minutes before the estimated time of arrival and should revise such information as necessary.

GM1 to AMC2 ATS.TR.230(b)(2) Transfer of responsibility for control

EXCHANGE OF MOVEMENT AND CONTROL DATA FROM A UNIT PROVIDING APPROACH CONTROL SERVICE TO A UNIT PROVIDING AREA CONTROL SERVICE

Pertinent data on controlled traffic should include:

- (a) runway(s)-in-use and expected type of instrument approach procedure;
- (b) lowest vacant level at the holding fix available for use by the ACC;
- (c) average time interval or distance between successive arrivals as determined by the unit providing approach control service;
- (d) revision of the expected approach time issued by the ACC when the calculation of the expected approach time by the unit providing approach control service indicates a variation of 5 minutes or such other time as has been agreed between the two air traffic control units concerned;
- (e) arrival times over the holding fix when these vary by 3 minutes, or such other time as has been agreed between the two air traffic control units concerned, from those previously estimated;
- (f) cancellations by aircraft of IFR flight if these will affect levels at the holding fix or expected approach times of other aircraft;
- (g) aircraft departure times or, if agreed between the two air traffic control units concerned, the estimated time at the control area boundary or other specified point;
- (h) all available information relating to overdue or unreported aircraft; and
- (i) missed approaches which may affect the ACC.

GM2 to AMC2 ATS.TR.230(b)(2) Transfer of responsibility for control

EXCHANGE OF MOVEMENT AND CONTROL DATA FROM A UNIT PROVIDING AREA CONTROL SERVICE TO A UNIT PROVIDING APPROACH CONTROL SERVICE

Pertinent data on controlled traffic should include:

- (a) identification, type and point of departure of arriving aircraft;
- (b) estimated time and proposed level of arriving aircraft over holding fix or other specified point;
- (c) actual time and proposed level of arriving aircraft over holding fix if the aircraft is released to the unit providing approach control service after arrival over the holding fix;
- (d) requested type of IFR approach procedure if different from that specified by the approach control unit;
- (e) expected approach time issued;
- (f) when required, statement that an aircraft has been instructed to contact the unit providing approach control service;
- (g) when required, statement that an aircraft has been released to the unit providing approach control service including, if necessary, the time and conditions of release; and

- (h) anticipated delay to departing traffic due to congestion.

AMC3 ATS.TR.230(b)(2) Transfer of responsibility for control**EXCHANGE OF MOVEMENT AND CONTROL DATA BETWEEN A UNIT PROVIDING APPROACH CONTROL SERVICE AND A UNIT PROVIDING AERODROME CONTROL SERVICE**

- (a) An aerodrome control tower should keep the unit providing approach control service promptly advised of pertinent data on relevant controlled traffic.
- (b) The unit providing approach control service should keep the aerodrome control tower promptly advised of pertinent data on controlled traffic.

GM1 to AMC3 ATS.TR.230(b)(2) Transfer of responsibility for control**EXCHANGE OF MOVEMENT AND CONTROL DATA FROM AN AERODROME CONTROL TOWER TO A UNIT PROVIDING APPROACH CONTROL SERVICE**

Pertinent data on controlled traffic should include:

- (a) arrival and departure times;
- (b) when required, statement that the first aircraft in an approach sequence is in communication with and is sighted by the aerodrome control tower, and that reasonable assurance exists that a landing can be accomplished;
- (c) all available information relating to overdue or unreported aircraft;
- (d) information concerning missed approaches; and
- (e) information concerning aircraft that constitute essential local traffic to aircraft under the control of the unit providing approach control service.

GM2 to AMC3 ATS.TR.230(b)(2) Transfer of responsibility for control**EXCHANGE OF MOVEMENT AND CONTROL DATA FROM A UNIT PROVIDING APPROACH CONTROL SERVICE TO AN AERODROME CONTROL TOWER**

Pertinent data on controlled traffic should include:

- (a) estimated time and proposed level of arriving aircraft over the aerodrome, at least 15 minutes prior to estimated arrival;
- (b) when required, a statement that an aircraft has been instructed to contact the aerodrome control tower and that control shall be assumed by that unit; and
- (c) anticipated delay to departing traffic due to congestion.

GM1 ATS.TR.230(b)(2) Transfer of responsibility for control

COORDINATION BETWEEN AIR TRAFFIC CONTROL UNITS FOR APPROVAL REQUESTS

- (a) If the flying time from the departure aerodrome of an aircraft to the boundary of an adjacent control area is less than the specified minimum required to permit transmission of the necessary flight plan and control information to the accepting control unit after take-off and to allow adequate time for reception, analysis and coordination, the transferring control unit should, prior to departure, forward that information to the accepting control unit together with a request for approval. The required time period should be specified in letters of agreement or local instructions, as appropriate. In the case of revisions to a previously transmitted current flight plan, and control data being transmitted earlier than this specified time period, no approval from the accepting control unit should be required.
- (b) In the case of an aircraft in flight requiring an initial clearance when the flying time to the boundary of an adjacent control area is less than a specified minimum, the aircraft should be held within the transferring air traffic control unit's control area until the flight plan and control information have been forwarded together with a request for approval, and coordination effected with the adjacent air traffic control unit.
- (c) In the case of an aircraft requesting a change in its current flight plan, or of a transferring air traffic control unit proposing to change the current flight plan of an aircraft, and the flying time of the aircraft to the control area boundary is less than a specified minimum, the revised clearance should be withheld pending approval of the proposal by the adjacent air traffic control unit.
- (d) When boundary estimate data is to be transmitted for approval by the accepting control unit, the time in respect of an aircraft not yet departed should be based on the estimated time of departure as determined by the air traffic control unit in whose area of responsibility the departure aerodrome is located. In respect of an aircraft in flight requiring an initial clearance, the time should be based on the estimated elapsed time from the holding fix to the boundary plus the time expected to be needed for coordination.

GM2 ATS.TR.230(b)(2) Transfer of responsibility for control

COORDINATION BETWEEN AIR TRAFFIC CONTROL UNITS FOR TAKE-OFF AND CLEARANCE EXPIRY TIMES

- (a) The take-off time should be specified by the ACC when it is necessary to:
 - (1) coordinate the departure with traffic not released to the unit providing approach control service; and
 - (2) provide en-route separation between departing aircraft following the same track.
- (b) If the take-off time is not specified, the unit providing approach control service should determine it when necessary to coordinate the departure with traffic released to it.
- (c) A clearance expiry time should be specified by the ACC if a delayed departure would conflict with traffic not released to the unit providing approach control service. If, for traffic reasons of its own, a unit providing approach control service has to specify in addition its own clearance expiry time, this should not be later than that specified by the ACC.

GM3 ATS.TR.230(b)(2) Transfer of responsibility for control COORDINATION BETWEEN AIR TRAFFIC SERVICES UNITS FOR CHANGE FROM IFR TO VFR

An air traffic control unit receiving notification of an aircraft's intention to change from IFR to VFR flight should, as soon as practicable thereafter, so inform all other air traffic services units to whom the IFR flight plan was addressed, except those units through whose regions or areas the flight has already passed.

AMC1 ATS.TR.230(b)(7) Transfer of responsibility for control PHRASEOLOGIES TO BE USED IN THE COORDINATION BETWEEN AIR TRAFFIC SERVICES UNITS

(a) When, in accordance with ATS.TR.120, communications between air traffic services units or sectors are effected in English language, the following phraseology should be used for the coordination:

<i>Circumstances</i>	<i>Phraseologies</i>
ESTIMATES AND REVISIONS ... sending unit ... receiving unit reply (if flight plan details are not available)	a) ESTIMATE [<i>direction of flight</i>] (<i>aircraft call sign</i>) [SQUAWKING (<i>SSR code</i>)] (<i>type</i>) ESTIMATED (<i>significant point</i>) (<i>time</i>) (<i>level</i>) (or DESCENDING FROM (<i>level</i>) TO (<i>level</i>)) [SPEED (<i>filed TAS</i>)] (<i>route</i>) [REMARKS]; b) ESTIMATE (<i>significant point</i>) ON (<i>aircraft call sign</i>); c) NO DETAILS;

<i>Circumstances</i>	<i>Phraseologies</i>
... receiving unit reply (if flight plan details are available) ... sending unit reply	<p>(aircraft type) (destination);</p> <p>[SQUAWKING (SSR code)] [ESTIMATED] (significant point) (time) AT (level);</p> <p><i>Note. — In the event that flight plan details are not available the receiving station shall reply to b) NO DETAILS and transmitting station shall pass full estimate as in a).</i></p> <p>d) ESTIMATE UNMANNED FREE BALLOON(S) (identification and classification) ESTIMATED OVER (place) AT (time) REPORTED FLIGHT LEVEL(S) (figure or figures) [or FLIGHT LEVEL UNKNOWN] MOVING (direction) ESTIMATED GROUND SPEED (figure) (other pertinent information, if any);</p> <p>e) REVISION (aircraft call sign) (details as necessary).</p>
TRANSFER OF CONTROL	<p>a) REQUEST RELEASE OF (aircraft call sign);</p> <p>b) (aircraft call sign) RELEASED [AT (time)] [conditions/restrictions];</p> <p>c) IS (aircraft call sign) RELEASED [FOR CLIMB (or DESCENT)];</p> <p>d) (aircraft call sign) NOT RELEASED [UNTIL (time or significant point)];</p> <p>e) UNABLE (aircraft call sign) [TRAFFIC IS (details)].</p>
CHANGE OF CLEARANCE	<p>a) MAY WE CHANGE CLEARANCE OF (aircraft call sign) TO (details of alteration proposed);</p> <p>b) AGREED TO (alteration of clearance) OF (aircraft call sign);</p> <p>c) UNABLE (aircraft call sign);</p> <p>d) UNABLE (desired route, level, etc.) [FOR (aircraft call sign)] [DUE (reason)] (alternative clearance proposed).</p>
APPROVAL REQUEST	<p>a) APPROVAL REQUEST (aircraft call sign) ESTIMATED DEPARTURE FROM (significant point) AT (time);</p> <p>b) (aircraft call sign) REQUEST APPROVED [(restriction if any)];</p> <p>c) (aircraft call sign) UNABLE (alternative instructions).</p>

<i>Circumstances</i>	<i>Phraseologies</i>
INBOUND RELEASE	[INBOUND RELEASE] <i>(aircraft call sign)</i> [SQUAWKING <i>(SSR code)</i>] <i>(type)</i> FROM <i>(departure point)</i> RELEASED AT <i>(significant point, or time, or level)</i> CLEARED TO AND ESTIMATING <i>(clearance limit)</i> <i>(time)</i> AT <i>(level)</i> [EXPECTED APPROACH TIME or NO DELAY EXPECTED] CONTACT AT <i>(time)</i> .
HANDOVER	HANDOVER <i>(aircraft call sign)</i> [SQUAWKING <i>(SSR code)</i>] POSITION <i>(aircraft position)</i> <i>(level)</i> .
EXPEDITION OF CLEARANCE	a) EXPEDITE CLEARANCE <i>(aircraft call sign)</i> EXPECTED DEPARTURE FROM <i>(place)</i> AT <i>(time)</i> ; b) EXPEDITE CLEARANCE <i>(aircraft call sign)</i> [ESTIMATED] OVER <i>(place)</i> AT <i>(time)</i> REQUESTS <i>(level or route, etc.)</i> .
REDUCED VERTICAL SEPARATION MINIMUM (RVSM) OPERATIONS ... to verbally supplement estimate messages of aircraft non-approved for RVSM or to verbally supplement an automated estimate message exchange that does not automatically transfer information from Item 18 of the flight plan followed by supplementary information, as appropriate ... to communicate the cause of a contingency relating to an aircraft that is unable to conduct RVSM operations due to severe turbulence or other severe meteorological phenomena or equipment failure, as applicable	a) NEGATIVE RVSM [<i>(supplementary information, e.g. State aircraft)</i>]; b) UNABLE RVSM DUE TURBULENCE (or EQUIPMENT, as applicable).

- (b) When, in accordance with ATS.TR.120, communications between air traffic services units or sectors are effected in a mutually agreed language other than English, the air traffic services provider(s) should coordinate to develop and use a phraseology for coordination between such units or sectors.

GM1 ATS.TR.235 ATC clearances

The issuance of ATC clearances by air traffic control units constitutes authority for an aircraft to proceed only in so far as known air traffic is concerned. ATC clearances do not constitute authority to violate any applicable regulations for promoting the safety of flight operations or for any other purpose; neither do clearances relieve a pilot-in-command of any responsibility whatsoever in connection with a possible violation of applicable rules and regulations.

GM1 ATS.TR.235(a)(5) ATC clearances**ASSURANCE OF OBSTACLE CLEARANCE IN VECTORING**

- (a) Prescribed obstacle clearance will exist at all times when an air traffic controller issues clearances at or above the established minimum flight altitudes.
- (b) When an IFR flight is being vectored, the pilot may be unable to determine the aircraft's exact position in respect of obstacles in this area and consequently the altitude which provides the required obstacle clearance.

AMC1 ATS.TR.235(b) ATC clearances**CONTENTS OF CLEARANCES FOR DEPARTING AIRCRAFT**

Clearances for departing aircraft should specify, when necessary for the separation of aircraft:

- (a) direction of take-off and turn after take-off;
- (b) heading or track to be made good before taking up the cleared departure track;
- (c) level to maintain before continuing climb to assigned level;
- (d) time, point and/or rate at which a level change shall be made; and
- (e) any other necessary manoeuvre consistent with safe operation of the aircraft.

GM1 to AMC1 ATS.TR.235(b) ATC clearances**CORRECTION TO HEADING OR TRACK PRIOR TO TAKING UP THE CLEARED DEPARTURE TRACK**

'Track to be made good' means that the pilot should correct for the wind effect and to fly a heading that would ensure keeping that track.

AMC2 ATS.TR.235(b) ATC clearances**CONTENTS OF STANDARD CLEARANCES FOR DEPARTING AIRCRAFT**

Standard clearances for departing aircraft should contain the following items:

- (a) aircraft identification;
- (b) clearance limit (normally destination aerodrome);
- (c) designator of the assigned SID, if applicable;
- (d) cleared level;
- (e) allocated SSR code; and
- (f) any other necessary instructions or information not contained in the SID description, e.g. instructions relating to change of frequency.

GM1 to AMC2 ATS.TR.235(b) ATC clearances**CONTENTS OF STANDARD CLEARANCES FOR DEPARTING AIRCRAFT — COMMUNICATION FAILURE**

- (a) Clearances for departing aircraft may specify a cleared level other than that indicated in the filed flight plan for the en-route phase of flight, without a time or geographical limit for the cleared level. Such clearances will normally be used to facilitate the application of tactical control methods by air traffic control units, normally through the use of an ATS surveillance system.
- (b) Where clearances for departing aircraft which contain no time or geographical limit for a cleared level are utilised, the action to be taken by an aircraft experiencing air-ground communication failure in the event that the aircraft has been radar-vectorised away from the route specified in its current flight plan, should be prescribed on the basis of a regional air navigation agreement and included in the SID description or published in AIPs.

AMC3 ATS.TR.235(b) ATC clearances**CLEARANCES FOR ARRIVING IFR FLIGHTS**

An IFR flight should neither be cleared for an initial approach below the appropriate minimum altitude as specified by the State concerned nor descend below that altitude unless:

- (a) the pilot has reported passing an appropriate point defined by a navigation aid or as a waypoint;
or
- (b) the pilot reports that the aerodrome is and can be maintained in sight; or
- (c) the aircraft is conducting a visual approach; or
- (d) the air traffic controller has determined the aircraft's position through the use of an ATS surveillance system, and a lower minimum altitude has been specified for use when providing ATS surveillance services.

AMC4 ATS.TR.235(b) ATC clearances**CONTENTS OF STANDARD CLEARANCES FOR ARRIVING AIRCRAFT**

Standard clearances for arriving aircraft should contain the following items:

- (a) aircraft identification;
- (b) designator of the assigned STAR if applicable;
- (c) runway-in-use, except when part of the STAR description;
- (d) cleared level; and
- (e) any other necessary instructions or information not contained in the STAR description, e.g. change of communications.

AMC1 ATS.TR.235(b)(2) ATC clearances**SPECIFICATION OF CLEARANCE LIMIT**

A clearance limit should be described by specifying the name of an appropriate significant point, or aerodrome, or controlled airspace boundary.

GM1 to AMC1 ATS.TR.235(b)(2) ATC clearances**SPECIFICATION OF CLEARANCE LIMIT**

- (a) When prior coordination has been effected with units under whose control the aircraft will subsequently come, or if there is reasonable assurance that it can be effected a reasonable time prior to their assumption of control, the clearance limit should be the destination aerodrome or, if not practicable, an appropriate intermediate point, and coordination should be expedited so that a clearance to the destination aerodrome may be issued as soon as possible.
- (b) If an aircraft has been cleared to an intermediate point in adjacent controlled airspace, the appropriate air traffic control unit will then be responsible for issuing, as soon as practicable, an amended clearance to the destination aerodrome.
- (c) When the destination aerodrome is outside controlled airspace, the air traffic control unit responsible for the last controlled airspace through which an aircraft will pass should issue the appropriate clearance for flight to the limit of that controlled airspace.

GM1 ATS.TR.235(b)(3)(i) ATC clearances

The phrase 'cleared flight planned route' may be used to describe any route or portion thereof, provided the route or portion thereof is identical to that filed in the flight plan and sufficient routing details are given to definitely establish the aircraft on its route. The phrases 'cleared (designation) departure' or 'cleared (designation) arrival' may be used when standard departure or arrival routes have been established and published in AIPs.

AMC1 ATS.TR.235(b)(4) ATC clearances**INSTRUCTIONS IN CLEARANCES RELATING TO LEVELS**

Instructions included in clearances relating to levels should consist of:

- (a) cruising level(s) or, for cruise climb, a range of levels, and, if necessary, the point to which the clearance is valid with regard to the level(s);
- (b) levels at which specified significant points are to be crossed, when necessary;
- (c) the place or time for starting climb or descent, when necessary;
- (d) the rate of climb or descent, when necessary; and
- (e) detailed instructions concerning departure or approach levels, when necessary.

GM1 ATS.TR.235(b)(4) ATC clearances**ASSIGNMENT OF FLIGHT LEVELS FOR CONTROLLED FLIGHTS**

- (a) Except when traffic conditions and coordination procedures permit authorisation of cruise climb, an air traffic control unit should normally authorise only one level for an aircraft beyond its control area, i.e. that level at which the aircraft will enter the next control area whether contiguous or not. It is the responsibility of the accepting control unit to issue clearance for further climb as appropriate. When relevant, aircraft will be advised to request en-route any cruising level changes desired.
- (b) In so far as practicable, cruising levels of aircraft flying to the same destination should be assigned in a manner that will be correct for an approach sequence at destination.
- (c) An aircraft at a cruising level should normally have priority over other aircraft requesting that cruising level. When two or more aircraft are at the same cruising level, the preceding aircraft should normally have priority.

GM1 ATS.TR.235(b)(5) ATC clearances**CONTENT OF THE CLEARANCES — TIME OF EXPIRY**

The time of expiry of the clearance indicates the time after which the clearance will be automatically cancelled if the flight has not been commenced.

GM1 ATS.TR.235(c) ATC clearances**ESTABLISHMENT AND PROCEDURES FOR STANDARD ARRIVAL AND DEPARTURE ROUTES**

Guidance related to the establishment of standard departure and arrival routes and associated procedures is available in ICAO Doc 9426 'ATS Planning Manual' (Chapter 4, Appendix A).

AMC1 ATS.TR.235(d) ATC clearances**CLEARANCES FOR TRANSONIC FLIGHT**

- (a) Air traffic control units should, whenever practicable, deliver clearance for the transonic acceleration phase to aircraft intending supersonic flight prior to departure.
- (b) During the transonic and supersonic phases of a flight, amendments to the clearance should be kept to a minimum and should take due account of the operational limitations of the aircraft in these flight phases.

GM1 ATS.TR.235(e) ATC clearances**CHANGE IN CLEARANCE REGARDING ROUTE**

The nature of the change should include a description of the route and levels to the point where it joins the previously cleared route, or, if the aircraft will not rejoin the previous route, to the destination.

GM2 ATS.TR.235(e) ATC clearances**CHANGE IN CLEARANCE REGARDING CRUISING LEVEL**

If it is necessary to change the cruising level of an aircraft operating along an established ATS route extending partly within and partly outside controlled airspace and where the respective series of cruising levels are not identical, the change should, whenever possible, be effected within controlled airspace.

GM1 ATS.TR.235(g)(2) ATC clearances**READ-BACK OF CPDLC MESSAGES**

When so indicated by local safety assessments, the air traffic services provider may require that the receipt of some of the CPDLC message types (in particular those addressing trajectory changes) is acknowledged by voice.

GM1 ATS.TR.235(h)(1) ATC clearances**CLEARANCE UPDATE**

Where a clearance is issued covering the initial part of the flight solely as a means of expediting departing traffic, the succeeding en-route clearance will be as specified in point (h)(1) of ATS.TR.235 even though the aerodrome of first intended landing is under the jurisdiction of an ACC other than the one issuing the en-route clearance.

GM1 ATS.TR.235(h)(3)(i) ATC clearances**AIR-GROUND COMMUNICATION FOR DELIVERY OF DOWNSTREAM CLEARANCES**

Where practicable, and where data link communications are used to facilitate downstream clearance delivery, two-way voice communications between the pilot and the air traffic control unit providing the downstream clearance should be available.

AMC1 ATS.TR.240(a) Control of persons and vehicles at controlled aerodromes**CONTROL OF OTHER THAN AIRCRAFT TRAFFIC ON THE MANOEUVRING AREA**

(a) The movement of pedestrians or vehicles on the manoeuvring area should be subject to authorisation by the aerodrome control tower. Persons, including drivers of all vehicles, should be required to obtain authorisation from the aerodrome control tower before entry to the manoeuvring area. Notwithstanding such an authorisation, entry to a runway or runway strip or change in the operation authorised should be subject to a further specific authorisation by the aerodrome control tower.

(b) When an aircraft is landing or taking off, the air traffic controller should not permit vehicles to hold closer to the runway-in-use than:

(1) at a taxiway/runway intersection — at a runway-holding position; and

- (2) at a location other than a taxiway/runway intersection — at a distance equal to the separation distance of the runway-holding position.

AMC2 ATS.TR.240(a) Control of persons and vehicles at controlled aerodromes

UNCERTAINTY ON AIRCRAFT AND/OR VEHICLES POSITION ON THE MANOEUVRING AREA

In the event that the aerodrome air traffic controller becomes aware of an aircraft or vehicle that is lost or uncertain of its position on the manoeuvring area, he or she should immediately take appropriate action to safeguard operations and assist the aircraft or vehicle concerned in determining its position.

GM1 ATS.TR.240(b)(2) Control of persons and vehicles at controlled aerodromes

CONTROL OF PERSONS AND VEHICLES AT AERODROMES

In prescribing the separation method(s) between vehicles and taxiing aircraft, the availability of lighting, markings, signals and signage should normally be taken into account.

GM1 ATS.TR.240(c) Control of persons and vehicles at controlled aerodromes

PRIORITY TO EMERGENCY VEHICLES

When emergency vehicles are proceeding to the assistance of an aircraft in distress, all other movement of surface traffic should, to the extent practicable, be halted until it is determined that the progress of the emergency vehicles will not be impeded.

GM1 ATS.TR.245 Use of surface movement surveillance equipment at aerodromes

FUNCTIONS OF SURFACE MOVEMENT RADAR IN SURFACE MOVEMENT CONTROL

The information displayed on an SMR display may be used to assist in:

- (a) monitoring of aircraft and vehicles on the manoeuvring area for compliance with clearances and instructions;
- (b) determining that a runway is clear of traffic prior to a landing or take-off;
- (c) providing information on essential local traffic on or near the manoeuvring area;
- (d) determining the location of aircraft and vehicles on the manoeuvring area;
- (e) providing directional taxi information to aircraft when requested by the pilot or deemed necessary by the air traffic controller. Except under special circumstances, e.g. emergencies, such information should not be issued in the form of specific heading instructions; and
- (f) providing assistance and advice to emergency vehicles.

GM2 ATS.TR.245 Use of surface movement surveillance equipment at aerodromes

FUNCTIONS OF ADVANCED SURFACE MOVEMENT GUIDANCE AND CONTROL SYSTEMS — A-SMGCS IN SURFACE MOVEMENT CONTROL

When authorised and subject to conditions prescribed by the competent authority, the information provided on an A-SMGCS display may be used for the purpose of:

- (a) determining the location of aircraft on the movement area and vehicles on the manoeuvring area. Where visual observation by the aerodrome air traffic controller is not possible, or whenever deemed beneficial by the aerodrome air traffic controller, the information provided by A-SMGCS may be used to replace visual observation;
- (b) monitoring of aircraft and vehicles on the manoeuvring area for compliance with clearances and instructions;
- (c) determining that a runway is clear of traffic or assisting in the assessment that a runway will be clear of traffic prior to a landing or take-off;
- (d) providing information on essential local traffic on or near the manoeuvring area;
- (e) providing directional taxi information to aircraft when requested by the pilot or deemed necessary by the air traffic controller. Such information should not be issued in the form of specific heading instructions (except in special circumstances, e.g. emergencies); and
- (f) providing assistance and advice to emergency vehicles.

AMC1 ATS.TR.250(a) Essential traffic and essential local traffic information

ESSENTIAL TRAFFIC INFORMATION — CONTENT

Essential traffic information should include the following information if relevant and available:

- (a) direction of flight of aircraft concerned;
- (b) type and wake turbulence category of aircraft concerned;
- (c) level of aircraft concerned; and
- (d) one of the following:
 - (1) estimated time over the reporting point nearest to where the level will be crossed; or
 - (2) relative bearing of the aircraft concerned in terms of the 12-hour clock as well as distance from the conflicting traffic; or
 - (3) actual or estimated position of the aircraft concerned.

GM1 ATS.TR.250(a) Essential traffic and essential local traffic information

ESSENTIAL TRAFFIC INFORMATION — CONTENT

Subject to provisions in point (b) of ATS.TR.210, air traffic control units are required to provide separation between IFR flights in airspace classes A to E, and between IFR and VFR flights in classes B and C. Air traffic control units are not required to provide separation between VFR flights, except within airspace class B. Therefore, IFR or VFR flights may constitute essential traffic to IFR traffic, and IFR flights may constitute essential traffic to VFR traffic. However, a VFR flight would not constitute essential traffic to other VFR flights except within class B airspace.

AMC1 ATS.TR.250(b) Essential traffic and essential local traffic information

ESSENTIAL LOCAL TRAFFIC INFORMATION

- (a) Information on essential local traffic should be issued in a timely manner, either directly or through the unit providing approach control service when, in the judgement of the aerodrome air traffic control, such information is necessary in the interest of safety, or when requested by aircraft.
- (b) Essential local traffic should be described so as to be easily identified.

AMC1 ATS.TR.255 Operations on parallel or near-parallel runways

REQUIREMENTS AND PROCEDURES FOR INDEPENDENT PARALLEL DEPARTURES

- (a) Parallel runways may be used for independent instrument departures as follows:
 - (1) both runways are used exclusively for departures (independent departures); or
 - (2) one runway is used exclusively for departures while the other runway is used for a mixture of arrivals and departures (semi-mixed operation); or
 - (3) both runways are used for mixed arrivals and departures (mixed operation).
- (b) Independent IFR departures should only be conducted from parallel runways when the conditions listed below are met:
 - (1) the runway centre lines are spaced by a minimum distance of 760 m (2 500 ft) (as also specified in CS ADR-DSN.B.055 'Minimum distance between parallel instrument runways' in EASA ED Decision 2014/013/R 'Certification Specifications and Guidance Material For Aerodromes Design', as amended);
 - (2) the nominal departure tracks diverge by at least:
 - (i) 15 degrees immediately after take-off; or
 - (ii) 10 degrees where:
 - (A) both aircraft are flying an RNAV or RNP instrument departure; and
 - (B) the turn commences no more than 3.7 km (2.0 NM) from the departure end of the runway;

- (3) a suitable ATS surveillance system capable of identification of the aircraft within 1.9 km (1.0 NM) from the end of the runway is available; and
- (4) ATS operational procedures ensure that the required track divergence is achieved.

AMC2 ATS.TR.255 Operations on parallel or near-parallel runways

REQUIREMENTS AND PROCEDURES FOR INDEPENDENT PARALLEL APPROACHES

Independent parallel approaches should only be conducted to parallel runways when the following conditions are met:

- (a) separate air traffic controllers are responsible for the sequencing and spacing of arriving aircraft to each runway;
- (b) as early as practicable after an aircraft has established communication, the approach control unit advises the aircraft that independent parallel approaches are in force;
- (c) the following ATS surveillance criteria are met:
 - (1) for runway centreline spacing less than 1 310 m (4 300 ft) but not less than 1 035 m (3 400 ft), an ATS surveillance system with:
 - (i) a minimum accuracy as follows:
 - (A) for SSR, an azimuth accuracy of 0.06 degrees (one sigma); or
 - (B) for MLAT or ADS-B, an accuracy of 30 m (100 ft);
 - (ii) an update of 2.5 seconds or less; and
 - (iii) a high-resolution display providing position prediction and deviation alert;
 - (2) for runway centreline spacing less than 1 525 m (5 000 ft) but not less than 1 310 m (4 300 ft), provided that it is determined that the safety of aircraft operations is not adversely affected, an ATS surveillance system:
 - (i) with performance specifications equal to or better than:
 - (A) for SSR, a demonstrated minimum accuracy of 0.3 degrees (one sigma); or
 - (B) for MLAT or ADS-B, a demonstrated performance capability equivalent to or better than the SSR requirement;
 - (ii) with an update of 5 seconds or less;
 - (3) for runway centreline spacing of 1 525 m (5 000 ft) or more, a surveillance system with:
 - (i) a minimum SSR azimuth accuracy of 0.3 degrees (one sigma), or for MLAT or ADS-B, a demonstrated performance capability equivalent to or better than the SSR requirement; and
 - (ii) an update of 5 seconds or less;
- (d) the instrument approach procedure that aligns the aircraft with the extended runway centre line is one of the following:
 - (1) a precision approach procedure;

- (2) an approach with vertical guidance (APV) designed using the RNP AR APCH specification where:
- (i) the RNP value for B, and the RNP value for C, if that segment of the approach is within the horizontal separation minimum of a parallel approach, does not exceed one quarter of the distance between runway centre lines (A) (see Figure 51); and
 - (ii) the RNP value for B, and the RNP value for C, if that part of the approach is within the horizontal separation minimum of a parallel approach, does not exceed $(A-D)/2$ (see Figure 51);

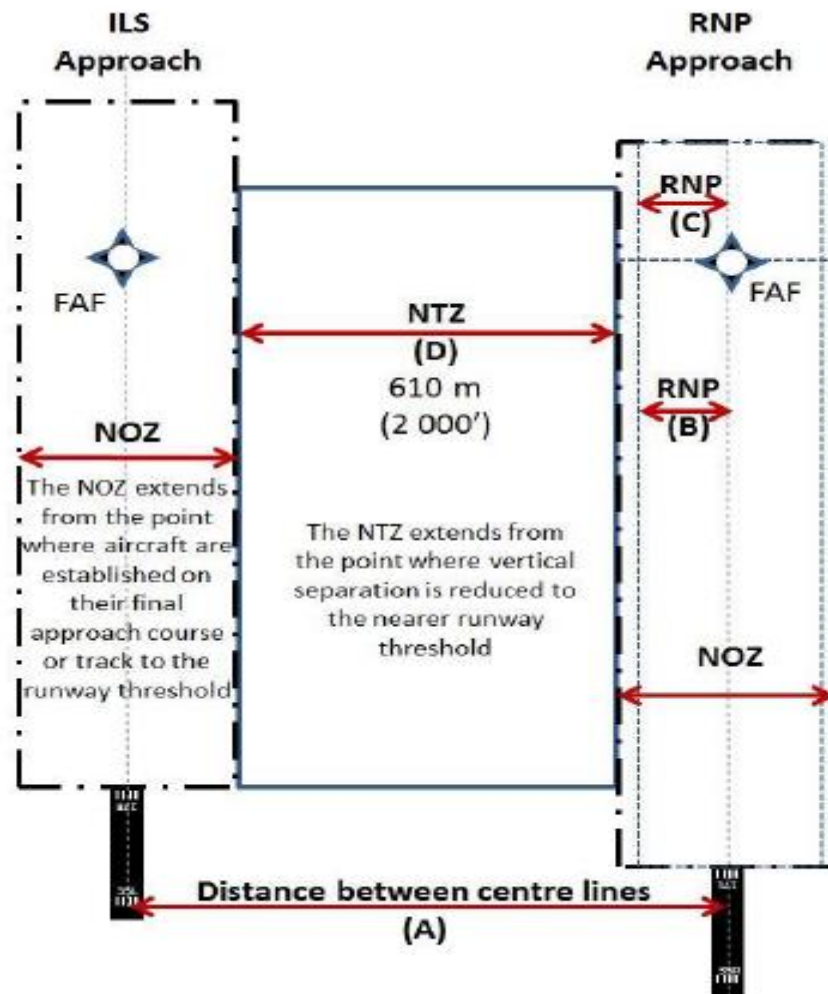

Figure 51: Distance between centre lines, NTZ and NOZ

- (3) an APV procedure designed using either the RNP APCH or RNP AR APCH navigation specification, provided that:
- (i) an appropriate documented safety assessment has shown that an acceptable level of safety can be met;
 - (ii) operations are approved by the competent authority; and
 - (iii) the instrument approach is demonstrated to protect the NTZ from infringement during normal operations;

- (e) the nominal tracks of the missed approach procedures diverge by at least 30 degrees;
- (f) an obstacle survey and evaluation is completed, as appropriate, for the areas adjacent to the final approach segments;
- (g) aircraft are advised as early as possible, of the assigned runway, instrument approach procedure and any additional information considered necessary to confirm correct selection;
- (h) the final approach course or track is intercepted by use of either:
 - (1) a published arrival and approach procedures that intercept with the IAF or the intermediate approach fix (IF); or
 - (2) vectoring, provided that:
 - (i) the final vector meets the following conditions:
 - (A) enable the aircraft to intercept at an angle not greater than 30 degrees;
 - (B) provide at least 1.9 km (1.0 NM) straight and level flight prior to the final approach course or track intercept; and
 - (C) enable the aircraft to be established on the final approach course or track in level flight for at least 3.7 km (2.0 NM) prior to intercepting the glide path or vertical path for the selected instrument approach procedure;
 - (ii) when assigning the final vector, the aircraft is advised of:
 - (A) the runway to which the approach is being made;
 - (B) its position relative to a fix on the final approach course or track;
 - (C) the altitude to be maintained until established on the final approach course or track, to the glide path or vertical path intercept point; and
 - (D) if required, clearance for the appropriate approach.
- (i) an NTZ at least 610 m (2 000 ft) wide is established equidistant between extended runway centre lines and is depicted on the ATS surveillance system situation display;
- (j) a minimum of a nominal 300 m (1 000 ft) vertical separation or, subject to ATS surveillance system capabilities, a minimum of 5.6 km (3.0 NM) horizontal separation is provided between aircraft on adjacent approaches until the aircraft are established inbound on a final approach course or track, or on an RNP AR APCH approach, and within the normal operating zone (NOZ);
- (k) a minimum of 5.6 km (3.0 NM) horizontal separation, or a minimum of 4.6 km (2.5 NM) horizontal separation if so determined in accordance with point (a) of ATS.TR.215, is provided between aircraft established on the same final approach course or track, unless increased longitudinal separation is required due to wake turbulence;
- (l) the approaches to each runway are monitored with an ATS surveillance system by separate air traffic controllers (referred to as monitoring controllers) different than those in point (a) above for each runway, or, if determined by a safety assessment and approved by the competent authority, by a single monitoring controller for no more than two runways:

- (1) on dedicated radio channels, or when no such channels are available to the monitoring controller until landing, it is assured that:
 - (i) transfer of communication of aircraft to the respective aerodrome air traffic controller's channel is effected before either of the two aircraft on adjacent final approach tracks intercepts the glide path or vertical path for the selected instrument approach procedure; and
 - (ii) the air traffic controller(s) monitoring the approaches to each runway are provided with the capability to override transmissions of aerodrome control on the respective radio channels for each arrival flow;
- (2) so that when the nominal 300 m (1 000 ft) vertical separation is reduced:
 - (i) the applicable minimum longitudinal separation between aircraft on the same final approach course or track is maintained; and
 - (ii) aircraft do not penetrate the depicted NTZ by issuing instructions as follows:
 - (A) when it is observed that an aircraft overshoots the turn-on or continues on a track which will penetrate the NTZ, the aircraft is instructed to return immediately to the correct track; or
 - (B) when an aircraft is observed penetrating the NTZ, the aircraft on the adjacent final approach course or track is instructed to immediately climb and turn to the assigned altitude/height and heading (break-out procedure) in order to avoid the deviating aircraft. Where parallel approach obstacle assessment surfaces (PAOAS) criteria are applied for the obstacle assessment, the monitoring controller (see below in point (f)) should not issue the heading instruction to the aircraft below 120 m (400 ft) above the runway threshold elevation, and the heading instruction should not exceed 45 degrees track difference with the final approach course or track;
- (3) the monitoring is provided until:
 - (i) separation as stipulated in point (b)(1) of AMC3 ATS.TR.210(c)(2) is applied, provided the established procedures ensure that monitoring controllers are advised whenever such separation is applied; or
 - (ii) the aircraft has landed, or in case of a missed approach, is at least 1.9 km (1.0 NM) beyond the departure end of the runway and adequate separation with any other traffic is established;
- (m) the meteorological conditions under which independent parallel approaches are suspended for runway centre lines which are spaced less than 1 525 m (5 000 ft) are defined by the air traffic services provider and approved by the competent authority.

GM1 to AMC2 ATS.TR.255 Operations on parallel or near-parallel runways

The information that independent parallel operations are in force may be provided through the ATIS broadcasts.

GM2 to AMC2 ATS.TR.255 Operations on parallel or near-parallel runways

HIGH-RESOLUTION DISPLAY

With reference to point (c)(1)(iii) of AMC2 ATS.TR.255, a high-resolution display should:

- (a) enable the air traffic controller to determine whether an aircraft is correctly aligned with the intended trajectory;
- (b) depict the NTZ(s);
- (c) be able to display any obstacle that would adversely affect a break-out procedure; and
- (d) accurately reflect the azimuth accuracy prescribed in point (c)(1)(i)(A) of AMC2 ATS.TR.255.

GM3 to AMC2 ATS.TR.255 Operations on parallel or near-parallel runways

PRECISION APPROACH PROCEDURE

With reference to point (d)(1) of AMC2 ATS.TR.255, the precision approach procedure that aligns the aircraft with the extended runway centre line may include one of the following: ILS, GLS, MLS or SBAS CAT I, when applicable, for the final approach segment.

GM4 to AMC2 ATS.TR.255 Operations on parallel or near-parallel runways

PRECISION APPROACH PROCEDURE — DEMONSTRATION OF SAFETY

With reference to point (d)(3) of AMC2 ATS.TR.255, the demonstration of the safety of an APV procedure designed using either RNP APCH or RNP AR APCH navigation specification during simultaneous approaches may consider, inter alia:

- (a) the collision risk from normal and residual (not mitigated) atypical errors;
- (b) likelihood of ACAS nuisance alerting during normal operations;
- (c) wake hazard;
- (d) monitoring and available levels of system automation;
- (e) data base management;
- (f) flight management system input and related crew workload;
- (g) impacts of meteorological conditions and other environmental factors; and

- (h) training and published ATC break-out procedures.

GM5 to AMC2 ATS.TR.255 Operations on parallel or near-parallel runways

SAFETY ASSESSMENT

With reference to point (l) of AMC2 ATS.TR.255, the conduct of safety assessments to enable the monitoring of not more than two runways by a single air traffic controller should review factors such as, but not limited to, complexity, times of operation, traffic mix and density, arrival rate, available levels of system automation, availability of back-up systems, impacts of meteorological conditions and other environmental factors.

GM6 to AMC2 ATS.TR.255 Operations on parallel or near-parallel runways

MONITORING CONTROLLER

With reference to point (l) of AMC2 ATS.TR.255:

- (a) Independent operations on parallel runways can only be conducted if there are means to ensure that the objectives of the air traffic services would be fulfilled in a manner similar to what the application of separation minima (vertical or horizontal) would achieve.
- (b) Considering the geometry of two aircraft operating simultaneously on the parallel runways, while longitudinal separation is applied between aircraft approaching the same runway, a lateral separation is needed between the aircraft operating on parallel approaches for the most critical scenario: two aircraft at the same time on each final approach.
- (c) To provide the acceptable lateral separation in such circumstances, an NTZ is established. The NTZ is considered to provide the lateral separation from the moment vertical separation between aircraft on adjacent approaches no longer exists until aircraft have landed. The responsibility of air traffic controllers is to closely monitor the progress of the flights and to immediately react when an aircraft deviates towards the NTZ boundary.
- (d) In that sense, the tasks of these air traffic controllers (referred to as ‘monitoring controllers’), are as follows:
- (1) **to ensure** that the NTZ is not penetrated when vertical separation is reduced;
 - (2) **to instruct** aircraft observed to overshoot the turn-on or to continue on a track which will penetrate the NTZ to return immediately to the correct track;
 - (3) **to ensure** that the applicable minimum longitudinal separation between aircraft on the same final approach course or track is maintained;
 - (4) if no dedicated radio channels are available for the monitoring controllers to control aircraft until landing, **to transfer** communication with the aircraft to the respective channel of the aerodrome air traffic controller before either of the two aircraft on adjacent final approach tracks intercepts the glide path or vertical path for the selected instrument approach procedure. In this case, the controllers monitoring the approaches

- to each runway are provided with the capability to override transmissions of aerodrome control on the respective radio channels for each arrival flow;
- (5) if dedicated radio channels are available for the monitoring controllers to **relay** the landing clearances received from the aerodrome air traffic controller, or when the aerodrome air traffic controller informs that visual separation can be applied, to **transfer** the communications to the aerodrome air traffic controller;
- (6) when an aircraft is observed penetrating the NTZ, to **instruct** the aircraft on the adjacent final approach course or track to immediately climb and turn to an assigned altitude/height and heading (break-out procedures) in order to avoid the deviating aircraft. Where PAOAS criteria are applied for the obstacle assessment, the monitoring controller will not issue the heading instruction to the aircraft below 120 m (400 ft) above the runway threshold elevation, and the heading instruction will not exceed 45 degrees track difference with the final approach course or track; and
- (7) **to terminate** monitoring when either:
- (i) visual separation is applied provided that procedures ensure that both monitoring controllers are advised whenever visual separation is applied; or
 - (ii) the aircraft has landed or, in case of a missed approach, is at least 1 NM beyond the departure end of the runway and adequate separation with other traffic is established.
- (e) When there is a large deviation from the final approach track, communication between the controllers and pilots involved is critical. For independent parallel approaches, monitoring controllers are required, for each runway, with separate control frequencies. The monitoring controller(s) can transmit on either of these frequencies, automatically overriding transmissions by the other aerodrome air traffic controllers, or can use dedicated radio channels, if available. It is essential that a check of the override capability at each monitor position be performed prior to the monitoring controllers assuming responsibility of the position. The air traffic services provider should take steps to ensure that, in the event of a deviation, the monitoring controller will be able to contact the deviating aircraft and the endangered aircraft immediately. This will involve studying the proportion of time during which communications are blocked.
- (f) Monitoring of approaches to no more than two runways by a single monitoring controller may be permitted if determined by a safety assessment and approved by the competent authority, as described below.
- (g) During simultaneous independent approach operations, participating aircraft are established on guidance to instrument approach procedures which have been designed to not interfere with one another. By remaining on their guidance, the aircraft are, by design, not threats to each other, and are considered separated. If either aircraft deviates from its lateral path defined by its assigned instrument approach, separation is no longer assured. To protect against operational errors, system or equipment failures, etc., Simultaneous Operations on Parallel or Near-Parallel Instrument Runways (SOIR) procedures require the monitoring controller to provide intervention as necessary. Monitoring controllers are required to identify and respond to such traffic transgressions in a timely manner to protect proximate traffic and minimise collision risk. Their responsibility is to recognise a deviation from a cleared lateral path,

determine a manoeuvre for any nearby traffic that might be threatened by this deviation that will avoid a collision, and transmit this manoeuvre instruction to the threatened aircraft. If there is no threatened traffic, or after the threatened traffic has begun its escape manoeuvre, the monitoring controller will also attempt to instruct the deviating aircraft.

(h) The time budgeted for recognition by monitoring controller of potential collision during non-nominal events in simultaneous parallel approaches is in the order of seconds. System-generated alerts to the monitoring controller that can differentiate quickly and accurately between normal and non-nominal situations will be an enabling element of the operation. The region known as NTZ is used to provide air traffic controllers with time to identify that one aircraft on a simultaneous approach may threaten the other and to then take appropriate action to avoid a collision. Normally, a dedicated monitoring controller is assigned to each approach during simultaneous operations. However, since a single NTZ is defined in the space between simultaneous approaches, it may be possible for a single controller to effectively monitor and correct any transgressing aircraft. Approval of an alternate to the otherwise-required approach-specific monitor control positions should consider, as a minimum, the following elements unique to a specific approach pairing:

(1) Approach geometry complexity:

- (i) displaced thresholds which cause non-coincident altitudes along the parallel tracks;
- (ii) use of curved course transitions to final; and
- (iii) short finals.

(2) Traffic mix and density:

- (i) mix of light-heavy traffic necessitating varying longitudinal wake spacing; and
- (ii) approach speed variations.

(3) Arrival rate and density:

- (i) total traffic volume versus approach capacity; and
- (ii) flow management consistency with traffic demand.

(4) Available levels of system automation:

- (i) conformance monitoring tools; and
- (ii) non-transgression alerting.

(5) Availability of back-up systems to provide continuity of:

- (i) communication;
- (ii) approach navigation (approach technology);
- (iii) surveillance (independent, redundant sources); and
- (iv) interdependency of CNS.

(6) The impacts of local meteorological conditions and other environmental factors:

- (i) inversion on final that can cause wake vortices to not dissipate;

- (ii) excessive tailwind;
- (iii) high cross-winds;
- (iv) gusty winds; and
- (v) inconsistent wind patterns (e.g. caused by nearby obstacles or terrain).

GM7 to AMC2 ATS.TR.255 Operations on parallel or near-parallel runways

SUSPENSION OF INDEPENDENT PARALLEL OPERATIONS DUE TO METEOROLOGICAL CONDITIONS

With reference to point (m) of AMC2 ATS.TR.255:

- (a) The meteorological conditions to be considered include, but are not limited to, the following:
 - (1) wind shear;
 - (2) turbulence;
 - (3) downdrafts; and
 - (4) crosswind and significant meteorological conditions such as thunderstorms, which might otherwise increase deviations from the final approach course or track to the extent that safety may be impaired.
- (b) Guidance relating to meteorological conditions is contained in the ICAO Doc 9643 'Manual on Simultaneous Operations on Parallel or Near-Parallel Instrument Runways (SOIR)'.

AMC3 ATS.TR.255 Operations on parallel or near-parallel runways

REQUIREMENTS AND PROCEDURES FOR DEPENDENT PARALLEL APPROACHES

Dependent parallel approaches should only be conducted to parallel runways when the following conditions are met:

- (a) separate air traffic controllers are responsible for the sequencing and spacing of arriving aircraft to each runway;
- (b) the runway centre lines are spaced by 915 m (3 000 ft) or more;
- (c) the final approach course or track is intercepted by use of:
 - (1) vectoring; or
 - (2) a published arrival and approach procedures that intercepts with the IAF or the IF.
- (d) an ATS surveillance system with a minimum SSR azimuth accuracy of 0.3 degrees (one sigma), or for MLAT or ADS-B a performance capability equivalent to or better than the SSR requirement can be demonstrated and an update period of 5 seconds or less is available;
- (e) the instrument flight procedure that aligns the aircraft with the extended runway centre line is one of the following:
 - (1) a precision approach procedure;

- (2) an APV procedure designed using the RNP AR APCH navigation specification, provided that the RNP value for B, and the RNP value for C if that segment of the approach is within the horizontal separation minimum of a parallel approach, does not exceed one quarter of the distance between runway centre lines (A) (See Figure 52);
- (3) an APV procedure designed using the RNP AR APCH navigation specification that does not meet the provisions in point (2) above or an RNP APCH, provided that:
- (i) an appropriate, documented safety assessment has shown that an acceptable level of safety can be met; and
 - (ii) operations are approved by the competent authority;

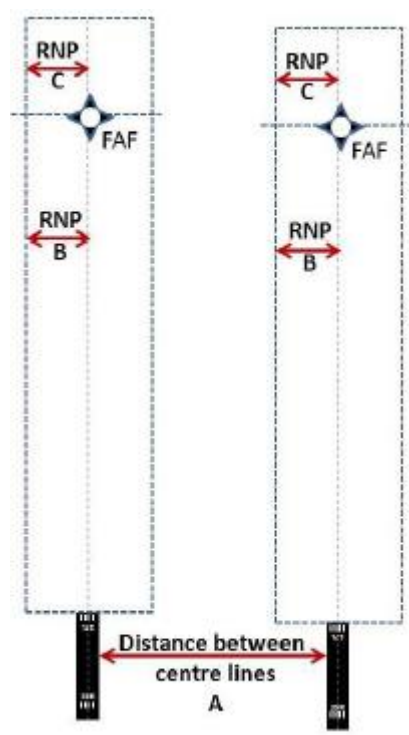

Figure 52: RNP value and distance between centre lines

- (f) aircraft are advised that approaches are in use to both runways;
- (g) the nominal tracks of the missed approach procedures diverge by at least 30 degrees;
- (h) the approach control unit has the capability to override the frequencies used by the aerodrome control tower;
- (i) a minimum of nominal 300 m (1 000 ft) vertical separation or a minimum of 5.6 km (3.0 NM) horizontal separation is provided between aircraft until established on the final approach courses or tracks of parallel approaches;
- (j) the minimum horizontal separation to be provided between aircraft established on the same final approach course or track is 5.6 km (3.0 NM), or 4.6 km (2.5 NM) horizontal separation if so determined in accordance with ATS.TR.215, unless increased longitudinal separation is required due to wake turbulence;

(k) the minimum horizontal separation to be provided diagonally between successive aircraft on adjacent final approach courses or tracks is:

- (1) 3.7 km (2.0 NM) between successive aircraft on adjacent final approach courses or tracks more than 2 529 m (8 300 ft) apart (See figure 53); or

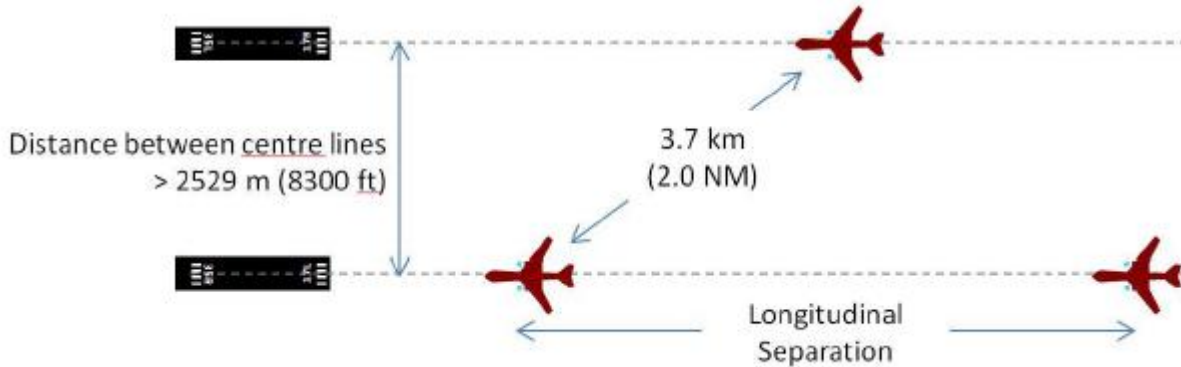

Figure 53: Diagonal separation for distance between centre lines greater than 2 529 m (8 300 ft)

- (2) 2.8 km (1.5 NM) between successive aircraft on adjacent final approach courses or tracks more than 1 097 m (3 600 ft) but not more than 2 529 m (8 300 ft) apart (see Figure 54); or

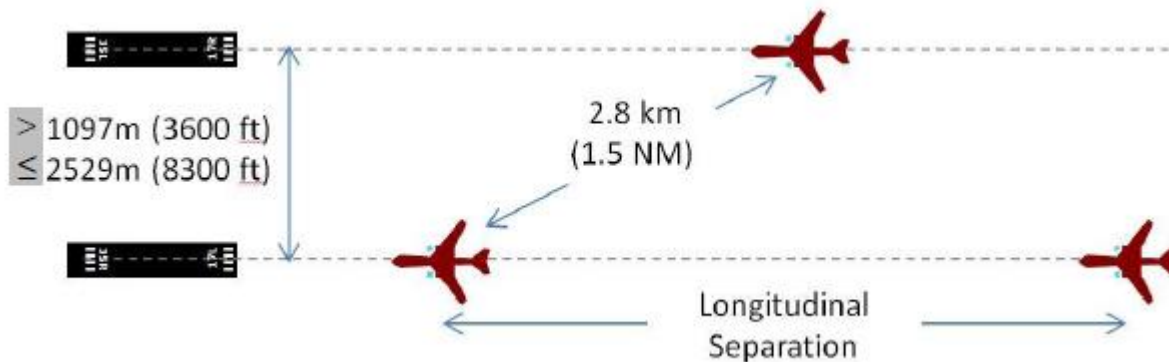

Figure 54: Diagonal separation for distance between centre lines greater than 1 097 m (3 600 ft) but less than or equal to 2 529 m (8 300 ft)

- (3) 1.9 km (1.0 NM) between successive aircraft on adjacent final approach courses or tracks more than 915 m (3 000 ft) but not more than 1 097 m (3 600 ft) apart (see Figure 55).

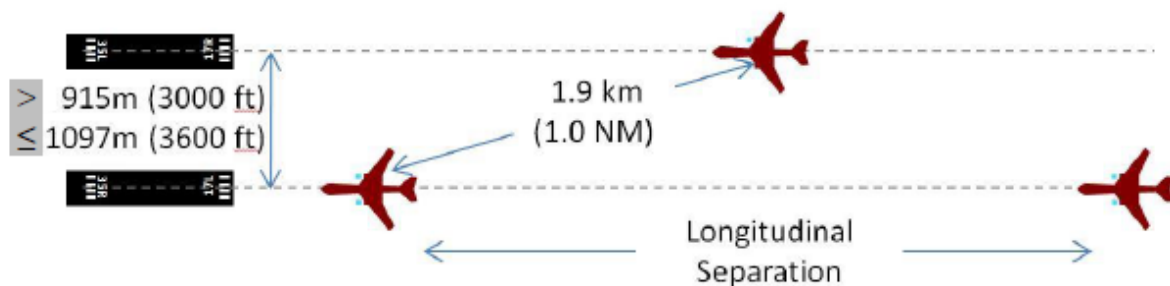

Figure 55: Diagonal separation for distance between centre lines greater than 915 m (3 000 ft) but less than or equal to 1 097 m (3 600 ft)

GM1 to AMC3 ATS.TR.255 Operations on parallel or near-parallel runways

PRECISION APPROACH PROCEDURES

With reference to point (e)(1) of AMC3 ATS.TR.255, the precision approach procedure that aligns the aircraft with the extended runway centre line may include one of the following: ILS, GLS, MLS or SBAS CAT I, when applicable, for the final approach segment.

GM2 to AMC3 ATS.TR.255 Operations on parallel or near-parallel runways

ATIS BROADCAST

With reference to point (f) of AMC3 ATS.TR.255, the information that dependent parallel operations are in force may be provided through the ATIS broadcasts.

AMC4 ATS.TR.255 Operations on parallel or near-parallel runways REQUIREMENTS AND PROCEDURES FOR SEGREGATED PARALLEL OPERATIONS

Segregated parallel operations should only be conducted on parallel runways when the following conditions are met:

- (a) the runway centre lines are spaced by a minimum of 760 m (2 500 ft) (see Figure 56). Such minimum may be decreased by 30 m for each 150 m that the arrival runway is staggered toward the arriving aircraft, to a minimum of 300 m (see Figure 57), and should be increased by 30 m for each 150 m that the arrival runway is staggered away from the arriving aircraft (see Figure 58);
- (b) the nominal departure track diverges immediately after take-off by at least 30 degrees from the missed approach track of the adjacent approach (see Figure 56);

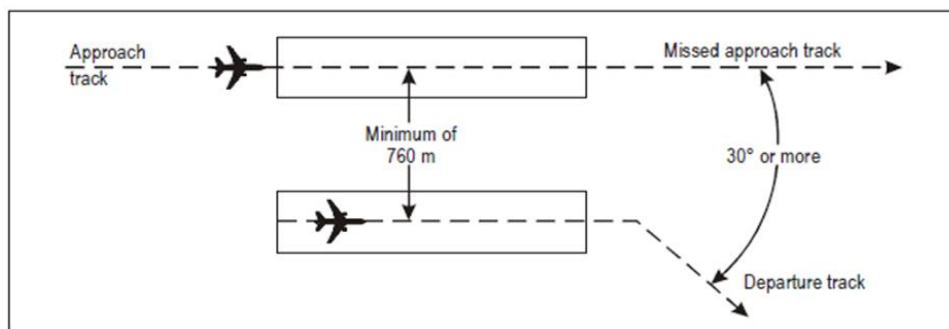

Figure 56: Segregated parallel operations

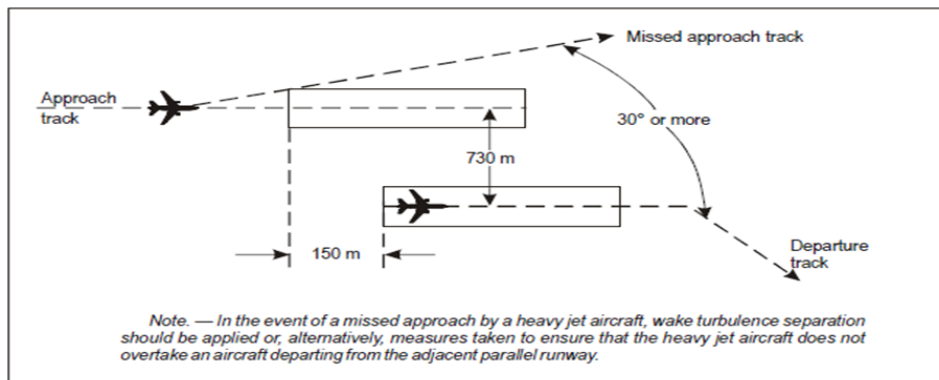

Figure 57: Segregated parallel operations where runways are staggered

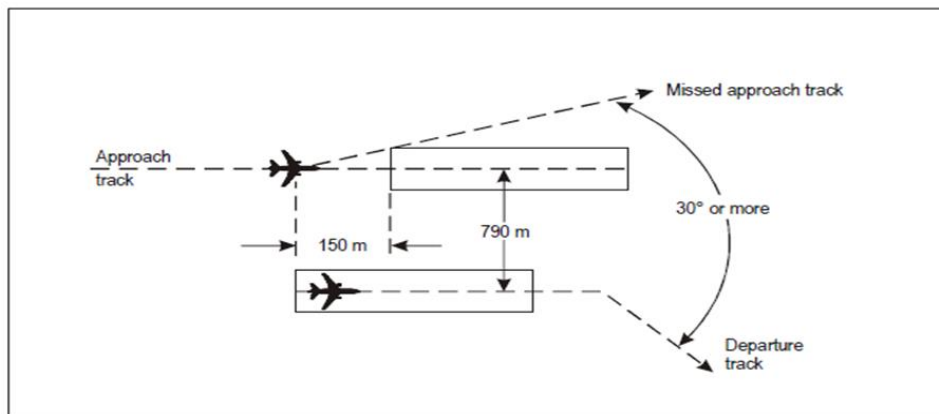

Figure 58: Segregated parallel operations where runways are staggered

- (c) the instrument flight procedure that aligns the aircraft with the extended runway centre line is one of the following:
- (1) precision approaches and/or APV (RNP AR APCH, RNP APCH);
 - (2) surveillance radar approach (SRA);
 - (3) visual approach; and
- (d) a suitable ATS surveillance system and the appropriate ground facilities conform to the standard necessary for the specific type of approach in point (c) above.

GM1 to AMC2 ATS.TR.255; AMC3 ATS.TR.255 and AMC4 ATS.TR.255 Operations on parallel or near-parallel runways DETERMINATION THAT AN AIRCRAFT IS ESTABLISHED ON RNP AR APCH

- (a) An aircraft conducting an RNP AR APCH procedure (in accordance with Regulation (EU) 2018/1048) is considered to be established for the entire approach procedure after the IAF or the IF, as applicable, provided that:
- (1) the aircraft confirms that it is established on the RNP AR APCH procedure prior to a designated point, the location of which is to be determined by the competent authority;
 - (2) the designated point is positioned on the RNP AR APCH to ensure the applicable horizontal separation minimum (e.g. 5.6 km (3 NM)) from the adjacent approach

procedure (see Figure 59). The designated point may normally be coincident with the IAF; and

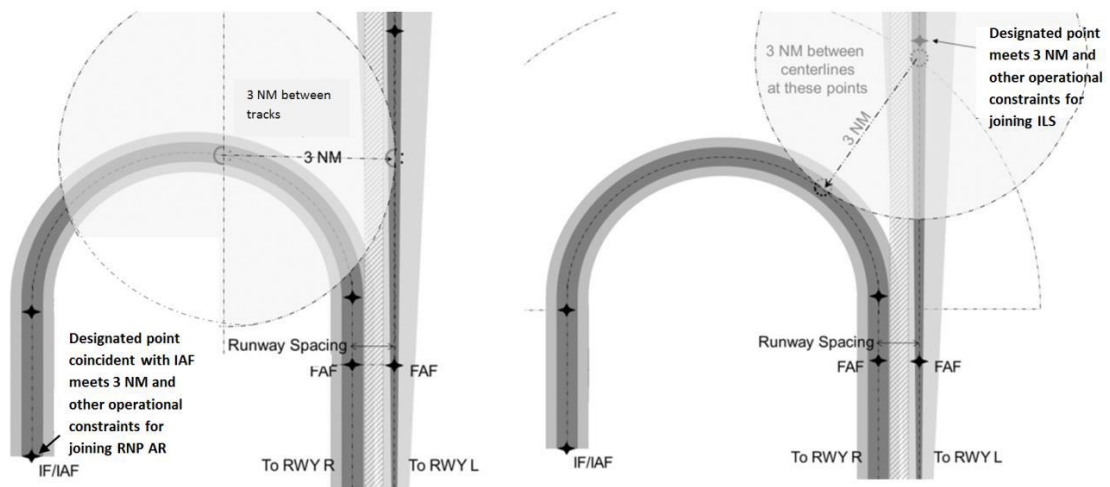

Figure 59: Established on RNP AR APCH concept

(RNP AR APCH/precision approach with 3 NM separation minimum example)

- (3) the designated point is readily apparent to the approach and monitoring air traffic controllers, to facilitate the application of the procedure. The designated point may be depicted on the situation display.
- (b) Attention is drawn to the application of the appropriate wake turbulence separation between aircraft on the same approach, as established in ATS.TR.220.
- (c) If, after reporting that it is established on the RNP AR APCH procedure, the aircraft is unable to execute the procedure, the pilot is expected to notify the air traffic controller immediately with a proposed course of action, and thereafter follow ATC instructions (e.g. break-out procedure).
- (d) In circumstances where a break-out procedure becomes necessary during the application of the independent parallel approach procedure (for example, an aircraft penetrating the NTZ), monitoring controllers may issue climb and/or heading instructions to an aircraft established on an RNP AR APCH. Guidance on break-out procedures is contained in ICAO Doc 9643 'Manual on Simultaneous Operations on Parallel or Near-Parallel Instrument Runways (SOIR)'.
- (e) To support a break-out instruction, an obstacle assessment is to be completed, in accordance with Regulation (EU) 2017/373. Guidance on obstacle assessment is contained in ICAO Doc 9643 'Manual on Simultaneous Operations on Parallel or Near-Parallel Instrument Runways (SOIR)'.
- (f) Where appropriate, break-out procedures are published in the AIP and in the local instructions.

GM1 ATS.TR.255 Operations on parallel or near-parallel runways

Guidance material relating to operations on parallel or near-parallel runways is contained in ICAO Doc 9643 'Manual on Simultaneous Operations on Parallel or Near-Parallel Instrument Runways (SOIR)'.

AMC1 ATS.TR.260(g) Selection of the runway-in-use

CONSIDERATION OF NOISE ABATEMENT IN THE SELECTION OF THE RUNWAY-IN-USE

- (a) The aerodrome control tower should select runways for noise abatement purposes for landing operations only when they are equipped with suitable glide path guidance, e.g. ILS, or a visual approach slope indicator system for operations in VMC.
- (b) Noise abatement should not be a determining factor in runway nomination under the following circumstances:
 - (1) if the runway surface conditions are adversely affected (e.g. by snow, slush, ice, water, mud, rubber, oil or other substances);
 - (2) for landing in conditions:
 - (i) when the ceiling is lower than 150 m (500 ft) above aerodrome elevation, or the visibility is less than 1 900 m; or
 - (ii) when the approach requires use of vertical minima greater than 100 m (300 ft) above aerodrome elevation and:
 - (A) the ceiling is lower than 240 m (800 ft) above aerodrome elevation; or
 - (B) the visibility is less than 3 000 m;
 - (3) for take-off when the visibility is less than 1 900 m;
 - (4) when wind shear has been reported or forecast or when thunderstorms are expected to affect the approach or departure; and
 - (5) when the crosswind component, including gusts, exceeds 28 km/h (15 kt), or the tailwind component, including gusts, exceeds 9 km/h (5 kt).

GM1 ATS.TR.260 Selection of the runway-in-use

- (a) Normally, an aircraft will land and take off into wind.
- (b) Departing aircraft may be expedited by suggesting a take-off direction which is not into the wind. It is the responsibility of the pilot-in-command of an aircraft to decide between making such a take-off or waiting for take-off in a preferred direction.

GM1 ATS.TR.260(e) Selection of the runway-in-use

DESCRIPTION OF AIR TRAFFIC CONDITIONS

When considering the air traffic conditions for the selection of the runway-in-use, the following elements, inter alia, should be evaluated:

- (a) traffic complexity;

- (b) traffic density;
- (c) task complexity; and
- (d) traffic typology (e.g. prevalent aircraft types operating at the aerodrome and preferred runway-in-use).

GM1 ATS.TR.265(a)(1) Control of aerodrome surface traffic in low-visibility conditions

HOLDING POSITION LIMITS

The definition of holding position limits by intermediate holding positions, stop bar or taxiway intersection marking is established in accordance with EASA ED Decision 2014/013/R 'Certification Specification and Guidance Material for Aerodrome Design', as amended.

AMC1 ATS.TR.265(b) Control of aerodrome surface traffic in low-visibility conditions

PROCEDURES FOR CONTROL OF AERODROME TRAFFIC IN LOW-VISIBILITY OPERATIONS (LVOs)

- (a) LVOs should be initiated by or through the aerodrome control tower.
- (b) The aerodrome control tower should inform the approach control unit concerned when procedures for precision approach in LVOs will be applied and also when such procedures are no longer in force.
- (c) Provisions regarding LVOs should specify:
 - (1) for the different types of LVOs, the RVR value(s) at which the LVOs procedures are to be implemented;
 - (2) the minimum navigation equipment requirements for LVOs;
 - (3) other facilities and aids required for LVOs, including aeronautical ground lights, which are to be monitored for normal operation;
 - (4) the criteria for and the circumstances under which downgrading of the navigation equipment from LVOs capability is to be made;
 - (5) the requirement to report any relevant equipment failure and degradation, without delay, to the flight crews concerned, the approach control unit, the aerodrome operator and, where established, the organisation(s) providing apron management services, and any other appropriate organisation;
 - (6) special procedures for the control of traffic on the manoeuvring area, including:
 - (i) the runway-holding positions to be used;
 - (ii) the minimum distance between an arriving and a departing aircraft to ensure protection of the sensitive and critical areas;
 - (iii) procedures to verify that aircraft and vehicles have vacated the runway; and
 - (iv) procedures applicable to the separation of aircraft and vehicles;

- (7) the applicable spacing between successive approaching aircraft;
 - (8) the action(s) to be taken in the event that LVOs need to be discontinued, e.g. due to equipment failures; and
 - (9) any other relevant procedures or requirements.
- (d) The aerodrome control tower should, prior to a period of application of low-visibility procedures, establish a record of vehicles and persons currently on the manoeuvring area and maintain this record during the period of application of these procedures to assist in assuring the safety of operations on that area.

GM1 ATS.TR.270 Authorisation of special VFR

SPECIAL VFR — DEVIATIONS

The list of type of operations subject to permit by the competent authority to deviate from the requirements for special VFR flights is not exhaustive. The competent authority may grant a permit for other kinds of helicopter operations such as power line inspections, helicopter hoist operations, etc.

GM1 ATS.TR.270(a)(3) Authorisation of special VFR

SPECIAL VFR IN CONTROL ZONES

When the reported ground visibility at the aerodrome is less than 1 500 m, air traffic control units may issue a special VFR clearance for a flight crossing the control zone and not intending to take off or land at an aerodrome within a control zone, or enter the aerodrome traffic zone or aerodrome traffic circuit when the flight visibility reported by the pilot is not less than 1 500 m, or, for helicopters, not less than 800 m.

GM1 ATS.TR.300(a)(2) Application

PROVISION OF FLIGHT INFORMATION SERVICE TO AIRCRAFT OTHERWISE KNOWN TO AIR TRAFFIC SERVICES

In the context of flight information service, the expression 'otherwise known to the relevant air traffic service unit' transposed from the Standard in Section 4.1 of ICAO Annex 11, covers the cases when the aircraft is operating within uncontrolled airspace, where there are no requirements for the submission of a flight plan or for a continuous air-ground two-way communication with the air traffic services unit in charge of providing services in that portion of airspace. Therefore, the expression may be interpreted as traffic, the current flight details and intentions of which are known to the air traffic controllers/FIS officer/AFIS officer.

GM1 ATS.TR.300(b) Application

It is recognised that in certain circumstances an aircraft on final approach, landing, take-off and climb may require to receive without delay essential information other than that pertaining to the air traffic control service provision.

AMC1 ATS.TR.300(c)(1) Application**RECORDING AND TRANSMISSION OF INFORMATION ON THE PROGRESS OF FLIGHTS**

Information on the actual progress of flights, including those of heavy or medium unmanned free balloons, under neither air traffic control service nor air traffic advisory service should be:

- (a) recorded by the air traffic services unit serving the FIR within which the aircraft is flying in such a manner that it is available for reference and in case it is requested for alerting service and search and rescue action; and
- (b) transmitted by the air traffic services unit receiving the information to other air traffic services units concerned, when so required for the purposes of the coordination between air traffic services units providing flight information service in adjacent FIRs in respect of IFR and VFR flights (see points (a) and (b) of GM2 ATS.TR.300(c)(2)).

GM1 to AMC1 ATS.TR.300(c)(1) Application**RECORDING AND TRANSMISSION OF INFORMATION ON THE PROGRESS OF FLIGHTS**

- (a) Information on the progress of flights, including flight plan data, may be recorded through the use of paper flight progress strips or electronic flight progress strips, by other electronic presentation forms or by a combination of presentation methods.
- (b) The air traffic services provider should specify the procedures for annotating data and provisions specifying the types of data to be entered on flight progress strips, including the use of symbols.

GM1 ATS.TR.300(c)(2) Application**INFORMATION EXCHANGE IN CASE OF TERMINATION OF A CONTROLLED FLIGHT**

In the case where a flight ceases to be operated as a controlled flight, i.e. by leaving controlled airspace or by cancelling its IFR flight and proceeding on VFR in airspace where VFR flights are not controlled, the air traffic control unit concerned should ensure that appropriate information on the flight is forwarded to air traffic services unit(s) responsible for the provision of flight information and alerting services for the remaining portion of the flight, in order to ensure that such services will be provided to the aircraft.

GM2 ATS.TR.300(c)(2) Application**COORDINATION IN RESPECT OF THE PROVISION OF FLIGHT INFORMATION SERVICE AND ALERTING SERVICE**

- (a) Coordination between air traffic services units providing flight information service in adjacent FIRs should be effected in respect of IFR and VFR flights, in order to ensure continued flight information service to such aircraft in specified areas or along specified routes. Such coordination should be effected in accordance with an agreement between the air traffic services units concerned.
- (b) The coordination of flights effected in accordance with point (a) should include transmission of the following information on the flight concerned:

- (1) appropriate items of the current flight plan; and
 - (2) the time at which last contact was made with the aircraft concerned.
- (c) This information should be forwarded to the air traffic services unit in charge of the next FIR in which the aircraft will operate prior to the aircraft entering such FIR.
- (d) In order to assist in the identification of strayed or unidentified aircraft and thereby eliminate or reduce the need for interception, flight plan and flight progress information for flights along specified routes or portions of routes in close proximity to FIR boundaries should also be provided to the air traffic services units in charge of the FIRs adjacent to such routes or portions of routes.
- (e) In circumstances where an aircraft has declared minimum fuel or is experiencing an emergency or in any other situation wherein the safety of the aircraft is not assured, the type of emergency and/or the circumstances experienced by the aircraft should be reported by the transferring unit to the accepting control unit and any other air traffic services unit that may be concerned with the flight and to the associated rescue coordination centres, if necessary.

AMC1 ATS.TR.305 Scope of flight information service

TRANSMISSION OF INFORMATION

(a) Means of transmission

- (1) Information should be disseminated to aircraft by one or more of the following means:
 - (i) the preferred method of directed transmission on the initiative of the appropriate air traffic services unit to an aircraft, ensuring that receipt is acknowledged; or
 - (ii) general call, unacknowledged transmission to all aircraft concerned; or
 - (iii) broadcast; or
 - (iv) data link.
- (2) The use of general calls should be limited to cases where it is necessary to disseminate essential information to several aircraft without delay, e.g. the sudden occurrence of hazards, a change of the runway-in-use, or the failure of a key approach and landing aid.

(b) Transmission of special air-reports, SIGMET and AIRMET information

- (1) Appropriate SIGMET and AIRMET information, as well as special air-reports which have not been used for the preparation of a SIGMET, should be disseminated to aircraft by one or more of the means specified in point (a) as established by the competent authority. Special air-reports should be transmitted with the least possible delay and disseminated to aircraft for a period of 60 minutes after their issuance.
- (2) The special air-report, SIGMET and AIRMET information to be passed on to aircraft on ground initiative should cover a portion of the route up to 1 hour's flying time ahead of the aircraft.

(c) Transmission of information concerning volcanic activity

Information concerning pre-eruption volcanic activity, volcanic eruptions and volcanic ash clouds (position of clouds and flight levels affected) should be disseminated to aircraft by one or more of the means specified in point (a) as established by the competent authority.

(d) Transmission of information concerning radioactive materials and toxic chemical clouds

Information on the release into the atmosphere of radioactive materials or toxic chemicals which could affect airspace within the area of responsibility of the air traffic services unit should be transmitted to aircraft by one or more of the means specified in point (a).

(e) Transmission of local special reports, SPECI and amended TAF

(1) Special reports and amended TAF should be transmitted on request and supplemented by:

(i) directed transmission from the appropriate air traffic services unit of selected special reports and amended TAF for the departure, destination and its alternate aerodromes, as listed in the flight plan; or

(ii) a general call on appropriate frequencies for the unacknowledged transmission to affected aircraft of selected special reports and amended TAF; or

(iii) continuous or frequent broadcast or the use of data link to make available current METAR and TAF in areas determined on the basis of regional air navigation agreements where traffic congestion dictates. VOLMET broadcasts and/or D-VOLMET should be used to serve this purpose.

(2) The passing of amended aerodrome forecasts to aircraft on the initiative of the appropriate air traffic services unit should be limited to that portion of the flight where the aircraft is within a specified time from the aerodrome of destination, such time being established on the basis of regional air navigation agreements.

(3) SPECI should, when issued for aerodromes not serving scheduled commercial air transport, be transmitted on request.

GM1 ATS.TR.305 Scope of flight information service**PRESENTATION OF INFORMATION FOR THE PROVISION OF FLIGHT INFORMATION SERVICE**

(4) The air traffic services provider should consider the manner in which data and information are provided to the FIS officer/AFIS officer, paying particular attention, where applicable, to the method of representing the air traffic situation to the FIS officer/AFIS officer and taking into account human performance. Additional guidance on human performance may be found in ICAO Doc 9683 'Human Factors Training Manual'.

(5) All information and data, including data related to individual aircraft, should be presented in a manner which minimises the potential for misinterpretation or misunderstanding.

(6) Where used, data generated automatically should be presented to the FIS officer/AFIS officer in a timely manner. The presentation of information and data for individual flights should

continue until such time as the data is no longer required for the purpose of providing flight information service, or until terminated by the FIS officer/AFIS officer.

(7) Information displays may be generated and updated automatically, or the data may be entered and updated by authorised personnel.

(f) Transmission of information on heavy or medium unmanned free balloons

Appropriate information on heavy or medium unmanned free balloons should be disseminated to aircraft by one or more of the means specified in point (a).

(g) Transmission of information to supersonic aircraft

The following information should be available at appropriate ACCs or flight information centres for aerodromes determined by the competent authority and should be transmitted on request to supersonic aircraft prior to commencement of deceleration/descent from supersonic cruise:

(1) current meteorological reports and forecasts, except that where communications difficulties are encountered under conditions of poor propagation, the elements transmitted may be limited to:

(i) mean surface wind, direction and speed (including gusts);

(ii) visibility or RVR;

(iii) amount and height of base of low clouds;

(iv) other significant information; and

(v) if appropriate, information regarding expected changes;

(2) operationally significant information on the status of facilities relating to the runway-in-use, including the precision approach category in the event that the lowest approach category promulgated for the runway is not available; and

(3) sufficient information on the runway surface conditions to permit assessment of the runway braking action.

AMC1 ATS.TR.305(a);(b) Scope of flight information service

INFORMATION FOR DEPARTING AIRCRAFT — METEOROLOGICAL CONDITIONS

Information regarding significant changes in the meteorological conditions in the take-off or climb-out area, obtained by the unit providing approach control service after a departing aircraft has established communication with such unit, should be transmitted to the aircraft without delay, except when it is known that the aircraft already has received the information.

GM1 to AMC1 ATS.TR.305(a);(b) Scope of flight information service

INFORMATION FOR DEPARTING AIRCRAFT — METEOROLOGICAL CONDITIONS

Significant changes in this context include those relating to surface wind direction or speed, visibility, RVR or air temperature (for turbine-engined aircraft), and the occurrence of thunderstorm or cumulonimbus, moderate or severe turbulence, wind shear, hail, moderate or severe icing, severe

squall line, freezing precipitation, severe mountain waves, sandstorm, dust storm, blowing snow, tornado or waterspout.

GM1 ATS.TR.305(a);(b);(c) Scope of flight information service

INFORMATION TO AIRCRAFT BY AFIS UNITS — AERODROME AND METEOROLOGICAL INFORMATION

- (a) Prior to taxiing for take-off, the AFIS unit should advise aircraft of the following elements of information, in the order listed, with the exception of such elements which are known to have been already received by the aircraft:
- (1) the runway-in-use;
 - (2) the surface wind direction and speed, including significant variations therefrom;
 - (3) the QNH altimeter setting and, either on a regular basis in accordance with local arrangements or if so requested by the aircraft, the QFE altimeter setting;
 - (4) the air temperature for the runway-in-use, in the case of turbine-engined aircraft;
 - (5) the visibility representative of the direction of take-off and initial climb, if less than 10 km, or, when applicable, the RVR value(s) for the runway-in-use; and
 - (6) the correct time.
- (b) Prior to take-off, the AFIS unit should advise aircraft of:
- (1) any significant changes in the surface wind direction and speed, the air temperature, and the visibility or RVR value(s) given in accordance with point (a); and
 - (2) significant meteorological conditions in the take-off and climb-out area, except when it is known that the information has already been received by the aircraft. 'Significant meteorological conditions' in this context include the occurrence or expected occurrence of cumulonimbus or thunderstorm, moderate or severe turbulence, wind shear, hail, moderate or severe icing, severe squall line, freezing precipitation, severe mountain waves, sandstorm, dust storm, blowing snow, tornado or waterspout in the take-off and climb-out area.

GM2 ATS.TR.305(a);(b);(c) Scope of flight information service

INFORMATION TO AIRCRAFT BY AFIS UNITS — INFORMATION FOR ARRIVING AIRCRAFT

- (a) Prior to entering the traffic circuit or commencing its approach to land, the AFIS unit should provide aircraft with the following elements of information, in the order listed, with the exception of such elements which are known to have been already received by the aircraft:
- (1) the runway-in-use;
 - (2) the surface wind direction and speed, including significant variations therefrom; and
 - (3) the QNH altimeter setting and, either on a regular basis in accordance with local arrangements or if so requested by the aircraft, the QFE altimeter setting.
- (b) For arriving IFR traffic that intends to conduct an instrument approach, the AFIS unit should, as early as practicable after an aircraft has established communication with the unit, transmit to

the aircraft the following elements of information, in the order listed, with the exception of such elements which are known to have been already received by the aircraft :

- (1) Runway-in-use; and
- (2) Meteorological information, as follows:
 - (i) surface wind direction and speed, including significant variations therein;
 - (ii) visibility and, when applicable, RVR;
 - (iii) present weather;
 - (iv) cloud below 1 500 m (5 000 ft) or below the highest minimum sector altitude, whichever is greater; cumulonimbus; if the sky is obscured, vertical visibility when available;
 - (v) air temperature;
 - (vi) dew point temperature, inclusion determined on the basis of a regional air navigation agreement;
 - (vii) altimeter setting(s);
 - (viii) any available information on significant meteorological phenomena in the approach area; and
 - (ix) trend-type landing forecast, when available.
- (c) For arriving IFR traffic conducting an instrument approach, at the commencement of final approach the AFIS unit should transmit the following information to the aircraft:
 - (1) significant variations in the mean surface wind direction and speed. 'Significant variations' are specified in point (a)(3) of MET.TR.205. However, if the AFIS unit transmits wind information in the form of components, the significant changes are:
 - (i) mean headwind component: 19 km/h (10 kt);
 - (ii) mean tailwind component: 4 km/h (2 kt); and
 - (iii) mean crosswind component: 9 km/h (5 kt);
 - (2) the latest information, if any, on wind shear and/or turbulence in the final approach area; and
 - (3) the current visibility representative of the direction of approach and landing or, when provided, the current RVR value(s) and the trend.
- (d) For arriving IFR traffic conducting an instrument approach, during the final approach the AFIS unit should transmit without delay the following information to the aircraft:
 - (1) the sudden occurrence of hazards (e.g. unauthorised traffic on the runway);
 - (2) significant variations in the current surface wind, expressed in terms of minimum and maximum values;
 - (3) significant changes in runway surface conditions;
 - (4) changes in the operational status of required visual or non-visual aids;

- (5) changes in observed RVR value(s), in accordance with the reported scale in use, or changes in the visibility representative of the direction of approach and landing.

GM3 ATS.TR.305(a);(b);(c) Scope of flight information service

TRAFFIC INFORMATION TO AIRCRAFT IN THE AFIS CONTEXT

The AFIS unit should provide the following information, as appropriate:

- (a) direction of flight of aircraft concerned;
- (b) type and wake turbulence category (if known) of aircraft concerned;
- (c) level of aircraft concerned, including possible changes;
- (d) relative bearing of the aircraft concerned in terms of the 12-hour clock as well as distance from the conflicting traffic; or
 - (1) actual or estimated position of the aircraft concerned; or
 - (2) estimated times; and
- (e) any other information considered relevant (e.g. approaching, crossing the flight information zone, estimated take-off or landing time).

GM4 ATS.TR.305(a);(b);(c) Scope of flight information service

LOCAL TRAFFIC INFORMATION TO AIRCRAFT IN THE AFIS CONTEXT

AFIS units should issue traffic information on local traffic in a timely manner, either directly or through the unit providing approach control service when, in the judgement of the AFIS unit, such information is necessary in the interest of safety, or when requested by aircraft. Local traffic should be described so as to be easily identified by the pilot.

GM5 ATS.TR.305(a);(b);(c) Scope of flight information service

WAKE TURBULENCE AND JET BLAST HAZARDS INFORMATION TO AIRCRAFT IN THE AFIS CONTEXT

- (a) The responsibility for wake turbulence avoidance rests entirely with the pilot-in-command. AFIS units should, to the extent practicable, advise aircraft of the expected occurrence of hazards caused by turbulent wake. Such information will be provided by the warning 'caution wake turbulence' and may also include relevant information on the aircraft concerned.
- (b) In providing information, AFIS units should take into account the hazards caused by jet blast, helicopter downwash turbulence and propeller slipstream to taxiing aircraft, to aircraft taking off or landing, particularly when intersecting runways are being used, and to vehicles and personnel operating on the aerodrome.

AMC1 ATS.TR.305(a)(5) Scope of flight information service

ESSENTIAL INFORMATION ON AERODROME CONDITIONS

Essential information on aerodrome conditions should be given to every aircraft, except when it is known that the aircraft has already received all or part of the information from other sources,

including NOTAM(s), ATIS broadcasts, and the display of suitable signals. The information should be given in sufficient time for the aircraft to make proper use of it, and the hazards should be identified as distinctly as possible.

GM1 to AMC1 ATS.TR.305(a)(5) Scope of flight information service

ESSENTIAL INFORMATION ON AERODROME CONDITIONS

- (a) Essential information on aerodrome conditions is information necessary to safety in the operation of aircraft, which pertains to the movement area or any facilities usually associated therewith. For example, construction work on a taxi strip not connected to the runway-in-use would not be essential information to any aircraft except one that might be taxied in the vicinity of the construction work. As another example, if all traffic must be confined to runways, that fact should be considered as essential aerodrome information to any aircraft not familiar with the aerodrome.
- (b) Essential information on aerodrome conditions should include information relating to the following:
- (1) construction or maintenance work on, or immediately adjacent to, the movement area;
 - (2) rough or broken surfaces on a runway, a taxiway or an apron, whether marked or not;
 - (3) water, snow, slush, ice or frost on a runway, a taxiway or an apron;
 - (4) anti-icing or de-icing liquid chemicals or other contaminants on a runway, taxiway or apron;
 - (5) other temporary hazards, including parked aircraft and birds on the ground or in the air;
 - (6) failure or irregular operation of part or all of the aerodrome lighting system; and
 - (7) any other pertinent information.
- (c) Up-to-date information on the conditions on aprons may not always be available to the aerodrome control tower or to the AFIS unit. The responsibility of the aerodrome control tower or the AFIS unit in relation to aprons is, with respect to the provision of information as described in points (a) and (b), limited to the transmission to aircraft of the information which is provided to it by the operator responsible for the aprons.

AMC2 ATS.TR.305(a)(5) Scope of flight information service

INFORMATION FOR DEPARTING AIRCRAFT — OPERATIONAL STATUS OF VISUAL AND NON-VISUAL AIDS

Information regarding changes in the operational status of visual or non-visual aids essential for take-off and climb should be transmitted without delay to a departing aircraft, except when it is known that the aircraft has already received the information.

GM1 ATS.TR.305(a)(6) Scope of flight information service**INFORMATION ON UNMANNED FREE BALLOONS**

- (a) On receipt of notification of the intended flight of a medium or heavy unmanned free balloon, the air traffic services unit should arrange for the information to be disseminated to all concerned. The information should include:
- (1) the balloon flight identification or project code name;
 - (2) balloon classification and description;
 - (3) SSR code or NDB frequency as applicable;
 - (4) the launch site;
 - (5) the estimated time of the commencement of the launch or the planned period of the launches;
 - (6) the expected direction of ascent;
 - (7) the cruising level(s) (pressure-altitude); and
 - (8) the estimated elapsed time to pass 18 000 m (60 000 ft) pressure-altitude, or to reach cruising level if at or below 18 000 m (60 000 ft), together with the estimated location.
- (b) On receipt of notification that a medium or heavy unmanned free balloon has been launched, the air traffic services unit should arrange for the information to be disseminated to all concerned. The information should include:
- (1) the balloon flight identification or project code name;
 - (2) balloon classification and description;
 - (3) SSR code or NDB frequency as applicable;
 - (4) the launch site;
 - (5) the time of launch(-es);
 - (6) the estimated time at which 18 000 m (60 000 ft) pressure-altitude will be passed, or the estimated time at which the cruising level will be reached if at or below 18 000 m (60 000 ft), and the estimated location;
 - (7) the estimated date and time of termination of the flight; and
 - (8) the planned location of ground contact, when applicable.
- (c) When there is reasonable expectation that a heavy or medium unmanned free balloon will cross international borders, the appropriate air traffic services unit should arrange for the pre-launch and the launch notifications to be sent by NOTAM to the air traffic services unit(s) in the State(s) concerned. If agreed between the States concerned, the launch notification may be transmitted orally by direct ATS speech circuit between the ACCs/flight information centres involved.

AMC1 ATS.TR.305(a)(7) Scope of flight information service**INFORMATION ON ABNORMAL AIRCRAFT CONFIGURATION AND CONDITION**

- (a) Whenever an abnormal configuration or condition of an aircraft, including conditions such as landing gear not extended or only partly extended, or unusual smoke emissions from any part of the aircraft, is observed by or reported to the aerodrome air traffic controller or the AFIS officer, the aircraft concerned should be advised without delay.
- (b) When requested by the flight crew of a departing aircraft suspecting damage to the aircraft, the departure runway used should be inspected without delay and the flight crew advised in the most expeditious manner as to whether any aircraft debris or bird or animal remains have been found or not.

GM1 ATS.TR.305(a)(8) Scope of flight information service**INFORMATION ON AIRSPACE RESERVATIONS AND RESTRICTIONS**

Flight information service should include the provision of relevant information on airspace restrictions and/or reservations, as also stipulated in Regulation (EC) No 2150/2005.

GM2 ATS.TR.305(a)(8) Scope of flight information service**INFORMATION ON SPACE WEATHER**

When available, information on space weather phenomena that have an impact on high-frequency radio communications, communications via satellite, GNSS-based navigation and surveillance systems, and/or pose a radiation risk to aircraft occupants at flight levels, within the area of responsibility of the air traffic services unit should be transmitted to the affected aircraft.

GM1 ATS.TR.305(b)(1) Scope of flight information service**INFORMATION RELATED TO WEATHER CONDITIONS AT DEPARTURE, DESTINATION, AND ALTERNATE AERODROMES**

Pilots normally obtain information on the weather conditions from the appropriate office before the flight. Outstanding or safety-relevant information is normally provided by radio communication when available.

GM1 ATS.TR.305(b)(2) and (c)(1) Scope of flight information service**INFORMATION CONCERNING COLLISION HAZARDS**

Information relating to collision hazards includes only known activities that constitute risks to the aircraft concerned. The availability of such information to air traffic services may sometimes be incomplete (e.g. limitations in radar or radio coverage, optional radio contact by pilots, limitations in the accuracy of reported information by pilots, or unconfirmed level of information) and, therefore, air traffic services cannot assume responsibility for its issuance at all times or for its accuracy.

GM2 ATS.TR.305(b)(2) Scope of flight information service**ATS SURVEILLANCE SERVICE — INFORMATION REGARDING TRAFFIC ON CONFLICTING PATH**

When an identified IFR flight operating outside controlled airspace is observed to be on a conflicting path with another aircraft, the pilot should, as far as practicable:

- (a) be informed as to the need for collision avoidance action to be initiated, and if so requested by the pilot or if, in the opinion of the air traffic controller, the FIS officer or the AFIS officer, the situation warrants, a course of avoiding action should be suggested; and
- (b) be notified when the conflict no longer exists.

GM1 ATS.TR.305(b)(4) Scope of flight information service**INFORMATION TO AIRCRAFT BY AFIS UNITS — START-UP TIME PROCEDURES**

- (a) Start-up time procedures should be implemented where necessary to avoid congestion and excessive delays on the manoeuvring area or when warranted by ATFM regulations. Start-up time procedures should be contained in local instructions, and should specify the criteria and conditions for determining when and how start-up times shall be calculated and issued to departing flights.
- (b) When an aircraft is subject to ATFM regulations, it should be advised to start up in accordance with its allocated slot time.

GM1 ATS.TR.305(c)(1) Scope of flight information service**RUNWAY INCURSION OR OBSTRUCTED RUNWAY**

In the event that the AFIS officer becomes aware of a runway incursion or the imminent occurrence thereof, or the existence of any obstruction on or in close proximity to the runway likely to impair the safety of an aircraft taking off or landing, appropriate action should be taken to inform the aircraft of the runway incursion or obstruction and its location in relation to the runway.

GM2 ATS.TR.305(c)(1) Scope of flight information service

AFIS officers should maintain a continuous watch on all flight operations on and in the vicinity of an aerodrome as well as on vehicles and personnel on the manoeuvring area in order to fulfil the task described in point (c)(1) of ATS.TR.305.

GM1 ATS.TR.305(c)(2) Scope of flight information service**RUNWAY-IN-USE AT AFIS AERODROMES**

- (a) Normally, an aircraft will land and take off into wind unless safety or other local factors determine that a different direction is preferable.
- (b) In considering the most suitable runway-in-use for take-off and landing of aircraft, besides surface wind speed and direction, other relevant factors should be taken into consideration such as:
 - (1) runway configuration;

- (2) meteorological conditions;
- (3) instrument approach procedures;
- (4) approach and landing aids available;
- (5) aerodrome traffic circuits;
- (6) airspace considerations;
- (7) length of runways; and
- (8) other factors indicated in local instructions.

(c) When AFIS officers provide information concerning the runway-in-use, it should be interpreted as a suggestion to the pilot on which would be the most suitable runway for take-off and landing, based on the information available. The decision on the selection and use of the runway is a responsibility of the pilot-in-command. A pilot-in-command can refuse a runway-in-use suggested by an AFIS officer. In such circumstances, AFIS officers should provide detailed information on other aerodrome traffic that is utilising the runway-in-use to assist the pilot in fulfilling their responsibilities under SERA.3205 of Regulation (EU) No 923/2012 when using an alternative runway.

GM1 ATS.TR.305(d)(3) Scope of flight information service

OTHER AIR TRAFFIC SERVICES UNITS CONCERNED

'Other air traffic services units concerned' are those that have flights under their jurisdiction which are expected to enter the airspace concerned at a later stage of flight. Those flights could, for instance, require rerouting before entering the airspace concerned. As an example, a special air-report concerning volcanic ash or volcanic eruption could be necessary to be transmitted to aircraft by air traffic services units in the FIR adjacent to that affected by that air-report.

GM1 ATS.TR.310 Voice-automatic terminal information service (Voice-ATIS) broadcasts

ATIS BROADCAST MESSAGES

The Voice-ATIS broadcast message should, whenever practicable, not exceed 30 seconds, care being taken that the readability of the ATIS message is not impaired by the speed of the transmission or by the identification signal of a navigation aid used for transmission of ATIS. The ATIS broadcast message should take into consideration human performance. Additional guidance on human performance may be found in ICAO Doc 9683 'Human Factors Training Manual'.

GM1 ATS.TR.310(f) Voice-automatic terminal information service (Voice-ATIS) broadcasts

ATIS BROADCAST CHANNELS

Where Voice-ATIS broadcasts are available in more than one language, a discrete channel should be used for each language.

GM1 ATS.TR.315 Data link-automatic terminal information service (D-ATIS)

Guidance material relating to D-ATIS is contained in ICAO Doc 9694 'Manual of Air Traffic Services Data Link Applications'.

GM1 ATS.TR.320 Automatic terminal information service (voice and/or data link)

CONTENTS OF ATIS MESSAGES

- (a) Contents of ATIS messages are established in SERA.9010 of Regulation (EU) No 923/2012, and more specifically:
 - (1) the elements of information of ATIS messages containing both arrival and departure information are specified in point (b) of SERA.9010, in the order listed.
 - (2) the elements of information ATIS messages containing arrival information only are specified in point (c) of SERA.9010, in the order listed; and
 - (3) the elements of information of ATIS messages containing departure information only are specified in point (d) of SERA.9010, in the order listed.
- (b) Contents of ATIS messages should be kept as brief as possible.
- (c) Information additional to that specified in SERA.9010 of Regulation (EU) No 923/2012, for example, information already available in AIPs and NOTAM, should only be included when justified in exceptional circumstances.

GM1 ATS.TR.325 VOLMET broadcasts and D-VOLMET broadcasts

VOLMET BROADCAST PHRASEOLOGIES

Guidance on standard radiotelephony phraseologies to be used in VOLMET broadcasts is available in ICAO Doc 9377 'Manual on Coordination between Air Traffic Services, Aeronautical Information Services and Aeronautical Meteorological Services', Appendix 1.

GM1 ATS.TR.400(a)(2) Application

INSTRUCTIONS ON ALERTING SERVICE PROVISION TO AIRCRAFT OTHERWISE KNOWN TO AIR TRAFFIC SERVICES UNITS

An air traffic services provider should ensure that appropriate instructions, approved by the competent authority, are provided to its air traffic services units regarding the provision of alerting service to aircraft 'otherwise known to the air traffic services'. Such instructions should include options for cases where radio contact is not mandatory and a voluntary radio-communication has been interrupted without proper termination of the contact. These instructions should clarify what kind of information may be used for providing alerting service to aircraft which have not filed a flight plan, based on the available technologies and local operational conditions (e.g. use of emergency transponder codes or declared emergency of available communication channels).

GM1 ATS.TR.400(b) Application**COORDINATION FOR ALERTING SERVICE**

- (a) When alerting service is required in respect of a flight operated through more than one FIR or control area, and when the position of the aircraft is in doubt, responsibility for coordinating such service should rest with the air traffic services unit of the FIR or control area:
- (1) within which the aircraft was flying at the time of last air-ground radio contact; or
 - (2) that the aircraft was about to enter when last air-ground contact was established at or close to the boundary of two FIRs or control areas; or
 - (3) within which the aircraft's intermediate stop or final destination point is located if the aircraft was not:
 - (i) equipped with suitable two-way radio communication equipment; or
 - (ii) under obligation to transmit position reports.
- (b) The unit responsible for alerting service, in accordance with point (a), should:
- (1) notify units providing alerting service in other affected FIRs or control areas of the emergency phase or phases, in addition to notifying the rescue coordination centre associated with it;
 - (2) request those units to assist in the search for any useful information pertaining to the aircraft presumed to be in an emergency, by all appropriate means and available communication facilities;
 - (3) collect the information gathered during each phase of the emergency and, after verifying it as necessary, transmit it to the rescue coordination centre; and
 - (4) announce the termination of the state of emergency as circumstances dictate.
- (c) In obtaining the necessary information as required under points (b) and (c) of ATS.TR.405, attention is to particularly be given to informing the relevant rescue coordination centre of the distress frequencies available to survivors. Said information is listed in Item 19 of the flight plan but not normally transmitted.

AMC1 ATS.TR.400(d) Application**ALERTING OF RESCUE AND FIREFIGHTING SERVICES**

Local instructions, as in point (d) of ATS.TR.400, should specify the type of information to be provided by the aerodrome control tower or approach control unit responsible or the relevant AFIS unit to the rescue and firefighting services, including type of aircraft and type of emergency and, when available, number of persons on board, and any dangerous goods carried on the aircraft.

GM1 ATS.TR.405(a)(1) Notification to rescue coordination centres**AIRCRAFT REPORT FOR THE PURPOSES OF UNCERTAINTY PHASE**

When no report from an aircraft has been received within a reasonable period of time (which may be a specified interval prescribed on the basis of regional air navigation agreements) after a scheduled or

expected reporting time, the air traffic services unit should, within the stipulated period of 30 minutes, endeavour to obtain such report in order to be in a position to apply the provisions relevant to the 'Uncertainty Phase' should circumstances warrant such application.

GM1 ATS.TR.405(a)(2)(ii) Notification to rescue coordination centres

MISSED AIRCRAFT REPORT — ACTIONS OF THE AERODROME CONTROL TOWER

When an aircraft fails to report after having been transferred to an aerodrome control tower, or, having once reported, ceases radio contact and in either case fails to land 5 minutes after the expected landing time, the same aerodrome control tower should, in accordance with point (c) of ATS.TR.400, report the situation to the approach control unit, ACC or flight information centre, or to the rescue coordination centre or rescue sub-centre.

GM1 ATS.TR.405(a)(2)(iii) Notification to rescue coordination centres

MISSED AIRCRAFT REPORT — ACTIONS OF THE AFIS UNIT

When an aircraft fails to report to or ceases radio contact with an AFIS unit under the circumstances established by the competent authority, the same AFIS unit should, in accordance with point (c) of ATS.TR.400, report the situation to the approach control unit, ACC or flight information centre, or to the rescue coordination centre or rescue sub-centre.

GM1 ATS.TR.405(c) Notification to rescue coordination centres

INFORMATION FOR THE PURPOSES OF ALERTING SERVICE

In case of missing information specified in point (b) of ATS.TR.405, the air traffic services units should clearly indicate to the rescue coordination centre the information not available at the time of the notification of the distress phase.

GM1 ATS.TR.405(d) Notification to rescue coordination centres

CANCELLATION OF ACTION(S) RELATED TO ALERTING SERVICE

The cancellation of action(s) initiated by the rescue coordination centre is the responsibility of that centre.

AMC1 ATS.TR.415 Plotting aircraft in a state of emergency

PLOTTING AIRCRAFT IN A STATE OF EMERGENCY WHERE ATS SURVEILLANCE SERVICES ARE PROVIDED

The progress of an aircraft in emergency should be monitored and (whenever possible) plotted on the situation display until the aircraft passes out of coverage of the ATS surveillance system, and position information should be provided to all air traffic services units which may be able to give assistance to the aircraft. Transfer to adjacent sectors should also be effected when appropriate.