

European Union Aviation Safety Agency

Certification Specifications and Acceptable Means of Compliance

for

Airborne Communications, Navigation and Surveillance

CS-ACNS

Issue 2

26 April 2019¹

¹ For the date of entry into force of this Amendment, kindly refer to Decision 2019/011/R in the [Official Publication](#) of the Agency.

CONTENTS

CS ACNS — Airborne Communications, Navigation and Surveillance

BOOK 1

Subpart A — General.....4
Subpart B — Communications (COM) 12
Subpart C — Navigation (NAV)22
Subpart D — Surveillance (SUR).....49
Subpart E — Others.....62

BOOK 2

Subpart A — General.....72
Subpart B — Communications (COM) 74
Subpart C — Navigation (NAV) 93
Subpart D — Surveillance (SUR)..... 151
Subpart E — Others.....230

CS-ACNS

Book 1

Certification Specifications

Subpart A — General

CS ACNS.A.GEN.001 Applicability

These certification specifications are intended to be applicable to aircraft for the purpose of complying with the communications, navigation and surveillance carriage requirements.

Compliance with the relevant sections of CS-ACNS ensures compliance with the following European regulations:

- (a) Commission Regulation (EU) No 965/2012 of 5 October 2012 laying down technical requirements and administrative procedures related to air operations pursuant to Regulation (EC) No 216/2008 of the European Parliament and of the Council;
- (b) Commission Implementing Regulation (EU) No 1207/2011, of 22 November 2011 laying down requirements for the performance and the interoperability for surveillance for the single European sky;
- (c) Commission Implementing Regulation (EU) No 1206/2011, of 22 November 2011 laying down requirements on aircraft identification for surveillance for the single European sky;
- (d) Commission Regulation (EC) No 29/2009 of 16 January 2009 laying down requirements on data link services for the single European sky;
- (e) Commission Implementing Regulation (EU) No 1079/2012 of 16 November 2012 laying down requirements for voice channels spacing for the single European sky.

[Issue: CS-ACNS/2]

CS ACNS.A.GEN.005 Definitions

This point contains the definitions of terms used in CS-ACNS:

Accuracy is, in the context of PBN operations, the degree of conformance between the estimated, measured or desired position and/or the velocity of a platform at a given time, and its true position or velocity.

ADS-B refers to automatic dependent surveillance - broadcast, a surveillance technique in which aircraft automatically provide, via a data link, data derived from on-board navigation and position-fixing systems. It refers to a surveillance technology where ADS-B Out equipped aircraft broadcast position, altitude, velocity, and other information in support of both air-to-ground and air-to-air surveillance applications.

ADS-B device failure refers to a condition announced to the flight crew whereby the ADS-B transmit unit is unable to transmit ADS-B messages.

ADS-B function failure refers to a condition announced to the flight crew whereby the position source(s) or interconnecting avionics fail to provide horizontal position data to the ADS-B transmit unit.

ADS-B Out system refers to the overall set of avionics that generate, transport, process, and transmit ADS-B data.

ADS-B transmit unit refers to that part of the ADS-B Out system that resides within the transponder and transmits 1090 MHz ES ADS-B data, including the data processing within that system.

Advisory alerts refers to the level or category of alert for conditions that require flight crew awareness and may require subsequent flight crew response.

Advisory vertical navigation ('Advisory VNAV') is an area navigation system function guiding the aircraft on a vertical path calculated by the area navigation system on an approach procedure that has been designed as a 2D procedure.

Aircraft Identification is an alphanumeric chain that contains information allowing operational identification of individual flights. It contains either the Aircraft Identification as registered in item 7 of the flight plan or the aircraft registration if no flight plan has been filed.

Airship is a power-driven lighter-than-air aircraft.

Alert is a generic term used to describe a flight deck indication meant to attract the attention of and identify to the flight crew a non-normal operational or aeroplane system condition. Alerts are classified at levels or categories corresponding to Warning, Caution, and Advisory. Alert indications also include non-normal range markings (for example, exceedances on instruments and gauges).

Altimetry system error (ASE) refers to the difference between the altitude indicated by the altimeter display, assuming a correct altimeter barometric setting, and the pressure altitude corresponding to the undisturbed ambient pressure.

Area navigation (RNAV) is a method of navigation which permits aircraft operation on any desired flight path within the coverage of ground or space-based navigation aids or within the limits of the capability of self-contained aids, or a combination of these.

Aircraft-based augmentation system (ABAS) is an augmentation system that augments and/or integrates the information obtained from the GNSS core constellation elements with other information available on board the aircraft.

ATN B1 refers to Aeronautical Telecommunication Network Build 1.

ATS communications management service (ACM) is a service that provides automated assistance to flight crews and air traffic controllers for conducting the transfer of ATC communications (voice and data).

ATS clearance and information service (ACL) is a service that provides flight crews and controllers with the ability to conduct operational exchanges.

ATS microphone check service (AMC) is a service that provides air traffic controllers with the capability to send an instruction to one or several data link equipped aircraft, at the same time, in order to instruct flight crew(s) to verify that his/their voice communication equipment is not blocking a given voice channel.

Aural alert is a discrete sound, tone, or verbal statement used to annunciate a condition, situation, or event.

Automatic altitude control system is any system that is designed to automatically control the aircraft to a referenced pressure altitude

Barometric Altitude Rate refers to the rate of climb estimated by using the difference of pressure.

Barometric Pressure Setting is the barometric pressure setting used by the pilot when flying the aircraft.

Comm-B refers to a 112-bit Mode S reply containing a 56-bit MB message field containing the extracted transponder register.

Caution refers to the level or category of alert for conditions that require immediate flight crew awareness and a less urgent subsequent flight crew response than a warning alert.

Continuity of function refers, in the context of PBN operations, to the capability of the system to perform its intended function without unscheduled interruptions.

Continuity (system continuity) is the probability that a system will perform its required function without unscheduled interruption, assuming that the system is available at the initiation of the intended operation.

Controlled flight into terrain (CFIT) is an accident or incident in which an aircraft, under the full control of the pilot, is flown into terrain, obstacles, or water.

CPDLC is the ICAO standardised procedure for Controller-Pilot Data Link Communications. CPDLC takes the form of an application, present on both aircraft and ground-based ATC centres that provides support for the data link communications initiation capability (DLIC), ATS communications management service (ACM), ATS clearance and information service (ACL) and ATS microphone check service (AMC).

Data link is a communication technology where 'data link' equipped aircraft communicate with 'data link' capable ground units to exchange digital information (bi-directional exchange).

Data link communications initiation capability (DLIC) is a service that enables the exchange of the necessary information for the establishment of data link communications between the ground and aircraft data link systems.

Data quality indicator refers to integrity and/or accuracy quality metrics that are associated with some of the ADS-B Out surveillance data, in particular with the horizontal position.

Defined path is the output of the path definition function of the RNP system.

Desired path is the path that the flight crew and air traffic control can expect the aircraft to fly, given a particular route leg or transition.

Distance-measuring equipment (DME) refers to a ground-airborne positioning system based on interrogations from an airborne interrogator and replies from a ground-based transponder that allows the aircraft to measure its slant range from the position of the ground-based DME transponder.

Downlink is a transfer of information, generated by an aircraft (not necessarily airborne) and sent to the ground for further processing by an ATC Centre.

Emergency indicators refers to specific Mode A Code values: 7500 unlawful interference, 7600 radio failure, 7700 general emergency.

Failure condition terms are defined in AMC 25.1309, FAA AC 23.1309-1(), AC 27-1B or AC 29-2C.

FANS 1/A refers to Future Air Navigation System 1 or Future Air Navigation System A.

False alert is an incorrect or spurious alert caused by a failure of the alerting system including the sensor.

Field of view refers to either the optimum or maximum vertical and horizontal visual fields from the design eye reference point that can be accommodated with eye rotation only, as described in the figure below.

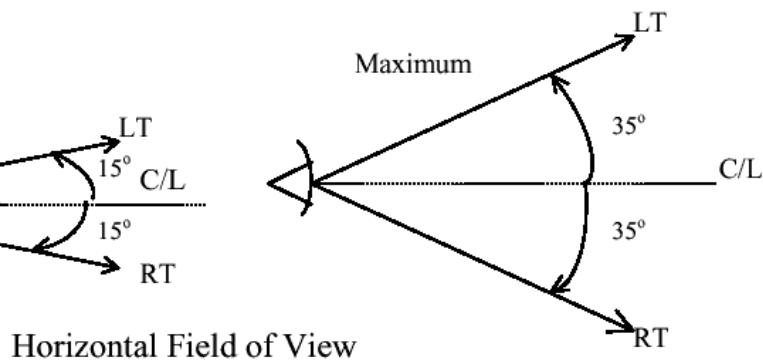
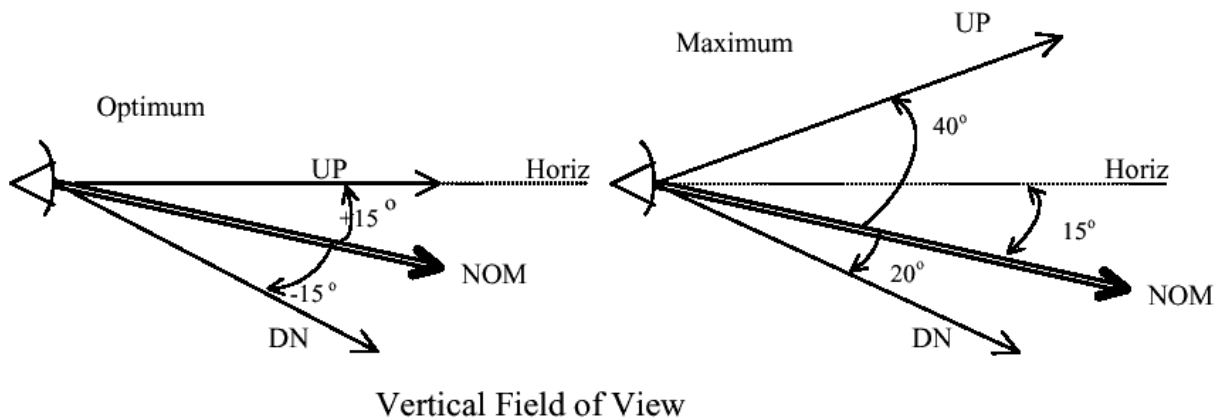

Optimum and maximum fields of view

Flight plan is, in the context of PBN operations, a set of route segments and flight procedures defined and activated by the flight crew in the RNP system, relative to an intended flight or portion of a flight of an aircraft.

FMS Selected Altitude refers to the level altitude used by the FMS to manage the vertical profile of the aircraft.

Forward looking terrain avoidance (FLTA) looks ahead of the aeroplane along and below the aeroplane's lateral and vertical flight path and provides suitable alerts if a potential CFIT exists.

Global Navigation Satellite System (GNSS) refers to a worldwide position and time determination system that includes one or more satellite constellations, aircraft receivers and system integrity monitoring.

Ground-initiated Comm-B refers to a protocol which allows the interrogator to extract Comm-B replies containing data from a defined source.

Ground speed is the speed of an aircraft relative to the surface, or relative to a horizontal plane at present position.

Group aircraft is a group of aircraft with similar altitude keeping equipment configurations and performance characteristics that are combined together for the purposes of statistical generic performance

evaluation. Typically group aircraft refers to aircraft constructed to the same Type Certificate, Service Bulletin or Supplementary Type Certificate.

Hazard refers to a state or set of conditions that together with other conditions in the environment can lead to an accident.

Holding is a predetermined manoeuvre which keeps an aircraft within a specified airspace.

Horizontal velocity refers to the ground speed vector information.

ICAO 24-bit aircraft address is a technical address used by Mode S protocols to identify the transponder on the 1030/1090 MHz RF network. Each aircraft uses a unique 24-bit aircraft address allocated by their state of registry. This address may also be used by other types of avionics equipment for other purpose.

Inertial navigation system/inertial reference unit (INS/IRU) is an aircraft position sensor relying on accelerometers and gyroscopes to estimate position, direction and velocity.

Inertial vertical velocity is the rate of climb measure along the axis estimated using different sources including inertial reference.

Instrument landing system (ILS) is a system using ground-based transmitters and airborne receivers to provide lateral ('localiser') and vertical ('glide slope') guidance to the runway.

Integrity (system integrity) is measured as the probability per operating hour of an undetected failure of a functional element that results in corrupted (erroneous) data, or a failure in the processing as specified, leading to the (partial) loss of otherwise available data.

Lateral navigation (LNAV) refers to area navigation in the horizontal plane.

Magnetic Heading is the angle between the aircraft centreline and magnetic North (angle between the direction to which the aircraft nose is pointing and the magnetic North).

MCP/FCU Selected Altitude is the level selected by the flight crew on the MCP or FCU of the aircraft. This altitude constitutes the level-off target input to the auto-pilot.

Mean sea level (MSL) is a reference for measuring and specifying altitudes in aeronautical information.

Mode S Elementary Surveillance refers to the use of Mode S surveillance data to downlink aircraft information from airborne installations.

Mode S Enhanced Surveillance refers to the use of other airborne information in addition to data used for Elementary Surveillance.

Navigation aid refers to a space- or ground-based facility that transmits signals that the aircraft's navigation system may use to determine its position or its bearing.

Navigation functionality is the detailed capability of the navigation system required to meet the needs of the proposed operations in the airspace.

Navigation specification is a set of aircraft and aircrew requirements needed to support performance-based navigation operations within a defined airspace.

Non-group aircraft refers to an aircraft that is not a group aircraft but which is submitted for airworthiness approval on the characteristics of the unique airframe

Nuisance alert is an alert generated by a system that is functioning as designed but which is inappropriate or unnecessary for the particular condition.

Performance-based navigation (PBN) is area navigation based on performance requirements for aircraft operating along an ATS route, on an instrument approach procedure or in designated airspace.

Qualitative probability terms are defined in AMC 25.1309, FAA AC 23.1309-1(), AC 27-1B or AC 29-2C.

Required obstacle clearance (ROC) refers to the required vertical clearance expressed in feet between an aircraft and an obstruction.

Required Terrain Clearance (RTC) is a Terrain Awareness and Warning System (TAWS) FLTA mode that alerts when the aeroplane is above the terrain in the aeroplane's projected flight path, but the projected amount of terrain clearance is considered unsafe for the particular phase of flight.

RNAV (X) specification refers to a navigation specification based on area navigation that does not include the requirement for on-board performance monitoring and alerting, designated by the prefix RNAV, where 'X' refers to the lateral navigation accuracy in nautical miles.

RNP (X) specification refers to a navigation specification based on area navigation that includes the requirement for on-board performance monitoring and alerting, designated by the prefix RNP, where 'X' refers to the lateral navigation accuracy in nautical miles or the operation type.

RNP system is a system that supports area navigation operations by integrating information from one or more positioning sensors and providing flight crew with the means to define a desired flight path.

Roll Angle is the angle of wings compared to horizon representing the angle of rotation around the roll axis going along the centreline of the aircraft

RVSM flight envelope may be considered to be in two parts; the basic RVSM flight envelope and the full RVSM flight envelope. The basic envelope includes those ranges of Mach numbers and gross weights at which the aircraft can most frequently be expected to operate at RVSM levels (i.e. FL 290 to FL 410 (or maximum attainable altitude)). The full envelope refers to the entire range of Mach numbers, gross weights and altitude values that the aircraft can be operated in RVSM airspace.

RVSM operational flight envelope is the Mach number, W/δ , and altitude ranges over which an aircraft can be operated in cruising flight within the RVSM airspace.

Satellite-based augmentation system (SBAS) is a wide coverage augmentation system which monitors the GNSS core constellation(s) and provides the user with augmentation information through a satellite-based transmitter.

Search volume is a volume of airspace around the aeroplane's current and projected path that is used to define a TAWS alert condition.

Static Source Error (SSE) is the difference between the pressure sensed by the static system at the static port and the undisturbed ambient pressure.

Static Source Error Correction (SSEC) is the correction for the residual static error to ensure compliance with performance requirements.

Terrain cell is a grid of terrain provided by the TAWS database which identifies the highest terrain elevation within a defined geographical area. Terrain cell dimensions and resolution can vary depending on the needs of the TAWS system and availability of data. If a supplier desires, obstacle height can be included in the terrain elevation.

Track is the projection on the earth's surface of the path of an aircraft, the direction of which is usually expressed in degrees from north (true, magnetic or grid).

Track Angle Rate is the rate of change of the track angle.

Transmit refers to the provision of surveillance data by the transponder.

Transponder is a device that transmits airborne surveillance data spontaneously or when requested. The transmissions are performed on 1090 MHz RF band and the interrogations are received on 1030 MHz RF band using SSR/Mode S protocols. It is also named Secondary Surveillance Radar transponder.

Transponder level is an indication of which Mode S data-link protocols are supported by a transponder. There are 5 transponder levels defined by ICAO.

Transponder register is a transponder data buffer containing different pieces of information. It has 56 bits which are split in different fields. The definition of the transponder registers can be found in ICAO Doc 9871 edition 2 and in transponder MOPS ED-73E with the ICAO document being the reference document in case of conflict. Transponder registers are numbered in hexadecimal (00hex to FFhex). The register number is also known as the BDS code (Comm-B data selector). In this documentation a register is named: register XY₁₆ or register addressed by BDS code X,Y. Outside this document, it is also often referenced as just BDS X,Y.

True Track Angle is the angle between the track (course over ground or path) of the aircraft and true north.

Uplink is a transfer of information, issued from any ground-based entity (typically: the ATC Centre under which the aircraft is under responsibility) to an aircraft (not necessarily airborne).

Vertical navigation (VNAV) refers to a method of navigation based on a computed vertical path.

VHF omnidirectional range (VOR) is a ground–airborne positioning system based on signals in space transmitted by the VOR ground station to the aircraft VOR receiver to measure its angular position from the ground station.

Warning refers to the level or category of alert for conditions that require immediate flight crew awareness and immediate flight crew response.

Worst case avionics is a combination of tolerance values, specified by the aircraft constructor for the altimetry fit into the aircraft, which gives the largest combined absolute value for residual SSE plus avionics errors.

[Issue: CS-ACNS/2]

CS ACNS.A.GEN.010 Instructions for continued airworthiness

(See AMC1 ACNS.A.GEN.010)

Instructions for continued airworthiness for each system, part or appliance as specified in this CS ACNS and any information related to the interface of those systems, parts or appliances with the aircraft are to be provided.

CS ACNS.A.GEN.015 Aircraft documentation

- (a) The aircraft flight manual (AFM), or similar documentation approved by EASA, provides the list of aircraft capabilities for which the aircraft is certified in accordance with this CS.
- (b) If there are deviations from this CS which result in limitation(s), they are to be clearly stated in the AFM or similar documentation approved by EASA.

[Issue: CS-ACNS/2]

CS ACNS.A.GEN.020 Deviation from equipment standards

Any deviations from the ETSO referenced in this CS and associated AMC are to be evaluated to ensure compliance with the CS requirements.

[Issue: CS-ACNS/2]

Subpart B — Communications (COM)

SECTION 1 – VOICE CHANNEL SPACING (VCS)

General

CS ACNS.B.VCS.001 Applicability

The section provides standards for aircraft voice communication systems operating in the band 117,975-137 MHz.

System functional requirements

CS ACNS.B.VCS.010 Voice Communication System

(See AMC1 ACNS.B.VCS.010)

- (a) The voice communication system is capable of 8.33 kHz and 25 kHz channel spacing
- (b) Voice communication system is capable of operating with off-set carrier frequencies on 25 kHz channel spacing.

System performance requirements

CS ACNS.B.VCS.020 Performance Requirements

The voice communication system conforms to the performance requirements of the following sections of ICAO Annex 10, Volume III, Part 2 (Second Edition — July 2007 incorporating Amendment No 90) Chapter 2 'Aeronautical Mobile Service':

- (a) Section 2.1 'Air-ground VHF communication system characteristics'.
- (b) Section 2.2 'System characteristics of the ground installations'.
- (c) Section 2.3.1 'Transmitting function'.
- (d) Section 2.3.2 'Receiving function' excluding sub-section 2.3.2.8 'VDL — Interference Immunity Performance'.

[Issue: CS-ACNS/2]

CS ACNS.B.VCS.025 Integrity

The voice communication systems is designed commensurate with a 'major' failure condition.

CS ACNS.B.VCS.030 Continuity

(See AMC1 ACNS.B.VCS.030 and GM1 ACNS.B.VCS.030)

The voice communication system, including radio, controls, and antenna(s), is designed to provide a level of continuity that supports the intended operation.

[Issue: CS-ACNS/2]

Installation requirements

CS ACNS.B.VCS.040 Flight Deck Interface

(See AMC1 ACNS.B.VCS.040)

A means is provided to:

- (a) select the voice communications channel;
- (b) display the selected voice communications channel to the flight crew;
- (c) indicate the non-operational status or failure of the system without undue delay;

SECTION 2 –DATA LINK SERVICES (DLS)

General

CS ACNS.B.DLS.B1.001 Applicability

(See GM1 ACNS.B.DLS.B1.001)

This section provides the airworthiness standard for ATN B1 with VDL Mode 2 data link aircraft systems to be installed on aircraft intended to be used for CPDLC Communications.

CS ACNS.B.DLS.B1.005 Installation Requirements

(See AMC1 ACNS.B.DLS.B1.005)

The data link system includes a means to enable data communication and flight deck annunciations and controls.

Flight deck control and indication capabilities

CS ACNS.B.DLS.B1.010 Flight Deck Interface

(See AMC1 ACNS.B.DLS.B1.010)

- (a) A means is provided:
- (1) to inform clearly and unambiguously when uplinked messages are received;
 - (2) for the flight crew to initiate the data link services;
 - (3) for the flight crew to know in real time the identifier of the ATS provider(s) connecting with the aircraft;
 - (4) to display all messages, with minimal flight crew action, in a format that is easy to comprehend and distinguishable from each other;
 - (5) for the flight crew to respond to ATS messages;
 - (6) to inform the flight crew that pending or open messages are waiting for a response;
 - (7) for the flight crew to determine the status of the data link system;
- (b) A means is provided to prohibit the deletion, confirmation, or clearance of a message until the entire message is displayed.

CS ACNS.B.DLS.B1.015 Dual Data Link Capabilities (Dual stack)

(See AMC1 ACNS.B.DLS.B1.015)

For aircraft integrating both FANS 1/A and ATN B1 CPDLC applications:

- (a) Control and display: Messages with the same intent that are transmitted or received through these technologies are displayed in the same way.
- (b) Alerting: Where a common alerting is not demonstrable, a mean is provided to distinguish between the alerting scheme in a format that is easy to comprehend.

ATN B1 data link

CS ACNS.B.DLS.B1.020 Data Link Services

(See AMC1 ACNS.B.DLS.B1.020 and GM1 ACNS.B.DLS.B1.020)

The data link system provides the following services:

- (a) Data Link Initiation Capability (DLIC);
- (b) ATC Communications Management (ACM);
- (c) ATC Clearances and Information (ACL); and
- (d) ATC Microphone Check (AMC).

CS ACNS.B.DLS.B1.025 Protection mechanism

(See AMC1 ACNS.B.DLS.B1.025, AMC2 ACNS.B.DLS.B1.025, AMC3 ACNS.B.DLS.B1.025, GM1 ACNS.B.DLS.B1.025, GM2 ACNS.B.DLS.B1.025 and GM3 ACNS.B.DLS.B1.025)

A means is provided to protect the integrity of the message.

System performance requirements

CS ACNS.B.DLS.B1.030 Integrity

The data link system integrity is designed commensurate with a 'major' failure condition.

CS ACNS.DLS.B1.035 Continuity

The data link system continuity is designed to an allowable qualitative probability of 'probable'.

Time

CS ACNS.B.DLS.B1.040 Universal Time Coordinated (UTC)

(See AMC1 ACNS.B.DLS.B1.040)

For time synchronisation a valid UTC time source is used.

Data link initiation capability (DLIC) service messages

CS ACNS.B.DLS.B1.050 DLIC Uplink Messages

(See AMC1 ACNS.B.DLS.B1.050)

The data link system is capable of receiving and processing the following messages for the DLIC logon and contact functions:

Function	Message
Logon	CMLogonResponse
Contact	CMContactRequest

CS ACNS.B.DLS.B1.055 DLIC Downlink Messages

(See AMC1 ACNS.B.DLS.B1.055)

The data link system is capable of sending the following messages for the DLIC logon and contact functions:

Function	Message
Logon	CMLogonRequest
Contact	CMContactResponse

CS ACNS.DLS.B.B1.060 DLIC Initiation when in CPDLC Inhibited State (Uplink)

When the data link system is in the ‘CPDLC inhibited’ state, DLIC Contact Request is processed but the system is remaining in the ‘CPDLC inhibited’ state.

CPDLC Messages

CS ACNS.B.DLS.B1.070 CPDLC Uplink Messages

(See AMC1 ACNS.B.DLS.B1.070, AMC2 ACNS.B.DLS.B1.070, GM1 ACNS.B.DLS.B1.070 and GM2 ACNS.B.DLS.B1.070)

The data link system is capable of receiving, processing and displaying the following message elements:

ID	Message
UM0	UNABLE
UM1	STANDBY
UM3	ROGER
UM4	AFFIRM
UM5	NEGATIVE
UM19	MAINTAIN [level]
UM20	CLIMB TO [level]
UM23	DESCEND TO [level]
UM26	CLIMB TO REACH [level] BY [time]
UM27	CLIMB TO REACH [level] BY [position]
UM28	DESCEND TO REACH [level] BY [time]
UM29	DESCEND TO REACH [level] BY [position]

ID	Message
UM46	CROSS [position] AT [level]
UM47	CROSS [position] AT OR ABOVE [level]
UM48	CROSS [position] AT OR BELOW [level]
UM51	CROSS [position] AT [time]
UM52	CROSS [position] AT OR BEFORE [time]
UM53	CROSS [position] AT OR AFTER [time]
UM54	CROSS [position] BETWEEN [time] AND [time]
UM55	CROSS [position] AT [speed]
UM61	CROSS [position] AT AND MAINTAIN
UM64	OFFSET [specifiedDistance] [direction] OF ROUTE
UM72	RESUME OWN NAVIGATION
UM74	PROCEED DIRECT TO [position]
UM79	CLEARED TO [position] VIA [routeClearance]
UM80	CLEARED [routeClearance]
UM82	CLEARED TO DEVIATE UP TO [specifiedDistance] [direction] OF ROUTE
UM92	HOLD AT [position] AS PUBLISHED MAINTAIN [level]
UM94	TURN [direction] HEADING [degrees]
UM96	CONTINUE PRESENT HEADING
UM106	MAINTAIN [speed]
UM107	MAINTAIN PRESENT SPEED
UM108	MAINTAIN [speed] OR GREATER
UM109	MAINTAIN [speed] OR LESS
UM116	RESUME NORMAL SPEED
UM117	CONTACT [unitname] [frequency]
UM120	MONITOR [unitname] [frequency]
UM123	SQUAWK [code]
UM133	REPORT PRESENT LEVEL
UM148	WHEN CAN YOU ACCEPT [level]
UM157	CHECK STUCK MICROPHONE [frequency]
UM159	ERROR [errorInformation]
UM162	SERVICE UNAVAILABLE

ID	Message
UM165	THEN
UM171	CLIMB AT [verticalRate] MINIMUM
UM172	CLIMB AT [verticalRate] MAXIMUM
UM173	DESCEND AT [verticalRate] MINIMUM
UM174	DESCEND AT [verticalRate] MAXIMUM
UM179	SQUAWK IDENT
UM183	[freetext]
UM190	FLY HEADING [degrees]
UM196	[freetext]
UM203	[freetext]
UM205	[freetext]
UM211	REQUEST FORWARDED
UM213	[facilitydesignation] ALTIMETER [altimeter]
UM215	TURN [direction] [degrees]
UM222	NO SPEED RESTRICTION
UM231	STATE PREFERRED LEVEL
UM232	STATE TOP OF DESCENT
UM237	REQUEST AGAIN WITH NEXT UNIT

The data link system is capable of receiving and processing the following message elements:

UM160	NEXT DATA AUTHORITY [facility]
UM227	LOGICAL ACKNOWLEDGEMENT

CS ACNS.B.DLS.B1.075 CPDLC Downlink Messages

(See AMC1 ACNS.B.DLS.B1.075, GM1 ACNS.B.DLS.B1.075, GM2 ACNS.B.DLS.B1.075 and GM3 ACNS.B.DLS.B1.075)

The data link system is capable of preparing and send the following downlink message elements:

ID	Message
DM0	WILCO
DM1	UNABLE
DM2	STANDBY
DM3	ROGER

ID	Message
DM4	AFFIRM
DM5	NEGATIVE
DM6	REQUEST [level]
DM18	REQUEST [speed]
DM22	REQUEST DIRECT TO [position]
DM32	PRESENT LEVEL [level]
DM62	ERROR [errorInformation]
DM63	NOT CURRENT DATA AUTHORITY
DM65	DUE TO WEATHER
DM66	DUE TO AIRCRAFT PERFORMANCE
DM81	WE CAN ACCEPT [level] AT [time]
DM82	WE CANNOT ACCEPT [level]
DM89	MONITORING [unitname] [frequency]
DM98	[freetext]
DM99	CURRENT DATA AUTHORITY
DM100	LOGICAL ACKNOWLEDGEMENT
DM106	PREFERRED LEVEL [level]
DM107	NOT AUTHORIZED NEXT DATA AUTHORITY
DM109	TOP OF DESCENT [time]

Data link services requirements

CS ACNS.B.DLS.B1.080 Data Link Initiation Capability (DLIC) Service

(See AMC 1 ACNS.B.DLS.B1.080 and GM1 ACNS.B.DLS.B1.080)

The data link system for DLIC conforms with section 4.1, 4.2.2 and 4.3.2 of EUROCAE Document ED-120 Safety and Performance Requirements Standard For Initial Air Traffic Data Link Services In Continental Airspace, including change 1 and change 2 and section 2.2.1 and 4.1 of EUROCAE Document ED-110B Interoperability Requirements Standard for Aeronautical Telecommunication Network Baseline 1.

CS ACNS.B.DLS.B1.085 ATC Communications Management (ACM) Service

(See AMC1 ACNS.B.DLS.B1.085 and GM1 ACNS.B.DLS.B1.085)

The data link system for ACM conforms with section 5.1.1, 5.1.2.3 (excluding requirements relating to downstream clearance) and 5.1.3.2 of EUROCAE Document ED-120 Safety and Performance Requirements Standard For Initial Air Traffic Data Link Services In Continental Airspace, including change 1 and change 2.

CS ACNS.B.DLS.B1.090 ACL Service Safety Requirements

(See AMC1 ACNS.B.DLS.B1.090 and GM1 ACNS.B.DLS.B1.090)

The data link system for ACL conforms with section 5.2.1, 5.2.2.3 and 5.2.3.2 of EUROCAE Document ED-120 Safety and Performance Requirements Standard For Initial Air Traffic Data Link Services In Continental Airspace, including change 1 and change 2.

CS ACNS.B.DLS.B1.095 ATC Microphone Check (AMC) Service

The data link system for AMC conforms with section 5.3.1, 5.3.2.3 and 5.3.3.2 of EUROCAE Document ED-120 Safety and Performance Requirements Standard For Initial Air Traffic Data Link Services In Continental Airspace, including change 1 and change 2.

Interoperability Requirements

CS ACNS.B.DLS.B1.100 Network Layer Requirements

(See AMC1 ACNS.B.DLS.B1.100 and GM1 ACNS.B.DLS.B1.100)

The ATN Router conforms to Class 6 with the capability to support Inter-domain routing protocol (IDRP).

CS ACNS.B.DLS.B1.105 Transport Layer Protocol Requirements

(See AMC1 ACNS.B.DLS.B1.105 and GM1 ACNS.B.DLS.B1.105)

The ATN Connection Oriented Transport Protocol (COTP), conforms to Transport Protocol Class 4.

CS ACNS.B.DLS.B1.110 Session Layer Requirement

(See AMC1 ACNS.B.DLS.B1.110)

ATN Session protocol is capable of supporting the following session protocol data units (SPDUs):

Abbreviation	Full SPDU Name
SCN	Short Connect
DRPSAC	Short Accept
SACC	Short Accept Continue
SRF	Short Refuse
SRFC	Short Refuse Continue

CS ACNS.B.DLS.B1.115 Presentation Layer Requirements

(See AMC ACNS.B.DLS.B1.115)

ATN Presentation protocol is capable of supporting the presentation protocol data units (PPDUs) listed in the following table:

Abbreviation	Full PDU Name
SHORT-CP	Short Presentation Connect, unaligned PER
SHORT-CPA	Short Presentation Connect Accept, unaligned PER
SHORT-CPR	Short Presentation Connect Reject

CS ACNS.B.DLS.B1.120 Application Layer Requirements

(See AMC1 ACNS.B.DLS.B1.120 and GM1 ACNS.B.DLS.B1.120)

The Application Layer is application-independent (also known as ‘Layer 7a’), and composed of a Convergence Function supporting operations of an Application Control Service Element (ACSE).

CS ACNS.B.DLS.B1.125 Database

The Network Service Access Point (NSAP) address database is capable of being updated.

Subpart C — Navigation (NAV)

SECTION 1 — PERFORMANCE-BASED NAVIGATION (PBN)

Subsection 1 — Applicability — General

CS ACNS.C.PBN.101 Applicability

(See AMC 1 ACNS.C.PBN.101, GM1 ACNS.C.PBN.101 and GM2 ACNS.C.PBN.101)

- (a) Table 1 indicates the applicable airworthiness requirements to be met by the airborne RNP system installation in order to obtain airworthiness approval for the RNP specifications addressed in this CS. Applicants should select the target PBN specification from the left column and then follow the respective row to the right.
- (b) Subsection 2 provides also certification criteria for RNAV 10, RNAV 5, RNAV 2 and RNAV 1.
- (c) The RNP 0.3 specification is applicable to helicopters.

Table 1: PBN specifications — Mandatory and optional airworthiness requirements

PBN specification	Basic criteria	Supplementary criteria							
	Subsections 1 & 2 LNAV	Subsection 3 LNAV in final approach	Subsection 4 VNAV	Subsection 5 VNAV in final approach	Subsection 6 RNP AR	Subsection 7 Advanced-RNP	Subsection 8 RF	Subsection 9 FRT	Subsection 10 Parallel offset
RNP 4	Required							<i>Optional</i>	Required
RNP 2	Required							<i>Optional</i>	<i>Optional</i>
RNP 1	Required		<i>Optional</i>				<i>Optional</i>		
RNP 0.3	Required		<i>Optional</i>				<i>Optional</i>		
RNP APCH	Required	Required	<i>Optional</i>	Required			<i>Optional</i>		
RNP AR	Required	Required	Required	Required	Required		Required		
A-RNP	Required	Required	<i>Optional</i>	Required		Required	Required	<i>Optional</i>	Required

Subsection 1: General applicability for performance-based lateral navigation

Subsection 2: Generic specifications for performance-based lateral navigation

Subsection 3: Supplementary specifications for lateral navigation in final approach

Subsection 4: Supplementary specifications for vertical navigation

Subsection 5: Supplementary specifications for vertical navigation in final approach

Subsection 5 includes criteria for RNP APCH approaches to LNAV/VNAV minima, either supported by barometric VNAV or by SBAS VNAV, as well as for RNP APCH approaches to LPV minima, which are supported by SBAS VNAV only. An applicant may opt to apply for approval of the RNP system to conduct operations to LNAV/VNAV minima, LPV minima or both.

Subsection 6: Supplementary specifications for RNP authorisation required (AR)

Subsection 6 includes criteria for RNP AR APCH and RNP AR departures. An applicant may opt to only apply for approval for RNP AR APCH.

Subsection 7: Supplementary specifications for applications for advanced RNP (A-RNP)

Subsection 8: Supplementary specifications supporting radius to fix (RF)

Subsection 9: Supplementary specifications supporting fixed radius transition (FRT)

Subsection 10: Supplementary specifications supporting parallel offset

[Issue: CS-ACNS/2]

Subsection 2 — Generic specifications for performance-based lateral navigation

APPLICABILITY

CS ACNS.C.PBN.201 Applicability

Subsection 2 provides the functional and performance criteria that are common to all PBN specifications for lateral navigation.

[Issue: CS-ACNS/2]

SYSTEM QUALIFICATION CRITERIA

CS ACNS.C.PBN.205 RNP system approval

(See AMC1 ACNS.C.PBN.205, AMC2 ACNS.C.PBN.205, GM1 ACNS.C.PBN.205, GM2 ACNS.C.PBN.205 and GM3 ACNS.C.PBN.205)

All equipment contributing to the area navigation function is approved.

[Issue: CS-ACNS/2]

CS ACNS.C.PBN.210 Position source

(See AMC1 ACNS.C.PBN.210)

The RNP system uses GNSS as the primary source of horizontal position.

[Issue: CS-ACNS/2]

FUNCTIONAL CRITERIA

RNP system

CS ACNS.C.PBN.215 Position estimation

(See AMC1 ACNS.C.PBN.215 and GM1 ACNS.C.PBN.215)

The RNP system continuously estimates:

- (a) the present lateral position of the aircraft; and
- (b) the accuracy and integrity of the lateral position, when supported by the navigation sensors.

[Issue: CS-ACNS/2]

CS ACNS.C.PBN.220 Navigation source selection and reversion

(See AMC1 ACNS.C.PBN.220)

When a multi-sensor RNP system is installed, it has the capability to automatically, or manually, select the best available navigation source(s).

[Issue: CS-ACNS/2]

CS ACNS.C.PBN.225 Reasonableness check of distance-measuring equipment (DME)

(See AMC1 ACNS.C.PBN.225)

When the RNP system uses DME, it has the capability to perform a reasonableness check of the radio navigation data.

[Issue: CS-ACNS/2]

CS ACNS.C.PBN.230 Flight plan management

(See AMC1 ACNS.C.PBN.230)

The RNP system provides flight crew with the capability to create, review, modify and activate a flight plan. Activation of any new flight plan or modification of an existing flight plan requires a positive action by the flight crew. Guidance output is not affected until the flight plan or its modification is activated. Once the flight plan is activated, the RNP system has the capacity to execute it.

[Issue: CS-ACNS/2]

CS ACNS.C.PBN.235 Automatic leg sequencing

(See AMC1 ACNS.C.PBN.235)

The RNP system has the capability to automatically sequence legs and display the sequencing to the flight crew in a readily visible manner.

[Issue: CS-ACNS/2]

CS ACNS.C.PBN.240 Route/procedure extraction and loading

(See AMC1 ACNS.C.PBN.240)

The RNP system has the capability to extract routes/procedures from the on-board navigation database in their entirety, including all their characteristics, and to load them into the RNP system's flight plan.

[Issue: CS-ACNS/2]

CS ACNS.C.PBN.245 Path definition and leg transition

(See AMC1 ACNS.C.PBN.245 and GM1 ACNS.C.PBN.245)

- (a) The RNP system allows flight crew to define the flight path for the intended route.
- (b) The RNP system has the capability to execute leg transitions and maintain tracks consistent with the following path terminators:
 - (1) direct to fix (DF), track to a fix (TF), initial fix (IF), fix to an altitude (FA), and course to a fix (CF);
 - (2) heading to an altitude (VA), heading to a manual termination (VM), and heading to an intercept (VI);
 - (3) course to an altitude (CA), and from a fix to a manual termination (FM).
- (c) The RNP system has the capability to execute fly-by turns.
- (d) Unless otherwise specified in the on-board navigation database, the RNP system constructs the flight path between waypoints in the same manner as a TF leg.

[Issue: CS-ACNS/2]

CS ACNS.C.PBN.250 'Direct-to' function

(See AMC1 ACNS.C.PBN.250)

The RNP system has the capability to generate and execute a geodesic path to any designated fix, at any time, without 'S-turning' and without undue delay, known as 'direct-to' function.

[Issue: CS-ACNS/2]

CS ACNS.C.PBN.255 Magnetic variation

(See AMC1 ACNS.C.PBN.255 and GM1 ACNS.C.PBN.255)

- (a) The RNP system has the capability to assign a magnetic variation at any location within the region where flight operations are conducted using magnetic North as reference.
- (b) For paths defined by a course, the RNP system uses the appropriate magnetic variation value available in the navigation database.
- (c) The conditions under which the magnetic variation table (MAGVAR table), certified as part of the aircraft configuration, is updated are included in the aircraft's instructions for continued airworthiness (ICA).

[Issue: CS-ACNS/2]

CS ACNS.C.PBN.260 RNAV holding

(See AMC1 ACNS.C.PBN.260 and GM1 ACNS.C.PBN.260)

- (a) The RNP system has the capability to initiate, maintain and discontinue holding procedures at any point and at all altitudes. When a holding procedure is initiated, the RNP system:
 - (1) permits the flight crew to readily select a desired course to the holding waypoint;
 - (2) retains all subsequent waypoints in the active flight plan in the same sequence; and
 - (3) permits the flight crew to readily initiate the return to automatic waypoint sequencing at any time and continue with the existing flight plan.
- (b) The RNP system allows for manual or automatic definition of the holding pattern.

[Issue: CS-ACNS/2]

CS ACNS.C.PBN.265 User-defined routes and fixes

(See AMC1 ACNS.C.PBN.265 and GM1 ACNS.C.PBN.265)

The RNP system provides means for the flight crew to build a user-defined route by:

- (a) entering unique waypoints extracted from the on-board navigation database; and
- (b) manually creating user-defined fixes.

[Issue: CS-ACNS/2]

CS ACNS.C.PBN.270 Navigation accuracy

(See AMC1 ACNS.C.PBN.270)

- (a) The RNP system is capable of acquiring and setting the RNP value for each segment of a route or procedure.
- (b) When an aircraft flies an RNP route or procedure and the RNP value changes to a lower value, the RNP completes the change no later than reaching the leg with the lower RNP value.

[Issue: CS-ACNS/2]

Display of navigation data

CS ACNS.C.PBN.275 Display and entry of navigation data — resolution

(See AMC1 ACNS.C.PBN.275)

The RNP system displays and allows manual entry of navigation data with a resolution that supports the intended operation.

[Issue: CS-ACNS/2]

CS ACNS.C.PBN.280 Deviation display

(See AMC1 ACNS.C.PBN.280, AMC2 ACNS.C.PBN.280 and AMC3 ACNS.C.PBN.280)

- (a) For defined paths, the RNP system continuously displays, in each flight crew's optimum field of view, the computed path and the deviation from that path.
- (b) The lateral deviation display is automatically slaved to the RNP system's computed path.

[Issue: CS-ACNS/2]

CS ACNS.C.PBN.285 Display of active waypoint

(See AMC1 ACNS.C.PBN.285 and AMC2 ACNS.C.PBN.285)

The RNP system displays in the flight crew's maximum field of view:

- (a) the identification of the active (To) waypoint; and
- (b) the distance, estimated time of arrival at, or time-to go to, and bearing to the active (To) waypoint.

[Issue: CS-ACNS/2]

CS ACNS.C.PBN.290 Display of ground speed

(See AMC1 ACNS.C.PBN.290)

The RNP system displays the ground speed in the flight crew's maximum field of view.

[Issue: CS-ACNS/2]

CS ACNS.C.PBN.2105 Display of speed constraints

(See AMC1 ACNS.C.PBN.2105)

The RNP system displays speed constraints to the flight crew in the maximum field of view.

[Issue: CS-ACNS/2]

CS ACNS.C.PBN.2110 Display of navigation aid frequencies and/or identifiers

The RNP system has the capability to display the frequencies and/or identifiers of the ground positioning navigation aids selected on a page which is readily available to the flight crew.

[Issue: CS-ACNS/2]

Navigation database

CS ACNS.C.PBN.2115 Use of navigation database

(See AMC1 ACNS.C.PBN.2115 and GM1 ACNS.C.PBN.2115)

The RNP system uses an on-board navigation database which:

- (a) is protected against flight crew modification of the stored data; and
- (b) has a capacity appropriate for the intended operation.

[Issue: CS-ACNS/2]

CS ACNS.C.PBN.2120 Data quality requirements (DQRs)

(See AMC1 ACNS.C.PBN.2120)

The applicant ensures that the DQRs associated with the navigation database have been defined and are compatible with the intended function through formal arrangements that are signed with the corresponding data services provider(s) (DAT provider).

[Issue: CS-ACNS/2]

CS ACNS.C.PBN.2125 Extraction and display of navigation data

(See AMC1 ACNS.C.PBN.2125 and GM1 ACNS.C.PBN.2125)

The RNP system has the means to:

- (a) process the data with the resolution provided by the database; and
- (b) enable flight crew to:
 - (1) verify the validity period of the on-board navigation database; and
 - (2) load from the on-board navigation database, by its identifier(s), the procedure(s) to be flown.

[Issue: CS-ACNS/2]

Monitoring and alerting

CS ACNS.C.PBN.2130 Alerting associated with degradation of navigation

(See AMC1 ACNS.C.PBN.2130)

When the RNP system is unable to meet the RNP value, the RNP system provides, without undue delay, an indication in the flight crew's optimum field of view.

[Issue: CS-ACNS/2]

CS ACNS.C.PBN.2135 Navigation accuracy alerting

(See AMC1 ACNS.C.PBN.2135)

The RNP system provides an annunciation if a manually entered RNP value is greater than the RNP value associated with the current routes and procedures as defined in the on-board navigation database. Any subsequent reduction of the latter RNP value reinstates this annunciation.

[Issue: CS-ACNS/2]

PERFORMANCE CRITERIA

Lateral performance

CS ACNS.C.PBN.2140 Lateral navigation accuracy

(See AMC1 ACNS.C.PBN.2140)

The lateral navigation accuracy provided by the RNP system supports the intended operations.

[Issue: CS-ACNS/2]

CS ACNS.C.PBN.2145 RNP system design — integrity

(See AMC1 ACNS.C.PBN.2145)

The RNP system, including position sensors, displays, etc., is designed to provide a level of integrity that supports the intended operation.

[Issue: CS-ACNS/2]

CS ACNS.C.PBN.2150 RNP system design — continuity

(See AMC1 ACNS.C.PBN.2150)

The RNP system, including position sensors, displays, etc., is designed to provide a level of continuity that supports the intended operation.

[Issue: CS-ACNS/2]

Subsection 3 — Supplementary specifications for lateral navigation in final approach

APPLICABILITY

CS ACNS.C.PBN.301 Applicability

(See GM1 ACNS.C.PBN.301)

Subsection 3 provides the supplementary functional and performance criteria that are applicable to the lateral navigation function for the final approach segment; these criteria are necessary to obtain certification against the RNP specifications that support approach operations (i.e. A-RNP, RNP APCH and RNP AR APCH).

[Issue: CS-ACNS/2]

SUPPLEMENTARY FUNCTIONAL CRITERIA

RNP system

CS ACNS.C.PBN.305 RNP system approval

(See AMC1 ACNS.C.PBN.305)

All equipment contributing to the area navigation function is approved.

[Issue: CS-ACNS/2]

CS ACNS.C.PBN.310 Final approach intercept

(See AMC1 ACNS.C.PBN.310 and GM1 ACNS.C.PBN.310)

The RNP system has the capability to intercept the final approach course at or before the final approach fix or the final approach point.

[Issue: CS-ACNS/2]

Display of navigation data

CS ACNS.C.PBN.320 Approach mode indication

(See GM1 ACNS.C.PBN.320)

The RNP system provides unambiguous indications in the flight crew's maximum field of view that enables the flight crew to readily identify:

- (a) the type of approach that is being flown and the applicable line of minima; and
- (b) whether the guidance is angular or linear.

[Issue: CS-ACNS/2]

CS ACNS.C.PBN.325 Lateral deviation display

(See AMC1 ACNS.C.PBN.325)

The RNP system continuously displays on a non-numeric lateral deviation display, in each flight crew's optimum field of view, the deviation from the computed path.

[Issue: CS-ACNS/2]

CS ACNS.C.PBN.330 Non-numeric lateral deviation display scaling for approach

(See AMC1 ACNS.C.PBN.330)

The full-scale deflection of the non-numeric lateral deviation display supports the applicable track-keeping accuracy that is required for the approach.

[Issue: CS-ACNS/2]

CS ACNS.C.PBN.335 Display of distance to threshold

For approaches to LPV minima, the RNP system continuously displays in the flight crew's maximum field of view the distance to the landing threshold point/fictitious threshold point (LTP/FTP) or missed approach point (MAPt) after passing the final approach fix/final approach point.

[Issue: CS-ACNS/2]

Subsection 4 — Supplementary specifications for vertical navigation

APPLICABILITY

CS ACNS.C.PBN.401 Applicability

(See GM1.ACNS.C.PBN.401)

Subsection 4 provides the supplementary requirements that support the use of vertical navigation outside the final approach segment.

[Issue: CS-ACNS/2]

SUPPLEMENTARY FUNCTIONAL CRITERIA

RNP system

CS ACNS.C.PBN.405 Vertical path

The RNP system has the capability to define a vertical path to a fix.

[Issue: CS-ACNS/2]

CS ACNS.C.PBN.410 Altitude constraints

(See AMC1 ACNS.C.PBN.410)

Where barometric altimetry is used as the source for vertical guidance (BARO-VNAV), the RNP system has the capability to specify a vertical path between altitude constraints at two fixes in the flight plan.

[Issue: CS-ACNS/2]

CS ACNS.C.PBN.420 Pressure settings

(See GM1 ACNS.C.PBN.420)

Where barometric altimetry is used as the source for vertical guidance (BARO-VNAV), the RNP system uses the same pressure-setting input as the aircraft's altimetry system.

[Issue: CS-ACNS/2]

Subsection 5 — Supplementary specifications for vertical navigation in final approach

APPLICABILITY

CS ACNS.C.PBN.501 Applicability

(See GM1 ACNS.C.PBN.501)

Subsection 5 provides the supplementary functional and performance criteria that are applicable to vertical navigation function for final approach.

[Issue: CS-ACNS/2]

SUPPLEMENTARY FUNCTIONAL CRITERIA

RNP system

CS ACNS.C.PBN.505 Vertical approach path

(See AMC1 ACNS.C.PBN.505)

The RNP system has the capability to define a vertical approach path.

[Issue: CS-ACNS/2]

CS ACNS.C.PBN.515 Pressure settings

(See GM1 ACNS.C.PBN.515)

Where barometric VNAV is provided, the RNP system uses the same pressure-setting input as the aircraft's altimetry system.

[Issue: CS-ACNS/2]

CS ACNS.C.PBN.520 Glide path intercept

(See AMC1 ACNS.C.PBN.520)

The RNP system has the capability to automatically intercept the final approach glide path.

[Issue: CS-ACNS/2]

CS ACNS.C.PBN.525 Temperature compensation

(See AMC1 ACNS.C.PBN.525)

- (a) For operations below the promulgated temperature limits on RNP APCH procedures down to LNAV/VNAV minima, area navigation systems that provide barometric VNAV apply automatic temperature compensation along the final approach segment (FAS).
- (b) If the automatic temperature compensation is also provided outside the FAS of the procedure, the function providing automatic temperature compensation is pilot-selectable.

- (c) Systems supporting pilot-selectable automatic temperature compensation, either within or outside of the FAS, provide a clear and distinct indication when the function is activated.

[Issue: CS-ACNS/2]

Display of navigation data

CS ACNS.C.PBN.530 Vertical deviation display

(See AMC1 ACNS.C.PBN.530 and AMC2 ACNS.C.PBN.530)

The RNP system continuously displays, on the non-numeric vertical deviation display located in the flight crew's optimum field of view, the deviation from the defined vertical approach path, including the extended vertical approach path.

[Issue: CS-ACNS/2]

CS ACNS.C.PBN.535 Resolution and full-scale deflection of the vertical deviation display

(See AMC1 ACNS.C.PBN.535 and GM1 ACNS.C.PBN.535)

The vertical deviation display has a resolution and a full-scale deflection that suitably supports the monitoring and bounding of the vertical deviation.

[Issue: CS-ACNS/2]

CS ACNS.C.PBN.540 Barometric altitude

When the approach is supported by barometric VNAV, the aircraft displays the barometric altitude from two independent altimetry sources:

- (a) one in each of the flight crew's optimum field of view, if the required minimum flight crew is two; or
- (b) one in the flight crew's optimum field of view and the other visible from the flight crew's normal position, if the required minimum flight crew is one.

[Issue: CS-ACNS/2]

CS ACNS.C.PBN.545 Active approach mode display

If the RNP system provides both barometric VNAV and SBAS/GNSS VNAV, an unambiguous indication is provided in the flight crew's maximum field of view that enables the flight crew to identify the active source for the VNAV, barometric altitude or SBAS/GNSS geometric altitude.

[Issue: CS-ACNS/2]

Monitoring and alerting

CS ACNS.C.PBN.550 Glide path alerting

(See AMC1 ACNS.C.PBN.550)

For approaches to LPV minima, aircraft equipped with a Class A TAWS provide an alert for excessive deviation below the glide path.

[Issue: CS-ACNS/2]

SUPPLEMENTARY PERFORMANCE CRITERIA

Vertical performance

CS ACNS.C.PBN.555 Vertical accuracy when using barometric VNAV

(See AMC1 ACNS.C.PBN.555)

The accuracy of the vertical position that is provided by the RNP system when providing barometric VNAV supports the intended operations.

[Issue: CS-ACNS/2]

CS ACNS.C.PBN.560 Vertical accuracy when using SBAS/GNSS geometric altitude sources

(See AMC1 ACNS.C.PBN.560 and GM1 ACNS.C.PBN.560)

When supporting approach operations down to LNAV/VNAV or LPV minima using SBAS/GNSS vertical position source, the accuracy of the RNP system is demonstrated to be suitable for the intended operation.

[Issue: CS-ACNS/2]

CS ACNS.C.PBN.565 Transitions

(See AMC1 ACNS.C.PBN.565)

RNP systems that provide both barometric VNAV and SBAS/GNSS VNAV perform smooth transitions from barometric VNAV to SBAS/GNSS VNAV and vice versa.

[Issue: CS-ACNS/2]

CS ACNS.C.PBN.570 Advisory VNAV

(See AMC1 ACNS.C.PBN.570 and GM1 ACNS.C.PBN.570)

(a) RNP systems that provide advisory VNAV comply with the criteria of this Subsection for barometric VNAV or SBAS/GNSS VNAV:

- (1) Advisory VNAV provided within the FAS that is based on barometric altitude meets the intent of the temperature compensation function defined in CS ACNS.C.PBN.525.
- (2) When Advisory VNAV is provided and the performance criteria of this Subsection for barometric VNAV or SBAS/GNSS VNAV cannot be met, a clear and unambiguous indication that the VNAV is advisory is provided.

(b) Advisory VNAV is based on a correct path definition:

- (1) Either provided by the State's AIP; or
- (2) Through an alternative approved process.

[Issue: CS-ACNS/2]

CS ACNS.C.PBN.575 RNP system design — integrity in final approach

(See AMC1 ACNS.C.PBN.575)

The integrity of the vertical guidance provided by the aircraft's RNP system supports the intended operations.

[Issue: CS-ACNS/2]

CS ACNS.C.PBN.580 RNP system design — continuity

(See AMC1 ACNS.C.PBN.580)

The continuity of vertical guidance provided by the RNP system supports the intended operation.

[Issue: CS-ACNS/2]

Subsection 6 — Supplementary specifications for RNP authorisation required (RNP AR)

APPLICABILITY

CS ACNS.C.PBN.601 Applicability

Subsection 6 provides the supplementary functional and performance criteria that are applicable to obtain certification for RNP AR APCH. Criteria for RNP AR departures (RNP AR DP) are provided consistently with the draft ICAO Navigation Specification for RNP AR departures.

The criteria of Subsection 6 only apply to operations on RNP AR procedures designed in accordance with the requirements of ICAO Doc 9905 'Required Navigation Performance Authorization Required (RNP AR) Procedure Design Manual.

[Issue: CS-ACNS/2]

SUPPLEMENTARY SYSTEM QUALIFICATION

CS ACNS.C.PBN.605 System performance demonstration

(See AMC1 ACNS.C.PBN.605 and GM1 ACNS.C.PBN.605)

The performance (including the RF function) of the aircraft's system is demonstrated under a variety of operational, meteorological, and failure conditions, commensurate with the intended operation.

Criteria for assessing RNP significant failures under design limit performance conditions are the following:

- (a) the lateral excursions observed as a result of probable failures are contained within a 1 × RNP corridor;
- (b) the lateral excursions observed as a result of one-engine-inoperative (OEI) are contained within a 1 × RNP corridor;
- (c) the lateral excursions observed as a result of remote failures are contained within a 2 × RNP corridor; and
- (d) a demonstration is made that the aircraft remains manoeuvrable and a safe extraction can be flown for all extremely remote failures.

For criteria (a), (b), and (c) above, the vertical excursion does not exceed 75 feet below the desired path.

[Issue: CS-ACNS/2]

CS ACNS.C.PBN.610 Source of horizontal position

(See AMC 1 ACNS.C.PBN.610 and GM1 ACNS.C.PBN.610)

- (a) The RNP system utilises the global navigation satellite system (GNSS) as primary source of horizontal position and is backed by an inertial position source.
- (b) The aircraft's RNP system does not use VOR-updating when conducting RNP AR APCH procedures.

[Issue: CS-ACNS/2]

SUPPLEMENTARY FUNCTIONAL CRITERIA

RNP system

CS ACNS.C.PBN.615 Autopilot/Flight director

- (a) Means are provided to couple the RNP system with the autopilot or flight director.
- (b) The RNP system, the flight director system and autopilot must be capable of commanding a bank angle up to 25 degrees above 121 m (400 ft) AGL and up to 8 degrees below 121 m (400 ft) AGL.

[Issue: CS-ACNS/2]

CS ACNS.C.PBN.620 Reversion

(See GM1 ACNS.C.PBN.620)

When the RNP cannot be maintained during a radius to fix (RF) leg, the flight guidance mode remains in lateral navigation.

[Issue: CS-ACNS/2]

CS ACNS.C.PBN.625 Go-around and missed approach

(See GM1 ACNS.C.PBN.625)

Upon initiating a go-around or missed approach, both RNP system and the autopilot or flight director remain in lateral navigation guidance mode and continue to guide the aircraft along the lateral path of the procedure until completion of the approach and missed approach procedure.

[Issue: CS-ACNS/2]

CS ACNS.C.PBN.630 Radius to fix (RF) leg transition

(See AMC1 ACNS.C.PBN.630)

The RNP system has the capability to execute the radius to fix (RF) leg transitions and to consistently maintain tracks, as specified in Subsection 8.

[Issue: CS-ACNS/2]

CS ACNS.C.PBN.635 Navigation accuracy for RNP AR operations

(See AMC1 ACNS.C.PBN.635)

The RNP system is capable of acquiring the RNP value associated with the intended operation.

[Issue: CS-ACNS/2]

CS ACNS.C.PBN.640 RNP AR departures – Functional Requirements

(See AMC1 ACNS.C.PBN.640 and GM1 ACNS.C.PBN.640)

The RNP system provides the following capabilities to support RNP AR departure procedures:

- (a) The RNP system allows loading and execution of a flight plan where the initial fix of the RNP AR DP defined path is placed at or just beyond the approach end of the take-off runway.

- (b) The RNP system provides lateral path guidance not later than when reaching 50 feet above the departure runway.
- (c) The RNP system is capable of executing an RF leg where the first fix defining the RF leg begins at the departure end of the runway.
- (d) The RNP system provides a means for the flight crew to confirm availability of GNSS for aircraft positioning immediately prior to take-off.
- (e) The INS position is automatically updated upon pressing the take-off/go-around (TOGA) button or provide the ability to manually initiate a position update during ground operations immediately prior to take-off.

[Issue: CS-ACNS/2]

CS ACNS.C.PBN.645 RNP AR departures – Take off performance Data

In support of RNP AR departures, the applicant provides aircraft take off performance data, including performance on non-standard climb gradients, to the operator in a form acceptable to EASA.

[Issue: CS-ACNS/2]

Display of navigation data

CS ACNS.C.PBN.650 Display of aircraft track

The RNP system displays the desired and current aircraft track on an electronic map display in the flight crew's optimum field of view.

[Issue: CS-ACNS/2]

CS ACNS.C.PBN.655 Lateral deviation display

(See AMC1 ACNS.C.PBN.655)

The full-scale deflection of the non-numeric lateral deviation display supports the intended operation.

[Issue: CS-ACNS/2]

Navigation database

CS ACNS.C.PBN.660 Use of a navigation database

(See AMC1 ACNS.C.PBN.660)

The RNP system uses an on-board navigation database which provides sufficient data resolution to ensure that the RNP system achieves the required accuracy to support RNP AR operations.

[Issue: CS-ACNS/2]

Vertical performance

CS ACNS.C.PBN.670 Vertical accuracy

(See AMC1 ACNS.C.PBN.670 and AMC2 ACNS.C.PBN.670)

The vertical position accuracy supports the intended RNP AR operations.

[Issue: CS-ACNS/2]

SUPPLEMENTARY PERFORMANCE CRITERIA

CS ACNS.C.PBN.675 RNP system design — RNP AR integrity

(See AMC1 ACNS.C.PBN.675)

The integrity of the lateral guidance provided by the aircraft RNP system supports the intended RNP AR operations.

[Issue: CS-ACNS/2]

CS ACNS.C.PBN.680 RNP system design — RNP AR continuity

(See AMC1 ACNS.C.PBN.680)

The continuity of lateral guidance provided by the RNP system supports the intended RNP AR operation.

[Issue: CS-ACNS/2]

Subsection 7 — Supplementary specifications for applications for advanced RNP (A-RNP)

APPLICABILITY

CS ACNS.C.PBN.701 Applicability

Subsection 7 provides the supplementary functional and performance criteria that are applicable to obtain certification for applications for advanced-RNP (A-RNP).

[Issue: CS-ACNS/2]

SUPPLEMENTARY FUNCTIONAL CRITERIA

RNP system

CS ACNS.C.PBN.705 Radius to Fix

The RNP system has the capability to execute radius to Fix (RF) legs (as specified in Subsection 8).

[Issue: CS-ACNS/2]

CS ACNS.C.PBN.710 Parallel offset

The RNP system has the capability to implement parallel offset (as specified in Subsection 10).

[Issue: CS-ACNS/2]

CS ACNS.C.PBN.715 RNP scalability

The RNP system has the capability to operate with RNP values (ranging from 0.3 to 1.0 NM in tenth(s) of NM). The RNP value is either retrievable automatically from the on-board navigation database or manually adjustable by the flight crew.

[Issue: CS-ACNS/2]

Display of navigation data

CS ACNS.C.PBN.725 Display of aircraft track

The RNP system displays the current aircraft track (or track angle error) in the flight crew's optimum field of view.

[Issue: CS-ACNS/2]

Subsection 8 — Supplementary specifications supporting radius to fix (RF)

APPLICABILITY

CS ACNS.C.PBN.801 Applicability

Subsection 8 provides the supplementary functional and performance criteria that are applicable to obtain certification for the capability to execute radius to fix (RF) path terminators.

The RF functionality is mandatory to obtain A-RNP and RNP AR certification, and can be optionally associated with RNP 1, RNP 0.3 and RNP APCH.

[Issue: CS-ACNS/2]

SUPPLEMENTARY FUNCTIONAL CRITERIA

RNP system

CS ACNS.C.PBN.805 RF functional requirements

(See AMC1 ACNS.C.PBN.805 and GM1 ACNS.C.PBN.805)

The RNP system coupled with an autopilot or a flight director is capable of:

- (a) executing the radius to fix (RF) legs; and
- (b) commanding and achieving a minimum bank angle of up to 30 degrees above 400 feet above ground level (AGL) and up to 8 degrees below 400 feet AGL.

[Issue: CS-ACNS/2]

CS ACNS.C.PBN.810 RNP failure

If the RNP cannot be achieved during a radius to fix (RF) leg, the flight guidance mode remains in lateral navigation.

[Issue: CS-ACNS/2]

CS ACNS.C.PBN.815 Autopilot/Flight director

(See AMC1 ACNS.C.PBN.815)

The use of autopilot or flight director is required to execute radius to fix (RF) leg transitions, except for CS-23 Level 1, 2, and 3 aircraft, for which no type rating is required, and that are performing RNP 1 and RNP APCH operations with an RNP value of not less than 1, and at speeds of 200 knots or less, provided that, in addition to the requirement stated in CS ACNS.C.PBN.820, the aircraft is equipped with an appropriately scaled course deviation indicator (CDI).

[Issue: CS-ACNS/2]

Display of navigation data

CS ACNS.C.PBN.820 Display of computed path

The RNP system displays the intended path on an appropriately scaled moving map display in the flight crew's maximum field of view.

[Issue: CS-ACNS/2]

Subsection 9 — Supplementary specifications supporting fixed radius transition (FRT)

APPLICABILITY

CS ACNS.C.PBN.901 Applicability

Subsection 9 provides the supplementary functional and performance criteria that are applicable to obtain FRT certification.

The FRT functionality can optionally be associated with RNP 2, RNP 4, and advanced RNP (A-RNP) specifications.

Issue: CS-ACNS/2]

SUPPLEMENTARY FUNCTIONAL CRITERIA

RNP system

CS ACNS.C.PBN.905 Fixed radius transition (FRT) requirements

(See AMC1 ACNS.C.PBN.905 and GM1 ACNS.C.PBN.905)

The RNP system is capable of defining, executing and maintaining a track consistent with an FRT between flight path segments, using a 0.1-NM resolution for the radius value.

Issue: CS-ACNS/2]

Display of navigation data

CS ACNS.C.PBN.910 Display of the computed path

The RNP system displays the computed curved path of the FRT on an appropriately scaled moving map display in the flight crew's maximum field of view.

Issue: CS-ACNS/2]

Subsection 10 — Supplementary specifications supporting parallel offset

APPLICABILITY

CS ACNS.C.PBN.1001 Applicability

Subsection 10 provides supplementary functional and performance criteria that are applicable to obtain certification for parallel offset which enables the aircraft to fly a path parallel to, but offset left or right from, the original active route (parent route). Parallel offset is applicable only for en-route segments and is not foreseen to be applied on standard instrument departures (SIDs), standard instrument arrivals (STARs) or approach procedures.

The parallel offset functionality is mandatory to obtain RNP 4 and A-RNP certification, and can be optionally associated with RNP 2 specifications.

Issue: CS-ACNS/2]

SUPPLEMENTARY FUNCTIONAL CRITERIA

RNP system

CS ACNS.C.PBN.1005 Parallel offset capabilities

(See AMC1 ACNS.C.PBN.1005)

- (a) The RNP system has the capability to:
- (1) define a offset path from the parent track and transit to and from the offset track maintaining an intercept angle of 30 degrees;
 - (2) manually initiate and cease the parallel offset path;
 - (3) automatically cancel the offset path:
 - (i) following an amendment of the active flight plan by executing a 'direct-to';
 - (ii) approaching the first fix of an instrument approach procedure (initial approach fix (IAF), initial fix (IF), or final approach fix (FAF));
 - (iii) approaching the commencement of a segment which is not compatible with the offset.
- An advance notice of the automatic cancellation is given to the flight crew and the RNP system allows sufficient time for the aircraft to return to the parent track before the commencement of the incompatible leg or the first fix of the instrument approach procedure.
- (b) When executing a parallel offset, the RNP system applies to the offset route all performance requirements and constraints of the original route, as defined in the active flight plan.

Issue: CS-ACNS/2]

Display of navigation data

CS ACNS.C.PBN.1010 Indication of parallel offset status

When in offset mode, the RNP system provides:

- (a) lateral guidance parameters relative to the offset path;
- (b) distance and estimated time of arrival at, or time to go to, information relative to the offset reference points;
- (c) a continuous indication of the parallel offset status in the flight crew's maximum field of view; and
- (d) the cross-track deviation indication during the operation of the offset relative to the offset track.

Issue: CS-ACNS/2]

Subpart D — Surveillance (SUR)

Section 1 — Mode A/C only surveillance

GENERAL

CS ACNS.D.AC.001 Applicability

This section provides standards for Mode A/C only airborne surveillance installations.

SYSTEM FUNCTIONAL REQUIREMENTS

CS ACNS.D.AC.010 Transponder characteristics

(See AMC1 ACNS.D.AC.010)

- (a) The transponder is approved and has Mode A and Mode C capability.
- (b) The transponder replies with Mode A and Mode C replies to Mode A/C interrogations, to Mode A/C-only all-call interrogations, and to Mode A/C/S all-call interrogations.
- (c) The peak pulse power available at the antenna end of the transmission line of the transponder is more than 125 W (21 dBW) and not more than 500 W (27 dBW) for aircraft that operate at altitudes exceeding 4 570m (15 000 ft) or with a maximum cruising speed exceeding 90 m/s (175 knots).
- (d) The peak pulse power available at the antenna end of the transmission line of the transponder is more than 70 W (18.5 dBW) and not more than 500 W (27 dBW) for aircraft operating at or below 4 570m (15 000 ft) with a maximum cruising airspeed of 90 m/s (175 knots) or less.

CS ACNS.D.AC.015 Data transmission

(See AMC1 ACNS.D.AC.015)

The surveillance system provides the following data in the replies:

- (a) The Mode A identity code in the range 0000 to 7777 (Octal).
- (b) The pressure altitude corresponding to within plus or minus 38.1 m (125 ft), on a 95 % probability basis, with the pressure-altitude information (referenced to the standard pressure setting of 1.01325 10^5 Pa), used on board the aircraft to adhere to the assigned flight profile. The pressure altitude ranges from minus 304 m (1 000 ft) to the maximum certificated altitude of aircraft plus 1520 m (5 000 ft)
- (c) Special Position Indication (SPI) for 15 to 30 seconds after an IDENT (SPI) command has been initiated by the pilot.

CS ACNS.D.AC.020 Altitude source

(See AMC1 ACNS.D.AC.020)

- (a) The reported pressure altitude is obtained from an approved source.

- (b) The altitude resolution is equal to or less than 30.48 m (100 ft.).
- (c) The altitude source connected to the active transponder is the source being used to fly the aircraft.

CS ACNS.D.AC.025 Flight deck interface

(See AMC1 ACNS.D.AC.025)

A means is provided to:

- (a) select Mode A Code including emergency indicators;
- (b) initiate the IDENT (SPI) feature;
- (c) notify the flight crew when the transmission of pressure altitude information has been inhibited if a means to inhibit the transmission of pressure altitude is provided;
- (d) select the transponder to the 'standby' or 'OFF' condition;
- (e) indicate the non-operational status or failure of the transponder system without undue delay and without the need for flight crew action;
- (f) display the selected Mode A code to the flight crew; and
- (g) select the pressure altitude source to be connected to the active transponder.

SYSTEM PERFORMANCE REQUIREMENTS

CS ACNS.D.AC.030 Integrity

The Mode A/C only airborne surveillance system integrity is designed commensurate with a 'minor' failure condition.

CS ACNS.D.AC.035 Continuity

The Mode A/C airborne surveillance system continuity is designed to an allowable qualitative probability of 'probable'.

INSTALLATION REQUIREMENTS

CS ACNS.D.AC.040 Dual/multiple transponder installation

(See AMC1 ACNS.D.AC.040)

If more than one transponder is installed, simultaneous operation of the transponders is prevented.

CS ACNS.D.AC.045 Antenna installation

(See AMC1 ACNS.D.AC.045)

The installed antenna(s) has (have) a radiation pattern which is vertically polarised, omnidirectional in the horizontal plane, and has sufficient vertical beam width to ensure proper system operation during normal aircraft manoeuvres.

Section 2 — Mode S elementary surveillance

GENERAL

CS ACNS.D.ELS.001 Applicability

(See AMC1 ACNS.D.ELS.001)

This section provides the standards for airborne Mode S Elementary Surveillance installations.

SYSTEM FUNCTIONAL REQUIREMENTS

CS ACNS.D.ELS.010 Transponder characteristics

(See AMC1 ACNS.D.ELS.010)

- (a) The transponder(s) is (are) an approved level 2 or greater Mode S transponder(s) with Elementary Surveillance and Surveillance Identifier (SI) capability.
- (b) The transponder(s) of aircraft that have ACAS II installed is (are) ACAS compatible.
- (c) The peak pulse power available at the antenna end of the transmission line of the transponder is more than 125 W (21 dBW) and not more than 500 W (27 dBW) for aircraft that operate at altitudes exceeding 4 570 m (15 000 ft) or with a maximum cruising speed exceeding 90 m/s (175 knots).
- (d) The peak pulse power available at the antenna end of the transmission line of the transponder is more than 70 W (18.5 dBW) and not more than 500 W (27 dBW) for aircraft operating at or below 4 570 m (15 000 ft) with a maximum cruising airspeed of 90 m/s (175 knots) or less.

CS ACNS.D.ELS.015 Data transmission

(See AMC1 ACNS.D.ELS.015)

- (a) The surveillance system provides the following data in the Mode S replies:
 - (1) The Mode A Code in the range 0000 to 7777 (Octal);
 - (2) The pressure altitude corresponding to within plus or minus 38 m (125 ft), on a 95 per cent probability basis, with the pressure-altitude information (referenced to the standard pressure setting of 1013.25 hectopascals), used on board the aircraft to adhere to the assigned flight profile. The pressure altitude ranges from minus 300 m (1 000 ft) to the maximum certificated altitude of aircraft plus 1 500 m (5 000 ft);
 - (3) On-the-ground status information;
 - (4) The Aircraft Identification as specified in Item 7 of the ICAO flight plan or the aircraft registration;
 - (5) Special Position Indication (SPI);
 - (6) Emergency status (Emergency, Radio communication failure, Unlawful interference);
 - (7) The data link capability report;
 - (8) The common usage GICB capability report;

- (9) The ICAO 24-bit aircraft address; and
 - (10) Aircraft that have ACAS II installed provide the ACAS active resolution advisory report.
- (b) All other data transmitted is verified.
- (1) If the system transmits one or more additional downlink airborne parameters in addition to those listed in paragraph (a), then the relevant sub specifications of CS ACNS.D.EHS.015 are also complied with.
 - (2) If the system transmits additional parameters on the extended squitter and if their full compliance with CS ACNS.D.ADSB has not been verified, as a minimum the aircraft identification, pressure altitude, ICAO 24-bit aircraft address is identical to those transmitted in the Mode S replies. Additionally the position and velocity quality indicators reports the lowest quality.

CS ACNS.D.ELS.020 On-the-ground status determination

(See AMC1 ACNS.D.ELS.020)

- (a) The on-the-ground status is not set by a manual action.
- (b) If automatic determination of the On-the-ground status is not available, the On-the-ground status is set to airborne.

CS ACNS.D.ELS.025 Altitude source

(See AMC1 ACNS.D.ELS.025)

- (a) The reported pressure altitude is obtained from an approved source.
- (b) The altitude resolution is equal to or less than 30.48 m (100 ft.).
- (c) The altitude source connected to the active transponder is the source being used to fly the aircraft.

CS ACNS.D.ELS.030 Flight deck interface

(See AMC1 ACNS.D.ELS.030)

- (a) A means is provided:
 - (1) to select Mode A Code, including emergency indicators;
 - (2) to initiate the IDENT (SPI) feature;
 - (3) for an aircraft identification to be inserted by the flight crew if the aircraft uses variable aircraft identification;
 - (4) to notify the flight crew when the transmission of pressure altitude information has been inhibited, if a means to inhibit the transmission of pressure altitude is provided;
 - (5) to select the transponder to the 'standby' or 'OFF' condition;
 - (6) to indicate the non-operational status or failure of the transponder system without undue delay and without the need for flight crew action;
 - (7) to display the selected Mode A code to the flight crew;
 - (8) to display the aircraft identification to the flight crew; and

- (b) Input which is not intended to be operated in flight, is not readily accessible to the flight crew.

SYSTEM PERFORMANCE REQUIREMENTS

CS ACNS.D.ELS.040 Integrity

The Mode S ELS airborne surveillance system integrity is designed commensurate with a 'minor' failure condition.

CS ACNS.D.ELS.045 Continuity

The Mode S ELS airborne surveillance system continuity is designed to an allowable qualitative probability of 'remote'.

INSTALLATION REQUIREMENTS

CS ACNS.D.ELS.050 Dual/multiple transponder installation

(See AMC1 ACNS.D.ELS.050)

If more than one transponder is installed, simultaneous operation of transponders is prevented.

CS ACNS.D.ELS.055 ICAO 24-bit Aircraft address

The ICAO 24-bit aircraft address assigned by the competent authority is correctly implemented on each transponder.

CS ACNS.D.ELS.060 Antenna installation

(See AMC1 ACNS.D.ELS.060)

- (a) The installed antenna(s) has (have) a resulting radiation pattern which is (are) vertically polarised, omnidirectional in the horizontal plane, and has (have) sufficient vertical beam width to ensure proper system operation during normal aircraft manoeuvres.
- (b) Antenna(s) is/are located such that the effect on the far field radiation pattern(s) by the aircraft structure are minimised.

CS ACNS.D.ELS.065 Antenna diversity

(See AMC1 ACNS.D.ELS.065)

Aircraft with a maximum certified take-off mass in excess of 5700 kg or a maximum cruising true airspeed capability, under International Standard Atmosphere (ISA) conditions, in excess of 130 m/s (250 knots) operates with an antenna diversity installation.

Section 3 — Mode S Enhanced Surveillance

GENERAL

CS ACNS.D.EHS.001 Applicability

(See AMC1 ACNS.D.EHS.001)

- (a) This section provides standards for airborne Mode S EHS installations which provide on request (through Mode S replies elicited by Mode S interrogations) airborne parameters in addition to parameters provided by ELS installations compliant with Section 2.

Note: The criteria that are applicable to airborne installations providing spontaneously (through ADS-B Extended Squitters) airborne parameters are specified in Section 4.

- (b) This certification specification is applied together with Mode S Elementary Surveillance certification specification defined in Section 2.

SYSTEM FUNCTIONAL REQUIREMENTS

CS ACNS.D.EHS.010 Transponder characteristics

(See AMC1 ACNS.D.EHS.010)

The transponder is an approved Mode S transponder with EHS capability.

CS ACNS.D.EHS.015 Data transmission

(See AMC1 ACNS.D.EHS.015)

- (a) The surveillance system provides in the Mode S reply the following downlink aircraft parameters in addition to those specified in CS ACNS.D.ELS.:
- (1) MCP/FCU Selected Altitude;
 - (2) Roll Angle;
 - (3) True Track Angle;
 - (4) Ground Speed;
 - (5) Magnetic Heading;
 - (6) Indicated Airspeed or Mach No ;
 - (7) Vertical rate: Barometric Altitude rate or Inertial vertical Velocity. When barometric altitude rate field is provided, it is derived solely from barometric measurement;
 - (8) Barometric Pressure Setting in use minus 80 000 Pascal; and
 - (9) Track Angle Rate or True Airspeed.
- (b) The sensor sources connected to the active transponder are the sensors relevant to the aircraft flight profile.
- (c) All transmitted parameters are correct and are correctly indicated as available.

SYSTEM PERFORMANCE REQUIREMENTS

CS ACNS.D.EHS.020 Integrity

The Mode S EHS airborne surveillance system integrity is designed commensurate with a 'minor' failure condition for the downlink aircraft parameters listed in CS ACNS.D.EHS.015.

CS ACNS.D.EHS.025 Continuity

The Mode S EHS airborne surveillance system continuity is designed to an allowable qualitative probability of 'probable' for the downlink aircraft parameters listed in CS ACNS.D.EHS.015.

Section 4 — 1090 MHz Extended Squitter ADS-B

GENERAL

CS ACNS.D.ADSB.001 Applicability

(See GM1 ACNS.D.ADSB.001)

This section provides standards for 1090 MHz Extended Squitter (ES) ADS-B Out installations.

SYSTEM FUNCTIONAL REQUIREMENTS

CS ACNS.D.ADSB.010 ADS-B Out system approval

(See AMC1 ACNS.D.ADSB.010)

The equipment contributing to the ADS-B Out function is approved.

ADS-B OUT DATA

CS ACNS.D.ADSB.020 ADS-B Out Data Parameters

(See AMC1 ACNS.D.ADSB.020(a-b))

(a) The ADS-B Out system provides the following minimum set of data parameters:

- (1) Aircraft Identification;
- (2) Mode A Code;
- (3) ICAO 24-bit aircraft address;
- (4a) Airborne Horizontal Position — Latitude and Longitude;
- (4b) Airborne Navigation Integrity Category: NIC;
- (4c) Airborne/Surface Navigation Accuracy Category for Position: NACp;
- (4d) Airborne/Surface Source Integrity Level: SIL;
- (4e) Airborne/Surface System Design Assurance: SDA;
- (5) Pressure Altitude (incl. NICbaro);
- (6) Special Position Identification (SPI);
- (7a) Emergency Status;
- (7b) Emergency Indication;
- (8) 1090 ES Version Number;
- (9a) Airborne velocity over Ground — (East/West and North/South);
- (9b) Airborne/Surface Navigation Accuracy Category for Velocity: NACv;
- (10) Emitter Category;

- (11) Vertical Rate;
 - (12a) Surface Horizontal Position — Latitude and Longitude;
 - (12b) Surface Navigation Integrity Category: NIC;
 - (13) Surface Ground Track;
 - (14) Movement (surface ground speed);
 - (15) Length/width of Aircraft;
 - (16) GPS Antenna Longitudinal Offset;
 - (17a) Geometric Altitude; and
 - (17b) Geometric Altitude Quality: GVA.
- (b) Where available in a suitable format, the ADS-B Out system provides the following data parameters:
- (1) Selected Altitude;
 - (2) Barometric Pressure Setting; and
 - (3) ACAS Resolution Advisory.

CS ACNS.D.ADSB.025 Provision of Data

(See AMC1 ACNS.D.ADSB.025(a)(c))

- (a) All data provided by the ADS-B Out system comes from approved sources.
- (b) The data transmitted by the ADS-B Out system originates from the same data source as used in the transponder replies to Mode S interrogations.
- (c) When a data quality indication is required, it is provided to the ADS-B transmit unit together with the associated data parameter and it expresses the actual quality of the respective data as valid at the time of applicability of the measurement.

ADS-B TRANSMIT UNIT

CS ACNS.D.ADSB.030 ADS-B Transmit Unit Approval

(See AMC1 ACNS.D.ADSB.030)

The ADS-B transmit unit is approved and it is integrated in the Mode S transponder.

CS ACNS.D.ADSB.035 ICAO 24-bit Aircraft address

The ICAO 24 bit aircraft address is implemented as specified in CS ACNS.D.ELS.055.

CS ACNS.D.ADSB.040 Antenna diversity

(See AMC1 ACNS.D.ADSB.040)

The ADS-B transmit unit employs antenna diversity under the same conditions as specified in CS ACNS.D.ELS.065.

CS ACNS.D.ADSB.045 Antenna installation

The antenna is installed as specified in CS ACNS.D.ELS.060.

CS ACNS.D.ADSB.050 Transmit power

The ADS-B transmit unit has a peak transmit power as specified in CS ACNS.D.ELS.010(c);(d).

CS ACNS.D.ADSB.055 Simultaneous operation of ADS-B transmit units

(See AMC1 ACNS.D.ADSB.055)

If more than one ADS-B transmit unit is installed, simultaneous operation of the transmit systems is prevented.

CS ACNS.D.ADSB.060 On-the-ground status determination

(See AMC1 ACNS.D.ADSB.060)

- (a) The on-the-ground status is determined and validated by the ADS-B Out system.
- (b) The on-the-ground status is not set by a manual action.

HORIZONTAL POSITION AND VELOCITY DATA SOURCES

CS ACNS.D.ADSB.070 Horizontal Position and Velocity Data Sources

(See AMC1 ACNS.D.ADSB.070)

- (a) The horizontal position is derived from GNSS data.
- (b) The GNSS receiver based horizontal position and velocity data source is approved and performs, as a minimum, horizontal position receiver autonomous integrity monitoring (RAIM) and fault detection and exclusion (FDE).
- (c) Horizontal velocity data stems from the same source as horizontal position data.

OTHER DATA SOURCES

CS ACNS.D.ADSB.080 Data Sources as defined by Mode S Elementary and Enhanced Surveillance

(See AMC1 ACNS.D.ADSB.080)

The data source requirements as defined for in section 2 and 3 of this subpart, are applicable.

CS ACNS.D.ADSB.085 Geometric Altitude

(See AMC1 ACNS.D.ADSB.085)

- (a) Geometric Altitude is provided by the horizontal position and velocity source (see CS ACNS.D.ADSB.070).
- (b) Geometric Altitude is transmitted as height above WGS-84 ellipsoid.

FLIGHT DECK CONTROL AND INDICATION CAPABILITIES

CS ACNS.D.ADSB.090 Flight deck interface

(See AMC1 ACNS.D.ADSB.090(a) and AMC1 ACNS.D.ADSB.090(b))

- (a) The control and display of surveillance data items is as per CS ACNS.D.ELS.030.
- (b) A means is provided to indicate the non-operational status or failure of the ADS-B Out system without undue delay.

SYSTEM PERFORMANCE REQUIREMENTS

CS ACNS.D.ADSB.100 Integrity

- (a) The ADS-B Out system integrity is designed commensurate with a 'major' failure condition for the transmission of the following parameters:
 - (1) ICAO 24-bit aircraft address;
 - (2) Airborne Horizontal Position — Latitude and Longitude;
 - (3) Airborne Navigation Integrity Category: NIC;
 - (4) Airborne/Surface Navigation Accuracy Category for Position: NACp;
 - (5) Airborne/Surface Source Integrity Level: SIL;
 - (6) Airborne/Surface System Design Assurance: SDA;
 - (7) 1090 ES Version Number;
 - (8) Airborne velocity over Ground — East/West and North/South;
 - (9) Airborne/Surface Navigation Accuracy Category for Velocity: NACv;
 - (10) Emitter Category;
 - (11) Surface Horizontal Position — Latitude and Longitude;
 - (12) Surface Navigation Integrity Category: NIC;
 - (13) Surface Ground Track;
 - (14) Movement (surface ground speed);
 - (15) Length/width of Aircraft;
 - (16) GPS Antenna Offset;
 - (17) Geometric Altitude;
 - (18) Geometric Altitude Quality: GVA;
- (b) The ADS-B Out system integrity is designed commensurate with a 'minor' failure condition for the transmission of other data parameters.

CS ACNS.D.ADSB.105 Continuity

- (a) The ADS-B Out system continuity is designed to an allowable qualitative probability of 'remote'.

HORIZONTAL POSITION AND VELOCITY DATA REFRESH RATE AND LATENCY

CS ACNS.D.ADSB.110 Horizontal Position and Velocity Data Refresh Rate

(See AMC1 ACNS.D.ADSB.110)

A horizontal position and velocity source calculates position and velocity data with a rate of at least 1 Hertz.

CS ACNS.D.ADSB.115 Horizontal Position and Velocity Total Latency

(See AMC1 ACNS.D.ADSB.115 and 120)

Measured from the time of applicability within the source, the total latency of the horizontal position and horizontal velocity data introduced by the ADS-B Out system does not exceed 1.5 second.

CS ACNS.D.ADSB.120 Horizontal Position Uncompensated Latency

(See AMC1 ACNS.D.ADSB.115 and 120)

The uncompensated latency of the horizontal position data introduced by the ADS-B Out System does not exceed 0.6 second.

Subpart E — Others

SECTION 1 – TERRAIN AWARENESS AND WARNING SYSTEM (TAWS)

General

CS ACNS.E.TAWS.001 Applicability

(See GM1 ACNS.E.TAWS.001)

This section provides the airworthiness standards applicable to Terrain Awareness and Warning System Class A and Class B for aeroplanes.

CS ACNS.E.TAWS.005 TAWS Equipment Approval

(See AMC1 ACNS.E.TAWS.005)

The TAWS is Class A or Class B approved equipment.

System functional requirements

CS ACNS.E.TAWS.010 Required Functions and Interfaces

(See AMC1 ACNS.E.TAWS.010, AMC2 ACNS.E.TAWS.010)

TAWS Class A or Class B provides suitable alerting and warning capabilities and other system interfaces to support the following functions:

TAWS System Function		Class A TAWS	Class B TAWS
Alerting	Imminent contact with ground indications (GPWS functions) including: (19) excessive Rates of Descent; (20) negative Climb Rate or Altitude Loss After Take-Off or Go-around. A Voice callout when descending through a predefined altitude above the terrain or nearest runway elevation.	X With a 500 ft call out	x With a 500 ft call out
	A forward Looking Terrain Avoidance (FLTA) function, including: <ul style="list-style-type: none"> • a Reduced Required Terrain Clearance (RTC) function; • an Imminent Terrain Impact function; • a FLTA Turning Flight function. 	x	x

	A Premature Descent Alert (PDA) function, including detection and alerting for Premature Descents Along the Final Approach Segment	x	x
	Excessive Closure Rate to Terrain	x	
	Flight Into Terrain When not in Landing Configuration	x	
	Excessive Downward Deviation from a glide slope or glide path	x	
	TAWS and sensor failure monitoring and annunciation function	x	x
	Capability to initiate the TAWS self-test function on the ground and where feasible in the air	x	x

TAWS System Interfaces		Class A TAWS	Class B TAWS
	A terrain display capability	x	
	Capability to drive a terrain display		x
	The use of position source input	x	x
	The use of landing guidance deviation input	x	
	The use of radio altimeter sensor input	x	
	The use of Terrain and Airport information	x	x
	Interface with the flight recording system to record TAWS alerts and inhibition of the FLTA or PDA functions	x	x
	The use of landing gear and flaps position	x	
	The use of roll attitude input	x	
	The interface with flight deck audio systems	x	

CS ACNS.E.TAWS.015 FLTA function requirements

(See AMC1 ACNS.E.TAWS.015)

Provide an FLTA function that:

- (a) Provides an Forward Looking Terrain Avoidance (FLTA) function that looks ahead of the airplane along and below the airplane’s lateral and vertical flight path and provides suitable alerts if a potential CFIT threat exists.
- (b) Provides a Required Terrain Clearance (RTC) alerts when the aeroplane is currently above the terrain in the aeroplane’s projected flight path but the projected amount of terrain clearance is considered unsafe for the particular phase of flight.

TAWS REQUIRED TERRAIN CLEARANCE (RTC) BY PHASE OF FLIGHT	TAWS (RTC) Level Flight	TAWS (RTC) Descending /climbing
En route	215 m (700 ft)	150 m (500 ft)
Terminal (Intermediate Segment)	105 m (350 ft)	90 m (300 ft)
Approach	45 m (150 ft)	30 m (100 ft)
Departure (above 400 ft)	30 m (100 ft)	30 m (100 ft)

TABLE 1

- (c) gives Imminent Terrain Impact alerts when the aeroplane is currently below the elevation of a terrain cell along the aeroplane’s lateral projected flight path and, based upon the vertical projected flight path, the equipment predicts that the terrain clearance will be less than the value given in the RTC column of Table 1.
- (d) gives alerts for the Imminent Terrain Impact and Required Terrain Clearance functions when the aeroplane is in turning flight.

CS ACNS.E.TAWS.020 PDA function requirements

(See GM1 ACNS.E.TAWS.020)

Provide a Premature Descent Alert function:

- (a) to determine if the aeroplane is significantly below the normal approach flight path to a runway and in such a case issue an alert, based on the current position and flight path information of the aeroplane, as determined from a suitable navigation source and airport database;
- (b) that is available on all types of instrument approaches including straight-in approaches, circling approaches and approaches that are not aligned within 30 degrees of the runway heading.

CS ACNS.E.TAWS.025 Class A TAWS inhibition

(See AMC1 ACNS.E.TAWS.025)

A means is provided to:

- (a) the flight crew to inhibit the FLTA and PDA functions together with appropriate annunciation of the inhibited condition. Inhibiting FLTA and PDA does not impact the Basic GPWS functions;
- (b) indicate to the flight crew of the ‘Inhibit status’.

CS ACNS.E.TAWS.030 Terrain information display

(See AMC1 ACNS.E.TAWS.030)

- (a) When terrain information is provided it is clearly visible to the flight crew.
- (b) Terrain information is displayed as follows:
 - (1) The terrain is depicted relative to the aeroplane’s position such that the pilot may estimate the relative bearing and distance to the terrain of interest.

- (2) The terrain depicted is oriented in accordance with the orientation of the navigation information used on the flight deck.
 - (3) Variations in terrain elevation depicted relative to the aeroplane's elevation (above and below) are visually distinguishable.
 - (4) Terrain that generates alerts is displayed in a manner to distinguish it from non-hazardous terrain, consistent with the caution and warning alert level.
 - (5) If the terrain is presented on a multi-function display, the terrain mode and terrain information is distinguishable from weather and other features.
 - (6) Terrain information is readily available and displayed with sufficient accuracy and in a manner to allow the flight crew to determine if it is a terrain threat to the aeroplane.
- (c) The display of terrain data complements and is compatible with the terrain alerting function of the TAWS.
 - (d) The terrain information is clear and unambiguous, available without potential confusion during day and night operations under all ambient conditions expected in service.
 - (e) Where additional terrain views are provided, they must present information consistent and compatible with (a) to (e) above.

CS ACNS.E.TAWS.035 Aural and visual alerts

(See AMC1 ACNS.E.TAWS.035)

- (a) The TAWS provides suitable aural and visual alerts for each of its functions.
- (b) Aural and visual alerts are initiated simultaneously, except when suppression of aural alerts is necessary to protect pilots from nuisance aural alerting.
- (c) Each aural alert identifies the reason for the alert.
- (d) The system is capable of accepting and processing aeroplane performance related data or aeroplane dynamic data and providing the capability to update aural and visual alerts at least once per second.
- (e) The aural and visual outputs are compatible with the standard cockpit displays and auditory systems.
- (f) The visual display of alerting information is continuously displayed until the situation is no longer valid.

System performance requirements

CS ACNS.E.TAWS.040 Integrity

- (a) Integrity of the TAWS (including un-enunciated loss of the terrain alerting function) is designed commensurate with a major failure condition.
- (b) False terrain alerting is designed commensurate with a minor failure condition.
- (c) Failure of the installed TAWS does not degrade the integrity of any critical system interfacing with the TAWS.

CS ACNS.E.TAWS.045 Continuity

Continuity of the TAWS is designed to an allowable qualitative probability of 'probable'.

CS ACNS.E.TAWS.050 GPWS

The predictive terrain hazard warning functions, does not adversely affect the functionality, reliability or integrity of the basic GPWS functions.

CS ACNS.E.TAWS.055 Terrain and airport information

(See AMC1 ACNS.E.TAWS.055)

- (a) Terrain and airport information are developed in accordance with an acceptable standard.
- (b) TAWS is capable of accepting updated terrain and airport information.

CS ACNS.E.TAWS.060 Positioning information

(See AMC1 ACNS.E.TAWS.060)

- (a) The positioning information (i.e. horizontal and vertical position, velocity, or rate of information) is provided from an approved positioning source.
- (b) For Class B TAWS, GNSS is the only approved horizontal positioning source.
- (c) When the TAWS positioning source is the same as the one used by the primary navigation system and provided that, applicable performance requirements are satisfied for navigation, a failure of the TAWS (including loss of electrical power to the TAWS) does not degrade the primary navigation capability.
- (d) When a positioning source generates a fault indication or any flag indicating the position is invalid or does not meet performance requirements, the TAWS is to stop utilising that positioning source.
- (e) The positioning source for the predictive terrain hazard warning system accuracy is suitable for each phase of flight and/or region of operations.
- (f) The TAWS provides indications, as appropriate, regarding degradation or loss of function associated with the loss of the positioning source.

Installation requirements

CS ACNS.E.TAWS.070 Failure mode

- (a) A failure of the TAWS does not disable other protection functions (e.g. windshear or weather radar).
- (b) The failure of the GPWS functions, except for power supply failure, input sensor failure, or other failures external to the TAWS functions, does not negatively alter the FLTA function, PDA function, or Terrain Display and vice versa.
- (c) Where the terrain information is displayed on a multi-function display, failure of the TAWS does not prevent the normal functioning of other systems using that display.

CS ACNS.E.TAWS.075 Prioritisation scheme

(See AMC1 ACNS.E.TAWS.075)

The prioritisation scheme for Class A TAWS alerts is compatible and consistent with other alerts including voice call outs from all alerting systems.

CS ACNS.E.TAWS.080 Pop-up mode

(See AMC1 ACNS.E.TAWS.080)

- (a) If implemented, the design of an automatic pop-up function ensures that:
- (1) the terrain information is automatically displayed on all crew member terrain displays, when either a predictive terrain caution or a predictive terrain warning alert occurs;
 - (2) the TAWS pop-up function is consistent with pop-up weather and traffic alerts;
 - (3) it is evident that an automatic pop-up has occurred;
 - (4) the terrain display mode is annunciated on the display;
 - (5) manual switching back to the original display mode is simple.

SECTION 2 – REDUCED VERTICAL SEPARATION MINIMUM (RVSM)

General

CS ACNS.E.RVSM.001 Applicability

(See AMC1 ACNS.E.RVSM.001)

This section provides airworthiness standard for aircraft to operate a 300 m (1000 ft) vertical separation within RVSM airspace.

CS ACNS.E.RVSM.005 RVSM system

(See AMC1 ACNS.E.RVSM.005)

The RVSM system includes:

- (a) two independent altitude measurement systems. Each system is composed of the following elements:
 - (1) Cross-coupled static source/system, with ice protection if located in areas subject to ice accretion;
 - (2) Equipment for measuring static pressure sensed by the static source, converting it to pressure altitude;
 - (3) Equipment for providing a digitally encoded signal corresponding to the displayed pressure altitude, for automatic altitude reporting purposes;
 - (4) Static source error correction (SSEC), as required to meet the performance criteria as specified in CS ACNS.E.RVSM.035; and
 - (5) Signals referenced to a pilot selected altitude for automatic control and alerting derived from one altitude measurement system.
- (b) an altitude alerting system;
- (c) an automatic altitude control system; and
- (d) a secondary surveillance radar (SSR) transponder with altitude reporting system that can be connected to the altitude measurement system in use for altitude keeping.

System functional requirements

CS ACNS.E.RVSM.010 Required functions

(See AMC1 ACNS.E.RVSM.010)

The system:

- (a) provides indication to the flight crew of the pressure altitude being flown;
- (b) based on the signal produced by the altimetry system, automatically maintains a selected flight level with its altitude control system;

- (c) provides an alert to the flight crew when the altitude displayed to the flight crew deviates from the selected altitude by a value of ± 60 m (± 200 ft) or greater;
- (d) automatically reports pressure altitude;
- (e) provides an output to the aircraft transponder.

System performance requirements

CS ACNS.E.RVSM.020 Integrity

The RVSM system integrity is designed commensurate with a 'major' failure condition.

CS ACNS.E.RVSM.025 Continuity

The RVSM system continuity is designed to an allowable qualitative probability of 'remote'.

CS ACNS.E.RVSM.030 RVSM system performance

(See AMC1 ACNS.E.RVSM.030)

- (a) The automatic altitude control system controls the altitude within ± 20 m (65 ft) about the selected altitude, when the aircraft is operated in straight and level flight under non-turbulent non-gust conditions.
- (b) The tolerance of the alert issued when the altitude displayed to the flight crew deviates from the selected altitude by a value of ± 60 m (± 200 ft) or greater is no greater than ± 15 m (± 50 ft).
- (c) Where an altitude select/acquire function is provided, the altitude select/acquire control panel is configured such that an error of no more than ± 8 m (± 25 ft) exists between the value selected by, and displayed to, the flight crew, and the corresponding output to the control system.

CS ACNS.E.RVSM.035 Altimetry system accuracy

(See AMC1 ACNS.E.RVSM.035, GM1 ACNS.E.RVSM.035)

- (a) For Group aircraft, the altimetry system accuracy meets the following criteria in the full envelope:
 - (1) At the point of the flight envelope where the mean ASE (ASE_{mean}) reaches its largest absolute value that value does not exceed 25 m (80 ft);
 - (2) At the point of the flight envelope where the absolute mean ASE plus three standard deviations of ASE (ASE_{3SD}) reaches its largest absolute value, the absolute value does not exceed 60 m (200 ft).
- (b) For RVSM installations on a non-group aircraft, the altimetry system accuracy meets the following criteria:
 - (1) For all conditions in the basic envelope:
 - | residual static source error +worst case avionics | does not exceed 50 m (160 ft).
 - (2) For all conditions in the full envelope (outside the basic envelope):
 - | residual static source error +worst case avionics | does not exceed 60 m (200 ft).

CS ACNS

Book 2

**Acceptable Means of Compliance (AMC)
and
Guidance Material (GM)**

(a) GENERAL

Book 2 contains Acceptable Means of Compliance (AMC) and Guidance Material (GM).

(b) PRESENTATION

- (1) The Acceptable Means of Compliance and Guidance Material are presented in full page.
- (2) A numbering system has been used in which the Acceptable Means of Compliance and Guidance Material use the same number as the paragraph in Book 1 to which they are related. The number is introduced by the letters AMC (Acceptable Means of Compliance) or GM (Guidance Material) to distinguish the material from Book 1. Reference to the Acceptable Means of Compliance and/or Guidance Material, when applicable, is included in the heading of each Book 1 paragraph.
- (3) Explanatory Notes, not forming part of the AMC text, appear in italic typeface.
- (4) The units of measurement used in this document are in accordance with the International System of Units (SI) specified in Annex 5 to the Convention on International Civil Aviation. Non-SI units are shown in parentheses following the base units. Where two sets of units are quoted, it should not be assumed that the pairs of values are equal and interchangeable. It may be inferred, however, that an equivalent level of safety is achieved when either set of units is used exclusively.

Subpart A — General

AMC1 ACNS.A.GEN.010 Instructions for Continued Airworthiness

(a) Transponder testing

The Instructions for Continued Airworthiness should include the following measures and precautions in order to minimise the possibility of causing nuisance warnings to ACAS equipped aircraft.

- (1) When not required, ensure all transponders are selected to 'OFF' or 'Standby'.
- (2) Before starting any test, contact the local Air Traffic Control Unit and advise them of your intention to conduct transponder testing. Advise the Air Traffic Unit of your start time and test duration. Also inform them of the altitude(s) at which you will be testing, your intended Aircraft Identification (Flight Id) and your intended Mode A code.

Note: Certain altitudes may not be possible due to over flying aircraft.

- (3) Set the Mode A code to 7776 (or other Mode A code agreed with Air Traffic Control Unit).

Note: The Mode A code 7776 is reserved for SSR ground transponder monitoring. This code may be used for transponder testing after having received agreement from the Air Traffic Control Unit.

- (4) Set the Aircraft Identification (Flight Id) with the first 8 characters of the company name. This is the name of the company conducting the tests.
- (5) Set the on-the-ground status for all Mode S replies, except when an airborne reply is required (e.g. for altitude testing).
- (6) Where possible, perform the testing inside a hangar to take advantage of any shielding properties it may provide.
- (7) As a precaution, use antenna transmission covers whether or not testing is performed inside or outside.
- (8) When testing the altitude (Mode C or S) parameter, radiate directly into the ramp test set via the prescribed attenuator.
- (9) In between testing, i.e., to transition from one altitude to another, select the transponder to 'standby' mode.
- (10) If testing transponder parameters other than 'altitude', set altitude to minus 300 m (minus 1 000 feet) or over 18 250 m (60 000 feet). This will minimise the possibility of ACAS warning to airfield and overflying aircraft.
- (11) When testing is complete, select the transponder(s) to 'OFF' or 'Standby'.

(b) Reduced Vertical Separation Minima

When developing the instructions for continued airworthiness, attention should be given to the following items:

- (1) All RVSM equipment should be maintained in accordance with the component manufacturers' maintenance instructions and the performance criteria of the RVSM approval data package.
- (2) Any repairs, not covered by approved maintenance documents, that may affect the integrity and accuracy of the altimeter system, e.g. those affecting the alignment of pitot/static probes,

repairs to dents or deformation around static plates should be subject to a design review which is acceptable to the competent authority.

- (3) Airframe geometry or skin waviness checks should be performed following repairs or alterations which have an effect on airframe surface and airflow.
- (4) The maintenance and inspection programme for the autopilot should ensure continued accuracy and integrity of the automatic altitude control system.

AMC1 ACNS.A.GEN.015(a) Aircraft documentation

An acceptable means of compliance in the case of aircraft PBN capabilities is to specify in the documentation which of the following navigation specifications and functionalities the aircraft is certified for:

- (a) RNAV 10,
- (b) RNAV 5,
- (c) RNAV 2,
- (d) RNAV 1,
- (e) RNP 4,
- (f) RNP 2,
- (g) RNP 1,
- (h) RNP 0.3,
- (i) A-RNP,
- (j) RNP APCH,
- (k) RNP AR (for approach and/or departures),
- (l) RF (specify the associated navigation specifications),
- (m) FRT,
- (n) parallel offset.

[Issue: CS-ACNS/2]

Subpart B — Communications (COM)

SECTION 1 - VOICE CHANNEL SPACING (VCS) (8.33 KHZ)

AMC1 ACNS.B.VCS.010 Voice Communication Systems

The VCS equipment composing of the system should be approved in accordance with ETSO-2C37e, ETSO-2C38e or ETSO-2C169a.

For the 25 kHz channel spacing off-set carrier frequency operations the equipment composing the system should conform with the requirements of EUROCAE document ED-23C.

In airspace where 8.33 kHz channel spacing communication equipment is mandatory and the carriage of two radios is required, both radios should be 8.33 kHz capable (as opposed to one 8.33 kHz system and one 25 kHz system).

AMC1 ACNS.B.VCS.030 Continuity

For aircraft that are foreseen to be operated within airspace where continuous air-ground voice communications is required, the continuity of the voice communication system is designed to an allowable qualitative probability of 'remote', except for

- (a) Class I aircraft, as defined in FAA AC 23-1309-1E, certified to a CS-23 amendment prior to 5, and;
- (b) aircraft with type code 1SRXXXXX or 2SRXXXXX as defined in ASTM International Standards F3061/F3061M – 17 and certified to CS-23 Amendment 5 or subsequent amendments

where the continuity of the voice communication system may be designed to an allowable qualitative probability of 'probable'.

[Issue: CS-ACNS/2]

GM1 ACNS.B.VCS.030 Continuity

Information about European Union requirements for continuous air-ground communications is provided in Commission Implementing Regulation (EU) No 923/2012 of 26 September 2012 laying down the common rules of the air and operational provisions regarding services and procedures in air navigation. Specific requirements for the operation of radio equipment may be found in the respective States' aeronautical information publications (AIPs).

Aircraft type codes are defined in ASTM International Standards F3061/F3061M – 17, Standard Specification for Systems and Equipment in Small Aircraft.

[Issue: CS-ACNS/2]

AMC1 ACNS.B.VCS.040 Flight Deck Interface

Flight Crew control and display of communication frequencies information should be consistent with the overall crew flight deck design philosophy.

SECTION 2 –DATA LINK SERVICES

General

GM1.ACNS.B.DLS.B1.001 Applicability

Controller pilot communications through data link is used in different airspaces worldwide. Different technologies are used, and this CS is intended to provide the airworthiness standard for such installations. Additionally, controller pilot communications over ATN B1 data link technology has been mandated in Europe, through the Regulation (EC) No 29/2009. Installations intended to operate within EU Airspace defined in mentioned regulation, should fully comply with all requirements of 'DATA LINK SERVICES' section, in its entirety.

Installations not intended to operate within EU Airspace, are not required to comply with mentioned section.

Note: Requirements CS ACNS.B.DLS.B1.010 and 015 are also applicable for CPDLC installations where, additionally to ATN B1 over VDL M2, other means of communications and other services are also provided.

GM1 ACNS.B.DLS.B1.005 Data Link System Installation

An example of installation may be a system comprising the following components or inputs:

A VHF Data Radio (VDR) with Mode 2 capability and its associated antenna.

A Unit for Communication Management with Mode 2 and ATN capabilities

A display unit with means for crew to be notified of ATS Requests and Clearances, and issue downlink crew requests to controllers or responses to outstanding messages (from controllers).

An adequate source for UTC time e.g. a Global Navigation Satellite System (GNSS).

An adequate source for conducted flight plan information (Departure Airport, Destination Airport, Estimated Time of Arrival) e.g. Flight Management System (FMS)

An adequate source of aeroplane position e.g. Flight Management System (FMS), or a Global Navigation Satellite System (GNSS) or both

An adequate source for Air/Ground Status information e.g. an interface with the landing gear or Flight Management System (FMS) or both

An adequate aural attention getter for announcements.

Adequate indication means of system and service availability.

Adequate control means for the crew.

Flight Deck Control and Indication Capabilities

AMC1 ACNS.B.DLS.B1.010 Flight Deck Interface

Flight crew control and display of data link related information (connectivity status, outstanding messages, etc.) should be consistent with the overall crew flight deck design philosophy.

Flight crew control and display of data link messages should satisfy integrity and interface design criteria appropriate for the intended purpose. Reference to the applicable CS xx.1309 requirements should be observed.

If a direct interface exists between the data link application and other on board systems, (e.g. flight planning and navigation), a means may be provided for the flight crew to initiate the use of the data contained in the message by the other on board system. The means provided should be separate from that used to respond to a message.

Flight deck annunciations should be compatible with the overall alerting scheme of the aircraft.

Audible and visual indications should be given by the data link system for each uplinked ATS message, including those messages not displayed immediately because of lack of crew response to an earlier ATS message. Visual alerts alone may be used for non-ATS messages.

Annunciation of the receipt of a message during critical flight phases should be inhibited until after the critical flight phase. The criteria that define critical flight phases should be consistent with the particular flight deck philosophy and the particular data link services supported.

Means should be provided for the flight crew to list, select, and retrieve the most recent ATS messages received and sent by the flight crew during the flight segment. The status of each message, the time it was received or sent, should be accessible.

When CPDLC messages are displayed:

- (a) such location should be in the Primary Field of View.
- (b) messages should be provided in a dedicated display (or in a dedicated window of a display). Shared use of CPDLC and other applications in a common display (or in the same window of a display) should be avoided.

Note 1: (a) and (b) are intended for future extension of CPDLC use beyond en-route flight phase. Installations not in accordance with these recommendations are liable to be limited for CPDLC operations in the en-route or prior departure flight phase.

Note 2: Where data link messages are displayed on a shared display or on a shared display area, selection of another display format or function should not result in the loss of uplinked messages which are waiting for a response. In case the pilot is working on another task and a message is uplinked, the uplinked message should not interrupt the current work, nor result in the loss of any uplinked message and/or data entered while accomplishing the other task.

- (c) messages from the ATS should remain displayed until responded, cleared or the flight crew selects another message.
- (d) means should be provided for the flight crew to clear uplinked messages from the display. However, this capability should be protected against inadvertent deletion.

Means should be provided for the flight crew to create, store, retrieve, edit, delete, and send data link messages.

The data link system should indicate when message storage and/or printing is not available.

A flight deck printer could be used as a means of storing data communications messages received or sent during flight.

If a message intended for visual display is greater than the available display area and only part of the message is displayed, a visual indication shall be provided to the pilot to indicate the presence of remaining message.

Data link messages from the ATS should be displayed and remain displayed until responded, cleared or the flight crew selects another message.

The status of each message (i.e. source, time sent, open/closed) should be displayed together with the message.

AMC1.ACNS.B.DLS.B1.015 Dual Data Link Capabilities (Dual stack)

Note: A Dual stack system is either a bilingual system capable of automatically selecting the data link network or a dual system that use manual selection with an interlock system.

The data link system should comply with ED-154A, interoperability requirements IR-207, IR-209, IR-210, IR-211, IR-212, IR-214, and IR-215 to ensure seamless transition between two adjacent ATSU, one using FANS 1/A+ and the other using ATN B1.

The data link system should demonstrate common accessibility to the FANS 1/A and ATN B1 CPDLC applications. Accessibility demonstration should include common controls (i.e. line select keys) or, where different, the potential to introduce confusion or unacceptable flight crew workload should be evaluated.

The data link system should demonstrate common control and input procedures for retrieving and responding to FANS 1/A and ATN B1 uplink messages.

The data link system should demonstrate common control and input procedures for composing and sending FANS 1/A and ATN B1 downlink messages.

The data link system should demonstrate common flight deck indications for incoming FANS 1/A and ATN B1 messages. Where common alerting is not demonstrable, the alerting scheme evaluate to ensure that neither confusion nor unnecessary flight crew workload is introduced.

Annunciations and indications should be clear, unambiguous, timely, and consistent with the flight deck philosophy.

FANS 1/A differentiates messages alerting between normal and Urgent. Upon receipt of a high alert CPDLC message, the data link system should indicate it to the flight crew.

Note: FANS 1/A standard (ED-100A) identifies the term ‘IMMEDIATELY’, within the phraseology standardised for CPDLC communications. This term is to be understood within the required communications performance scope (RCP), which for oceanic and remote operations is either 240 seconds or 400 seconds. The use of these terms ‘IMMEDIATELY’ and ‘EXPEDITE’ are not to be confused with the terminology used in material related to CS 25.1322. However, annunciations and indications should allow flight crews to easily identify these messages (associated with Urgent and Distress urgency attribute) among the normal messages.

Flight Deck Display of Messages from either FANS 1/A or ATN B1 CPDLC Applications:

A common flight deck display should be capable of displaying messages with the same operational intent resulting from same message elements that may be implemented differently between FANS 1/A and ATN B1 CPDLC applications. The common format to display FANS 1/A messages may be in accordance with the preferred format denoted in Annex A of ED 122, which is consistent with Doc 4444, 15th Ed, and ATN B1 message formats.

Dual Stack ATS Data Link System Status Indication:

The system should provide the flight crew with a means to clearly identify the status of different modes of the data link system that affect significant operational capability. Examples of different modes of data link may include situations when downlink messages are available in one airspace, but not the other; or messages that may or may not be loadable depending on system status, i.e., ATN B1 or FANS 1/A.

ATSU Connections and Handoffs:

The system should be capable of the following functions:

- (1) Proper connection and termination for FANS 1/A ATSU.
- (2) Proper connection and termination for ATN B1 ATSU.
- (3) Transfer to next data authority (e.g., FANS 1/A ATSU to ATN B1 ATSU), in both directions. This should include proper connection, maintenance of connection and connection termination protocol to ensure that aircraft does not hold two simultaneous active CPDLC connections.
- (4) Ability for flight crew to manually terminate existing connection and establish new connection, initiate a DLIC 'logon' in both directions (i.e., FANS 1/A-to-ATN B1 and ATN B1-to-FANS 1/A).
- (5) Ability for flight crew to verify current and next facility designation or name.

Note: FAA AC 20-140A provides adequate guidance related to the application interoperability, sub-networks and performance designators. (refer to Tables 5.1 and 5.2).

ATN B1 Data link**AMC1 ACNS.B.DLS.B1.020 Data Link Services**

When the aircraft has no CPDLC Current Data Authority, the data link aircraft equipment should provide crew members entering an airspace of a data link equipped ATS unit with the capability to initiate a DLIC 'Logon' function (e.g. send a CMLogonRequest message) with the applicable ATS unit, in order to identify the aircraft and initiate the use of data link services.

GM1 ACNS.B.DLS.B1.020 Data Link Services

Community Specification EN 303 214 'Data Link Services (DLS) System' provides a set of test scenarios that demonstrated using verified ground data link system or ground data link system simulator.

GM1 ACNS.B.DLS.B1.020 Data Link Services**(a) Data Link Initiation Capability (DLIC) Service**

The DLIC service enables the exchange of information between aircraft and ground data link equipment necessary for the establishment of data link communications. It ensures:

- (1) the unambiguous association of flight data from the aircraft with flight plan data used by an ATS unit;
- (2) the exchange of the supported air-ground application type and version information;
- (3) the delivery of the addressing information of the entity hosting the application.

(b) **ATC Communications Management (ACM) Service**

The ACM service provides automated assistance to flight crews for conducting the transfer of ATC communications (voice and data). It includes:

- (1) the initial establishment of CPDLC with an ATS unit;
- (2) the CPDLC ATC transfer instruction from one ATS unit to the next ATS unit;
- (3) the CPDLC ATC instructions for a change in voice channel;
- (4) the normal termination of CPDLC with an ATS unit.

(c) **ATC Clearances and Information (ACL) Service**

The ACL service provides flight crews with the ability to:

- (1) send requests and reports to air traffic controllers;
- (2) receive clearances, instructions and notifications issued by air traffic controllers to flight crews.

(d) **ATC Microphone Check (AMC) Service**

The AMC service provides CPDLC ATC instructions to flight crew(s) requesting him/them to verify the status of his/their voice communication equipment.

AMC1 ACNS.B.DLS.B1.025 Protection mechanism

The data link system should comply with the following applicable ATN Baseline 1 standards:

- ICAO Document 9705 (Edition 2) for ICS (Sub-Volume V), ULCS (Sub-Volume IV), CM CPDLC (Sub-Volume II) ASE requirements;
- EUROCAE Document ED-110B;
- ICAO Document 9776 and ARINC 631-6 for VDL Mode 2 multi-frequency operations.

The data link aircraft equipment should provide support for the CPDLC application message integrity check mechanism, with support for 'default checksum algorithm' only.

AMC2 ACNS.B.DLS.B1.025 Protection mechanism

Testing demonstrations could be based in two main steps:

- Equipment testing (done by equipment manufacturer) using adequate simulation testing tools.
- System testing, at system test bench and/or at aircraft test level (either on ground or in flight).

Equipment qualification testing data may be reused from the avionics manufacturer, provided that full and unrestricted access to the compliance data is established and maintained. However, the applicant remains responsible for all test data used in the course of compliance demonstration.

AMC3 ACNS.B.DLS.B1.025 Protection mechanism

Where ARINC 631-6 identifies a specific deviation from ICAO Doc 9776 (Manual on VDL Mode 2), the provisions of the former should take precedence.

ARINC 631-6 also references ARINC 750 for definition of Signal Quality Parameter (SQP) levels. Measurements of SQP levels may be passed over the air-ground link as parameters in the XID exchanges.

GM1 ACNS.B.DLS.B1.025 Protection mechanism

EUROCAE Document ED-110B sections 3.3.5.1 and 3.3.6 mentions an 'ATN Message Checksum Algorithm' (or 'Application Message Integrity Check (AMIC)') that does not exist in ICAO Document 9705 Edition 2. These terms are correctly referenced in ICAO Doc 9705 PDR M60050001.

GM2 ACNS.B.DLS.B1.025 Protection mechanism

Both ICAO Document 9705 and EUROCAE Document ED-110B include requirements for the support of FIS and ADS-C applications. These two applications are not mandated for operations in European airspace. Data link aircraft implementations are free to support these applications and should notify their application availability in the DLIC logon function.

GM3 ACNS.B.DLS.B1.025 Protection mechanism

Further guidance material from EUROCONTROL is available on EUROCONTROL website (www.eurocontrol.int):

- LINK2000+/ATC DATA LINK OPERATIONAL GUIDANCE, Version 6.0, Date: 17 December 2012.
- LINK 2000+ Guidance to Airborne Implementers, Version 1.1, Date: 09 December 2009.
- LINK2000+/FLIGHT CREW DATA LINK OPERATIONAL GUIDANCE Version 5.0, Date: 17 December 2012.
- LINK2000+ Programme, Generic Interop Test Plan for Avionics - Part 1, Upper Layers and CM/CPDLC applications, Version 2.3, Date: 15th June 2010.

Time

AMC1 ACNS.B.DLS.B1.040 Universal Time Coordinated (UTC)

A Global Navigation Satellite System (GNSS) sensor provides an acceptable source of synchronised UTC time.

Time synchronisation is required by ICAO Annex II, chapter 3, section 3.5 as referred by EUROCAE Document ED-110B, section 3.3.2. It is also identified as a safety requirement in EUROCAE Document ED-120 (e.g. SR-ACL-15).

Data link initiation capability (DLIC) service messages

AMC1 ACNS.B.DLS.B1.050 DLIC Uplink Messages

Data link aircraft equipment should comply with ICAO Doc 9705 (Edition 2), section 2.1.4 and EUROCAE Document ED-110B, section 2.2.1.

AMC1 ACNS.B.DLS.B1.055 DLIC Downlink Messages

Data link aircraft equipment should comply with ICAO Doc 9705 (Edition 2), section 2.1.4 and EUROCAE Document ED-110B, section 2.2.1.

CPDLC messages

AMC1 ACNS.B.DLS.B1.070 CPDLC Uplink Messages

The data link system should comply with EUROCAE Document ED-110B section 2.2.3 and comply with the CPDLC message syntax ICAO Doc 9705 (Edition 2), section 2.1.4.

For the sole exception of UM117, the data link system should prepare the appropriate response downlink message to a received uplink message in compliance with EUROCAE Document ED-110B, section 2.2.3.3 Table 2-4. Received uplink messages with response type ‘A/N’ as indicated in the ‘Response’ column should be responded with either DM4 (AFFIRM) or DM5 (NEGATIVE). Received uplink messages with response type ‘R’ as indicated in the ‘Response’ column should be responded with DM3 (ROGER) or with DM1 (UNABLE). When UM117 CONTACT is received, no DM89 MONITORING message should be sent.

The data link aircraft system should also handle unsupported messages (i.e. uplink message not referenced in CS ACNS.B.DLS.B1.050) as specified in EUROCAE Document ED-110B, section 3.3.7.6.

AMC2 ACNS.B.DLS.B1.070 CPDLC Uplink Messages

EUROCAE Document ED-110B requires (in Table 4-3, item 6a) aircraft to send the DM89 (MONITORING [unitname] [frequency]) CPDLC message upon receipt of a UM117 (CONTACT) or UM120 (MONITOR) CPDLC message. The sending of DM89 could manually prepared and sent by the flight crew in response to UM120 but not for UM117.

GM1 ACNS.B.DLS.B1.070 Uplink Messages

The following table associates uplink CPDLC messages to the data link services.

ID	Message	ACM	ACL	AMC
UM0	UNABLE		x	
UM1	STANDBY		x	
UM3	ROGER		x	
UM4	AFFIRM		x	
UM5	NEGATIVE		x	
UM19	MAINTAIN [level]		x	
UM20	CLIMB TO [level]		x	
UM23	DESCEND TO [level]		x	
UM26	CLIMB TO REACH [level] BY [time]		x	
UM27	CLIMB TO REACH [level] BY [position]		x	
UM28	DESCEND TO REACH [level] BY [time]		x	
UM29	DESCEND TO REACH [level] BY [position]		x	
UM46	CROSS [position] AT [level]		x	

ID	Message	ACM	ACL	AMC
UM47	CROSS [position] AT OR ABOVE [level]		x	
UM48	CROSS [position] AT OR BELOW [level]		x	
UM51	CROSS [position] AT [time]		x	
UM52	CROSS [position] AT OR BEFORE [time]		x	
UM53	CROSS [position] AT OR AFTER [time]		x	
UM54	CROSS [position] BETWEEN [time] AND [time]		x	
UM55	CROSS [position] AT [speed]		x	
UM61	CROSS [position] AT AND MAINTAIN		x	
UM64	OFFSET [specifiedDistance] [direction] OF ROUTE		x	
UM72	RESUME OWN NAVIGATION		x	
UM74	PROCEED DIRECT TO [position]		x	
UM79	CLEARED TO [position] VIA [routeClearance]		x	
UM80	CLEARED [routeClearance]		x	
UM82	CLEARED TO DEVIATE UP TO [specifiedDistance] [direction] OF ROUTE		x	
UM92	HOLD AT [position] AS PUBLISHED MAINTAIN [level]		x	
UM94	TURN [direction] HEADING [degrees]		x	
UM96	CONTINUE PRESENT HEADING		x	
UM106	MAINTAIN [speed]		x	
UM107	MAINTAIN PRESENT SPEED		x	
UM108	MAINTAIN [speed] OR GREATER		x	
UM109	MAINTAIN [speed] OR LESS		x	
UM116	RESUME NORMAL SPEED		x	
UM117	CONTACT [unitname] [frequency]	x		
UM120	MONITOR [unitname] [frequency]	x		
UM123	SQUAWK [code]		x	
UM133	REPORT PRESENT LEVEL		x	
UM148	WHEN CAN YOU ACCEPT [level]		x	
UM157	CHECK STUCK MICROPHONE [frequency]			x
UM159	ERROR [errorInformation]	x	x	
UM160	NEXT DATA AUTHORITY [facility]	x		
UM162	SERVICE UNAVAILABLE		x	

ID	Message	ACM	ACL	AMC
UM165	THEN		x	
UM171	CLIMB AT [verticalRate] MINIMUM		x	
UM172	CLIMB AT [verticalRate] MAXIMUM		x	
UM173	DESCEND AT [verticalRate] MINIMUM		x	
UM174	DESCEND AT [verticalRate] MAXIMUM		x	
UM179	SQUAWK IDENT		x	
UM183	[freetext]	x	x	x
UM190	FLY HEADING [degrees]		x	
UM196	[freetext]		x	
UM203	[freetext]		x	
UM205	[freetext]		x	
UM211	REQUEST FORWARDED		x	
UM213	[facilitydesignation] ALTIMETER [altimeter]		x	
UM215	TURN [direction] [degrees]		x	
UM222	NO SPEED RESTRICTION		x	
UM227	LOGICAL ACKNOWLEDGEMENT	x	x	
UM231	STATE PREFERRED LEVEL		x	
UM232	STATE TOP OF DESCENT		x	
UM237	REQUEST AGAIN WITH NEXT UNIT	x	x	

GM2 ACNS.B.DLS.B1.070 Uplink Messages

The above ACL messages correspond to the common subset of ACL messages defined in EUROCAE Document ED-120 section 5.2.1.1.5 as required by Regulation (EC) No 29/2009.

AMC1 ACNS.B.DLS.B1.075 Downlink Messages

The data link system should comply with EUROCAE Document ED-110B section 2.2.3 and comply with the CPDLC message syntax ICAO Doc 9705 (Edition 2), section 2.1.4.

For the sole exception of UM117, data link aircraft equipment should prepare the appropriate response downlink message to a received uplink message in compliance with EUROCAE Document ED-110B, section 2.2.3.3 Table 2-4. When UM117 CONTACT is received, no DM89 MONITORING message should be sent.

GM1 ACNS.B.DLS.B1.075 Downlink Messages

The following table associates downlink messages to the data link services.

ID	Message	ACM	ACL	AMC
DM0	WILCO	x	x	
DM1	UNABLE	x	x	
DM2	STANDBY	x	x	
DM3	ROGER		x	
DM4	AFFIRM		x	
DM5	NEGATIVE		x	
DM6	REQUEST [level]		x	
DM18	REQUEST [speed]		x	
DM22	REQUEST DIRECT TO [position]		x	
DM32	PRESENT LEVEL [level]		x	
DM62	ERROR [errorInformation]	x	x	
DM63	NOT CURRENT DATA AUTHORITY	x		
DM65	DUE TO WEATHER		x	
DM66	DUE TO AIRCRAFT PERFORMANCE		x	
DM81	WE CAN ACCEPT [level] AT [time]		x	
DM82	WE CANNOT ACCEPT [level]		x	
DM89	MONITORING [unitname] [frequency]	x		
DM98	[freetext]	x	x	
DM99	CURRENT DATA AUTHORITY	x		
DM100	LOGICAL ACKNOWLEDGEMENT	x	x	
DM106	PREFERRED LEVEL [level]		x	
DM107	NOT AUTHORIZED NEXT DATA AUTHORITY	x	x	
DM109	TOP OF DESCENT [time]		x	

GM2 ACNS.B.DLS.B1.075 Downlink Messages

The above ACL messages correspond to the common subset of ACL messages defined in EUROCAE Document ED-120 section 5.2.1.1.5 as required by Regulation (EC) No 29/2009.

GM3 ACNS.B.DLS.B1.075 Optional ACL Downlink Messages

The data link system may also allow the sending the following ACL messages defined in EUROCAE Document ED-120 section 5.2.1.1.5. The message syntax should also comply with ICAO Doc 9705 (Edition 2), section 2.3.4.

ID	Message
DM9	REQUEST CLIMB TO [level]
DM10	REQUEST DESCENT TO [level]
DM27	REQUEST WEATHER DEVIATION UP TO [specifiedDistance] [direction] OF ROUTE

Note: To prevent costly retrofitting, implementation of the above optional messages is highly recommended.

Data link services requirements

AMC1 ACNS.B.DLS.B1.080 Data Link Initiation Capability (DLIC) Service

- (a) The data link aircraft equipment DLIC logon function should comply with the aircraft system PR-DLIC-Init-ET_{RCTP} and PR-DLIC-Init-TT performance values, respectively 6 seconds and 4 seconds, as specified in EUROCAE Document ED-120 Table A-3.
- (b) The data link aircraft equipment DLIC contact function should comply with the aircraft system PR-DLIC-Cont-ET_{RCTP} and PR-DLIC-Cont-TT performance values, respectively 12 seconds and 8 seconds, as specified in EUROCAE Document ED-120 Table A-3.
- (c) The data link system should:
 - (1) not permit data link services when there are incompatible DLIC version numbers;
 - (2) reinitiate the service with the applicable ATSUs when any of the application or flight information changes;
 - (3) insert the relevant initiation data in the initiation messages;
 - (4) not affect the intent of the DLIC message during processing (data entry/encoding/transmitting/decoding/displaying).

GM1 ACNS.B.DLS.B1.080 Data Link Initiation Capability (DLIC) Service

The Performance Tables in the main body of EUROCAE Document ED-120 for DLIC (Table 4-8 and Table 4-9), ACM (Table 5-21) and ACL (Table 5-31 and Table 5-32) provide the allocated values for the required transaction performance.

A detailed allocation for Aircraft delays is provided in EUROCAE Document ED-120 Annex A Table A-3.

AMC1 ACNS.B.DLS.B1.085 ATC Communications Management (ACM) Service

The data link system for ACM service should comply with the aircraft system PR-ACM-ET_{RCTP} and PR-ACM-TT performance values, respectively 6 seconds and 4 seconds, as specified in EUROCAE Document ED-120 Annex A Table A-3.

GM1 ACNS.B.DLS.B1.085 ATC Communications Management (ACM) Service

The Performance Tables in the main body of EUROCAE Document ED-120 for DLIC (Table 4-8 and Table 4-9), ACM (Table 5-21) and ACL (Table 5-31 and Table 5-32) provide the allocated values for the required transaction performance.

A detailed allocation for Aircraft delays is provided in EUROCAE Document ED-120 Annex A/Table A-3.

AMC1 ACNS.B.DLS.B1.090 ATC Clearances and Information (ACL) Service

The data link system for ACL service should comply with the aircraft system PR-ACL-ET_{RCTP} and PR-ACL-TT performance values, respectively 6 seconds and 4 seconds, as specified in EUROCAE Document ED-120 Annex A Table A-3.

GM1 ACNS.B.DLS.B1.090 ATC Clearances and Information (ACL) Service

The Performance Tables in the main body of EUROCAE Document ED-120 for DLIC (Table 4-8 and Table 4-9), ACM (Table 5-21) and ACL (Table 5-31 and Table 5-32) provide the allocated values for the required transaction performance.

A detailed allocation for Aircraft delays is provided in EUROCAE Document ED-120 Annex A Table A-3.

Interoperability requirements

AMC1 ACNS.B.DLS.B1.100 Network Layer Requirements

The ATN Router should comply with ICAO Document 9705 (Edition 2), sections 5.2.4.1, 5.2.4.3 with an IDRP Hold Time value of 900 seconds.

GM1 ACNS.B.DLS.B1.100 Network Layer Requirements

Compression Schemes

Airborne ATN Router may implement several distinct, yet complementary, compression schemes.

Airborne ATN Routers should support the CLNP Header Compression (also known as 'LREF Compression'). Other compression schemes in ICS are optional.

In addition to the CLNP Header Compression, data link ATN Routers that claims support for optional DEFLATE compression should also support ICAO PDU M0070002 ('Interoperability impact when deflate compression is used. Non-compliance with Zlib').

AMC1 ACNS.B.DLS.B1.105 Transport Layer Requirements

The ATN End System of the data link aircraft equipment should comply with the Transport Protocol Class 4 specified in ICAO Document 9705 (Edition 2), Sub-volume V, section 5.5.2.

The data link aircraft equipment should implement Transport Protocol Class 4 parameter settings in accordance with the following table:

Scope	Parameter	Definition	Value
Inactivity	Inactivity time (I)	A bound for the time after which a transport entity will, if it does not receive a Transport Protocol Data Unit (TPDU), initiate the release procedure to terminate the transport connection.	360 sec
Re-transmission	Retransmission time (T1)	A bound for the maximum time the transport entity will wait for acknowledgement before re-transmitting a TPDU. The retransmission time is adaptive.	Initial value 30 sec
	Maximum Retransmission (N)	Maximum number of TPDU retransmissions.	7
Window	Window time (W)	A bound for the maximum time a transport entity will wait before retransmitting up-to-date window information.	120 sec
Flow Control	Local Acknowledgement delay (AI)	A bound for the maximum time which can elapse between the receipt of a TPDU by the local transport entity from the network layer and the transmission of the corresponding acknowledgement.	1 sec

GM1 ACNS.B.DLS.B1.105 Transport Layer Requirements

Transport Protocol Classes

ICAO Doc 9705 (Edition 2), Sub-volume V, section 5.5 identifies both Connection Oriented and Connection-Less Transport Protocols (as specified in, respectively, ISO/IEC 8073 for COTP and ISO/IEC 8602 for CLTP). The only mandated support is for COTP (i.e. CLTP support is not required).

In addition, ISO/IEC 8073 identifies 5 distinct possible implementations for COTP support, ranging from Class 0 (the less constraining to implement, but also the less reliable) to Class 4 (most reliable). The fifth Class, i.e. COTP Class 4 (also known as 'TP4'), is the only mandated implementation (all other implementations classes are useless for the ATN COTP support).

Transport Protocol Classes

In the ATN Baseline 1 SARPS (i.e. Doc 9705, Edition 2), the Transport Class 4 - as known as TP4 - is as specified in ISO 8073, that mandates support for a 16-bits checksum. Such checksum is considered to be insufficient to detect, and thus compensate, all potential miss deliveries of CLNP Packets by the underlying network routers. The analysis that concluded of TP4 inability to detect and compensate all CLNP miss

deliveries is available in ICAO PDR M00040002. The use of a 32-bits long checksum is identified as a solution to address this potential issue.

AMC1 ACNS.B.DLS.B1.110 Session Layer Requirement

- (a) The ATN End System of the data link aircraft equipment should support a Session Protocol as specified in ICAO Doc 9705 (Edition 2), Sub-Volume IV, section 4.4 including the ISO/IEC 8327 Technical Corrigendum 1 (2002), listed in the following table.

Value (Hex)	Abbreviation	Full SPDU Name
E8	SCN	Short Connect
F0	SAC	Short Accept
D8	SACC	Short Accept Continue
E0-E3	SRF	Short Refuse E0: TC retained, transient refusal E1: TC retained, persistent refusal E2: TC released, transient refusal E3: TC released, persistent refusal
A0	SRFC	Short Refuse Continue

- (b) The ATN End System Session Protocol of the data link system should make use of the value ‘E3’ to encode the Short Refuse (SRF) SPDU.

AMC1 ACNS.B.DLS.B1.115 Presentation Layer Requirement

- (a) The ATN End System of the data link aircraft equipment should support a Presentation Protocol as specified in ICAO Doc 9705 (Edition 2), Sub-Volume IV, section 4.5, and listed in the following table:

Value (Hex)	Abbreviation	Full PPDU Name
02	SHORT-CP	Short Presentation Connect, unaligned PER
02	SHORT-CPA	Short Presentation Connect Accept, unaligned PER
x2	SHORT-CPR	Short Presentation Connect Reject Where x = reason code: 02: presentation-user 12: reason not specified (transient) 22: temporary congestion (transient) 32: local limit exceeded (transient) 42: called presentation address unknown (permanent) 52: protocol version not supported (permanent) 62: default context not supported (permanent) 72: user data not readable (permanent)

- (b) The ATN End System Presentation Protocol of the data link aircraft equipment should make use of the value '02' to encode the SHORT-CPR PDU.

AMC1 ACNS.B.DLS.B1.120 Application Layer Requirements

- (a) The ATN End System of the data link system should support an ATN Convergence Function compliant with ICAO Doc 9705 (Edition 2), Sub-volume IV, section 4.3.
- (b) The ATN End System of the data link system should support an ATN Association Control Service Element (ACSE) compliant with ICAO Doc 9705 (Edition 2), Sub-volume IV, section 4.6.

GM1 ACNS.B.DLS.B1.120 Application Layer Requirements

From an OSI perspective, the ATN Application layer is composed of three distinct parts:

- Layer 7a, that includes all application-independent services (Convergence Function + ACSE).
- Layer 7b, that includes all application-dependent service elements (such as the CPDLC-ASE).
- Layer 7c, that includes applications (such as the CPDLC application, that uses CPDLC-ASE for its communications with ground-based systems).

APPENDIX A — BACKGROUND INFORMATION FOR VOICE COMMUNICATION SYSTEM

(a) General

This appendix provides additional references, background information, and guidance for maintenance testing, as appropriate to Voice Communication System installations.

(b) Related References

(1) EASA

- i. ETSO-2C37e, VHF Radio Communication Transmitting Equipment Operating Within the Radio Frequency Range 117.975–137 Megahertz
- ii. ETSO-2C38e, VHF Radio Communication Receiving Equipment Operating Within the Radio Frequency Range 117.975–137 Megahertz
- iii. ETSO-2C169a VHF Radio Communications Transceiver Equipment Operating Within the Radio Frequency Range 117.975 To 137 Megahertz.

(2) ICAO

ICAO Annex 10, Volume III, Part II, Voice Communication Systems, Chapter 2 Aeronautical Mobile Service — Second Edition including amendment 85.

(3) EUROCAE

ED-23C June 2009 MOPS for airborne VHF Receiver-Transmitter operating in the frequency range 117.975 – 137.000 MHz.

APPENDIX B — BACKGROUND INFORMATION FOR DATA LINK SYSTEM

(a) General

This appendix provides additional references, background information, and guidance for maintenance testing, as appropriate to Data Link System installations.

(b) Related References

(1) ICAO

- i. ICAO Doc 4444 Air Traffic Management 15th Ed 2007
- ii. ICAO Doc 9705 MANUAL OF TECHNICAL PROVISIONS FOR THE AERONAUTICAL TELECOMMUNICATION NETWORK (ATN) 2nd Ed 1999
- iii. ICAO Doc 9776 Manual on VHF Digital Link (VDL) Mode 2 1st Ed 2001.

(2) ARINC

Specification 631-6 Guidelines for Design Approval of Aircraft Data Link Communication Systems Supporting Air Traffic Services (ATS) dated 11/2010

(3) FAA

AC 20-140B Guidelines for Design Approval of Aircraft Data Link Communication Systems Supporting Air Traffic Services (ATS) dated 27/09/2012

(4) EUROCONTROL

- i. LINK2000+/ATC DATA LINK OPERATIONAL GUIDANCE, Version 6.0, Date: 17 December 2012.
- ii. LINK 2000+ Guidance to Airborne Implementers, Version 1.1, Date: 09 December 2009.
- iii. LINK2000+/FLIGHT CREW DATA LINK OPERATIONAL GUIDANCE Version 5.0, Date: 17 December 2012.
- iv. LINK2000+ Programme, Generic Interop Test Plan for Avionics - Part 1, Upper Layers and CM/CPDLC applications, Version 2.3, Date: 15th June 2010.

(5) ISO/IEC

- i. Document 8073 Information technology -- Open Systems Interconnection -- Protocol for providing the connection-mode transport service Edition 4,0 including amendment 1 dated 09/1998
- ii. Document 8602 Information technology -- Protocol for providing the OSI connectionless-mode transport service Edition 2,0 including amendment 1 dated 12/1996
- iii. ISO/IEC 8327-1:1996 Information technology — Open Systems Interconnection — Connection-oriented Session protocol: Protocol specification TECHNICAL CORRIGENDUM 1 Published 15/05/2002

(6) EUROCAE

- i. ED-110B December 2007 Interoperability Requirements Standard for Aeronautical Telecommunication Network Baseline 1 (Interop ATN B1),
- ii. ED-120 May 2004 Safety and Performance Requirements Standard For Initial Air Traffic Data Link Services In Continental Airspace (SPR IC) including change 1 and change 2.
- iii. ED-122 February 2011 Safety and Performance Standard for Air Traffic Data Link Services in Oceanic and Remote Airspace (Oceanic SPR Standard)
- iv. ED-154A March 2012 Future Air Navigation System 1/A (FANS 1/A) - Aeronautical Telecommunications Network (ATN) Interoperability Standard

Subpart C — Navigation (NAV)

SECTION 1 — PERFORMANCE-BASED NAVIGATION (PBN)

Subsection 1 — Applicability — General

AMC1 ACNS.C.PBN.101 Applicability

RNAV certification is granted as follows:

- (a) Aircraft that comply with the requirements of Subsection 2 comply with all the criteria of the RNAV 1, RNAV 2, and RNAV 5 specifications.
- (b) Aircraft equipped with dual multi-sensor RNP systems which integrate inertial position source(s) that meet the criteria of Appendix B and which conform to the requirements of Subsection 2 comply with the criteria of the RNAV 10 specification.
- (c) Aircraft that are equipped with dual stand-alone RNP systems with integrated GNSS sensors that comply with the requirements of Subsection 2, comply with the criteria of the RNAV 10 specification if the AFM (or equivalent) contains a requirement stating that:
 - an approved fault detection and exclusion (FDE) availability-prediction program is used, and;
 - the maximum allowable time for which FDE capability is projected to be unavailable is 34 minutes for any one occasion.

[Issue: CS-ACNS/2]

GM1 ACNS.C.PBN.101 Applicability

Subpart C of CS-ACNS provides certification criteria for performance-based navigation. EASA has considered the current and future aircraft equipment and has assumed that most, if not all, aircraft are equipped with one or more GNSS receivers. Subpart C, therefore, considers GNSS equipped aircraft and focuses on compliance with RNP navigation specifications. Compliance with Subsection 2, however, also assures compliance with the RNAV 10, RNAV 5, RNAV 2, and RNAV 1 navigation specifications.

Where the term 'Required' is used in Table 1, it refers to compliance with the navigation specification.

It should be noted that for multi-sensor RNP systems, loss of RNP capability does not imply loss of RNAV capability if an inertial or DME navigation source(s) is(are) still operable.

It should be noted that this Subpart does not address communication and surveillance considerations that are, in some cases, related to the implementation of a navigation specification (e.g. controller-pilot data link communications (CPDLC) and automatic dependent surveillance — contract (ADS-C) for RNP 4) within a particular airspace.

The ICAO PBN Manual (Doc 9613) contains 11 navigation specifications, each of them addressing specific operations by flight phase:

- (a) RNAV 10, historically referred to as RNP 10, is applied for oceanic and remote continental navigation operations;

- (b) RNAV 5, RNAV 2 and RNAV 1 are applied for continental en-route and terminal navigation operations;
- (c) RNP 4 and RNP 2 and A-RNP are applied for oceanic and remote continental navigation operations;
- (d) RNP 2 and A-RNP are applied for continental en-route navigation operations;
- (e) RNP 1 and A-RNP are applied for terminal navigation operations;
- (f) A-RNP, RNP APCH, and RNP AR APCH are applied for initial, intermediate, final, and missed approach navigation operations, and may include requirements for vertical navigation (VNAV);
- (g) RNP 0.3 was specifically written to facilitate (low-level) en-route operations with rotorcraft.

Subpart C on performance-based navigation contains basic and supplemental certification criteria. The basic criteria must always be complied with, regardless of the navigation specification, and ensure compliance with the navigational requirements of the RNAV 10, RNAV 5, RNAV 2, RNAV 1, RNP 2, RNP 1 and RNP 0.3 criteria.

Some navigation specifications require compliance with supplemental criteria, e.g. compliance with Subsection 10 for parallel offsets for RNP 4.

The criteria for navigation specifications that include approach, i.e. A-RNP, RNP APCH and RNP AR, are more specific. Subsection 3 ('LNAV in final approach') and Subsection 5 ('VNAV in final approach') apply to these operations. In addition, both RNP AR and A-RNP have their own specific criteria that need to be met, as described in Subsection 6 for RNP AR and Subsection 7 for A-RNP.

Subsection 4 addresses vertical navigation (VNAV) outside the final approach part of the flight. It contains criteria for compliance with altitude constraints considered in Commission Implementing Regulation (EU) 2018/1048.

In addition to the criteria for RNP APCH approaches, Subsection 5 also contains optional requirements for advisory VNAV, which apply to the final approach segment (FAS) only.

Subsections 8, 9, and 10 contain criteria for specific functions. These functions (radius to fix, fixed radius transition, and parallel offset) are required for some applications and are optional for some others.

In some instances, the CS requirements deviate from the ICAO navigation specification, for example by requiring VNAV for RNP APCH. This is based on recent certification experience, the fact that CS-ACNS is a forward-looking document that is based on the latest ICAO and industry standards, and it is also a consequence of the way Section 1 has been structured. Where applicants intent to strictly apply the criteria of the ICAO navigation specification, they are invited to consult EASA (e.g. an applicant applying for RNP APCH without VNAV down to LNAV minima or LP minima only).

Applicants intending to apply strictly for RNAV navigation specifications predicated on conventional ground navigation aids, i.e. non-GNSS-based navigation, are also invited to consult EASA.

Example application of Table 1:

Question: An applicant wishes to apply for certification of an aircraft for RNP APCH. Which subsections of Subpart C should the applicant demonstrate compliance with?

Answer: Subsections 1 and 2, and the supplemental and the more stringent criteria provided in Subsections 3 and 5 for lateral and vertical navigation, respectively. The applicant may need to also demonstrate compliance with Subsection 8, which is optional, as the RF functionality could

be used in the initial and intermediate approach segments, and in the final phase of the missed approach.

Additionally, Appendix C to Subpart C provides guidance material for the installation of equipment constituting the aircraft's RNP system and for testing the aircraft's RNP system.

[Issue: CS-ACNS/2]

GM2 ACNS.C.PBN.101 Applicability

With the publication of CS-ACNS, AMC 20-4A, AMC 20-5, AMC 20-12, AMC 20-26, AMC 20-27A, AMC 20-28, JAA TGL-10 and CM-AS-002 Issue 2 have become obsolete. This, however, does not invalidate existing approvals to these references.

Changes to aircraft/systems that were approved to the above AMC-20 references or TGL will be handled as follows:

- Where the change remains within the original scope of the AMC or TGL, i.e. no new functionality is added, the applicant may continue to use the criteria of the AMC or TGL as the certification basis for the change.
- Where the change is outside the original scope of the AMC or TGL, i.e. a new functionality is added, the corresponding certification criteria in CS-ACNS are to be applied. Given the differences in the set-up of the AMC/TGL compared to CS-ACNS, an applicant may, within reason, claim credit for items already demonstrated to an AMC or TGL that are similar to the requirements in CS-ACNS.

Examples:

- 1) An aircraft has been approved to perform RNP AR operations to the criteria of AMC 20-26. The applicant is updating the software of the flight management system, but no additional functionality is being added. In that case, the criteria of AMC 20-26 continue to be applicable.
- 2) An aircraft has been approved to conduct RNP APCH operations to LNAV or LNAV/VNAV using barometric VNAV in accordance with AMC 20-27A. The applicant is replacing the GNSS receiver with one that can receive differential correction signals from a satellite based augmentation system (SBAS) and adds the capability to operate on RNP APCH approach procedures to LP or LPV minima. This capability was not within the original scope of AMC 20-27A. The applicant should, therefore, apply the criteria of the new CS-ACNS. Credit may be claimed for items already demonstrated as part of the compliance demonstration to AMC 20-27A, where these may be considered to be reasonably similar and applicable.

[Issue: CS-ACNS/2]

Subsection 2 — Generic specifications for performance-based lateral navigation

SYSTEM QUALIFICATION CRITERIA

AMC1 ACNS.C.PBN.205 RNP system approval

For all navigation specifications except RNP 0.3:

- (a) where the RNP system architecture is based on a stand-alone system, the RNP system should be granted a European Technical Standard Order (ETSO) authorisation against the following ETSO:
 - (1) ETSO-C146c (operational Class 3).
 - (2) ETSO-C190 active antenna.
- (b) where the RNP system architecture is based on a flight management system (FMS) receiving input from various sources of position, the FMS should be granted an ETSO authorisation against ETSO-C115d and, depending on the type of sources to determine position, these should be granted an ETSO authorisation against the following ETSO or be compliant with the following standards:
 - (1) GNSS position source against ETSO-C196a or ETSO-C145c (operational Class 3);
 - (2) GNSS antenna against:
 - (i) ETSO-C144a passive antenna when an ETSO-C196a GNSS position source is installed, or;
 - (ii) ETSO-C190 active antenna when an ETSO-C196a or ETSO-C145c GNSS position source is installed.
 - (3) DME/DME horizontal position source based on a DME interrogator that has been granted an ETSO authorisation against ETSO-2C66b;
 - (4) barometric altimeter: ETSO-C106 Amendment 1.
- (c) with reference to CS ACNS.A.GEN.020, any deviations from the ETSOs should be evaluated against the relevant sections of EUROCAE ED-75D Minimum Aviation System Performance Standard (MASPS).
- (d) noting that there is no equipment standard for INS/IRU horizontal position source, this equipment should comply with the functionality and performance that is detailed in Appendix B.

[Issue: CS-ACNS/2]

AMC2 ACNS.C.PBN.205 RNP system approval

For compliance with the RNP 0.3 navigation specification, the RNP system is supported by an SBAS capable GNSS position source, i.e. one that has been authorised against ETSO-C145c (operational Class 3) or ETSO-C146c (operational Class 3).

[Issue: CS-ACNS/2]

AMC3 ACNS.C.PBN.205 RNP system approval

Where AMC to Section 1 of Subpart C contain a reference to the criteria of EUROCAE Document ED-75D, these criteria are considered to be means to comply with the related CSs. Therefore, these criteria may be applied instead of installing ETSO-authorized equipment.

Where AMC to Section 1 of Subpart C contain a reference to a specific amendment to an ETSO, it indicates the minimum acceptable standard, so any subsequent amendments are also considered to be acceptable.

[Issue: CS-ACNS/2]

GM1 ACNS.C.PBN.205 RNP system approval

Subpart C of CS-ACNS is based on EUROCAE ED-75D (RTCA DO-236C and Change 1), except for RNP AR, and on the ICAO PBN Manual (Doc 9613).

The AMC to Subpart C requirements encourage the installation of ETSO-authorized equipment, recognising the fact that many of the EUROCAE ED-75D requirements are covered through compliance with ETSO requirements. Recognition of ETSO authorisation generally limits the burden on the applicant that demonstrates compliance with the CS requirements.

[Issue: CS-ACNS/2]

GM2 ACNS.C.PBN.205 RNP system approval

ETSO-C145c and ETSO-C146c (operational Class 3) support the following operations:

- (a) oceanic/remote en route;
- (b) continental en route;
- (c) arrival;
- (d) approach down to LNAV minima;
- (e) approach down to LNAV/VNAV minima;
- (f) approach down to LP minima;
- (g) approach down to LPV minima; and
- (h) departure;

ETSO-C146c (functional Class D, operational Class 4) only supports approach down to LP and LPV minima and is, therefore, only recognised as AMC for lateral navigation in final approach (see AMC1 ACNS.C.PBN.305).

The minimum system requirements may also depend on the intended airspace to be flown; hence, carriage of additional navigation systems could be required.

[Issue: CS-ACNS/2]

GM3 ACNS.C.PBN.205 RNP system approval

Integrated GNSS/INS position solutions reduce the rate of degradation after loss of position updating. For 'tightly coupled' GNSS/IRUs, RTCA Document DO-229D, Appendix R, and RTCA Document DO-316, Appendix R, provide additional guidance on 'tightly coupled' GNSS/IRUs.

[Issue: CS-ACNS/2]

AMC1 ACNS.C.PBN.210 Position source

If other horizontal position sources are available, they may be used to complement the GNSS-computed position, provided that the output position continues to meet the required performance.

If the position is no longer available from a GNSS position source and if additional sources are available, the system should revert to the best available source (e.g. the source that can provide the best computed position in terms of accuracy and integrity).

Installation of equipment with an ETSO authorisation against ETSO-C115d satisfies the requirement.

[Reference: ED-75D § 3.7.3.1.2]

[Issue: CS-ACNS/2]

FUNCTIONAL CRITERIA

RNP system

AMC1 ACNS.C.PBN.215 Position estimation

Installation of equipment with an ETSO authorisation against ETSO-C115d or ETSO-C146c (operational Class 3) satisfies the requirement.

[Reference: ED-75D § 3.1.1.1]

[Issue: CS-ACNS/2]

GM1 ACNS.C.PBN.215 Position estimation

The estimated lateral position accuracy is a measure that is based on a defined scale, in nautical miles, which conveys the current position estimation performance. The lateral position accuracy can be related to the required navigation performance (RNP) value.

[Issue: CS-ACNS/2]

AMC1 ACNS.C.PBN.220 Navigation source selection and reversion

Installation of equipment with an ETSO authorisation against ETSO-C115d satisfies the requirement.

[Reference: ED-75D § 3.7.3.1]

[Issue: CS-ACNS/2]

AMC1 ACNS.C.PBN.225 Reasonableness check of distance-measuring equipment (DME)

Installation of equipment with an ETSO authorisation against ETSO-C115d satisfies the requirement.

[Reference: ED-75D § 3.7.3.1.1]

[Issue: CS-ACNS/2]

AMC1 ACNS.C.PBN.230 Flight plan management

- (a) The RNP system should be capable of displaying:
 - (1) the along-track distance between any flight plan waypoints;
 - (2) the distance to go to any waypoint selected by the flight crew; and
 - (3) the actual waypoint and the data that defines it.
- (b) The RNP system should enable modification of any flight plan, or flight plan segment, including procedures that were loaded from the on-board navigation database. However, FAS data blocks protected by a cyclic redundancy check (CRC) code can never be modified.
- (c) The RNP system should allow the creation and insertion of pilot-defined fixes and related data.

Installation of equipment with an ETSO authorisation against ETSO-C115d is considered to meet the criteria of (b), and (c). It also supports item (a); however, the applicant should ensure the flight deck interface complies with this CS.

Installation of equipment with an ETSO authorisation against ETSO-C146c (operational Class 3) is considered to meet the criteria of (a) through (d).

[Reference: ED-75D § 3.7.2.1.1.1]

[Issue: CS-ACNS/2]

AMC1 ACNS.C.PBN.235 Automatic leg sequencing

Installation of equipment with an ETSO authorisation against ETSO-C115d and ETSO-C146c satisfies the requirement.

[Reference: ED-75D § 3.7.2.1.4]

[Issue: CS-ACNS/2]

AMC1 ACNS.C.PBN.240 Route/procedure extraction and loading

Installation of equipment with an ETSO authorisation against ETSO-C115d satisfies the requirement.

The installation of equipment with an ETSO authorisation against ETSO-C146c satisfies the CS requirement, provided that the applicant ensures that speed constraints are extracted from the database.

[Reference: ED-75D § 3.7.2.1.1.1]

[Issue: CS-ACNS/2]

AMC1 ACNS.C.PBN.245 Path definition and leg transition

Installation of equipment with an ETSO authorisation against ETSO-C115d satisfies the requirements.

Installation of equipment with an ETSO authorisation against ETSO-C146e satisfies the requirements.

Installation of equipment with an ETSO authorisation against ETSO-C146c satisfies the requirements of (a), (b)(1), (c) and (d).

Subject to EASA's agreement, where the RNP system does not support the execution of VA, VM, and VI path terminators, the applicant may demonstrate that the aircraft and flight systems allow the flight crew to manually fly the aircraft on a heading to intercept a course or to go direct to another fix after reaching a procedure-specified altitude. The manual execution of VA, VM and VI terminators should be supported by a flight crew workload assessment.

Subject to EASA's agreement, where the RNP system does not support the execution of CA and FM path terminators, the applicant may demonstrate that the RNP system allows the flight crew to readily designate a waypoint and select a desired course to or from a designated waypoint. The manual execution of CA and FM terminators should be supported by a flight crew workload assessment.

[References: ED-75D § 3.2.1.2 and ED-75D § 3.2.5.4]

[Issue: CS-ACNS/2]

GM1 ACNS.C.PBN.245 Path definition and leg transition

- (a) The intent of CS ACNS.C.PBN.245(d) is to ensure a smooth transition.
- (b) Path terminators and leg transitions are defined in Aeronautical Radio, Inc. (ARINC) 424 documents, and their application is described in more detail in EUROCAE ED-75D, and ED-77 (RTCA documents DO-236C Change 1, and DO-201A).

[Issue: CS-ACNS/2]

AMC1 ACNS.C.PBN.250 ‘Direct-to’ function

Installation of equipment with an ETSO authorisation against ETSO-C115d or ETSO-C146c satisfies the requirement.

[Reference: ED-75D § 3.2.4.2]

[Issue: CS-ACNS/2]

AMC1 ACNS.C.PBN.255 Magnetic variation

Installation of equipment with an ETSO authorisation against ETSO-C115d or ETSO-C146c satisfies the requirement of (a) and (b).

[Reference: ED-75D § 3.2.5.2]

[Issue: CS-ACNS/2]

AMC1 ACNS.C.PBN.260 RNAV holding

Installation of equipment with an ETSO authorisation against ETSO-C115d satisfies the requirement, provided that the equipment meets the criteria defined in RTCA DO-283B § 2.2.1.2.6.

Installation of equipment with an ETSO authorisation against ETSO-C146c satisfies the requirement.

[Reference: ED-75D § 3.7.2.2.3.1]

[Issue: CS-ACNS/2]

GM1 ACNS.C.PBN.260 RNAV holding

The intent of the CS is to require RNAV holding, not RNP holding.

[Issue: CS-ACNS/2]

AMC1 ACNS.C.PBN.265 User-defined routes and fixes

Installation of equipment with an ETSO authorisation against ETSO-C115d or ETSO-C146c satisfies the requirement.

[References: ED-75D § 3.7.2.1.2.1 & ED-75D § 3.7.2.1.2.2]

[Issue: CS-ACNS/2]

GM1 ACNS.C.PBN.265 User-defined routes and fixes

User-defined fixes are usually defined via the entry of latitude/longitude, place/along-track, place/bearing-place/bearing, and place/bearing/distance.

[Issue: CS-ACNS/2]

AMC1 ACNS.C.PBN.270 Navigation accuracy

(a) The RNP value associated with a leg or segment should be assigned in the following order of precedence:

- (1) flight crew manually entered RNP value for the leg or segment;

- (2) the RNP value coded in the on-board navigation database for the current leg or segment, if implemented;
 - (3) the RNP value coded in the on-board navigation database for the current area, if implemented; and last
 - (4) a system default RNP value, if provided by the RNP system.
- (b) Installation of equipment with an ETSO authorisation against ETSO-C115d or ETSO-C146c satisfies the requirement.

[References: ED-75D § 3.7.2.1.3.1, ED-75D § 3.2.6, ED-75D § 3.2.6.2]

[Issue: CS-ACNS/2]

Display of navigation data

AMC1 ACNS.C.PBN.275 Display and entry of navigation data — resolution

Installation of equipment with an ETSO authorisation against ETSO-C115d or ETSO-C146c satisfies the requirement.

[Reference: ED-75D § 3.6.2]

[Issue: CS-ACNS/2]

AMC1 ACNS.C.PBN.280 Deviation display

An acceptable means of compliance is to provide a non-numeric deviation display. The full-scale deflection of the non-numeric lateral deviation display should be:

- (a) comparable with the applicable RNP value; and
- (b) made available to the flight crew.

Alternatively, subject to EASA's agreement, a moving map display with appropriate map scales, and which provides a sufficiently equivalent functionality to a non-numeric lateral deviation display, may be accepted. EASA's agreement will be based on a human factor and workload assessment performed by the applicant.

[Issue: CS-ACNS/2]

AMC2 ACNS.C.PBN.280 Deviation display

When used to conduct a departure procedure off the runway, the RNP system should display lateral deviations not later than when reaching 50 feet above the departure runway. Installation of equipment with an ETSO authorisation against ETSO-C115d or ETSO-C146c supports this.

[Reference: ED-75D § 3.3.3.1]

[Issue: CS-ACNS/2]

AMC3 ACNS.C.PBN.280 Deviation display

Subject to EASA's agreement, a lateral deviation display not slaved to the RNP system associated with adequate operational procedures may be accepted for type-certification application against RNP 2, RNP 1

or RNP APCH. The applicant should provide a human factor and workload assessment in support of the application.

Note: The alleviation provided above is intended to address particular concerns on small CS-23, Level 1, 2, and 3 aircraft.

[Issue: CS-ACNS/2]

AMC1 ACNS.C.PBN.285 Display of active waypoint

The installation of equipment with an ETSO authorisation against ETSO-C146c satisfies the CS requirement, provided that the applicant ensures that both the distance to and the estimated time of arrival at the active waypoint are available to the flight crew.

[Issue: CS-ACNS/2]

AMC2 ACNS.C.PBN.285 Display of active waypoint

Subject to EASA's agreement, the display of the data on a page on a multifunction control and display unit (MCDU), readily accessible to the flight crew, may be accepted for type-certification application against RNP 4 or RNP 2. EASA's agreement will be based on a human factor and workload assessment performed by the applicant.

[Issue: CS-ACNS/2]

AMC1 ACNS.C.PBN.290 Display of ground speed

The installation of equipment in the flight crew's maximum field of view with an ETSO authorisation against ETSO-C146c satisfies the requirement.

Installation of equipment with an ETSO authorisation against ETSO-C115d supports the requirement, provided that the applicant ensures that the flight deck interface complies with this CS.

[Reference: ED-75D § 3.7.5.2.1]

[Issue: CS-ACNS/2]

AMC1 ACNS.C.PBN.2105 Display of speed constraints

Subject to EASA's agreement, a display of speed constraints outside the maximum field of view with adequate operational procedures may be accepted. The applicant should provide a human factor and workload assessment in support of the application.

[Issue: CS-ACNS/2]

Navigation database

AMC1 ACNS.C.PBN.2115 Use of navigation database

The installation of equipment with an ETSO authorisation against ETSO-C115d or ETSO-C146C satisfies the CS requirement, provided that the applicant ensures that the database capacity is appropriate for the intended operation.

[References: ED-75D § 3.8.1, ED -75D § 3.8.2]

[Issue: CS-ACNS/2]

GM1 ACNS.C.PBN.2115 Use of navigation database

The storage capacity is consistent with the intended use of the aircraft. For example, the database of a regional aircraft may contain data for a given region only, whereas the database of a long-range aircraft may contain worldwide data.

[Issue: CS-ACNS/2]

AMC1 ACNS.C.PBN.2120 Data quality requirements (DQRs)

Since database process assurance levels are normally addressed at equipment design level, the applicant should verify with the equipment manufacturer that the DQRs have been established and provided to the navigation database provider(s). Formal arrangements should also ensure that deficiencies and/or errors detected by the DAT provider can be reported to the applicant, whenever DQRs could be compromised.

Documentation that these data quality requirements are valid at aircraft level must be confirmed during the airworthiness approval.

[Issue: CS-ACNS/2]

AMC1 ACNS.C.PBN.2125 Extraction and display of navigation data

The installation of equipment with an ETSO authorisation against ETSO-C115d or ETSO-C146c satisfies the requirement.

[Reference: ED-75D § 3.8.2]

[Issue: CS-ACNS/2]

GM1 ACNS.C.PBN.2125 Extraction and display of navigation data

The intent of CS ACNS.C.PBN.2125 (a) is not to prevent truncating resolution to optimise performance as long as the truncation is commensurate with the procedure. Rather, the intent is to ensure compatibility between the database and the RNP system.

[Issue: CS-ACNS/2]

Monitoring and alerting

AMC1 ACNS.C.PBN.2130 Alerting associated with degradation of navigation

The alerting requirement is satisfied by installation of equipment with an ETSO authorisation against ETSO-C115d or ETSO-C146c, provided that the applicant ensures that the alert is appropriately indicated in the flight crew's optimum field of view, and assess any processing delays caused by the aircraft flight deck alerting system.

Subject to EASA's agreement, display of the alert in the flight crew's maximum field of view may be accepted. The applicant should support the deviation by providing a human factor and workload assessment.

Note: The alleviation provided above is intended to address particular concerns on smaller aircraft, for example, CS-23, Level 1, 2, and 3 aircraft.

[Reference: ED-75D § 3.7.6]

[Issue: CS-ACNS/2]

AMC1 ACNS.C.PBN.2135 Navigation accuracy alerting

Installation of equipment with an ETSO authorisation against ETSO-C115d satisfies the CS criteria, provided that the applicant ensures that the flight deck interface complies with the CS.

This CS is typically not relevant for equipment with an ETSO authorisation against ETSO-C146c. If this equipment provides a facility to the flight crew to enter the RNP value, then this alerting mechanism should be implemented as well.

Note: This functionality is not part of the functionalities specified in RTCA Document DO-229D (MOPS).

[Reference: ED-75D § 3.7.6.1]

[Issue: CS-ACNS/2]

PERFORMANCE CRITERIA

Lateral performance

AMC1 ACNS.C.PBN.2140 Lateral navigation accuracy

Installation of equipment with an ETSO authorisation against ETSO-C115d and ETSO-C146c satisfies the requirement.

[References ED-75D §1.7.1, §1.7.2 and §2.1.1]

[Issue: CS-ACNS/2]

AMC1 ACNS.C.PBN.2145 RNP system design — integrity

Guidance on the integrity (provisioning of erroneous output or display of data) of the RNP system related to lateral position or guidance is provided in Appendix A to Subpart C.

[Issue: CS-ACNS/2]

AMC1 ACNS.C.PBN.2150 RNP system design — continuity

Guidance on the continuity (loss of the function) of the RNP system to provide lateral position or guidance is provided in Appendix A to Subpart C.

[Issue: CS-ACNS/2]

Subsection 3 — Supplementary specifications for lateral navigation in final approach

APPLICABILITY

GM1 ACNS.C.PBN.301 Applicability

The lateral navigation capabilities of RNP systems that are required to support initial, intermediate, and missed approach segments of an approach procedure are described in Subsection 2.

[Issue: CS-ACNS/2]

SUPPLEMENTARY FUNCTIONAL CRITERIA

RNP system

AMC 1 ACNS.C.PBN.305 RNP system approval

In addition to the systems referenced in AMC1 ACNS.C.PBN.205, equipment authorised against ETSO-C146c functional Class Delta (operational Class 4) supports operations to LP and LPV minima.

[Issue: CS-ACNS/2]

AMC1 ACNS.C.PBN.310 Final approach intercept

The installation of equipment with an ETSO authorisation against ETSO-C146c Class 3 or 4 and ETSO-C115d Class A satisfies the requirement.

[Reference: ED-75D § 3.2.8.4]

[Issue: CS-ACNS/2]

GM1 ACNS.C.PBN.310 Final approach intercept

The capability to intercept the final approach provides the pilot with the ability to capture the published final approach segment following a period when the aircraft has been flown manually, or in autopilot/automatic flight control system heading mode, following ATC vectors to support final approach sequencing.

[Issue: CS-ACNS/2]

Display of navigation data

GM1 ACNS.C.PBN.320 Approach mode indication

The requirement is intended to avoid confusion with regard to the type of approach procedure that is being flown and the line of minima applicable to that approach procedure, e.g. down to LNAV/VNAV minima. It is not required to actually indicate the value associated with the applicable minima.

[Issue: CS-ACNS/2]

AMC1 ACNS.C.PBN.325 Lateral deviation display

The deviation indicators on the non-numerical lateral display should appear in a timely fashion to allow the flight crew to intercept the final approach segment.

[Issue: CS-ACNS/2]

AMC1 ACNS.C.PBN.330 Non-numeric lateral deviation display scaling for approach

- (a) When linear lateral deviation is provided, the full-scale deflection of the non-numeric deviation display should not exceed two times the RNP value.
- (b) When angular lateral deviation is provided:
 - (1) installation of equipment with an ETSO authorisation against ETSO-C146c operational Class 3 or 4 satisfies the requirement; or
 - (2) the full-scale deflection of the non-numeric deviation display should allow the aircraft to remain within the two times RNP value of (a) above

[Issue: CS-ACNS/2]

Subsection 4 — Supplementary specifications for vertical navigation

APPLICABILITY

GM1 ACNS.C.PBN.401 Applicability

The criteria of Subsection 4 are based on the PBN Manual, Volume II, Attachment A, and are intended to support the definition of vertical paths in airspace where vertical navigation outside the approach is intended to be applied in environments with high traffic density, traffic complexity, or terrain features, as for example those defined in the Commission Implementing Regulation (EU) 2018/1048.

[Issue: CS-ACNS/2]

SUPPLEMENTARY FUNCTIONAL CRITERIA

RNP system

AMC1 ACNS.C.PBN.410 Altitude constraints

The altitude constraints should be defined as follows:

- (a) an 'AT or ABOVE' altitude constraint;
- (b) an 'AT or BELOW' altitude constraint;
- (c) an 'AT' altitude constraint; or
- (d) a 'WINDOW' altitude constraint.

The installation of equipment with an ETSO authorisation against ETSO-C115d satisfies the requirement.

[Reference: ED-75D § 3.2.8.1]

[Issue: CS-ACNS/2]

GM1 ACNS.C.PBN.420 Pressure settings

This requirement is intended to prevent potential flight crew errors due to different altimeter settings in the aircraft altimeter system and RNP system.

[Issue: CS-ACNS/2]

Subsection 5 — Supplementary specifications for vertical navigation in final approach

APPLICABILITY

GM1 ACNS.C.PBN.501 Applicability

Subsection 5 sets out the certification specifications for systems that use either a barometric VNAV (BARO-VNAV) or a GNSS space-based augmented source of vertical position (SBAS-VNAV) on procedures where vertical guidance is based on a published vertical path to LNAV/VNAV or LPV minima respectively.

The vertical performance of systems that comply with CS ACNS.C.PBN.575 is not adequate to support RNP AR APCH operations, but the requirements contained in CS ACNS.C.PBN.675 should be applied instead.

[Issue: CS-ACNS/2]

SUPPLEMENTARY FUNCTIONAL CRITERIA

RNP system

AMC 1 ACNS.C.PBN.505 Vertical approach path

The installation of equipment with an ETSO authorisation against ETSO-C115d or ETSO-C146c Class 3 or 4 satisfies the requirement.

[Reference: ED-75D § 3.2.8.4.3]

[Issue: CS-ACNS/2]

GM1 ACNS.C.PBN.515 Pressure settings

This requirement is intended to prevent potential flight crew errors due to different altimeter settings in the aircraft altimeter system and RNP system.

[Issue: CS-ACNS/2]

AMC1 ACNS.C.PBN.520 Glide path intercept

The RNP system should allow the glide path to be intercepted at the final approach fix (FAF) using a fly-by technique with a normal acceleration factor of not less than 0.03 g.

The installation of equipment with an ETSO authorisation against ETSO-C115d or ETSO-C146c Class 3 or 4 satisfies the requirement.

[Reference: ED-75D § 3.2.8.5]

AMC1 ACNS.C.PBN.525 Temperature compensation

The RNP system providing temperature compensation capability for the vertical path should comply with EUROCAE ED-75D, Appendix H.2.

The capability to provide automatic temperature compensation is an optional function for ETSO authorisation against ETSO C115d. Consequently, the applicant should ensure that this function has been implemented into the RNP system.

[Issue: CS-ACNS/2]

Display of navigation data

AMC1 ACNS.C.PBN.530 Vertical deviation display

Deviations from the defined path should be displayed in a timely fashion to support the flight crew to intercept the extended vertical approach path.

[Issue: CS-ACNS/2]

AMC2 ACNS.C.PBN.530 Vertical deviation display

Installation of equipment with an ETSO authorisation against ETSO-C115d or ETSO-C146c supports the requirement, provided that the applicant ensures the display characteristics comply with this CS.

[Reference: ED-75D § 3.7.5.1.2.1 and § 3.7.5.1.4]

[Issue: CS-ACNS/2]

AMC1 ACNS.C.PBN.535 Resolution and full-scale deflection of the vertical deviation display

Installation of equipment with an ETSO authorisation against ETSO-C115d or ETSO-C146c supports the requirement of the CS, provided that the applicant ensures that the display characteristics comply with the CS.

RNP systems that provide fixed vertical scaling should provide a non-numerical vertical deviation display with a full-scale deflection of ± 150 ft. In addition, the display should provide the flight crew with an easy way to readily identify a path deviation of 75 ft using the vertical deviation display alone, i.e. provide clear markings at + 75 ft and at – 75 ft.

Note: Subject to EASA's agreement, the use of a scale of other than ± 150 ft may be accepted, provided that the scaling is suitable to control the aircraft on the intended path and the 75-ft deviation can be easily identified by the flight crew. The applicant should provide a human factor and workload assessment as well as relevant operating procedures that ensure that the aircraft's deviation from the path can be monitored and bounded within the ± 75 -ft interval, supporting this deviation.

Systems that use angular vertical scaling should meet the following:

- (a) The deviation scaling suitably supports the flight technical error (FTE) monitoring and bounding (75-ft deviation);
- (b) The deviation limits are equivalent to the operational limits for glideslope deviations during an ILS approach.

In order to meet the primary safety objective of not exceeding an FTE of 75 ft below path to maintain obstacle clearance, it may be required to put a limitation on the length of the approach that the RNP system is able to support.

A vertical situation display is not considered to satisfy the requirements.

[Issue: CS-ACNS/2]

GM1 ACNS.C.PBN.535 Resolution and full-scale deflection of the vertical deviation display

Vertical deviation displays that rely on the flight crew to assess the deviation based on whether or not the pointer still touches a marker are not considered acceptable. Neither does EASA consider solutions requiring the flight crew to verify the vertical deviation on a (multifunction) control display unit ((M)CDU) acceptable.

[Issue: CS-ACNS/2]

Monitoring and alerting**AMC1 ACNS.C.PBN.550 Glide path alerting**

The excessive-deviation-below-the-glide-path alert may be provided by another system other than the TAWS. If this is the case, the alert should have equivalent effect to the Mode 5 alert provided by a Class A TAWS system.

Note: Applicants are highly encouraged to install a similar glide path deviation alerting function for systems that support RNP APCH down to LNAV/VNAV minima.

[Issue: CS-ACNS/2]

SUPPLEMENTARY PERFORMANCE CRITERIA**Vertical performance****AMC1 ACNS.C.PBN.555 Vertical accuracy when using barometric VNAV**

When supporting VNAV, the vertical total system error (TSE_z), taking into account all the errors in the aircraft processing chain of the vertical guidance, should be lower than or equal to the values specified in the table below.

Altitude bands	Level flight segments & climb/descent intercept of clearance altitudes	Flight along specified vertical descent profile
At or below 5 000 ft MSL	150 ft	160 ft
Above 5 000 to 29 000 ft MSL	200 ft	210 ft
Above 29 000 to 41 000 ft MSL	200 ft	260 ft

Maximum vertical total system error (TSE_z)

TSE_z should be calculated as the combination of the altimetry system error (ASE), the vertical path steering error (PSE_z), the vertical path definition error (PDE_z) and the horizontal coupling error (HCE) — see the figure below. Vertical navigation accuracy (TSE_z) is expected to be achieved for at least 99.7 % of the flight time. Assuming that these four errors are Gaussian and independent, the distribution of TSE_z is also Gaussian with a standard deviation equal to the root sum square (RSS) of the standard deviations of the ASE, PSE_z, PDE_z, and HCE.

$$TSE_z = \sqrt{ASE^2 + PSE_z^2 + PDE_z^2 + HCE^2}$$

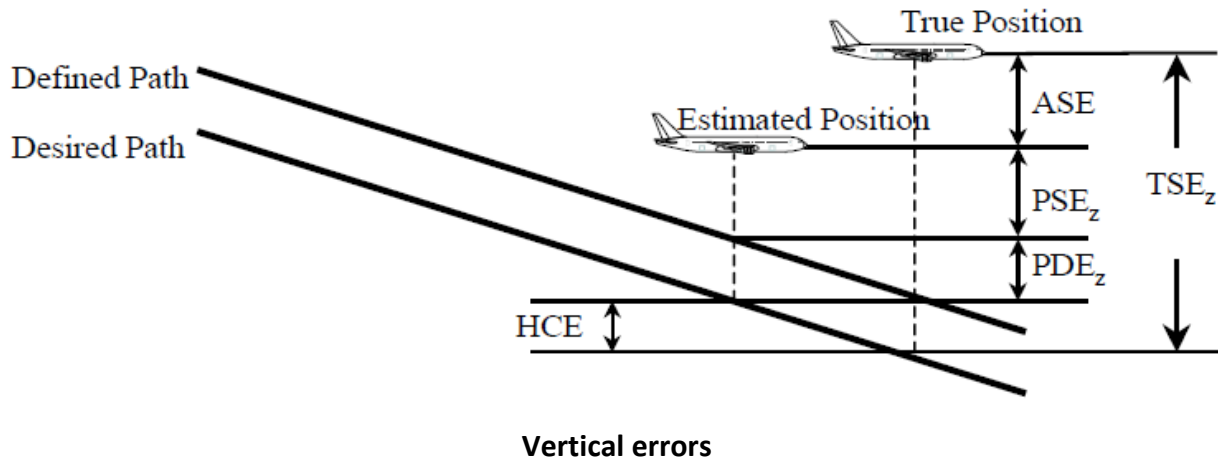

(a) Altimetry system error (ASE)

Altimetry system performance is demonstrated separately from the VNAV certification through the static pressure system certification process (e.g. CS XX.1325). Altimetry systems that meet such a requirement satisfy the ASE requirements for VNAV operations. No further demonstration or compliance is necessary, and the following formula should be used to calculate the ASE (in ft) as a function of the aircraft altitude H (in ft), representing the maximum value which is expected to be achieved for at least 99.7 % of the flight time.

$$ASE = - 8.8 \times 10^{-8} \times H^2 + 6.5 \times 10^{-3} \times H + 50$$

(b) Vertical path definition error (PDE_z)

VNAV path definition error is the error associated to the vertical path computation. It includes path definition error (PDE) and the approximation made by the VNAV equipment for the vertical path construction, if any. This is addressed through equipment approval (ETSO).

(c) Horizontal coupling error (HCE)

HCE (vertical error component of along-track positioning error) is a function of the horizontal NSE and is directly reflected in the along-track tolerance offset used in BARO-VNAV procedure design criteria. The HCE should only be taken into account in the final approach segment.

HCE is expected to be achieved for at least 99.7 % of the flight time and, in this context, may be assumed to be equal to 24 ft on a vertical path of 3 degrees°.

(d) Vertical path steering error (PSE_z)

The vertical path steering performance varies depending on how operations are conducted (manual, flight director or autopilot). The use of a flight director or autopilot may be required to support the PSE_z requirement in certain conditions. In this case, the RNP system coupling to the flight director and/or autopilot should be unambiguously displayed in the flight crew's primary field of view. This should also be documented in the AFM.

[Issue: CS-ACNS/2]

AMC1 ACNS.C.PBN.560 Vertical accuracy when using SBAS/GNSS geometric altitude sources

The vertical total system error (TSE_z) is dependent on the navigation system error (NSE), the path definition error (PDE_z) and the flight technical error (FTE_z).

(a) Navigation system error (NSE)

The NSE should be within the accuracy requirements of ICAO Annex 10, Volume 1 to the Chicago Convention with respect to signal-in-space performance. These NSE requirements are considered to be fulfilled without any demonstration if the equipment has been granted an ETSO authorisation against ETSO-C145c, operational Class 3 or ETSO-C146c, operational Class 3 or 4.

(b) Flight technical error (FTE_z)

FTE_z is considered to be equivalent to the ILS approach if the angular deviations are displayed to the flight crew on the existing or comparable display, and the system meets the integration criteria of paragraph 7(a) of Appendix C to Subpart C of CS-ACNS and the SBAS/GNSS receiver has been granted an ETSO authorisation against ETSO-C145c, operational Class 3 or ETSO-C146c, operational Class 3 or 4.

For flight guidance systems, the FTE_z performance is considered acceptable if it meets the criteria of paragraph 7(a) of Appendix C to Subpart C of CS-ACNS and the SBAS/GNSS receiver has been granted an ETSO authorisation against ETSO-C145c, operational Class 3 or ETSO-C146c, operational Class 3 or 4.

(c) Path definition error (PDE_z)

For approaches to LPV minima, there are no performance or demonstration requirements for PDE_z. PDE_z is considered negligible based on the requirements for the FAS data block generation process.

For approaches to LNAV/VNAV minima, the applicant may assume that the PDE_z is negligible, provided that the RNP system's internal resolution is equal to or better than the resolution provided for the path definition.

[Issue: CS-ACNS/2]

GM1 ACNS.C.PBN.560 Vertical accuracy when using SBAS/GNSS geometric altitude sources

The lateral and vertical full-scale deflection requirements detailed in RTCA DO-229D, which is the basis for ETSO-C145c (operational Class 3) and ETSO-C146c (operational Class 3 or 4), ensure an ILS 'lookalike' presentation. The deflection may be fully angular with no limitation or angular but bounded at a certain value (e.g. bounded at ± 1 NM laterally and ± 150 m vertically).

[Issue: CS-ACNS/2]

AMC 1 ACNS.C.PBN.565 Transitions

Transitions from one source of VNAV to another should not cause discontinuities or transients that have the potential to destabilise the aircraft on final or missed approach. Aspects to consider when transitioning from one source to the other include:

- (a) temperature errors, particularly if operating outside the allowable BARO-VNAV temperature range;
- (b) MSL versus WGS-84 ellipsoid for path definition;
- (c) curved BARO-VNAV path versus straight SBAS/GNSS path; and
- (d) linear BARO-VNAV guidance versus angular SBAS/GNSS guidance.

[Issue: CS-ACNS/2]

AMC1 ACNS.C.PBN.570 Advisory VNAV

Attachment 5 to ARINC 424 provides an acceptable method of origination of the data.

If the data does not originate from an authoritative source, the data should be validated in accordance with ED-76A, Section 2.4.1, item 6.

[Issue: CS-ACNS/2]

GM1 ACNS.C.PBN.570 Advisory VNAV

With reference to (a)(2), the indication should be plain and easy to interpret to avoid confusion. The use of typographic characters (e.g. '+' or '/') as the only means to distinguish whether the vertical guidance is advisory or is referenced to a published procedure is not considered adequate.

The use of the function should be documented in AFM, pilot operating handbook (POH) or similar documents and supplements to these documents and should contain a statement to inform the flight crew that, when advisory VNAV is provided, the primary barometric altimeter should be used as the primary reference for compliance with all altitude restrictions that are associated with the instrument approach procedure, including compliance with step-down fixes.

[Issue: CS-ACNS/2]

AMC1 ACNS.C.PBN.575 RNP system design — integrity in final approach

Guidance on the integrity (provisioning of erroneous output or display of data) by the RNP system related to vertical position or guidance is provided in Appendix A to Subpart C.

[Issue: CS-ACNS/2]

AMC1 ACNS.C.PBN.580 RNP system design — continuity

Guidance on the continuity (loss of the function) of the RNP system to provide vertical position or guidance is provided in Appendix A to Subpart C.

[Issue: CS-ACNS/2]

Subsection 6 — Supplementary specifications for RNP authorisation required (RNP AR)

APPLICABILITY

AMC1 ACNS.C.PBN.601 Applicability

Compliance with the criteria of CS-ACNS for RNP AR operations ensure that the probability of the aircraft exiting the lateral or vertical extent of the obstacle clearance volume of the procedure (i.e. $2 \times \text{RNP}$ and -75 ft.) does not exceed 10^{-7} per procedure; in the case of RNP AR APCH, this includes the missed approach.

Applicants who deviate from the criteria in Subsection 6 should demonstrate that they meet the aforementioned objective.

[Issue: CS-ACNS/2]

GM1 ACNS.C.PBN.601 Applicability

Compliance demonstration of aircraft eligibility for RNP AR approval is often a long and very demanding process. It requires full and unrestricted access to the aircraft's safety (i.e. the data used to support compliance with CS XX.1309), aerodynamics and performance data. Furthermore, the applicant should have, as a minimum, access to a representative simulator for prolonged periods of time. Occasionally, access to the aircraft for flight testing will be required.

More stringent criteria may apply to aircraft that operate with special or proprietary procedures which are not designed to conform to ICAO Doc 9905.

Applicants who intend to apply for RNP AR approval are encouraged to contact EASA at the earliest opportunity to discuss the technical details of the compliance demonstration.

[Issue: CS-ACNS/2]

SUPPLEMENTARY SYSTEM QUALIFICATION

AMC1 ACNS.C.PBN.605 System performance demonstration

The applicant should demonstrate the aircraft capability in terms of performance under design limit operational conditions (e.g. tailwinds and crosswinds, centre-of-gravity (CG) limits, temperature limits), and on representative procedures that include RF legs of varying radii. The applicant should also assess the effects of configuration changes (e.g. gear and flap extension and retraction).

The applicant should conduct a safety impact assessment based on the aircraft's system safety assessments (SSAs) and identify any failure conditions that could potentially impact on performance. The functional hazard assessment (FHA) and SSA of all the aircraft's systems that support RNP AR operations (RNAV systems, flight controls systems, flight guidance systems, displays, etc.) should, therefore, be revisited to identify these failures. System failures should include latent failures ('integrity') and detected failures ('continuity'). For the detected failures, the monitor limit of the alert, the time to alert, the flight crew reaction time, and the aircraft response should all be taken into account and verified to ensure that the aircraft does not exit the obstacle clearance volume.

The intent of this requirement is to ensure robustness of the aircraft and its systems to failure conditions. Consequently, performing a safe extraction contingency procedure, i.e. initiating a missed approach, is not an acceptable means of demonstrating compliance against the criteria of CS ACNS.C.PBN.605(a), (b), and (c). These demonstrations may rely on crew action to intervene and place the aircraft back on the target track even if, in an operational environment, the crew is expected to initiate a missed approach procedure when the lateral or vertical criteria are exceeded. For compliance demonstration purposes, however, executing a safe extraction is not considered appropriate for demonstration of compliance with these criteria.

- (a) With reference to CS ACNS.C.PBN.605(a), any failure that is classified as ‘probable’ and supports the RNP AR operation should be assessed. Those failures that would require the flight crew to act or intervene should be assessed in a representative environment and design limit operational conditions by the applicant’s flight test pilots. The impact of the failure and the flight crew intervention should be such that the aircraft can be maintained within the $1 \times$ RNP value and within -75 ft altitude deviation.
- (b) With reference to CS ACNS.C.PBN.605(b), the same requirements apply for the case of an engine failure. If the engine failure would require the flight crew to act or intervene, then this should be assessed in a representative environment and design limit operational conditions by the applicant’s flight test pilots. The impact of the failure and the flight crew intervention should be such that the aircraft can be maintained within the $1 \times$ RNP value and within -75 ft altitude deviation.
- (c) With reference to CS ACNS.C.PBN.605(c), the same requirements apply, except that, for the case of failures classified as ‘remote’ but not ‘extremely remote’, the impact of the failure and the flight crew intervention should be such that the aircraft can be maintained within the $2 \times$ RNP value and within -75 ft altitude deviation.
- (d) With reference to CS ACNS.C.PBN.605(d), the applicant should demonstrate that no ‘extremely remote’ failure limits the flight crew’s ability to:
 - intervene and place the aircraft back on the target track contained within the alert threshold; or
 - safely extract the aircraft through manual intervention.

Safe extraction is defined as within $2 \times$ RNP for the applicable approach and missed approach procedure, until such time that the aircraft is stabilised and reaches a safe altitude. The RNP for the missed approach procedure is usually higher than the RNP for the continued approach. For extremely remote navigational failure conditions (e.g. all flight management computers (FMCs) failed), the flight crew must be able to navigate the aircraft free of obstacles.

For departure procedures with close-in RF legs at or just beyond the departure end of the runway, and for missed approach procedures with close-in RF legs, the retraction of the landing gear and flaps and subsequent rapid acceleration may affect the RNP system’s ability to conduct accurate turn anticipation. An inaccurate turn anticipation calculation may result in an overshoot of a close-in RF turn. When this performance characteristic is present, the applicant should consider including a limiting airspeed for the initial phase of the departure or the missed approach in the AFM. The airspeed limit should not be lower than the best-climb airspeed with one-engine-inoperative.

The severity level of the above demonstrations (failure conditions in combination with the RNP approach containment requirements), as assessed by the test pilot, must still match the probability of the applicable failure condition (ref.: CS 25.1309).

Specific evaluations should be conducted to assess path excursions upon failures and the resulting RNP levels. Results should be documented in the AFM, AFM Supplement, or any appropriate aircraft operational support document which is approved by EASA and made available to the operator. In other words: If, for example, the worst-case result of the assessments that have been conducted to demonstrate compliance for ‘remote’ failures shows that the aeroplane diverts 0.40 NM from the published track, then the applicant should limit the authorised RNP to 0.20 NM.

[Issue: CS-ACNS/2]

GM1 ACNS.C.PBN.605 System performance demonstration

As regards applications for RNP AR approval, the involvement of flight test pilots in this exercise has been shown to be crucial. Flight crew intervention is an essential aspect of these demonstrations and on occasion it has been proven difficult for flight crews to timely recognise the failure and intervene adequately. An appropriate level of specific training for RNP AR operations may be assumed.

[Issue: CS-ACNS/2]

AMC1 ACNS.C.PBN.610 Source of horizontal position

As a minimum, the inertial positioning source needs to comply with the criteria of Appendix B. The applicant should, however, demonstrate that circular error of the inertial system supports a safe extraction, as defined in AMC1 ACNS.C.PBN.605 in case of loss of GNSS. This may imply that the design of the inertial position source needs to exceed the performance criteria described in Appendix B.

If the RNP system does not exclude VOR-updating automatically, the applicant should identify any pilot procedures for an aircraft to comply with this requirement.

[Issue: CS-ACNS/2]

GM1 ACNS.C.PBN.610 Source of horizontal position

Integrated global navigation satellite system/inertial navigation system (GNSS/INS) or global navigation satellite system/inertial reference unit (GNSS/IRU) position solutions reduce the rate of degradation after loss of position updating. The use of a ‘tightly coupled’ GNSS/inertial system to support RNP AR operations is recommended. For ‘tightly coupled’ GNSS/inertial systems, RTCA/DO-229D Appendix R provides additional guidance.

INS or IRU are generally not considered suitable as a sole source of horizontal position for RNP AR applications described herein. However, it is recognised that many multi-sensor navigation systems utilise INS or IRU within their navigation calculations to provide continuity when the other higher accuracy sensor(s) is (are) momentarily unavailable.

Attitude and heading reference systems (AHRs), including an AHRS with inputs from air-data computers, are generally not considered to provide a level of performance that would be adequate to support RNP AR operations, i.e. meet the criteria of Appendix B.

[Issue: CS-ACNS/2]

SUPPLEMENTARY FUNCTIONAL CRITERIA

RNP system

GM1 ACNS.C.PBN.620 Reversion

This requirement is intended to support the flight crew in extracting the aircraft from the procedure.

[Issue: CS-ACNS/2]

GM1 ACNS.C.PBN.625 Go-around and missed approach

Loss of the RNP capability is considered as a condition that would require the initiation of a missed approach.

[Issue: CS-ACNS/2]

AMC1 ACNS.C.PBN.630 Radius to fix (RF) leg transition

The demonstration of the RF capability should be undertaken considering:

- (a) limit wind speed;
- (b) turn radius;
- (c) configuration changes;
- (d) failure conditions.

With reference to failure conditions (d), the unique requirements on demonstration of performance under failure conditions of CS ACNS.C.PBN.605 apply.

[Issue: CS-ACNS/2]

AMC1 ACNS.C.PBN.635 Navigation accuracy for RNP AR operations

If the RNP system offers multiple RNP values associated with lines of minima on an RNP AR approach procedure, the system should allow the flight crew to select the RNP values associated with the appropriate line of minima for use on the final approach segment. The system should then acquire the associated RNP value(s) for the procedure from the navigation database.

[Issue: CS-ACNS/2]

AMC1 ACNS.C.PBN.640 RNP AR departures

With reference to (c), when the RNP AR DP requires a close-in turn at or just beyond the DER, retraction of the landing gear and flaps during the take-off sequence and subsequent rapid acceleration to en-route climb airspeed may compromise the RNP system's ability to conduct accurate turn anticipation for the close-in turns, possibly resulting in the aircraft's inability to comply with the defined turn (i.e. overshoot a close-in RF turn). Limiting the airspeed for the initial phase of the departure can help ensure the RNP system's turn anticipation calculations are accurate.

With reference to (e), if the aircraft requires the flight crew to conduct a manual INS position update immediately prior to take-off, the applicant should provide procedures requiring the air crew to conduct the position update within 300 meter (1 000 ft) of the start point of the aircraft's take-off roll.

[Issue: CS-ACNS/2]

GM1 ACNS.C.PBN.640 RNP AR departures

With reference to (a), locating an initial fix of an RNP AR DP at or just beyond the approach end of the take-off runway is one acceptable means to facilitate executing an RF leg at the departure end of the runway (DER). The straight segment from the initial fix leading to the fix defining the beginning of the RF leg at the DER helps ensure the aircraft’s path is tangent to the RF leg in order to capture of the RF leg guidance.

[Issue: CS-ACNS/2]

Display of navigation data

AMC1 ACNS.C.PBN.655 Lateral deviation display

The full-scale deflection of the non-numeric lateral deviation display should not be greater than two (2) times the applicable RNP.

[Issue: CS-ACNS/2]

Navigation database

AMC1 ACNS.C.PBN.660 Use of a navigation database

Waypoint definition error should be less than or equal to 60 feet, including both the data storage resolution and the RNP system computational resolution used internally for the construction of flight plan waypoints.

The navigation database should contain vertical angles (glide path angles) stored to a resolution of hundredths of a degree, with equivalent computational resolution.

[Issue: CS-ACNS/2]

Vertical performance

AMC1 ACNS.C.PBN.670 Vertical accuracy

When the vertical position is provided by BARO-VNAV and the aircraft performs stabilised constant descent path, the RNP system should ensure that 99.7 % of the system error in the vertical position is equal to or less than the vertical error budget (VEB) attributed to the aircraft, as defined by (in feet):

$$VEB_{aircraft} = \sqrt{ANPE^2 + WPR^2 + FTE^2 + ASE^2}$$

Where:

ANPE = actual navigation performance error which can be computed as follows:

$$ANPE = 6076.115 \times 1.225 \times RNP \times \tan(\theta)$$

WPR = waypoint precision error which can be computed as follows:

$$WPR = 60 \times \tan(\theta)$$

FTE = flight technical error which can be assumed to be 75 feet with autopilot or flight director coupled.

ASE = altimetry system error which can be computed as follows:

$$ASE = - 8.8 \cdot 10^{-8} \times (h + \Delta h)^2 + 6.5 \cdot 10^{-3}(h + \Delta h) + 50$$

Using:

- ‘ θ ’ as the vertical navigation (VNAV) path angle;
- ‘h’ as the height in feet of the local altimetry reporting station; and
- ‘ Δh ’ as the height in feet of the aircraft above the reporting station.

Note: $VEB_{aircraft}$ contains the elements out of the minimum obstacle clearance (MOC) equation in Appendix 1 to ICAO Document 9905 ‘Required Navigation Performance Authorization Required Procedure Design Manual’, which are attributed to the aircraft. The applicant should not apply the other elements of the MOC equation, i.e. body geometry (bg) error or international standard atmosphere temperature deviation (isad), in support of demonstration of vertical accuracy.

[Issue: CS-ACNS/2]

AMC2 ACNS.C.PBN.670 Vertical accuracy

Where SBAS/GNSS geometric altitude is used, the installation of equipment that supports a 50-m vertical alert limit (VAL) satisfies the requirement for operations down to RNP 0.3 and the installation of equipment that supports a 35-m vertical alert limit (VAL) satisfies the requirement for operations down to RNP 0.1.

[Issue: CS-ACNS/2]

SUPPLEMENTARY PERFORMANCE CRITERIA

AMC1 ACNS.C.PBN.675 RNP system design — RNP AR integrity

Guidance on the integrity (provisioning of erroneous output or display of data) of the RNP system related to RNP AR operations is provided in Appendix A to Subpart C.

[Issue: CS-ACNS/2]

AMC1 ACNS.C.PBN.680 RNP system design — RNP AR continuity

Guidance on the continuity (loss of the function) of the RNP system to provide lateral and vertical position or guidance is provided in Appendix A to Subpart C.

[Issue: CS-ACNS/2]

Subsection 7 — Supplementary specifications for applications for advanced RNP (A-RNP)

SUPPLEMENTARY FUNCTIONAL CRITERIA

RNP system

AMC1 ACNS.C.PBN.715 RNP scalability

Installation of equipment with an ETSO authorisation against ETSO-C115d satisfies the requirement.

[References: ED-75D § 3.7.2.1.3.1, ED-75D § 3.2.6, ED-75D § 3.2.6.2]

[Issue: CS-ACNS/2]

Subsection 8 — Supplementary specifications supporting radius to fix (RF)

SUPPLEMENTARY FUNCTIONAL CRITERIA

RNP system

AMC1 ACNS.C.PBN.805 RF functional requirements

The applicant should perform an evaluation of the navigation system on a representative set of procedure designs under all foreseen operating conditions. The evaluation should address maximum assumed crosswind and maximum altitude with the aircraft operating in the range of expected airspeeds for the manoeuvre and operating gross weights and CG conditions (i.e. forward/aft). Procedure design constraints should include sequencing multiple, consecutive RF leg segments of varying turn radii, including consecutive RF leg segments reversing the direction of turn (i.e. reversing from a left-hand RF turn to a right-hand RF turn).

When evaluating flight technical error on RF legs, the effect of rolling into and out of the turn should be considered.

Within the demonstration, the applicant should be seeking to confirm that the FTE is commensurate with the RNP navigation accuracy.

Where applicable, the ability of the aircraft to maintain an appropriate FTE after a full or partial failure of the autopilot and/or flight director should also be demonstrated.

Any limitations identified during the compliance demonstration should be documented. Flight crew procedures should be assessed, including identification of any limitations which surround the use of pilot selectable or automatic bank angle limiting functions and confirmation of those related to go-around or missed approach from an RF leg segment.

Test procedures for aircraft capability to perform RF legs in approach and departure should make use of the RF leg demonstration templates described in Appendix D to Subpart C.

[Issue: CS-ACNS/2]

GM1 ACNS.C.PBN.805 RF functional requirements

The test procedure is designed to provide 5 degrees of manoeuvrability margin to enable the aircraft to get back on the desired track after a slight overshoot at the start of the turn.

Industry standards for RF defined paths can be found in EUROCAE ED-75D (RTCA DO-236C Change 1).

AMC1 ACNS.C.PBN.815 Autopilot/Flight director

The applicant should perform an evaluation to demonstrate that the aircraft can be maintained on the desired path, without excessive deviations, under all foreseen operating conditions. The demonstrations should be performed on a representative set of procedure designs.

[Issue: CS-ACNS/2]

Subsection 9 — Supplementary specifications supporting fixed radius transition (FRT)

SUPPLEMENTARY FUNCTIONAL CRITERIA

RNP system

AMC1 ACNS.C.PBN.905 Fixed radius transition (FRT) requirements

The installation of equipment with an ETSO authorisation against ETSO-C115d satisfies the requirement.

[Reference ED-75D § 3.2.5.4.2]

[Issue: CS-ACNS/2]

GM1 ACNS.C.PBN.905 Fixed radius transition (FRT) requirements

FRT requirements are defined in Aeronautical Radio, Inc. (ARINC) 424, and their application is described in more detail in EUROCAE documents ED-75D (RTCA DO-236C Change 1).

[Issue: CS-ACNS/2]

Subsection 10 — Supplementary specifications supporting parallel offset

SUPPLEMENTARY FUNCTIONAL CRITERIA

RNP system

AMC1 ACNS.C.PBN.1005 Parallel offset capabilities

The installation of equipment with an ETSO authorisation against ETSO-C115d, Class A, satisfies the requirement.

For RNP systems that have not been granted an ETSO authorisation against ETSO-C115d, Class A, the requirements of ED-75D (RTCA DO-236C Change 1) Section 3.7.2.2.4 'Parallel Offsets' apply, with the following additions:

(a) The RNP system should have the capability to define the offset path from the parent track using an increment of at least 1 NM, left or right and with a total offset of at least 20 NM. Where the RNP system supports the definition of a single, pre-planned parallel offset using specific start and end fixes, the RNP system should:

- (1) provide automatic initiation and cessation of the offset at the start and end waypoint;
- (2) begin transition to the offset path at the start waypoint on the original path to join the intercept path;
- (3) begin the return to the original path so that the return transition ends at the end waypoint on the original path.

With reference to CS ACNS.C.PBN.1005(a) (3)(iii), cases which are not compatible with an offset are considered to be:

- (i) arrival at a fix where a course change exceeds 120 degrees;
 - (ii) a route segment that ends at a hold fix.
- (b) When executing a parallel offset, the RNP system computes the offset reference points using the same resolution that the parent route reference points have. Where FRTs are applied, the offset track should be flown with the same turn radius as the parent track.

[Issue: CS-ACNS/2]

APPENDIX A — GUIDANCE ON CLASSIFICATION OF FAILURE CONDITIONS.

The following table provides guidance for the classification of failure conditions, based on a generic assessment of the risks related to the execution of the flight procedure as defined in the ICAO navigation specification.

As it is not possible for EASA to consider specific aspects of a particular design or particular mitigations, EASA will consider the outcome of a functional hazard assessment (FHA) applied to the specific design. If no FHA is provided, the higher of the classification is applied.

Type of operation	Continuity / Integrity	Classification of Failure Conditions
RNP 1 ¹ , RNP 2, RNP 4, RNP 0.3	Continuity (Loss)	Major
	Integrity (Erroneous)	Major
Advanced RNP, RNP APCH	Continuity (Loss)	Major ^{2,3}
	Integrity (Erroneous)	Major/Hazardous ²
RNP AR APCH, RNP AR DP (RNP ≥ 0.3 NM)	Continuity (Loss)	Major/Hazardous ³
	Integrity (Erroneous)	Major/Hazardous
RNP AR APCH (RNP < 0.3 NM)	Continuity (Loss)	Hazardous ³
	Integrity (Erroneous)	Hazardous

¹ In the RNP 1 navigation specification of the PBN Manual, the loss of function is classified as ‘minor’. Due to EASA’s decision to group all the basic requirements for lateral navigation together in Subsection 2 and not to grant specific approval for each separate navigation specification, but for the entire bundle, the failure condition has been set to ‘major’. Applicants that intend to apply for RNP 1 approval only with an intended classification of the loss of function as ‘minor’ are encouraged to consult EASA as early in the process as possible to discuss the applicable certification criteria.

² The loss of function during the missed approach may be classified as a ‘minor’ failure condition and the integrity may be ‘major’.

³ The loss of VNAV during the final approach may be classified as a ‘minor’ failure condition, provided that lateral navigation is not affected.

APPENDIX B — INS/IRU STANDARD PERFORMANCE AND FUNCTIONALITY

(1) Introduction

Appendix B provides the performance and functionality criteria that an airborne INS/IRU position source should meet to support PBN operations.

(2) INS/IRU position source standard performance and functionality

- (a) The equipment should support an unambiguous indication when its outputs are invalid.
- (b) The navigation function of the equipment should be designed commensurate with a 'major' failure condition.
- (c) The alignment, updating, and navigation computer functions of the system must not be invalidated by normal aircraft power transients.
- (d) The equipment should provide or support the following functions and displays:
 - (i) valid ground alignment capability at all latitudes appropriate for the intended use of the installation;
 - (ii) a display of alignment status; and
 - (iii) the present position of the aeroplane in suitable coordinates.
- (e) The circular error of the equipment should be lower than or equal to 2 nautical miles per flight hour on a 95-per-cent basis.

APPENDIX C — INSTALLATION AND TESTING GUIDANCE

(1) Introduction

- (a) Appendix C provides guidance on the installation and testing of RNP Systems. Depending on the applicable airworthiness standards, the applicant should consider the following paragraphs as indicated below:
 - (i) Paragraphs (2), (3), and (4) of Appendix C should always be considered.
 - (ii) When Subsection 3 ‘Supplementary specifications for lateral navigation in final approach’ is applicable, paragraph (5) ‘Supplementary testing for lateral navigation in final approach’ of Appendix C should be considered.
 - (iii) When Subsection 4 ‘Supplementary specifications for vertical navigation’ is applicable, paragraph (6) ‘Supplementary testing for vertical navigation’ of Appendix C should be considered.
 - (iv) When Subsection 5 ‘Supplementary specifications for vertical navigation in final approach’ is applicable, paragraph (7) ‘Supplementary testing for vertical navigation in final approach’ of Appendix C should be considered.
 - (v) When Subsection 7 ‘Supplementary specifications for applications for advanced RNP’ is applicable, paragraph (8) ‘Supplementary testing for applications for advanced RNP’ of Appendix C, as well as Appendix D ‘RF leg demonstration templates’, should be considered.

(2) Equipment installation

- (a) The applicant should can use equipment that has been granted ETSO authorisation and, in that case, should strictly follow the equipment manufacturer installation guide.
- (b) For each of the equipment installed, the applicant should verify and assess all switching and transfer functions, including electrical bus switching and failure modes under partial or complete loss of electrical power, loss of signal reception, loss of equipment interfaced with the RNP system, etc. Under such failure conditions, the applicant should:
 - (i) evaluate the aircraft’s system response to ensure that the switch is accomplished as expected;
 - (ii) verify that the switch is clearly enunciated and that any warning associated with the loss of equipment is commensurate with the requirements of CS XX.1322; and
 - (iii) verify that the switching itself does not induce any inaccurate guidance and that the autopilot/flight director response is appropriate.
- (c) For a multi-sensor installation, under sensor failure conditions, the applicant should verify the following:
 - (i) that the GNSS is used as a primary source of navigation;
 - (ii) the transfer to an alternative navigation sensor and the appropriate switching mode and annunciation are made;

- (iii) that the switch is clearly enunciated and that any warning associated with the loss of equipment is commensurate with the requirements of CS XX.1322;
 - (iv) that the switching itself does not induce any inaccurate guidance and that the autopilot/flight director response is appropriate; and
 - (v) that the remaining navigation sensors are appropriately reflected in the positioning computation of the RNP system.
- (d) During simulated loss of the GNSS signal-in-space, the applicant should verify that the criteria of point (2)(c)(ii) to (2)(c)(v) are met.
 - (e) Initial certification of systems, including multiple (scanning) DME sensors that have not been previously certified, must be based upon a demonstration of system accuracy by recording (at intervals not greater than 15 minutes) the DME/DME sensor position and comparing it to the actual position during evaluation flights. The latest revisions of FAA AC 25-7D and FAA AC 23-8C provide guidance on test distances from VOR and DME navigation aids. Recorded data should include sufficient signal parameters and sensor performance data to provide a clear indication of satisfactory sensor performance. The applicant should select the particular flight paths based on an analysis of critical signal characteristics, station geometry, signal coverage (including limited station availability with acceptable range), aircraft movement, etc. The system should demonstrate its ability to detect poor signal conditions, inadequate navigation capability, recovery from in-flight power failure, etc. The applicant should review and test the auto-tune logic to verify that ground stations are identified and tuned correctly.
 - (f) Inertial systems that satisfy the criteria of Appendix B do not need further evaluation.
 - (g) With regard to GNSS sensors that have been granted an ETSO authorisation against ETSO-C146 (Class Gamma equipment), it is stipulated that the equipment will support installations with the ability to compensate for the navigation centre to antenna offset. If applicable, the applicant should confirm that the antenna to aircraft centre of navigation offset is appropriate to the installation for GNSS SBAS equipment supporting RNP APCH to LPV and LNAV/VNAV minima.

Note: The fact that the GNSS antenna is top-mounted can result in several feet of vertical difference between the antenna and the aircraft centre of navigation, significantly greater than for ILS antennas. The centre-of-navigation to wheel-crossing height should be evaluated for each installation. For most installations, a fixed vertical offset is adequate.

- (h) The applicant should evaluate the accessibility of all controls pertaining to the installation of the RNP System.
 - (i) The applicant should evaluate the visibility of display(s) and annunciator(s) pertaining to the installation of the RNP System during day and night lighting conditions. No distracting cockpit glare or reflections may be introduced.
- (3) Sensor interference testing
 - (a) GNSS equipment is particularly susceptible to out-of-band SATCOM emissions and in-band inter-modulation between multiple channel SATCOM installations. The applicant should not install GNSS equipment on aircraft with SATCOM transceivers, unless absence of interference with the GNSS sensor is demonstrated.

- (b) Improperly used or installed GNSS re-radiators can present misleading information to GNSS equipment. Equipment manufacturers may provide mitigation against the use of erroneous data for GNSS position and navigation solutions. Possible measures include: implementing or enabling cross-checks of GNSS sensor data against independent position sources and/or other detection monitors using GNSS signal metrics or data. It is left to the applicant to determine that the method chosen by the equipment manufacturer is adequate for the aircraft integration.
 - (c) The applicant should demonstrate the lack of interference from VHF radios on the completed installation of navigation sensors (GNSS, DME where applicable, etc.) by tuning each VHF transmitter to the frequencies listed below and transmitting for a period of 30 seconds while observing the signal status of each satellite being received. Degradation of individually received satellite signals below a point where the satellite is no longer available will require additional isolation measures to be taken:
 - (i) 121.150 MHz; 121.175 MHz; 121.200 MHz; 131.250 MHz; 131.275 MHz; and 131.300 MHz (for radios with 25-kHz channel spacing); and
 - (ii) 121.185 MHz; 121.190 MHz; 130.285 MHz and 131.290 MHz (for radios with 8.33-kHz channel spacing);
 - (d) For installations on rotorcraft, the applicant should ensure that the rotor blades do not interfere with the received signals. This problem has been experienced in some rotorcraft and varies with the rotation rate.
- (4) Generic testing for performance-based lateral navigation
- (a) The applicant should evaluate the navigation parameters displayed on cockpit instruments (such as HSI, CDI, distance display, electronic flight instrument system, moving maps, FMSs, etc.) against the relevant criteria. In particular, the parameters displayed should be consistent across the cockpit, especially the aircraft heading or track reference (magnetic or true), the aircraft altitude (feet or metres), and the aircraft speed (knots or km/h).
 - (b) The applicant should verify that the RNP system continuously provides to the flight crew:
 - (i) an estimation of the present position, the position accuracy and integrity;
 - (ii) the computed desired path and the deviation from that path; in particular, the applicant should:
 - (1) evaluate the sensitivity of the deviation display;
 - (2) verify that the full-scale setting is appropriate for the intended operation; and
 - (3) when applicable, verify that when the full-scale setting changes, the display of the updated deviation is appropriate;
 - (iii) the identification of the active TO waypoint;
 - (iv) the distance, bearing and time to the active TO waypoint; and
 - (v) the aircraft ground speed.

This behaviour should be evaluated for different flight phases, altitudes, and under various normal aircraft manoeuvres (e.g. bank angles of up to 30 degrees and pitch angles associated with take-off, departures, approaches, landing, and missed approaches, as applicable).

- (c) The applicant should verify that the course selector and the RNP system are properly integrated. The behaviour of the system and the display of the aircraft heading and the selected course should be appropriate and consistent when the aircraft follows the RNP system's flight plan but also when the aircraft is manually flown.
- (d) The applicant should verify the automatic and manual selection/deselection of sensor types and positioning aids, in particular:
 - (i) The appropriate automatic sensor selection should be verified, and, where a multi-sensor system is installed, the applicant should check that the automatic selection is consistent with GNSS being the primary source of horizontal position;
 - (ii) Where a multi-sensor system is installed, the applicant should verify the appropriate automatic reversion when one or several sensors fail;
 - (iii) The applicant should verify the appropriate automatic selection and tuning of positioning navigation aids. Where DME is installed, the automatic selection and tuning should be evaluated where multiple DME can be received from the aircraft, for different flight phases and different altitudes. For each sensor, the applicant should verify the continuous aircraft position estimations for different flight phases, altitudes, and various normal aircraft manoeuvring (e.g. bank angles of up to 30 degrees and pitch angles associated with take-off, departures, approaches, landing and missed approaches as applicable);
 - (iv) The applicant should check the capability to manually override the selection or deselection of a positioning sensor type and positioning navigation aids.
- (e) The applicant should verify the capability to create, review, modify and activate a flight plan. In particular, the applicant should verify the capability to extract and load procedures from the navigation database into the RNP system. During the extraction, all procedures' characteristics (sequence of waypoints, speed and/or altitude constraint, etc.) should be loaded into the flight plan.
- (f) The applicant should evaluate the following aspects when the RNP system is interfaced with an autopilot and/or a flight director. If some issues are raised, the RNP system may still be installed, but either should not be connected to the autopilot or have an appropriate aircraft flight manual supplement/rotorcraft flight manual supplement (AFMS/RFMS) limitation that mitigates the issue.
 - (i) The applicant should evaluate the steering response while the flight director and/or autopilot are/is coupled to the RNP system during a variety of different track and mode changes while operating at the maximum and minimum operating speeds. This evaluation should include, as applicable:
 - (1) transition from en route through the approach to missed approach modes and then back to en route;
 - (2) intercept and track to and from a waypoint on a selected course.
 - (ii) The applicant should evaluate:
 - (1) the steering response during the automatic sequencing of various flight plan legs and transition; and
 - (2) the appropriate display of this sequencing to the flight crew.

In particular, the capability to execute fly-by, fly-over, and RNAV holding should be evaluated for different altitudes, wind conditions, aircraft speeds, and configurations.

- (iii) The applicant should verify that the lateral manoeuvre anticipation supplied by the RNP system is appropriate for the aircraft type. The applicant should verify that an appropriate annunciation of impending waypoint crossing is provided.
 - (iv) The applicant should verify that execution of the ‘direct-to’ and ‘direct-to’ with intercept function with a resultant aircraft heading change do not overshoot and do not cause ‘S-turns’.
 - (v) The applicant should evaluate that the autopilot response to the RNP system fault by simulating a representative fault consistent with the equipment architecture (e.g. pulling the circuit breaker). This test should be done under various navigation modes.
 - (vi) The applicant should verify that modification of the flight plan does not impact on the aircraft guidance until the flight plan and its modification is activated. This behaviour should be evaluated for various kinds of flight plan modifications (lateral revision, constraint insertion/deletion, etc.) and for different procedure types (departure procedures, en route, manually inserted segment, arrival procedures, etc.).
 - (g) The applicant should verify that the flight technical error (FTE) does not exceed the FTE credits. This test may not be necessary if the FTE has been previously established for the aircraft concerned. One acceptable way of assessing FTE is to monitor the measured cross-track deviation while either flying under autopilot control or flying manually using the navigation display provided.
 - (h) Tests should verify proper operation of caution indications and lateral navigation interface.
 - (i) Normal flight manoeuvres should not cause loss-of-system sensor inputs and the system dynamic response should be confirmed.
 - (j) The applicant should validate the navigational accuracy of multi-sensor equipment in each operating mode. In addition to overall system navigation performance, particular test requirements for navigational accuracy will vary depending on the particular sensors integrated in the multi-sensor equipment and whether sensor accuracy performance data has previously been obtained. The performance of each navigation sensor should be evaluated separately and in combination with other sensors as applicable.
- (5) Supplementary testing for lateral navigation in final approach
- (a) For installations where the autopilot has not been modified and the RNP system provides ILS-like deviations, the applicant should conduct several approaches:
 - (i) while flying raw data, flight director, and coupled to the autopilot, as applicable;
 - (ii) while intercepting before and after the final approach fix (FAF),
 and check that the autopilot response is appropriate and that the displays are appropriate and consistent within the cockpit.

The objective of this test is not to verify approach performance but to ensure that the RNP system interfaces are compatible with the aircraft. In addition, the autopilot approach functionality should be evaluated to ensure compatibility with the ‘gain scheduling’ employed by some autopilots during approaches.

- (b) For installations where the autopilot has been modified, the autopilot lateral control channel performance has not been assessed, or non-standard deviations are provided (not ILS-like), the approach performance will need to be evaluated by the applicant as per the latest revision of, AMC1 to CS 25.1329, FAA AC 23-17C or FAA AC 29-2C.
 - (c) For manual control to the approach flight path, the applicant should demonstrate that the appropriate flight display(s) provide(s) sufficient information to maintain the approach path and align with the runway or go-around without excessive reference to other cockpit displays.
 - (d) In order to ensure the system operates properly, the applicant should evaluate the lateral full-scale deflection while on approach.
 - (e) The applicant should evaluate how distance to go, course, bearing, etc., are displayed on all flight deck presentations during approach procedures when step-down fixes are included in the navigation database.
- (6) Supplementary testing for vertical navigation
- (a) The applicant should evaluate the autopilot response to the insertion of various altitude constraints into the RNP system's flight plan:
 - (i) 'AT or BELOW' altitude constraint;
 - (ii) 'AT or ABOVE' altitude constraint;
 - (iii) 'AT' altitude constraint;
 - (iv) 'WINDOW' altitude constraint.

The autopilot response should be evaluated under various conditions (different aircraft configurations and speeds, different lateral paths, and transitions at the altitude constraint, etc.).
- (7) Supplementary testing for vertical navigation in final approach
- (a) For installations where the autopilot has not been modified and the RNP System provides ILS-like deviations, the applicant should conduct several approaches:
 - (i) while flying raw data, flight director and coupled to the autopilot, as applicable;
 - (ii) while intercepting before and after the final approach fix (FAF),

and check that the autopilot response is appropriate and that the displays are appropriate and consistent within the cockpit.

The objective of this test is not to verify approach performance, but to ensure that the RNP system interfaces are compatible with the aircraft. In addition, the autopilot approach functionality should be evaluated to ensure compatibility with the 'gain scheduling' employed by some autopilots during approaches. For example, some autopilots depend upon a radio altimeter or middle marker beacon passage inputs to enable a 'glideslope extension' function to reduce oscillating or aerodynamic instability when coupled to a glideslope signal during the final approach phase. As PBN approaches do not have middle marker beacons, the autopilot response needs to be evaluated when incorporating the PBN capability.
 - (b) For installations where the autopilot has been modified, the autopilot lateral control channel performance has not been assessed, or non-standard deviations are provided (not ILS-like),

then the approach performance will need to be evaluated by the applicant as per the latest revision of AMC1 to CS 25.1329, Appendix B of CS-29, FAA AC 23-17b or equivalent means.

- (c) For manual control to the approach flight path, the applicant should demonstrate that the appropriate flight display(s) provide(s) sufficient information to maintain the approach path and align with the runway or go-around without excessive reference to other cockpit displays.
- (d) In order to ensure that the system operates properly, the applicant should evaluate the vertical full-scale deflection while on approach.
- (e) A flight crew workload analysis when operating the RNP system in association with other piloting requirements should be conducted by the applicant during all phases of flight and found to be acceptable, including those non-normal procedures that can be evaluated in flight.
- (f) Where the RNP System is capable of automatically intercepting a vertical path, the vertical fly-by and the autopilot response (if applicable) should be evaluated under different configurations and winds.
- (g) If the equipment uses barometric input, the applicant should verify that the equipment properly interprets the barometer reading. Special consideration should be given to manually entering barometric corrections.
- (h) The initial certification of each BARO-VNAV system to be used for IFR approach operations should be based on a system-performance demonstration by recording the BARO-VNAV equipment vertical guidance and comparing it to the actual aircraft position along a pre-established vertical flight path. This evaluation can be made by using the actual coded path and appropriate path definition.
- (i) Data should be gathered using a variety of descent rates, angles, and lateral navigation source inputs available to the BARO-VNAV system.

Note: GNSS SBAS LNAV/VNAV most closely emulates BARO-VNAV performance.

- (j) When a Class A TAWS is installed and LPV minima are foreseen to be used, the applicant should verify the interface between the TAWS and the RNP system by checking the excessive downward deviation from the glide path.
 - (k) When temperature compensation is enabled, the applicant should ensure that the display of corrected altitude(s) is consistent on all displays in the cockpit.
 - (l) Where the RNP system provides both Barometric VNAV and SBAS/GNSS VNAV, the applicant should ensure that transitions from one source to the other do not result in transients or jumps that would cause either a sudden change in aircraft position on the flight path or in commands that could contribute to destabilisation of the aircraft.
- (8) Supplementary testing for applications for advanced RNP
- (a) The applicant should evaluate the aircraft response to the insertion of a hold to a manual termination. This evaluation should be performed at different altitudes, under different wind conditions, and for different aircraft operating speeds.
 - (b) RF legs should be evaluated as detailed in Appendix D.
 - (c) The use of different navigation accuracies (RNP values) between 0.3 and 1 NM should be evaluated. The applicant should particularly evaluate the aircraft response to navigation accuracy changes and should check that:

- (i) the display update following the navigation accuracy change is appropriate;
- (ii) the display of the updated navigation accuracy is consistent with all displays in the cockpit; and
- (iii) the steering response while the flight director and/or autopilot are/is coupled to the RNP system during the navigation accuracy change is appropriate.

APPENDIX D — RF LEG DEMONSTRATION TEMPLATES**AppD-1 — Introduction**

- (1) Applicants must demonstrate the aircraft's capability to perform all types of RF legs that can be published on instrument procedures as per the procedure design criteria. Appendix D provides templates that are an acceptable method to demonstrate an aircraft's capability to perform RF legs. Applicants may use engineering simulations and/or aircraft for the flight test demonstrations. The templates depict the various RF legs that procedure designers may use when constructing actual initial, intermediate, missed approach, or final approach segments for RNP approaches along with SIDs and STARs. Applicants may use the templates to create one or more approach procedures at the desired aerodrome for flight test demonstration purposes in visual meteorological conditions only. The intent of such demonstrations is to streamline the airworthiness approval for conducting RF legs.
- (2) The demonstration procedures need to include the depicted RF leg types shown in **AppD-2**. To increase flight test efficiency, it is acceptable for applicants to link the individual RF legs that are depicted in the figures by using straight segments to create 'mega procedures' for demonstrating the aircraft's capability. However, the reflex curve legs ('S-turns') and decreasing radius turns must not have a straight segment between the path terminators (see **Figure 1** below for an example). The point is to demonstrate that the aircraft is capable of flying the various types of turns including turns of minimum radius.

Note: Figure 1 is only an example and is not intended as the only possible combination for creating efficient flight profiles.

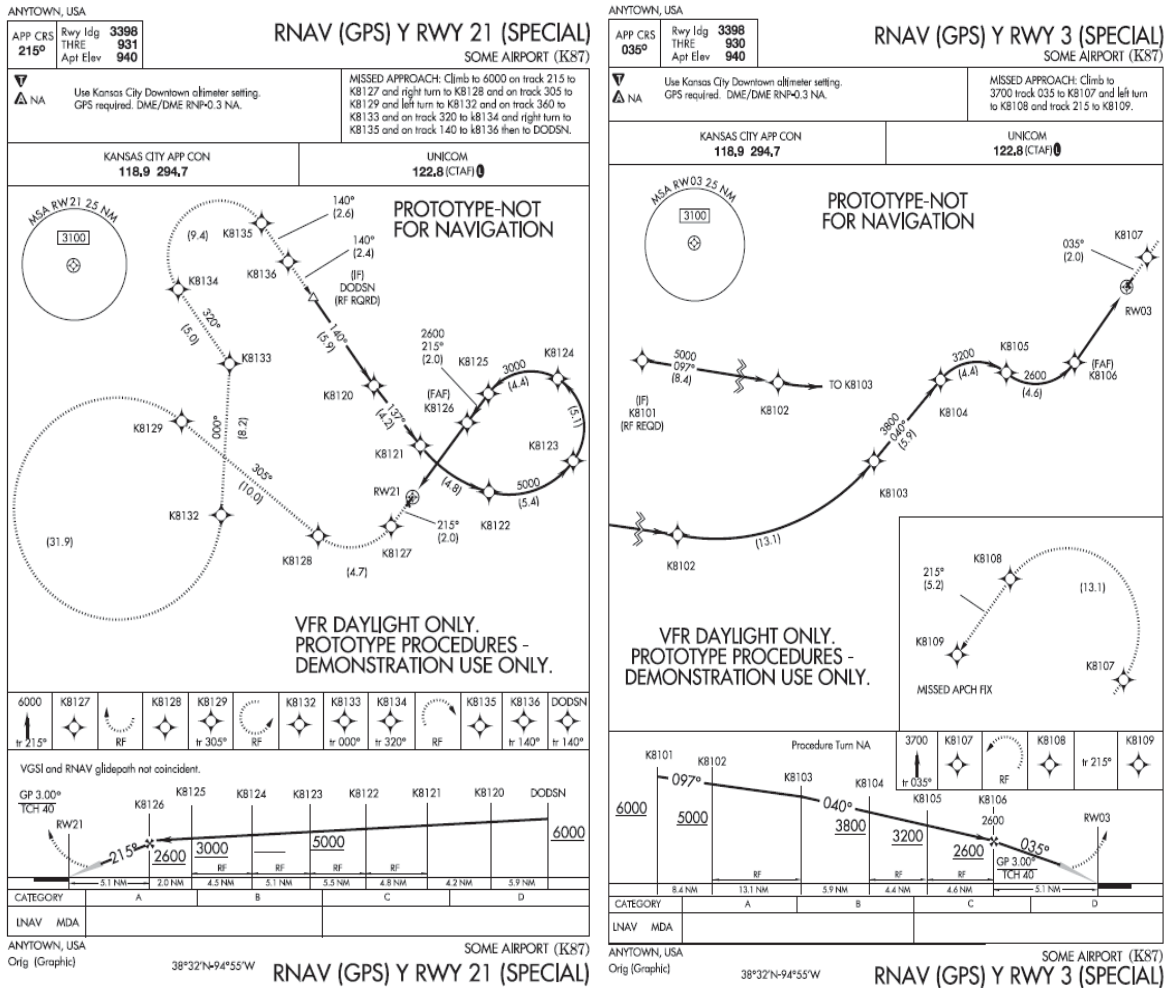

Figure 1: Example procedure profiles

- (3) It should be noted that the templates are designed for use on both RNP AR and standard RNP approach procedures with RF legs. In addition, the procedures created from the templates intend to provide some ‘stressing’ situations as a consequence of the procedure design criteria applied. For example, several RF leg radii were intentionally reduced to approach the 25-degree RNP AR flight guidance system bank angle limits, given the design wind criteria and aircraft approach category C/D in terms of aircraft speeds (121–165 knots).
- (4) **AppD-2** provides a basic description, illustration, and waypoint information for the RF legs. A ‘test guide’ in **AppD-3** lists a recommended testing regimen and considerations for test conduct, but the applicant can tailor the test regimen as needed.
- (5) The test procedures are designed for an aerodrome with an elevation of approximately 1 500 ft MSL. All turn radii were computed using expected ground speeds and altitudes based upon the 1 500-ft MSL aerodrome elevation. The turn radii were adjusted so that the required bank angle, given the adverse wind input, would approach the bank angle limitation noted in the procedure design criteria. The waypoint and navigation leg data is provided so that the procedures can be ‘translated’ to a location suitable to the applicant. However, the elevation of the selected location should be within the range of 1 000–2 000 ft MSL to ensure that the designed turn radii and bank angles do not change significantly. If the location used has an elevation outside the 1 000–2 000-ft MSL range, it is the applicant’s responsibility to ensure the procedures offer adequate obstacle clearance and meet the bank angle limits in the RF leg design criteria.

AppD-2 — Description of test procedures

Each of the procedures is described in this section along with an image for illustration.

AppD-2.1 — Departures

- (1) Design criteria for departures are currently being developed. Subsequently, two procedures were designed using known criteria in addition to criteria features that are likely to be incorporated. One of the procedures mimics a conventional design at Boston Logan International Airport that has proven difficult for some high-performance aircraft to use. Due to environmental restrictions on the ground track, the previous conventional procedure incorporates a series of short track-to-fix (TF) legs that, when viewed from a larger perspective, ‘looks’ like a series of RF legs when considering that each of the waypoints are ‘fly-by’. However, in the conventional format, some FMSs have difficulty with the short leg segments and, therefore, announce an inability to capture a subsequent leg. The resolution to this issue is the RF leg or a series of RF legs that ensure conformance to the desired ground path. The ‘Alpha departure’ shown in **Figure 2** incorporates an RF leg shortly after take-off followed by a straight climbing segment to a series of two back-to-back RF legs with reducing radii. Waypoint information is shown in **Table 1**.

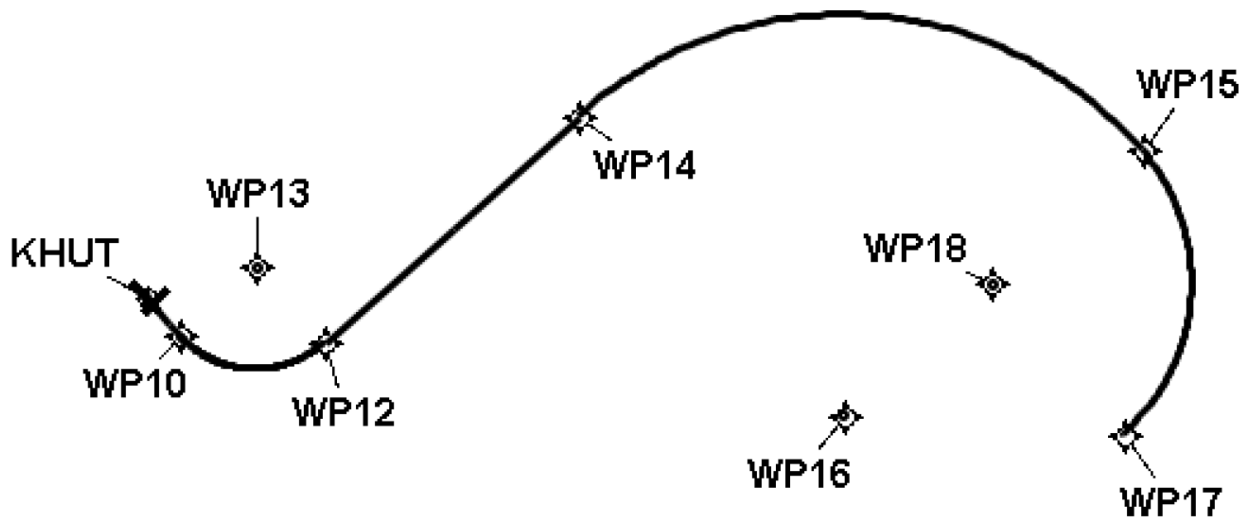

Figure 2: Alpha departure

Runway Transition Data - Northwest1 DEP														
DB	Waypoint	Distance	Leg	FO/FB	Latitude	Longitude	TC	MC	Altitude	Speed	MEA	Arc Center Lat (D° M' S.ss")	Arc Center Lon (D° M' S.ss")	Arc Radius (NM)
NACO: FULL	DER RW13				N38 03 35.48	W097 51 17.61								
	WP10 WP	1.00	CF	FB	N38 02 50.65	W097 50 27.06	138.28	132.28	+2043					
	WP12 WP	4.71	RF		N38 02 36.01	W097 45 05.27						N38 04 50.54	W097 47 36.91	3.00
	WP14 WP	10.03	TF	FB	N38 09 15.81	W097 35 35.10	48.37	42.37		230				
	WP15 WP	18.36	RF		N38 08 14.78	W097 14 40.04						N38 00 29.33	W097 25 46.14	11.70
	WP17 WP	9.23	RF		N37 59 56.88	W097 15 19.74				250		N38 04 21.38	W097 20 14.52	5.87

Waypoint Data									
DB	Waypoint	Arc Center	Lat-Long (DMS.S)	Latitude (Deg)	Longitude (Deg)	Latitude (D°, M, mm')	Longitude (D°, M, mm')	Latitude (D° M' S.ss")	Longitude (D° M' S.ss")
	WP10 WP		380250.65N-0975027.06W	N 38.0474016	W 97.8408493	N38 02.844	W97 50.451	N38 02 50.65	W097 50 27.06
	WP12 WP		380236.01N-0974505.27W	N 38.0433368	W 97.7514634	N38 02.600	W97 45.088	N38 02 36.01	W097 45 05.27
	WP13 WP	Y	380450.54N-0974736.91W	N 38.0807058	W 97.7935850	N38 04.842	W97 47.615	N38 04 50.54	W097 47 36.91
	WP14 WP		380915.81N-0973535.10W	N 38.1543916	W 97.5930830	N38 09.263	W97 35.585	N38 09 15.81	W097 35 35.10
	WP15 WP		380814.78N-0971440.04W	N 38.1374327	W 97.2444558	N38 08.246	W97 14.667	N38 08 14.78	W097 14 40.04
	WP16 WP	Y	380029.33N-0972546.14W	N 38.0081485	W 97.4294845	N38 00.489	W97 25.769	N38 00 29.33	W097 25 46.14
	WP17 WP		375956.88N-0971519.74W	N 37.9991334	W 97.2554842	N37 59.948	W97 15.329	N37 59 56.88	W097 15 19.74
	WP18 WP	Y	380421.38N-0972014.52W	N 38.0726064	W 97.3373679	N38 04.356	W97 20.242	N38 04 21.38	W097 20 14.52

No FAA checks included.

Database Effective Dates

Database	Date
NFDC	10/20/2011
JEPPESEN	N/A
IFP OFFLINE	N/A
AVNIS	12/15/2011
benefits	N/A
NACO	N/A

Table 1: Alpha departure waypoints

- (2) The 'Bravo departure' shown in Figure 3 consists of an RF leg shortly after take-off followed by a brief straight segment, then two back-to-back RF legs with a turn direction reversal. The turn radii also vary as the aircraft climbs and increases performance. Waypoint information is shown in Table 2.

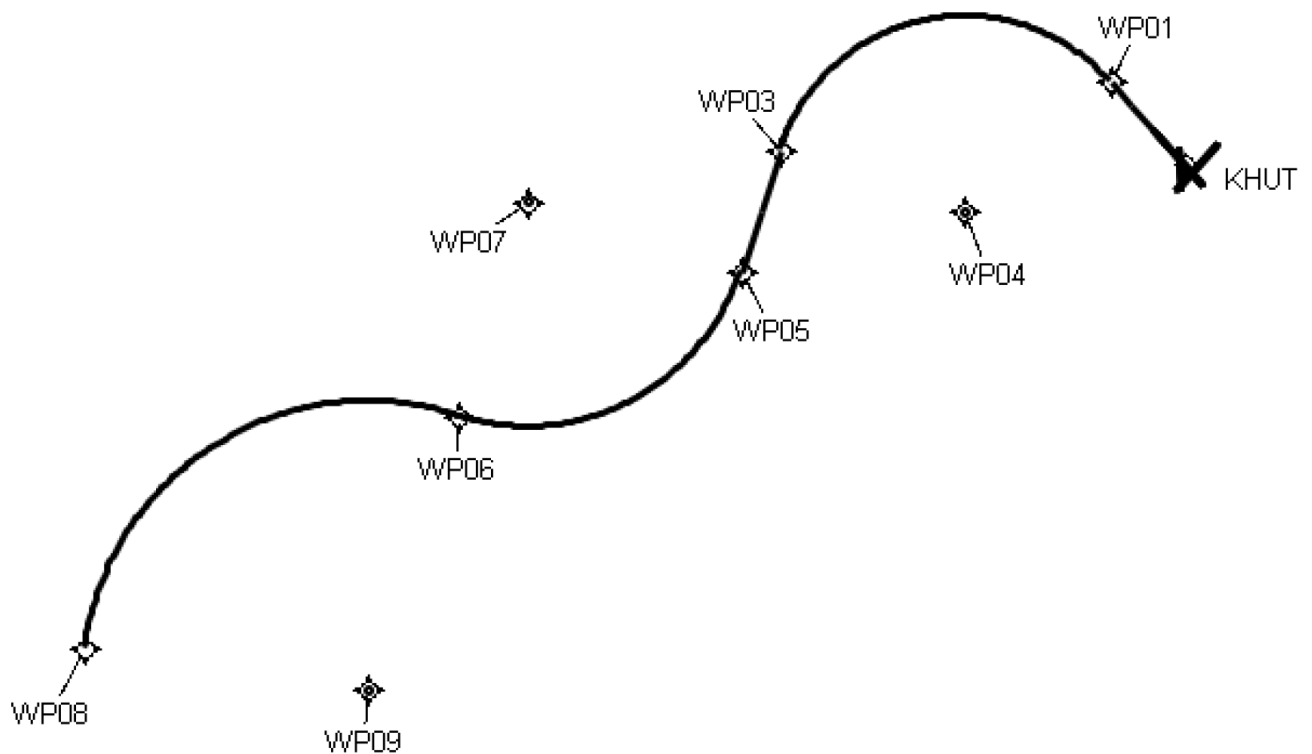

Figure 3: Bravo departure

Runway Transition Data - Southwest1 DEP														
DB	Waypoint	Distance	Leg	FO/FB	Latitude	Longitude	TC	MC	Altitude	Speed	MEA	Arc Center Lat (D° M' S.ss")	Arc Center Lon (D° M' S.ss")	Arc Radius (NM)
NACO: FULL	DER RW31				N38 04 27.15	W097 52 15.90								
	WP01 WP	1.00	CF	FB	N38 05 11.97	W097 53 06.49	318.27	312.27	+2043					
	WP03 WP	6.40	RF		N38 04 07.23	W097 59 40.21						N38 03 09.74	W097 55 59.72	3.06
	WP05 WP	2.00	TF	FB	N38 02 13.13	W098 00 27.73	198.23	192.23						
	WP06 WP	5.53	RF		N37 59 58.37	W098 06 05.17				230		N38 03 19.16	W098 04 41.65	3.52
	WP08 WP	7.86	RF		N37 56 19.81	W098 13 30.08				250		N37 55 41.30	W098 07 51.90	4.50
Waypoint Data														
DB	Waypoint	Arc Center	Lat-Long (DMS.S)	Latitude (Deg)	Longitude (Deg)	Latitude (D° M.mm')	Longitude (D° M.mm')	Latitude (D° M' S.ss")	Longitude (D° M' S.ss")					
	WP01 WP		380511.97N-0975306.49W	N 38.0866586	W 97.8851359	N38 05.200	W97 53.108	N38 05 11.97	W097 53 06.49					
	WP03 WP		380407.23N-0975940.21W	N 38.0686757	W 97.9945032	N38 04.121	W97 59.670	N38 04 07.23	W097 59 40.21					
	WP04 WP	Y	380309.74N-0975559.72W	N 38.0527067	W 97.9332567	N38 03.162	W97 55.995	N38 03 09.74	W097 55 59.72					
	WP05 WP		380213.13N-0980027.73W	N 38.0369801	W 98.0077039	N38 02.219	W98 00.462	N38 02 13.13	W098 00 27.73					
	WP06 WP		375958.37N-0980605.17W	N 37.9995476	W 98.1014351	N37 59.973	W98 06.086	N37 59 58.37	W098 06 05.17					
	WP07 WP	Y	380319.16N-0980441.65W	N 38.0553211	W 98.0782353	N38 03.319	W98 04.694	N38 03 19.16	W098 04 41.65					
	WP08 WP		375619.81N-0981330.08W	N 37.9388359	W 98.2250232	N37 56.330	W98 13.501	N37 56 19.81	W098 13 30.08					
	WP09 WP	Y	375541.30N-0980751.90W	N 37.9281393	W 98.1310840	N37 55.688	W98 07.865	N37 55 41.30	W098 07 51.90					

No FAA checks included.

Database Effective Dates

Database	Date
NFDC	10/20/2011
JEPPESEN	N/A
IFP OFFLINE	N/A
AVNIS	12/15/2011
benefits	N/A
NACO	N/A

Table 2: Bravo departure waypoints

AppD-2.2 — Arrival

- (1) A single arrival was designed which is similar to a previously studied design at Fargo, North Dakota, USA. As the aircraft descends and decelerates, it follows a path that consists of a series of RF legs with a reversal of the turn direction after the first turn. The second directional turn consists of two back-to-back RF legs with decreasing radii. The arrival is shown in **Figure 4** and waypoint information is shown in **Table 3**.

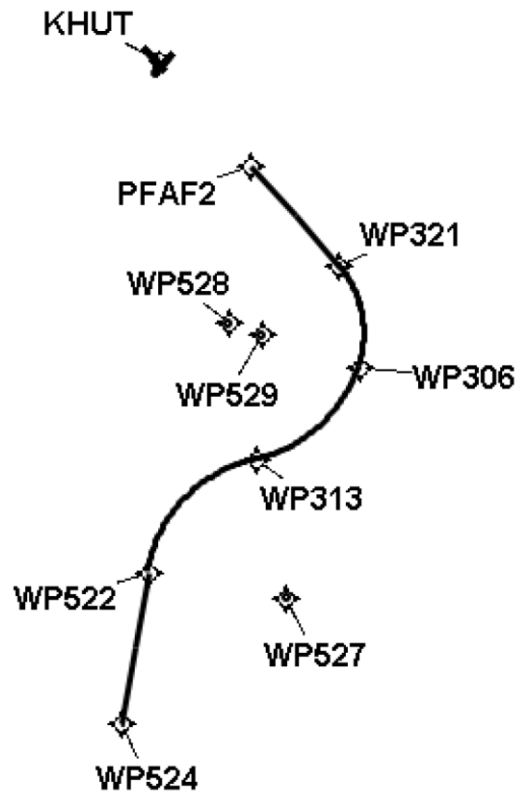

Figure 4: Arrival

Runway Transition Data - South RNAV STAR														
DB	Waypoint	Distance	Leg	FO/FB	Latitude	Longitude	TC	MC	Altitude	Speed	MEA	Arc Center Lat (D° M' S.ss")	Arc Center Lon (D° M' S.ss")	Arc Radius (NM)
	WPS24 WP		IF		N37 40 27.46	W097 53 15.62								
	WPS22 WP	5.40	TF	FB	N37 45 46.51	W097 52 03.10	10.23	4.23						
	WP313 WP	5.91	RF		N37 49 46.57	W097 47 09.39						N37 44 52.99	W097 45 51.24	5.00
	WP306 WP	5.19	RF		N37 53 05.51	W097 42 30.19						N37 54 37.47	W097 48 27.02	4.85
	PFAF2 WP	3.86	RF		N37 56 42.35	W097 43 28.16						N37 54 14.09	W097 46 56.16	3.89
	WP321 WP	4.70	TF	FB	N38 00 12.21	W097 47 26.74	318.04	312.04						
Waypoint Data														
DB	Waypoint	Arc Center	Lat-Long (DMS.S)	Latitude (Deg)	Longitude (Deg)	Latitude (D°, M.mm)	Longitude (D°, M.mm)	Latitude (D° M' S.ss")	Longitude (D° M' S.ss")					
	PFAF2 WP		375642.35N-0974328.16W	N 37.9450982	W 97.7244900	N37 56.706	W97 43.489	N37 56 42.35	W097 43 28.16					
	WP306 WP		375305.51N-0974230.19W	N 37.8848637	W 97.7083862	N37 53.092	W97 42.503	N37 53 05.51	W097 42 30.19					
	WP313 WP		374946.57N-0974709.39W	N 37.8296033	W 97.7859430	N37 49.778	W97 47.157	N37 49 46.57	W097 47 09.39					
	WP321 WP		380012.21N-0974726.74W	N 38.0033911	W 97.7907609	N38 00.203	W97 47.446	N38 00 12.21	W097 47 26.74					
	WPS22 WP		374546.51N-0975203.10W	N 37.7629185	W 97.8675290	N37 45.775	W97 52.052	N37 45 46.51	W097 52 03.10					
	WPS24 WP		374027.46N-0975315.62W	N 37.6742955	W 97.8876734	N37 40.458	W97 53.280	N37 40 27.46	W097 53 15.62					
	WPS27 WP	Y	374452.99N-0974551.24W	N 37.7480540	W 97.7642320	N37 44.883	W97 46.854	N37 44 52.99	W097 45 51.24					
	WPS28 WP	Y	375437.47N-0974827.02W	N 37.9104090	W 97.8075046	N37 54.625	W97 48.450	N37 54 37.47	W097 48 27.02					
	WPS29 WP	Y	375414.09N-0974656.16W	N 37.9039145	W 97.7822680	N37 54.235	W97 46.936	N37 54 14.09	W097 46 56.16					

No FAA checks included.

No TERPS Surfaces included.

Database Effective Dates

Database	Date
NFDC	10/20/2011
JEPPESEN	N/A
IFP OFFLINE	N/A
AVNIS	12/15/2011
benefits	N/A
NACO	N/A

Table 3: Arrival waypoints

AppC-2.3 — Approaches

- (1) Three approaches are provided to assess avionics guidance capability through a series of RF leg approach designs. These templates are acceptable for demonstrating the aircraft’s capability to perform both RNP AR and standard RNP APCH approach procedures.
- (2) As shown in **Figure 5**, Approach 1 is a teardrop procedure that incorporates a descending RF right turn to final, rolling out at the final approach fix. Note that there is no straight segment 2 NM prior to the final approach fix which will be stressing for RNP APCH final approach guidance due to the reduced scaling transition from terminal mode to approach mode. This path requires the aircraft to descend, decelerate, and then configure for landing all during the RF leg. The missed approach also contains an RF leg en route to the missed approach hold. Waypoint information is shown in **Table 4** and vertical error budget information is shown in **Table 5**.

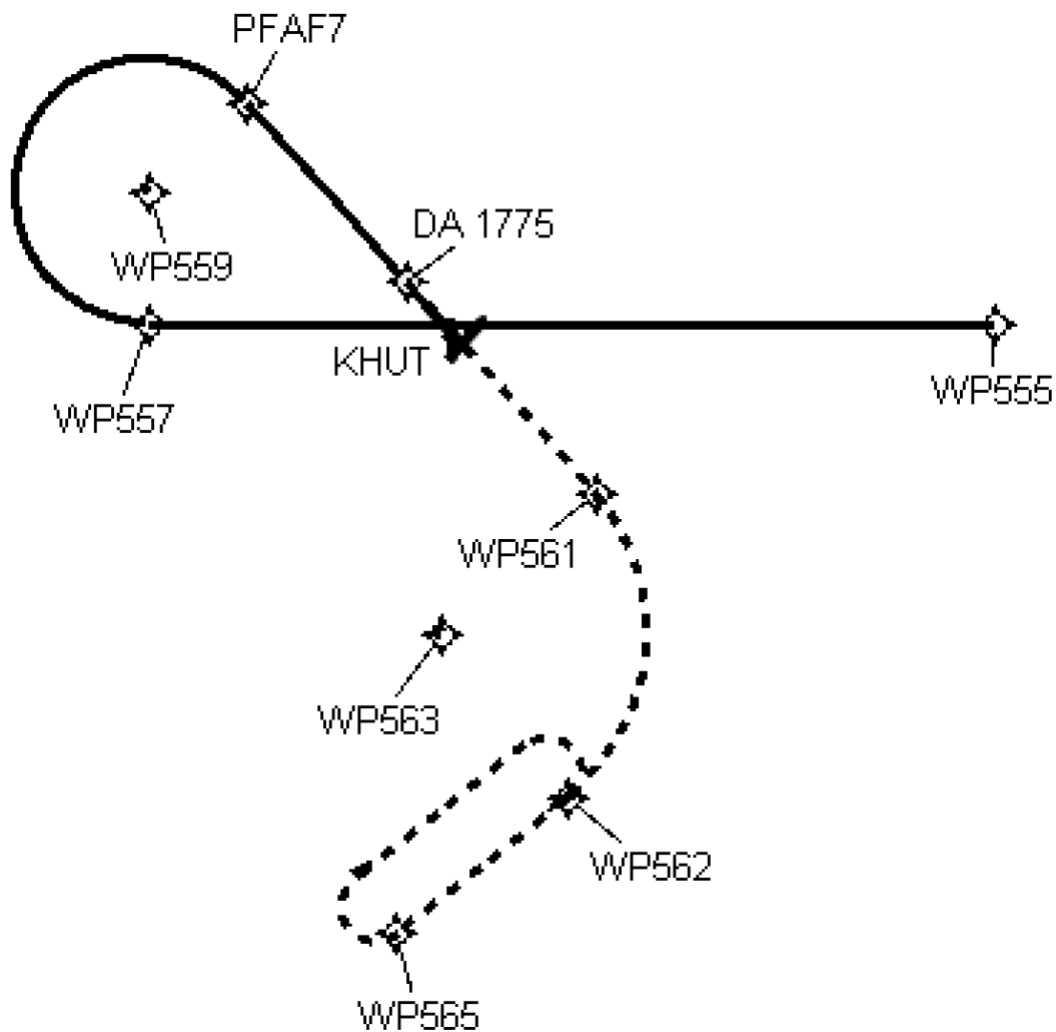

Figure 5: Approach 1

Leg Table 1

Segment	Leg Type	Start	End	Turn Type	Glide Path End Alt	Min Obs./ ATC End Alt	Max End Alt	Turn Radius Comp Alt	Descent Grad	Climb Grad	End Spd	Turn Radius Comp Spd	RNP	Turn Dir
Intermediate	IF	WP555	WP555	FB	10129			10129.22	0.0			300.0	1.0	
Intermediate	TF	WP555	WP557	FB	6235			6235.10				165.0	1.0	LEFT
Final	RF	WP557	PFAF7	FB	3172			6235.10				165.0	0.3	RIGHT
Final	TF	PFAF7	KHUT:RW13:AER	FB	1580			1580.00				165.0	0.3	
Missed	TF	DA 1775	WP561	FB				4337.40				265.0	1.0	RIGHT
Missed	RF	WP561	WP562	FB				4873.04				265.0	1.0	RIGHT
Missed	TF	WP562	WP565	FB				6881.69				265.0	1.0	
Missed	HM	WP565	WP565	FB				8890.33				265.0	1.0	RIGHT

Leg Table 2

Segment	Leg Type	Start	End	Turn Type	Leg Length (NM)	Leg Length (FT)	Start Course Magnetic	End Course Magnetic	Course Change	RF/Flyby Leg Radius	RF/Flyby Turn Bank Angle	Tailwind	RF Leg Arc Center
Intermediate	IF	WP555	WP555	FB	0.00	0.00000							
Intermediate	TF	WP555	WP557	FB	15.58	94644.27202	264.04	263.84					
Final	RF	WP557	PFAF7	FB	9.62	58427.49136	263.86	131.96	228.10	2.4156	19.95	59.35	WP559
Final	TF	PFAF7	KHUT:RW13:AER	FB	5.00	30380.57743	131.96	132.00	0.00		n/a	30.00	
Missed	TF	DA 1775	WP561	FB	5.22	31746.48819	131.96	132.00					
Missed	RF	WP561	WP562	FB	6.30	38255.73029	132.00	226.20	94.20	3.8294	24.89	56.65	WP563
Missed	TF	WP562	WP565	FB	4.02	24409.52927	226.16	226.12					
Missed	HM	WP565	WP565	FB	4.02	24409.52927	226.16						

Waypoint Data

DB	Waypoint	Latitude (Deg)	Longitude (Deg)	Latitude (Deg, Decimal Min)	Longitude (Deg, Decimal Min)	Latitude (D° M' S.ss")	Longitude (D° M' S.ss")
	PFAF7 WP	N 38.1361836	W 97.9417593	N38 8.171	W97 56.506	N38 08 10.26	W097 56 30.33
	WP555 WP	N 38.0691650	W 97.8507673	N38 4.150	W97 38.046	N38 04 08.99	W097 39 02.76
	WP557 WP	N 38.0688801	W 97.9795143	N38 4.133	W97 58.771	N38 04 07.97	W097 58 46.25
	WP559 WP	N 38.1091356	W 97.9796419	N38 6.551	W97 58.779	N38 06 33.07	W097 58 46.71
	WP561 WP	N 38.0170377	W 97.8059367	N38 1.022	W97 48.356	N38 01 01.34	W097 48 21.37
	WP562 WP	N 37.8237951	W 97.8164481	N37 55.428	W97 48.987	N37 55 25.66	W097 48 59.21
	WP563 WP	N 37.8742701	W 97.8659231	N37 58.456	W97 51.955	N37 58 27.37	W097 51 57.32
	WP565 WP	N 37.8826581	W 97.8832395	N37 52.959	W97 52.994	N37 52 57.57	W097 52 59.66

PFAF

	LAT	LON
LTP/FTP	N38 04 27.15	W097 52 15.90
Runway True Bearing	138.00	
FAF Altitude	6235.10	
LTP/FTP Elevation	1525.00	
TCH	55.00	
Glidepath Angle	3.00	
GPI	1049.46	
FAF Distance From LTP/FTP	88808.07 Feet	
	14.62 NM	
PFAF	N38 04 07.97	W097 58 46.25

RNAV (RNP)Z RW13

Created : Fri Jan 06 09:13:34 EST 2012 in TARGETS vTARGETS 4.8 Beta 01/06/2012 (r23735), NACO effective date 1003

Table 4: Approach 1 waypoint information

RNP Value	0.30
LTP MSL Elevation	1525.00
Distance (ft) LTP to PFAF	88808.07
MSL PFAF Altitude	6235.10
Glidepath Angle	3.00
TCH	55.00
Delta ISA (dISA)	0.00
Semispan	131.00

Max Glidepath Angle	3.50
PFAF Elevation	6235.10
LTP Elevation	1525.0
ACT	0.00

Min Glidepath Angle	3.10	
NA Below	11.95 (C)	53.51 (F)
NA Above	46.85 (C)	116.32 (F)

Dist (ft) LTP to OCS ORIGIN	3324.78
OCS Slope (run:rise)	19.15:1
VEB ROC @ PFAF	72.14

Error Components	(Enter Bank Angle, WPR, FTE, and ATIS values below)	@ 250 ft	@ PFAF
ISAD	$(dh \times dISA)/288 + dISA - 0.5 \times .00198 \times (dh+h)$	0.00	0.00
BG	$40.48 \times \text{semispan} \times \sin(\text{Bank Angle})$	40.48	40.48
ANPE	$1.225 \times rnp \times \tan(a)$	117.03	117.03
VAE	$D \times (\tan(a) - \tan(a - .01)) \quad D=250/\tan(a)$	0.83	15.73
WPR	$60.00 \times \text{WPR} \times \tan(a)$	3.14	3.14
FTE	75.00	75.00	75.00
ASE	$-8.8 \times 10^{-8} \times (h + D \times \tan(a))^2 + 6.5 \times 10^{-3} \times (h + D \times \tan(a)) + 50$	61.26	87.11
ATIS	20.00	20.00	20.00

Table 5: Approach 1 vertical error budget (VEB)

- (3) Approach 2, as shown in **Figure 6**, is also a descending right turn to final but has a series of four RF legs with differing radii. Similar to Approach 1 in **Figure 5**, this path will require the aircraft to descend and decelerate during the RF leg. Waypoint information is shown in **Table 6** and vertical error budget information is included in **Table 7**.

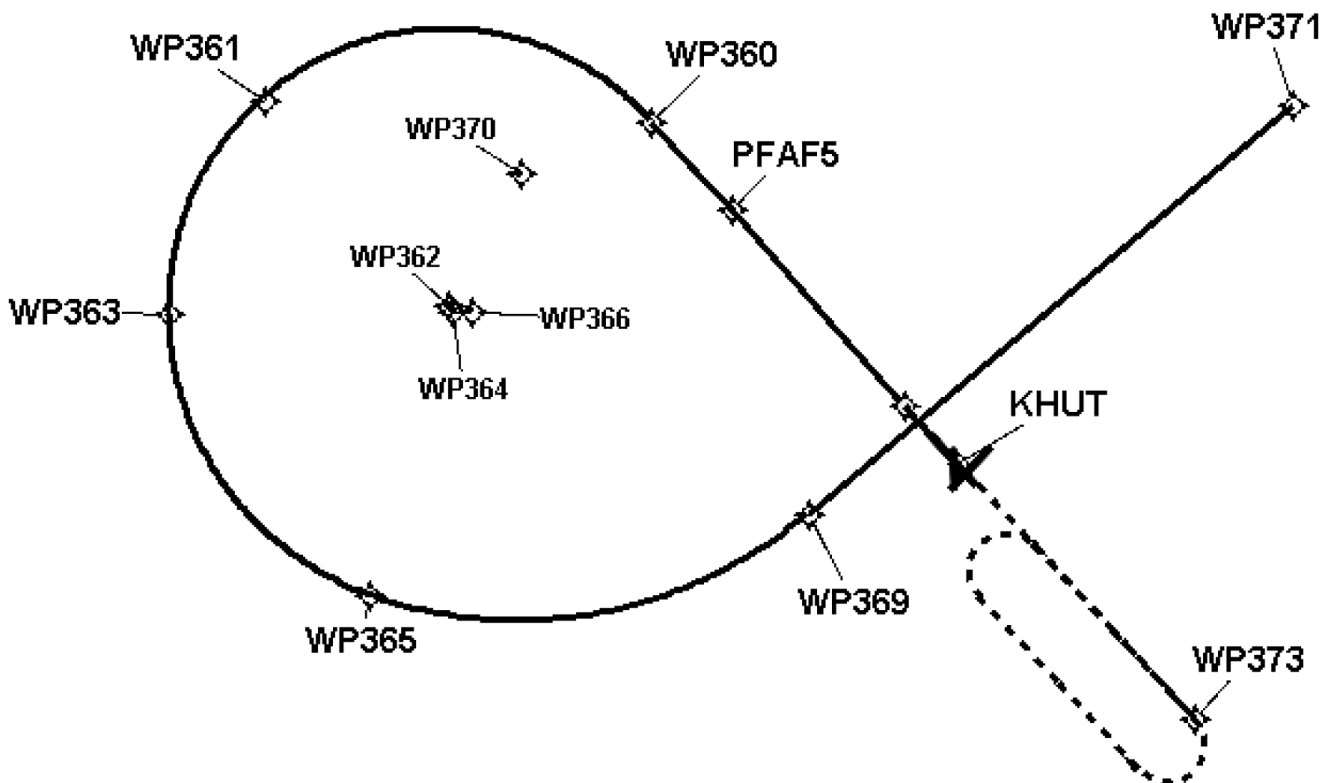

Figure 6: Approach 2

Leg Table 1

Segment	Leg Type	Start	End	Turn Type	Glide Path End Alt	Min Obs./ ATC End Alt	Max End Alt	Turn Radius Comp Alt	Descent Grad	Climb Grad	End Spd	Turn Radius Comp Spd	RNP	Turn Dir
Intermediate	IF	WP371	WP371	FB	12677			12678.98	0.0			300.0	1.0	
Intermediate	TF	WP371	WP369	FB	10009			10009.28				300.0	1.0	RIGHT
Intermediate	RF	WP369	WP365	FB	8044			10009.28				300.0	1.0	RIGHT
Intermediate	RF	WP365	WP363	FB	6499			8043.55				250.0	1.0	RIGHT
Intermediate	RF	WP363	WP361	FB	5486			6499.25				250.0	1.0	RIGHT
Intermediate	RF	WP361	WP360	FB	3672			5486.00				250.0	1.0	RIGHT
Intermediate	TF	WP360	PFAF5	FB	3172			3172.36				165.0	1.0	RIGHT
Final	TF	PFAF5	KHUT:RW13:AER	FB	1580			1580.00				165.0	0.3	
Missed	TF	DA 1775	WP373	FB				5312.04				265.0	1.0	
Missed	HM	WP373	WP373	FB				3725.00				265.0	1.0	RIGHT

Leg Table 2

Segment	Leg Type	Start	End	Turn Type	Leg Length (NM)	Leg Length (FT)	Start Course Magnetic	End Course Magnetic	Course Change	RF/Flyby Leg Radius	RF/Flyby Turn Bank Angle	Tailwind	RF Leg Arc Center
Intermediate	IF	WP371	WP371	FB	0.00	0.00000							
Intermediate	TF	WP371	WP369	FB	10.67	64836.91202	223.80	223.70					
Intermediate	RF	WP369	WP365	FB	7.86	47776.01926	223.70	283.59	59.89	7.5100	19.36	66.82	WP370
Intermediate	RF	WP365	WP363	FB	6.18	37533.45966	283.59	353.36	69.76	5.0700	19.68	62.93	WP368
Intermediate	RF	WP363	WP361	FB	4.05	24626.59378	353.36	42.16	48.81	4.7600	19.79	59.87	WP364
Intermediate	RF	WP361	WP360	FB	7.25	44079.45700	42.16	132.22	90.05	4.6200	19.65	57.86	WP362
Intermediate	TF	WP360	PFAF5	FB	2.00	12152.23097	132.22	132.23	0.02		n/a	30.00	
Final	TF	PFAF5	KHUT:RW13:AER	FB	5.00	30380.57743	132.23	132.28	1.16		n/a	30.00	
Missed	TF	DA 1775	WP373	FB	7.17	43590.52964	131.07	131.14					
Missed	HM	WP373	WP373	FB	4.00	24304.46194	131.07						

Waypoint Data

DB	Waypoint	Latitude (Deg)	Longitude (Deg)	Latitude (Deg, Decimal Min)	Longitude (Deg, Decimal Min)	Latitude (D° M' S.ss")	Longitude (D° M' S.ss")
	PFAF5 WP	N 38.1364523	W 97.9413803	N38 8.187	W97 56.483	N38 08 11.23	W097 56 28.97
	WP360 WP	N 38.1613379	W 97.9695326	N38 9.680	W97 58.172	N38 09 40.82	W097 58 10.32
	WP361 WP	N 38.1673998	W 98.1073560	N38 10.044	W98 6.441	N38 10 02.64	W098 06 26.48
	WP362 WP	N 38.1099519	W 98.0422797	N38 6.597	W98 2.537	N38 06 35.83	W098 02 32.21
	WP363 WP	N 38.1073598	W 98.1408183	N38 6.442	W98 8.449	N38 06 26.50	W098 08 26.95
	WP364 WP	N 38.1082105	W 98.0403093	N38 6.493	W98 2.419	N38 06 29.56	W098 02 25.11
	WP365 WP	N 38.0285723	W 98.0696613	N38 1.714	W98 4.180	N38 01 42.86	W098 04 10.78
	WP366 WP	N 38.1082629	W 98.0337635	N38 6.496	W98 2.026	N38 06 29.75	W098 02 01.55
	WP369 WP	N 38.0510922	W 97.9138308	N38 3.066	W97 54.830	N38 03 03.93	W097 54 49.79
	WP370 WP	N 38.1466107	W 98.0164594	N38 8.797	W98 0.988	N38 08 47.80	W098 00 59.25
	WP371 WP	N 38.1661249	W 97.7418454	N38 9.967	W97 44.511	N38 09 58.05	W097 44 30.64
	WP373 WP	N 37.8941400	W 97.7766721	N37 59.648	W97 46.600	N37 59 38.90	W097 46 36.02

PFAF

	LAT	LON
LTP/FTP	N38 04 27.15	W097 52 15.90
Runway True Bearing	138.00	
FAF Altitude	3172.36	
LTP/FTP Elevation	1525.00	
TCH	55.00	
Glidepath Angle	3.00	
GPI	1049.46	
FAF Distance From LTP/FTP	30380.58 Feet	
	5.00 NM	
PFAF	LAT N38 08 11.23	LON W097 56 28.97

Table 6: Approach 2 waypoints

RNP Value	0.30	Max Glidepath Angle	3.50
LTP MSL Elevation	1525.00	PFAF Elevation	3172.36
Distance (ft) LTP to PFAF	30380.58	LTP Elevation	1525.0
MSL PFAF Altitude	3172.36	ACT	0.00
Glidepath Angle	3.00		
TCH	55.00	Min Glidepath Angle	3.10
Delta ISA (dISA)	0.00	NA Below	11.95 (C) 53.51 (F)
Semispan	131.00	NA Above	45.68 (C) 114.23 (F)

Dist (ft) LTP to OCS ORIGIN	3324.90
OCS Slope (run:rise)	19.15:1
VEB ROC @ PFAF	216.86

Error Components	(Enter Bank Angle, WPR, FTE, and ATIS values below)	@ 250 ft	@ PFAF
ISAD	$(dh \times dISA)/288 + dISA - 0.5 \times .00198 \times (dh+h)$	0.00	0.00
BG	25.00 semispan $\times \sin$ (Bank Angle)	25.00	25.00
ANPE	$1.225 \times rnp \times \tan(a)$	117.03	117.03
VAE	$D \times (\tan(a) - \tan(a - .01))$ D=250/tan(a)	0.83	5.50
WPR	60.00 WPR $\times \tan(a)$	3.14	3.14
FTE	75.00	75.00	75.00
ASE	$-8.8 \times 10^{-8} \times (h + D \times \tan(a))^2 + 6.5 \times 10^{-3} \times (h + D \times \tan(a)) + 50$	61.26	69.73
ATIS	20.00	20.00	20.00

Table 7: Approach 2 vertical error budget (VEB)

- (4) Approach 3 is shown in **Figure 7**. This procedure uses an RF leg early in the procedure followed by a brief straight segment, then two back-to-back RF legs with a turn direction reversal. The second RF leg terminates at the final approach fix. As on the other approaches, the aircraft will be required to descend, decelerate, and configure for landing during the series of RF legs. The missed approach also includes an RF leg to the missed approach hold. Waypoint information is shown in **Table 8** and vertical error budget information is included in **Table 9**.

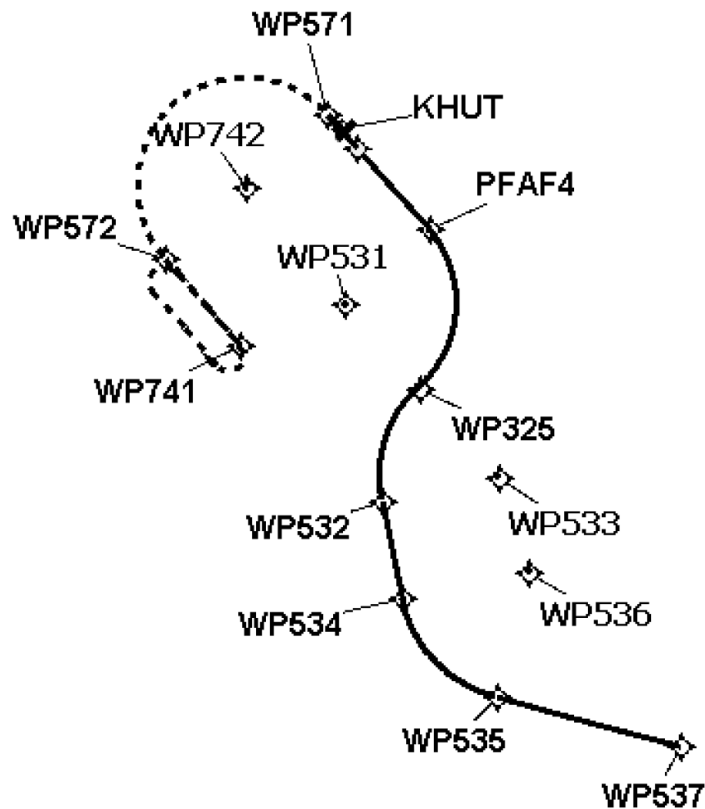

Figure 7: Approach 3

Leg Table 1

Segment	Leg Type	Start	End	Turn Type	Glide Path End Alt	Min Obs./ ATC End Alt	Max End Alt	Turn Radius Comp Alt	Descent Grad	Climb Grad	End Spd	Turn Radius Comp Spd	RNP	Turn Dir
Intermediate	IF	WP537	WP537	FB	10584			10583.57	0.0			300.0	1.0	
Intermediate	TF	WP537	WP535	FB	8641			8641.47				250.0	1.0	RIGHT
Intermediate	RF	WP535	WP534	FB	7193			8641.47				250.0	1.0	RIGHT
Intermediate	TF	WP534	WP532	FB	6193			6192.56				250.0	1.0	RIGHT
Intermediate	RF	WP532	WP325	FB	4937			6192.56				250.0	1.0	RIGHT
Intermediate	RF	WP325	PFAF4	FB	3162			4936.79				250.0	1.0	LEFT
Final	TF	PFAF4	KHUT:RW31:AER	FB	1570			1570.00				165.0	0.3	
Missed	TF	DA 1765	WP571	FB				2615.00				265.0	0.5	LEFT
Missed	RF	WP571	WP572	FB				8536.36				265.0	1.0	LEFT
Missed	TF	WP572	WP741	FB				10854.65				265.0	1.0	LEFT
Missed	HM	WP741	WP741	FB				13172.95				265.0	1.0	RIGHT

Leg Table 2

Segment	Leg Type	Start	End	Turn Type	Leg Length (NM)	Leg Length (FT)	Start Course Magnetic	End Course Magnetic	Course Change	RF/Flyby Leg Radius	RF/Flyby Turn Bank Angle	Tailwind	RF Leg Arc Center
Intermediate	IF	WP537	WP537	FB	0.00	0.00000							
Intermediate	TF	WP537	WP535	FB	7.77	47201.70006	278.82	278.72					
Intermediate	RF	WP535	WP534	FB	5.80	35214.94480	278.72	342.26	63.54	5.2220	19.55	64.11	WP538
Intermediate	TF	WP534	WP532	FB	4.00	24304.46194	342.26	342.25					
Intermediate	RF	WP532	WP325	FB	5.02	30520.94148	342.25	42.26	60.00	4.7980	19.44	59.26	WP533
Intermediate	RF	WP325	PFAF4	FB	7.10	43126.52487	42.26	312.31	89.95	4.5209	19.67	56.77	WP531
Final	TF	PFAF4	KHUT:RW31:AER	FB	5.00	30380.57743	312.31	312.27	0.00		n/a	30.00	
Missed	TF	DA 1765	WP571	FB	1.80	10937.00787	312.31	312.29					
Missed	RF	WP571	WP572	FB	13.64	82894.71614	312.29	133.02	179.27	4.3623	24.99	63.90	WP742
Missed	TF	WP572	WP741	FB	4.64	28172.46233	133.02	133.06					
Missed	HM	WP741	WP741	FB	4.64	28172.46233	133.02						

Waypoint Data

DB	Waypoint	Latitude (Deg)	Longitude (Deg)	Latitude (Deg, Decimal Min)	Longitude (Deg, Decimal Min)	Latitude (D° M' S.ss")	Longitude (D° M' S.ss")
	PFAF4 WP	N 37.9975785	W 97.7847137	N37 59.855	W97 47.083	N37 59 51.28	W097 47 04.97
	WP325 WP	N 37.8911180	W 97.7924249	N37 53.467	W97 47.545	N37 53 28.02	W097 47 32.73
	WP531 WP	N 37.9473859	W 97.8559480	N37 56.843	W97 51.351	N37 56 50.59	W097 51 21.05
	WP532 WP	N 37.8151083	W 97.8240457	N37 48.906	W97 49.443	N37 48 54.39	W097 49 26.56
	WP533 WP	N 37.8313647	W 97.7252214	N37 49.882	W97 43.513	N37 49 52.91	W097 43 30.80
	WP534 WP	N 37.7497614	W 97.8069336	N37 44.986	W97 48.416	N37 44 59.14	W097 48 24.96
	WP535 WP	N 37.6831652	W 97.7273813	N37 40.990	W97 43.642	N37 40 59.39	W097 43 38.50
	WP536 WP	N 37.7674351	W 97.6994648	N37 46.046	W97 41.968	N37 46 02.77	W097 41 58.07
	WP537 WP	N 37.6501154	W 97.5686846	N37 39.007	W97 34.181	N37 39 00.42	W097 34 10.86
	WP571 WP	N 38.0748650	W 97.8715595	N38 4.479	W97 52.294	N38 04 28.76	W097 52 17.61
	WP572 WP	N 37.9784995	W 98.0097230	N37 58.740	W98 0.583	N37 58 42.60	W098 00 35.00
	WP741 WP	N 37.9200757	W 97.9458813	N37 55.205	W97 56.741	N37 55 12.27	W097 56 44.45
	WP742 WP	N 38.0262098	W 97.9402549	N38 1.573	W97 56.415	N38 01 34.36	W097 56 24.92

PFAF

	LAT	LON
LTP/FTP	N38 03 35.48	W097 51 17.61
Runway True Bearing	318.00	
FAF Altitude	3162.36	
LTP/FTP Elevation	1515.00	
TCH	55.00	
Glidepath Angle	3.00	
GPI	1049.46	
FAF Distance From LTP/FTP	30380.58 Feet	
	5.00 NM	
PFAF	N37 59 51.28	W097 47 04.97

Table 8: Approach 3 waypoints

RNP Value	0.30	Max Glidepath Angle	3.50
LTP MSL Elevation	1515.00	PFAP Elevation	3162.36
Distance (ft) LTP to PFAP	30380.58	LTP Elevation	1515.0
MSL PFAP Altitude	3162.36	ACT	0.00
Glidepath Angle	3.00	Min Glidepath Angle	3.10
TCH	55.00	NA Below	11.97 (C) 53.55 (F)
Delta ISA (dISA)	0.00	NA Above	45.70 (C) 114.27 (F)
Semispan	131.00		

Dist (ft) LTP to OCS ORIGIN	3324.27
OCS Slope (run:rise)	19.15:1
VEB ROC @ PFAP	216.83

Error Components	(Enter Bank Angle, WPR, FTE, and ATIS values below)	@ 250 ft	@ PFAP
ISAD	$(dh \times dISA)/288 + dISA - 0.5 \times .00198 \times [dh+h]$	0.00	0.00
BG	25.00 semispan $\times \sin$ (Bank Angle)	25.00	25.00
ANPE	$1.225 \times rnp \times \tan(a)$	117.03	117.03
VAE	$D \times (\tan(a) - \tan(a - .01))$ D=250/tan(a)	0.83	5.50
WPR	60.00 WPR $\times \tan(a)$	3.14	3.14
FTE	75.00	75.00	75.00
ASE	$-8.8 \times 10^{-8} \times (h + D \times \tan(a))^2 + 6.5 \times 10^{-3} \times (h + D \times \tan(a)) + 50$	61.20	69.68
ATIS	20.00	20.00	20.00

Table 9: Approach 3 vertical error budget (VEB)

AppD-3 — Test guide

- (1) **AppD-3** provides guidance that may be used to conduct development and/or airworthiness RF leg testing for new equipment hardware/software, or updates to existing equipment hardware/software. The guidance is designed to be used together with the templates described in **AppD-2** to create ‘FOR TEST ONLY’ terminal area instrument procedures (departures, arrivals, and approaches). The intent of this regimen is to provide a set of rigorous instrument procedures that the applicant can use to demonstrate that the RF leg airworthiness approval criteria are met.
- (2) The test instrument procedures are designed and located at an aerodrome with an elevation of approximately 1 500-ft MSL. The waypoint and navigation leg data is provided so that the procedures can be ‘translated’ to another location suitable to the applicant. However, the new aerodrome elevation should be within the range of 1 000–2 000-ft MSL to ensure that the designed turn radii and bank angles do not change significantly (see **AppD-1**). The applicant will be required to obtain a navigation database for their respective navigation system that contains the test procedures.
- (3) The information in the following paragraphs describes test conditions such as generic aircraft performance parameters, desired atmospheric conditions, and considerations to assist the applicant with creating a detailed test plan. Applicants are encouraged to use these recommended guidelines. However, amendments may be made as required to accommodate unique equipment designs, test environment, testing methods, or other considerations.

AppD-3.1 — Initial set-up

- (1) Configure the aircraft for individual trials using two gross weight conditions:
 - (a) nominal heavy weight resulting in lower accelerations to climb speed and higher speeds on approach;
 - (b) nominal light weight resulting in higher accelerations to climb speed and lower speeds on approach.

- (2) The test should be performed in representative operational conditions in terms of speeds, flap, and gear settings, etc.
- (3) Verify that a navigation database with the 'FOR TEST ONLY' terminal procedures is loaded in the RNP system.
- (4) Verify that desired data parameters will be recorded (if data recording capability is available).

Note: In addition to the desired data parameters, the lateral path definition (desired path) and lateral path 'cross-track error' (distance from the path's centre line) should be included in the recorded data parameters to monitor/review path maintenance performance.

- (5) Configure the simulation, if practical, for trials using two atmospheric conditions:
 - (a) standard day, with standard lapse rate;
 - (b) 35 °C outside air temperature, with standard lapse rate.
- (6) If practical, simulated wind direction should be set to a tailwind for each turn entry. Below 2 000-ft AGL, the wind velocity should be fixed at 30 kt. At 2 000-ft AGL and above, the wind velocity in knots (V_{KTW}) should be calculated as a function of the altitude in feet (A) in accordance with the formula:

$$V_{KTW} = 0.00198 \times A + 47$$

If impractical (i.e. when the simulator cannot model variable winds and various levels), select the wind direction and velocity that most effectively simulates the worst-case tailwind for the procedure.

AppD-3.2 — Airborne test conditions

- (1) Record aircraft configuration:
 - (a) verify that the simulation is 'conformed' with correct avionics hardware and software;
 - (b) record aircraft performance parameters (gross weight, etc.);
 - (c) record aircraft configuration and changes to the configuration (flap, gear, and thrust setting, etc.).
- (2) Select the procedure to be tested, load the procedure into the route of flight, and verify the procedure is in the active route.
- (3) Ensure the correct RNP values correspond to the appropriate value for the respective route/procedure segment.
- (4) Engage lateral and vertical path guidance where applicable.
- (5) Engage autopilot/flight director (as soon as practical after take-off) and verify the autopilot/flight director is providing guidance to the lateral path.
- (6) Fly the programmed route and observe that the lateral cross-track deviation does not exceed the FTE for the respective RNP level as follows:

RNP	FTE
1.0	0.5 NM
0.3	0.25 NM with flight director / 0.125 NM with autopilot
< 0.3	Agreed allowable FTE value to achieve $TSE \leq 1 \times RNP$ value

Table 10: FTE value versus RNP value

- (7) Perform steps (1) through (6) for each appropriate aircraft gross weight configuration and for each test procedure.

Subpart D — Surveillance (SUR)

Section 1 — Mode A/C only Surveillance

AMC1 ACNS.D.AC.010 Transponder characteristics

(a) Transponder capabilities.

- (1) To be approved, the Mode A/C only transponder should hold an EASA equipment authorisation in accordance with European Technical Standard Order ETSO-C74d, or an equivalent standard that is consistent with ICAO Annex 10 Volume IV, and which is acceptable to EASA.

- (2) The Mode A/C only transponder should be a class 2A / class 2B as defined in ETSO-C74d.

Note 1: ETSO-C74d Class 2 equipment meets EUROCAE Document 1/WG9 /71 June 1972 with amendment 1 and 2. Amendment 2 contains the requirements and tests to show that the transponder correctly replies to Mode A/C-only all call interrogations and to Mode A/C/S all-call interrogations used by Mode S radars.

Note 2: RTCA DO-144 does not include requirement to reply to Mode A/C/S All-Call and Mode A/C-Only All-Call interrogations and is, therefore, not sufficient to prove the compliance. RTCA DO-144A contains the requirements for the equipment to reply to Mode A/C/S All-Call and Mode A/C-Only All-Call interrogations.

(b) Minimum reply rate

- (1) Mode A/C only transponders should be capable of continuously generating at least 500 replies per second for a 15-pulse coded reply.
- (2) Transponder installations used solely below 4 500 m (15 000 ft), or below a lesser altitude established by the appropriate authority or by regional air navigation agreement, and in aircraft with a maximum cruising true airspeed not exceeding 90 m/s (175 knots) should be capable of generating at least 1 000 15-pulse coded replies per second for a duration of 0,1 s.

Note: The rate of 1 000 replies per second for a limited duration of 100ms is an acceptable deviation to ETSO-C74d.

- (3) Transponder installations operated above 4 500 m (15 000 ft) or in aircraft with a maximum cruising true airspeed in excess of 90 m/s (175 knots) should be capable of generating at least 1 200 15-pulse coded replies per second for a duration of 0,1 s.

Note 1: A 15-pulse reply includes 2 framing pulses, 12 information pulses, and the SPI pulse.

Note 2: The transponder should be capable of replying to this short-term burst rate, even though the transponder may not be capable of sustaining this rate.

Note 3: The rate of 1 200 replies per second for a limited duration of 0,1 s is an acceptable deviation to ETSO-C74d.

(c) Minimum output power level

The transponder power output capability should be verified as follows depending on the aircraft capability:

- (1) For aircraft that operate at altitudes exceeding 4 570 m (15 000 ft) or with maximum cruising speed exceeding 90 m/s (175 knots), the class of the transponder declared in the transponder DDP should be Class A.
- (2) For aircraft operating at or below 4 570m (15 000 ft) with a maximum cruising airspeed of 90 m/s (175 knots) or less, the class of the transponder declared in the transponder DDP should be Class A or Class B.

AMC1 ACNS.D.AC.015 Data transmission

(a) Mode A Code verifications.

- (1) Set the Mode A code to 7776 (or other Mode A code agreed with the local Air Traffic Control Unit) through the dedicated flight crew interface. Confirm receipt of correct code by using ground test equipment.
- (2) For dual transponder installation with a common control panel, set the Mode A code to 7776 (or other Mode A code agreed with the local Air Traffic Control Unit) and verify that the correct code is received by the ground test equipment. Switch to transponder 2 and verify that the correct Mode A code is received by the ground test equipment.

Note: Agreement of Mode A code values is to be agreed with the local ATC if the transponder is in the visibility of an ATC cooperative surveillance system.

(b) Pressure Altitude verifications

- (1) Verify that all Mode A/C transponders report the pressure-altitude encoded in the information pulses in Mode C replies.

Note: more details on the encoding of the altitude can be found in ICAO Annex 10, Vol IV, para 3.1.2.6.5.4.

- (2) Select the altitude switch to the ON position and verify that the transponder provides the current aircraft altitude in response to Mode C interrogations.
- (3) A sufficient number of test points should be checked to ensure that the altitude reporting equipment and transponder perform their intended function through their entire range while ascending or descending. Where a Gillham altitude encoder is used, tests of each altitude code segment of the encoder (2300, 2500, 3800, 4300, 4800, 6800, 14800 30800, 70800, 90800, 110800 and 126700 if available) should be sufficient to ensure proper operation of each altitude code segment of the encoder.

AMC1 ACNS.D.AC.020 Altitude source

- (a) Altimeters compliant with JAA TGL No 6 are an approved and acceptable means of compliance for the altitude source.
- (b) Altimeters with a pressure altitude resolution lower than or equal to 7,62 m (25 ft) is an approved and acceptable means of compliance.

Note: Altitude source resolution of 7,62 m (25 ft) or better is required for aeroplanes intended to be used for international air transport as defined in ICAO Annex 6 Part 1 — 6.19.

- (c) An altimeter with a pressure altitude resolution lower than or equal to 30 m (100 ft) and greater than 7.62 m (25 ft) is an approved and acceptable means of compliance for aircraft provided that the flight deck interface provides a means to inhibit the transmission of pressure altitude information for aircraft equipped with Gillham encoded altitude

Note: It is not recommended to install altimeters with a Gillham altitude encoder interface.

- (d) Manual or automatic selection of the altitude source are acceptable means of compliance

AMC1 ACNS.D.AC.025 Flight deck interface

Modes of operation should be identified. Attention should be closely paid to line select keys, touch screens or cursor controlled trackballs as these can be susceptible to unintended mode selection resulting from their location in the flight deck.

Note: Systems not utilising Gillham interfaces may or may not provide a means to inhibit the transmission of pressure altitude.

AMC1 ACNS.D.AC.040 Dual/multiple transponder installation

When dual or multiple transponders are installed on an aircraft, it is highly recommended to use a common control interface/panel to ensure that only one transponder is active at a given time.

AMC1 ACNS.D.AC.045 Antenna Installation

- (a) Antenna locations recommended by the aircraft manufacturer do not need to be revalidated.
- (b) Antenna performance for new locations may be validated in flight, by ground measurements or simulation modelling.

Section 2 — Mode S Elementary Surveillance

AMC1 ACNS.D.ELS.001 Applicability

Provided that the differences listed in Appendix D have also been addressed, then previous compliance declarations with JAA TGL 13 Revision1 (Certification of Mode S Transponder Systems for Elementary Surveillance) supplemented with the additional assessments is another Acceptable Means of Compliance.

Note 1: A list of Mode S ELS related documents is provided in Book 2 Subpart D APPENDIX B section (b).

Note 2: More information on how the ELS information will be extracted and used by ground surveillance is available in Book 2 Subpart D APPENDIX B section (c).

Note 3: In accordance with EU Regulation No 1207/2011, aircraft operating flights as general air traffic in accordance with instrument flight rules in the airspace within the ICAO EUR and AFI regions where EU Member States are responsible for the provision of air traffic services are to be compliant with CS ACNS Book 1 Subpart D section 2.

AMC1 ACNS.D.ELS.010 Transponder characteristics

(a) Transponder capabilities.

- (1) To be approved, the Mode S transponder should hold an EASA equipment authorisation in accordance with European Technical Standard Order ETSO-C112d, or an equivalent standard that is consistent with ICAO Annex 10 Volume IV and which is acceptable to the responsible certification authority

Note: ETSO-C112d requires compliance with EUROCAE ED-73E.

- (2) The transponder class can be verified by checking that the transponder DDP declares the transponder level as '2', '3', '4', or '5'.

Note: The definition of a level 2 transponder and associated functions can be found in EUROCAE ED-73E paragraph 1.4.2.1, 3.22 and 3.23.

- (3) The SI code capability can be verified by checking that the transponder DDP indicates the letter 's' in the transponder capability declaration.

Note 1: The DDP indicates those requirements of ED-73E (or later version) with which the transponder is not compliant with.

Note 2: The transponder SI code capability can be found in EUROCAE ED-73E paragraph 3.18.4.34. SI codes have been allocated to Mode S radars used in Europe and it is, therefore, an important capability to ensure correct detection of the aircraft.

- (4) The Elementary Surveillance functionality can be verified by checking that the transponder DDP indicates the letter 'l' for ELS or 'n' for EHS in the transponder capability declaration.

Note: Such transponders meet the requirements specified in EUROCAE ED-73E 3.29. According to ED-73E, a transponder with the Enhanced Surveillance capability has also the Elementary Surveillance capability.

- (5) ACAS compatibility can be verified by checking that the transponder DDP indicates the letter ‘a’ in the transponder capability declaration.

Note: Necessary capabilities to be an ACAS-compatible Mode S transponder are described in section 3.27 of EUROCAE ED-73E.

- (b) Minimum output power level: The transponder power output capability should be verified as follows, depending on the aircraft capability:

- (1) For aircraft that operate at altitudes exceeding 4 570m (15 000ft) or with maximum cruising speed exceeding 90 m/s (175 knots), the class of the transponder declared in the transponder DDP should be **Class 1**.
- (2) For aircraft operating at or below 4570m (15 000ft) with a maximum cruising airspeed of 90 m/s (175 knots) or less, the class of the transponder declared in the transponder DDP should be **Class 1** or **Class 2**.

Note: Classes of equipment are defined in EUROCAE ED-73E 1.4.2.4. Power characteristic is defined in ICAO Annex 10 Volume IV 3.1.1.7.11.

AMC1 ACNS.D.ELS.015 Data transmission

Data transmission verifications

- (a) Table 1 below provides the parameters that should be verified for Mode S Elementary Surveillance.

Table 1 — List of parameters to be verified on an ELS installation

Item	Parameters	Message/register	Remark
1	Mode A code and Emergency status	DF5 and DF21	Note 3
2	Pressure altitude	DF4 and DF20	See (b) and (c)
3	On-the-ground status	CA field in DF11 or FS field in DF4/5/20/21	
4	Aircraft Identification	Register 20 ₁₆	See (d)
5	SPI	DF4/5/20/21	See (e)
6a	Capability report	CA field in DF11	
6b	Data-link capability report and common usage GICB capability report	Register 10 ₁₆ Register 17 ₁₆	(g)
7	ICAO 24 bit aircraft address	DF11	
8	RA report	Register 30 ₁₆ + announcement in DF4/5/20/21	Only for ACAS installation see (f)

Note 1: Information about how Mode S ELS data are used by Mode S ground system can be found in Book 2 APPENDIX B to this CS.

Note 2: Downlink Formats (DF) are defined in ICAO Annex 10 Volume IV and EUROCAE ED-73E. A summary can also be found in Book 2 APPENDIX B.

Note 3: It is not recommended to have 2 transponders installed without a common control panel.

(b) Pressure Altitude

- (1) The consistency of the altitude reported in Mode C replies and Mode S replies should be checked.

Note: An incorrect installation of altimeters using Gillham encoding may result in altitude transmitted in Mode C replies and no altitude transmitted in Mode S replies.

- (2) For aircraft transmitting parameters via the Extended Squitter, for which compliance with Subpart D section 4 is not required, the pressure altitude data should be checked in the Extended Squitter register for airborne position (register 05₁₆).

(c) Pressure altitude resolution transmission

- (1) The resolution of the transmitted pressure altitude should be 7.62 m (25 ft) for aircraft equipped with a pressure altitude source having a resolution better than 7.62 m (25 ft) for all altitudes except those above 15 298 m (50 187.5 ft).
- (2) Aircraft equipped with altimeters that have a resolution greater than 7.62 m (25 ft) (e.g. 30.48 m (100 ft)) should report their altitude in 30.48 m (100 ft) encoding.
- (3) Verify that the encoding of the altitude is appropriate to the altimeter resolution as defined in paragraphs 1 and 2 above.
- (4) For aircraft transmitting parameters via the Extended Squitter, for which compliance with Subpart D section 4 is not required, the pressure altitude resolution data should be checked in the Extended Squitter register for airborne position (register 05₁₆).

(d) Aircraft Identification

- (1) For aircraft transmitting parameters via the Extended Squitter, for which compliance with Subpart D section 4 is not required, the Aircraft Identification received via the Extended Squitter should be checked to ensure that it is identical to the information transmitted in register 20₁₆.

(e) Special Position Indication (SPI)

The FS field should report FS = 4 or 5 for 18 seconds (+/-1 second) in replies DF4, DF5, DF20 or DF21 after the SPI (IDENT) has been manually activated.

Note: Flight Status values can be found in ICAO Annex 10, Vol IV, paragraph 3.1.2.6.5.1.

(f) ACAS active Resolution Advisory report

For aircraft that have ACAS II installed, no undue RA report should be announced (DR field never set to 2, 3, 6 or 7) within (5 minutes).

- (g) Common usage GICB capability report: BDS 17₁₆ = 0 is an acceptable means of compliance for transponders that are strictly ELS (not transmitting other parameters).

(h) Transmission of other parameters

When one or more other airborne data items are transmitted, they should be verified as proposed in AMC1 ACNS.D.EHS..

Note 1: The minimum data transmission verification of transponder also having ADS-B ES capabilities has been defined above. Transponders that are transmitting parameters other than the minimum tested above, are encouraged to demonstrate compliance with Subpart D section 4.

Note 2: The implementation of registers E3₁₆, E4₁₆, E5₁₆ and E6₁₆ is recommended.

AMC1 ACNS.D.ELS.020 On-the-ground status determination

The automatic determination of the on-the-ground status should be obtained from:

- (a) Weight On Wheel (WOW) sensor: When the aircraft is equipped with an automatic sensor to determine if the aircraft is on the ground (i.e. Weight On Wheel sensor), this sensor should be used as the on-the-ground status source of the transponder. For Aircraft with transponders that have access to at least one of the following parameters (ground speed, radio altitude, airspeed) the following validation check should be performed when detected 'on the ground' and the air/ground status should be overridden and changed to 'airborne' if [Ground speed > 50 m/s (100 knots) OR airspeed > 50 m/s (100 knots) OR radio altitude > 15 m (50 feet)].

Note: Care should be taken to ensure the wiring of the WOW to the correct transponder pins.

- (b) automatic algorithm : If ground speed, radio altitude, or airspeed parameters are being used in the algorithm and the 'on-the-ground' condition is being reported or if the on-the-ground status has been commanded via the TCS subfield, the on-the-ground status is to be overridden and changed to 'airborne' if :

Ground Speed OR Airspeed > X or Radio height > 15 m (50 ft).

Note 1: Care should be taken to ensure that the chosen threshold values of X are such that the aircraft can never report 'on ground' status when in the air, and should be based on the aircraft nominal performance.

Note 2: Systems that support Enhanced Surveillance and ADS-B might use available airborne parameters in their automatic algorithm to determine if they are on the ground. More information can be found in Subpart D section 4.

AMC1 ACNS.D.ELS.025 Altitude source

- (a) Altimeters compliant with JAA TGL No 6 are an approved and Acceptable Means of Compliance for the altitude source.
- (b) Altimeters with a pressure altitude resolution lower than or equal to 7.62 m (25 ft) are an approved and Acceptable Means of Compliance.

Note: Altitude source resolution lower than or equal to 7.62 m (25 ft) is required for aeroplanes intended to be used for international air transport as defined in ICAO Annex 6 Part 1 — 6.19.

- (c) An altimeter with a pressure altitude resolution lower than or equal to 30 m (100 ft) and greater than 7.62 m (25 ft) is an approved and Acceptable Means of Compliance for aircraft provided that the following provisions are implemented:

- (1) There is no conversion of Gillham encoded data to another format before inputting to the transponder unless failure detection can be provided, and the resolution (quantisation) is set in the transmitted data to indicate 30 m (100 ft);

Note 1: It is not recommended to install altimeters with a Gillham altitude encoder interface as it supports a resolution of only 30 m (100 ft).

Note 2: Losses or errors of pressure altitude have an impact on the provision of separation by ATC. It is, therefore, important to design the altitude pressure source to minimise the loss of this data or the provision of erroneous data.

Note 3: Further guidance on altitude measurement and coding systems may be found in EUROCAE document ED-26.

- (2) Altitude source comparison;

For aircraft equipped with ACAS II where the available source of pressure altitude information is only in Gillham encoded format, detection of an altitude source or encoder failure can be satisfied by means of dual independent altitude corrected sensors together with an altitude data comparator (which may be incorporated and enabled in the transponder). Similar provision is also acceptable for alternative altitude information sources that do not signal erroneous data.

The flight deck interface should provide a means to inhibit the transmission of pressure altitude information for aircraft equipped with a Gillham encoded altitude interface.

- (d) Manual or automatic selection of the altitude source are acceptable means of compliance.

AMC1 ACNS.D.ELS.030 Flight deck interface

Modes of operation should be identified. Attention should be closely paid to line select keys, touch screens or cursor controlled trackballs as these can be susceptible to unintended mode selection resulting from their location in the flight deck.

AMC1 ACNS.D.ELS.050 Dual/multiple transponder installation

When dual or multiple transponders are installed on an aircraft, a common control interface/panel should be provided to ensure that only one transponder is active at a given time, and to ensure that the Mode A code and Aircraft Identification changes are applied to the active transponder.

AMC1 ACNS.D.ELS.060 Antenna Installation

- (a) Antenna locations recommended by the aircraft manufacturer do not need to be revalidated.
- (b) Antenna performance for new locations should be validated in flight by ground measurements or simulation modelling.
- (c) The distance between ATC Transponder antenna should be at least 40 cm and the distance between ATC Transponder antenna and other antenna (e.g. ACAS, DME) should satisfy the appropriate isolation and longitudinal separation limits.
- (d) When the Mode S ELS surveillance installation is using two antennas, the horizontal distance between the two antennas should be less than 7.6m

AMC1 ACNS.D.ELS.065 Antenna Diversity

- (a) The aircraft maximum cruising true airspeed may be determined using one of the 3 following options:
 - (1) Where the Aircraft Flight Manual or Pilot's Operating Handbook gives more than one table of true airspeed values for a range of temperatures, the table which gives the maximum true airspeed, should be used;
 - (2) For some aircraft, the maximum cruising true airspeed is not obtained at the maximum operating altitude. In those cases, the maximum true airspeed has to be considered and not the true airspeed at maximum operating altitude;
 - (3) Aircraft which do not state the maximum cruising true airspeed under ISA conditions in their Aircraft Flight Manual or Pilot's Operating Handbook, may use the following alternative method to calculate maximum cruising true airspeed:
 - (i) Use the maximum operating values of altitude and airspeed (i.e. VNO, or VMO/MMO as applicable) quoted in the Limitations section of the Aircraft Flight Manual or Pilot's Operating Handbook to calculate the maximum cruising true airspeed of the aircraft. If the aircraft is unpressurised, an altitude of 8 000 feet may be used as the maximum 'normal' operating altitude.
 - (ii) For example, using a maximum 'normal' operating altitude of 2 400 m (8 000 feet) for an unpressurised aircraft, and a maximum operating airspeed of 110 m/s (215 knots), (as stated in the Aircraft Flight Manual or Pilot's Operating Handbook, e.g. VNO = 110 m/s (215 knots)) then the aircraft has an equivalent TAS capability of 128 m/s (250 knots) in the ICAO Standard atmosphere. The calculation may be made using a pilot's TAS computer.
- (b) For airships, the applicant should demonstrate the need or otherwise for antenna diversity. The demonstration should be based on the construction techniques and size of the airship.
- (c) The transponder DDP should indicate the letter 'd' in the transponder capability declaration to indicate antenna diversity capability.

Section 3 — Mode S Enhanced Surveillance

AMC1 ACNS.D.EHS.001 Applicability

Provided that the differences listed in Appendix E have also been addressed, then previous compliance declarations with EASA AMC 20-13 (Certification of Mode S Transponder Systems for Enhanced Surveillance) supplemented with the additional assessments is another Acceptable Means of Compliance.

Note: In accordance with EU Regulation No 1207/2011, fixed wing aircraft having a maximum take off mass greater than 5 700 kg or a maximum cruising true airspeed greater than 128.6 m/s (250 knots) and operating flights as general air traffic in accordance with instrument flight rules in the airspace within the ICAO EUR and AFI regions where EU Member States are responsible for the provision of air traffic services are to be compliant with CS ACNS Book 1 Subpart D section 3.

AMC1 ACNS.D.EHS.010 Transponder characteristics

- (a) The means of compliance defined in AMC1 ACNS.D.ELS.010 should be followed, with the exception that the transponder DDP should indicate a label 'n' in the transponder capability declaration to reflect ELS and EHS capabilities.

Note: Such transponders meet the requirements specified in EUROCAE ED-73E section 3.30 for EHS capabilities. If the transponder is compliant with EUROCAE ED-73E, it provides register format corresponding to a Mode S sub-network version 5.

- (b) The Mode S sub-network format should be 3 or above.

Note : The use of the highest Mode S sub-network version format is recommended.

AMC1 ACNS.D.EHS.015 Data transmission

- (a) The compliance verification should include a list of transponder registers supported by the installation, including the parameters that are available in each register. The list should contain the registers that are indicated as available in the Mode Specific Capability reports (18₁₆ to 1C₁₆), except the following registers:

- (1) registers managed by the transponder to support the Mode S airborne initiated protocol (02₁₆, 03₁₆, 04₁₆);
- (2) registers containing extended squitters information (05₁₆, 06₁₆, 07₁₆, 08₁₆, 09₁₆, 0A₁₆);
- (3) aircraft capability reporting (10₁₆ to 1F₁₆);
- (4) Aircraft Identification (20₁₆);
- (5) ACAS RA report (30₁₆); and
- (6) transponder dependant information (5F₁₆, E3₁₆, E4₁₆, E7₁₆, EA₁₆).

Note 1: An example of a minimum list of registers to support EHS is provided in Subpart D APPENDIX C.

Note 2: An example of other registers and parameters is provided in Subpart D APPENDIX C.

- (b) Verification of operation

- (1) All the transponder registers containing data as defined in (a). should be verified to ensure correct data is transmitted by the Mode S transponder.

Note: Format and resolution of airborne parameters can be found in ED-73E Volume 2 or in ICAO Doc 9871 Edition 2.

- (2) Where a register is declared available but a parameter within that register is not available, it is necessary to verify that the status of the parameter is declared invalid in the corresponding aircraft register.

Note 1: Some parameters are particularly difficult to measure statically. To ensure that these parameters (e.g. Roll Angle, Track Angle Rate, Inertial Vertical Velocity) are correctly received from the sensor and transmitted by the transponder, it is acceptable to test that the correct transponder register is transmitted (by the transponder), that the value of the parameter status bit is valid (status bit = 1), and the value of the parameter field is set to zero when aircraft is not moving on the ground. Alternatively, for such parameters which remain invalid in static condition, ground test may use simulation if simulated data bus signal meets sensor data bus specifications, the same data bus provides at least one other valid parameter which is tested and sensor specifications clearly establish availability conditions and format of the simulated data parameter.

Note 2: Due to the limitations of the static tests, a recommended option is to perform a flight and record the content of the different transponder registers (as extracted by a Mode S ground station) to verify that all parameters listed in (a) are changing in accordance with pilot input and aircraft attitude and manoeuvre.

Note 3: To minimise the certification effort for transponder follow-on installations, the applicant may claim from the responsible authority credit for applicable certification and test data obtained from equivalent aircraft installations. This is acceptable for a parameter only if all related equipment connected to the transponders are of the same type and same software revision number.

(c) Aircraft parameters

(1) Selected Altitude

(i) MCP/FCU Selected Altitude

Selected level input to the MCP or FCU should be used.

In case there is no MCP/FCU Selected Altitude function, it is accepted to use the information provided by an altitude alerter.

(ii) FMS Selected Altitude

When available, it is recommended that the FMS Selected altitude field is provided.

Note: This will allow the reporting of the intermediate selected altitudes during applications (e.g. Continuous Descent Operations) when the FMS provides the guidance input to the auto-pilot.

(iii) MCP/FCU mode bits

When data is available, it is recommended (optional) to provide information on autopilot mode which is selected by the flight crew.

Note: It is accepted to set this bit to zero rather than providing wrong information.

(iv) Target Altitude source bits

The target altitude source bits are used to indicate the source (e.g. FCU/MCP, FMS) which provides the next level at which the aircraft will level off. This is also referred to as the Target Altitude. However, the necessary data may be inconsistent or not accessible. In this case, the status of target altitude source bits should indicate no source information provided (set to zero).

Note: It is also acceptable that status of target altitude source bits is set to valid and target altitude source is set to 00 to indicate unknown.

(2) Vertical Rate

The Barometric Altitude Rate should contain value solely derived from barometric measurement.

When different sources are available, the Inertial Vertical Velocity should contain data coming from the most accurate and steady source.

Note 1: The vertical rate can be provided in the Barometric Altitude Rate and/or the Inertial Vertical Velocity fields of register 60₁₆. Both the Barometric Altitude Rate and the Inertial Vertical Velocity can be transmitted simultaneously.

Note 2: The Barometric Altitude Rate is usually very unsteady.

Note 3: The Inertial Vertical Velocity (derived from IRS, AHRS and/or GPS) information is more filtered and smoothed.

(3) Barometric Pressure Setting

If operating with reference to the standard pressure setting, the Barometric Pressure Setting field should indicate standard pressure value equivalent to 1.01325×10^5 Pa.

(4) Track Angle Rate or True Airspeed

If Track Angle Rate data cannot be readily provided due to the aircraft configuration, True Airspeed data should be substituted.

(5) Roll Angle

It is difficult to test different values of Roll Angle when the aircraft is on the ground. To ensure that this parameter is correctly received from the sensor and transmitted by the transponder, it is acceptable to test that the Roll Angle field in register 50₁₆ contains a credible value, consistent with aircraft roll angle on the ground, and the Roll Angle Status bit indicates valid data.

(6) True Track Angle

It is difficult to test different values of True Track Angle when the aircraft is on the ground. To ensure that this parameter is correctly received from the sensor and transmitted by the transponder, it is acceptable to test that the True Track Angle field in register 50₁₆ contains a value and the True Track Angle Status bit indicates valid data.

(7) Ground Speed

It is difficult to test different values of Ground Speed when the aircraft is on the ground. To ensure that this parameter is correctly received from the sensor and transmitted by the transponder, it is acceptable to test that the Ground Speed field in register 50₁₆ contains a

value, consistent with the speed of the aircraft on the ground (close to zero if the aircraft is not moving) and the Ground Speed Status bit indicates valid data.

(8) Magnetic Heading

To ensure that this parameter is correctly received from the sensor and transmitted by the transponder, it is acceptable to test that the Magnetic Heading field in register 60₁₆ contains a value, consistent with the magnetic heading of the aircraft, and the Magnetic Heading Status bit indicates valid data.

(9) Indicated Airspeed or Mach No

Indicated Airspeed and Mach No are considered as a single parameter. Both should be provided where available.

To ensure that these parameters are correctly received from the sensor and transmitted by the transponder, it is acceptable to test that the Indicated Airspeed or Mach fields in register 60₁₆ contain a value, consistent with the indicated airspeed or Mach No generated via a test set, and the Indicated Airspeed or Mach Status bits indicate valid data.

(d) Sensor Sources

Particular attention should be given to the interface between data sources and transponders when multiple transponders and multiple sensors are employed. In this context, 'sensors' refers to FMS, IRS, AHRS, ADS, GPS, or Data Concentrator (or other) systems used to provide data to the transponder.

The crew should be aware, at all times, which sensors are providing information to the active transponder.

In an installation, where automatic sensor selection for the active transponder is not provided, the captain's side transponder should utilise the captain's side sensors, and the co-pilot's side transponder should utilise the co-pilot's side sensors.

Data parameters from different sensors of the same type should not be mixed.

Note: For example, Mode-C or Mode-S altitude reporting information from ADC source #1 should not be mixed with reporting of TAS, Baro Vertical Rate, Mach from ADC source #2. In this case, partially blocking of data output from either ADC source #1 or #2 will cause uncorrelated results. This could result in problems with ATC ground processing of the data.

Where only single sensors are available (i.e. single FMS), it is permissible to connect the single sensor to multiple transponders. It should be noted that this may result in reduced operational availability should the single sensor fail.

Section 4 — 1090 MHz Extended Squitter ADS-B Out

GM1 ACNS.D.ADSB.001 Applicability

With respect to 1 090 MHz ES ADS-B Out installations, the material in this section is to a large degree in line with the corresponding FAA AC 20-165A material. Differences between the two documents are listed in Appendix J . This guidance may be of use when showing of compliance with both documents is required.

The requirements of CS ACNS.D.ADSB fully cover (and exceed) the requirements of AMC 20-24 (Certification Considerations for the Enhanced ATS in Non-Radar Areas using ADS-B Surveillance (ADS-B-NRA) Application via 1090 MHz Extended Squitter). Therefore, aircraft that comply with CS ACNS.D.ADSB also comply with AMC 20-24 but not vice versa.

The approval of on-board systems receiving and processing ADS-B messages in support of air-to-air applications is outside the scope of Subpart D section 4.

Note: In accordance with EU Regulation No 1207/2011, aircraft having a maximum take off mass greater than 5 700 kg or a maximum cruising true airspeed greater than 128.6 m/s (250 knots) and operating flights as general air traffic in accordance with instrument flight rules in the airspace within the ICAO EUR and AFI regions where EU Member States are responsible for the provision of air traffic services are to be compliant with CS ACNS Book 1 Subpart D section 4.

AMC1 ACNS.D.ADSB.010 ADS-B Out system approval

Equipment Qualification

For equipment qualification, refer to AMC1 ACNS.D.ADSB.030 through to AMC1 ACNS.D.ADSB.090.

The ADS-B Out functionality should be demonstrated by ground testing, using ramp test equipment where appropriate, that verifies during nominal system operation, the correctness of the aircraft derived surveillance data contained in the ADS-B messages, and the functioning of system monitoring tools/fault detectors including any ADS-B self-test features.

AMC1 ACNS.D.ADSB.020(a-b) ADS-B Out data parameters

During ADS-B Out system installation testing, all the parameters that are broadcast should be demonstrated to be correct for each installed ADS-B transmit unit, i.e. the transmitted data should be in line with the respective source data.

The Emitter Category, Aircraft Length and Width and GPS Antenna Offset parameters might be either configured as a fixed value during ADS-B Out system installation, or provided via a variable data interface. In both cases, during installation, the respective settings should be verified to be correctly set.

The ADS-B Horizontal Position System Design Assurance (SDA) parameter indicates the probability of an ADS-B Out system malfunction causing false or misleading position information or position quality metrics to be transmitted. SDA may be pre-set at installation for systems that do not utilise multiple position sources with different design assurance levels, otherwise the system should be capable of adjusting the SDA broadcast parameter to match the position source being employed at the time of transmission.

ADS-B transmit equipment that is compliant with AMC1 ACNS.D.ADSB.030 and that is directly connected to a position source compliant with AMC1 ACNS.D.ADSB.070 may set the SDA to 'two' without further analysis. For more complex ADS-B installations, a system safety assessment is required to set the SDA.

Basically, the lowest design assurance level of one system in the horizontal position data transmission chain should define the SDA value.

Additional guidance material on the required surveillance data parameters are provided in APPENDIX H Part 1 and Part 2.

APPENDIX H Part 6 provides matrices of the so-called BDS register fields as used by the 1090 ES ADS-B transmit unit to broadcast the ADS-B Out parameters. These matrices detail the ADS-B Out data requirements at data field level for general understanding and in support of integration testing, as appropriate.

If installations transmit ADS-B Out data that do not meet some requirements of the Subpart D Section 4, the respective data should only be transmitted with a 'zero' quality indication (if a quality indication is defined in the ADS-B Out transmit system).

AMC1 ACNS.D.ADSB.025(a) Provision of data — Approved sources

(a) See AMC1 ACNS.D.ADSB.070-090 for details on the approval of the respective data sources.

(b) For transmission of optional data items, the following provisions should be considered:

(1) Airspeed

In case of a loss of GNSS horizontal velocity data, the ADS-B transmit unit normally switches to broadcast airspeed information (using subtypes 3 and 4 of register 0916).

Therefore, if airspeed data is provided to the ADS-B transmit unit, it should be provided by an approved airspeed source that is providing data intended for use by the flight crew. An air data computer meeting the minimum performance requirements of holding an EASA equipment authorisation in accordance with ETSO-C106 (JTSO-C106) is an acceptable source.

(2) Heading

In case of a loss GNSS ground track and if heading is provided to the ADS-B transmit unit, the heading source should hold an EASA equipment authorisation in accordance with ETSO-C5e (JTSO-C5e) or any revision of ETSO-C6d (JTSO-C6d).

(3) Other Data Parameters

The Intent Change Flag should be set as appropriate to indicate the availability of information in the Mode S registers 40₁₆ to 42₁₆.

If available, Selected Heading information should come from approved data sources.

The 1090 ES IN capability field should be set correctly.

AMC1 ACNS.D.ADSB.025(c) Provision of data – Data quality indication and associated data

Data quality indications for the horizontal position containment bound (NIC) and horizontal position accuracy bound (NACp) should be provided to the ADS-B transmit unit together with the corresponding horizontal position information within the same data set.

Data quality indications for the horizontal position source integrity level (SIL) and system design assurance level (SDA) may be preset at installation. Systems that utilise multiple GNSS-based position sources with different design assurance levels or source integrity levels, should be capable of adjusting the SDA and SIL quality indications to match the position source that is employed at the time of transmission.

The horizontal velocity accuracy bound (NACv) and vertical geometric altitude accuracy bound (GVA) should be dynamically provided to the ADS-B transmit unit together with the corresponding velocity and geometric altitude information within the same data set. However, NACv and GVA may be also preset at installation.

For further guidance on the ADS-B data quality indicators, refer to AMC1 ACNS.D.ADSB.070(a).

AMC1 ACNS.D.ADSB.030 ADS-B Transmit unit installation

To be approved, the ADS-B transmit unit should hold an EASA equipment authorisation in accordance with ETSO-C166b and ETSO-C112d, including any additional requirements as required to comply with the provision of the AMC's to Subpart D section 4 (e.g. On-the-ground status determination and maximum NIC encoding). Where such additional requirements apply, it is expected that the ADS-B transmit unit manufacturer supplies compliance information through a Declaration of Design and Performance (DDP), or an equivalent document.

The broadcast of Selected Altitude and Barometric Pressure Setting are optional for equipment meeting ETSO-C166b and equipment should implement this optional functionality if available and in a suitable format

If using earlier versions of ETSO-C112(), it should to be demonstrated that all applicable requirements from EUROCAE ED-102A have been implemented. This can be achieved by a positive deviation of compliance to previous versions of EUROCAE ED-73 that have been documented in the Declaration of Design and Performance (DDP).

AMC1 ACNS.D.ADSB.040 Antenna Diversity

The 1090 ES data protocol includes a bit to indicate, at any time, if only one or both antennas (if installed) are functional. The corresponding parameter for the Single Antenna bit is contained in register 65₁₆ (message element bit '30') and should be set to the appropriate value.

Note 1: For detailed guidance on the required antenna diversity as a function of aircraft maximum cruising true airspeed capability, refer to AMC1 ACNS.D.ELS.065.

Note 2: For further guidance on antenna installations, see CS ACNS.D.ELS.060, CS ACNS.D.ELS.065, AMC1 ACNS.D.ELS.060 and AMC1 ACNS.D.ELS.065.

AMC1 ACNS.D.ADSB.055 Simultaneous operation of ADS-B transmit units

Manual switching between transmitters is considered acceptable.

Note: The requirement applies to ADS-B transmit units broadcasting on the same data link. It does not preclude simultaneous operation of dual link installations.

AMC1 ACNS.D.ADSB.060 On-the-ground status Determination

For aircraft with retractable landing gear, the on-the-ground status determination is typically provided through a landing gear weight-on-wheels switch. For aircraft that have fixed-gear, the ADS-B Out system should be able to determine the air-ground status of the aircraft using other means.

Installations that provide a means to automatically determine on-the-ground status based on input from other aircraft sensors are acceptable if they are demonstrated to accurately detect the status. Otherwise, ground status validation algorithms should be implemented, using speed thresholds that match the typical aircraft's rotation speed as closely as possible.

It is noted that for the validation of a directly determined on-the-ground status that is not validated outside the ADS-B transmit function, validation against the aircraft's typical rotation speed (rather than a fixed value of 50 m/s (100 knots)) might not have been tested in accordance with ETSO-C166b. If that is the case, it is expected that the ADS-B transmit unit manufacturer supplies compliance information through a Declaration of Design and Performance (DDP), or an equivalent document.

Detailed guidance material is provided in APPENDIX I.

AMC1 ACNS.D.ADSB.070 Horizontal Position and Velocity Data Sources

(a) GNSS Standards

(1) Basic GNSS System Approval

To be approved, the horizontal position and velocity data source should hold an EASA equipment authorisation in accordance with either ETSO-C129a, or ETSO-C196, or ETSO-C145/ETSO-C146, including the additional qualification requirements as specified in paragraph (2) below.

(2) Additional GNSS Receiver Qualification Requirements

In order to fully address the standard associated with ADS-B Out, an ETSO authorisation alone may not be sufficient to ensure ADS-B compatibility. The position and velocity source should also comply with the following requirements (i) to (vi).

It is expected that compliance with these requirements is demonstrated by the equipment manufacturer and documented in the Declaration of Design and Performance (DDP), or an equivalent document. Detailed guidance material on the qualification requirements is provided in APPENDIX H Part 5.

(i) GNSS system must provide a latitude and longitude output.

Note: ETSO-C129a does not cater for full compliance with this requirement.

(ii) The horizontal position integrity containment should have been qualified as per APPENDIX H Part 5 paragraph 1;

Note: Horizontal Uncertainty Level (HUL) information does not fulfil CS ACNS.D.ADSB.070.

(iii) The maximum time to alert for the indication of a signal-in-space data integrity failure should be 10 seconds as per Appendix H in Part 5 paragraph 1;

(iv) Navigation modes that would force the NIC value temporarily to 'zero' whilst the actual horizontal position integrity containment bound would meet the NIC requirements in APPENDIX H Part 3 Table , should not be installed.

(v) The horizontal position source accuracy output should have been qualified as per Appendix H Part 5 paragraph 2;

(vi) The horizontal position source latency and timing characteristics should have been documented (see APPENDIX H Part 5 paragraph 3);

(vii) The horizontal velocity accuracy output should have been qualified. If a dynamic horizontal velocity accuracy output is not provided, the transmitted horizontal velocity accuracy should be based on a worst case accuracy. If a dynamic horizontal velocity

accuracy output is provided, the source should have been qualified for this quality indication accordingly as per APPENDIX H Part 5 paragraph 4.

In addition, a means should be provided to establish the condition when the horizontal velocity track angle accuracy exceeds plus/minus 'eight' degrees as per Appendix H Part 5 paragraph 4.

(3) Interface Interoperability Aspects

It should be verified that the position and velocity information (including their respective quality indicators) received from the source are correctly interpreted by the ADS-B equipment.

(i) Horizontal Position Integrity Containment Bound

Some approved horizontal position sources may incorrectly output horizontal position integrity containment bounds of less than 75 meters. In such cases, it is accepted that the transmit unit limits the NIC value to 'eight'.

It is expected that the ADS-B transmit unit manufacturer supplies compliance information through a Declaration of Design and Performance (DDP), or an equivalent document.

(ii) Horizontal Velocity Format

The position and velocity source manufacturer should provide information describing how the horizontal velocity information is output (i.e. in a ground speed/track angle format versus north/east velocity format) and the protocols used.

(4) Data Quality Indicator Testing

By design and under nominal GNSS satellite constellation conditions, an ADS-B Out system that is compliant with CS ACNS.D.ADSB.070 should meet the required values of the horizontal position NIC, NACp, SIL and horizontal velocity NACv quality indicators (refer to APPENDIX H Part 3 Table).

(b) Installation Guidance

The GNSS based position sources should be installed in accordance with FAA AC 20-138B (or later).

Note: EASA is developing GNSS installation guidance, once published, should be used instead of the FAA material.

(c) Multiple Position and Velocity Data Sources

(1) Multiple Source Approval

Any position and velocity source that is interfaced to the ADS-B transmit unit, should meet the requirements of CS ACNS.D.ADSB.070.

(2) Source Priority

If multiple horizontal position data sources are interfaced with the ADS-B transmit unit, priority should be given to the source that provides the best ADS-B performance with respect to the horizontal position integrity containment bound (NIC).

A change of the selection between sources should only take place when the not selected source has exceeded the NIC performance of the selected source for several seconds.

(d) Interconnecting Avionics

Interconnecting avionics between a horizontal position and velocity data source and the ADS-B transmit unit are not recommended.

If installed, interconnecting avionics should:

- (1) not output horizontal position and velocity data that has been blended with data from other sources;
- (2) use GNSS horizontal velocity data to extrapolate the horizontal position data if extrapolation is deployed; and
- (3) maintain full source resolution of the horizontal position and velocity data.

Interconnecting avionics that do not comply with the above may dilute the horizontal position accuracy achieved with GNSS-based sources, with detrimental effects on the usability of the ADS-B Out system.

Note: closely coupled GPS/IRS systems are not considered as interconnecting avionics.

AMC1 ACNS.D.ADSB.080 Data Sources as defined by Mode S Elementary and Enhanced Surveillance

(a) General Requirements

For the requirements and general guidance on the data sources providing the Mode S Elementary and Enhanced surveillance parameters, the following references to CS ACNS.D.ELS and CS ACNS.D.EHS apply:

- (1) Aircraft Identification: CS ACNS.D.ELS.(a)(3);
- (2) Mode A Code: CS ACNS.D.ELS.(a)(1);
- (3) SPI: CS ACNS.D.ELS.(a)(2);
- (4) Emergency Mode/Status: CS ACNS.D.ELS.(a)(1);
- (5) Pressure Altitude: CS ACNS.D.ELS.025;
- (6) MCP/FCU Selected Altitude: : AMC1 ACNS.D.EHS. (c)(1);
- (7) Barometric Pressure Setting:AMC1 ACNS.D.EHS.;
- (8) ACAS Operational/Resolution Advisory: AMC1 ACNS.D.ELS.015; and
- (9) ICAO 24 bit Address: CS ACNS.D.ELS.050.

(b) Emergency Status

When transmitting the Mode A emergency status codes, the additional specific bits should be set (see APPENDIX H , Part 1, Definition 10).

(c) Pressure Altitude — NICbaro

For aircraft with an approved, non-Gillham altitude source, the Barometric Altitude Integrity Code 'NICbaro' should be set to 'one'.

For aircraft where the pressure altitude that is based on a Gillham coded input that has not been cross-checked against another source of pressure altitude, the 'NICbaro' should be set to 'zero'. Otherwise, the 'NICbaro' should be set to 'one'.

For general guidance on the ADS-B ‘NICbaro’ indicator that is associated with Pressure Altitude information, refer to APPENDIX H , Part 1, Definition 9.

(d) Vertical Rate

The Vertical Rate information should come from the most accurate and steady source.

In order to ensure that minimum performance requirements are met for Vertical Rate information, the following source prioritisation should be applied:

- Hybrid Vertical Rate Source: the information may be taken from a hybrid system which filters barometric vertical rate with an inertial reference unit (IRU) vertical rate and GNSS vertical rate, provided the accuracy of the vertical rate output is at least as good as barometric vertical rate sources (e.g. ETSO-C106).
- Blended Vertical Rate Source: the information may be taken from a blended system which filters IRU vertical rate and barometric vertical rate, provided the accuracy of the vertical rate output is at least as good as barometric vertical rate sources (e.g. ETSO-C106).
- Barometric Vertical Rate Source: the information may be taken from an air data computer (ADC) holding an EASA equipment authorisation in accordance with ETSO-C106 or a vertical velocity instrument holding an EASA equipment authorisation in accordance with applicable revisions of ETSO-C8() .
- GNSS Vertical Rate Source: GNSS vertical velocity equipment which have not been qualified in accordance with CS-ACNS.D.ADSB.070 should not be interfaced with the ADS-B transmit unit.

Vertical Rate from an inertial sensor that is not blended with barometric altitude should not be transmitted. Neither should ADS-B transmit units derive a barometric altitude rate by sampling barometric altitude measurements.

The source bit for vertical rate (1090 ES register 09₁₆, message bit ‘36’) should be coded as barometric when utilising barometric rate from an air data computer, or when using a blended or hybrid vertical rate. The source bit for vertical rate should only be coded as geometric when using vertical rate from a GNSS source.

Note: due to differences in the respective transmit formats, the above source prioritisation differs in some parts with the guidance applicable to Mode S Enhanced Surveillance as provided in AMC1 ACNS.D.EHS.015.

For general guidance on Vertical Rate data sources, refer to APPENDIX H , Part 1, Definition 14.

(e) Selected Altitude (and related Modes)

With respect to the various status and mode fields contained in register 62₁₆ (subtype 1), the respective provisions of AMC1 ACNS.D.EHS. (c)(1) apply to the Selected Altitude Type, Status of MCP/FCU Mode Bits, VNAV Mode Engaged, Altitude Hold Mode, and Approach Mode information.

The population of the additional Autopilot Engaged and LNAV Mode Engaged fields status bits are optional but should be populated where the data is available.

AMC1 ACNS.D.ADSB.085 Geometric Altitude

(a) Geometric Altitude data source

The position source should output a vertical position accuracy metric to support the encoding of the Geometric Altitude GVA quality indicator.

GNSS position sources should provide the geometric altitude accuracy through the vertical figure of merit (VFOM). If that is the case, the vertical position source accuracy output by a GNSS receiver should have been qualified as per Appendix H Part 5 paragraph 5.

If the position source does not output a qualified vertical accuracy metric, the GVA parameter should be set to 'zero'.

For general guidance on the GVA encoding, refer to Definition 20 in APPENDIX H of Subpart D.

(b) Geometric Altitude Reference

A GNSS position source compliant with CS ACNS.D.ADSB.070 provides Geometric Altitude, in its native format, as geocentric height above the earth's ellipsoid shape. Height Above Ellipsoid (HAE) is described by the WGS-84 format.

Another altitude reference is described by the earth's geoid, a surface on which the gravitational potential is constant and which approximates the (local) mean levels of all the earth's seas. The difference between the mathematically idealised smooth ellipsoid and irregular geoid surfaces varies between +106m to -85m across the earth. The related Mean Sea Level (MSL) altitude is then established as the sum of the HAE altitude and those local differences (using look-up tables). MSL is sometimes also referred to as Height-Above-Geoid (HAG).

A position source that only provides HAG or MSL altitude (ARINC label 076) but not HAE (ARINC label 370) should not be interfaced to the ADS-B transmit unit unless the ADS-B transmit unit can properly convert HAG/MSL to HAE, using the same HAG/MSL model as the position source (typically NATO STANAG Appendix 6). This should be based on position source installation instructions that specify a deterministic method to perform conversion to HAE, and be demonstrated during ADS-B transmit unit design approval. It is expected that the respective compliance information is supplied by the position and velocity source, and ADS-B transmit unit manufacturers through a Declaration of Design and Performance (DDP) or an equivalent document.

Note: Horizontal position sources compliant with Class 3 equipment approved under ETSO-C145c/C146c are required to output HAE altitude. The requirement has been implemented from revision C of RTCA/DO-229 onwards.

(c) Geometric Altitude Accuracy Quality Indicator Testing

If a qualified vertical accuracy metric is available, under nominal GNSS satellite constellation and visibility conditions, the transmitted GVA value should be a minimum of 'one'.

AMC1 ACNS.D.ADSB.090(a) Flight Deck Interface

(a) Installations

(1) Data Transmission and Display Consistency

The data transmitted by the active ADS-B transmit unit with the data displayed to the flight crew should be consistent.

Note: The horizontal position data displayed to the flight crew might be based on data from more than the position source than that used for ADS-B transmissions.

(2) Single Point of Flight Crew Entry

Installations that do not provide a single point of flight crew entry for the transponder and the ADS-B transmit unit should be evaluated to ensure that dual entry of the Mode

A code, SPI, and emergency status does not lead to the transmission by the active ADS-B transmit unit of inconsistent data, particularly when communicating an aircraft emergency.

(b) ADS-B Off Switch

If control is provided to enable or disable the ADS-B transmit unit, then the status of the active ADS-B transmit unit should clearly be indicated to the flight crew from their normal seated position.

The respective controls should be located such that inadvertent disabling is prevented.

AMC1 ACNS.D.ADSB.090(b) Flight Deck Interface

ADS-B device or function failures, should be indicated in amber or in accordance with the flight deck annunciation philosophy, without undue delay, i.e. a response time within the order of one second.

ADS-B device or function failures may be indicated independently of each other; however, detailed operating instructions should be developed to describe the means to interpret indications.

The ADS-B device or function failure indication should not be confused with an ACAS or Mode S system failure annunciations.

In case of an ADS-B function failure, it is expected that the transponder should continue to support the ACAS, Mode A/C and Mode S functions.

The proper indications of the ADS-B Out system failures should be tested.

AMC1 ACNS.D.ADSB.110 Horizontal Position and Velocity Data Refresh

For systems with a 1 Hertz computation rate, the output of position and velocity data can vary between 0.8 seconds and 1.2 seconds.

Note Faster position update rates reduce the latency of the transmitted position and velocity information and are therefore encouraged.

AMC1 ACNS.D.ADSB.115 and 120 Horizontal Position and Velocity Total and Uncompensated Latency

(a) Time of Applicability

With respect to the latency requirements in CS ACNS.D.ADSB.115 and CS ACNS.D.ADSB.120, the initial time of applicability (ITOA) is the time of validity of the position or velocity solution. Hence, the latency between the time of signal in space measurement (TOM) and this time of validity is excluded from the total latency budget.

The transmit time of applicability (TTOA) equals the initial time of applicability plus the amount of compensated latency (CL), as valid at the time at which the ADS-B transmit unit broadcasts the position (or velocity) information (TOT).

(b) Compliance Demonstration

Total latency (TL) is the difference between time of transmission (TOT) and initial time of applicability (ITOA). The analysis of total latency includes the maximum asynchronous delay caused by the time difference of position (or velocity) updates arriving at the ADS-B transmit unit and of transmitting the information. It is noted that for ADS-B transmit units compliant with AMC1 ACNS.D.ADSB.030, this asynchronous delay can be up to 1.1 second.

Uncompensated latency (UL, or more generically a latency compensation error) is the difference between total latency (TL) and amount of compensated latency (CL) thereof. Therefore, uncompensated latency determines the transmit time of applicability (TTOA). The GNSS time mark if provided to the transmit system, can be used by the ADS-B transmit unit to reduce uncompensated latency. It is possible for compensation algorithms to overcompensate for the effects of latency, also as a result of the desired attempt to account for latency external to the ADS-B transmit unit. This might lead to transmitting a position that is out in front of the actual aircraft position rather than behind the actual aircraft position. This is acceptable as long as the transmitted position is not further ahead than 0.2 s (200 ms).

The various latency related parameters are summarised in Figure 1.

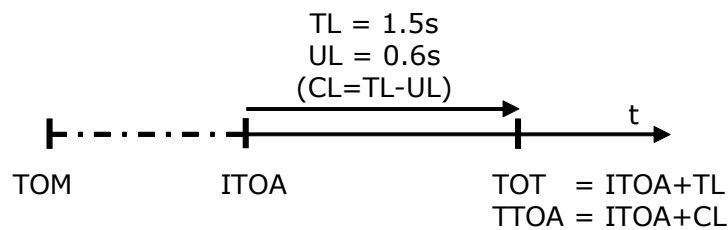

Figure 1: Latency Parameters

Latency should be addressed through analysis rather than testing. Total and uncompensated latency information should be generated by the respective manufacturers of the position source, ADS-B transmit unit and any interconnecting avionics and should be included as part of the latency analysis.

The latency analysis should determine the latency applicable to each component of the ADS-B Out system. The total of all of the individual component latencies should be established as the sum of their maximum latencies.

ADS-B Out systems whereby the transmit equipment compliant with AMC1 ACNS.D.ADSB.030 is directly connected to a position source compliant with AMC1 ACNS.D.ADSB.070, should meet the total latency and uncompensated latency requirements without further analysis.

For other ADS-B Out systems, the applicant should perform a detailed position and velocity latency analysis. This includes systems where ADS-B Out system components are interfaced through a highly integrated architecture.

For detailed guidance on horizontal position and velocity source latency qualification, refer to APPENDIX H Part 5.

It is expected that this compliance information is supplied by the position and velocity source manufacturer through a Declaration of Design and Performance (DDP) or an equivalent document.

(c) ADS-B Quality Indicator Change Latency

The ADS-B Quality Indicator change latency requirements are driven by the maximum time to alert for the indication of a data integrity failure with respect to exceeding integrity containment bound (CS ACNS.D.ADSB.070 and related AMC guidance).

For detailed guidance on time to alert qualification, refer to APPENDIX H Part 5.

(d) Horizontal Position Latency Compensation

The ADS-B transmit unit may compensate for horizontal position latency incurred outside the ADS-B transmit unit (see sub-paragraph 2 above). If such is implemented, a verifiable estimation of the delay between the time of applicability of the position measurement, and the provision of that measurement to the ADS-B transmit unit data interface should be performed

APPENDIX A — BACKGROUND INFORMATION FOR MODE A/C SURVEILLANCE SYSTEM

(a) General

This appendix provides additional references, background information, and guidance for maintenance testing, as appropriate to Mode A/C surveillance installations.

(b) Related References

(1) EASA

ETSO-C74d, Minimum Performance Standards for Airborne ATC Transponder Equipment.

(2) ICAO

(i) ICAO Annex 10, Volume IV, Aeronautical Communications (Surveillance Radar and Collision Avoidance Systems) — Amd. 85;

(ii) ICAO Document 8168-OPS/611 Volume I, Procedures for Air Navigation Services, Aircraft Operations;

(iii) ICAO Document 4444-ATM/501, Procedures for Air Navigation Service, Air Traffic Management; and

(iv) ICAO EUR Regional Air Navigation Plan, Part IV CNS Supplement SSR Code Allocation List for the EUR region, current edition.

(3) EUROCAE

(i) ED-43, Minimum Operational Performance Requirements for SSR Transponder and Alticoder;

(ii) ED-26, Minimum Performance Specification for Airborne Altitude Measurement and Coding Systems; and

(iii) EUROCAE document 1/WG9/71 June 1972 MPS for airborne secondary surveillance radar transponder apparatus - Including Amendment N°1 (measurement procedures)- April 1974 & Amendment N°2-January 2000.

(4) RTCA

(i) DO-144A Minimum Operational Performance Standards (MOPS) for Air traffic Control Radar Beacon Systems (ATCRBS) Airborne Equipment.

(c) Background Information

Airborne surveillance system

The following diagram presents the Mode A and C transponder and its main functional interfaces.

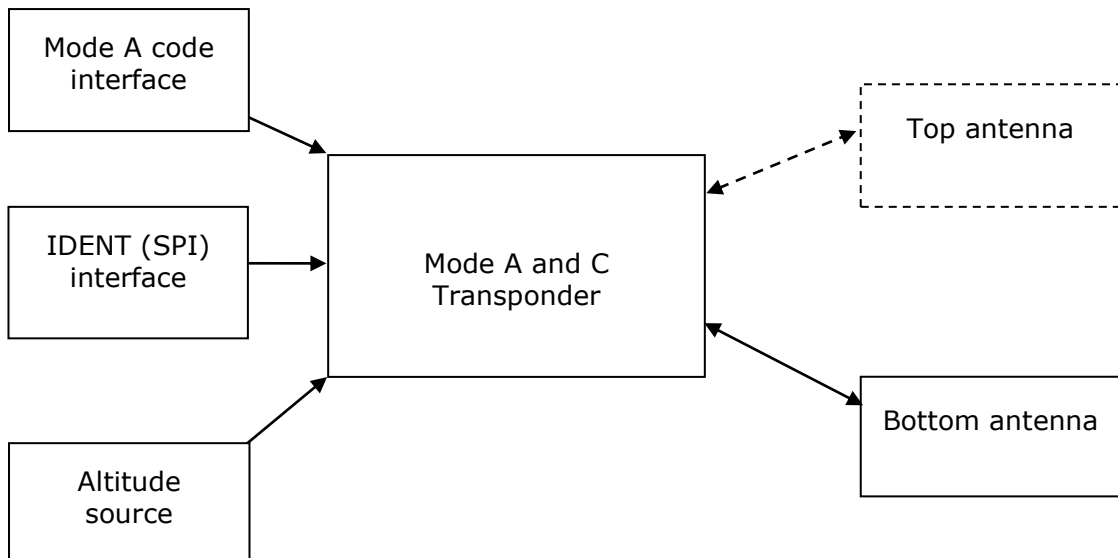

Figure 2: Mode A/C transponder interfaces

APPENDIX B — BACKGROUND INFORMATION ON MODE S ELS

(a) General

This appendix provides background information on Elementary Surveillance (ELS) useful to understand ELS airborne surveillance system defined in the CS ACNS.D.ELS and its associated AMCs.

(b) Related Material

(1) EASA

ETSO-C112d, Minimum Operational Performance Specification for SSR Mode S Transponders. (Based on EUROCAE ED-73E).

(2) ICAO

- (i) ICAO Annex 10, Volume IV, Amd. 85, Aeronautical Communications (Surveillance Radar and Collision Avoidance Systems);
- (ii) ICAO Document 9871 Edition 2 (transponder register formats);
- (iii) ICAO Document 8168-OPS/611 Volume I (Procedures for Air Navigation Services); and
- (iv) ICAO Document Doc 4444-RAC/501 Procedures for Air Navigation Service, Air Traffic Management.

(3) EUROCAE

- (i) ED-73E Minimum Operational Performance Specification for Secondary Surveillance Radar Mode S Transponders; and
- (ii) ED-26 Minimum Performance Specification for Airborne Altitude Measurement and Coding Systems.

(4) RTCA

RTCA DO-181E. Minimum Operational Performance Specification for Air Traffic Control Radar Beacon System/Mode Select (ATCRBS/Mode S) Airborne Equipment.

(c) Background Information

Airborne surveillance system description

This section describes the ELS system including transponder, interfaces, and antenna.

The following diagram represents the Mode S Transponder and its main functional interfaces.

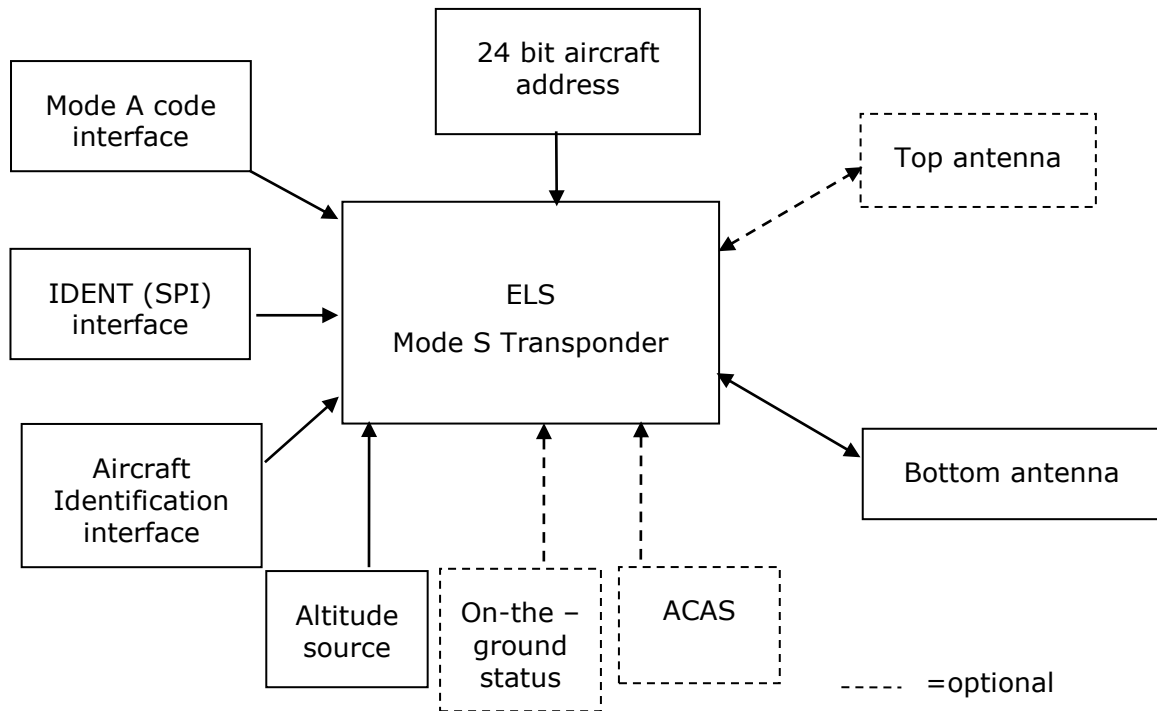

Figure 3: Mode S ELS transponder interfaces

(1) Acquisition of aircraft position by Mode S ELS radar

Aircraft entering the coverage of a Mode S radar is first acquired by All Call interrogations to which the transponder will reply if it is not on the ground. Therefore, it is important to test that the airborne surveillance system correctly takes into account the on-the-ground information. The on-the-ground status is also used by the ACAS systems to select aircraft which will be tracked.

During this acquisition phase the radar will acquire the Horizontal position and the 24-bit aircraft address corresponding to the aircraft technical address on the RF network.

The position and the aircraft address will be subsequently used to selectively interrogate the aircraft during the rest of its trajectory through the radar coverage.

Selective interrogations will be used:

- (a) to update the horizontal position of the aircraft;
- (b) to request the aircraft to not reply to the All Call interrogations specifically transmitted by the radar. This is known as lockout command;
- (c) to request additional information such as Mode A code and altitude; and
- (d) to request further information to be downlinked from specific aircraft transponder registers such as the Aircraft Identification.

(2) Determination of the aircraft surveillance system capability

Ground surveillance system will need to establish the capabilities of the aircraft surveillance system to extract information only if it is available in the aircraft surveillance system. If this is not done, it could result in a situation where the aircraft would no longer reply to the

interrogations used by the radar, and, therefore, the position of the aircraft could be lost. Hence, there is a need to have correct reporting of the aircraft surveillance system capability.

This process starts by determining whether the transponder is level 2 or above by checking the CA field of the Mode S All Call replies. The CA field is encoded with either 4,5,6,7 to indicate that the transponder is a level 2.

If the transponder is a level 2 or above transponder, the second step of the process is the verification of the data-link capability provided in register 10₁₆, the 'Data link capability report'. It contains different information about the data link capability of the airborne surveillance system

Elementary Surveillance System will use important information from this register, including:

- (i) Aircraft Identification capability (bit 33 of register 10₁₆) to determine the availability of the register containing the Aircraft Identification;
- (ii) Surveillance Identifier code (bit 35 of register 10₁₆) which indicates if SI protocol can be used to lockout the transponder; and
- (iii) the Mode S Specific Services capability (bit 25 of register 10₁₆) which indicates that Mode S specific services; including additional registers used for enhanced surveillance; are supported; and that the particular capability reports should be checked.

If the 'Mode S Specific Services' bit is set in register 10₁₆, the availability of other registers will be checked by extracting register 17₁₆.

(3) Extraction of Aircraft Identification using Mode S protocol

Aircraft equipped with Mode S having an aircraft identification feature transmits its Aircraft Identification as specified in Item 7 of the ICAO flight plan, or when no flight plan has been filed, the aircraft registration.

Aircraft Identification information will be obtained by Mode S radar by extracting the transponder register 20₁₆ at the track initialisation.

The Aircraft Identification is variable when it changes from one flight to another flight. It is, therefore, possible that input errors may occur. Whenever it is observed on the ground situation display that the Aircraft Identification transmitted by a Mode S-equipped aircraft is different from that expected from the aircraft, the flight crew will be requested to confirm and, if necessary, re-enter the correct Aircraft Identification.

When Aircraft Identification is modified, the transponder will indicate this change for 18s in its selective replies. This is done using the Mode S Comm-B Broadcast protocol (ICAO Annex 10 Volume IV 3.1.2.6.11.4). The Mode S ground station will extract the Comm-B Broadcast message to obtain the new value of the Aircraft Identification.

(4) Extraction of Mode A code using Mode S protocol

Ground Mode S surveillance system will extract Mode A code at track initialisation.

If the Mode A code is modified, the transponder will indicate this change for 18s in its selective replies. This is done by raising an alert bit which is set for 18s after the change. Once this alert is detected, the Mode S ground stations will extract the new Mode A code.

It is, therefore important, that the change of the Mode A code happens on the active transponder which is announcing the change for 18s.

Note: ED-73E contains additional requirement requiring the announcement of a Mode A code change when a transponder becomes active. This is not necessarily available on older Mode S transponders in which it may be necessary to follow a specified procedure on installations with

no common control interface. In some instances, a ground system workaround, consisting of periodically extracting the Mode A code, has also been implemented.

(5) ACAS Resolution Advisory (RA) report extraction

When a resolution advisory has been produced, the transponder announces the presence of a 'RA report' for the time that the RA is active until 18s after it has ceased. The Mode S ground stations will extract the register 30₁₆ to obtain the information

(6) Summary of registers used for ELS

Register 10₁₆ to obtain information on data link capability of the airborne surveillance system.

Register 17₁₆ to obtain information on additional services available. For ELS, it is possible that register 17₁₆ is empty (=0).

Register 20₁₆ to obtain the Aircraft Identification.

Register 30₁₆ to obtain the RA Report

(7) Information on Mode S replies used to support ELS

The following Mode S reply types are used to track the aircraft and obtain additional data:

DF11: Mode S All Call replies containing the 24-bit Aircraft Address and the CA field indicating whether the transponder is level 2 or greater and whether the aircraft is on the ground or airborne. DF11 can also be spontaneously transmitted as acquisition squitters. These replies are used for aircraft acquisition.

DF4: Short Mode S reply containing Altitude information.

DF5: Short Mode S reply containing the selected Mode A code.

DF20: Long Mode S reply containing the Altitude information and the content of the transponder register requested.

DF21: Long Mode S reply containing the Mode A code and the content of the transponder register requested.

APPENDIX C — BACKGROUND INFORMATION ON MODE S EHS

(a) Introduction

This appendix provides background information on Enhanced Surveillance (EHS) useful to understand EHS airborne surveillance system defined in the CS ACNS.D.EHS and its associated AMCs.

(b) Related Material

(1) EASA

ETSO-C112d, Minimum Operational Performance Specification for SSR Mode S Transponders. (Based on EUROCAE ED-73E).

(2) EUROCONTROL

- (i) The Concept of Operations - Mode S in Europe, document SUR.ET2.ST02.1000-CNP-01-00, Edition 2, Nov 1996;
- (ii) Operational Hazard Assessment of Elementary and Enhanced Surveillance, Edition 1.1, EATMP Infocentre Reference: 04/04/07-01, 07.04.2004; and
- (iii) Preliminary System Safety Analysis for the Controller Access Parameter service delivered by Mode S Enhanced Surveillance, Edition 1.1, EATMP Infocentre Reference: 04/04/07-02, 07.04.2004.

(3) ICAO

- (i) ICAO Annex 10, Volume IV, Amd. 85, Aeronautical Communications (Surveillance Radar and Collision Avoidance Systems);
- (ii) ICAO Document 9871 Edition 2;
- (iii) ICAO Document 8168-OPS/611 Volume I (Procedures for Air Navigation Services); and
- (iv) ICAO Document Doc 4444-RAC/501 Procedures for Air Navigation Service, Air Traffic Management.

(4) EUROCAE

- (i) ED-73E Minimum Operational Performance Specification for Secondary Surveillance Radar Mode S Transponders;
- (ii) ED-26 Minimum Performance Specification for Airborne Altitude Measurement and Coding Systems; and
- (iii) ED-12C Software Considerations in Airborne Systems and Equipment Certification.

(5) RTCA

DO-181E Minimum Operational Performance Specification for Air Traffic Control Radar Beacon System/ Mode Select (ATCRBS/Mode S) Airborne Equipment.

(c) Background Information

(1) Airborne surveillance system description

This section describes the EHS system including transponder, interfaces, and antenna.

The following diagram represents the Mode S Transponder, and its main functional interfaces. It is to be noted that different interfaces coming from different parts of the avionics may need to be connected to the transponder to support EHS.

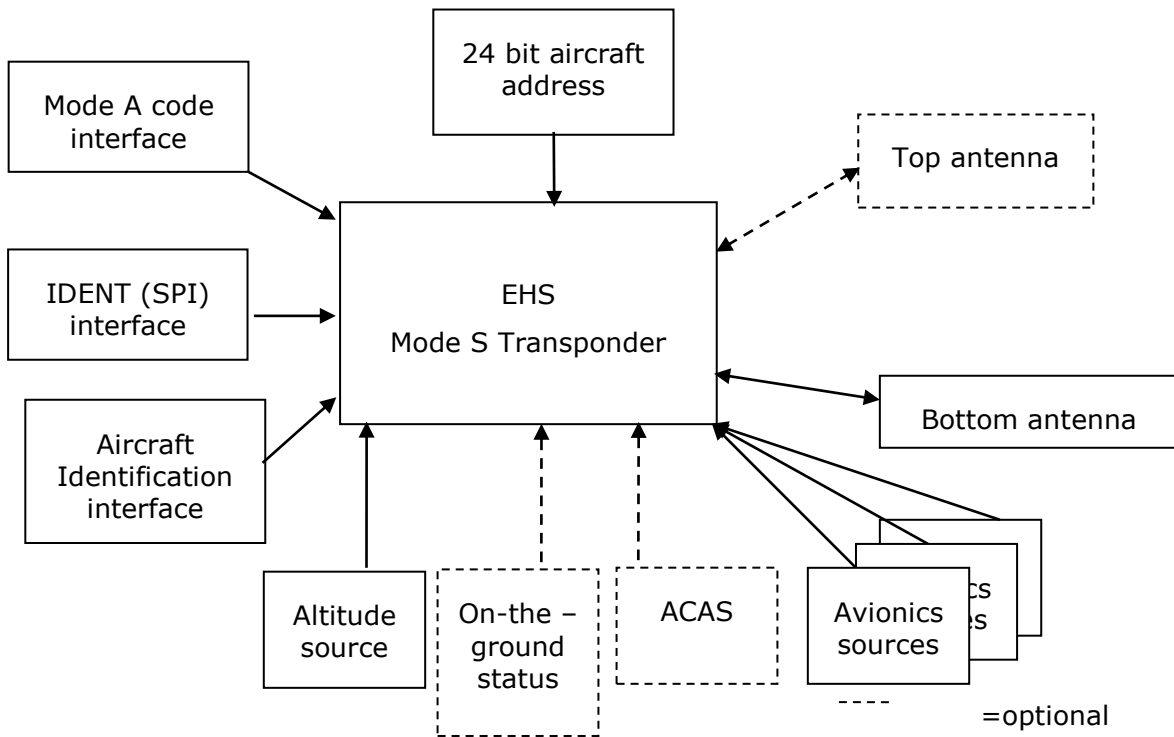

Figure 4: Mode S EHS transponder interfaces

(2) Registers used to support EHS capability

(i) Capability

In addition to the registers already used for ELS capability establishment, the EHS capability of the aircraft will be established using register 17₁₆ and 1D₁₆.

Register 17₁₆ will indicate which other registers (e.g. 40₁₆, 50₁₆, 60₁₆) are currently supported by the airborne surveillance system.

Ground systems could also use register 18₁₆ to 1C₁₆, if available, to determine which registers are installed if those register are not included in register 17₁₆.

Register 1D₁₆ is used to determine if Dataflash specific MSP is installed. Dataflash is an application allowing the transmission of registers to the ground only when they have changed, and, therefore, removing the need for periodic extraction of registers. Dataflash is not expected to be installed, however, some Mode S ground stations have been developed to take benefit of the dataflash application when available on aircraft.

Mode S ground stations can also use Mode S sub network version to filter old systems not correctly supporting EHS.

(ii) Basic Data

Example of a basic list of registers and parameters to use to support the declaration of registers and parameters supported by an EHS installation is provided in Table 2 below.

Table 2 - Example of basic list of EHS registers and parameters

Register number	Assignment	Capability reporting in register 18₁₆ to 1C₁₆	parameters	EHS req
40 ₁₆	Selected vertical intention	Reg. 19 ₁₆ Bit 49	MCP/FCU Selected Altitude	Yes
			FMS Selected Altitude	No
			Barometric Pressure Setting	Yes
			MCP/FCU Mode bits	No
			Target altitude source bits	No
50 ₁₆	Track and turn report	Reg. 19 ₁₆ Bit 33	Roll Angle	Yes
			True Track angle	Yes
			Ground speed	Yes
			Track Angle Rate	Yes
			True Airspeed	Yes
60 ₁₆	Heading and speed report	Reg. 19 ₁₆ Bit 17	Magnetic Heading	Yes
			Indicated Airspeed	Yes
			Mach	Yes
			Barometric Altitude Rate	Yes
			Inertial Vertical Velocity	Yes

(3) Other data

Mode S ground stations can extract other data when available. It is, therefore, important that all data provided are verified.

Table 3 provides more data to facilitate the declaration of other registers and parameters which may be supported and which may need to be added to the basic list provided above.

Table 3 - Example of extended list of Transponder registers and supported parameters

Register number	Assignment	Capability reporting in register 18₁₆ to 1C₁₆	parameters	EHS req
0B ₁₆	Air/air information 1 (aircraft state)	Reg. 18 ₁₆ Bit 46	True Air Speed	No
			heading	No
			True track angle	No
			Ground speed	No
0C ₁₆	Air/air information 2	Reg. 18 ₁₆	Level Off Altitude	No

Register number	Assignment	Capability reporting in register 18 ₁₆ to 1C ₁₆	parameters	EHS req
	(aircraft intent)	Bit 45	Next Course	No
			Time to Next Waypoint	No
			Vertical Velocity	No
			Roll Angle	No
21 ₁₆	Aircraft and airline registration markings	Reg. 18 ₁₆ Bit 24	Aircraft registration number	No
			ICAO airline registration marking	No
22 ₁₆	Antenna positions	Reg. 18 ₁₆ Bit 23		No
25 ₁₆	Aircraft type	Reg. 18 ₁₆ Bit 20		No
41 ₁₆	Next waypoint identifier	Reg. 19 ₁₆ Bit 48	-	No
42 ₁₆	Next waypoint position	Reg. 19 ₁₆ Bit 47	Waypoint latitude	No
			Waypoint Longitude	No
			Waypoint Crossing Altitude	No
43 ₁₆	Next waypoint information	Reg. 19 ₁₆ Bit 46	Bearing to waypoint	No
			Time To Go	No
			Distance To Go	No
44 ₁₆	Meteorological routine air report	Reg. 19 ₁₆ Bit 45	Wind Speed and Direction	No
			Average Static Pressure	No
			Turbulence	No
			Humidity	No
45 ₁₆	Meteorological hazard report	Reg. 19 ₁₆ Bit 44	Turbulence	No
			Wind Shear	No
			Microburst	No
			Icing	No
			Wake vortex	No
			Static Air temperature	No
			Average Static Pressure	No
48 ₁₆	VHF channel report	Reg. 19 ₁₆ Bit 41	VHF1	No
			VHF2	No

Register number	Assignment	Capability reporting in register 18 ₁₆ to 1C ₁₆	parameters	EHS req
			VHF3	No
51 ₁₆	Position report coarse	Reg. 19 ₁₆ Bit 32	Latitude and Longitude and Pressure altitude	No
52 ₁₆	Position report fine	Reg. 19 ₁₆ Bit 31	Latitude fine and Longitude Fine and Pressure altitude or GNSS Height	No
53 ₁₆	Air-referenced state vector	Reg. 19 ₁₆ Bit 30	Magnetic Heading	No
			Indicated Airspeed	No
			Mach Number	No
			True Airspeed	No
			Altitude Rate	No
54 ₁₆	Waypoint 1	Reg. 19 ₁₆ Bit 29	-	No
55 ₁₆	Waypoint 2	Reg. 19 ₁₆ Bit 28	-	No
56 ₁₆	Waypoint 3	Reg. 19 ₁₆ Bit 17	-	No
E3 ₁₆	Transponder type/part number	Reg. 1C ₁₆ Bit 54	-	No
E4 ₁₆	Transponder software revision number	Reg. 1C ₁₆ Bit 53	-	No
E5 ₁₆	ACAS unit part number	Reg. 1C ₁₆ Bit 52	-	No
E6 ₁₆	ACAS unit software revision number	Reg. 1C ₁₆ Bit 51	-	No
F1 ₁₆	Military applications	Reg. 1C ₁₆ Bit 40	-	No
F2 ₁₆	Military applications	Reg. 1C ₁₆ Bit 39	-	No

Note 1: When different fields are defined with their own status, each field will be listed in the table. In this case, it is possible to indicate the provision of the associated parameter by checking the value of the associated status bit.

Note 2: For more information about the content of the registers see Doc 9871 Edition 2 or above.

Note 3: It is recommended to provide registers E3₁₆, E4₁₆, E5₁₆ and E6₁₆.

(d) Existing Installed Transponders

A number of service bulletins have been issued to rectify some observed deficiencies and have already been addressed by the equipment manufacturers. Therefore, the installed transponders should have all published corrective transponder equipment service bulletins (SB) relating to the correct operation of the elementary functionality embodied.

APPENDIX D — DIFFERENCES BETWEEN CS ACNS.D.ELS AND JAA TGL 13 REV1

To demonstrate compliance with CS ACNS Elementary Surveillance requirements, the following additional points need to be addressed for aircraft previously compliant with JAA TGL 13 Rev1:

- (a) Verification that the Aircraft identification sent in Extended Squitter messages and in the Mode S replies are identical, (See CS ACNS.D.ELS. (b) (2));
- (b) Verification that the pressure altitude provided in Extended Squitter messages and in Mode S replies if the installation sends Extended Squitter are identical (See CS ACNS.D.ELS. (b) (2));
- (c) Other parameters provided by the airborne surveillance system are verified as correct and are correctly indicated as available. (See CS ACNS.D.ELS. (b) (1)).

Note. The tests of the other parameters transmitted by the system allow certification of aircraft not subject to full EHS mandate but capable of transmitting some of the parameters which can be used by the operational systems.

APPENDIX E — DIFFERENCES BETWEEN CS ACNS.D.EHS AND EASA AMC 20-13

To demonstrate compliance with CS ACNS Enhanced Surveillance requirements, the following additional points need to be addressed for aircraft previously compliant with EASA AMC 20-13:

- (a) All transmitted parameters are correct and are correctly indicated as available (see CS ACNS.D.EHS.015 (c)) ;
- (b) Barometric pressure setting is provided (See CS ACNS.D.EHS.015 (a) (8) and (c)).

APPENDIX F — EXAMPLE OF FLIGHT MANUAL SUPPLEMENT FOR ELS/EHS

This Flight Manual is EASA approved under Approval Number P-EASA.xxxxx

Flight Manual [or POH as appropriate] Reference _____

(Company Name)

FLIGHT MANUAL SUPPLEMENT

Aircraft Model: _____

Serial Number: _____

SSR MODE S Elementary/Enhanced Surveillance

Modification Number _____

The limitations and information contained herein either supplement or, in the case of conflict, override those in the flight manual.

GENERAL

The installed transponder system is able to respond to interrogations in Modes A, C and S and is fully compliant with the requirements of CS ACNS.D.ELS/EHS (Mode S Elementary/Enhanced Surveillance). A detailed description of the transponder operation can be found in the _____, P/N _____, Rev. ____ or subsequent revisions.

LIMITATIONS

None.

EMERGENCY PROCEDURES

No change to Approved Aircraft Flight Manual.

NORMAL/ ABNORMAL PROCEDURES

Normal/Abnormal transponder operating procedures are described in the _____, P/N _____, Rev. ____ or subsequent revisions.

The procedure to change Aircraft Identification in flight is described in _____.

PERFORMANCE

No change to Approved Aircraft Flight Manual.

To be inserted in the flight manual and record sheet amended accordingly.

Page (__) of (__)

Authority/DOA

Approval: _____ Date: _____

Issue: _____

Signature: _____

APPENDIX G - EXAMPLE OF FLIGHT MANUAL SUPPLEMENT FOR ADS-B OUT

(Aircraft Type) Flight Manual [or POH as appropriate] Reference (XXXX)

(Company Name)

FLIGHT MANUAL SUPPLEMENT (1) ISSUE (1)

Aircraft Model: _____

Serial Number: _____

ADS-B Out

Modification Number _____

ADDITIONAL LIMITATIONS AND INFORMATION

The limitations and information contained herein either supplement or, in the case of conflict, override those in the flight manual.

GENERAL

The installed ADS-B out system is fully compliant with the requirements of CS ACNS.D.ADSB (1090 MHz Extended Squitter ADS-B Out). A detailed description of the system operation can be found in the _____, P/N _____, Rev. ____ or subsequent revisions.

LIMITATIONS

None.

EMERGENCY PROCEDURES

No change to Approved Aircraft Flight Manual.

NORMAL/ ABNORMAL PROCEDURES

Normal/Abnormal operating procedures are described in the _____, P/N _____, Rev. ____ or subsequent revisions.

The procedure to change Aircraft Identification in flight is described in _____.

PERFORMANCE

No change to Approved Aircraft Flight Manual.

To be inserted in the flight manual and record sheet amended accordingly.

Page (__) of (__)

Authority/DOA

Approval: _____ Date: _____

Issue: _____

Signature: _____

APPENDIX H – GUIDANCE ON 1090 MHZ EXTENDED SQUITTER ADS-B OUT

Part 1 – ADS-B Out Data Parameters (AMC ACNS.D.ADSB.020(a))

Part 1 of this Appendix provides guidance to the aircraft integrator on the minimum ADS-B Out surveillance data requirements (Table 5 and associated Definitions).

In addition, guidance is given for the overall understanding of the ADS-B Out system, in support of equipment configuration and ADS-B Out data parameter testing, as appropriate. This includes the presentation of data encodings related to the so-called BDS registers (Table 4), as extracted from ED-102A. The content of the various BDS registers are loaded into the 56-bit ADS-B message (ME) field of the Mode S Downlink Format 17 (DF17, bits 33-88), in line with their respective transmission rates.

Table 5 below makes reference to the BDS registers that contain the various ADS-B Out data parameters. When Table 5 states Same source as for Mode S replies, reference is made to the requirement that the content of ADS-B broadcasts and Mode S replies that carry the same information need to come from the same source (CS ACNS.D.ADSB.025(b)).

The reference to the BDS registers is provided in order to facilitate a detailed understanding and traceability of ADS-B Out requirements at ADS-B transmit unit level, also in support of integration testing, as appropriate.

The relationship between the BDS registers and the ADS-B message Type Codes (first 5 bits in the 56-bit ADS-B message field) is thereby as shown in Table 4. The Type Code is used to differentiate between ADS-B message types (i.e. BDS registers). In addition, for Airborne and Surface Position Messages, the Type Code is used to encode the horizontal position integrity containment bounds (NIC). The Subtype Code is used to further differentiate between ADS-B messages of a certain type (e.g. Operational Status Message).

A number of service bulletins have been issued to rectify some observed deficiencies and have already been addressed by the equipment manufacturers. Therefore, the installed transponders should have all published corrective transponder equipment service bulletins (SB) relating to the correct operation of the ADS-B functionality embodied.

Table 4: BDS Register Overview

BDS Register	Type Code(s)	Subtype Code
05 ₁₆ – Airborne Position Message	0, 9-18, 20-22	n/a
06 ₁₆ – Surface Position Message	0, 5-8	n/a
08 ₁₆ - Aircraft Identification and Category Message	1, 2, 3 or 4	n/a
09 ₁₆ - Airborne Velocity Message Velocity over Ground (Normal/Supersonic)	19	1+2
61 ₁₆ - Aircraft Status Message Emergency Status and Mode A Code	28	1
61 ₁₆ - Aircraft Status Message ACAS RA Broadcast	28	2
62 ₁₆ - Target State and Status Message	29	1
65 ₁₆ – Aircraft Operational Status Message While Airborne	31	0
65 ₁₆ – Aircraft Operational Status Message On the Surface	31	1

Note: Although BDS registers 07₁₆ and 0A₁₆ are not conveying ADS-B data items their implementation is needed to complement the ADS-B protocol.

Table 5: Minimum ADS-B Out Surveillance Data Transmission Requirements

Item	Parameter	Requirements	BDS Register	Remarks
1	Aircraft Identification	See Definition 1	08 ₁₆	Same source as for Mode S replies
2	Mode A Code	See Definition 2	61 ₁₆	Same source as for Mode S replies Broadcast suppressed for conspicuity code '1000'
3	ICAO 24-bit aircraft address	Transmit ICAO 24-bit aircraft address	All BDS (AA field of DF17, bits 9-32)	Unique ICAO 24 bit aircraft address needs to be assigned by the responsible authority
4a	Airborne Horizontal Position – Latitude and Longitude	See Definition 3	05 ₁₆	
4b	Airborne Horizontal Position Quality: NIC	See Definition 4 and 5	05 ₁₆ Type Codes	Incl. NIC Supplements A (65 ₁₆) and B (05 ₁₆)
4c	Horizontal Position Quality: NACp	See Definition 4 and 6	62 ₁₆ and 65 ₁₆	
4d	Horizontal Position Quality: SIL	See Definition 4 and 7	62 ₁₆ and 65 ₁₆	Incl. SIL Supplement.
4e	Horizontal Position Quality: SDA	See Definition 4 and 8	65 ₁₆	
5	Pressure Altitude	See Definition 9	05 ₁₆	Same source as for Mode S replies Data associated with 'NICbaro' integrity indicator
6	Special Position Identification (SPI)	Setting as per ED-73E §2.5	05 ₁₆	Same source as for Mode S replies
7a	Emergency Status	See Definition 10	61 ₁₆ (subtype 1)	Same source as for Mode S replies (where defined for SSR)
7b	Emergency Indication	Setting as per ED-73E §2.5	05 ₁₆	Same source as for Mode S replies
8	1090 ES Version Number	To be set to 2 for ED-102A/DO-260B systems.	65 ₁₆	Value is fixed at the time the ADS-B transmit unit is manufactured.
9a	Airborne Horizontal Velocity (Ground Speed) - east/west and north/south	See Definition 11	09 ₁₆ (subtypes 1and2)	Same source as for SSR EHS replies

Item	Parameter	Requirements	BDS Register	Remarks
9b	Horizontal Velocity Quality: NACv	See Definition 12	09 ₁₆ (airborne) and 65 ₁₆ (subtype 1, surface)	
10	Emitter Category	See Definition 13	08 ₁₆	
11	Vertical Rate	See Definition 14	09 ₁₆ (subtypes 1and2)	Selected source is indicated in 09 ₁₆ source indication
12a	Surface Horizontal Position – Latitude and Longitude	Source see AMC ACNS.D.ADSB.070 See Definition 3	06 ₁₆	Quality indicators NACp, SIL, SDA: same encodings as for airborne horizontal position
12b	Surface Horizontal Position Quality: NIC	See Definition 15	06 ₁₆ Type Codes	Incl. NIC Supplements A and C (both 65 ₁₆)
13	Heading/Ground Track	See Definition 16	06 ₁₆	Heading preferred source
14	Movement (surface ground speed)	See Definitions 11 and 12	06 ₁₆	NACv: same as for airborne ground velocity (see 9b)
15	Length/width of Aircraft	See Definition 17	65 ₁₆ (subtype 1)	
16	GPS Antenna Offset	See Definition 18	65 ₁₆ (subtype 1)	Lateral and longitudinal
17a	Geometric Altitude	See Definition 19	09 ₁₆ (05 ₁₆)	In 09 ₁₆ reported as difference from Pressure Altitude
17b	Geometric Altitude Quality: GVA	See Definition 20	65 ₁₆ (subtype 0)	

Definition 1: Aircraft Identification Data Sources

Aircraft Identification is provided to the ADS-B transmit unit so that the information is identical to the filed ICAO flight plan. This information may be provided from, amongst others:

A flight management system; or

A pilot control panel; or

For aircraft, which always operate with the same aircraft identification (e.g. using registration as the aircraft identification), it may be programmed into equipment at installation.

In case no ICAO flight plan is filed, the Aircraft Registration is provided to the ADS-B transmit unit.

Definition 2: Mode A Code

Refer to AMC1 ACNS.D.ELS.015 for general guidance.

When the ADS-B transmit unit receives a Mode A Code containing the Mode S conspicuity code (1000), the broadcast of Mode A code information is stopped.

Note: The broadcast of the Mode A Code is provided as a transitional feature, e.g. to aid operation of legacy ATC automation systems that use Mode A Code for Flight Plan correlation. Entry of the Mode A Code of 1000 will disable the transmission of the Mode A Code, and, hence, reduce the overall 1090 ES transmission rate.

Definition 3: Horizontal Position Information

The Mode S Extended Squitter position format uses the Compact Position Reporting (CPR) algorithm to encode latitude and longitude efficiently into messages. The resulting messages are compact in the sense that several higher order bits which are normally constant for long periods of time, are not transmitted in every message.

The CPR technique enables a receiving system to unambiguously determine the location of the aircraft, and, hence, reconstruct the original information provided by the source. If required for integration testing purposes, detailed guidance on the CPR algorithm is provided in ED-102A/DO-260B.

A horizontal position data source provides position information for both the airborne and surface horizontal position data formats (i.e. registers 05₁₆ or 06₁₆, respectively), accordingly encoded by the ADS-B transmit unit depending on the aircraft airborne/surface state.

Definition 4: Horizontal Position Quality – NIC and NACp

The encoding of the NIC and NACp horizontal position quality indicators should be directly derived from the corresponding integrity and accuracy information as being reported by the selected horizontal position source (refer also to CS ACNS.D.ADSB.025(c)).

In case a measurement integrity failure has been indicated by the selected horizontal position source (e.g. bit 11 of ARINC label 130 for ARINC 743A compliant sources), both the NIC and NACp quality indicators will be set to invalid (zero), regardless of the indicated integrity containment bound (e.g. HPL).

Definition 5: Airborne NIC Value

NIC is reported so that surveillance applications, such as by ATC or other aircraft, may determine whether the reported horizontal position has an acceptable level of measurement integrity for the intended use. (Note that the NIC parameter is closely associated with the SIL quality metric.)

The NIC (and SIL) values are associated with a possible failure condition of the position measurement function and the detection thereof. For most ADS-B applications, the NIC (and SIL) values are the key horizontal position quality metrics on which the horizontal position data is determined to be of sufficient quality for its intended use. The NIC value is encoded on the respective horizontal position integrity containment radius as provided by the source.

The NIC values, including the NIC Supplements values, are encoded for airborne position messages as follows (R_c is the horizontal position integrity containment bound, typically HPL/HIL for GNSS systems):

Table 6: Airborne NIC Encoding

NIC Value	Radius of Containment (R_c)	Airborne		
		Airborne Position TYPE Code	NIC Supplement Codes	
			A	B
0	R_c unknown or $R_c \geq 37\,040$ m (20 NM)	0, 18 or 22	0	0
1	$R_c < 37\,040$ m (20 NM)	17	0	0
2	$R_c < 14\,816$ m (8 NM)	16	0	0
3	$R_c < 7\,408$ m (4 NM)	16	1	1
4	$R_c < 3\,704$ m (2 NM)	15	0	0
5	$R_c < 1\,852$ m (1 NM)	14	0	0
6	$R_c < 1\,111.2$ m (0.6 NM)	13	1	1
	$R_c < 926$ m (0.5 NM)	13	0	0
	$R_c < 555.6$ m (0.3 NM)	13	0	1
7	$R_c < 370.4$ m (0.2 NM)	12	0	0
8	$R_c < 185.2$ m (0.1 NM)	11	0	0
9	$R_c < 75$ m	11	1	1
10	$R_c < 25$ m	10 or 21	0	0
11	$R_c < 7.5$ m	9 or 20	0	0

Note: The minimum NIC values required for the ADS-B-RAD application can be found in Table , in Part 3 of Appendix A. They are met through the horizontal position source requirements defined in CS ACNS.D.ADSB.070.

Definition 6: NACp

NACp specifies the 95 % radial accuracy of the aircraft’s horizontal position information (latitude and longitude) derived from the position source’s accuracy output, typically the HFOM metric from GNSS based sources.

Whereas the NIC value is associated with a possible failure condition of the position measurement function, the NACp value describes the nominal performance of the measurement function in terms of horizontal position accuracy as provided by the source.

The NACp value is encoded as follows:

Table 7: NACp Encoding

Coding	95 % Horizontal Accuracy Bound
0	EPU \geq 18 520 m (\geq 10 NM)
1	EPU < 18 520 m (10 NM)
2	EPU < 7 408 m (4 NM)
3	EPU < 3 704 m (2 NM)
4	EPU < 1852 m (1 NM)
5	EPU < 926 m (0.5 NM)
6	EPU < 555.6 m (0.3 NM)
7	EPU < 185.2 m (0.1 NM)
8	EPU < 92.6 m (0.05 NM)
9	EPU < 30 m
10	EPU < 10 m
11	EPU < 3 m

Note: The minimum NACp values required for the ADS-B-RAD application can be found in Table , in Part 3 of Appendix A. This value is met through the horizontal position source requirements defined in CS ACNS.D.ADSB.070.

The NACp encoding is the same for airborne position messages and surface position messages.

Definition 7: SIL

The encoding of the horizontal position source integrity level (SIL) is based on the probability of the reported horizontal position exceeding the radius of containment defined by the NIC, without alerting, assuming no avionics faults. The SIL value is set as follows:

Table 8: SIL Encoding

SIL value	Probability of Exceeding the NIC Containment Radius
0	Unknown or $> 1 \times 10^{-3}$ per flight hour or per sample
1	$\leq 1 \times 10^{-3}$ per flight hour or per sample
2	$\leq 1 \times 10^{-5}$ per flight hour or per sample
3	$\leq 1 \times 10^{-7}$ per flight hour or per sample

Note: The minimum SIL value required for the ADS-B-RAD application can be found in Table , in Part 3 of Appendix A. This value is met through the horizontal position source requirements defined in CS ACNS.D.ADSB.070 (see also related AMC guidance).

Whereas SIL assumes that there are no system integrity failures, the SIL should consider the effects of a faulted signal-in-space.

For horizontal position sources compliant with CS ACNS.D.ADSB.070, the probability of exceeding a NIC radius of containment without alerting is based on a per hour rate. Hence, the SIL Supplement should be set to 'zero'. If based on per sample, the SIL Supplement would be set to 'one'.

The SIL encoding is the same for airborne position messages and surface position messages.

Definition 8: SDA

The encoding of the system design assurance level (SDA) is based on the failure condition that the entire ADS-B Out system, with respect to the horizontal position data and associated quality indicators, is designed to support.

The SDA value is encoded as follows:

Table 9: SDA Encoding

SDA value	Software & Hardware Design Assurance Level (see Note 1)	Corresponding System Integrity Level (see Note 2)
0	N/A	$> 1 \times 10^{-3}$ per flight hour or unknown (No Safety Effect)
1	D	$\leq 1 \times 10^{-3}$ per flight hour (Probable)
2	C	$\leq 1 \times 10^{-5}$ per flight hour (Remote)
3	B	$\leq 1 \times 10^{-7}$ per flight hour (Extremely Remote)

Note 1: Software Design Assurance per EUROCAE ED-12C (RTCA DO-178C). Airborne Electronic Hardware Design Assurance per EUROCAE ED-80 (RTCA DO-254).

Note 2: In line with the ADS-B-RAD requirements, the minimum value required for the horizontal position source is SDA=2 ().

The SDA encoding is the same for airborne position messages and surface position messages.

Definition 9: Pressure Altitude Data Sources

Refer to AMC1 ACNS.D.ELS.015 for guidance.

The ADS-B NICbaro quality indicator is encoded as follows:

Table 10: NICbaro Encoding

Coding	Meaning
0	The barometric altitude is based on a Gillham coded input that has not been cross-checked against another source of pressure altitude.
1	The barometric altitude is either based on a Gillham code input that has been cross-checked against another source of pressure altitude and verified as being consistent, or is based on a non-Gillham coded source.

Definition 10: Emergency Status

The provision of the Emergency Status values that do not have a corresponding Mode A Code value (see CS ACNS.D.ELS.015) denoting the other emergency conditions defined in 61₁₆, is optional. This applies to the decimal values 2, 3, 6 and 7 in Table 11.

Table 11: Emergency Status Encoding

Coding		Meaning
(Binary)	(Decimal)	
000	0	No Emergency
001	1	General Emergency
010	2	Lifeguard/medical Emergency
011	3	Minimum Fuel
100	4	No Communications
101	5	Unlawful Interference
110	6	Downed Aircraft
111	7	Reserved

Definition 11: Horizontal Velocity (Ground Velocity)

The horizontal velocity provides the rate at which an aircraft changes its horizontal position with a clearly stated direction.

Velocity data sources provide ground velocity vector information for both the airborne and surface velocity data transmit formats, allowing for the transmission of east/west and north/south velocity information (09₁₆), or velocity scalar (06₁₆, movement) and possibly ground track information² (06₁₆), respectively.

In case of a failure of the provision of ground velocity data, the ADS-B transmit unit will broadcast airspeed (and heading) information instead (using subtypes 3 or 4 of register 09₁₆).

2.Refer to Definition 16.

Definition 12: Horizontal Velocity Quality Indicator NACv

The NACv is an estimate of the accuracy of the horizontal geometric velocity data.

The NACv value is encoded as follows:

Table 12: NACv Encoding

Navigation Accuracy Category for Velocity		
NACv		
Coding		Horizontal Velocity Error (95 %)
(Binary)	(Decimal)	
000	0	Unknown or ≥ 10 m/s
001	1	< 10 m/s
010	2	< 3 m/s
011	3	< 1 m/s
100	4	< 0.3 m/s

The NACv encoding is the same for airborne position messages and surface position messages.

Definition 13: Emitter Category

Emitter Category settings describe the size and performance of an aircraft, primarily expressed with respect to its maximum take-off weight.

The Emitter Category value is encoded as follows:

Table 13: Emitter Category Encoding

ADS-B Emitter Category Set “A”	
Coding	Meaning
0	No ADS-B Emitter Category Information
1	Light (< 7 031 kg (15 500 lbs))
2	Small (7 031 to 34 019 kg (15 500 to 75 000 lbs))
3	Large (34 019 to 136 078 kg (75 000 to 300 000 lbs))
4	High-Vortex Large (aircraft such as B-757)
5	Heavy (> 136 078 kg (300 000 lbs))
6	High Performance (> 49 m/s ² (5g) acceleration and > 205 m/s (400 knots))
7	Rotorcraft

ADS-B Emitter Category Set “B”	
Coding	Meaning
0	No ADS-B Emitter Category Information
1	Glider / Sailplane
2	Lighter-than-Air
3	Parachutist / Skydiver
4	Ultralight / hang-glider / paraglider
5	Reserved
6	Unmanned Aerial Vehicle
7	Space / Trans-atmospheric vehicle

ADS-B Emitter Category Set “C”	
Coding	Meaning
0	No ADS-B Emitter Category Information
1	Surface Vehicle - Emergency Vehicle
2	Surface Vehicle - Service Vehicle
3	Point Obstacle (includes tethered balloons)
4	Cluster Obstacle
5	Line Obstacle
6 - 7	Reserved

ADS-B Emitter Category Set “D”	
Coding	Meaning
0	No ADS-B Emitter Category Information
1 - 7	Reserved

The ADS-B Emitter Category Sets A, B, C or D are identified by the Message Format TYPE Codes 4, 3, 2, and 1 respectively.

Note 1: A coding of ‘0’ within an Emitter Category Set is not allowed.

Note 2: The Emitter Category codes 1 to 5 in category set A are intended to advise other aircraft of the transmitting aircraft’s wake vortex characteristics, and not necessarily the transmitting aircraft’s actual maximum take-off weight. In case of doubt, the next higher aircraft category code should be used.

Definition 14: Vertical Rate

Vertical Rate is either the barometric or geometric rate at which the aircraft is climbing or descending, measured in feet per minute. The vertical rate is typically generated by an air data computer or GNSS position source, or equipment which blends barometric vertical rate with inertial vertical rate and/or GNSS vertical rate.

As the geometric vertical rate can be readily derived from the ADS-B Out position source, it is classified as a minimum requirement rather than an (effectively Mode S Enhanced Surveillance) conditional requirement.

Definition 15: Surface NIC Value

The Surface NIC value, including the NIC Supplement A and C values, is encoded as follows:

Table 14: Surface NIC Encoding

NIC Value	Radius of Containment (R _C)	Surface		
		Surface Position TYPE Code	NIC Supplement Codes	
			A	C
0	R _C unknown	0, 8	0	0
6	R _C < 1 111.2 m (0.6 NM)	8	0	1
	R _C < 555.6 m (0.3 NM)	8	1	0
7	R _C < 370.4 m (0.2 NM)	8	1	1
8	R _C < 185.2 m (0.1 NM)	7	0	0
9	R _C < 75m	7	1	0
10	R _C < 25m	6	0	0
11	R _C < 7.5m	5	0	0

Definition 16: Surface Heading/Ground Track

Aircraft Heading indicates the direction in which the nose of the aircraft is pointing. It should be used as the primary source and be expressed (in ME bit 54 in 65₁₆) as either true north ('0', preferred) or magnetic north ('1').

If an approved heading source is not available (or failed during operation), the Ground Track angle information from the selected ground velocity data source will be used instead by the ADS-B transmit unit for the determination of the direction of the horizontal velocity vector.

If the position source ground track is used and inaccurate below a certain ground speed, and the position source does not inhibit output of the ground track at these slower speeds, the installer should ensure that the ADS-B transmit unit has the capability to invalidate the ground track when the GNSS ground speed falls below a threshold specified by the position source manufacturer (e.g. 3.6 m/s (7 knots)).

Definition 17: Aircraft Length and Width

Aircraft Length and Width settings describe the aircraft dimensions by the width and length of a rectangle that is aligned parallel to the aircraft's heading. The aircraft's length is to be measured along its axis of symmetry (i.e. from nose to tail). The aircraft's width is to be measured from wing-tip to wing-tip.

The Aircraft Length and Width values are encoded as shown in Table 15 to be less than or equal to a respective upper bound length and width as expressed in the two right-side columns. The Length and Width Codes are based on a combined encoding of the actual length **and** width whereby the largest respective upper bound prevails. If the Aircraft or Vehicle is longer than 85 meters, or wider than 90 meters, then decimal Aircraft/Vehicle Length/Width Code 15 is used.

Table 15: Aircraft Length/Width Encoding

A/V - L/W Code (Decimal)	Length Code			Width Code 'ME' Bit 24	Upper-Bound Length and Width for Each Length/Width Code	
	'ME' Bit 21	'ME' Bit 22	'ME' Bit 23		Length (meters)	Width (meters)
0	0	0	0	0	No Data or Unknown	
1	0	0	0	1	15	23
2	0	0	1	0	25	28.5
3				1		34
4	0	1	0	0	35	33
5				1		38
6	0	1	1	0	45	39.5
7				1		45
8	1	0	0	0	55	45
9				1		52
10	1	0	1	0	65	59.5
11				1		67
12	1	1	0	0	75	72.5
13				1		80
14	1	1	1	0	85	80
15				1		90

Example: a powered glider with an overall length of 24 meters and wingspan of 50 meters would, normally, have a length code of '001'. However, since the wingspan exceeds 34 meters, it does not qualify for either Width subcategory of length category '001'. In line with its actual width, such an aircraft would be assigned a length code of '100' and width code of '1', meaning length less than 55 meters and width less than 52 meters.

Definition 18: GPS Antenna Offset (lateral and longitudinal)

GPS Antenna Offset information provides the position offset of the GNSS antenna used for the provision of horizontal position information.

Both a lateral distance of the GPS Antenna (from the longitudinal axis of the aircraft) and a longitudinal distance of the GPS Antenna (from the nose of the aircraft) are provided.

The accuracy of the information should be better than 2 meters, consistent with the data resolution.

The lateral and longitudinal GPS Antenna Offset values are encoded as follows:

Table 16: Lateral Axis GPS Antenna Offset Encoding

'ME' Bit (Message Bit)			Upper Bound of the GPS Antenna Offset Along Lateral (Pitch) Axis Left or Right of Longitudinal (Roll) Axis	
33 (65)	34 (66)	35 (67)		
0 = left 1 = right	Encoding		Direction	(meters)
	Bit 1	Bit 0		
0	0	0	LEFT	NO DATA
	0	1		2
	1	0		4
	1	1		6
1	0	0	RIGHT	0
	0	1		2
	1	0		4
	1	1		6

Supplementary Notes

Maximum distance left or right of aircraft longitudinal (roll) axis is 6 meters or 19.685 feet. If the distance is greater than 6 meters, then the encoding should be set to 6 meters.

The No Data case is indicated by encoding of 000 as above, while the ZERO offset case is represented by encoding of 100 as above.

The rounding should be performed to half of the resolution of the GPS antenna offset information, i.e. +/- 1 meter.

Table 17: Longitudinal Axis GPS Antenna Offset Encoding

'ME' Bit (Message Bit)					Upper Bound of the GPS Antenna Offset Along Longitudinal (Roll) Axis Aft From Aircraft Nose (meters)
36 (68)	37 (69)	38 (70)	39 (71)	40 (72)	
Encoding					
Bit 4	Bit 3	Bit 2	Bit 1	Bit 0	
0	0	0	0	0	NO DATA
0	0	0	0	1	Position Offset Applied by Sensor (see also Notes)
0	0	0	1	0	2
0	0	0	1	1	4
0	0	1	0	0	6
*	*	*	*	*	***
1	1	1	1	1	60

Supplementary Notes:

If the distance is greater than 60 meters, the encoding should be set to 60 meters.

Position Offset Applied by the Sensor applies to future cases where the antenna offset is compensated by the horizontal position source to the centre of the rectangle describing the aircraft's length and width (refer to Definition 17).

The encoding of the values from decimal '2' (only bit 1 one set to '1') to '31' (all five bits set to '1') is as follows: encoded binary value = offset [m] / 2 + 1 (e.g. an offset of 4 meters leads to a binary value of (4/2 + 1 = 3), i.e. Bits 0-1 equal '1' and Bits 2-4 equal '0').

Definition 19: Geometric Altitude

The geometric altitude is a measure of the aircraft's height above a geometric reference and is provided by a GNSS-based position source.

Both within 05₁₆ and 09₁₆, Geometric Altitude is provided as height above ellipsoid (HAE) in accordance with the WGS 84 coordinate system (AMC1 ACNS.D.ADSB.085(b)).

Definition 20: Geometric altitude quality indicator information (GVA)

The GVA parameter expresses the actual performance of the geometric altitude data source as valid at the time of applicability of the measurement.

The GVA value is encoded as follows:

Table 18: GVA Encoding

GVA Encoding (decimal)	95 % Accuracy (meters)
0	Unknown or > 150 meters
1	≤ 150 meters
2	≤ 45 meters
3	Reserved

APPENDIX H

Part 2 – ADS-B Out Surveillance Data Parameters (AMC1 ACNS.D.ADSB.020(b))

Table 19 below makes reference to the BDS register(s) that contain the various ADS-B Out surveillance data parameters. When Table 19 states Same source as for Mode S replies, reference is made to the requirement that the content of ADS-B broadcasts and Mode S replies that carry the same information and need to come from the same source (CS ACNS.D.ADSB.025(b)).

Guidance on the content of the various BDS registers and their relationship with the ADS-B message Type Codes is provided in Table 4 in part 1 of Appendix A.

Table 19: ADS-B-ADD Surveillance Data Transmission Requirements

Item	Parameter	Requirements	BDS Register	Remarks
1	Selected Altitude	See Definition 21.	62 ₁₆	Same source as for Mode S replies
2	Barometric Pressure Setting		62 ₁₆	
3a	ACAS Operational	See Definition 22.	62 ₁₆ and 65 ₁₆	
3b	Resolution Advisory (RA)		61 ₁₆ (subtype 2)	

Definition 21: Selected Altitude/Barometric Pressure Setting

Refer to AMC1 ACNS.D.EHS.015 (c) (1 and (c) (3) for detailed guidance.

Definition 22: ACAS Operational /Resolution Advisory (RA)

Refer to AMC1 ACNS.D.ELS.015 (f) for detailed guidance.

The data is populated from ACAS II systems if installed on the aircraft. Both parameters should be preset to 'zero' if an ACAS II system is not installed (refer to ADS-B transmit unit manufacturer instructions).

Appendix H

Part 3 – ADS-B Out Minimum Horizontal Position and Velocity Data Requirements

Table 20 provides a summary of the minimum horizontal position data requirements as specified in the defining ADS-B-RAD Safety and Performance Requirements/Interoperability document (ED-161).

Table 20: Minimum Horizontal Position and Velocity Data Quality Requirements

Quality Parameter	Requirement
Position Accuracy (NACp)	NACp≤185.2 m (0.1NM) (i.e. NACp≥7) for both 3 NM and 5 NM separation
Position Integrity Containment Radius (NIC)	3 NM Sep: NIC≤1 111.2 m (0.6 NM) (i.e. NIC≥6) 5 NM Sep: NIC≤1 852 m (1 NM) (i.e. NIC≥5)
Source Integrity Level (SIL)	SIL=3: 10 ⁻⁷ /flight-hour
System Design Assurance (SDA)	SDA=2: 10 ⁻⁵ /flight-hour - allowable probability level REMOTE (MAJOR failure condition, LEVEL C software and design assurance level)
Velocity Accuracy (NACv)	NACv≤10 m/s (i.e. NACv≥1)

Note 1: The requirement of NACp≤0.1NM in support of 3NM separation is based on the arguments produced in Annex B to ED-161 (ADS-B-RAD Safety and Performance Requirements/Interoperability Requirements Document).

Note 2: The SDA encoding of '2' (10⁻⁵/flight-hour) applies to individual components of the ADS-B Out system, i.e. 10⁻⁵/flight-hour for the ADS-B transmit unit and 10⁻⁵/flight-hour for the horizontal position and velocity source.

Note 3: ADS-B transmit units interfaced with a GNSS position source that is compliant with CS ACNS.D.ADSB.070 (and the related AMC guidance) should preset the SIL Supplement to 'zero'.

Note 4: If set as fixed value, NACv should be always 'one'. For quality indications that are dynamically provided by the velocity source, NACv should be 'one' or 'two'. There is currently no established guidance on establishing a NACv performance of 'three' or better.

This should be verified through appropriate tests, as follows. With respect to NIC and NACp testing, the ADS-B Out system installer should check for satellite shielding and masking effects if the stated performance is not achieved.

(a) Airborne & Surface NIC:

During testing under nominal GNSS satellite constellation and visibility conditions, the transmitted NIC value should be a minimum of 'six'.

(b) NACp:

During testing under nominal GNSS satellite constellation and visibility conditions, the transmitted NACp value should be a minimum of 'eight'.

In order to validate the correctness of the transmitted horizontal position, the aircraft should be positioned on a known location.

(c) SIL:

SIL is typically a static (unchanging) value and may be set at the time of installation if a single type of position source is integrated with the ADS-B transmit unit. SIL should be set based on design data from the position source equipment manufacturer. Installations which derive SIL from GNSS position sources compliant with CS ACNS.D.ADSB.070 should set the SIL to 'three'.

ADS-B transmit units interfaced with a GNSS position source that is compliant with CS ACNS.D.ADSB.070 (and the related AMC guidance) should pre-set the SIL Supplement to 'zero'.

(d) NACv:

If set as fixed value, NACv should be always 'one'. For quality indications that are dynamically provided by the velocity source, NACv should be 'one' or 'two'.

It is noted that there is currently no established guidance on establishing a NACv performance of 'three' or better.

Appendix H.

Part 4 – ADS-B Out Integrity and Continuity Requirements

CS ACNS.D.ADSB.100 and CS ACNS.D.ADSB.105 summarise, per data parameter, the integrity and continuity probability levels applicable to the ADS-B Out system.

In the first place, the ADS-B Out System installed in the aircraft needs to deliver data that satisfy the ADS-B-RAD airborne domain system safety and performance requirements in line with Section 3.4 of the ADS-B-RAD Safety and Performance Requirements/Interoperability standard ED-161.

As, for the purpose of framing the ADS-B-RAD operational safety assessment, the ADS-B-RAD airborne domain only comprises the horizontal position data source and the ADS-B transmit unit, including the interconnecting avionics, the data sources providing surveillance information other than horizontal position and velocity are assumed to operate as within today's SSR environment. Hence, in line with CS ACNS.D.ADSB.080, the related Mode S Elementary and Enhanced Surveillance requirements apply.

It is noted that the respective Mode S Elementary and Enhanced Surveillance requirements have to be understood within their given context, in particular taking into account applicable procedural mitigation means (e.g. as currently performed by means of the ICAO required controller-pilot verification procedure for pressure altitude reporting).

The ADS-B Out data parameters other than the ones addressed in the preceding paragraphs, need to satisfy comparable ADS-B-RAD requirements.

The specified integrity levels are required to adequately protect against the corruption of ADS-B Out surveillance data causing false or misleading information to be transmitted.

Although the direct effects to an aircraft of an ADS-B Out failure may be minor, the ADS-B Out information will be used by ATC and other ADS-B equipped aircraft, thus provisions that would allow for a reduction in failure probabilities and design assurance level, do not apply to the ADS-B Out system.

Appendix H

Part 5 – GNSS Position and Velocity Source Qualification

This part 5 of Appendix H provides guidance to GNSS equipment manufacturers on how to establish a qualification for these ADS-B specific requirements, i.e. beyond the demonstration of compliance to ETSO requirements. In the following, as appropriate, reference is made to the respective:

- ETSO material: ETSO-C129a (JTSO-C129a), ETSO-C196a, ETSO-C145()/146());
- EUROCAE/RTCA MOPS material: ED-72A, DO-208, DO-229D, DO-316 as well as DO-235B; and
- FAA AC material (AC 20-138C).

Note: ETSO-C145 refers to RTCA DO-229A, ETSO-C146 refers to RTCA DO-229B, ETSO-C145c/146c refers to RTCA DO-229D, and ETSO-C145()/146() refers to any of those revisions.

In addition to the ETSO minimum requirements, the requirements of this part need to be demonstrated unless this has been demonstrated as a declared non-ETSO function. It is expected that the required compliance demonstration is supplied by the position and velocity source manufacturer through a Declaration of Design and Performance (DDP), or an equivalent document.

(a) Horizontal Position Integrity (HPL)

Horizontal Position Integrity — AMC1 ACNS.D.ADSB.070(a).1.2(a)

Applicability: ETSO-C129a (JTSO-C129a)

GNSS equipment manufacturers should provide substantiation data showing that the equipment outputs latitude and longitude information that is referenced to the WGS-84 coordinate system.

GNSS equipment manufacturers should provide substantiation data showing that the equipment outputs a 10^{-7} /hr Horizontal Protection Limit (HPL, or equivalent) based on the RAIM algorithm meeting the ETSO-C129a (JTSO-C129a) Class A1, A2, B1, B2, C1, or C2 RAIM requirements.

Applicability: ETSO-C145()/146()

SBAS equipment certified under any revision of ETSO-C145 or ETSO-C146 is required to have several modes of operation depending on the availability of augmentation. For example, when operating in an augmented mode intended for LPV approach guidance, the position source may determine HPL based on a lateral error versus a horizontal error and an exposure time based on the duration of the approach versus flight hour (refer to Appendix J to RTCA DO229D for details).

If the position source outputs the HPL on lateral error and approach exposure time, it is possible that the ADS-B transmit function would need to inflate the HPL by 3 % in approach modes to ensure the integrity is appropriately bounded.

GNSS equipment manufacturers should provide information data to determine if the integrity output needs to be scaled (i.e., by applying an inflation factor). The same considerations apply to GBAS differentially-corrected position sources when in approach mode.

Integrity Fault – Time to Alert — AMC ACNS.D.ADSB.070(a).1.2(b)

Applicability: ETSO-C129a (JTSA-C129a)

For the horizontal position sources compliant with AMC ACNS.D.ADSB.070, it should be demonstrated, that a non-isolated GNSS satellite fault detected by the position source is properly passed to the ADS-B transmit unit within the allowable time to alert of 10 seconds, at any time.

With reference to the mode dependent time to alert in Table 3-5 of EUROCAE ED-72A section 3.2.1 (Table 2-1 of RTCA DO-208 Section 2.2.1.13.1), GNSS equipment manufacturers should provide information describing the equipment integrity fault output latency, along with interface instructions and/or any limitations for meeting the 10-second latency requirement of AMC1 ACNS.D.ADSB.070(a).1.2(b).

Note 1: The latency of reporting nominal ADS-B Quality Indicator changes, such as in response to changing GNSS satellite constellations or due to switching between position sources, is bounded by CS ACNS.D.ADSB.070(a).1.2(c) as well.

Note 2: ED-72A allows a provision to extend the Time to Alarm up to 30 seconds during en route phases of flight while for terminal and Non-Precision Approach the 10-second limit is applicable. For ADS-B Out, a time to alert of 10 seconds applies to any phases of flight.

Mode Output — AMC1 ACNS.D.ADSB.070(a).1.3

Applicability: ETSO-C129a (JTSA-C129a), ETSO-C196a, ETSO-C145()/146()

GNSS equipment manufacturers should provide instructions describing any equipment modes affecting the interpretation of horizontal position integrity output and how the position source outputs the mode indication.

As the minimum horizontal position integrity containment bound provided by non-augmented, as well as some specific augmented GNSS source, equipment is limited to 0.1 NM by design, the GNSS equipment manufacturer should present substantiation data whether the HPL output is limited or not, and provide proper instructions for the ADS-B Out system integration. If the GNSS source equipment does not limit the HPL, although it should do so by design, the ADS-B transmit unit limits the encoded NIC value to be equal to or less than 'eight'.

(b) Horizontal Position Accuracy (HFOM) — AMC ACNS.D.ADSB.070(a).1.2(d)

Applicability: ETSO-C129a, ETSO-C145, and ETSO-C146

Note 1: Compliance with RTCA/DO-229D is required by ETSO-C145c-C146c. ETSO-C145/-C146 may be acceptable by applications of a positive deviation.

Note 2: If in the following, reference is made in the qualification tests described in DO-229D, the equivalent material in DO-316 applies as well.

GNSS equipment manufacturers should provide substantiation data showing the equipment computes and outputs HFOM. The following criteria for an acceptable horizontal position output and its associated HFOM accuracy metric are recommended to be applied:

- (1) The horizontal position output should be calculated using the general least squares position solution of DO-229D Appendix J.1 (or any mathematically equivalent linear combination of range measurements). There is no restriction on the choice of the weight matrix W including non-weighted solutions; the use of the LNAV/VNAV, LP, LPV approach weight ($w_i = 1/\sigma_i^2$) is optional.
- (2) The horizontal position accuracy should be tested using the procedure of DO-229D Section 2.5.8.3. The σ_i^2 used to compute the variance d_{major}^2 should be greater or equal to the ones listed in DO-229D Appendix J when the equipment uses SBAS-provided integrity and greater or equal to the ones listed as an acceptable means for FDE-provided integrity in section DO-229D 2.1.2.2.2 when the equipment does not use SBAS-provided integrity. A fixed sigma of 33.3 m is considered a sufficient over-bound when using FDE-provided integrity. For equipment that uses SBAS-provided integrity, testing only in the highest mode attainable for its declared Operational Class as specified in the test itself is acceptable.
- (3) The accuracy metric should be greater or equal to $1.96 \sqrt{d_{\text{east}}^2 + d_{\text{north}}^2}$ or $2.45 d_{\text{major}}$ where d_{major} , d_{east} , and d_{north} are computed using the same σ_i employed during the horizontal accuracy test procedure. General certification substantiation data that the equipment meets this requirement is sufficient; no specific test is required.

Note 1: The scaling factors for the horizontal position accuracy metrics were rounded to 2 decimal places; there is no intention to prohibit the use of a more accurate number.

Note 2: The horizontal position accuracy metrics listed above are the standard metrics used to provide a minimum of 95 % containment (varying from 95 % to approximately 98.5 % for the horizontal metrics) under the assumption that a Gaussian distribution with a sigma of σ ; over-bounds the error of the range measurements. The use of a general least squares position solution (or mathematically equivalent) results in a joint Gaussian distribution for the components (North, East, Up) of the position error. Any accuracy metric that can be mathematically demonstrated to provide a minimum 95 % containment in the position domain under the Gaussian assumption is also acceptable.

(c) Horizontal Position Latency — AMC1 ACNS.D.ADSB.070(a).1.2(e)

Time of Measurement to Time of Applicability

Applicability: ETSO-C129a (JTSO-C129a)

The intent of this qualification is to ensure that position and related quality indicator information are related to the same time of applicability in a consistent manner.

Based on the particular receiver design, GNSS equipment manufacturers should use a manufacturer-defined test, and/or analysis to determine the latency between the time satellite measurements are collated for processing and the time the equipment calculates a filtered (impulse response) position solution. The equipment should meet a 500-millisecond time of measurement to time of applicability requirement and account for the impulse response of the position solution.

Note: Whilst CS ACNS.D.ADSB does not establish requirements on the time of measurement, the above qualification has been incorporated to ensure consistency with FAA AC 20-165A.

Time of Applicability to Time of Output

Applicability: ETSO-C129a (JTSO-C129a)

The GNSS equipment manufacturer should document the position source latency from time of applicability to time of position output. If this latency exceeds 0.4 seconds, it may not support the 1.5-second total ADS-B transmission latency at the aircraft level (refer also to AMC1 ACNS.D.ADSB.115).

Time Mark

Applicability: ETSO-C129a (JTSO-C129a), ETSO-C196a, ETSO-C145()/C146()

If the use of the time mark to reduce latency is implemented in the ADS-B Out system, GNSS equipment manufacturers should provide installation instructions describing how the time mark relates to the time of applicability of the position, velocity, and related quality indicator information.

(d) Horizontal Velocity Accuracy — AMC1 ACNS.D.ADSB.070(a).1.2(f)

Environmental Noise Test Conditions:

Applicability: ETSO-C129a, ETSO-C145()/C146() (JTSO-C145/C146)

For equipment that was not required to meet the environmental noise standard prescribed by DO-235B, the velocity tests in AC 20-138B, Appendix 4 use environmental noise test conditions that may cause the equipment to stop functioning, i.e. to lose satellite acquisition and tracking capability that causes the equipment to stop outputting velocity. Whilst this contributes to an ADS-B availability

issue for operators, this loss of function will not prevent the equipment from being used as an ADS-B velocity input, provided:

- (1) the equipment does not output misleading velocity information at or after the onset of the triggering interference levels; and

Note: A method to accomplish this is first running the test at the higher noise level to ensure there is no misleading velocity information at loss of function before running the complete test at the lower noise level.

- (2) the equipment manufacturer should state that the equipment meets the noise requirements in DO-235B.

If the above conditions are met, the velocity tests in Appendix 4 of AC 20-138B (see below for NACv=1 and NACv=2 cases) can be run using an interference level that does not cause the equipment to lose acquisition and tracking.

ADS-B Out system installations intending to support NACv = 1:

Applicability: ETSO-C129a (JTSS-C129a), ETSO-C196a, ETSO-C145()/146()

The GNSS equipment manufacturer should perform the velocity tests in Appendix 4 of AC 20-138B associated with NACv = 1 to substantiate the equipment's velocity output.

The GNSS equipment manufacturer should indicate that the equipment satisfies the requirements for NACv = 1 in the instructions for the ADS-B integration.

ADS-B Out system installations intending to support NACv = 2:

Applicability: ETSO-C129a (JTSS-C129a), ETSO-C196a, ETSO-C145()/146()

The GNSS equipment manufacturer should substantiate that the equipment dynamically outputs HFOMv and VFOMv and perform the velocity tests in AC 20-138C Appendix 4 associated with NACv = 1 and NACv = 2 to substantiate the equipment's velocity output.

The GNSS equipment manufacturer should indicate that the equipment satisfies the requirements for NACv = 2 in the instructions for ADS-B Out system integration.

Track Angle Validity:

Applicability: ETSO-C129a (JTSS-C129a), ETSO-C196a, ETSO-C145()/146()

Using test and/or analysis for substantiation data, GNSS manufacturers should provide instructions for the ADS-B Out system integrator indicating when the track angle 95 % accuracy, when derived from north/east velocity, exceeds plus/minus 'eight' degrees. It is acceptable for the instructions to state that the track angle does not meet the required accuracy below a specified speed.

Note 1: Track Angle Validity is only an issue at taxiing speeds. Thereby, only along-track acceleration (0.58g) and jerk (0.25g/sec) are assumed to apply.

Note 2: Use should be made of the test environment specified in Appendix 4 of AC 20-138B. The interference levels used to demonstrate velocity accuracy compliance can be used for true track angle validity testing as well.

(e) Geometric Altitude Accuracy (VFOM) — AMC ACNS.D.ADSB.085

Applicability: ETSO-C129a (JTSO-C129a), ETSO-C196a, ETSO-C145()/146()

GNSS equipment manufacturers should provide substantiation data showing if and how the equipment computes and outputs VFOM. If VFOM is output, the following criteria for an acceptable HAE-referenced geometric altitude output and its associated VFOM accuracy metric are recommended to be applied:

- (1) The HAE output should be calculated using the general least squares position solution of DO-229D Appendix J.1 (or any mathematically equivalent linear combination of range measurements). There is no restriction on the choice of the weight matrix W including non-weighted solutions; the use of the LNAV/VNAV, LP, LPV approach weight ($w_i = 1/\sigma_i^2$) is optional.
- (2) The HAE accuracy should be tested using the procedure of DO-229D Section 2.5.8.3. The σ_i^2 used to compute the variance d_U^2 should be greater or equal to the ones listed in DO-229D Appendix J when the equipment uses SBAS-provided integrity and greater or equal to the ones listed as an acceptable means for FDE-provided integrity in section 2.1.2.2.2.2 when the equipment does not use SBAS-provided integrity. A fixed sigma of 33.3 m is considered a sufficient over-bound when using FDE-provided integrity. For equipment that uses SBAS-provided integrity, testing only in the highest mode attainable for its declared Operational Class as specified in the test itself is acceptable.
- (3) The accuracy metric should be greater or equal to $1.96 d_U$ where d_U is computed using the same σ_i employed during the HAE accuracy test procedure. General certification substantiation data that the equipment meets this requirement is sufficient; no specific test is required.

For GPS equipment that outputs altitude references other than HAE whilst the overall ADS-B Out System meets AMC1 ACNS.D.ADSB.085(b), an equivalent data accuracy should be demonstrated.

Note 1: The scaling factors for the vertical position accuracy metrics were rounded to 2 decimal places; there is no intention to prohibit the use of a more accurate number.

Note 2: The vertical position accuracy metrics listed above are the standard metrics used to provide a minimum of 95 % containment (varying from 95 % to approximately 98.5 % for the vertical metrics) under the assumption that a Gaussian distribution with a sigma of σ_i over-bounds the error of the range measurements. The use of a general least squares position solution (or mathematically equivalent) results in a single Gaussian distribution for the components (North, East, Up) of the position error. Any accuracy metric that can be mathematically demonstrated to provide a minimum 95 % containment in the position domain under the Gaussian assumption is also acceptable.

Appendix H

Part 6 – Compliance Matrix BDS Register Fields

This part of Appendix H lists compliance matrices of the BDS register fields transmitted by the 1090 ES ADS-B transmit unit, with respect to the population of the 1090 ES data fields with data from approved sources (CS ACNS.D.ADSB.025(a) applies).

Omitted in the tables are fields containing the subtype codes (for these, refer to Part 1 of this Appendix) and reserved fields.

Reference to ADS-B Out item numbers is made in line with Part 1 of this Appendix respectively. Reference to Definitions is made in line with Part 1 of this Appendix.

Within the requirements (Req't) column, 'M' expresses a mandatory requirement, i.e. the respective fields are populated with data from approved sources. 'O' expresses an optional requirement, 'NA' expresses non-applicability and 'C' expresses a conditional requirement (requirement is mandatory provided that the condition expressed in the remark column is met).

In addition to the 1090 ES data fields (as specified by the respective 'ME' Bits conveyed within the downlink format DF 17), the 3-bit 'Capability (CA)' field, also conveyed within downlink format DF 17, should be populated for all below registers as follows:

DF 17 – CA Field

DF 17 bits	Field	Req't	Remark
6-8	Capability	M	Refer to ICAO Annex 10, Volume IV, section 3.1.2.5.2.2.1.

Register 05₁₆ – Airborne Position Message

ME Bits	Field	Req't	Remark
6-7	Surveillance Status	M	= '0', no condition information = '1', Item 7a, Definition 10 = '2', Mode A code change = '3', Item 6
8	NIC Supplement-B	M	Item 4b, Definition 4 and 5
9-20	Altitude	M	Item 5, Definition 9
21	Time (T)	M	"GNSS time mark coupled" ('0' no, '1' yes), Item 4a, Definition 3
22	CPR Format (F)	M	Compact Position Reporting (CPR) format type ('0' even, '1' odd), Item 4a, Definition 3
23-39	CPR Encoded Latitude	M	Item 4a, Definition 3
40-56	CPR Encoded Longitude	M	

Register 06₁₆ – Surface Position Message

ME Bits	Field	Req't	Remark
6-12	Movement	M	Item 14, Definitions 11 and 12
13	Heading/Ground Track Status	M	Item 13, Definition 15
14-20	Heading/Ground Track	M	
21	Time (T)	M	'GNSS time mark coupled' ('0' no, '1' yes), Item 4a, Definition 3
22	CPR Format (F)	M	Compact Position Reporting (CPR) format type ('0' even, '1' odd) , Item 4a, Definition 3
23-39	CPR Encoded Latitude	M	Item 4a, Definition 3
40-56	CPR Encoded Longitude	M	

Register 08₁₆ - Aircraft Identification and Category Message

ME Bits	Field	Req't	Remark
6-8	ADS-B Emitter Category	M	Item 10, Definition 13
9-56	Identification Characters #1-#8	M	6 bits per character, Item 1, Definition 1

Register 09₁₆ - Airborne Velocity Message - Velocity over Ground (Subtypes 1and2, Normal/Supersonic)

ME Bits	Field	Req't	Remark
6-8	Subtype	M	'0' normal, '1' supersonic
9	Intent Change Flag	O	Mode S protocol support, indication of new information in GICB registers 40 ₁₆ to 42 ₁₆
11-13	NAC _v	M	Item 9b, Definition 12
14	E/W Direction Bit	M	Item 9a, Definition 11
15-24	E/W Velocity	M	
25	N/S Direction Bit	M	
26-35	N/S Velocity	M	
36	Vertical Rate Source	M	Item 11, Definition 14
37	Vertical Rate Sign	M	
38-46	Vertical Rate	M	
49	Difference from Barometric Altitude Sign	M	Item 17a, Definition 19
50-56	Difference from Barometric Altitude	M	

Register 09₁₆ - Airborne Velocity Message - Airspeed (Subtypes 3 and 4, Normal/Supersonic)

ME Bits	Field	Req't	Remark
6-8	Subtype	M	'0' normal, '1' supersonic
9	Intent Change Flag	O	Mode S protocol support, indication of new information in GICB registers 40 ₁₆ to 42 ₁₆
11-13	NAC _v	O	Item 9b, Definition 12
14	Heading Status Bit	O	Item 9a, Definition 11
15-24	Heading	O	
25	Airspeed Type	O	
26-35	Airspeed	O	
36	Vertical Rate Source	M	Item 11, Definition 14
37	Vertical Rate Sign	M	
38-46	Vertical Rate	M	
49	Difference from Barometric Altitude Sign	M	Item 17a, Definition 19
50-56	Difference from Barometric Altitude	M	

Register 61₁₆ - Aircraft Status Message - Emergency Status and Mode A Code

ME Bits	Field	Req't	Remark
6-8	Subtype	M	= '1'
9-11	Emergency/Priority Status	M	Mandatory codes: '0', '1', '4' and '5', Item 7a, Definition 10
12-24	Mode A Code	M	Item 2, Definition 2

Register 61₁₆ - Aircraft Status Message - ACAS RA Broadcast

ME Bits	Field	Req't	Remark
5-8	Subtype	M	= '2'
9-22	Active Resolution Advisories	M	Item 20b, Definition 22
23-26	RACs Record	M	
27	RA Terminated	M	
28	Multiple Threat Encounter	M	
29-30	Threat Type Indicator	M	
31-56	Threat Identity Data	M	

Register 62₁₆ - Target State and Status Message

ME Bits	Field	Req't	Remark
6-7	Subtype	M	= '1'
8	SIL Supplement	M	Item 4d, Definition 4 and 7
9	Selected Altitude Type	C	Where available in a suitable format Item 18, Definition 21
10-20	MCP/FCU Selected Altitude or FMS Selected Altitude	C	
21-29	Barometric Pressure Setting	C	Where available in a suitable format Minus 800 millibars.
30	Selected Heading Status	O	not required by Commission Regulation (EU) No 1207/2011
31	Selected Heading Sign	O	
32-39	Selected Heading	O	
40-43	Navigation Accuracy Category Position (NAC _p)	M	Item 4c, Definition 4 and 6
44	Navigation Integrity Category Baro	M	Item 5, Definition 9
45-46	Source Integrity Level	M	Item 4d, Definition 4 and 7
47	Status of MCP/FCU Mode Bits	M	Item 18, Definition 21
48	Autopilot Engaged	O	
49	VNAV Mode Engaged	O	
50	Altitude Hold Mode	O	
52	Approach Mode	O	
53	TCAS Operational	M	Item 20a, Definition 22
54	LNAV Mode Engaged	O	Item 18, Definition 21

Register 65₁₆ – Aircraft Operational Status Message - While Airborne

ME Bits	Field	Req't	Remark
6-8	Subtype	M	= '0' (Airborne)
9-10	Airborne Capability Class Subtype	M	= '0,0'
11	TCAS Operational	M	Item 20a, Definition 22
12	1090 ES IN	O	not required by EU Regulation No 1207/2011
15	Air Referenced Velocity Report Capability	M	= '0', if aircraft is not capable of sending Airborne Velocity, Subtype 3 or 4 = '1', if yes
16	Target State Report Capability	M	= '1'
17-18	Trajectory Change Report Capability	M	= '0'
19	UAT IN	O	not required by EU Regulation No 1207/2011
25-26	Airborne Operational Mode Subtype	M	= '0,0'
27	TCAS RA Active	M	Item 20b, Definition 22
28	IDENT Switch Active	M	Item 6
30	Single Antenna Flag	M	= '0', see CS-ACNS.D.ADSB.040
31-32	System Design Assurance	M	Item 4e, Definition 4 & 8
41-43	MOPS Version Number	M	= '2'
44	NIC Supplement-A	M	Item 4b, Definition 4 & 5
45-48	NACP	M	Item 4c, Definition 4 & 6
49-50	GVA	M	Item 17b, Definition 20
51-52	Source Integrity Level	M	Item 4d, Definition 4 & 7
53	NICBaro	M	Item 5, Definition 9
54	Horizontal Reference Direction (HRD)	O	'0' true north, '1' magnetic north (Airborne Velocity, subtype 3 & 4)
55	SIL Supplement	M	Item 4d, Definition 4 & 7

Register 65₁₆ – Aircraft Operational Status Message - On the Surface

ME Bits	Field	Req't	Remark
6-8	Subtype	M	= '1' (Surface)
9-10	Surface Capability Class Subtype	M	= '0,0'
12	1090 ES IN	O	not required by Commission Regulation (EU) No 1207/2011
15	B2 Low	NA	not applicable (targeting at class B2 equipment, e.g. ground vehicles)
16	UAT IN	O	not required by Commission Regulation (EU) No 1207/2011
17-19	NAC _v	M	Item 9b, Definition 12
20	NIC Supplement C	M	Item 12b, Definition 15
21-24	Length/Width Codes	M	Item 15, Definition 17
25-26	Surface Operational Mode Subtype	M	= '0,0'
27	TCAS RA Active	M	Item 20b, Definition 22
28	IDENT Switch Active	M	Item 6
30	Single Antenna Flag	M	= '0', see CS ACNS.D.ADSB.040
31-32	System Design Assurance	M	Item 4e, Definition 4 and 8
33-40	GPS Antenna Offset	M	Item 16, Definition 18
41-43	MOPS Version Number	M	= '2'
44	NIC Supplement-A	M	Item 12b, Definition 15
45-48	NAC _p	M	Item 4c, Definition 4 and 6
51-52	Source Integrity Level	M	Item 4d, Definition 4 and 7
53	Track Angle/Heading	M	Item 9a, Definition 11
54	Horizontal Reference Direction (HRD)	M	'0' true north, '1' magnetic north Item 13, Definition 15
55	SIL Supplement	M	Item 4d, Definition 4 and 7

APPENDIX I — ON-THE-GROUND STATUS TEST AND VALIDATION GUIDANCE FOR AEROPLANES

The ADS-B Out system installer should verify that the air-ground status inputs (or algorithms) are functioning properly and that the ADS-B Out system transmits the appropriate airborne messages or surface messages based on the On-the-ground status. This can be accomplished with simulated inputs to the appropriate sensors or accomplished in conjunction with the flight test.

The following tests provide guidance to the aircraft integrator for the verification of the ADS-B Out system installation, as appropriate. Separate cases are presented depending on the need to validate the status within the ADS-B transmit unit.

- (a) Directly determined On-the-ground status being validated outside the ADS-B transmit function:

Modern aircraft with integrated avionics suites commonly contain sophisticated algorithms for determining the On-the-ground status based on multiple aircraft sensors. These algorithms are customised to the airframe and designed to overcome individual sensor failures. These algorithms are an acceptable means to determine the On-the-ground status and do not require additional validation.

- (b) Validation of directly determined On-the-ground status not being validated outside the ADS-B transmit function:

If ground speed **or** airspeed is larger than the aeroplane's typical rotation speed, then the On-the-ground status is (changed to) airborne and the airborne position message is broadcast irrespective of the directly determined On-the-ground status (i.e. as indicated to the ADS-B transmit function).

- (c) Indirectly determined On-the-ground status validation within the ADS-B transmit unit:

If an aircraft is not equipped with a means, such as a weight-on-wheels switch, to determine whether it is airborne or on the ground, then the following tests should be performed to determine whether to broadcast the Airborne or Surface Position Messages.

- (1) If the aircraft's radio height (RH) parameter is available, and RH is less than 15 m (50 feet), and at least ground speed (GS) or airspeed (AS) is available, and the GS or the AS are less than 51 m/s (100 knots), then that aircraft broadcasts the surface position message.

If all three parameters are available, the decision to broadcast the Airborne or Surface Position Messages is determined by the logical AND of all three parameters.

- (2) If radio height (RH) is not available, and if the aircraft's ground speed (GS) and airspeed (AS) are available, and $GS < 26$ m/s (50 knots) and $AS < 26$ m/s (50 knots), then that aircraft broadcasts the surface position message.

Otherwise, the aircraft broadcasts the Airborne Position Message.

On-the-ground status Test and Validation Guidance for Helicopters, Lighter-than-Air Vehicles and Fixed-under-Carriage Aeroplanes

Installations intended for this category that are unable to provide a compliant direct or indirect ground status detection function, should only broadcast the Airborne Position Message. In addition, the "CA" capability field in downlink format DF 17 should be set accordingly.

Appendix J — Comparison between EASA CS ACNS.D.ADSB and FAA AC 20-165A Requirements

CS ACNS.D.ADSB Reference	Comparison
CS ACNS.D.ADSB.001 Applicability	CS refers to Commission Regulation (EU) No 1207/2011, AC to FAA 14 CFR § 91.227.
CS ACNS.D.ADSB.010 ADS-B Out System Installation	CS addresses 1090 ES as the only ADS-B Out data link, AC UAT as well.
CS ACNS.D.ADSB.020 ADS-B Out Data Parameters	Parameters required by CS, optional for AC: GPS Antenna Offset. Parameters required by CS where available in suitable format, optional for AC: Vertical Rate and Selected Altitude. Parameters required by CS where available in suitable, not addressed by AC: Barometric Pressure Setting. Parameters not required by CS, required by AC: ADS-B In Capability. Parameters not addressed by CS, optional for AC: Selected Heading. All other parameters are required by both the CS and AC.
CS ACNS.D.ADSB.025 Provision of Data	No difference.
CS ACNS.D.ADSB.030 ADS-B Transmit Unit Installation	No difference.
CS ACNS.D.ADSB.040 Antenna Diversity	CS requires antenna diversity (as applicable to Commission Regulation (EU) No 1207/2011 aircraft). Within AC, single bottom-mounted antenna installations are allowed for ETSO-C166b classes A1S and B1S.
CS ACNS.D.ADSB.050 Transmit Power	No difference.
CS ACNS.D.ADSB.055 Simultaneous Operation of ADS-B Transmit Units	No difference.
CS ACNS.D.ADSB.060 On-the-ground Status Determination	No difference.
CS ACNS.D.ADSB.070 Horizontal Position and Velocity Data Sources	No difference overall. However, CS specifies ETSO-C129a as a minimum requirement (in line with Commission Regulation (EU) No 1207/2011).
CS ACNS.D.ADSB.080 Other Data Sources	No difference, as applicable to the common data parameters (see also 'CS ACNS.D.ADSB.020').
CS ACNS.D.ADSB.085 Geometric Altitude	No difference.

CS ACNS.D.ADSB Reference	Comparison
CS ACNS.D.ADSB.090 Flight Deck Interface	No difference.
CS ACNS.D.ADSB.100 Integrity	No difference, however, CS details requirements per data parameter.
CS ACNS.D.ADSB.105 Continuity	No requirement expressed in AC.
CS ACNS.D.ADSB.110 Horizontal Position and Velocity Data Refresh Rate	No difference.
CS ACNS.D.ADSB.115 Horizontal Position and Velocity Total Latency	CS uses time of applicability as a reference, AC time of measurement. In line with the AC recommendation that the difference between the two references should be less than or equal to 500ms, the total latency requirements are effectively the same (CS: 1.5s, AC 2.0s).
CS ACNS.D.ADSB.120 Horizontal Position Uncompensated Latency	No difference.
AMC1 ACNS.D.ADSB.010(b) Flight Test	AC requires a flight test, for any set of component part numbers of the ADS-B Out system on a given aircraft type.

Subpart E — Others

SECTION 1 – TERRAIN AWARENESS AND WARNING SYSTEM (TAWS)

GM1 ACNS.E.TAWS.001 Applicability

CS ACNS.TAWS airworthiness requirements are not suitable to allow the use of TAWS for navigation or for mitigation of navigation system failures.

AMC1 ACNS.E.TAWS.005 TAWS equipment approval

The Class A or Class B TAWS equipment should be approved in accordance with ETSO-C151b.

AMC1 ACNS.E.TAWS.010 Required functions

Note: An example of an acceptable TAWS installation is provided at Appendix 2.

- (a) For the voice call out a predetermined altitude of 150 m (500 ft.) has been found acceptable. However, another altitude may be allowed when a call-out at 150 m (500 ft.) would interfere with other operations.
- (b) For Class B equipment the predetermined altitude voice callout is based upon barometric height above runway elevation.

Note: The nearest runway elevation may be used for this purpose.

- (c) TAWS equipment may compute Barometric Altitude Rate using an Instantaneous Vertical Speed Indicator (IVSI) or an inertial smoothed vertical speed indicator. An alternative means, with demonstrated equal or better accuracy, may be used in lieu of barometric altitude rate (accuracy specified in ETSO-C10b, Altimeter, Pressure Actuated, Sensitive Type, or later revisions) and/or altimeter altitude (accuracy specified in ETSO-2C87 (Low range radio altimeters) - or later revisions) to meet the warning requirements described in RTCA Document No. DO-161A. In addition, ETSO-C106 for Air Data Computers may be used as an alternative means of compliance with this provision.
- (d) An interface with the accident data recording system to record alerts from the TAWS and to record, where practicable, when FLTA or PDA is inhibited.

Note 1: It is not necessary to be able to distinguish between the Basic GPWS and the new FLTA and/or PDA alerts from the recording. The voice recorder will be used for this purpose.

Note 2: Where the data recorded by the Flight Data Recorder is modified, the document which presents the information necessary to retrieve and convert the stored data into engineering units, will need to be amended by the operator.

AMC 2 ACNS.E.TAWS.010 Required functions

In case of descent the TAWS should provide an automatic call out when descending through a predefined altitude (typically 150 m (500 ft) above terrain or above the elevation of nearest runway).

For a Class B TAWS in order to compensate for the lack of ‘excessive closure rate to terrain’ function the predefined altitude should be 500ft.

AMC1 ACNS.E.TAWS.015 FLTA function requirements

- (a) The TAWS lateral search area should be less than the protected area defined by ICAO PANS OPS 8168, volume 2 to prevent nuisance alerts.

Note: The required obstacle (terrain) clearance (ROC) have been used to define the minimum requirements for obstacle/terrain clearance (RTC) appropriate to the FLTA function

- (b) As an alternate to the stepped down reduction from the terminal to approach phase in CS ACNS.E.TAWS.015 Table 1 , a linear reduction of the RTC as the aeroplane comes closer to the nearest runway is allowed, providing the requirements of CS ACNS.E.TAWS.015 Table 1 are met.
- (c) During the visual segment of a normal instrument approach (typically about 1850 m (1 NM) from the runway threshold), the RTC should be defined/reduced to minimise nuisance alerts.
- (d) The RTC values can be reduced slightly for descending flight conditions to accommodate the dynamic conditions and pilot response times.
- (e) The FLTA search volume should vary as a function of phase of flight, distance from runway, and the required terrain clearance.

GM1 ACNS.E.TAWS.020 PDA function requirements

The purpose of the PDA alert is to increase pilot’s awareness. Therefore ‘significantly below’ means the point below the profile where the pilot would normally initiate a Go Around (e.g. for ILS this would correspond to 1 dot deviation).

AMC1 ACNS.E.TAWS.025 Class A TAWS inhibition

- (a) An automatic inhibit capability is acceptable if it uses the information of the TAWS as a failure monitoring function.
- (b) If an automatic inhibition is provided and it automatically inhibits the FLTA alerts, PDA alerts and terrain display then the manual inhibit may be designed to only inhibit aural and visual alerts.
- (c) A separate guarded control should be provided to inhibit GPWS alerts based on flaps being other than the landing configuration.

AMC1 ACNS.E.TAWS.030 Terrain information display

- (a) Terrain data should be displayed in the normal field of view. Terrain that is more than 600 m (2000 ft.) below the aeroplane’s elevation need not be depicted.
- (b) If terrain alerting information is displayed on a weather radar, an Electronic Flight Instrument System display, or other compatible display system available on the flight deck, then the TAWS information should be displayed in a manner consistent with other information (e.g. range, colour coding, symbology).
- (c) When Auto-range switching is provided, an auto-ranging display should be designed so that it is evident to the flight crew that the range has been automatically selected. The range selected for

auto-ranging should clearly depict the threat on the display. Manual reversion to a selected range should be simple.

AMC1 ACNS.E.TAWS.035 Aural and visual alerts

- (a) The testing of the TAWS system integration within the aircraft should address the provision of the alerts listed in **Table 1** below. In addition to this minimum set, other implemented optional voice alerts should be tested.

Alert Condition	Caution	Warning
Ground proximity Altitude Loss after Take-off Class A & Class B equipment	<p>Visual Alert Amber text message that is obvious, concise, and must be consistent with the Aural message</p> <p>Aural Alert 'Don't Sink' and 'Too Low Terrain'</p>	<p>Visual Alert None required</p> <p>Aural Alert None Required</p>
Ground Proximity Envelope 1 (Not in Landing Configuration) Class A equipment	<p>Visual Alert Amber text message that is obvious, concise, and must be consistent with the Aural message</p> <p>Aural Alert 'Too Low Terrain' and 'Too Low Gear'</p>	<p>Visual Alert None required</p> <p>Aural Alert None Required</p>
Ground Proximity Envelope 2 Insufficient Terrain Clearance (Landing and Go around configuration) Class A equipment	<p>Visual Alert Amber text message that is obvious, concise, and must be consistent with the Aural message</p> <p>Aural Alert 'Too Low Terrain' and 'Too Low Flaps'</p>	<p>Visual Alert None required</p> <p>Aural Alert None Required</p>
Ground Proximity Envelope 4C Insufficient Terrain Clearance (Take-off configuration) Class A equipment	<p>Visual Alert Amber text message that is obvious, concise, and must be consistent with the Aural message</p> <p>Aural Alert 'Too Low Terrain'</p>	<p>Visual Alert None required</p> <p>Aural Alert None Required</p>
Ground Proximity Excessive Glide Slope or Glide Path Deviation Class A equipment	<p>Visual Alert Amber text message that is obvious, concise, and must be consistent with the Aural message</p> <p>Aural Alert 'Glide Slope'</p>	<p>Visual Alert None required</p> <p>Aural Alert None Required</p>
Ground Proximity Advisory Voice Call Out	<p>Visual Alert None Required</p>	<p>Visual Alert None required</p>

Alert Condition	Caution	Warning
Class A & Class B equipment	<p><u>Aural Alert</u> ‘Five Hundred’</p>	<p><u>Aural Alert</u> None Required</p>
<p>Reduced Required Terrain Clearance Class A & Class B equipment</p>	<p><u>Visual Alert</u> Amber text message that is obvious, concise, and must be consistent with the Aural message</p> <p><u>Aural Alert</u> Minimum selectable Voice Alerts: ‘Caution, Terrain; Caution, Terrain’ and ‘Terrain Ahead; Terrain Ahead’</p>	<p><u>Visual Alert</u> Red text message that is obvious, concise and must be consistent with the Aural message</p> <p><u>Aural Alert</u> Minimum selectable Voice Alerts: ‘Caution, Terrain; Terrain; Pull-Up, Pull-Up’ and ‘Terrain Ahead, Pull-Up; Terrain Ahead, Pull-Up’</p>
<p>Imminent Impact with Terrain Class A & Class B equipment</p>	<p><u>Visual Alert</u> Amber text message that is obvious, concise, and must be consistent with the Aural message</p> <p><u>Aural Alert</u> Minimum selectable Voice Alerts: ‘Caution, Terrain; Caution, Terrain’ and ‘Terrain Ahead; Terrain Ahead’</p>	<p><u>Visual Alert</u> Red text message that is obvious, concise and must be consistent with the Aural message</p> <p><u>Aural Alert</u> Minimum selectable Voice Alerts: ‘Caution, Terrain; Terrain; Pull-Up, Pull-Up’ and ‘Terrain Ahead, Pull-Up; Terrain Ahead, Pull-Up’</p>
<p>Premature Descent Alert (PDA) Class A & Class B equipment</p>	<p><u>Visual Alert</u> Amber text message that is obvious, concise, and must be consistent with the Aural message</p> <p><u>Aural Alert</u> ‘Too Low Terrain’</p>	<p><u>Visual Alert</u> None required</p> <p><u>Aural Alert</u> None Required</p>
<p>Ground Proximity Envelope 1, 2 or 3 Excessive Descent Rate Class A & Class B equipment</p>	<p><u>Visual Alert</u> Amber text message that is obvious, concise, and must be consistent with the Aural message</p> <p><u>Aural Alert</u> ‘Sink Rate’</p>	<p><u>Visual Alert</u> Red text message that is obvious, concise and must be consistent with the Aural message</p> <p><u>Aural Alert</u> ‘ Pull-Up’</p>
<p>Ground Proximity Excessive Closure Rate (Flaps not in Landing Configuration) Class A equipment</p>	<p><u>Visual Alert</u> Amber text message that is obvious, concise, and must be consistent with the Aural message</p> <p><u>Aural Alert</u> ‘Terrain- Terrain’</p>	<p><u>Visual Alert</u> Red text message that is obvious, concise and must be consistent with the Aural message</p> <p><u>Aural Alert</u> ‘ Pull-Up’</p>

Alert Condition	Caution	Warning
Ground Proximity Excessive Closure Rate (Landing Configuration) Class A equipment	<p>Visual Alert Amber text message that is obvious, concise, and must be consistent with the Aural message</p> <p>Aural Alert 'Terrain- Terrain'</p>	<p>Visual Alert None required</p> <p>Aural Alert ' Pull-Up' - for gear up None required - for gear down</p>

TABLE 1: Visual and aural alerts

- (b) If a two tone sweep ('Whoop Whoop') is used then the complete cycle of the two tone sweeps plus annunciation may be extended from '1.4' to '2' seconds.
- (c) Note: GPWS alerting thresholds may be adjusted or modified to be more compatible with the FLTA alerting functions and to minimize GPWS nuisance alerts.
- (d) Parameters such as airspeed, groundspeed barometric altitude rate should be included in the logic that determines basic GPWS alerting time.
- (e) GPWS alerting thresholds may be adjusted or modified to be more compatible with the FLTA alerting functions and to minimize GPWS nuisance alerts.
- (f) Consideration should be given to presenting voice announcements at a pre-set level via headsets when they are in use.

AMC1 ACNS.E.TAWS.055 Terrain and airport information

Terrain data used for the generation of the TAWS terrain database should be compliant with EUROCAE ED-98 () – User Requirements for Terrain and Obstacle Data. Similarly airport and runway data terrain used for the generation of the TAWS airport database should be compliant with EUROCAE ED-77 () – Standards for Aeronautical Information. Generation of the TAWS terrain database and of the TAWS airport database should be compliant with EUROCAE ED-76 () – Standards for Processing Aeronautical Information.

Note: Other technologies could be considered to provide the required terrain and airport information.

The manufacturer of the TAWS system should present the development and methodology used to validate and verify the terrain and airport information and, if relevant, obstacle information in compliance with EUROCAE ED-76/RTCA DO-200A.

AMC1 ACNS.E.TAWS.060 Positioning information

- (a) The TAWS positioning information can be generated internally to the TAWS (e.g. GPS receiver) or acquired by interfacing to other installed avionics on the aeroplane (e.g. FMS).
 - (1) For Class A TAWS an RNAV system may be used as an aeroplane horizontal position sensor provided that:
 - it has been approved for navigation in accordance with ETSO-C115() or ETSO-C129a or ETSO-C145() or ETSO-C146() or ETSO-C196a; or
 - it satisfies FAA AC 20-138 or FAA AC 20-130A.

- (2) For Class A and B TAWS a GNSS sensor may be used as an aeroplane horizontal position sensor provided that it is compliant with ETSO-C196 or ETSO-C145.

Note: For TAWS relying on GNSS sensor, the TAWS design should consider the use of other horizontal position sensors to ensure TAWS availability in case of GNSS failures.

- (3) Equipment that uses a GNSS internal to the TAWS for horizontal position information, and that are capable of detecting a positional error that exceeds the appropriate alarm limit for the particular phase of flight in accordance with ED-72A is considered acceptable.

- (4) Vertical position for TAWS may come from a barometric source such as an altimeter or an air data computer, or from a geometric source, such as GNSS provided that:

- the barometric altitude equipment is approved in accordance with ETSO-C106 Air data computer or ETSO-C10b Altimeter, Pressure Actuated, Sensitive Type;
- the radio altimeter equipment is approved in accordance with ETSO-2C87 Low-Range Radio Altimeter;
- the vertical velocity equipment is compliant with ETSO-C8 Vertical Velocity Instruments or ETSO-C105 Air Data Computer;
- the GNSS equipment is approved in accordance with:
 - ETSO-C129a, Airborne Supplemental Navigation Equipment Using Global Positioning System (GPS); or
 - ETSO-C145, Airborne Navigation Sensors Using the Global Positioning System Augmented by the Satellite Based Augmentation System; or
 - ETSO-C146, Stand-Alone Airborne Navigation Equipment Using the Global Positioning System Augmented by the Satellite Based Augmentation System.

Note: TAWS should mitigate potential vertical positioning source inaccuracies by appropriate blending of available vertical position information.

- (b) When the GPS alert limit is activated, the GPS computed position is considered unsuitable for TAWS, and a TAWS unsuitability indication should be given.
- (c) Geometric altitude should be enabled if the system has the facility.

AMC1 ACNS.E.TAWS.075 Prioritisation schemes

TAWS prioritisation schemes should be compliant with the content of Table 2:

Priority	Description	Alert Level	Comments
1	Reactive Windshear Warning	W	
2	Sink Rate Pull-Up Warning	W	Continuous
3	Excessive Closure Pull-Up Warning	W	Continuous
4	RTC Terrain Warning	W	
5	V1 Callout	A	
6	Engine Fail Callout	W	
7	FLTA Pull-Up Warning	W	Continuous
8	PWS Warning	W	
9	RTC Terrain Caution	C	Continuous
10	Minimums	A	
11	FLTA Caution	C	7 s period
12	Too Low Terrain	C	
13	PDA 'Too Low Terrain' Caution	C	
14	Altitude Callouts	A	
15	Too Low Gear	C	
16	Too Low Flaps	C	
17	Sink Rate	C	
18	Don't Sink	C	
19	Glideslope	C	3 s period
20	PWS Caution	C	
21	Approaching Minimums	A	
22	Bank Angle	C	
23	Reactive Windshear Caution	C	
Mode 6	TCAS RA ('Climb', 'Descent', etc)	W	continuous
Mode 6	TCAS TA ('Traffic, Traffic')	C	Continuous

TABLE 2: Alert Prioritization Scheme

Note 1: These alerts can occur simultaneously with TAWS voice callout alerts.

Note 2: W= Warning, C= Caution, A= Advisory.

TAWS internal priority alerting scheme should be compliant with the content of Table 3 below

Priority	Description
1	Sink Rate Pull-Up Warning
2	Terrain Awareness Pull-Up warning
3	Terrain Awareness Caution
4	PDA 'Too Low Terrain' Caution
5	Altitude Callouts '500'
6	Sink Rate
7	Don't Sink (Mode 3)

TABLE 3: TAWS Internal Alert Prioritization Scheme

AMC1 ACNS.E.TAWS.080 Pop-up mode

For dual displays installations, when an automatic pop-up mode is provided, the pop-up function should be inhibited if terrain is already presented on at least one display.

If TAWS and the Predictive Windshear System share the same display and an automatic pop-up function is employed, the display priorities indicated in Table 4 are recommended:

Priority	Description
Highest	Terrain Awareness Warning
	Predictive Windshear Warning
	Terrain Awareness Caution
	Predictive Windshear Caution
	Normal Terrain Display
Lowest	Weather Radar Display

TABLE 4: Alert display priorities

If the TAWS system provides alerting for obstacle threats, the priority for warning and cautions should be the same as those for terrain.

APPENDIX A: TAWS INSTALLATIONS TESTING GUIDANCE MATERIAL

General Testing:

- (a) Most of the testing of a TAWS installation can be achieved by ground testing that verifies system operation, interfaces between affected aeroplane systems, correct warning prioritisation, and freedom from unwanted interaction or interference.
- (b) The use of the TAWS as an integrated part of the aeroplane flight deck should be demonstrated. The TAWS should be shown to be compatible with the operation of the installed navigation systems, the airborne collision and avoidance system (ACAS), the windshear warning system, and the weather radar.
- (c) The tests should evaluate the effects of sensor failure on TAWS operation.
- (d) Flight testing should be carried out to evaluate overall operation, compatibility of TAWS with warning systems, navigation systems, and displays, freedom from unwanted interference, and to assess, during adverse flight conditions, instrument visibility, display intelligibility, sound levels and intelligibility of voice announcements, and the effects of electrical transients.
- (e) Adequate flight testing to evaluate the terrain display can be conducted while verifying all the other required TAWS functions. Emphasis could be placed on showing compliance with CS ACNS.E.TAWS requirements during normal aeroplane manoeuvres for all phases of flight. Pop-up and auto-ranging features could be evaluated if applicable. Sustained turns could be performed, to evaluate for example symbol stability, flicker, jitter, display update rate, readability, the use of colour to depict relative elevation data, caution and warning alerts, and overall suitability of the display.

GPWS Testing:

- (a) Flight testing to verify the proper operation of Basic GPWS functions can be conducted in any area where the terrain elevation is known to the flight crew. The following information provides an example of guidance for conducting flight tests to verify the proper operation of each GPWS function.
 - (1) *Excessive Rate of Descent.* Descents toward near level terrain are recommended if they provide the best results and ease of correlation with designed Mode 1 envelopes. This test verifies the operation of barometric altitude (and the corresponding computation of barometric altitude rate) and radio altitude.
 - (2) *Excessive Closure Rate To Terrain.* It is recommended that one level test run at an altitude between 150 m (500 ft.) and 300 m (1000 ft.) above the terrain elevation be conducted. This test will verify the proper installation of the radio altimeter.
 - (3) *Negative Climb Rate or Altitude Loss After take-off.* If it is adequate this test can be conducted immediately after take-off before climbing above 700 AGL or above runway elevation. This test verifies the proper operation of barometric altitude, barometric altitude rate and radio altitude.

- (4) *Flight Into Terrain When Not In Landing Configuration.* If it is adequate this test can be conducted while *on* a visual approach to a suitable runway. This test verifies the proper installation of barometric altitude, barometric altitude rate and radio altitude as well as the gear and flap sensor inputs to TAWS.
- (5) *Excessive Downward Deviation from a glide slope or glide path.* These tests should be conducted, as applicable, during:
 - (i) an ILS approach to verify the proper operation of the ILS glide slope input to TAWS;
 - (ii) an RNP approach to LPV minima to verify the proper operation of the glide path input from the GNSS receiver or FMS to the TAWS;
 - (iii) a GBAS approach to verify the proper operation of the GBAS glide path input to TAWS.
- (6) *Voice Callout 'Five Hundred ft.* This test should be conducted during an approach to a suitable runway in order to verify the proper operation of barometric altitude and/or radio altitude.
- (7) *Go-around.* This test can be performed to confirm that nuisance alerts do not occur during normal go-around manoeuvres.

FLTA Testing:

- (a) Flight testing to verify the proper operation of the FLTA function can be conducted in an area where the terrain elevation for the test runs is known within approximately 90 m (300 ft.). Two test runs can be performed:
 - (1) In level flight at approximately 150 m (500 ft) above the terrain of interest.
 - (2) While descending toward the terrain of interest.
- (b) In each test case, the terrain display, the aural and visual alerts, the navigation source input, and the terrain data base can each be evaluated if necessary. Confirmation that the specific terrain cells do generate the required alert can also be evaluated if necessary.

Note: To conduct the test as described, the chosen terrain could be for example at least 28 Km (15 NM) away from the nearest airport. If this is not practical, the fly-over altitude will have to be lowered, for example to 90 m (300 ft.) or less above the terrain in order to generate a TAWS alert.

PDA Testing:

- (a) Flight testing to verify the proper operation of the PDA function can be conducted in any airport area within an adequate distance of the nearest runway for example, 18.5 Km (10 NM). The aeroplane should be configured for landing at an adequate height for example, 450 m (1500 ft.) AGL, along the final approach segment of the runway at an adequate distance from the runway, for example, 18.5 Km (10 NM).
- (b) At a suitable point, a normal flight path angle descent, for example, three degrees can be initiated and maintained until the PDA alert occurs. This test may exercise also, if necessary the 500 ft. voice callout.

The adequacy of the PDA aural alert should be verified during this test. If necessary, this test could verify the adequacy of the airport data base, the navigation source input and the barometric and/or radio altitude inputs to TAWS.

Note: The area in the vicinity of the runway selected for this test should be relatively free from terrain and obstacles to preclude activation of the FLTA function. Approximately level terrain along the final approach segment will exercise the PDA function.

- (c) Flight tests should be conducted to verify that conditions at 300 m (1 000 ft) AGL within 18.5 – 28 Km (10 -15 NM) of the nearest airport the TAWS system does not generate alerts.

APPENDIX B: EXAMPLE OF AN ACCEPTABLE TAWS INSTALLATION

An example of an acceptable installation is a single approved TAWS comprising the following components or inputs:

- (a) A single terrain awareness and warning computer.
- (b) A single radio altimeter sensor.
- (c) A single air data system.
- (d) An ILS/GBAS/SBAS/MLS/MMR receiver for Class A TAWS only.
- (e) An interface with the landing gear and flaps.
- (f) A roll attitude sensor.
- (g) An accurate source of aeroplane position e.g. Flight Management System (FMS), or a Global Positioning System (GPS) or both.
- (h) Where operations are reliant on the use of QFE, an adequate means of determining the altitude should be provided.
- (i) A terrain data base covering the expected region of normal operations, together with a means of updating the stored data and to check its validity (by effective date and geographical region).
- (j) A terrain awareness display.
- (k) A loudspeaker for voice announcements.
- (l) Consideration should be given to presenting voice announcements via headsets at a preset level particularly where active noise-reducing or noise cancelling headsets are used.
- (m) Indication of TAWS and sensor failures.
- (n) Indication that the TAWS is operating in Basic GPWS mode only.
- (o) A means to initiate the TAWS self-test function on the ground.
- (p) An interface with the flight recording system to record TAWS alerts and inhibition of FLTA or PDA functions.
- (q) Indication to the flight crew where geographical regions of operation or other factors which adversely affect system performance to the extent that the TAWS may be potentially misleading and should not be relied up. If this indication is not practicable, a flight crew procedure may be used to determine whether the navigation system accuracy is acceptable for continued use of the TAWS.
- (r) A means for the flight crew to inhibit the FLTA and PDA functions together with appropriate annunciation of the inhibited condition.
- (s) A display with a means for the flight crew to select or deselect the terrain information. An automatic pop-up mode may be used with a simple means to deselect the terrain information after an automatic pop-up.

APPENDIX 3 — BACKGROUND INFORMATION FOR TERRAIN AWARENESS AND WARNING SYSTEM (TAWS)

(a) General

This appendix provides additional references, background information, and guidance for maintenance testing, as appropriate to TAWS installations.

(b) Related References

(1) EASA

- (i) ETSO-C151b Terrain Awareness and Warning System (TAWS) dated 18/12/2007
- (ii) ETSO-C92c Ground Proximity Warning, Glide Slope Deviation Alerting Equipment dated 24/10/2003
- (iii) ETSO-C10b Aircraft Altimeter, Pressure Actuated, Sensitive Type dated 24/10/2003
- (iv) ETSO-2C87 Low Range Radio Altimeters dated 24/10/2003
- (v) ETSO-C106 Air Data Computer dated 24/10/2003
- (vi) ETSO –C115b Airborne Area Navigation Equipment using Multi-Sensor Inputs dated 24/10/2003
- (vii) ETSO-C129a Airborne Supplemental Navigation Equipment Using Global Positioning System (GPS) dated 24/10/2003
- (viii) ETSO-C145 Airborne Navigation Sensors Using the Global Positioning System (GPS) Augmented by the Wide Area Augmentation System (WAAS) dated 24/10/2003 – ETSO-C145c Airborne Navigation Sensors Using the Global Positioning System Augmented by the Satellite Based Augmentation System (SBAS) dated 21/12/2010
- (ix) ETSO–C146 Stand-Alone Airborne Navigation Equipment Using the Global Positioning System (GPS) Augmented by the Wide Area Augmentation System (WAAS) dated 24/10/2003 – ETSO-C146c Stand-Alone Airborne Navigation Equipment Using the Global Positioning System Augmented by the Satellite Based Augmentation System (SBAS) dated 21/12/2010
- (x) ETSO-C196a Airborne Supplemental navigation Sensors for Global Positioning System Equipment Using Aircraft-Based Augmentation dated 05/07/2012
- (xi) ETSO-C105 Optional Display Equipment for Weather and Ground Mapping Radar Indicators dated 24/10/2003

(2) ICAO

Doc 8168 Aircraft Operations Procedures for Air Navigation Services Fifth edition – 2006 Volume II Construction of Visual and Instrument Flight Procedures

(3) EUROCAE

- (i) ED-98 () User requirements for Terrain and Obstacle Data (any edition - last edition B dated September 2012)
- (ii) ED-76 Standards for processing aeronautical data dated October 1998 (identical to RTCA DO-200A)

(4) RTCA

DO-161A Minimum Performance Standards-Airborne Ground Proximity Warning Equipment dated 27/05/1976

SECTION 2 – REDUCED VERTICAL SEPARATION MINIMUM (RVSM)

AMC1 ACNS.E.RVSM.001 Applicability

Previous airworthiness certification against JAA TGL6 is an acceptable means of compliance for the RVSM system.

AMC1 ACNS.E.RVSM.005 RVSM system

- (a) When Static Source Error Corrections (SSEC) are required they should be embedded within the altimetry system.

Note: The design aim for SSEC is to correct for the residual static source error, compatible with the RVSM performance requirements.

- (b) For RVSM systems with SSEC, an equivalent SSEC should be applied to the altitude control signal.

AMC1 ACNS.E.RVSM.010 Required functions

The signal representing the altitude alerting system may be used either directly, or combined with other sensor signals. The signal may be an altitude deviation signal, relative to the selected altitude, or a suitable absolute altitude signal.

AMC1 ACNS.E.RVSM.030 RVSM system performance requirement

If the design and characteristics of the aircraft and its altimetry system are such that the performance requirements are not satisfied by the location and geometry of the static sources alone, then suitable Static Source Error Corrections should be applied automatically within the altimetry system.

AMC1 ACNS.E.RVSM.035 Altimetry system accuracy

To demonstrate the compliance with ASE performances the following steps should be performed:

- (a) Group determination:
- (1) Aircraft should have been constructed to a nominally identical design and be approved on the same Type Certificate (TC). Aircraft modified to a TC amendment, or by a Supplemental TC may be considered as part of the same group providing that all height keeping performance characteristics as described in the following paragraphs remain the same.
 - (2) The static system of each aircraft should be nominally identical. The Static Source Error and any applied SSE Corrections should be the same for all aircraft of the group. Differences affecting factors that contribute to the Static Source Error (see Appendix A, Table 1), that effect RVSM performances and accuracy should be demonstrated as negligible.
 - (3) The operational flight envelope should be the same.
 - (4) The avionics units installed on each aircraft to meet the minimum RVSM performance requirements should demonstrate equivalent height keeping system performance in relation to; altitude control, altitude reporting and the interface to the altimetry system sensors. Altimetry system integrity should be the same with equivalent reliability, degradation and failure rates.

If an airframe does not meet the conditions above to qualify as a member of a Group, or is presented as an individual airframe for approval, then it will be considered as a non-group aircraft for the purposes of RVSM approval.

(b) RVSM Flight envelopes boundaries (Full and Basic)

The RVSM full flight envelope boundaries should be defined based on the RVSM airspace and aircraft or group aircraft characteristics as summarised in Table 1.

The RVSM basic envelope boundaries are similar to the ones of the full flight envelope, however, the upper Mach boundary may be lower than the one of the full flight envelope but not be less than the Long Range Cruise Mach Number plus 0.04 Mach, unless limited by available cruise thrust, buffet or other flight limitations. This reduction in upper Mach value would typically apply to cases where airspeeds could be limited to the range of airspeeds over which the aircraft can reasonably be expected to operate most frequently.

Condition	Lower Boundary is defined by	Upper Boundary is defined by
Flight Level	FL 290	The lower of : <ul style="list-style-type: none"> • FL 410 • Aircraft maximum certified altitude • Altitude limited by: cruise thrust; buffet; other aircraft flight limitations
Mach or Speed	The lower of: <ul style="list-style-type: none"> • Maximum endurance (holding speed) • Manoeuvre speed 	The lower of : <ul style="list-style-type: none"> • MMO/VMO • Speed limited by cruise thrust; buffet; other aircraft flight limitations
Gross Weight	<ul style="list-style-type: none"> • The lowest gross weight compatible with operations in RVSM airspace 	<ul style="list-style-type: none"> • The highest gross weight compatible with operations in RVSM airspace

TABLE 1 - Full RVSM envelope boundaries

(c) Test performance results presentation:

The test performance results may be presented on a single chart if the RVSM flight envelope is plotted using W/δ (weight divided by atmospheric pressure ratio) versus Mach number.

Note: This is due to the relationship between W/δ and the fundamental aerodynamic variables M and lift coefficient as shown below.

$$W/\delta = 1481.4 C_L M^2 S_{Ref}, \text{ where:}$$

δ = ambient pressure at flight altitude divided by sea level standard pressure of 1013.25 hPa

W/δ = Weight over Atmospheric Pressure Ratio

C_L = Lift Coefficient

M = Mach number

S_{Ref} = Reference Wing Area

Since δ is a fixed value for a given altitude, weight can be obtained for a given condition by simply multiplying the W/δ value by δ . Furthermore, over the RVSM altitude range, it is a good approximation to assume that position error is uniquely related to Mach number and W/δ for a given aircraft.

(d) Error budget

The demonstration of compliance with the RVSM performance criteria should include a justification of the contribution of all significant errors to the ASE (Error Budget). Appendix A provides guidance supporting the development of such justification.

Note: A trade-off may be made between the various error sources which contribute to ASE (e.g.: in the case of an aircraft group approval, the smaller the mean of the group and the more stringent the avionics standard, the larger the available allowance for the SSE variations). The ASE performance demonstration should consider this ASE trade off.

(e) ASE Flight Calibration Methods

Where flight calibrations are used to quantify or verify altimetry system performance they should be accomplished by any of the following methods. Flight calibrations should be performed only when appropriate ground checks have been completed. Uncertainties in application of the method will need to be assessed and taken into account in the data package.

- (1) Precision tracking radar in conjunction with pressure calibration of atmosphere at test altitude.
- (2) Trailing cone.
- (3) Pacer aircraft.
- (4) Any other method acceptable to the competent authority

Note: When using pacer aircraft, the pacer aircraft will need to be calibrated directly to a known standard. It is not acceptable to calibrate a pacer aircraft by another pacer aircraft.

(f) Compliance Demonstration for Groups of Aircraft.

Because of the statistical nature of the performance requirements, the demonstration of the compliance may vary considerably from group to group and therefore for a group aircraft the following process should be applied:

- (1) The mean and airframe-to-airframe variability of ASE should be established, based on flight test calibration of the accuracy for a number of aircraft. Where analytical methods are available, it may be possible to enhance the flight test data base and to track subsequent changes in the mean and variability based on geometric inspections and bench test, or any other method acceptable to the responsible authority. In the case of derivative aircraft it may be possible to use data from the parent as part of the data base, providing adequate provision is made for the changes that may contribute to difference in ASE characteristics.

Note: This is particularly important when a derivative involves changes to the airframe structure that may alter the SSE characteristics.

- (2) An assessment of the aircraft-to-aircraft variability of each error source should be made. The error assessment may take various forms as appropriate to the nature and magnitude of the source and the type of data available. It may be acceptable to use specification values to represent three standard deviations for smaller error sources; however a more comprehensive assessment may be required for those sources that contribute a greater proportion of the overall error.

Note: This assessment is particularly important for airframe error sources where specification values of ASE contribution may not have been previously established.

- (3) In many cases, one or more of the major ASE error sources will be aerodynamic in nature, such as variations in the airframe surface contour in the vicinity of the static pressure source. If evaluation of these errors is based on geometric measurements, substantiation should be provided that the methodology used is adequate to ensure compliance.

- (4) An error budget should be established to ensure that the RVSM performance criteria are met.

Note: the worst condition experienced in flight may differ for each criterion and therefore the component error values may also differ.

- (5) In showing compliance with the overall criteria, the component error sources should be combined appropriately. In most cases this will involve the algebraic summation of the mean components of the errors, root-sum-square (rss) combination of the variable components of the errors, and summation of the rss value with the absolute value of the overall mean. Care should be taken that only variable component error sources that are independent of each other are combined by rss.

- (6) A statistical study based on a representative sample of measured data should provide sufficient confidence that each individual aircraft in the group would have an ASE contained within $\pm 60\text{m}$ ($\pm 200\text{ ft}$).

Note: It is accepted that if any aircraft is identified as having an error exceeding $\pm 60\text{m}$ ($\pm 200\text{ ft}$) then it should receive corrective action.

(g) Compliance Demonstration for a Non Groups Aircraft.

For non-group aircraft, the following data should be established:

- (1) Flight test calibration of the aircraft to establish its ASE or SSE over the RVSM envelope should be conducted. The flight test calibration should be performed at points in the flight envelope(s) as agreed by the responsible authority using one of the methods identified in (e) above.
- (2) Calibration of the avionics used in the flight test as required may be conducted for establishing residual SSE. The number of test points should be agreed by the responsible authority. Since the purpose of the flight test is to determine the residual SSE, specially calibrated altimetry equipment may be used.
- (3) The installed altimetry avionics equipment specification should identify the largest allowable errors.

GM1 ACNS.E.RVSM.035 Altimetry System Accuracy

For group aircraft; to evaluate a system against the ASE performance, it is necessary to quantify the mean and three standard deviation values for ASE expressed as ASE_{mean} and ASE_{3SD} . To do this, it is necessary to take into account the different ways in which variations in ASE can arise. The factors that affect ASE are:

- (a) Unit to unit variability of avionics equipment.
- (b) Effect of environmental operating conditions on avionics equipment.
- (c) Airframe to airframe variability of static source error.
- (d) Effect of flight operating conditions on static source error.

Note: Assessment of ASE, whether based on measured or predicted data will need to consider item a to d above. The effect of item d as a variable can be eliminated by evaluating ASE at the most adverse flight condition in an RVSM flight envelope.

Appendix A provides two examples of methods to establish and monitor static source errors.

APPENDIX A - ALTIMETRY SYSTEM ERROR COMPONENTS

1 Introduction

The purpose of this appendix is to provide guidance to help ensure that all the potential error sources are identified and included in the Altimetry System Error budget.

2 Objective of ASE Budget

The purpose of the ASE budget is to demonstrate that the allocation of tolerances amongst the various parts of the altimetry system is consistent with the overall statistical ASE performance requirements. These individual tolerances within the ASE budget also form the basis of the procedures, defined in the airworthiness approval data package, which will be used to demonstrate that aircraft satisfy the RVSM criteria.

It is necessary to ensure that the budget takes account of all contributory components of ASE.

For group approval it is necessary to ensure either that the budget assesses the combined effect of the component errors in a way that is statistically realistic, or that the worst case specification values are used.

3 Altimetry System Error

3.1 Breakdown

Figure 1 shows the breakdown of total ASE into its main components, with each error block representing the error associated with one of the functions needed to generate a display of pressure altitude. This breakdown encompasses all altimetry system errors that can occur, although different system architectures may combine the components in slightly different ways.

- (a) The 'Actual Altitude' is the pressure altitude corresponding to the undisturbed ambient pressure.
- (b) The 'Static Source Error' is the difference between the undisturbed ambient pressure and the pressure within the static port, at the input end of the static pressure line.
- (c) The 'Static Line Error' is the difference in pressure along the length of the line.
- (d) The 'Pressure Measurement and Conversion Error' is the error associated with the processes of sensing the pneumatic input seen by the avionics, and converting the resulting pressure signal into altitude. As drawn, Figure 2-1 represents a self-sensing altimeter system in which the pressure measurement and altitude conversion functions would not normally be separable. In an air data computer system the two functions would be separate, and SSEC would probably then be applied before pressure altitude (H_p) was calculated.
- (e) The 'Perfect SSEC' would be that correction that compensated exactly for the SSE actually present at any time. If such a correction could be applied, then the resulting value of H_p calculated by the system would differ from the actual altitude only by the static line error plus the pressure measurement and conversion error. In general this cannot be achieved, so although the 'Actual SSEC' can be expected to reduce the effect of SSE, it will do so imperfectly.

- (f) The 'Residual Static Source Error' is applicable only in systems applying an avionic SSEC. It is the difference between the SSE and the correction actually applied. The corrected value of Hp will therefore differ from actual pressure altitude by the sum of static line error, pressure measurement and conversion error, and residual SSE.
- (g) The error between Hp and displayed altitude is the sum of the baro-correction error and the display error. Figure 2-1 represents their sequence for a self-sensing altimeter system. Air data computer systems can implement baro-correction in a number of ways that would modify slightly this part of the block diagram, but the errors would still be associated with either the baro-correction function or the display function. The only exception is that those systems that can be switched to operate the display directly from the Hp signal can eliminate baro-correction error where standard ground pressure setting is used, as in RVSM operations.

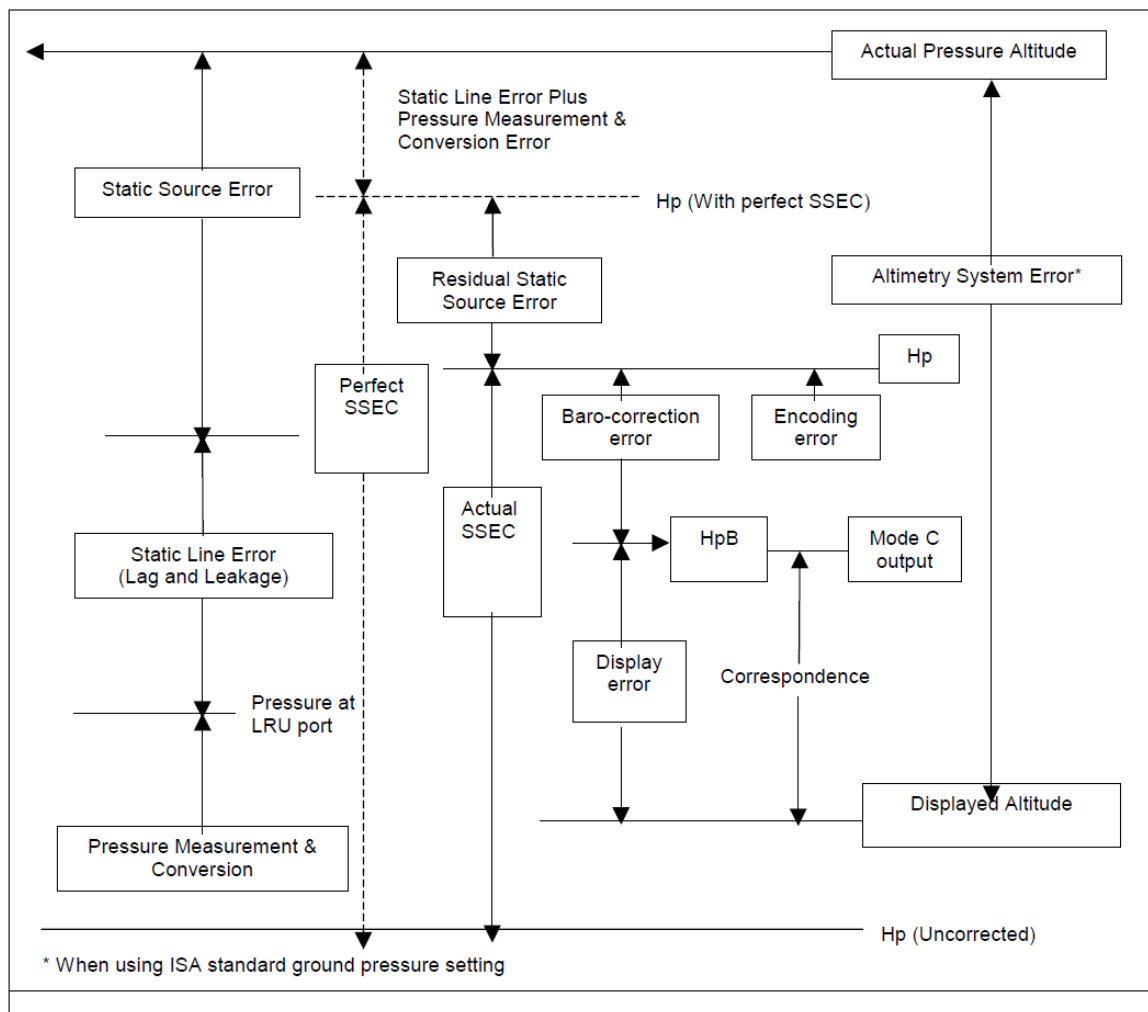

FIGURE 1 - Altimetry system errors

3.2 Components

Each of the system errors presented in Figure 1 and described in (c)(1) is discussed below in greater detail.

3.2.1 Static Source Error

The component parts of SSE are presented in Table 1, with the factors that control their magnitude.

- (a) The reference SSE is the best estimate of actual SSE, for a single aircraft or an aircraft group, obtained from flight calibration measurements. It is variable with operating condition, characteristically reduced to a family of W/δ curves that are functions of Mach.

It includes the effect of any aerodynamic compensation that may have been incorporated in the design. Once determined, the reference SSE is fixed for the single aircraft or group, although it may be revised when considering subsequent data.

- (b) The test techniques used to derive the reference SSE will have some measurement of uncertainty associated with them, even though known instrumentation errors will normally be eliminated from the data. For trailing-cone measurements the uncertainty arises from limitations on pressure measurement accuracy, calibration of the trailing-cone installation, and variability in installations where more than one are used. Once the reference SSE has been determined, the actual measurement error is fixed, but as it is unknown it can only be handled within the ASE budget as an estimated uncertainty.
- (c) The airframe variability and probe/port variability components arise from differences between the individual airframe and probe/port, and the example(s) of airframe and probe port used to derive the reference SSE.

3.2.2 Residual Static Source Error

- (a) The components and factors are presented in Table 1. Residual SSE is made up of those error components which make actual SSE different from the reference value, components 2, 3, and 4 from Table 1, plus the amount by which the actual SSEC differs from the value that would correct the reference value exactly, components 2(a), (b) and(c) from Table 2.
- (b) There will generally be a difference between the SSEC that would exactly compensate the reference SSE, and the SSEC that the avionics is designed to apply. This arises from practical avionics design limitations. The resulting error component 2(a) will therefore be fixed, for a particular flight condition, for the single aircraft or group. Additional variable errors 2(b) and 2(c) arise from those factors that cause a particular set of avionics to apply an actual SSEC that differs from its design value.
- (c) The relationship between perfect SSEC, reference SSEC, design SSEC and actual SSEC is illustrated in Figure 2, for the case where static line errors and pressure measurements and conversion errors are taken as zero.
- (d) Factors that create variability of SSE relative to the reference characteristic should be accounted for twice. First, as noted for the SSE itself in Table 2, and secondly for its effect on the corruption of SSEC as in factor 2(a)(i) of Table 2. Similarly, the static pressure measurement error should be accounted for in two separate ways. The main effect will be by way of the 'pressure measurement and conversion' component, but a secondary effect will be by way of factor 2(a)(ii) of Table 2.

Factors	Error Components
<p>Airframe Effects</p> <p>Operating Condition (Speed, altitude, angle of attack, sideslip)</p> <p>Geometry: Size and shape of airframe; Location of static sources; Variations of surface contour near the sources; Variations in fit of nearby doors, skin panels or other items.</p>	<p>1) Reference SSE values from flight calibration measurements.</p> <p>2) Uncertainty of flight calibration measurements.</p>
<p>Probe/Port Effects</p> <p>Operating Condition (Speed, altitude, angle of attack, sideslip)</p> <p>Geometry: Shape of probe/port; Manufacturing variations; Installation variations.</p>	<p>3) Airframe to airframe variability.</p> <p>4) Probe/port to probe/port variability.</p>

TABLE 1 - Static source error
(Cause: Aerodynamic Disturbance to Free-Stream Conditions)

Factors	Error Components
<p>(1) As for Static Source Error PLUS</p> <p>(2) Source of input data for SSEC function</p> <p>(a) Where SSEC is a function of Mach:</p> <p>(i) P_S sensing: difference in SSEC from reference SSE.</p> <p>(ii) P_S measurement: pressure transduction error.</p> <p>(iii) P_T errors: mainly pressure transduction error.</p> <p>(b) Where SSEC is a function of angle of attack:</p> <p>(i) geometric effects on alpha:</p> <ul style="list-style-type: none"> - sensor tolerances; - installation tolerances; - local surface variations. <p>(ii) measurement error:</p> <ul style="list-style-type: none"> - angle transducer accuracy. <p>(3) Implementation of SSEC function</p> <p>(a) Calculation of SSEC from input data;</p> <p>(b) Combination of SSEC with uncorrected height.</p>	<p>1) Error Components (2), (3), and (4) from table 2-1 PLUS</p> <p>2(a) Approximation in fitting design SSEC to flight calibration reference SSE.</p> <p>2(b) Effect of production variability (sensors and avionics) on achieving design SSEC.</p> <p>2(c) Effect of operating environment (sensors and avionics) on achieving design SSEC.</p>

TABLE 2 - Residual static source error: (aircraft with avionic SSEC)
 (Cause: Difference between the SSEC actually applied and the actual SSE)

FIGURE 2-2 SSE/SSEC RELATIONSHIPS FOR ASE WHERE STATIC LINE, PRESSURE MEASUREMENT AND CONVERSION ERRORS ARE ZERO

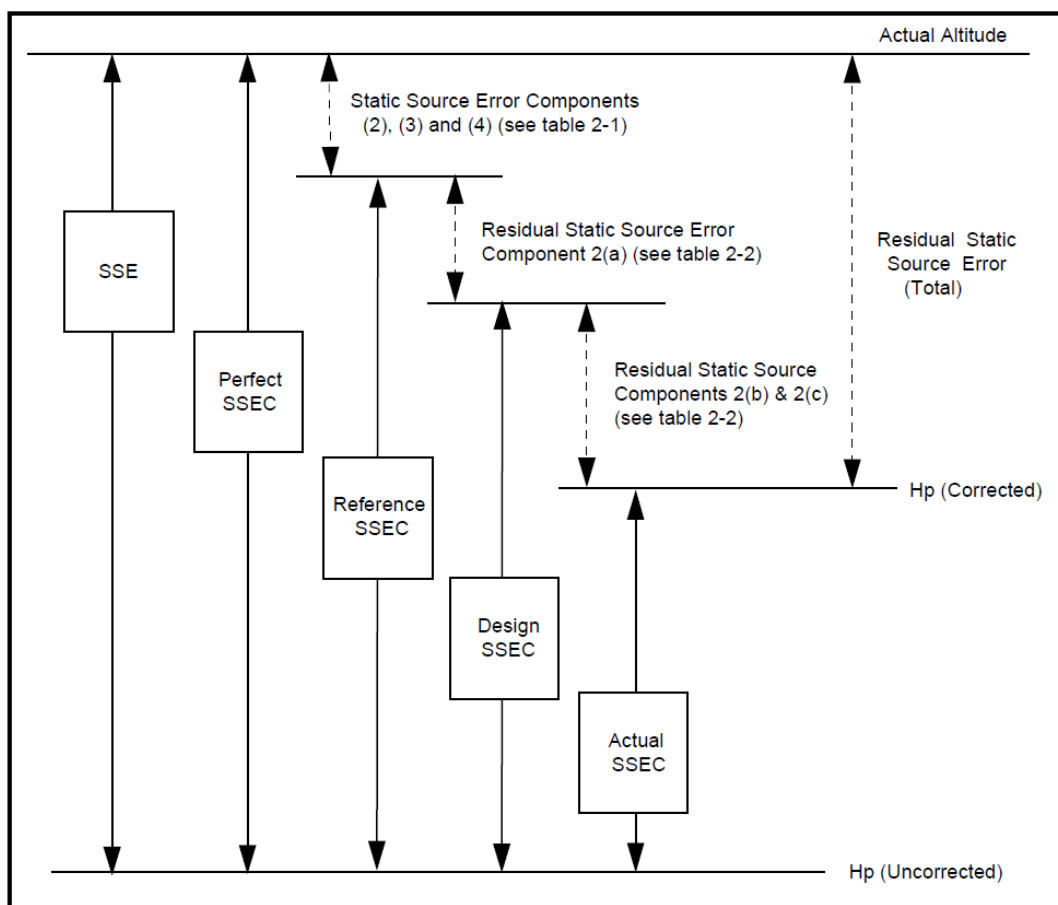

3.2.3 Static Line Error

Static line errors arise from leaks and pneumatic lags. In level cruise these can be made negligible for a system that is correctly designed and correctly installed.

3.2.4 Pressure Measurement and Conversion Error

- (a) The functional elements are static pressure sensing, which may be mechanical, electromechanical or solid-state, and the conversion of pressure signal to pressure altitude.
- (b) The error components are:
 - (i) calibration uncertainty;
 - (ii) nominal design performance;
 - (iii) unit to unit manufacturing variations; and
 - (iv) effect of operating environment.
- (c) The equipment specification is normally taken to cover the combined effect of the error components. If the value of pressure measurements and conversion error used in the error budget is the worst case specification value, then it is not necessary to assess the above components separately. However, calibration uncertainty, nominal design performance and effect of operating environment can all contribute to bias errors within the equipment

tolerance. Therefore, if it is desired to take statistical account of the likely spread of errors within the tolerance band, then it will be necessary to assess their likely interaction for the particular hardware design under consideration.

- (d) It is particularly important to ensure that the specified environmental performance is adequate for the intended application.

3.2.5 Baro-Setting Error

This is the difference between the value displayed and the value applied within the system. For RVSM operation the value displayed should always be the International Standard Atmosphere ground pressure, but setting mistakes, although part of TVE, are not components of ASE.

- (a) The components of Baro-Setting Error are:
 - (i) resolution of setting knob/display;
 - (ii) sensing of displayed value; and
 - (iii) application of sensed value.
- (b) The applicability of these factors and the way that they combine depend on the particular system architecture.
- (c) For systems in which the display is remote from the pressure measurement function there may be elements of the sensing and/or application or sensed value error components which arise from the need to transmit and receive the setting between the two locations.

3.2.6 Display Error

The cause is imperfect conversion from altitude signal to display.

The components are:

- (a) conversion of display input signal;
- (b) graticule/format accuracy, and
- (c) readability.

Note: In self-sensing altimeters the first of these would normally be separate from the pressure measurement and conversion error.

APPENDIX B — EXAMPLES OF METHODS TO ESTABLISH AND MONITOR STATIC SOURCE ERRORS (Group aircraft only)

1 Introduction

Two examples showing the method establish and monitor static source errors are presented below.

2 Example 1

One process for showing compliance with RVSM criteria is shown in Figure 1. Figure 1 illustrates how those flight test calibrations and geometric inspections will be performed on a given number of aircraft. The flight calibrations and inspections will continue until a correlation between the two is established. Geometric tolerances and SSEC will be established to satisfy RVSM criteria. For aircraft being manufactured, every Nth aircraft will be inspected in detail and every Mth aircraft will be flight test calibrated, where 'N' and 'M' are determined by the aircraft constructor and agreed to by the competent authority.

The data generated by 'N' inspections and 'M' flight calibrations can be used to track the mean and three standard deviation values to ensure continued compliance of the model with the criteria of CS ACNS.E.RVSM.035.

As additional data are acquired, they should be reviewed to determine if it is appropriate to change the values of N and M as indicated by the quality of the results obtained.

There are various ways in which the flight test and inspection data might be used to establish the correlation. The example shown in Figure 2 is a process in which each of the error sources for several aeroplanes is evaluated based on bench tests, inspections and analysis. Correlation between these evaluations and the actual flight test results would be used to substantiate the method.

The method illustrated in Figures 1 and 2 is appropriate for new models since it does not rely on any pre-existing data base for the group.

3 Example 2

Figure 3 illustrates that flight test calibrations should be performed on a given number of aircraft and consistency rules for air data information between all concerned systems verified. Geometric tolerances and SSEC should be established to satisfy the criteria. A correlation should be established between the design tolerances and the consistency rules. For aircraft being manufactured, air data information for all aircraft should be checked for consistency in cruise conditions and every Mth aircraft should be calibrated, where M is determined by the manufacturer and agreed to by the responsible authority. The data generated by the M flight calibrations should be used to track the mean and three standard deviation values to ensure continued compliance of the group with the criteria of CS ACNS.E.RVSM.035.

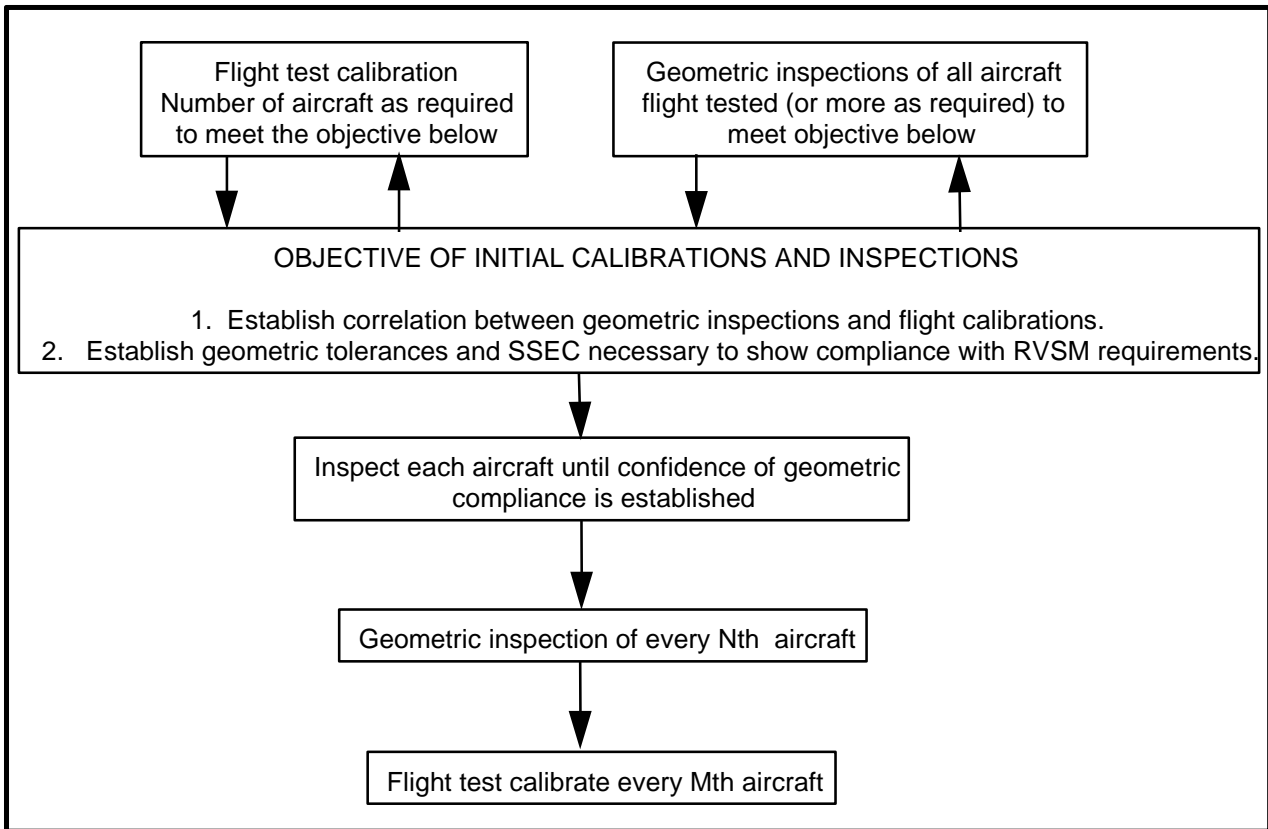

Figure 1 - Process for showing initial and continued compliance of airframe static pressure systems

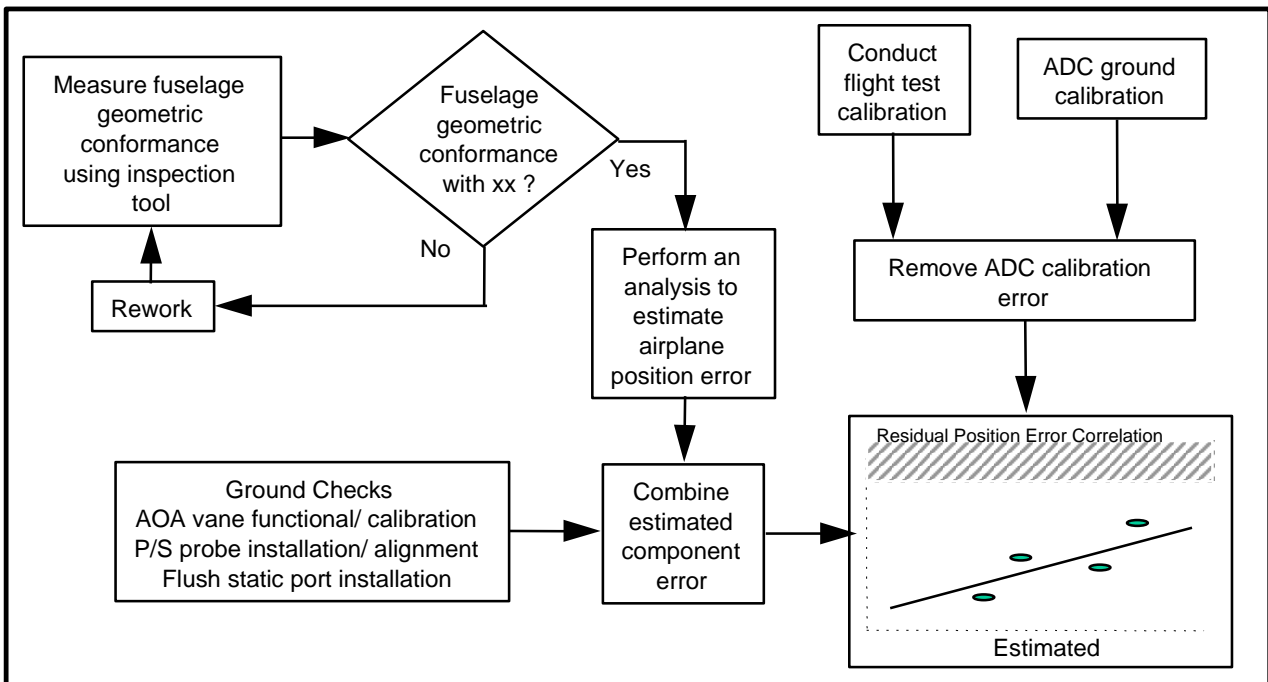

Figure 2 - Compliance demonstration ground - to flight test correlation process example

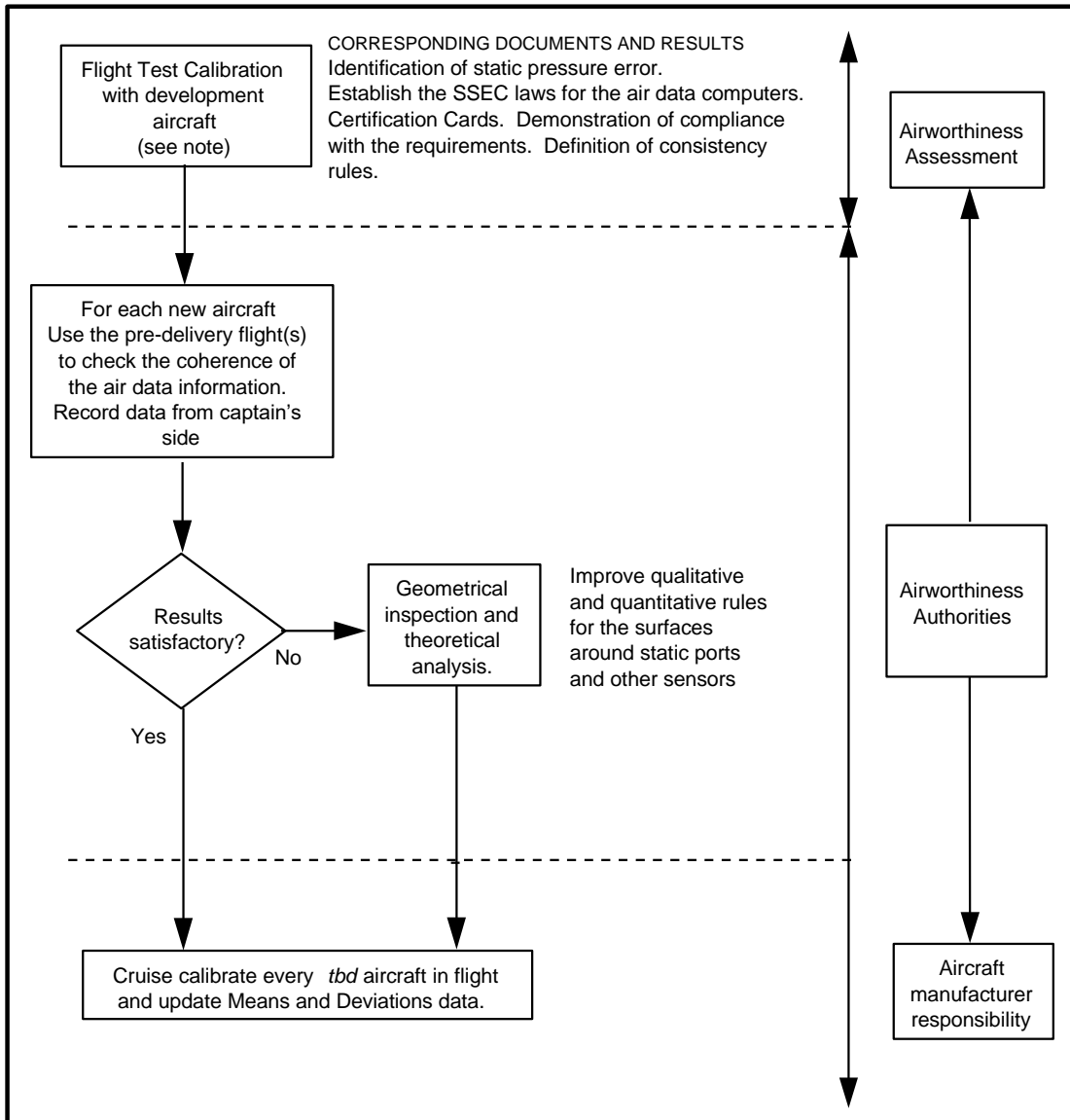

Figure 3 - Process for showing initial and continued compliance of airframe static pressure systems for new model aircraft.

Note : The flight test installation chosen to get the calibration data will need to have an accuracy compatible with the level of performance to be demonstrated and an analysis of this accuracy will need to be provided. Any possible degradation of this accuracy will need to be monitored and corrected during the flight test period.