

Annex V to ED Decision 2016/022/R

'AMC and GM to Annex V (Part-SPA) — Amendment 4'

The Annex to ED Decision 2012/019/R is amended as follows:

The text of the amendment is arranged to show deleted text, new or amended text as shown below:

- (a) deleted text is marked with ~~strikethrough~~;
- (b) new or amended text is highlighted in grey;
- (c) an ellipsis (...) indicates that the remaining text is unchanged in front of or following the reflected amendment.

1. A new Subpart K — Helicopter offshore operations is added as follows:

Subpart K — Helicopter offshore operations

GM1 SPA.HOFO.105(c) Approval for offshore operations

The requirement to inform both Member States (MSs) allows the MSs to mutually decide on how best to exercise their obligations in accordance with ARO.GEN.300(d) and (e) when operations are intended to be performed in a MS other than the MS issuing the approval for offshore operations.

AMC1 SPA.HOFO.110(a) Operating procedures

RISK ASSESSMENT

The operator's risk assessment should include, but not be limited to, the following hazards:

- (a) collision with offshore installations, vessels and floating structures;
- (b) collision with wind turbines;
- (c) collision with skysails;
- (d) collision during low-level instrument meteorological conditions (IMC) operations;
- (e) collision with obstacles adjacent to helidecks;
- (f) collision with surface/water;
- (g) IMC or night offshore approaches;
- (h) loss of control during operations to small or moving offshore locations;
- (i) operations to unattended helidecks; and
- (j) weather and/or sea conditions that could either cause an accident or exacerbate its consequences.

AMC1 SPA.HOFO.110(b)(1) Operating procedures

OPERATIONAL FLIGHT PLAN

The operational flight plan should contain at least the items listed in AMC1 CAT.OP.MPA.175(a) Flight preparation.

AMC1 SPA.HOFO.110(b)(2) Operating procedures

PASSENGER BRIEFING

The following aspects applicable to the helicopter used should be presented and demonstrated to the passengers by audio-visual electronic means (video, DVD or similar), or the passengers should be informed about them by a crew member prior to boarding the aircraft:

- (a) the use of the life jackets and where they are stowed if not in use;
- (b) the proper use of survival suits, including briefing on the need to have suits fully zipped with, if applicable, hoods and gloves on, during take-off and landing or when otherwise advised by the pilot-in-command/commander;
- (c) the proper use of emergency breathing equipment;
- (d) the location and operation of the emergency exits;

- (e) life raft deployment and boarding;
- (f) deployment of all survival equipment; and
- (g) boarding and disembarkation instructions.

When operating in a non-hostile environment, the operator may omit items related to equipment that is not required.

AMC1.1 SPA.HOFO.110(b)(2) Operating procedures

PASSENGER BRIEFING

This AMC is applicable to passengers who require more knowledge of the operational concept, such as sea pilots and support personnel for offshore wind turbines.

The operator may replace the passenger briefing as set out in AMC1 SPA.HOFO.110(b)(2) with a passenger training and checking programme provided that:

- the operator ensures that the passenger is appropriately trained and qualified on the helicopter types on which they are to be carried;
- the operator defines the training and checking programme for each helicopter type, covering all safety and emergency procedures for a given helicopter type, and including practical training;
- the passenger has received the above training within the last 12 calendar months; and
- the passenger has flown on the helicopter type within the last 90 days.

AMC1 SPA.HOFO.110(b)(5) Operating procedures

AUTOMATIC FLIGHT CONTROL SYSTEM (AFCS)

To ensure competence in manual handling of the helicopter, the operator should provide instructions to the flight crew in the operations manual (OM) under which circumstances the helicopter may be operated in lower modes of automation. Particular emphasis should be given to flight in instrument meteorological conditions (IMC) and instrument approaches.

GM1 SPA.HOFO.110(b)(9) Operating Procedures

Emergency flotation systems (EFSs) cannot always be armed safely before the approach when a speed limitation needs to be complied with. In such case, the EFS should be armed as soon as safe to do so.

AMC1 SPA.HOFO.115 Use of offshore locations

GENERAL

- (a) The operations manual (OM) relating to the specific usage of offshore helicopter landing areas (Part C for CAT operators) should contain, or make reference to, a directory of helidecks (helideck directory (HD)) intended to be used by the operator. The directory should provide details of helideck limitations and a pictorial representation of each offshore location and its helicopter landing area, recording all necessary information of a permanent nature and using a standardised template. The HD entries should show, and be amended as necessary, the most recent status of each helideck concerning non-compliance with applicable national standards, limitations, warnings, cautions or other comments of operational importance. An example of a typical template is shown in Figure 1 of GM1 SPA.HOFO.115 below.

- (b) In order to ensure that the safety of flights is not compromised, the operator should obtain relevant information and details in order to compile the HD, as well as the pictorial representation from the owner/operator of the offshore helicopter landing area.
- (c) If more than one name for the offshore location exists, the common name painted on the surface of the landing area should be listed, but other names should also be included in the HD (e.g. radio call sign, if different). After renaming an offshore location, the old name should also be included in the HD for the following 6 months.
- (d) Any limitations associated with an offshore location should be included in the HD. With complex installation arrangements, including combinations of installations/vessels (e.g. combined operations), a separate listing in the HD, accompanied by diagrams/pictures, where necessary, may be required.
- (e) Each offshore helicopter landing area should be inspected and assessed based on limitations, warnings, instructions and restrictions, in order to determine its acceptability with respect to the following as a minimum:
- (1) The physical characteristics of the landing area, including size, load-bearing capability and the appropriate 'D' and 't' values.

Note 1: 'D' is the overall length of the helicopter from the most forward position of the main rotor tip to the most rearward position of the tail rotor tip plane path, or rearmost extension of the fuselage in the case of 'Fenestron' or 'NOTAR' tails.

Note 2: 't' is the maximum allowable mass in tonnes.
 - (2) The preservation of obstacle-protected surfaces (an essential safeguard for all flights). These surfaces are:
 - (i) the minimum 210° obstacle-free surface (OFS) above helideck level;
 - (ii) the 150° limited-obstacle surface (LOS) above helideck level; and
 - (iii) the minimum 180° falling '5:1' gradient with respect to significant obstacles below helideck level.

If these sectors/surfaces are infringed, even on a temporary basis, and/or if an adjacent installation or vessel infringes the obstacle-protected surfaces related to the landing area, an assessment should be made to determine whether it is necessary to impose operating limitations and/or restrictions to mitigate any non-compliance with the criteria.
 - (3) Marking and lighting:
 - (i) for operations at night, adequate illumination of the perimeter of the landing area, using perimeter lighting that meets national requirements;
 - (ii) for operations at night, adequate illumination of the location of the touchdown marking by use of a lit touchdown/positioning marking and lit helideck identification marking that meet national requirements;
 - (iii) status lights (for night and day operations, indicating the status of the helicopter landing area, e.g. a red flashing light indicates 'landing area unsafe: do not land') meeting national requirements;
 - (iv) dominant-obstacle paint schemes and lighting;

- (v) condition of helideck markings; and
- (vi) adequacy of general installation and structure lighting.

Any limitations with respect to non-compliance of lighting arrangements may require the HD to be annotated 'daylight only operations'.

(4) Deck surface:

- (i) assessment of surface friction;
- (ii) adequacy and condition of helideck net (where provided);
- (iii) 'fit for purpose' drainage system;
- (iv) deck edge safety netting or shelving;
- (v) a system of tie-down points that is adequate for the range of helicopters in use; and
- (vi) procedures to ensure that the surface is kept clean of all contaminants, e.g. bird guano, sea spray, snow and ice.

(5) Environment:

- (i) foreign-object damage;
- (ii) an assessment of physical turbulence generators, e.g. structure-induced turbulence due to clad derrick;
- (iii) bird control measures;
- (iv) air flow degradation due to gas turbine exhaust emissions (turbulence and thermal effects), flares (thermal effects) or cold gas vents (unburned flammable gas); and
- (v) adjacent offshore installations may need to be included in the environmental assessment.

To assess for potential adverse environmental effects, as described in (ii), (iv) and (v) above, an offshore location should be subject to appropriate studies, e.g. wind tunnel testing and/or computational fluid dynamics (CFD) analysis.

(6) Rescue and firefighting:

- (i) systems for delivery of firefighting media to the landing area, e.g. deck integrated firefighting system (DIFFS);
- (ii) delivery of primary media types, assumed critical area, application rate and duration;
- (iii) deliveries of complementary agent(s) and media types, capacity and discharge;
- (iv) personal protective equipment (PPE); and
- (v) rescue equipment and crash box/cabinet.

(7) Communication and navigation (Com/Nav):

- (i) aeronautical radio(s);
- (ii) radio-telephone (R/T) call sign to match the offshore location name with the side identification that should be simple and unique; and
- (iii) radio log.

(8) Fuelling facilities:

in accordance with the relevant national guidance and legislation.

(9) Additional operational and handling equipment:

(i) windsock;

(ii) meteorological information, including wind, pressure, air temperature, and dew point temperature, and equipment recording and displaying mean wind (10-min wind) and gusts;

(iii) helideck motion recording and reporting system, where applicable;

(iv) passenger briefing system;

(v) chocks;

(vi) tie-down strops/ropes;

(vii) weighing scales;

(viii) a suitable power source for starting helicopters (e.g. ground power unit (GPU)), where applicable; and

(ix) equipment for clearing the landing area of snow, ice and other contaminants.

(10) Personnel:

trained helicopter-landing-area staff (e.g. helicopter landing officer/helicopter deck assistant and firefighters, etc.); persons required to assess local weather conditions or communicate with the helicopter by radio-telephony should be appropriately qualified.

(f) The HD entry for each offshore location should be completed and kept up to date, using the template and reflecting the information and details described in (e) above. The template should contain at least the following (GM1 SPA.HOFO.115 below is provided as an example):

(1) details:

(i) name of offshore location;

(ii) R/T call sign;

(iii) helicopter landing area identification marking;

(iv) side panel identification marking;

(v) landing area elevation;

(vi) maximum installation/vessel height;

(vii) helideck size and/or 'D' value;

(viii) type of offshore location:

(A) fixed, permanently manned installation;

(B) fixed, normally unattended installation;

(C) vessel type (e.g. diving support vessel, tanker, etc.);

(D) semi-submersible, mobile, offshore drilling unit;

(E) jack-up, mobile, offshore drilling unit;

(F) floating production, storage and offloading (FPSO);

(ix) name of owner/operator;

(x) geographical position, where appropriate;

(xi) Com/Nav frequencies and identification;

(xii) general drawing of the offshore location that shows the helicopter landing area with annotations indicating location of derrick, masts, cranes, flare stack, turbine and gas exhausts, side identification panels, windsock, etc.;

(xiii) plan view drawing, and chart orientation from the general drawing to show the above; the plan view should also show the 210-degree sector orientation in degrees true;

(xiv) type of fuelling:

(A) pressure and gravity;

(B) pressure only;

(C) gravity only; and

(D) none;

(xv) type and nature of firefighting equipment;

(xvi) availability of GPU;

(xvii) deck heading;

(xviii) 't' value ;

(xix) status light system (Yes/No); and

(xx) revision publication date or number; and

(2) one or more diagrams/photographs, and any other suitable guidance to assist pilots.

(g) For offshore locations for which there is incomplete information, 'restricted' usage based on the information available may be considered by the operator, subject to risk assessment prior to the first helicopter visit. During subsequent operations, and before any restriction on usage is lifted, information should be gathered and the following should apply:

(1) pictorial (static) representation:

(i) template blanks (GM1 SPA.HOFO.115 is provided as an example) should be available to be filled in during flight preparation on the basis of the information given by the offshore location owner/operator and of flight crew observations;

(ii) where possible, suitably annotated photographs may be used until the HD entry and template have been completed;

(iii) until the HD entry and template have been completed, conservative operational restrictions (e.g. performance, routing, etc.) may be applied;

(iv) any previous inspection reports should be obtained and reviewed by the operator; and

(v) an inspection of the offshore helicopter landing area should be carried out to verify the content of the completed HD entry and template; once found suitable, the landing area may be considered authorised for use by the operator; and

(2) with reference to the above, the HD entry should contain at least the following:

(i) HD revision date or number;

(ii) generic list of helideck motion limitations;

(iii) name of offshore location;

(iv) helideck size and/or 'D' value and 't' value; and

(v) limitations, warnings, instructions and restrictions.

GM1 SPA.HOFO.115 Use of offshore locations

Figure 1 — Example of a helicopter landing area template

Operator		10-1	Revision date	
Installation/vessel name		Position	(N/S XXX)	(E/W XXX)
Deck height	Installation height	Highest obstacle within 5 nm	Deck heading	Deck ident
(XXX ft)	(XXX ft)			
AIMS/ICAO code	Radio	Radio	Deck category	Side ident
			(1/2/3)	
Deck size (m)	T value (XXX kg)	Cleared for (above D or t values)	Installation type	Operator
		(Helicopter type xxx)	(Fixed/semi/etc.)	
Fuel	Ground power	Inspection date	Inspected by	Next due
(Press/gravity/no)	(AC/DC/no)			

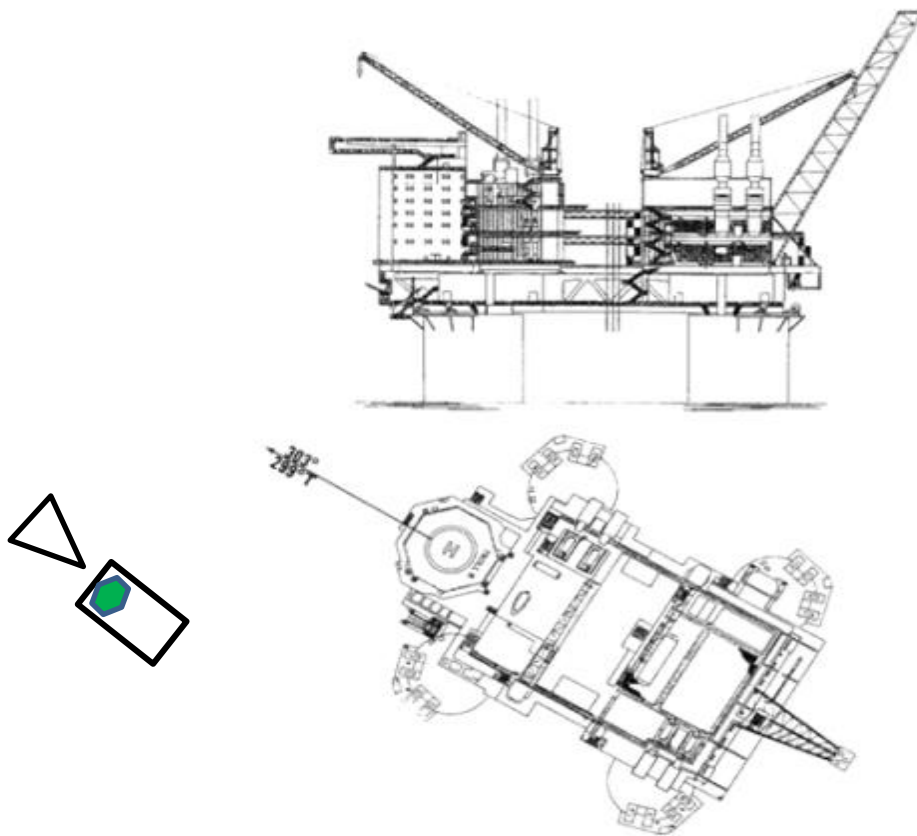

Wind direction	Wind speed	Limitations
(All) (000–050)	(All) (> 30)	(Performance requirements) (Table 2 etc.)
5:1 non-compliant obstacles		
Additional information		

Figure 2 — Example of a helicopter landing area template

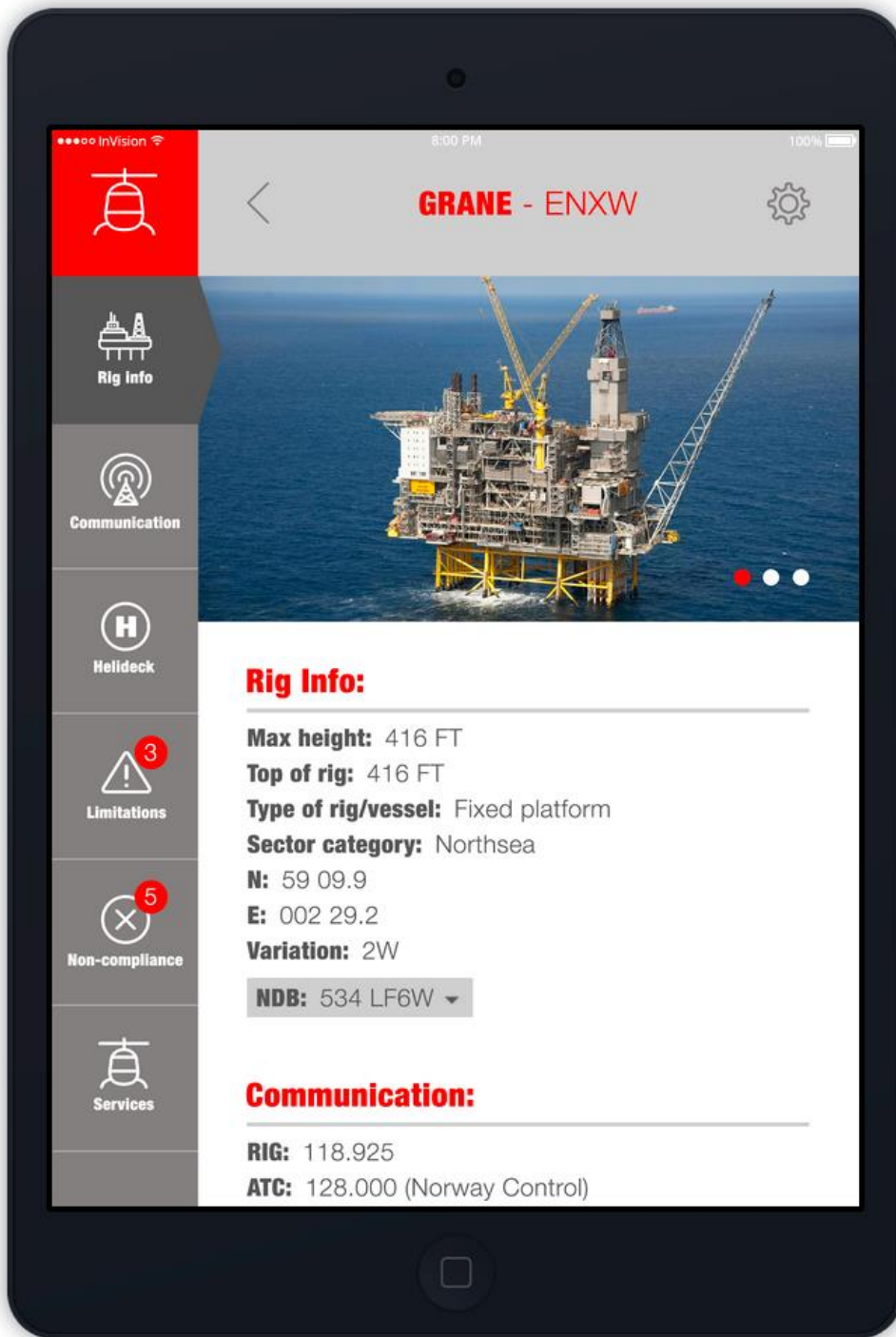

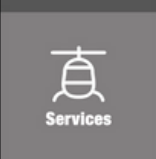
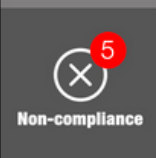
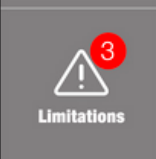
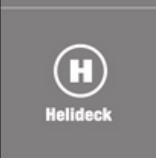
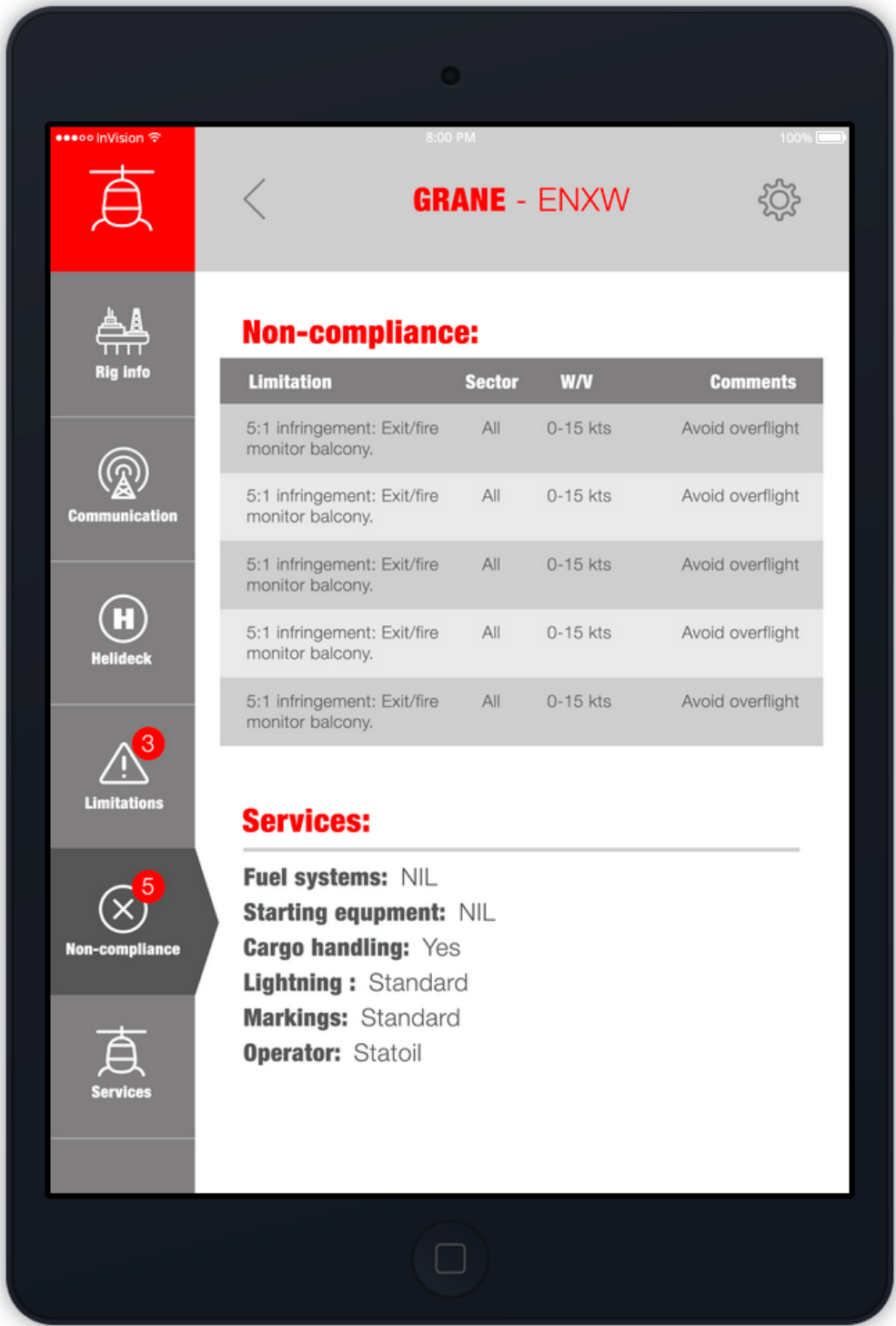

Non-compliance:

Limitation	Sector	W/V	Comments
5:1 infringement: Exit/fire monitor balcony.	All	0-15 kts	Avoid overflight
5:1 infringement: Exit/fire monitor balcony.	All	0-15 kts	Avoid overflight
5:1 infringement: Exit/fire monitor balcony.	All	0-15 kts	Avoid overflight
5:1 infringement: Exit/fire monitor balcony.	All	0-15 kts	Avoid overflight
5:1 infringement: Exit/fire monitor balcony.	All	0-15 kts	Avoid overflight

Services:

- Fuel systems:** NIL
- Starting equipment:** NIL
- Cargo handling:** Yes
- Lightning :** Standard
- Markings:** Standard
- Operator:** Statoil

GM2 SPA.HOFO.115 Use of offshore locations

Operators should use available standards and regulations provided for operations to offshore locations such as those contained in United Kingdom Civil Aviation Authority (UK CAA) CAP 437 'Standards for Offshore Helicopter Landing Areas', Norwegian Civil Aviation Regulation BSL D 5-1 or similar national documentation, or ICAO Annex 14, Vol II 'Heliports'.

AMC1 SPA.HOFO.120 Selection of aerodromes and operating sites

COASTAL AERODROME

- (a) Any alleviation from the requirement to select an alternate aerodrome for a flight to a coastal aerodrome under instrument flight rules (IFR) routing from offshore should be based on an individual safety risk assessment.
- (b) The following should be taken into account:
 - (1) suitability of the weather based on the landing forecast for the destination;
 - (2) the fuel required to meet the IFR requirements of CAT.OP.MPA.150, NCC.OP.131 or SPO.OP.131 except for the alternate fuel;
 - (3) where the destination coastal aerodrome is not directly on the coast, it should be:
 - (i) within a distance that with the fuel specified in (b)(2), the helicopter is able, at any time after crossing the coastline, to return to the coast, descend safely, carry out an approach under visual flight rules (VFR) and land, with the VFR fuel reserves intact;
 - (ii) within 5 nm of the coastline; and
 - (iii) geographically sited so that the helicopter is able, within the rules of the air and within the landing forecast:
 - (A) to proceed inbound from the coast at 500-ft above ground level (AGL), and carry out an approach and landing under VFR; or
 - (B) to proceed inbound from the coast on an agreed route, and carry out an approach and landing under VFR;
 - (4) procedures for coastal aerodromes should be based on a landing forecast no worse than:
 - (i) by day, a cloud base of ≥ 400 ft above descent height (DH)/minimum descent height (MDH), and a visibility of 4 km, or, if descent over the sea is intended, a cloud base of 600 ft and a visibility of 4 km; or
 - (ii) by night, a cloud base of 1 000 ft and a visibility of 5 km;
 - (5) the descent to establish visual contact with the surface should take place over the sea or as part of the instrument approach;
 - (6) routings and procedures for coastal aerodromes nominated as such should be included in the operations manual (OM) (Part C for CAT operators);
 - (7) the minimum equipment list (MEL) should reflect the requirement for airborne radar and radio altimeter for this type of operation; and
 - (8) operational limitations for each coastal aerodrome should be specified in the OM.

AMC2 SPA.HOFO.120 Selection of aerodromes and operating sites

OFFSHORE DESTINATION ALTERNATE AERODROME

'Aerodrome' is referred to as 'helideck' in this AMC.

(a) Offshore destination alternate helideck landing environment

The landing environment at an offshore location proposed for use as an offshore destination alternate helideck should be pre-surveyed, together with the physical characteristics, such as the effect of wind direction and strength, as well as of turbulence established. This information, which should be available to the pilot-in-command/commander both at the planning stage and in-flight, should be published in an appropriate form in the operations manual (OM) (including the orientation of the helideck) so that the suitability of the alternate helideck can be assessed. This helideck should meet the criteria for size and obstacle clearance appropriate to the performance requirements of the type of helicopter concerned.

(b) Performance considerations

The use of an offshore destination alternate helideck should be restricted to helicopters that can achieve one engine inoperative (OEI) in ground effect (IGE) hover at an appropriate power rating above the helideck at the offshore location. Where the surface of the helideck or prevailing conditions (especially wind velocity) precludes an OEI IGE, OEI out-of-ground effect (OGE) hover performance at an appropriate power rating should be used to compute the landing mass. The landing mass should be calculated based on graphs provided in the operations manual (OM) (Part B for CAT operators). When this landing mass is computed, due account should be taken of helicopter configuration, environmental conditions and the operation of systems that have an adverse effect on performance. The planned landing mass of the helicopter, including crew, passengers, baggage, cargo plus 30-min final reserve fuel (FRF), should not exceed the OEI landing mass of the helicopter at the time of approach to the offshore destination alternate.

(c) Weather considerations

(1) Meteorological observations

When the use of an offshore destination alternate helideck is planned, the meteorological observations, both at the offshore destination and the alternate helideck, should be made by an observer acceptable to the authority responsible for the provision of meteorological services. Automatic meteorological-observation stations may be used.

(2) Weather minima

When the use of an offshore destination alternate helideck is planned, the operator should neither select an offshore location as destination nor as alternate helideck unless the weather forecasts for the two offshore locations indicate that during a period commencing 1 h before and ending 1 h after the expected time of arrival at the destination and the alternate helideck, the weather conditions will be at or above the planning minima shown in the following table:

Table 1 — Planning minima

Planning minima		
	Day	Night
Cloud base	600 ft	800 ft
Visibility	4 km	5 km

(3) Conditions of fog

To use an offshore destination alternate helideck, it should be ensured that fog is not forecast or present within 60 nm of the destination helideck and alternate helideck during the period commencing 1 h before and ending 1 h after the expected time of arrival at the offshore destination or alternate helideck.

(d) Actions at point of no return

Before passing the point of no return, which should not be more than 30 min from the destination, the following actions should have been completed:

- (1) confirmation that navigation to the offshore destination and offshore destination alternate helideck can be assured;
- (2) radio contact with the offshore destination and offshore destination alternate helideck (or master station) has been established;
- (3) the landing forecast at the offshore destination and offshore destination alternate helideck have been obtained and confirmed to be at or above the required minima;
- (4) the requirements for OEI landing (see (b) above) have been checked in the light of the latest reported weather conditions to ensure that they can be met; and
- (5) to the extent possible, having regard to information on the current and forecast use of the offshore alternate helideck and on prevailing conditions, the availability of the helideck on the offshore location intended as destination alternate helideck should be guaranteed by the duty holder (the rig operator in the case of fixed installations, and the owner in the case of mobile ones) until the landing at the destination, or the offshore destination alternate helideck, has been achieved or until offshore shuttling has been completed.

AMC1 SPA.HOFO.125 Airborne radar approach (ARA) to offshore locations

Note: alternative approach procedures using original equipment manufacturer (OEM)-certified approach systems are not covered by this AMC.

GENERAL

- (a) Before commencing the final approach, the pilot-in-command/commander should ensure that a clear path exists on the radar screen for the final and missed approach segments. If lateral clearance from any obstacle will be less than 1 nm, the pilot-in-command/commander should:
 - (1) approach to a nearby target structure and thereafter proceed visually to the destination structure; or
 - (2) make the approach from another direction leading to a circling manoeuvre.
- (b) The cloud ceiling should be sufficiently clear above the helideck to permit a safe landing.
- (c) Minimum descent height (MDH) should not be less than 50 ft above the elevation of the helideck:
 - (1) the MDH for an airborne radar approach should not be lower than:
 - (i) 200 ft by day; or
 - (ii) 300 ft by night; and

- (2) the MDH for an approach leading to a circling manoeuvre should not be lower than:
 - (i) 300 ft by day; or
 - (ii) 500 ft by night.
- (d) Minimum descent altitude (MDA) may only be used if the radio altimeter is unserviceable. The MDA should be a minimum of the MDH + 200 ft, and be based on a calibrated barometer at the destination or on the lowest forecast barometric pressure adjusted to sea level (QNH) for the region.
- (e) The decision range should not be less than 0.75 nm.
- (f) The MDA/MDH for a single-pilot ARA should be 100 ft higher than that calculated in accordance with (c) and (d) above. The decision range should not be less than 1 nm.
- (g) For approaches to non-moving offshore locations, the maximum range discrepancy between the global navigation satellite system (GNSS) and the weather radar display should not be greater than 0.3 nm at any point between the final approach fix (FAF) at 4 nm from the offshore location and the offset initiation point (OIP) at 1.5 nm from the offshore location.
- (h) For approaches to non-moving offshore locations, the maximum bearing discrepancy between the GNSS and the weather radar display should not be greater than 10° at the FAF at 4 nm from the offshore location.

GM1 SPA.HOFO.125 Airborne radar approach (ARA) to offshore locations

GENERAL

(a) General

- (1) The helicopter ARA procedure may have as many as five separate segments: the arrival, initial, intermediate, final approach, and missed approach segment. In addition, the specifications of the circling manoeuvre to a landing under visual conditions should be considered. The individual approach segments can begin and end at designated fixes. However, the segments of an ARA may often begin at specified points where no fixes are available.
- (2) The fixes, or points, are named to coincide with the beginning of the associated segment. For example, the intermediate segment begins at the intermediate fix (IF) and ends at the final approach fix (FAF). Where no fix is available or appropriate, the segments begin and end at specified points; for example, at the intermediate point (IP) and final approach point (FAP). The order in which the segments are discussed in this GM is the order in which the pilot would fly them in a complete procedure: that is, from the arrival through the initial and intermediate to the final approach and, if necessary, to the missed approach.
- (3) Only those segments that are required by local conditions applying at the time of the approach need to be included in a procedure. In constructing the procedure, the final approach track, which should be orientated so as to be substantially into the wind, should be identified first as it is the least flexible and most critical of all the segments. When the origin and the orientation of the final approach have been determined, the other necessary segments should be integrated with it to produce an orderly manoeuvring pattern that does not generate an unacceptably high workload for the flight crew.

- (4) Where an ARA is conducted to a non-moving offshore location (i.e. fixed installation or moored vessel), and a reliable global navigation satellite system (GNSS) position for the location is available, the GNSS/area navigation system should be used to enhance the safety of the ARA. This is achieved by using the GNSS/area navigation system to navigate the helicopter onto, and maintain, the final approach track, and by using the GNSS range and bearing information to cross-check the position of the offshore location on the weather radar display.
- (5) Examples of ARA procedures, as well as vertical profile and missed approach procedures, are contained in Figures 1 and 2 below.

(b) Obstacle environment

- (1) Each segment of the ARA is located in an overwater area that has a flat surface at sea level. However, due to the passage of large vessels which are not required to notify their presence, the exact obstacle environment cannot be determined. As the largest vessels and structures are known to reach elevations exceeding 500 ft above mean sea level (AMSL), the uncontrolled offshore obstacle environment applying to the arrival, initial and intermediate approach segments can reasonably be assumed to be capable of reaching to at least 500 ft AMSL. Nevertheless, in the case of the final approach and missed approach segments, specific areas are involved within which no radar returns are allowed. In these areas, the height of wave crests, and the possibility that small obstacles may be present that are not visible on radar, results in an uncontrolled surface environment that extends to an elevation of 50 ft AMSL.
- (2) Information about movable obstacles should be requested from the arrival destination or adjacent installations.
- (3) Under normal circumstances, the relationship between the approach procedure and the obstacle environment is governed by the concept that vertical separation is very easy to apply during the arrival, initial and intermediate segments, while horizontal separation, which is much more difficult to guarantee in an uncontrolled environment, is applied only in the final and missed approach segments.

(c) Arrival segment

The arrival segment commences at the last en-route navigation fix, where the aircraft leaves the helicopter route, and it ends either at the initial approach fix (IAF) or, if no course reversal or similar manoeuvre is required, it ends at the IF. Standard en-route obstacle clearance criteria should be applied to the arrival segment.

(d) Initial approach segment

The initial approach segment is only required if the intermediate approach track cannot be joined directly. Most approaches will be flown direct to a point close to the IF, and then on to the final approach track, using GNSS/area navigation guidance. The segment commences at the IAF, and on completion of the manoeuvre, it ends at the IP. The minimum obstacle clearance (MOC) assigned to the initial approach segment is 1 000 ft.

(e) Intermediate approach segment

The intermediate approach segment commences at the IP, or in the case of straight-in approaches, where there is no initial approach segment, it commences at the IF. The segment ends at the FAP and should not be less than 2 nm in length. The purpose of the intermediate segment is to align the

helicopter with the final approach track and prepare it for the final approach. During the intermediate segment, the helicopter should be lined up with the final approach track, the speed should be stabilised, the destination should be identified on the radar, and the final approach and missed approach areas should be identified and verified to be clear of radar returns. The MOC assigned to the intermediate segment is 500 ft.

(f) Final approach segment

- (1) The final approach segment commences at the FAP and ends at the missed approach point (MAPt). The final approach area, which should be identified on radar, takes the form of a corridor between the FAP and the radar return of the destination. This corridor should not be less than 2 nm wide so that the projected track of the helicopter does not pass closer than 1 nm to the obstacles lying outside the area.
- (2) On passing the FAP, the helicopter will descend below the intermediate approach altitude and follow a descent gradient which should not be steeper than 6.5 %. At this stage, vertical separation from the offshore obstacle environment will be lost. However, within the final approach area, the MDA/MDH will provide separation from the surface environment. Descent from 1 000 ft AMSL to 200 ft AMSL at a constant 6.5 % gradient will involve a horizontal distance of 2 nm. In order to follow the guideline that the procedure should not generate an unacceptably high workload for the flight crew, the required actions of levelling off at MDH, changing heading at the offset initiation point (OIP), and turning away at the MAPt, should not be planned to occur at the same time from the destination.
- (3) During the final approach, compensation for drift should be applied, and the heading which, if maintained, would take the helicopter directly to the destination should be identified. It follows that at an OIP located at a range of 1.5 nm, a heading change of 10° is likely to result in a track offset of 15° at 1 nm, and the extended centre line of the new track can be expected to have a mean position approximately 300–400 m to one side of the destination structure. The safety margin built into the 0.75-nm decision range (DR) is dependent upon the rate of closure with the destination. Although the airspeed should be in the range of 60–90 KIAS during the final approach, the ground speed, after due allowance for wind velocity, should not be greater than 70 kt.

(g) Missed approach segment

- (1) The missed approach segment commences at the MAPt and ends when the helicopter reaches the minimum en route altitude. The missed approach manoeuvre is a 'turning missed approach' which should be of not less than 30° and should not, normally, be greater than 45°. A turn away of more than 45° does not reduce the collision risk factor any further nor does it permit a closer DR. However, turns of more than 45° may increase the risk of pilot disorientation, and by inhibiting the rate of climb (especially in the case of an OEI missed approach procedure), may keep the helicopter at an extremely low level for longer than it is desirable.
- (2) The missed approach area to be used should be identified and verified as a clear area on the radar screen during the intermediate approach segment. The base of the missed approach area is a sloping surface at 2.5 % gradient starting from MDH at the MAPt. The concept is that a helicopter executing a turning missed approach will be protected by the horizontal boundaries of the missed

approach area until vertical separation of more than 130 ft is achieved between the base of the area and the offshore obstacle environment of 500 ft AMSL that prevails outside the area.

- (3) A missed approach area, taking the form of a 45° sector orientated left or right of the final approach track, originating from a point 5 nm short of the destination, and terminating on an arc 3 nm beyond the destination, should normally satisfy the specifications of a 30° turning missed approach.

(h) Required visual reference

The visual reference required is that the destination should be in view in order to be able to carry out a safe landing.

(i) Radar equipment

During the ARA procedure, colour mapping radar equipment with a 120° sector scan and a 2.5-nm range scale selected may result in dynamic errors of the following order:

- (1) bearing/tracking error of $\pm 4.5^\circ$ with 95 % accuracy;
- (2) mean ranging error of 250 m; or
- (3) random ranging error of ± 250 m with 95 % accuracy.

Figure 1 — Horizontal profile

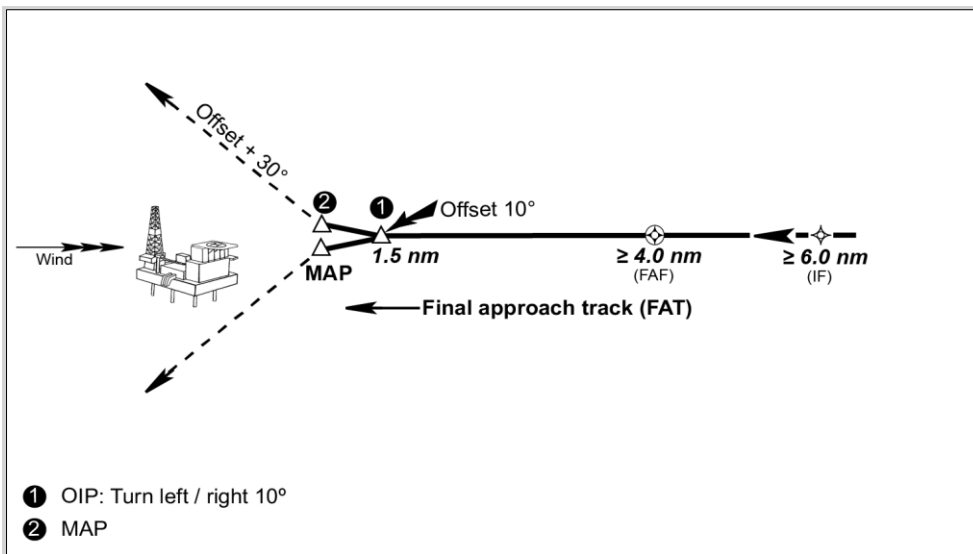
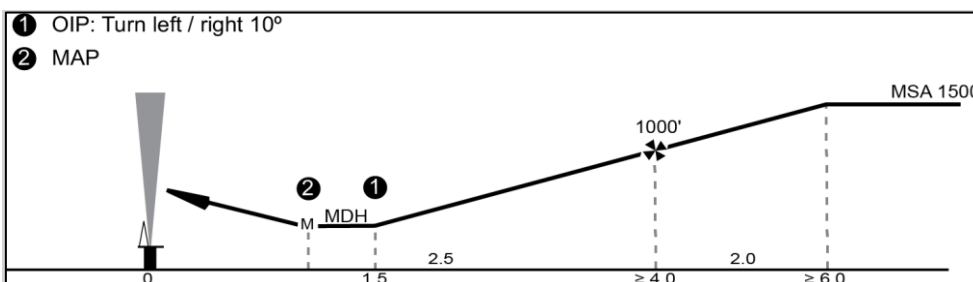

Figure 2 — Vertical profile



GM2 SPA.HOFO.125 Airborne radar approach (ARA) to offshore locations

GLOBAL NAVIGATION SATELLITE SYSTEM (GNSS)/AREA NAVIGATION SYSTEM

Where an ARA is conducted to a non-moving offshore location (i.e. fixed installation or moored vessel), and the GNSS/area navigation system is used to enhance the safety of the ARA, the following procedure or equivalent should be applied:

- (a) selection from the area navigation system database or manual entry of the offshore location;
- (b) manual entry of the final approach fix (FAF) or intermediate fix (IF), as a range of and bearing from the offshore location;
- (c) operation of the GNSS equipment in terminal mode;
- (d) comparison of weather radar and GNSS range and bearing data to cross-check the position of the offshore location;
- (e) use of GNSS guidance to guide the aircraft onto the final approach track during the initial or intermediate approach segments;
- (f) use of GNSS guidance from the FAF towards the offset initiation point (OIP) during the final approach segment to establish the helicopter on the correct approach track and, hence, heading;
- (g) transition from GNSS guidance to navigation based on headings once the track is stabilised and before reaching OIP;
- (h) use of GNSS range of and bearing to the offshore location during the intermediate and final approach segments to cross-check weather radar information (for correct 'painting' of the destination and, hence, of other obstacles);
- (i) use of GNSS range of the offshore location to enhance confidence in the weather radar determination of arrival at the OIP and MAPt; and
- (j) use of GNSS range of and bearing to the destination to monitor separation from the offshore location.

AMC1 SPA.HOFO.140 Performance requirements — take-off and landing at offshore locations

FACTORS

To ensure that the necessary factors are taken into account, operators not conducting CAT operations should use take-off and landing procedures that are appropriate to the circumstances and have been developed in accordance with ORO.MLR.100 in order to minimise the risks of collision with obstacles at the individual offshore location under the prevailing conditions.

AMC1 SPA.HOFO.145 Flight data monitoring (FDM) programme

FDM PROGRAMME

Refer to AMC1 ORO.AOC.130.

Note: Appendix 1 to AMC1 ORO.AOC.130 is not valid for helicopters.

GM1 SPA.HOFO.145 Flight data monitoring (FDM) programme

DEFINITION OF AN FDM PROGRAMME

Refer to GM1 ORO.AOC.130, except for the examples that are specific to aeroplane operation.

GM2 SPA.HOFO.145 Flight data monitoring (FDM) programme

FDM

Additional guidance material for the establishment of a FDM programme is found in:

- (a) International Civil Aviation Organization (ICAO) Doc 10000 — Manual on Flight Data Analysis Programmes (FDAP); and
- (b) United Kingdom Civil Aviation Authority (UK CAA) CAP 739 — Flight Data Monitoring.

The following table provides examples of FDM events that may be further developed using operator- and helicopter-specific limits. The table is considered illustrative and non-exhaustive.

Table 1 — Examples of FDM events

Event title/description	Parameters required	Comments
Ground		
Outside air temperature (OAT) high — Operating limits	OAT	To identify when the helicopter is operated at the limits of OAT.
Sloping-ground high-pitch attitude	Pitch attitude, ground switch (similar)	To identify when the helicopter is operated at the slope limits.
Sloping-ground high-roll attitude	Roll attitude, ground switch (similar)	To identify when the helicopter is operated at the slope limits.
Rotor brake on at an excessive number of rotations (main rotor speed) (NR)	Rotor brake discreet, NR	To identify when the rotor brake is applied at too high NR.
Ground taxiing speed — max	Ground speed (GS), ground switch (similar)	To identify when the helicopter is ground taxed at high speed (wheeled helicopters only).
Air taxiing speed — max	GS, ground switch (similar), radio altitude (Rad Alt)	To identify when the helicopter is air taxied at high speed.
Excessive power during ground taxiing	Total torque (Tq), ground switch (similar), GS	To identify when excessive power is used during ground taxiing.
Pedal — max left-hand (LH) and right-hand (RH) taxiing	Pedal position, ground switch (similar), GS or NR	To identify when the helicopter flight controls (pedals) are used to excess on the ground. GS or NR to exclude control test prior to rotor start.
Excessive yaw rate on ground during taxiing	Yaw rate, ground switch (similar), or Rad Alt	To identify when the helicopter yaws at a high rate when on the ground.
Yaw rate in hover or on ground	Yaw rate, GS, ground switch (similar)	To identify when the helicopter yaws at a high rate when in a

		hover.
High lateral acceleration (rapid cornering)	Lateral acceleration, ground switch (similar)	To identify high levels of lateral acceleration, when ground taxiing, that indicate high cornering speed.
High longitudinal acceleration (rapid braking)	Longitudinal acceleration, ground switch (similar)	To identify high levels of longitudinal acceleration, when ground taxiing, that indicate excessive braking.
Cyclic-movement limits during taxiing (pitch or roll)	Cyclic stick position, ground switch (similar), Rad Alt, NR or GS	To identify excessive movement of the rotor disc when running on ground. GS or NR to exclude control test prior to rotor start.
Excessive longitudinal and lateral cyclic rate of movement on ground	Longitudinal cyclic pitch rate, lateral cyclic pitch rate, NR	To detect an excessive rate of movement of cyclic control when on the ground with rotors running.
Lateral cyclic movement — closest to LH and RH rollover	Lateral cyclic position, pedal position, roll attitude, elapsed time, ground switch (similar)	To detect the risk of a helicopter rollover due to an incorrect combination of tail rotor pedal position and lateral cyclic control position when on ground.
Excessive cyclic control with insufficient collective pitch on ground	Collective pitch, longitudinal cyclic pitch, lateral cyclic pitch	To detect an incorrect taxiing technique likely to cause rotor head damage.
Inadvertent lift-off	Ground switch (similar), autopilot discreet	To detect inadvertent lifting into hover.
Flight — Take-off and landing		
Day or night landing or take-off	Latitude and Longitude (Lat & Long), local time or UTC	To provide day/night relevance to detected events.
Specific location of landing or take-off	Lat & Long, ground switch (similar), Rad Alt, total Tq	To give contextual information concerning departures and destinations.
Gear extension and retraction — airspeed limit	Indicated airspeed (IAS), gear position	To identify when undercarriage airspeed limitations are breached.
Gear extension & retraction — height limit	Gear position, Rad Alt	To identify when undercarriage altitude limitations are breached.
Heavy landing	Normal/vertical acceleration, ground switch (similar)	To identify when hard/heavy landings take place.

Cabin heater on (take-off and landing)	Cabin heater discreet, ground switch (similar)	To identify use of engine bleed air during periods of high power demand.
High GS prior to touchdown (TD)	GS, Rad Alt, ground switch (similar), elapsed time, latitude, longitude	To assist in the identification of 'quick stop' approaches.
Flight — Speed		
High airspeed — with power	IAS, Tq 1, Tq 2, pressure altitude (Palt), OAT	To identify excessive airspeed in flight.
High airspeed — low altitude	IAS, Rad Alt	To identify excessive airspeed in low-level flight.
Low airspeed at altitude	IAS, Rad Alt	To identify a 'hover out of ground' effect.
Airspeed on departure (< 300 ft)	IAS, ground switch (similar), Rad Alt	To identify shallow departure.
High airspeed — power off	IAS, Tq 1, Tq 2 or one engine inoperative (OEI) discreet, Palt, OAT	To identify limitation exceedance of power-off airspeed.
Downwind flight within 60 sec of take-off	IAS, GS, elapsed time	To detect early downwind turn after take-off.
Downwind flight within 60 sec of landing	IAS, GS, elapsed time	To detect late turn to final shortly before landing.
Flight — Height		
Altitude — max	Palt	To detect flight outside of the published flight envelope.
Climb rate — max	Vertical speed (V/S), or Palt, or Rad Alt, Elapsed time	Identification of excessive rates of climb (RoC) can be determined from an indication/rate of change of Palt or Rad Alt.
High rate of descent	V/S	To identify excessive rates of descent (RoD).
High rate of descent (speed or height limit)	V/S, IAS or Rad Alt or elevation	To identify RoD at low level or low speed.
Settling with power (vortex ring)	V/S, IAS, GS, Tq	To detect high-power settling with low speed and with excessive rate of descent.
Minimum altitude in autorotation	NR, total Tq, Rad Alt	To detect late recovery from autorotation.

Low cruising (inertial systems)	GS, V/S, elevation, Lat & Long	To detect an extended low-level flight. Ground speed is less accurate with more false alarms. Lat & Long used for geographical boundaries.
Low cruising (integrated systems)	Rad Alt, elapsed time, Lat & Long, ground switch (similar)	To detect an extended low-level flight.
Flight — Attitude and controls		
Excessive pitch (height related — turnover (T/O), cruising or landing)	Pitch attitude, Rad Alt elevation, Lat & Long	To identify inappropriate use of excessive pitch attitude during flight. Height limits may be used (i.e. on take-off and landing or < 500 ft) — Lat & Long required for specific-location-related limits. Elevation less accurate than Rad Alt. Elevation can be used to identify the landing phase in a specific location.
Excessive pitch (speed related — T/O, cruising or landing)	Pitch attitude, IAS, GS, Lat & Long	To identify inappropriate use of excessive pitch attitude during flight. Speed limits may be used (i.e. on take-off and landing or in cruising) — Lat & Long required for specific-location-related limits. GS less accurate than IAS.
Excessive pitch rate	Pitch rate, Rad Alt, IAS, ground switch (similar), Lat & Long	To identify inappropriate use of excessive rate of pitch change during flight. Height limits may be used (i.e. on take-off and landing). IAS only for IAS limit, ground switch (similar) and Lat & Long required for specific-location-related limits.
Excessive roll/bank attitude (speed or height related)	Roll attitude, Rad Alt, IAS/GS	To identify excessive use of roll attitude. Rad Alt may be used for height limits, IAS/GS may be used for speed limits.
Excessive roll rate	Roll rate, Rad Alt, Lat & Long, Ground switch (similar)	Rad Alt may be used for height limits, Lat & Long and ground switch (similar) required for specific-location-related and

		air/ground limits.
Excessive yaw rate	Yaw rate	To detect excessive yaw rates in flight.
Excessive lateral cyclic control	Lateral cyclic position, ground switch (similar)	To detect movement of the lateral cyclic control to extreme left or right positions. Ground switch (similar) required for pre or post T/O.
Excessive longitudinal cyclic control	Longitudinal cyclic position, ground switch (similar)	To detect movement of the longitudinal cyclic control to extreme forward or aft positions. Ground switch (similar) required for pre or post T/O.
Excessive collective pitch control	Collective position, ground switch (similar)	To detect exceedances of the aircraft flight manual (AFM) collective pitch limit. Ground switch (similar) required for pre or post T/O.
Excessive tail rotor control	Pedal position, ground switch (similar)	To detect movement of the tail rotor pedals to extreme left and right positions. Ground switch (similar) required for pre or post T/O.
Manoeuvre G loading or turbulence	Lat & Long, normal accelerations, ground switch (similar) or Rad Alt	To identify excessive G loading of the rotor disc, both positive and negative. Ground switch (similar) required to determine air/ground. Rad Alt required if height limit required.
Pilot workload/turbulence	Collective and/or cyclic and/or tail rotor pedal position and change rate (Lat & Long)	To detect high workload and/or turbulence encountered during take-off and landing phases. Lat & Long required for specific landing sites. A specific and complicated algorithm for this event is required. See United Kingdom Civil Aviation Authority (UK CAA) Paper 2002/02.
Cross controlling	Roll rate, yaw rate, pitch rate, GS, accelerations	To detect an 'out of balance' flight. Airspeed could be used instead of GS.

Quick stop	GS (min and max), V/S, pitch	To identify inappropriate flight characteristics. Airspeed could be used instead of GS.
Flight — General		
OEI — Air	OEI discreet, ground switch (similar)	To detect OEI conditions in flight.
Single engine flight	No 1 engine Tq, No 2 engine Tq	To detect single-engine flight.
Torque split	No 1 engine Tq, No 2 engine Tq	To identify engine-related issues.
Pilot event	Pilot event discreet	To identify when flight crews have depressed the pilot event button.
Traffic collision avoidance system (TCAS) traffic advisory (TA)	TCAS TA discreet	To identify TCAS alerts.
Training computer active	Training computer mode active or discreet	To identify when helicopter have been on training flights.
High/low rotor speed — power on	NR, Tq (ground switch (similar), IAS, GS)	To identify mishandling of NR. Ground switch (similar), IAS or ground speed required to determine whether helicopter is airborne.
High/low rotor speed — power off	NR, Tq (ground switch (similar), IAS, GS)	To identify mishandling of NR. Ground switch (similar), IAS or ground speed to determine whether helicopter is airborne.
Fuel content low	Fuel contents	To identify low-fuel alerts.
Helicopter terrain awareness and warning system (HTAWS) alert	HTAWS alerts discreet	To identify when HTAWS alerts have been activated.
Automatic voice alert device (AVAD) alert	AVAD discreet	To identify when AVAD alerts have been activated.
Bleed air system use during take-off (e.g. heating)	Bleed air system discreet, ground switch (similar), IAS	To identify use of engine bleed air during periods of high power demand.
Rotors' running duration	NR, elapsed time	To identify rotors' running time for billing purposes.
Flight — Approach		
Stable approach heading change	Magnetic heading, Rad Alt, ground switch (similar), gear position, elapsed time	To identify unstable approaches.

Stable approach pitch attitude	Pitch attitude, Rad Alt, ground switch (similar), gear position	To identify unstable approaches.
Stable approach rod GS	Altitude rate, Rad Alt, ground switch (similar), gear position	To identify unstable approaches.
Stable approach track change	Track, Rad Alt, ground switch (similar), gear position	To identify unstable approaches.
Stable approach angle of bank	Roll attitude, Rad Alt, ground switch (similar), gear position	To identify unstable approaches.
Stable approach — rod at specified height	Altitude rate, Rad Alt, ground switch (similar), gear position	To identify unstable approaches.
Stable approach — IAS at specified height	IAS, Rad Alt, ground switch (similar), gear position	To identify unstable approaches.
Glideslope deviation above or below	Glideslope deviation	To identify inaccurately flown instrument landing system (ILS) approaches.
Localiser deviation left and right	Localiser deviation	To identify inaccurately flown ILS approaches.
Low turn to final	Elevation, GS, V/S, heading change	Airspeed could be used instead of GS.
Premature turn to final	Elevation, GS, V/S, heading change	Airspeed could be used instead of GS.
Stable approach — climb	IAS (min & max), V/S (min & max), elevation	To identify unstable approaches.
Stable approach — descent	IAS (min & max), V/S, elevation	To identify unstable approaches.
Stable approach — bank	IAS (min & max), V/S, elevation, roll	To identify unstable approaches.
Stable approach — late turn	Heading change, elevation, GS	To identify unstable approaches.
Go-around	Gear select (Rad Alt)	To identify missed approaches. Rad Alt for height limit.
Rate of descent on approach	Altitude rate, Rad Alt, Lat & Long, ground switch (similar)	To identify high rates of descent when at low level on approach. Rad Alt if below specified height, Lat & Long for specified location required.
Flight — Autopilot		
Condition of autopilot in flight	Autopilot discreet	To detect flight without autopilot engaged; per channel for

		multichannel autopilots.
Autopilot engaged within 10 sec after take-off	Autopilot engaged discreet, elapsed time, ground switch (similar), total Tq, Rad Alt	To identify inadvertent lift-off without autopilot engaged.
Autopilot engaged on ground (postflight or preflight)	Autopilot engaged discreet, elapsed time, ground switch (similar), total Tq, Rad Alt	To identify inappropriate use of autopilot when on ground. Elapsed time required to allow for permissible short periods.
Excessive pitch attitude with autopilot engaged on ground (offshore)	Pitch attitude, autopilot discreet, ground switch (similar), Lat & Long	To identify potential for low NR when helicopter pitches on floating helideck.
Airspeed hold engaged — airspeed (departure or non-departure)	Autopilot modes discreet, IAS, (ground switch (similar), total Tq, Rad Alt)	To detect early engagement of autopilot higher modes. Ground switch (similar), total Tq and Rad Alt to determine if the flight profile is 'departure'.
Airspeed hold engaged — altitude (departure or non-departure)	Autopilot modes discreet, Rad Alt, (IAS, ground switch (similar), total Tq)	To detect early engagement of autopilot higher modes. IAS, ground switch (similar), total Tq to determine if the flight profile is 'departure'.
Alt mode engaged — altitude (departure or non-departure)	Autopilot modes discreet, Rad Alt, (ground switch (similar), total Tq, IAS)	To detect early engagement of autopilot higher modes. Ground switch (similar), total Tq and Rad Alt to determine if the flight profile is 'departure'.
Alt mode engaged — airspeed (departure or non-departure)	Autopilot modes discreet, IAS, (ground switch (similar), total Tq, Rad Alt)	To detect early engagement of autopilot higher modes. IAS, ground switch (similar), total Tq to determine if the flight profile is 'departure'.
Heading mode engaged — speed	Autopilot modes discreet, IAS	To detect engagement of autopilot higher modes below minimum speed limitations. Ground switch (similar), total Tq and Rad Alt to determine if the flight profile is 'departure'.
V/S mode active — below specified speed	Autopilot modes discreet, IAS	To detect engagement of autopilot higher modes below minimum speed limitations.
VS mode engaged — altitude	Autopilot modes discreet, IAS,	To detect early engagement of

(departure or non-departure)	(WOW, total Tq, Rad Alt)	autopilot higher modes. Ground switch (similar), total Tq and Rad Alt to determine if the flight profile is 'departure'.
Flight director (FD) engaged — speed	FD discreet, IAS	To detect engagement of autopilot higher modes below minimum speed limitations.
FD-coupled approach or take off — airspeed	FD discreet, IAS, ground switch (similar)	To detect engagement of autopilot higher modes below minimum speed limitations.
Go-around mode engaged — airspeed	Autopilot modes discreet, IAS, ground switch (similar), total Tq, Rad Alt	To detect engagement of autopilot higher modes below minimum speed limitations.
Flight without autopilot channels engaged	Autopilot channels	To detect flight without autopilot engaged; per channel for multichannel autopilots.

AMC1 SPA.HOFO.150 Aircraft tracking system

GENERAL

Flights should be tracked and monitored from take-off to landing. This function may be achieved by the air traffic services (ATS) when the planned route and the planned diversion routes are fully included in airspace blocks where:

- (a) ATS surveillance service is normally provided and supported by ATC surveillance systems locating the aircraft at time intervals with adequate duration; and
- (b) the operator has given to competent air navigation services (ANS) providers the necessary contact information.

In all other cases, the operator should establish a detailed procedure describing how the aircraft tracking system is to be monitored, and what actions and when are to be taken if a deviation or anomaly has been detected.

GM1 SPA.HOFO.150 Aircraft tracking system

OPERATIONAL PROCEDURE

The procedure should take into account the following aspects:

- (a) the outcome of the risk assessment made when the update frequency of the information was defined;
- (b) the local environment of the intended operations; and
- (c) the relationship with the operator's emergency response plan.

Aircraft tracking data should be recorded on the ground and retained for at least 48 h. Following an accident or a serious incident subject to investigation, the data should be retained for at least 30 days, and the operator should be capable of providing a copy of this data without delay.

AMC1 SPA.HOFO.155 Vibration health monitoring (VHM) system

GENERAL

Any VHM system should meet all of the following criteria:

(a) VHM system capability

The VHM system should measure vibration characteristics of rotating critical components during flight, using suitable vibration sensors, techniques, and recording equipment. The frequency and flight phases of data measurement should be established together with the type certificate holder (TCH) during the initial entry into service. In order to appropriately manage the generated data and focus upon significant issues, an alerting system should be established; this is normally automatic. Accordingly, alert generation processes should be developed to reliably advise maintenance personnel of the need to intervene and help determine what type of intervention is required.

(b) Approval of VHM installation

The VHM system, which typically comprises vibration sensors and associated wiring, data acquisition and processing hardware, the means of downloading data from the helicopter, the ground-based system and all associated instructions for operation of the system, should be certified in accordance with CS-29 or equivalent, established by the Agency.

Note: for applications that may also provide maintenance credit (see Federal Aviation Administration (FAA) Advisory Circular (AC) 29-2C Miscellaneous Guidance (MG) 15), the level of system integrity required may be higher.

(c) Operational procedures

The operator should establish procedures to address all necessary VHM subjects.

(d) Training

The operator should determine which staff will require VHM training, determine appropriate syllabi, and incorporate them into the operator's initial and recurrent training programmes.

GM1 SPA.HOFO.155 Vibration health monitoring (VHM) system

GENERAL

Operators should utilise available international guidance material provided for the specification and design of VHM systems.

Further guidance can be found in:

(a) CS 29.1465 Vibration health monitoring and associated AMC;

(b) Federal Aviation Administration (FAA) Advisory Circular (AC) 29-2C Miscellaneous Guidance (MG) 15 — Airworthiness Approval of Rotorcraft Health Usage Monitoring Systems (HUMSs); and

(c) United Kingdom Civil Aviation Authority (UK CAA) CAP 753 — Helicopter Vibration Health Monitoring.

GM1 SPA.HOFO.160(a)(1) Additional equipment requirements

PUBLIC ADDRESS (PA) SYSTEM

When demonstrating the performance of the PA system or that the pilot's voice is understandable at all passengers' seats during flight, the operator should ensure compatibility with the passengers' use of ear defenders/ear plugs (hearing protection). The operator should only provide hearing protection that is compatible with the intelligibility of the PA system or pilot's voice, as appropriate.

GM1 SPA.HOFO.160(a)(2) Additional equipment requirements

RADIO ALTIMETER

For additional information, please refer to AMC1 CAT.IDE.H.145 Radio altimeters and AMC2 CAT.IDE.H.145 Radio altimeters, as well as to GM1 CAT.IDE.H.145 Radio altimeters.

AMC1 SPA.HOFO.165(c) Additional procedures and equipment for operations in hostile environment

EMERGENCY BREATHING SYSTEM (EBS)

The EBS of SPA.HOFO.165(c) should be an EBS system capable of rapid underwater deployment.

AMC1 SPA.HOFO.165(d) Additional procedures and equipment for operations in hostile environment

INSTALLATION OF THE LIFE RAFT

- (a) Projections on the exterior surface of the helicopter that are located in a zone delineated by boundaries that are 1.22 m (4 ft) above and 0.61 m (2 ft) below the established static waterline could cause damage to a deployed life raft. Examples of projections that need to be considered are aerials, overboard vents, unprotected split-pin tails, guttering, and any projection sharper than a three-dimensional right-angled corner.
- (b) While the boundaries specified in (a) above are intended as a guide, the total area that should be considered should also take into account the likely behaviour of the life raft after deployment in all sea states up to the maximum in which the helicopter is capable of remaining upright.
- (c) Wherever a modification or alteration is made to a helicopter within the boundaries specified, the need to prevent the modification or alteration from causing damage to a deployed life raft should be taken into account in the design.
- (d) Particular care should also be taken during routine maintenance to ensure that additional hazards are not introduced by, for example, leaving inspection panels with sharp corners proud of the surrounding fuselage surface, or by allowing door sills to deteriorate to a point where their sharp edges may become a hazard.

AMC1 SPA.HOFO.165(h) Additional procedures and equipment for operations in a hostile environment

EMERGENCY EXITS AND ESCAPE HATCHES

In order for all passengers to escape from the helicopter within an expected underwater survival time of 60 sec in the event of capsizing, the following provisions should be made:

- (a) there should be an easily accessible emergency exit or suitable opening for each passenger;
- (b) an opening in the passenger compartment should be considered suitable as an underwater escape facility if the following criteria are met:

- (1) the means of opening should be rapid and obvious;
 - (2) passenger safety briefing material should include instructions on the use of such escape facilities;
 - (3) for the egress of passengers with shoulder width of 559 mm (22 in.) or smaller, a rectangular opening should be no smaller than 356 mm (14 in.) wide, with a diagonal between corner radii no smaller than 559 mm (22 in.), when operated in accordance with the instructions;
 - (4) non-rectangular or partially obstructed openings (e.g. by a seat back) should be capable of admitting an ellipse of 559 mm x 356 mm (22 in. x 14 in.); and
 - (5) for the egress of passengers with shoulder width greater than 559 mm (22 in.), openings should be no smaller than 480 mm x 660 mm (19 in. x 26 in.) or be capable of admitting an ellipse of 480 mm x 660 mm (19 in. x 26 in.);
- (c) suitable openings and emergency exits should be used for the underwater escape of no more than two passengers, unless large enough to permit the simultaneous egress of two passengers side by side:
- (1) if the exit size provides an unobstructed area that encompasses two ellipses of size 480 mm x 660 mm (19 in. x 26 in.) side by side, then it may be used for four passengers; and
 - (2) if the exit size provides an unobstructed area that encompasses two ellipses of size 356 mm x 559 mm (14 in. x 22 in.) side by side, then it may be used for four passengers with shoulder width no greater than 559 mm (22 in.) each; and
- (d) passengers with shoulder width greater than 559 mm (22 in.) should be identified and allocated to seats with easy access to an emergency exit or opening that is suitable for them.

GM1 SPA.HOFO.165(h) Additional procedures and equipment for operations in a hostile environment

SEAT ALLOCATION

The identification and seating of the larger passengers might be achieved through the use of patterned and/or colour-coded armbands and matching seat headrests.

AMC1 SPA.HOFO.165(i) Additional procedures and equipment for operations in a hostile environment

MEDICALLY INCAPACITATED PASSENGER

- (a) A 'Medically incapacitated passenger' means a person who is unable to wear the required survival equipment, including life jackets, survival suits and emergency breathing systems (EBSs), as determined by a medical professional. The medical professional's determination should be made available to the pilot-in-command/commander prior to arrival at the offshore installation.
- (b) The operator should establish procedures for the cases where the pilot-in-command/commander may accept a medically incapacitated passenger not wearing or partially wearing survival equipment. To ensure proportionate mitigation of the risks associated with an evacuation, the procedures should be based on, but not be limited to, the severity of the incapacitation, sea and air temperature, sea state, and number of passengers on board.

In addition, the operator should establish the following procedures:

- (1) under which circumstances one or more dedicated persons are required to assist a medically incapacitated passenger during a possible emergency evacuation, and the skills and qualifications required;

- (2) seat allocation for the medically incapacitated passenger and possible assistants in the helicopter types used to ensure optimum use of the emergency exits; and
- (3) evacuation procedures related to whether or not the dedicated persons as described in (1) above are present.

AMC1 SPA.HOFO.170(a) Crew requirements

FLIGHT CREW TRAINING AND CHECKING

- (a) Flight crew training programmes should:
 - (1) improve knowledge of the offshore operations environment with particular consideration of visual illusions during approach, introduced by lighting, motion and weather factors;
 - (2) improve crew cooperation specifically for offshore operations;
 - (3) provide flight crew members with the necessary skills to appropriately manage the risks associated with normal, abnormal and emergency procedures during flights by day and night;
 - (4) if night operations are conducted, give particular consideration to approach, go-around, landing, and take-off phases;
 - (5) include instructions on the optimum use of the helicopter's automatic flight control system (AFCS);
 - (6) for multi-pilot operation, emphasise the importance of multi-crew procedures, as well as the role of the pilot monitoring during all phases of the flight; and
 - (7) include standard operating procedures.
- (b) Emergency and safety equipment training should focus on the equipment fitted/carried. Water entry and sea survival training, including operation of all associated safety equipment, should be an element of the recurrent training, as described in AMC1 ORO.FC.230(a)(2)(iii)(F).
- (c) The training elements referred to above should be assessed during: operator proficiency checks, line checks, or, as applicable, emergency and safety equipment checks.
- (d) Training and checking should make full use of full flight simulators (FFSs) for normal, abnormal, and emergency procedures related to all aspects of helicopter offshore operations (HOFO).