



# Notice of Proposed Amendment 2018-06(B)

## All-weather operations

RMT.0379

### EXECUTIVE SUMMARY

The objective of rulemaking task (RMT).0379 is to modernise the European Union (EU) aviation regulatory framework applicable to all-weather operations (AWOs) so it ensures the highest level of safety while enabling efficiency gains based on the latest technological advancements. It addresses in a coordinated manner all relevant disciplines: initial airworthiness, air operations, flight crew licensing and aerodromes. It proposes performance- and risk-based approach, as much as feasible, considering also the appropriate balance between performance-based and prescriptive principles (depending on the type of air operations (CAT, NCC, NCO, and SPO).

This NPA proposes to update the AWO-relevant rules in many aviation domains such as airworthiness (CS-AWO), air operations (Commission Regulation (EU) No 965/2012), aircrew (Commission Regulation (EU) No 1178/2011) and aerodromes (Commission Regulation (EU) No 139/2014, including CS-ADR.DSN). The main aim has been to allow for a better integration of the regulatory requirements related to the operational use of new, advanced technology — either developed already or to be developed in the future — such as, for example, enhanced flight vision system (EFVS), as well as the application of some advanced new operational procedures, which may support AWOs.

Significant focus has been invested in developing resilient rules, which are not technology-dependent. A particular attention was paid to the development of requirements enabling the use of EFVS to the maximum extent possible (e.g. use of EFVS for landing). A new concept of ‘light operational credits’ for EFVS 200 operations, not requiring the use of specific low-visibility procedures, has also been introduced.

The proposed changes are expected to maintain safety, reduce the regulatory burden, increase cost-effectiveness, improve harmonisation (e.g. with the Federal Aviation Administration (FAA)), and achieve as much as feasible alignment with the Standards and Recommended Practices (SARPs) of the International Civil Aviation Organization (ICAO).

NPA 2018-06 is divided in four parts. The present sub-NPA(B) includes:

- the procedural information pertaining to the regulatory proposal; and
- the proposed amendments to CS-AWO (initial airworthiness).

The other sub-NPAs are organised as follows:

- sub-NPA(A) – procedural information pertaining to the regulatory proposal; presentation of the issue under discussion; impact assessment as well as the hazard identification and risk assessment; and proposed actions to support implementation;
- sub-NPA(C) – air operations and aircrew; and
- sub-NPA(D) – aerodromes.

<b>Action area:</b>	Airlines, air operators other than airlines		
<b>Affected rules:</b>	AMC/GM to the Air OPS Regulation (Commission Regulation (EU) No 965/2012); AMC/GM to the Aircrew Regulation (Commission Regulation (EU) No 1178/2011); AMC/GM to the aerodromes rules (Commission Regulation (EU) No 139/2014, including CS-ADR.DSN); and CS-AWO		
<b>Affected stakeholders:</b>	manufacturers, maintenance organisations (MOs), air operators, approved training organisations (ATOs), aerodrome operators, ATM/ANS, Member States		
<b>Driver:</b>	Level playing field	<b>Rulemaking group:</b>	No
<b>Impact assessment:</b>	Light	<b>Rulemaking Procedure:</b>	Standard

● EASA rulemaking process milestones

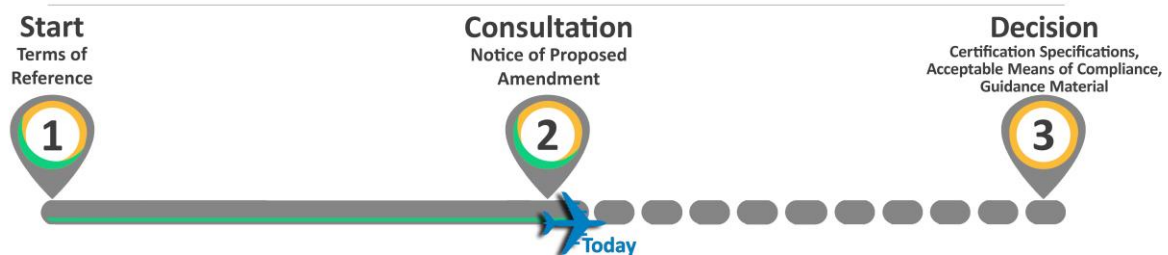

09.12.2015

13.7.2018

2019/Q1



## Table of contents

<b>1. About this NPA .....</b>	<b>3</b>
1.1. How this NPA was developed .....	3
1.2. How to comment on this NPA.....	3
1.3. The next steps .....	3
<b>2. Proposed amendments to CS-AWO .....</b>	<b>5</b>
CS-AWO — Book 1 and Book 2 .....	5
CSs and Acceptable Means of Compliance for All-Weather Operations (CS-AWO) .....	8
CS-AWO BOOK 1.....	9
CS-AWO BOOK 2.....	63



## 1. About this NPA

### 1.1. How this NPA was developed

The European Aviation Safety Agency (EASA) developed this NPA in line with Regulation (EC) No 216/2008<sup>1</sup> (hereinafter referred to as the 'Basic Regulation') and the Rulemaking Procedure<sup>2</sup>. This rulemaking activity is included in the EASA 5-year Rulemaking Programme<sup>3</sup> under RMT.0379.

RMT.0379 was initiated with the publication of the related Terms of Reference (ToR) and Concept Paper RMT.0379 Issue 1<sup>4</sup> on 9 December 2015. For the development of the implementing rules (IRs), the accelerated procedure<sup>5</sup> is applied; for the development of the acceptable means of compliance (AMC), guidance material (GM) and certification specifications (CSs), the standard rulemaking procedure is followed. As part of the accelerated procedure, EASA has already consulted its Advisory Bodies (ABs) on the regulatory impact assessment (RIA)<sup>6</sup> and the description of operations (DoOs). In the context of the second consultation phase (focused consultation), EASA consulted on the proposed amendments to the IRs only. In addition, EASA provided responses to the comments received during the AB consultation and presented the subsequent amendments to the RIA and the DoOs.

The text of this NPA has been developed by EASA based on the input of the Experts' Task Force Groups (air operations, airworthiness, and aerodromes). It is hereby submitted to all interested parties<sup>7</sup> for consultation.

### 1.2. How to comment on this NPA

Please submit your comments using the automated **Comment-Response Tool (CRT)** available at <http://hub.easa.europa.eu/crt/><sup>8</sup>.

The deadline for submission of comments is **15 October 2018**.

### 1.3. The next steps

Following the closing of the public commenting period, EASA will review all comments.

Based on the comments received EASA will:

- update the proposed text of the affected CSs and AMC; and

<sup>1</sup> Regulation (EC) No 216/2008 of the European Parliament and of the Council of 20 February 2008 on common rules in the field of civil aviation and establishing a European Aviation Safety Agency, and repealing Council Directive 91/670/EEC, Regulation (EC) No 1592/2002 and Directive 2004/36/EC (OJ L 79, 19.3.2008, p. 1) (<http://eur-lex.europa.eu/legal-content/EN/TXT/?qid=1467719701894&uri=CELEX:32008R0216>).

<sup>2</sup> EASA is bound to follow a structured rulemaking process as required by Article 52(1) of Regulation (EC) No 216/2008. Such a process has been adopted by the EASA Management Board (MB) and is referred to as the 'Rulemaking Procedure'. See MB Decision No 18-2015 of 15 December 2015 replacing Decision 01/2012 concerning the procedure to be applied by EASA for the issuing of opinions, certification specifications and guidance material (<http://www.easa.europa.eu/the-agency/management-board/decisions/easa-mb-decision-18-2015-rulemaking-procedure>).

<sup>3</sup> <http://easa.europa.eu/rulemaking/annual-programme-and-planning.php>

<sup>4</sup> <https://www.easa.europa.eu/system/files/dfu/ToR%20and%20Concept%20Paper%20RMT.0379%20Issue%201.pdf>

<sup>5</sup> In accordance with Article 16 of MB Decision No 18-2015.

<sup>6</sup> The RIA for the entire NPA is presented in Sub-NPA (A), Chapter 3.

<sup>7</sup> In accordance with Article 52 of Regulation (EC) No 216/2008 and Articles 6(3) and 7) of the Rulemaking Procedure.

<sup>8</sup> In case of technical problems, please contact the CRT webmaster ([crt@easa.europa.eu](mailto:crt@easa.europa.eu)).



- issue a decision containing CS-AWO.

The comments received and the EASA responses will be reflected in a comment-response document (CRD). The CRD will be annexed to the decision.



## 2. Proposed amendments to CS-AWO

### CS-AWO — Book 1 and Book 2

In the context of the RMT.0379 activities on AWOs, the CSs for AWOs (CS-AWO) are updated and amended. CS-AWO addresses the required regulatory changes in the airworthiness domain to complement the relevant AWO requirements in other domains from a design and certification point of view by enabling the certification of emerging technologies, such as EFVS, synthetic vision guidance system (SVGS), and CVS and also address special authorisations. In addition, RMT.0379 provided the opportunity to revise and update CS-AWO to reflect developments since it was first published.

The initial issue of CS-AWO (dated 17 October 2003) was based upon the Joint Aviation Authorities (JAA) document JAR-AWO with the inclusion of some of the ongoing JAA Notices of Proposed Amendments (NPAs).

The proposed draft CS-AWO Issue 2 incorporates the outstanding JAA NPAs in order to have an updated baseline document. Content from relevant certification review items (CRIs) has been considered, as well as aligned with other widely used authorities' regulations, such as the FAA's.

The proposed draft of CS-AWO Issue 2 addresses the CSs for Type A operations as a baseline for any applicable operational credits, the CSs for Type B category 1 operations as a baseline for operational credits, and the revised CSs for Type B category 2 and 3 operations to ensure that they reflect current technologies and support the intended operations. The revised CS-AWO also provides and clarifies as well the CSs for airborne equipment to gain the benefits from operational credits including SA CAT I, EFVSs to 100 ft and EFVSs/CVSs to touchdown, and provides the CSs for aircraft conducting taxiing and/or take-off operations in low-visibility conditions. CS-AWO has also been completely restructured to better reflect the utility of the document. As much as possible of the original CS-AWO text was retained in order to build upon its well established foundations. The table below shows the relationship between the initial issue of CS-AWO and the restructured Issue 2.

CS-AWO Initial Issue	CS-AWO Issue 2
	<b>Subpart A — Enabling Equipment</b>
Subpart 1	Section 1: Automatic Landing Systems
N/A	Section 2: Head Up Displays (HUD)
N/A	Section 3: Enhanced Flight Vision Systems (EFVS)
N/A	Section 4: Synthetic Vision Guidance Systems (SVGS)
N/A	Section 5: Combined Vision Systems (CVS)
	<b>Subpart B — Approach and Landing</b>

CS-AWO Initial Issue	CS-AWO Issue 2
N/A	Section 1: Airworthiness certification of aeroplanes for Type B operations with decision heights/altitude below 250 ft down to 200 ft — Category 1 operations (CAT I)
N/A	Section 2: Airworthiness certification of aeroplanes for operations with decision heights below 60 m (200 ft) and down to 45 m (150 ft) — Special Authorisation Category 1 operations (SA CAT I)
Sub-part 2	Section 3: Airworthiness certification of aeroplanes for operations with decision heights below 60 m (200 ft) and down to 30 m (100 ft) — Category 2 operations (CAT II)
Sub-part 3	Section 4: Airworthiness certification of aeroplanes for operations with decision heights below 30 m (100 ft) or no decision height — Category 3 operations (CAT III)
N/A	Section 5: Airworthiness certification of aeroplanes for operational credits for visual segment in reduced runway visual range (RRVR)
	<b>Subpart C — Take-off</b>
Sub-part 4	Section 1: Airworthiness certification of aeroplanes for take-off operations in low visibility (TOO)

Strikethrough and highlights have been included to show the evolution of the document and allow the reviewer to understand what changes have been made to the existing CS-AWO text.

Subpart A provides the certification specifications for the various enabling equipment that can be used to facilitate AWOs or operations in low visibility. The intent is that the equipment provisions are independent (to the greatest extent possible) of the intended operation. It is possible that one or more of the sections of Subpart A will be used for particular design or configuration (e.g. an EFVS displayed on a HUD). Subpart A includes the certification specifications for automatic landing systems, head-up displays, enhanced flight vision systems for approach and landing, synthetic vision guidance systems and combined vision systems.

Subpart B provides the required 'performance' of the systems that have been selected by the applicant for the chosen DH or category of landing. The certification specifications for Special Authorisation Category 1 (SA CAT) have been included in CS-AWO Subpart B and should be used to demonstrate that the required performance and level of safety can be achieved for the navigation means that is selected



by the applicant. Particular emphasis is placed on the need to assess the effect on the aircraft from external navigation means that may not be as robust as a Category 2 or 3 facility.

The proposed amendments to CS-AWO include updates to Category 2 and 3 approaches and landings to ensure that they reflect current technologies and support the intended operations.

Subpart C is based upon an amendment to the original text from Subpart 4 and provides a less technology-dependent use of navigation means whilst retaining the original intent of the subpart.

The intention of the new structure of CS-AWO is that for a particular system architecture, an applicant would need to combine the certification specifications from Subparts A and B (and possibly C) in order to achieve the required AWO certification for their product.



**CSs and Acceptable Means of Compliance for All-Weather Operations (CS-AWO)**

**CS-AWO Issue 2**



## CS-AWO BOOK 1

## SUBPART A — ENABLING EQUIPMENT

## SECTION 1

## AUTOMATIC LANDING SYSTEMS (ALS)

## GENERAL

**CS AWO.A.ALS.101 Applicability and terminology**

- (a) Subpart ~~1A~~ Section 1 of this certification specification ~~airworthiness code~~ is applicable to aeroplanes, which are capable of automatic landing carried out in association with an xLS (instrument landing system (ILS), microwave landing system (MLS), and/or ground-based augmentation system (GBAS) landing system (GLS)) ~~both~~. In addition, the automatic landing system ~~must~~ shall meet the requirements of CS 25.1329. ([See AMC AWO.A.ALS.101\(a\)](#))
- ~~(b) The term ‘automatic landing system’ in this CS AWO refers to the airborne equipment, which provides automatic control of the aeroplane during the approach and landing. It includes all of the sensors, computers, actuators and power supplies necessary to control the aeroplane to touchdown. It also includes provisions to control the aeroplane along the runway during the landing rollout. In addition, it includes the indications and control necessary for its management and supervision by the pilot.~~
- (b) If a head-up display (HUD) — or equivalent — is used, then it shall meet the performance and integrity requirements applicable to the type of operation intended. Refer to CS-AWO [Section 2 SA CAT I](#), [Section 3 CAT II](#) or [Section 4 CAT III](#).

**CS AWO.A.ALS.102 Safety level**

The safety level in automatic landing ~~may~~ shall not be less than that achieved in manual landing. Hence, in showing compliance with the performance and failure requirements, the probabilities of performance or failure effects may not be factored by the proportion of landings made under automatic control.

**CS AWO.A.ALS.103 Control actions**

In the absence of failure or extreme conditions, the control actions of the system and the resulting aeroplane flight path ~~may~~ shall not contain unusual features liable to cause a pilot to intervene and assume control.

**CS AWO.A.ALS.104 Approach speed**

The approach speed to be used ~~must~~ shall be established taking into account the accuracy with which speed is controlled. It ~~must~~ shall be specified in the aeroplane flight manual (AFM).

**~~CS AWO 105 – Manual override of automatic pilot~~**

~~When established on the final approach path it must not be possible to change the flight path of the aeroplane with the automatic pilot(s) engaged, except by initiating an automatic go-around.~~

**~~CS AWO 106 – Out of trim forces at disengagement~~**

~~It must be possible to disengage the automatic landing system at any time without the pilot being faced with out-of-trim forces that might lead to an unacceptable flight path disturbance.~~

**~~CS AWO 107 – Manual override of automatic throttle~~**

~~It must be possible to override the automatic throttle (when provided) without using excessive force.~~

**EQUIPMENT****CS AWO.A.ALS.105 Automatic throttle control**

- (a) An automatic landing system ~~must~~ shall include automatic control of throttles to touchdown unless it can be shown that:
- (1) the aeroplane speed can be controlled manually without an excessive workload in conditions for which the system is to be certified certified;
  - (2) with manual control of throttles, the touchdown performance limits of ~~CS-AWO 131~~ [CS AWO.A.ALS.106](#) (c) are achieved; and
  - (3) the touchdown performance is not critically affected by reasonable errors in speed control.
- (b) An automatic throttle system ~~must~~ shall provide safe operation taking into account the factors listed in ~~CS-AWO 131~~ [CS AWO.A.ALS.106](#) (a). The system should:
- (1) adjust throttles to maintain aeroplane speed within acceptable limits (See [AMC AWO.A.ALS.105 \(b\)\(1\)](#)); and
  - (2) provide throttle application at a rate consistent with the recommendations of the appropriate engine and airframe manufacturers.

**PERFORMANCE****CS AWO.A.ALS.106 Performance demonstration**

- (a) The automatic landing system, under the conditions for which its use is to be approved, ~~must~~ shall be demonstrated to achieve the performance accuracy and the limits in ~~CS-AWO 131~~ point (c) below and taking into account at least the following variables:
- (1) configurations of the aeroplane (e.g. flap settings);
  - (2) centre of gravity;
  - (3) landing weight;
  - (4) conditions of wind, turbulence and wind shear (see [AMC AWO.A.ALS.106](#), paragraph 3);
  - (5) ~~xLS ILS and/or MLS~~ characteristics ([AMC AWO.A.ALS.106](#), paragraph 4); and
  - (6) system tolerances.

If limitations are necessary in respect of any of these variables, then these ~~must~~ shall be established.

- (b) ~~Compliance with the accuracy limits of CS-AWO 131 point (c) below~~ must shall be demonstrated by a combination of:
- (1) an analysis (e.g. by simulation) considering reasonable combinations of variables listed in ~~CS-AWO 131 point (a)~~ and in (AMC AWO.A.ALS.106); and
  - (2) validation of any simulation/analysis by flight test demonstrations (using either statistical or deterministic methods).
- (c) It ~~must~~ shall be shown that the touchdown performance will be such that exceedance of any of the limits prescribed in this ~~paragraph~~ provision will be improbable (see AMC AWO.A.ALS.106, paragraph 1.4 for acceptable values for the actual probability level) when the variables follow their expected distribution and also when one of the variables is at its most critical value while the others vary in their expected manner:
- (1) longitudinal touchdown earlier than a point on the runway 60 m (200 ft) from the threshold;
  - (2) longitudinal touchdown beyond the end of the touchdown zone (TDZ) lighting, 823 m (2 700 ft) from threshold;
  - (3) lateral touchdown with the outboard landing gear more than 21 m (70 ft) from runway centre line. (This value assumes a 45 m (150 ft) runway. It may be appropriately increased if operation is limited in the ~~aeroplane flight manual AFM~~ to wider runways, or to runways with load-bearing shoulders);
  - (4) ~~Sink rate for structural limit load;~~ and
  - (5) bank angle resulting in hazard to the aeroplane.; and
  - (6) ~~Lateral velocity or slip angle for structural limit load.~~

#### CS AWO.A.ALS.107 Aerodrome conditions

~~Expected Aerodrome conditions (e.g. elevation, ambient temperature, runway slope and ground profile under the approach path) must shall be investigated considered~~ and appropriate limitations entered in the ~~aeroplane flight manual AFM~~ where necessary. (AMC AWO.A.ALS.106, paragraph 5).

#### CS AWO.A.ALS.108 Approach and automatic landing with an inoperative engine (See AMC AWO.A.ALS.108)

If approval is sought to include automatic landing where the approach is initiated, and the landing made, with an inoperative engine, the automatic landing system ~~must~~ shall be shown to perform a safe landing and, where applicable, safe roll-out in this non-normal aircraft condition taking account of the following:

- (a) the critical engine inoperative, with the propeller, where applicable, feathered;
- (b) all flap positions used for landing with an inoperative engine;
- (c) loss of systems associated with the inoperative engine, e.g. electrical and hydraulic power;
- (d) crosswinds in each direction greater than 18.5 Km/h (10 kt); and
- (e) weight of aircraft.

The go-around from any point on the approach to touchdown ~~must~~ shall not require exceptional piloting skill, alertness or strength and ~~must~~ shall ensure that the aeroplane remains within the obstacle limitation surface for a precision approach runway, Category II or III, specified in ICAO Annex 14.

#### **CS AWO.A.ALS.109 Automatic Landing distance**

The landing distance required ~~must~~ shall be established and scheduled in the aeroplane flight manual AFM if it exceeds the distance scheduled for manual landing for the same conditions (see [AMC AWO.A.ALS.109](#)).

### **CONTROLS, INDICATORS AND ~~WARNINGS~~ALERTS**

#### **CS AWO.A.ALS.110 Controls, indicators and alerts — General**

(See [AMC AWO.A.ALS.110](#))

The controls, indicators and ~~warnings~~ alerts ~~must~~ shall be designed to minimise flight crew errors, which could create a hazard. Mode and system malfunction indications ~~must~~ shall be presented in a manner compatible with the procedures and assigned tasks of the flight crew. The indications ~~must~~ shall be grouped in a logical and consistent manner and be visible under all expected normal lighting conditions.

#### **~~CS.AWO.A.ALS.111 Audible Warning of Automatic Pilot Disengagement~~**

- ~~(a) — Where, following failure of the automatic pilot or loss of the automatic landing mode, it is necessary for the pilot to assume manual control immediately, an audible warning must be given. This audible warning must be distinct from any other audible cockpit warnings and must operate with no delay until silenced by operating the automatic pilot quick release control on the control wheel (see CS 25.1329 (d)). It must be audible to all members of the flight crew specified in the aeroplane Flight Manual.~~
- ~~(b) — The audible warning in paragraph (a) must operate for a period long enough to ensure that it is heard and recognised by the other crew members when the automatic pilot is disengaged by one of the pilots.~~

#### **~~CS.AWO.A.ALS.112 Automatic throttle~~**

- ~~(a) — An indication of automatic throttle engagement must be provided.~~
- ~~(b) — An appropriate alert or warning of automatic throttle failure must be provided.~~
- ~~(c) — Automatic throttle disengagement switches must be mounted on or adjacent to the throttle levers where they can be operated without removing the hand from the throttles.~~

### **FAILURE CONDITIONS**

#### **CS AWO.A.ALS.111 General**

The effects of any failures of, or affecting, the approach and landing system shall be considered in accordance with CS 25.1309 and CS 25.1329.

The effects of engine failures shall also be considered.

- (a) ~~Any single failure or combination of failures affecting trim, flight path or attitude must be shown to be acceptable in relation to its probability. (See CS 25.1309 and its AMC)~~
- (b) ~~Compliance with the requirements of paragraph (a) must be shown by analysis and, where necessary, by appropriate ground simulation or flight tests and may take account of pilot recognition and recovery action in making a landing or go-around as appropriate. (See AMC 25.1309 and AMC 25.1329.)~~

#### **CS AWO.A.ALS.112 ~~xLS ILS and/or MLS navigation means (including signal-in-space) failure~~**

(See [AMC AWO.A.ALS.112](#))

The effects of failures of the navigation means (including signal in space) (if utilised) ~~must~~ shall be investigated taking into account the Standards and Recommended Practices (SARPs) of ICAO Annex 10 relevant to characterisation of failures (e.g. ~~including~~ monitor thresholds, and transmitter changeover or shut down times).

### **AEROPLANE FLIGHT MANUAL**

#### **CS AWO.A.ALS.113 General**

The ~~aeroplane flight manual~~ AFM ~~must~~ shall contain the limitations, procedures and other information pertinent to the operation of the automatic landing system and ~~must~~ shall include the following appropriate to the use for which the particular system has been ~~certified~~ certificated:

- (a) the approved limits established as a result of consideration of the factors listed in ~~CS AWO 131~~ [CS AWO.A.ALS.106](#) (a) and ~~132~~ [CS AWO.A.ALS.107](#);
- (b) the approved limits established as a result of consideration of any other factor that the certification has shown to be appropriate;
- (c) the normal and abnormal procedures, including airspeeds;
- (d) the minimum required equipment;
- (e) any additional aeroplane performance limitations (see ~~CS AWO 142~~ [CS AWO.A.ALS.109](#)); and
- (f) the ~~category type~~ of the ~~xLS ILS and/or MLS ground~~ navigation means (facilities external to the aircraft) and associated limitations (if any) which have been used as the basis for certification (see [AMC AWO.A.ALS.113\(f\)](#)).

#### **CS AWO.A.ALS.114 Wind speed limitations**

Wind speed limitations higher than those established in showing compliance with ~~CS AWO 131~~ [CS AWO.A.ALS.106](#) may be specified in the AFM for decision heights (DHs) of 60 m (200 ft) or more, provided that:

- (a) it can be shown that reliance may be placed on external visual reference for the detection of unsatisfactory performance; and
- (b) the wind speed limits without reliance on external visual reference are not less than 46 km/h (25 kt) head, 28 km/h (15 kt) cross, and 18.5 km/h (10 kt) tail.

**CS AWO.A.ALS.115 Approach and automatic landing with an inoperative engine**

If compliance with ~~CS-AWO-140~~ CS AWO.A.ALS.108 Approach and automatic landing with an inoperative engine (See AMC AWO.A.ALS.108) is established, a statement ~~must~~ shall be included in the Non-normal Procedures, or equivalent section of the flight manual AFM, that approach and automatic landing made with an engine inoperative have been satisfactorily demonstrated, together with the conditions under which that demonstration was made.

**SECTION 2****HEAD-UP DISPLAYS (HUD)****GENERAL****CS AWO.A.HUD.101 Applicability and terminology****(a) Head-up display landing (and if applicable take-off) system**

The term 'head-up display landing system (HUDLS)' refers to the total airborne system which provides head-up guidance to the pilot to enable the pilot to either control the aircraft or to monitor the autopilot during:

- (1) take-off (if applicable);
- (2) approach and landing (and roll-out if applicable); or
- (3) go-around.

It includes all the sensors, computers, power supplies, indications and controls.

**(b) A display will be considered to be equivalent to a HUD providing it can be shown to comply with the following:**

- (1) The display shall be presented head-up and shall not require transition of visual attention to the head-down display in order to view the displayed primary flight information.
- (2) The display shall be conformal with the pilot's external view.
- (3) The display shall enable simultaneous viewing of aircraft flight symbology, imagery (if applicable) and the external view.
- (4) The display shall have characteristics and dynamics that are suitable for manual control of the aircraft.
- (5) The display of imagery, information and symbology shall be clearly visible to the pilot flying in their normal position with the line of vision looking forward along the flight path.

**CS AWO.A.HUD.102 Go-around**

If a HUD (or equivalent) is used for approach guidance, it shall provide sufficient information to permit the pilot to initiate and stabilise a go-around manoeuvre at any point during the approach and the flare without reverting to other displays. This information shall not lead to a speed incompatible with normal go-around procedures and speeds. The approach information shall be removed on selection of go-around unless it is shown that its presence does not interfere with the go-around information. The go-around information shall not be changed or lost if the aeroplane touches the ground during a go-around. In the event of a HUD (or equivalent) failure at any time during the go-around, the pilot shall be able to revert to head-down displays to complete the go-around manoeuvre safely without loss of performance.

**CS AWO.A.HUD.103 HUD (or equivalent) information below decision height**

(See [AMC AWO.A.HUD.103](#))

Information presented on the HUD (or equivalent) below the DH shall not mislead, distract or jeopardise the safety of the landing.

#### **CS AWO.A.HUD.104 Control of take-off roll, flight path and ground roll**

(a) HUDLS

The system shall provide sufficient guidance information to enable a pilot that is competent to conduct the intended operation to intercept the xLS approach path, if that capability is provided, to track it, to land the aeroplane within the prescribed limits or to make a go-around without reference to other cockpit displays. It shall not require exceptional piloting skill to achieve the required performance. (See [CS AWO.B.SACATI.113](#) or [CS AWO.B.CATII.113](#) or [CS AWO.B.CATIII.115](#) (a) and (b)) or [CS AWO.B.CATIII.117](#).

(b) The transition from approach/flare guidance to roll-out control guidance shall be smooth and not distract the pilot from performing the intended operation.

(c) If the autopilot is used to control the flight path of the aeroplane to intercept and establish the xLS approach path, the point during the approach at which the transition from automatic to manual flight takes place shall be identified and taken into account in the performance demonstration (see [CS AWO.B.CATIII.115](#)). The transition from autopilot, to head-up guidance shall not require exceptional piloting skill, alertness, strength or excessive workload.

(d) For take-off roll, the HUD (or equivalent) shall meet the performance requirements of [CS AWO.C.TOO.106](#).

(e) The HUD characteristics and dynamics shall be suitable for manual control of the aircraft.

#### **CONTROLS, INDICATORS AND ALERTS**

##### **CS AWO.A.HUD.105 Presentation of information to the flight crew**

(See [AMC AWO.A.ALS.110](#))

(a) Where a HUD (or equivalent) is used to display approach guidance, the following shall apply:

(1) Any malfunctions of the HUD (or equivalent) which require immediate action on the part of the pilot shall be indicated by a positive and unmistakable alert to both pilots. These alerts shall be in accordance with CS 25.1322 as far as is practicable (See [AMC AWO.A.HUD.105\(a\)\(i\)](#)).

(2) The system shall be designed such that detected failures will cause the immediate removal of incorrect guidance information from view (See [AMC AWO.A.HUD.105\(a\)\(ii\)](#)).

(3) The pilot using the HUD (or equivalent) shall be able to monitor automatic and manual flight guidance modes and system status (See [AMC AWO.A.HUD.105 \(a\)\(iii\)](#)).

(4) Clear visual indication on the HUD (or equivalent) and at the other pilot's station (e.g. an alert light) when the aeroplane reaches the preselected DH. An additional aural indication is desirable.

(5) For normal approach cases, the HUD (or equivalent) symbology, including guidance symbology, shall remain usable at least to the minimum use height (see [CS AWO.B.SACATI.114](#) and [CS AWO.B.CATII.114](#)).

(b) In addition, for HUDLSs that are used for primary guidance during Category 3 operations (see Subpart B [Section 4](#)), the following are also required:



- (1) There shall be a means of monitoring the aeroplane approach and landing performance to alert both pilots to unsafe conditions.
- (2) The pilot who is not flying the aeroplane shall be provided with a display of the adequacy with which the flying pilot is tracking the HUDLS commands.
- (3) The pilot using the HUDLS shall be able to monitor the system operational status and approach performance continuously without referring to the head-down displays.
- (4) An alert of excessive deviation from the required approach path shall be provided on the HUD (or equivalent) and at the other pilot's station (See [CS AWO.B.CATII.115](#)).
- (5) If an automatic thrust system is provided, its operation and the information provided on the HUD (or equivalent) shall be consistent. In particular, the mode in which the autothrust is operating shall appear in the HUD (or equivalent), and system operation shall not adversely affect the pilot's control of the aircraft when using the HUDLS.

#### **CS AWO.A.HUD.106 Flight data recording**

Where a HUD (or equivalent) is installed, a 'HUD in use' parameter shall be recorded on the flight data recorder in accordance with CS 25.1549(e).

### **PERFORMANCE**

#### **CS AWO.A.HUD.107 Performance demonstration**

(See [AMC AWO.A.HUD.107](#))

- (a) When a HUDLS is used for primary guidance, the following additional variables shall be included in the performance demonstration (see [AMC AWO.A.HUD.107](#)):
  - (1) ambient lighting conditions and approach and runway lighting;
  - (2) variations of the reported runway visual range (RVR); and
  - (3) individual flight crew performance.
- (b) The HUD (or equivalent) shall meet the performance and integrity requirements applicable to the type of operation intended. Refer to CS-AWO Subpart B [Section 2 SA CAT I](#), [Section 3 CAT II](#) or [Section 4 CAT III](#).

#### **CS AWO.A.HUD.108 Fail-operational hybrid landing system**

Where a HUDLS is fitted as part of a hybrid system, its performance need not meet the same criteria as the primary system provided that it:

- (a) meets the overall performance requirements, taking into account the probability that it will be used;  
and
- (b) is sufficiently compatible with the primary system so as to retain pilot confidence.

### **FAILURE CONDITIONS**

**CS AWO.A.HUD.109 Head-up display landing systems**

In addition, for HUDLSs that are used for primary guidance during Category 3 operations (see Subpart B [Section 4](#)), the following are also required:

- (a) Failure conditions resulting in the inability to complete the landing from the DH using the HUDLS, shall not have a frequency of occurrence of more than once every thousand approaches.
- (b) In the event of an engine failure, the HUDLS shall permit the pilot to control the aeroplane without reverting to other displays.
- (c) Wear in mechanical components, e.g. pivots, to be expected in normal service use shall not significantly affect the alignment of the HUDLS display.
- (d) The radio altimeter (or other device capable of providing equivalent performance and integrity level) shall be such that the probability of the provision of false height information leading to a hazardous situation is extremely remote. The warning for false height information shall be given by the removal or obscuration of displayed information, at least in the height band from 30 m (100 ft) downwards.

**CS AWO.A.HUD.110 Head-up displays used for enhanced flight vision systems (EFVSs)**

- (a) HUDs (or equivalent displays) used to display EFVS imagery shall have a field of regard (FOR) that is appropriate to the intended usage (see [CS AWO.A.EFVS.104](#) (b), (c) and (d)).
- (b) Where the EFVS image is superimposed on the HUD (or equivalent display) symbology and is used in combination with other aircraft systems, then the EFVS image and installation shall:
  - (1) satisfactorily perform its intended function;
  - (2) permit the accurate identification and utilisation of visual references, using both EFVS and natural vision, as appropriate;
  - (3) have acceptable display characteristics to accomplish the intended function;
  - (4) not degrade the presentation of essential flight information listed in [CS AWO.A.EFVS.105](#) (a) on the HUD (or equivalent display);
  - (5) not be misleading and not cause confusion or any significant increase in pilot workload;
  - (6) be aligned with and scaled to the external scene, and consider, if needed, the effect of near distance parallax;
  - (7) not significantly or misleadingly alter the colour perception of the external scene to preclude the pilot's performance of any required tasks by causing confusion or any significant increase in workload; and
  - (8) permit the pilot to recognise misaligned or non-conformal conditions to the external scene that may preclude the pilot's performance of any required manoeuvres.

**CS AWO.A.HUD.111 Head-up displays used for synthetic vision guidance systems (SVGSs)**

A HUD (or equivalent display) used in an SVGS shall:

- (a) provide a means to control the SVGS scene brightness that is independent of the HUD (or equivalent display) symbology brightness control. This control shall be operable without causing excessive pilot workload, distraction or fatigue;

- (b) provide a readily accessible control to enable the pilot to remove and reactivate the SVGS image from the HUD (or equivalent display) without requiring the pilot to remove their hands from the primary flight controls and thrust control;
- (c) not cause interference with the safe and effective use of the pilot compartment view, either internally or externally;
- (d) not cause adverse physiological effects such as fatigue or eyestrain;
- (e) not significantly alter the colour perception of the external scene;
- (f) allow the pilot to recognise misaligned or non-conformal conditions in a timely manner; and
- (g) not create a combination of display features to the extent that display clutter reduces the efficiency of reading and interpreting the pilot's external visual cues.

If found to be necessary, a means to control the SVGS scene contrast shall be provided.

**CS AWO.A.HUD.112 Head-up display landing distance**

If there is any feature of the HUD or the associated procedures which would result in an increase to the landing distance, the appropriate increment shall be established and scheduled in the AFM.

**SECTION 3****ENHANCED FLIGHT VISION SYSTEMS (EFVS)****CS AWO.A.EFVS.101 General**

- (a) An EFVS uses an electronic means to provide a real-time display of the forward external scene topography through the use of imaging sensors.
- (b) The EFVS shall provide a demonstrated vision performance in low-visibility conditions and a level of safety suitable for the proposed operational procedure that will allow the required visual references to become visible in the image before they are visible naturally out-the-window.
- (c) The EFVS shall provide an enhanced vision image that can be used during an instrument approach to enhance the pilot's ability to detect and identify the required visual references for landing in order to gain an operational credit and descend below the decision altitude (DA)/DH or minimum descent altitude (MDA).
- (d) The EFVS sensor imagery and required aircraft flight information and flight symbology shall be displayed on a HUD (or an equivalent display) so that the imagery and symbology are clearly visible to the pilot flying in their normal position with the line of vision looking forward along the flight path.
- (e) The EFVS shall include the display element, sensors, computers and power supplies, indications, and controls. It may receive inputs from an airborne navigation system or flight guidance system. The EFVS display characteristics and dynamics shall be suitable for manual control of the aircraft.

**CS AWO.A.EFVS.102 EFVS designation**

- (a) An EFVS-Approach (EFVS-A) is a system that has been demonstrated to meet the criteria to be used for approach operations from a DA/H or an MDA to 30 m (100 ft) touchdown zone elevation (TDZE) whilst all system components are functioning as intended, but may have failure modes that could result in the loss of EFVS capability. It shall be assumed for an EFVS-A that:
  - (1) the pilot will conduct a go-around above 30 m (100 ft) TDZE, in the event of an EFVS failure; and
  - (2) descent below 30 m (100 ft) above the TDZE through to touchdown and roll-out shall be conducted using natural vision in order that any failure of the EFVS shall not prevent the pilot from completing the approach and landing.
- (b) An EFVS-Landing (EFVS-L) is a system that has been demonstrated to meet the criteria to be used for approach and landing operations that rely on sufficient visibility conditions to enable unaided roll-out and to mitigate for loss of EFVS function.
- (c) An EFVS that meets the certification criteria for an EFVS-L shall be considered to have met the certification criteria for an EFVS-A.

**CS AWO.A.EFVS.103 EFVS depiction**

- (a) The EFVS sensor imagery and the following flight symbology shall be presented so that they are aligned with and scaled to enable a one-to-one (conformal) overlay with the actual external scene:

- (1) aircraft attitude;
  - (2) command guidance as appropriate for the approach to be flown;
  - (3) flight path vector (FPV); and
  - (4) flight path angle reference cue (FPARC), and other cues, which are referenced to this imagery and external scene topography.
- (b) The FPARC shall be suitable for monitoring the vertical flight path of the aircraft on approaches without vertical guidance and shall be displayed referenced to the pitch scale. It shall be possible for the pilot to be able to set the FPARC to the desired descent angle for the approach. The descent angle may also be automatically set to a value found in an on-board database.
- (c) The displayed EFVS imagery and aircraft flight symbology shall not adversely obscure the pilot's outside view or field of view (FOV) through the cockpit window and shall be free of interference, distortion, and glare that would adversely affect the pilot's normal performance and workload.
- (d) The EFVS-L shall provide a means of providing a flare cue and shall use a radio altimeter (or other device capable of providing equivalent performance and integrity level) to determine height above terrain.

#### **CS AWO.A.EFVS.104 EFVS display**

- (a) The display of the EFVS image on the HUD (or equivalent display) shall not hinder or compromise the pilot's ability to see and use the required primary flight display information.
- (b) The FOR of the HUD (or other equivalent display) shall be sufficient for the EFVS information to be displayed conformally over the range of anticipated aircraft attitudes, aircraft configurations, and environmental, including wind, conditions for each mode of operation.
- (c) The EFVS FOR shall be appropriate for the intended operation and function and shall take into consideration:
- (1) HUD (or equivalent display) and EFVS sensor FOV;
  - (2) orientation of the HUD (or equivalent display) with respect to the aircraft frame of reference; and
  - (3) orientation of the aircraft.
- (d) The EFVS FOR shall be checked during certification flight test for sufficiency in meeting its intended function.
- (e) When a minimum flight crew of more than one pilot is required for the conduct of the operation, a suitable display EFVS sensor imagery shall be provided to the pilot monitoring.
- (f) The EFVS image shall be compatible with the FOV and head motion box of the HUD.
- (g) A previously certified HUD (or equivalent display) that is used to display EFVS shall continue to meet the conditions of the original approval and shall be adequate for the intended function, in all phases of flight in which the EFVS is used.
- (h) The EFVS display shall permit the pilot to accurately and easily recognise unusual aircraft attitude (and other abnormal manoeuvres) and initiate a timely recovery.
- (i) The latency of the EFVS display shall be minimised and shall not be confusing or misleading to the pilot and shall not affect control performance or increase pilot workload.

- 
- (j) The EFVS shall minimise the potential for misleading or distracting imagery by precluding off-axis information from folding into the primary FOR imagery.
- (k) The displayed EFVS image jitter amplitude shall be appropriate and minimised and shall not exhibit jitter greater than that of the HUD (or equivalent display) that it is displayed on.
- (l) The displayed EFVS image flicker shall be appropriate and minimised and shall not exhibit flicker greater than that of the HUD (or equivalent display) that it is displayed on.
- (m) The EFVS shall not exhibit any objectionable noise, local disturbances or an artefact that are hazardously misleading and/or detract from the use of the system.
- (n) The accuracy of the integrated EFVS and HUD (or equivalent display) image shall be appropriate for the intended function and operation.
- (o) Any passive sensor optical distortion shall be appropriate for the intended function and operation.
- (p) The EFVS sensor shall provide a means to minimise blooming and shall prevent blooming that results in the required visual references no longer being distinctly visible and identifiable.
- (q) The EFVS image persistence time shall be appropriate for the intended function and operation.
- (r) Dead pixels shall be minimised and shall be of a total area appropriate for the intended function and operation.
- (s) The effects of parallax caused by lateral, vertical, and longitudinal offset of the sensor from the pilots' design eye position shall not impede the EFVS from performing its intended function and shall not result in significant performance differences in unsatisfactory landing or safety-related performance parameters between EFVS operations and visual operations in the same aircraft.
- (t) The EFVS-A display providing imagery to the pilot monitoring shall:
- (1) be located so that it is plainly visible to the pilot monitoring from their station with the minimum practicable deviation from their normal position and line of vision when the pilot is looking forward along the flight path, and any symbology displayed shall not adversely obscure the sensor imagery of the runway environment;
  - (2) provide an image of the visual scene over the range of aircraft attitudes and wind conditions for each mode of operation and enable the pilot monitoring to see and identify visual references and to verify that all visual requirements for the approach and landing are satisfied;
  - (3) not require the pilot monitoring to unduly move their head/body away from their normal scan pattern or their normal seated position; and
  - (4) ensure satisfactory display of imagery in all lighting and environmental conditions and that dimming controls of the display are adequate.
- (u) The EFVS-L display providing imagery to the pilot monitoring shall:
- (1) be centred as nearly as practicable about the vertical plane of the pilot's forward vision;
  - (2) be located so that the pilot monitoring seated at the controls can monitor the aeroplane's flight path and instruments with minimum head and eye movement;

- (3) provide an image of the visual scene over the range of aircraft attitudes and wind conditions for each mode of operation and enable the pilot monitoring to see and identify visual references and to verify that all visual requirements for the approach and landing are satisfied;
- (4) not require the pilot monitoring to unduly move their head/body away from their normal scan pattern or their normal seated position; and
- (5) ensure satisfactory display of imagery in all lighting and environmental conditions and that dimming controls of the display are adequate.

#### **CS AWO.A.EFVS.105 HUD EFVS symbology**

- (a) In addition to sensor imagery, the flight instrument data that is displayed on the HUD (or equivalent display) shall, as a minimum, include:
  - (1) airspeed;
  - (2) vertical speed;
  - (3) aircraft attitude;
  - (4) heading;
  - (5) altitude;
  - (6) height above ground level (AGL) such as that provided by a radio altimeter or other device capable of providing equivalent performance and integrity level;
  - (7) command guidance as appropriate for the approach to be flown;
  - (8) path deviation indications;
  - (9) FPV; and
  - (10) FPARC.
- (b) If a runway outline (or symbolic runway) is used on the approach to increase awareness of the runway environment and its emergent location within the HUD (or equivalent display), then it shall be geo-referenced and shall not occlude the emerging EFVS cues.
- (c) EFVS-L that are intended to be used from the DA/H through touchdown and roll-out at not less than 300 m (1 000 ft) RVR, shall also display:
  - (1) height AGL such as that provided by the use of a radio altimeter or other device capable of providing equivalent performance and integrity level; and
  - (2) flare prompt or flare guidance for achieving acceptable touchdown performance.
- (d) The appearance and dynamic behaviour of the EFVS-L flare prompt shall be distinguishable from command guidance and shall appear in a timely and conspicuous manner to the pilot.
- (e) An FPV shall be provided on the same display as the EFVS imagery and shall provide a position and motion that corresponds to the aircraft's earth referenced FPV and shall dynamically respond to follow the pilot control inputs.
- (f) The dynamic response of the FPV symbol to pilot control inputs shall not exhibit undue lag or overshoot.

- (g) An FPARC shall be provided on the same display as the EFVS imagery that is suitable for monitoring the vertical path of the aircraft. A means shall be provided to permit the pilot to select the desired descent angle that is represented by the FPARC. It is also possible for the descent angle to be provided automatically from a database.
- (h) The display of attitude symbology, FPV, FPARC, and other visual elements which are earth-referenced, shall be aligned with, scaled and conformal to the external view.
- (i) The EFVS display of imagery, flight information and flight symbology shall provide suitable visual reference for the pilot during the manual performance of any manoeuvres within the operating limitations of the aircraft, including taxiing, take-off, approach, landing and roll-out as applicable for the intended function.

#### **CS AWO.A.EFVS.106 EFVS display controls**

- (a) A means of controlling the EFVS display contrast/brightness shall be provided that prevents:
  - (1) distraction of the pilot;
  - (2) impairment of the pilot's ability to detect and identify visual references;
  - (3) masking of flight hazards; and
  - (4) degradation of task performance or safety.
- (b) If automatic control for image brightness is not provided, it shall be shown that the manual setting of image brightness meets the above criteria and does not cause excessive workload.
- (c) The EFVS display controls shall be visible to, and within reach of, the pilot flying from any normal seated position and shall provide a readily accessible control to permit the pilot to immediately deactivate or reactivate the display of the EFVS image on a HUD (or equivalent display) without requiring the pilot to remove their hands from the primary flight controls and thrust control.
- (d) The position and movement of the EFVS controls shall be designed to minimise the likelihood of inadvertent operation.
- (e) With the exception of controls located on the pilot's control wheel (or equivalent), EFVS controls shall be adequately illuminated for all normal background lighting conditions, and shall not create any objectionable reflections on the HUD (or equivalent display) or other flight instruments.

#### **CS AWO.A.EFVS.107 EFVS safety assessment**

- (a) The normal operation of the EFVS shall not adversely affect, or be adversely affected by, other aircraft systems.
- (b) A safety assessment of the installed EFVS, considered separately and in conjunction with other relevant installed systems, shall be conducted to meet the requirements of CS 23.1309 or CS 25.1309 as applicable.
- (c) The EFVS design shall be assessed in accordance with the provisions of either CS 23.1309 or CS 25.1309 as applicable.
- (d) An aircraft and system level functional hazard assessment (FHA) and system safety assessment (SSA) shall be prepared to determine the hazard level associated with system failure conditions and to determine the minimum required software and hardware design assurance levels (DALs).



- (e) Any alleviating flight crew actions that are considered in the EFVS safety analysis shall be validated during testing for incorporation in the AFM.
- (f) The flight crew workload shall be assessed in accordance with CS 23.1523 or CS 25.1523 as applicable.

**CS AWO.A.EFVS.108 EFVS level of safety**

- (a) The safety design goals for airworthiness approval shall be established and shall consider the phase of flight and include the required:
  - (1) accuracy;
  - (2) continuity;
  - (3) availability; and
  - (4) integrity.
- (b) An FHA shall be conducted in accordance with CS 23.1309 or CS 25.1309 as applicable.
- (c) The EFVS safety level (failure and performance) shall not be less than the safety level required for non-EFVS-A-based precision and non-precision approaches (NPAs) with DAs/DHs of 60 m (200 ft) or above.
- (d) The ability of the pilot(s) to cope with any failures identified in the SSA or to provide intervention to limit the effect of a hazard shall be demonstrated and justified.
- (e) In showing compliance, any probabilities used shall not be factored by the fraction of approaches which are made using EFVS.
- (f) For EFVS-L, a satisfactory level of safety (failure and performance) appropriate to the operations being addressed shall be demonstrated with the visual segment primarily accomplished by the use of an EFVS-L rather than natural vision.
- (g) For EFVS-L, a system evaluation shall be conducted to establish the failure modes and determine whether the pilot can safely land and roll out with available natural vision plus whatever remains of the EFVS-L. The evaluation shall not assume that a safe landing can be achieved with only available natural vision after any failure of the EFVS-L.

**CS AWO.A.EFVS.109 EFVS performance**

- (a) A performance demonstration and evaluation of the EFVS shall be performed and shall include demonstrations of:
  - (1) approach;
  - (2) missed approach;
  - (3) failure conditions; and
  - (4) crosswind conditions.
- (b) The demonstration of performance shall consider the lateral and vertical limits that could exist at the approach minima for the type of intended approach that certification is being sought.
- (c) The performance of the EFVS sensor shall be established in terms of the range of the enhanced flight visibility when low-visibility conditions exist. This shall be achieved by determining the ability of the EFVS

sensor to provide the display of the visual references of the runway environment that are required at operationally relevant distances (see AMC7 SPA.LVO.105(c) point e).

- (d) The EFVS sensor resolution performance shall adequately resolve, for pilot identification, the runway threshold and the TDZ to enable the intended function.
- (e) The maximum allowable final approach course offset shall be established.
- (f) An EFVS-L with superimposed flight symbology shall not mislead, distract or jeopardise the safety of the landing and roll-out, and the performance of the system shall be demonstrated to be equivalent to or better than that normally achieved in visual operations for the specific aircraft type for all performance parameters measured.
- (g) The image/symbology of an EFVS-L shall provide the visual cues for the pilot to perform the following without requiring exceptional pilot skill, alerting, strength or excessive workload:
  - (1) control of approach speed (manual or automatic) up to the point of landing;
  - (2) transition through flare to landing;
  - (3) approach, flare, and landing at a normal sink rate for the aircraft;
  - (4) prompt and predictable correction of any lateral deviation away from the runway centre line to smoothly intercept the centre line;
  - (5) touchdowns with a bank angle that is not hazardous to the aeroplane;
  - (6) a normal derotation;
  - (7) control of the path of the aeroplane along the runway centre line through roll-out to a safe taxi speed; and
  - (8) a safe go-around anytime including up to touchdown in all configurations to be certified.
- (h) The lateral and longitudinal touchdown performance of an EFVS-L shall be demonstrated and shall be equivalent to or better than that normally achieved in visual operations.

However, if there is any feature of the system or the associated procedures which would result in an increase to the landing distance, the appropriate increment must be established and scheduled in the AFM.

- (i) The HUD (or equivalent display) shall meet the performance and integrity requirements applicable to the type of operation intended. Refer to CS-AWO Subpart B [Section 2 SA CAT I](#), [Section 3 CAT II](#) or [Section 4 CAT III](#).

#### **CS AWO.A.EFVS.110 EFVS monitoring, annunciation and alerting**

- (a) The mode of operation of the EFVS shall be:
  - (1) annunciated on the flight deck;
  - (2) visible to the flight crew; and
  - (3) recorded by the flight data recorder.

- (b) Any detected EFVS malfunction that can adversely affect the normal operation of the EFVS shall be annunciated to the flight crew and shall include as a minimum sensor failures and frozen image failure messages.
- (c) No single EFVS malfunction shall lead to the display of misleading information, and malfunctions shall be annunciated and the malfunctioning display elements removed.

**CS AWO.A.EFVS.111 EFVS documentation**

The demonstrated capability and any specific EFVS limitations of the EFVS shall be included within the relevant AFM.

**SECTION 4****SYNTHETIC VISION GUIDANCE SYSTEMS (SVGS)****GENERAL****CS AWO.A.SVGS.101 Applicability and terminology**

An SVGS is an installed airborne system that comprises the following elements:

- (a) a flight display, displayed head down or head up;
- (b) a means to monitor the system performance with the capability to provide alerts;
- (c) a means to monitor aircraft position with the capability to provide alerts;
- (d) a radio altimeter or other device capable of providing equivalent performance and integrity level;
- (e) terrain, runway and obstacle databases;
- (f) a means to depict the runway of intended landing;
- (g) a means to provide an FPARC;
- (h) a means to provide FPV; and
- (i) a means to identify the missed approach point (MAPt).

**CS AWO.A.SVGS.102 SVGS scene depiction**

The SVGS primary display at each pilot station shall provide:

- (a) a geospatially correct depiction of the external topography and obstacles from the perspective of the flight deck (egocentric) and not provide a pilot's view that is depicted below the earth's surface;
- (b) a means of giving a sense of motion while on the final approach segment (FAS);
- (c) a clear and obvious means of the display status of the SVGS scene depiction;
- (d) a means to easily identify and correlate prominent topographical features with the actual external scene;
- (e) a means to enable the flight crew to be able to perceive relative distances to prominent topographical features;
- (f) consistency between position accuracy, symbology, and topographical information;
- (g) integration of terrain awareness warning system (TAWS) (or terrain warning system) terrain alerts that are consistently depicted across all displays;
- (h) the ability for displayed terrain or displayed obstacle conflicts to be obvious to the flight crew;
- (i) a scene range from the eye position to the terrain horizon that is sufficient and is not misleading; and
- (j) an SVGS primary display that does not degrade the pilot's ability to see and use the required primary flight display information.

If depicted, displays of approach paths shall not be intersected by topographical features.

#### **CS AWO.A.SVGS.103 SVGS flight instrument display minimum requirements**

Pilots operating the aircraft from their normally seated position shall be provided with the following SVGS displays features and characteristics:

- (a) A clear and distinct geographically accurate, perspective depiction of the runway of intended landing that is integrated with the SVGS scene and derived from an accepted database (see [CS AWO.A.SVGS.114](#), [115](#), [116](#), [117](#) and [118](#)). The runway depiction shall be displayed within the positional accuracy requirements. This shall be usable by the flight crew at a minimum distance of two nautical miles from the runway threshold.
- (b) Lateral and vertical path deviations
- (c) Command guidance display
- (d) An earth-referenced FPV with a symbol that is scaled to and aligned with the SVGS scene that does not interfere with the display of attitude.
- (e) An FPARC referenced to the pitch scale at the desired and selected descent angle for the approach that does not interfere with the display of attitude.
- (f) Error annunciations (SVGS depiction, navigation signal integrity and excessive deviation (flight technical error)) that are displayed in the pilot's primary FOV.
- (g) Alerts (warning or caution level as appropriate) to inform the flight crew when the SVGS function is lost or degraded below the required level of performance. Any detected erroneous information shall be removed from the display.
- (h) Characteristics and dynamics that are suitable and effective to enable manual control of the aircraft
- (i) Radio altitude or equivalent display

The SVGS display shall not interfere with the external visibility, interpretation and use of cues and guidance presented on the head-down display (primary flight display) or HUDs used for the conduct of the approach procedure.

#### **CS AWO.A.SVGS.104 Command guidance**

Command guidance cues (flight director) shall meet the required flight technical error performance and accuracy for the intended operation (see CS-AWO Subpart B [Section 2 SA CAT I](#) or [Section 3 CAT II](#)).

#### **CS AWO.A.SVGS.105 SVGS — using a head-up display (or equivalent display)**

A HUD (or equivalent display) used in an SVGS shall meet the provisions of Subpart A [Section 2 HUD](#) for the intended operation — in particular, [CS AWO.A.HUD.111](#).

If the SVGS depiction is included with HUD (or equivalent display) symbology and used in combination with other aircraft systems, then the SVGS depiction shall include all the additional flight instrument features needed for operation, performance and monitoring.

The HUD (or equivalent) shall meet the performance and integrity requirements applicable to the type of operation intended. Refer to CS-AWO Subpart B [Section 2 SA CAT I](#), [Section 3 CAT II](#) or [Section 4 CAT III](#).

**CS AWO.A.SVGS.106 Field of regard**

The FOR of a HUD (or equivalent display) or a head-down display (HDD) used to display SVGS display shall support the intended functions over the range of anticipated aircraft attitudes, aircraft configurations, runway environments and environmental (e.g. wind) conditions.

**CS AWO.A.SVGS.107 Head-down display minification**

For a SVGS implemented on head-down primary displays, the minification ratio shall be shown to be satisfactory.

**SYSTEM MONITORING, ANNUNCIATION AND ALERTING****CS AWO.A.SVGS.108 Information provided to the flight crew**

Sufficient information shall be provided to the flight crew to enable them to monitor the system status and the approach operation progress and safety.

This information shall include unambiguous:

- (a) identification of the intended path for the approach (e.g. approach type, approach identifier, frequency or channel number); and
- (b) indication of the system status.

**CS AWO.A.SVGS.109 SVGS mode and status annunciation**

The flight crew shall be provided with a means to determine the capability of the airborne system elements to accomplish the approach operation prior to the approach in the event of failed aircraft systems or components that affect the decision to continue in SVGS mode.

If more than one approach navigation source is available, then the navigation source selected for the approach shall be positively indicated in the primary FOV.

**CS AWO.A.SVGS.110 SVGS fault detection and alerting**

The SVGS shall provide an automatic means to detect and alert the pilot to hazardously misleading guidance signals.

Annunciations shall be provided in the primary FOV.

The SVGS shall be capable of monitoring the continuity of the navigation source.

An alert shall be provided if during the final approach the SVGS operation cannot be completed due to system malfunction.

**CS AWO.A.SVGS.112 Flight technical error**

The lateral and vertical tracking performance shall be appropriate and comply with performance requirements for the intended operation (see [CS AWO.B.SACATI.113](#) or [CS AWO.B.CATII.113](#) or [CS AWO.B.CATIII.115](#)).

**CS AWO.A.SVGS.113 Navigation system error**

In order to ensure the required accuracy and integrity of the guidance and SVGS scene depiction, the navigation system or position error shall be monitored.

Positioning and guidance sources shall be monitored.

## **TERRAIN, RUNWAY AND OBSTACLE DATABASES**

### **CS AWO.A.SVGS.114 Databases general**

Any database such as terrain, runway or obstacle that are used for SVGS scene depiction shall have data quality requirements that support the intended function and have a documented means of producing and maintaining the data in accordance with the latest version of ED-76.

## **SVGS FLIGHT DISPLAY ELEMENTS**

### **CS AWO.A.SVGS.115 Minimum display size**

SVGS displays shall be large enough to present information in a form that is usable, readable and identifiable to the flight crew at their design eye positions, relative to the operational and lighting environment and in accordance with the SVGS intended function(s).

### **CS AWO.A.SVGS.116 Display features and symbology**

In addition to the required minimum symbology in [CS AWO.A.SVGS.103](#), SVGSs shall also provide on the display:

- (a) the threshold of the runway of intended landing;
- (b) a means of distinguishing the landing runway from other runways where more than one runway is depicted;
- (c) a means to provide a sense of ground speed, altitude trend and direction due to aircraft movement through the depicted scene, if not inherently provided by the terrain depiction; and
- (d) when conforming an image to the outside world, such as on a HUD (or equivalent display), the image shall not obscure or significantly hinder the ability of the flight crew to detect real-world objects.

Coded information elements overlaid over images shall:

- (1) be readily identifiable and distinguishable for all foreseeable conditions of the underlying image and range of motion;
- (2) not obscure necessary information contained in the image;
- (3) be depicted with the appropriate size, shape, and placement accuracy to avoid being misleading;
- (4) retain and maintain their shape, size, and colour for all foreseeable conditions of the underlying image and range of motion; and
- (5) show that if there is any obscured information, it is either not needed when it is obscured or it can be rapidly recovered.

### **CS AWO.A.SVGS.117 HUD SVGS pilot controls**

Manual or automatic SVGS scene depiction contrast (if provided) and/or brightness controls shall be effective in dynamically changing background (ambient) lighting conditions to prevent distraction of the pilot, impairment of the pilot's ability to detect and identify visual references, masking of flight hazards, or any other factor that would otherwise degrade task performance or safety.

Manual or automatic SVGS scene depiction brightness/luminance controls shall not overwrite or interfere with the HUD (or equivalent display) symbology.

### **SVGS FLIGHT DISPLAY PERFORMANCE**

#### **CS AWO.A.SVGS.118 Latency**

Latency or system lag shall not be discernible to the pilot and shall not affect control performance or increase pilot workload.

The latency period induced by the display system for alerts shall not be excessive and shall take into account the category of the alert and the required crew response time.

The dynamic response of the display shall be sufficient to discern and read the displayed information without presenting misleading, distracting, or confusing information.

#### **CS AWO.A.SVGS.119 Jitter**

The jitter amplitude of the displayed SVGS image shall be less than 0.6 milliradian (mrad).

#### **CS AWO.A.SVGS.120 Flicker**

The SVGS display refresh rate shall preclude both the appearance of unacceptable flicker (brightness variations at frequency above 0.25 Hz) and any flicker effects that result in misleading information or difficulty in reading or interpreting information under the full range of ambient environments up to the maximum ambient illumination level.

#### **CS AWO.A.SVGS.121 Image artefacts**

Undesirable display artefacts and characteristics shall be minimised so that information is still readable and identifiable under all foreseeable conditions, is not distracting, and does not lead to misinterpretation of data.

Line widths shall be of sufficient size and optimal sharpness to display the intended information with no distracting visual artefacts or ambiguities that could result in the information being unreadable, distracting or misleading.

#### **CS AWO.A.SVGS.122 HUD (or equivalent display) processing error**

Generation of the SVGS depiction shall not result in a scene display error greater than 5 mrad at the centre of the display, independent of sensor inputs.

#### **CS AWO.A.SVGS.123 SVGS scene depiction alignment**

There shall be no discernible image misalignment caused by lateral, vertical, or longitudinal offset of the computed SVGS reference point from the design eye position.

### **AIRCRAFT POSITION MONITORING AND ALERTING**

#### **CS AWO.A.SVGS.124 Aircraft positioning monitoring and alerting**

The SVGS shall provide a means of monitoring the difference between the intended flight path and the actual flight path. Information shall be provided to the flight crew to enable the monitoring of progress and safety of the approach operation.



This information shall be clear and unambiguous and indicate or alert the flight crew if the position of the aircraft with respect to the intended path becomes hazardous due to either:

- (a) the aircraft being out of position with respect to the defined flight path;
- (b) an error in the navigation guidance being followed; and/or
- (c) an error in the position of the SVGS scene.

The alerts shall be displayed in the pilot's primary FOV and active at least from 300 ft height above touchdown to the MAP.

#### **CS AWO.A.SVGS.125 Excessive deviation**

An alert shall be displayed to the pilot when the lateral and vertical deviation exceeds acceptable limits from the guidance being followed.

Refer to [CS AWO.B.SACATI.115](#), [CS AWO.B.CATII.115](#), or [CS AWO.B.CATIII.120](#).

#### **CS AWO.A.SVGS.126 System mode and status annunciation**

Any detected SVGS malfunction that can adversely affect the normal operation of the SVGS shall be visually annunciated to the flight crew.

The SVGS display shall indicate when SVGS operations are not authorised. Alerts shall be displayed in the pilot's primary FOV.

#### **CS AWO.A.SVGS.127 Determination of the missed approach point (MAPt)**

The SVGS shall provide a clear and unambiguous means to inform the pilot of the location of the MAPt on the approach path.

#### **CS AWO.A.SVGS.128 Altimetry requirements**

The SVGS display shall include a radio altitude display or another system providing height above terrain with equivalent performance, accuracy, integrity, availability, level of independence and dissimilarity.

#### **CS AWO.A.SVGS.129 Barometric altimeter/air data source**

The altitude source used for the SVGS display shall be consistent with that used for the on-board terrain awareness and alerting system on the aircraft and shall not provide contradictory indications of vertical terrain clearance.

If barometric altimetry is used to determine the MAP, then it shall be temperature compensated.

#### **CS AWO.A.SVGS.130 Geometric altimetry/GPS data source**

If geometric/GPS altimetry is used, it shall display geometric altitude relative to mean sea level.

### **SVGS SCENE**

#### **CS AWO.A.SVGS.131 Depiction of terrain and runway of intended landing**

The SVGS shall provide a means of integrating the runway and terrain data, and terrain in the area surrounding the runway shall not be depicted floating above or below the runway.

**CS AWO.A.SVGS.132 SVGS scene depiction positioning**

The SVGS scene depiction positioning sensor shall meet the required positioning performance criteria for the intended operation.

**SYSTEM SAFETY AND DESIGN ASSURANCE LEVEL (DAL)**

**CS AWO.A.SVGS.133 System safety objectives**

The SVGS shall be shown to safely perform its intended function for each operation and phase of flight for which it will be used and comply with the requirements of CS 23.1309/CS 25.1309.

**CS AWO.A.SVGS.134 Overall system safety design criteria**

The SVGS shall be shown to meet the performance and integrity requirements applicable to the type of operation intended (CS-AWO SA CAT I, CS-AWO CAT II or CS-AWO CAT III).

**CS AWO.A.SVGS.135 Flight data recorder**

The modes of the SVGS operation shall be recorded by the flight data recorder.

**CS AWO.A.SVGS.136 SVGS documentation**

The demonstrated capability and any specific SVGS limitations shall be included within the relevant AFM.

**SECTION 5****COMBINED VISION SYSTEMS (CVS)****GENERAL****CS AWO.A.CVS.101 General**

- (a) Combined vision systems (CVSs) combine a real-time imaging sensor and display with a synthetic image generated using a terrain and obstacle database utilising a precision navigation position.
- (b) A CVS shall comply with the provisions of the respective certification specifications for the images that are generated and in addition shall ensure that:
  - (1) images are conformal with each other;
  - (2) images are aligned within 5 mrad laterally and vertically at the boresight of the display;
  - (3) images do not cause confusion to the flight crew; and
  - (4) significant image discrepancies due to failure conditions are obvious to the flight crew.
- (c) If a HUD (or equivalent) is used to display the images, then it shall meet the performance and integrity requirements applicable to the type of operation intended. Refer to CS-AWO Subpart B [Section 2 SA CAT I](#), [Section 3 CAT II](#) or [Section 4 CAT III](#).

**SUBPART B — APPROACH AND LANDING**

**SECTION 1**

**AIRWORTHINESS CERTIFICATION OF AEROPLANES FOR TYPE B OPERATIONS WITH DECISION HEIGHTS/ALTITUDE BELOW 250 FT DOWN TO 200 FT — CATEGORY 1 OPERATIONS (CAT I)**

**GENERAL**

**CS AWO.B.CATI.101 Applicability**

An aeroplane with a basic airworthiness approval for instrument flight rules (IFR) operations shall be eligible to perform xLS approaches down to a DH of 60 m (200 ft), providing that the necessary xLS receiver(s) and instruments and their installation have been approved in accordance with the relevant provisions in CS-23 and CS-25.

**SECTION 2****AIRWORTHINESS CERTIFICATION OF AEROPLANES FOR OPERATIONS WITH DECISION HEIGHTS BELOW 60 M (200 FT) AND DOWN TO 45 M (150 FT) — SPECIAL AUTHORISATION CATEGORY 1 OPERATIONS (SA CAT I)****GENERAL****CS AWO.B.SACATI.101 Applicability**

This section is applicable to aeroplanes for which certification is sought to allow the performance of approaches with DHs below 60 m (200 ft) down to 45 m (150 ft) — Special Authorisation Category 1 (SA CAT I) operations, using a PA system as defined in ICAO Annex 10, which has outputs indicating the magnitude and sense of deviation from a preset azimuth and elevation angle giving equivalent operational characteristics to that of a conventional ILS. (See [AMC AWO.B.SACATI.101](#))

**CS AWO.B.SACATI.102 Safety level**

The safety level for precision approaches with DHs below 60 m (200 ft) down to 45 m (150 ft) shall not be less than the average safety level achieved in precision approaches with DHs of 60 m (200 ft) and above.

**CS AWO.B.SACATI.103 Go-around rate**

(See [AMC AWO.B.SACATI.103](#))

The proportion of approaches terminating in a go-around below 150 m (500 ft) due to the approach system performance or reliability shall not be greater than 5 % taking into account go-arounds that are caused by on-board navigation receivers.

**CS AWO.B.SACATI.104 Flight crew workload**

The workload associated with the use of the approach system shall be considered in showing compliance with CS 25.1523, AMC 25.1523 and CS 25 Appendix D.

**CS AWO.B.SACATI.105 Control of flight path**

The approach system shall either:

- (a) provide information of sufficient quality to the flight crew to permit the manual control of the aeroplane along the flight path within the prescribed limits; or
- (b) automatically control the aeroplane along the flight path within the prescribed limits.

**CS AWO.B.SACATI.106 Control of speed**

Automatic throttle/thrust control shall be provided unless it is demonstrated in flight that speed can be controlled manually by the flight crew within acceptable limits and without excessive workload. When making an approach using an automatic throttle/thrust system, the approach speed may be selected manually or automatically.

**CS AWO.B.SACATI.107 Manual control**

- (a) In the absence of a failure, the approach down to the DH shall not require a change in the means of control (e.g. a change from the automatic to manual).
- (b) The use of a manual mode or the transition from an automatic mode to manual control shall not require exceptional piloting skill, alertness or strength.

**CS AWO.B.SACATI.108 Oscillations and deviations**

The approach system shall not cause sustained nuisance oscillations or undue attitude changes or control activity as a result of configuration or power changes or any other disturbance to be expected in normal operation.

**CS AWO.B.SACATI.109 Decision height recognition**

DH recognition shall be by means of height measured by a radio altimeter or another system providing height above terrain with equivalent performance, accuracy, integrity, availability, level of independence and dissimilarity.

**CS AWO.B.SACATI.110 Go-around**

The go-around shall not require exceptional piloting skill, alertness or strength to maintain the desired flight path.

**EQUIPMENT****CS AWO.B.SACATI.111 Installed equipment**

(See [AMC AWO.B.SACATI.111](#))

The approach guidance system shall include:

- (a) two separate navigation receivers or demonstrated equivalent devices with a display of the selected deviation information at each pilot's station;
- (b) a flight guidance system with display at each pilot's station (or an alternative giving equivalent performance and safety);
- (c) a radio altimeter (or other device capable of providing equivalent performance and integrity level) with displays at each pilot's station of:
  - (1) height above terrain; and
  - (2) the selected DH;
- (d) clear visual indication at each pilot's station (e.g. an alert light) when the aircraft reaches the preselected DH appropriate to the approach;
- (e) automatic or flight director go-around system or any other attitude indicators that can achieve the required performance, accuracy and function;
- (f) audible warning of automatic pilot failure (for automatic approach) (refer to CS 25.1329);
- (g) an automatic throttle/thrust system where necessary (see [CS AWO.B.CATII.106](#));
- (h) an appropriate alerting system; and

- (i) an alert of excess deviation from the required approach path, at each pilot's station.

#### **CS AWO.B.SACATI.112 Minimum equipment**

The minimum equipment, which must be serviceable at the beginning of an approach, for compliance with the general requirements of this section and those relating to performance and failure conditions, shall be established and articulated in the AFM.

### **PERFORMANCE**

#### **CS AWO.B.SACATI.113 Flight path and speed control**

- (a) Flight path and speed control shall comply with the provisions of [CS AWO.B.CATII.113](#) down to 45 m (150 ft).
- (b) The demonstration of performance shall include performance at the lateral and vertical limits for the type of intended approach that certification is being sought.
- (c) The maximum allowable final approach course offset shall be established.

#### **CS AWO.B.SACATI.114 Decision height**

The DH shall not be less than 1.25 times the minimum permissible height for the use of the approach system. (See AMC 25.1329)

#### **CS AWO.B.SACATI.115 Excess-deviation alerts**

- (a) Excess-deviation alerts shall operate when the deviation from the intended flight path exceeds a value from which a safe landing can be made from offset positions equivalent to the excess-deviation alert, without exceptional piloting skill and with the visual references available in these conditions. ([AMC AWO.B.CATII.115\(a\)](#))
- (b) They shall be set to operate with a delay of not more than 1 second from the time that the values determined in point (a) above are exceeded.
- (c) They shall be active at least from 90 m (300 ft) to the DH, but the vertical path alert should not provide nuisance alert below 45 m (150 ft).

#### **CS AWO.B.SACATI.116 Go-around climb gradient**

The AFM shall contain either a weight, altitude, temperature (WAT) limit corresponding to a gross climb gradient of 2.5 %, with the critical engine failed and with the speed and configuration used for go-around, or the information necessary to construct a go-around gross flight path with an engine failure at the start of the go-around from the DH.

### **CONTROLS, INDICATORS AND ALERTS**

#### **CS AWO.B.SACATI.117 Mode selection and switching**

The system shall be designed so that no selection or changes of switch settings (other than system disengagement) need be made manually below a height of 150 m (500 ft) in the absence of a failure.

**CS AWO.B.SACATI.118 Presentation of information to the flight crew**

(See [AMC AWO.A.ALS.110](#))

The display and presentation of information to the flight crew, including that required to monitor the flight path, shall be compatible with the procedures specified in the AFM or flight crew operating manual as appropriate.

**FAILURE CONDITIONS****CS AWO.B.SACATI.119 General**

The effects of failures of the flight guidance system, including the on-board navigation receivers, shall be considered in accordance with CS 25.1309 and CS 25.1329.

**CS AWO.B.SACATI.120 xLS navigation means (including signal-in-space) failure**

(See [AMC AWO.B.SACAT I.120](#))

The effects of failures and reliability of the navigation means (including signal in space) shall be investigated taking into account the SARPs of ICAO Annex 10 relevant to characterisation of failures (e.g. monitor thresholds, and transmitter changeover or shut down times).

**CS AWO.B.SACATI.121 Radio altimeter (or other device capable of providing equivalent performance and integrity level)**

The radio altimeter (or other device capable of providing equivalent performance and integrity level) installation shall be such that the probability of the provision of false height information leading to a hazardous situation is extremely remote. The warning shall be given by the removal or obscuration of displayed information, at least in the height band from 45 m (150 ft) downwards.

**CS AWO.B.SACATI.122 Excess-deviation alerts**

The excess-deviation alerts shall be such that the probability of failure to operate when required is no greater than one in one thousand approaches.

**AEROPLANE FLIGHT MANUAL****CS AWO.B.SACATI.123 General**

(See [AMC AWO.B.CATII.122](#))

The AFM shall state:

- (a) limitations, including the minimum DH to which the aeroplane is certified;
- (b) the normal and abnormal procedures;
- (c) changes to the performance information, if necessary (e.g. approach speed, landing distance, go-around climb);
- (d) the minimum required equipment, including flight instruments;
- (e) the maximum head, tail and crosswind components in which the performance of the aeroplane has been demonstrated;
- (f) permitted configurations (e.g. flap setting, number of engines operating);



- (g) the type of xLS navigation means (facilities external to the aircraft), any deviations from standard and associated limitations (if any) which have been used as the basis for certification ([AMC AWO.B.CATII.122](#)); and
- (h) any restrictions on the ground installation that may differ from standard Category 1 installation.

## SECTION 3

### AIRWORTHINESS CERTIFICATION OF AEROPLANES FOR OPERATIONS WITH DECISION HEIGHTS BELOW 60 M (200 FT) AND DOWN TO 30 M (100 FT) — CATEGORY 2 OPERATIONS (CAT II)

#### GENERAL

#### CS AWO.B.CATII.101 Applicability and terminology

- a) ~~Subpart 2~~ This section of this airworthiness code certification specification is applicable to aeroplanes for which certification is sought to allow the performance of approaches with decision heights DHs below 60 m (200 ft) down to 30 m (100 ft) — Category 2 operations, using a precision approach system as defined in ICAO Annex 10 Chicago Convention (See [AMC AWO.B.CATII.101\(a\)](#)), i.e. an Instrument Landing System (ILS), or a Microwave Landing System (MLS), which has outputs indicating the magnitude and sense of deviation from a preset azimuth and elevation angle giving equivalent operational characteristics to that of a conventional ILS. (See [AMC AWO.B.CATII.101\(a\)](#)).
- b) Terminology
- ~~The term ‘approach system’ used here refers only to the airborne system. It includes the equipment listed in CS-AWO-221 and all related sensors, instruments and power supplies.~~
  - ~~‘Decision height’ is the wheel height above the runway elevation by which a go-around must be initiated unless adequate visual reference has been established and the aircraft position and approach path have been visually assessed as satisfactory to continue the approach and landing in safety. Where it is used in this Subpart 2 section 3 it means the minimum decision height at which compliance with the requirements of this Subpart 2 section 3 have been demonstrated.~~
  - ~~A go-around is the transition from an approach to a stabilised climb.~~
  - ~~‘Failure condition’ and terms describing the probabilities and effects of failure conditions are defined in AMC 25.1309.~~

#### CS AWO.B.CATII.102 Safety level

The safety level for precision approaches with decision height DHs below 60 m (200 ft) down to 30 m (100 ft) ~~must~~ shall not be less than the average safety level achieved in precision approaches with decision height DHs of 60 m (200 ft) and above. Hence, ~~in showing compliance with the performance and failure requirements, the probabilities of performance or failure effects may not be factored by the proportion of approaches, which are made with the decision height below 60 m (200 ft).~~

#### CS AWO.B.CATII.103 Go-around rate

(See [AMC AWO.B.CATII.103](#))

The proportion of approaches terminating in a go-around below 150 m (500 ft) due to the approach system performance or reliability shall ~~may~~ not be greater than 5 %.

**CS AWO.B.CATII.104 Flight crew workload**

The workload associated with the use of the approach system shall be considered in showing compliance with CS 25.1523, AMC 25.1523 and CS 25 Appendix D.

**CS AWO.B.CATII.105 Control of flight path**

The approach system ~~must~~ shall either:

- (a) provide information of sufficient quality to the flight crew to permit the manual control of the aeroplane along the flight path within the prescribed limits; or
- (b) automatically control the aeroplane along the flight path within the prescribed limits.

**CS AWO.B.CATII.106 Control of speed**

Automatic throttle control ~~must~~ shall be provided unless it is demonstrated in flight that speed can be controlled manually by the flight crew within acceptable limits and without excessive workload. When making an approach using an automatic throttle system, the approach speed may be selected manually or automatically.

**CS AWO.B.CATII.107 Manual control**

- (a) In the absence of a failure, the approach down to the decision height DH ~~must~~ shall not require a change in the means of control (e.g. a change from ~~the automatic flight control system to flight director~~ to manual).
- (b) The use of a manual mode or the transition from an automatic mode to manual control ~~must~~ shall not require exceptional piloting skill, alertness or strength.

**CS AWO.B.CATII.108 Oscillations and deviations**

The approach system ~~must~~ shall cause no sustained nuisance oscillations or undue attitude changes or control activity as a result of configuration or power changes or any other disturbance to be expected in normal operation.

**CS AWO.B.CATII.109 Decision height recognition**

~~Decision height~~ DH recognition ~~must~~ shall be by means of height measured by a radio altimeter or other device capable of providing equivalent performance and integrity level.

**CS AWO.B.CATII.110 Go around**

The go-around ~~may~~ shall not require exceptional piloting skill, alertness or strength to maintain the desired flight path.

## EQUIPMENT

### CS AWO.B.CATII.111 Installed equipment

(See [AMC AWO.B.CATII.111](#))

The approach guidance system ~~must~~ shall include:

- (a) two ~~xLS ILS and/or two MLS~~ receivers with a display of the selected deviation information at each pilot's station;
- (b) an automatic approach coupler or a flight director system with display at each pilot's station (or an alternative giving equivalent performance and safety)
- (c) a radio altimeter with displays at each pilot's station of:
  - (1) radio altitude; and
  - (2) the selected ~~decision height~~ DH (e.g. an index on an analogue scale or a digital indication);
- (d) clear visual indication at each pilot's station (e.g. an alert light) when the aeroplane reaches the preselected ~~decision height~~ DH appropriate to the approach;
- (e) automatic or flight director go-around system or acceptable attitude indicators;
- (f) audible warning of automatic pilot failure (for automatic approach);
- (g) an automatic throttle system ~~where necessary~~ (see ~~CS-AWO-206~~ when required by [CS AWO.B.CATII.106](#));
- (h) an appropriate equipment failure warning system; and
- (i) an alert of excess deviation from the required approach path, at each pilot's station (~~e.g. amber flashing light~~).

### CS AWO.B.CATII.112 Minimum equipment

The minimum equipment, which must be serviceable at the beginning of an approach, for compliance with the general requirements of this ~~Subpart 2~~ Section 3 and those relating to performance and failure conditions, ~~must~~ shall be established and articulated. ~~For example, where justified by a system safety assessment, one ILS or one MLS receiver may be unserviceable.~~

## PERFORMANCE

### CS AWO.B.CATII.113 Flight path and speed control

(See [AMC AWO.B.CATII.113](#))

The performance of the aeroplane and its systems ~~must~~ shall be demonstrated by flight tests supported ~~where necessary~~ by appropriate analysis and simulator tests. Flight testing ~~must~~ shall include a sufficient number of approaches conducted in conditions, which are reasonably representative of actual operating conditions and ~~must~~ shall cover the range of parameters affecting the behaviour of the aeroplane (~~e.g. wind speed, ILS and/or MLS ground facility characteristics, aeroplane configurations, weight, centre of gravity, etc.~~).

**CS AWO.B.CATII.114 Decision height**

The decision height DH must shall not be less than 1.25 times the minimum permissible height for the use of the approach system. (See AMC 25.1329.)

**CS AWO.B.CATII.115 Excess-deviation alerts**

- (a) Excess-deviation alerts must shall operate when the deviation from the xLS ILS or MLS glide path or localiser centre line exceeds a value from which a safe landing can be made from offset positions equivalent to the excess-deviation alert, without exceptional piloting skill and with the visual references available in these conditions. (See [AMC AWO.B.CATII.115\(a\)](#))
- (b) They must shall be set to operate with a delay of not more than 1 second from the time that the values determined in ~~CS AWO 236(a)~~ [CS AWO.B.CATII.115\(a\)](#) are exceeded.
- (c) They must shall be active at least from 90 m (300 ft) to the decision height DH, but the glide path alert should not be active below 30 m (100 ft).

**CS AWO.B.CATII.116 Go-around climb gradient**

The aeroplane flight manual AFM must shall contain either a WAT (Weight, Altitude, Temperature) limit corresponding to a gross climb gradient of 2.5%, with the critical engine failed and with the speed and configuration used for go-around, or the information necessary to construct a go-around gross flight path with an engine failure at the start of the go-around from the decision height DH.

**CONTROLS, INDICATORS AND ~~WARNINGS~~ ALERTS****CS AWO.B.CATII.117 Mode selection and switching**

- ~~(a) A positive and continuous indication must be provided of the modes actually in operation. In addition, where engagement of a mode is automatic (e.g. localiser and glide path acquisition) clear indication must be given when the mode has been armed by a member of the flight crew.~~
- ~~(b) Where reliance is placed on the pilot to detect non-engagement of go-around mode when it is selected, an appropriate indication or warning must be given.~~

The system must shall be designed so that no selection or changes of switch settings (other than system disengagement) need be made manually below a height of 150 m (500 ft) in the absence of a failure.

**CS AWO.B.CATII.118 Presentation of information to the flight crew**

(See [AMC AWO.A.ALS.110](#))

- a) The display and presentation of information to the flight crew, including that required to monitor the flight path, must shall be compatible with the procedures specified in the aeroplane flight manual AFM or flight crew operating manual as appropriate. All indications must be designed to prevent crew errors.
- ~~b) Essential information and warnings necessary to the crew in the use of the approach system must be so located and designed as to permit both their accurate use in normal operation and the rapid recognition of malfunctions, in all expected lighting conditions.~~

**~~CS.AWO.B.CATII.119 Audible warning of automatic pilot disengagement~~**

- ~~(a) Where the approach flight path is controlled automatically, an audible warning must be given following disengagement of the automatic pilot or loss of the automatic approach mode. This warning must comply with the provisions of CS-AWO 153.~~
- ~~(b) For aeroplanes with automatic landing systems, the same warning must be used for automatic approach as is used for automatic landing.~~

**FAILURE CONDITIONS**

~~(See CS 25.1309 and its AMC)~~

**CS AWO.B.CATII.119 General**

~~The effects of failures of the approach system e.g. false radio altitude information, incorrect flight guidance commands must be considered in accordance with the requirements of CS 25.1309 and CS 25.1329.~~ The effects of failures of the flight guidance system, including the navigation means, shall be considered in accordance with the requirements of CS 25.1309 and CS 25.1329.

**~~CS AWO.B.CATII.120 Automatic pilot~~**

~~The automatic pilot must comply with CS 25.1329 and its AMC.~~

**~~CS.AWO.B.CATII.121 Flight director system~~**

- ~~(a) The flight director system, or alternative form of information display, must be so designed that the probability of display of incorrect guidance commands to the pilot is Remote when credit is taken for an excess deviation alert.~~
- ~~(b) The deviation profile method of AMC 25.1329 must be used in assessing failures of flight director systems.~~
- ~~(c) Wherever practicable a fault must cause the immediate removal from view of the guidance information but, where a warning is given instead, it must be such that the pilot cannot fail to observe it whilst using the information.~~

**CS AWO.B.CATII.120 Radio altimeter (or other device capable of providing equivalent performance and integrity level)**

The radio altimeter (or other device capable of providing equivalent performance and integrity level) installation shall must be such that the probability of the provision of false height information leading to a hazardous situation is extremely remote. The warning shall must be given by the removal or obscuration of displayed information, at least in the height band from 30 m (100 ft) downwards.

**CS AWO.B.CATII.121 Excess-deviation alerts**

~~The excess-deviation alerts must be such that~~ The probability of an excess-deviation alert failure to operate when required is not frequent shall be no greater than one in one thousand approaches.

**AEROPLANE FLIGHT MANUAL****CS AWO.B.CATII.122 General**

The aeroplane flight manual AFM must shall state:

- (a) limitations, including the minimum decision height DH to which the aeroplane is certified certified;
- (b) the normal and abnormal procedures;
- (c) changes to the performance information, if necessary (e.g. approach speed, landing distance, go-around climb); and
- (d) the minimum required equipment, including flight instruments;
- (e) the maximum head, tail and crosswind components in which the performance of the aeroplane has been demonstrated;-
- (f) the permitted configurations (e.g. flap setting, number of engines operating); and
- (g) the type of xLS navigation means (facilities external to the aircraft) and associated limitations (if any) which have been used as the basis for certification (see [AMC AWO.B.CATII.122](#)).

## SECTION 4

## AIRWORTHINESS CERTIFICATION OF AEROPLANES FOR OPERATIONS WITH DECISION HEIGHTS BELOW 30 M (100 FT) OR NO DECISION HEIGHT — CATEGORY 3 OPERATIONS (CAT III)

## GENERAL

## CS AWO.B.CATIII.101 Applicability and terminology

(a) ~~Subpart 3~~ This section of this airworthiness code is applicable to aeroplanes for which certification is sought to allow the performance of approaches with decision height DHs below 30 m (100 ft) or with no DH — Category 3 operations, using a precision approach system as defined in ICAO Annex 10—Chicago Convention, i.e. an Instrument Landing System (ILS), or a Microwave Landing System (MLS) which has outputs indicating the magnitude and sense of deviation from a preset azimuth and elevation angle giving equivalent operational characteristics to that of a conventional ILS.

The criteria are divided, where necessary, into those applicable to the following types of operation:

- (1) Decision height DHs below 30 m (100 ft) but not less than 15 m (50 ft);
- (2) Decision height DHs below 15 m (50 ft); and
- (3) No decision height DH.

(See [AMC AWO.B.CATIII.101\(a\)](#))

(b) Terminology

- (1) The term 'landing system' used here refers only to the airborne system. It includes the equipment listed in JAR AWO 321 and also all related sensors, instruments and power supplies.
- (2) Automatic Landing System: The airborne equipment which provides automatic control of the aeroplane during the approach and landing.
- (3) Fail passive Automatic Landing System: An automatic landing system is fail passive if, in the event of a failure, there is no significant out-of-trim condition or deviation of flight path or attitude but the landing is not completed automatically.
- (4) For a fail-passive automatic landing system the pilot assumes control of the aircraft after a failure.

The following are typical arrangements:

- (i) A monitored automatic pilot in which automatic monitors will provide the necessary failure detection and protection.
- (ii) Two automatic pilots with automatic comparison to provide the necessary failure detection and protection.

Super Fail passive Automatic Landing System: An automatic landing system which meets the requirements of paragraph (3) above but has additional features such as automatic align, roll-out and go-around modes which, along with other aircraft



~~characteristics defined under CS-AWO 321 (b)(2), permit operations in lower RVRs than less sophisticated fail passive landing systems.~~

- ~~(5) Fail operational Automatic Landing System: An automatic landing system is fail operational if, in the event of a failure, the approach, flare and landing can be completed by the remaining part of the automatic system.~~

~~In the event of a failure, the automatic landing system will operate as a fail passive system.~~

~~The following are typical arrangements:~~

~~(i) Two monitored automatic pilots, one remaining operative after a failure.~~

~~(ii) Three automatic pilots, two remaining operative (to permit comparison and provide necessary failure detection and protection) after a failure.~~

- ~~(6) Fail operational Hybrid Landing System: A system which consists of a primary fail passive automatic landing system and a secondary independent guidance system enabling the pilot to complete a landing manually after failure of the primary system.~~

~~A typical secondary independent guidance system consists of a monitored head-up display providing guidance which normally takes the form of command information, but it may alternatively be situation (or deviation) information.~~

- ~~(7) The alert height is a specified radio height, based on the characteristics of the aeroplane and its fail operational landing system. In operational use, if a failure occurred above the alert height in one of the required redundant operational systems in the aeroplane (including, where appropriate, ground roll guidance and the reversionary mode in a hybrid system), the approach would be discontinued and a go-around executed unless reversion to a higher decision height is possible. If a failure in one of the required redundant operational systems occurred below the alert height, it would be ignored and the approach continued.~~

- ~~(8) Decision height is the wheel height above the runway elevation by which a go-around must be initiated unless adequate visual reference has been established and the aircraft position and approach path have been assessed as satisfactory to continue the approach and landing in safety.~~

- ~~(9) Where it is used in this document it means the minimum decision height determined in the airworthiness certification.~~

- ~~(10) A go-around is the transition from an approach to a stabilised climb~~

### **CS AWO.B.CATIII.102 Safety level**

The safety level for precision approaches with decision heights **DHs** below 30 m (100 ft) or no decision height **DH** may not be less than the average safety level achieved in precision approaches with decision heights **DHs** of 60 m (200 ft) and above. Hence, in showing compliance with the performance and failure requirements, the probabilities of performance or failure effects may not be factored by the proportion of approaches, which are made with the decision height below 30 m (100 ft).

**CS AWO.B.CATIII.103 Go-around rate**

The go-around rate below 150 m (500 ft) attributable to the landing system performance or reliability ~~may~~ shall not be greater than 5 %. Additionally, for ~~decision-height~~ DHs below 15 m (50 ft) and no ~~decision height~~ DH, the probability of go-around below the alert height attributable to the landing system performance and reliability ~~must~~ shall be such that compliance with ~~CS-AWO-301~~ [CS AWO.B.CATIII.102](#) is achieved. (See ~~CS-AWO-365~~ [CS AWO.B.CATIII.123](#) (a).)

**CS AWO.B.CATIII.104 Minimum flight crew**

The workload associated with use of the minimum ~~decision-height~~ DH shall ~~must~~ be considered in showing compliance with CS 25.1523, AMC 25.1523, and CS 25 Appendix D.

**CS AWO.B.CATIII.105 Control of flight path and ground roll**

The landing system shall ~~must~~ control the aeroplane within the prescribed limits along the flight path to touchdown (see ~~CS-AWO-331~~ [CS AWO.B.CATIII.115](#) (a) and (b)) and along the runway (see ~~CS-AWO-338~~ [CS AWO.B.CATIII.117](#)) when appropriate, and specifically:

- (a) For fail-passive automatic landings, ~~the~~ the primary mode of controlling the aeroplane ~~must~~ shall be automatic until the main wheels touch the ground (except as in ~~CS-AWO-321~~ [CS AWO.B.CATIII.113](#)(b)(1)), and for operation with no ~~decision-height~~ DH, control ~~must~~ shall be automatic until the nose wheels touch down.
- (b) For ~~decision-height~~ DHs below 15 m (50 ft), a fail-operational landing system (automatic or hybrid) ~~must~~ shall be provided which, when appropriate, includes provision for control of the aeroplane along the runway during the ground roll-down to a safe speed for taxiing.
- (c) If the landing roll-out is to be accomplished automatically using rudder control, the rudder axis ~~should~~ shall be engaged during the approach phase ~~to ensure that it is functioning correctly prior to touchdown.~~
- (d) For HUDLSs, the system shall provide sufficient guidance information to enable a pilot that is competent to conduct the intended operation to intercept the xLS approach path, if that capability is provided, to track it, to land the aeroplane within the prescribed limits or to make a go-around without reference to other cockpit displays. It shall not require exceptional piloting skill to achieve the required performance. (See [CS AWO.B.CATIII.115](#) (a) and (b)).
- (e) If the autopilot is used to control the flight path of the aeroplane to intercept and establish the xLS approach path, the point during the approach at which the transition from automatic to manual flight takes place shall be identified and taken into account in the performance demonstration (see [CS AWO.B.CATIII.115](#)).

**CS AWO.B.CATIII.106 Control of speed**

Automatic throttle control ~~must~~ shall be provided unless:

- (a) the ~~decision-height~~ DH is 15 m (50 ft) or greater; and
- (b) it is demonstrated in flight that speed can be controlled manually by the ~~flight~~ crew within acceptable limits and without excessive workload. (See ~~CS-AWO-123~~ [CS AWO.A.ALS.105](#) and [AMC AWO.B.CATII.113](#)).

**CS AWO.B.CATIII.107 Manual control**

The transition from an automatic mode to manual mode or the use of a manual mode ~~may~~ **shall** not require exceptional piloting skill, alertness or strength.

**CS AWO.B.CATIII.108 Oscillations and deviations**

The landing system ~~may~~ **shall not** cause ~~no~~ sustained nuisance oscillations or undue attitude changes or control activity as a result of configuration or power changes or any other disturbance to be expected in normal operation.

**CS AWO.B.CATIII.109 Alert height**

(See [AMC AWO.B.CATIII.109](#))

For a fail-operational system with a ~~decision height~~ **DH** below 15 m (50 ft) or with no ~~decision height~~ **DH**, an alert height ~~must~~ **shall** be established in accordance with ~~CS-AWO-365~~ [CS AWO.B.CATIII.123](#) (a) and ~~must~~ **shall** be at least 30 m (100 ft).

**CS AWO.B.CATIII.110 Decision height**

When the ~~decision height~~ **DH** is during the landing flare, it ~~must~~ **shall** be below the height at which the major attitude changes associated with this manoeuvre take place.

**CS AWO.B.CATIII.111 Decision height recognition**

~~Decision height~~ **DH** recognition ~~must~~ **shall** be by means of height measured by a radio altimeter (or other device capable of providing equivalent performance and integrity level). Arrival at the **DH** shall be positively annunciated to both pilots.

**CS AWO.B.CATIII.112 Go-around**

(See [AMC AWO.B.CATIII.112](#))

- (a) The aircraft ~~must~~ **shall** be capable of safely executing a go-around from any point on the approach to touchdown in all configurations to be ~~certified~~ **certificated**. The manoeuvre ~~may~~ **shall** not require exceptional piloting skill, alertness or strength and ~~must~~ **shall** ensure that the aeroplane remains within the obstacle limitation surface for a Category II or III precision approach runway as specified in [ICAO Annex 14-Chicago Convention](#).
- (b) For ~~decision height~~ **DHs** below 15 m (50 ft), automatic go-around ~~must~~ **shall** be provided.
- (c) When automatic go-around is provided, it ~~must~~ **shall** be available down to touchdown.
- (d) When automatic go-around is engaged, ~~the~~ subsequent ground contact ~~should~~ **shall** not cause its disengagement.

**EQUIPMENT****CS AWO.B.CATIII.113 Installed equipment**

(See [AMC AWO.B.CATIII.113](#))

The following items of equipment ~~must~~ **shall** be installed for certification to the ~~decision height~~ **DHs** specified unless it is shown that the intended level of safety is achieved with alternative equipment, or the deletion of some items:

- (a) All ~~decision height~~ DHs below 30 m (100 ft) or no ~~decision height~~ DH:
- (1) Two ~~xLS ILS and/or two MLS~~ receivers. Each pilot's station ~~must~~ shall display:
    - (i) deviation information from the selected ~~xLS ILS/MLS~~ navigation source; and
    - (ii) deviation information from a source independent of the other pilot's display.
  - (2) One radio altimeter (or other device capable of providing equivalent performance and integrity level) with display at each pilot's station.
  - (3) Clear visual indication at each pilot's station (e.g. an alert light) when the aeroplane reaches the preselected ~~decision height~~ DH appropriate to the approach.
  - (4) An appropriate equipment failure warning system.
  - (5) An alert of excess deviation from the required approach path at each pilot's station (~~e.g. amber flashing light~~).
  - (6) In the case of aeroplanes having a minimum flight crew of two pilots, an automatic voice system, which calls when the aeroplane is approaching the ~~decision height~~ DH (or when approaching the ground during a no ~~decision height~~ DH approach) and when it reaches the ~~decision height~~ DH.
  - (7) An anti-skid braking system unless it can be shown that the aeroplane can land safely without such a system (See [AMC AWO.B.CATIII.113](#)).
  - (8) A means for the pilot to determine that the aeroplane can be stopped within the available runway length (see [AMC AWO.B.CATIII.113](#)).

The number of ~~xLS ILS and/or MLS~~ receivers and radio altimeters (or other device capable of providing equivalent performance and integrity level) may need to be increased in order to provide fail-operational capability where required.

- (b) ~~Decision height~~ DH of 15 m (50 ft) or greater (See [AMC AWO.B.CATIII.113\(b\)\(2\)](#)):

Compliance with any one of the following paragraphs (1) ~~or~~, (2) ~~or~~ (3) is acceptable. The RVR minima authorised will be dependent on the equipment installed in compliance with a particular paragraph, and in accordance with the operational rules.

- ~~1) (i) Fail-passive automatic approach system without automatic landing, provided that:~~
- ~~(A) It is demonstrated that manual landings can be made without excessive workload in the visibility conditions; and~~
  - ~~(B) The aeroplane has a low approach speed, is easily manoeuvrable and the height of the pilot's eyes above the wheels is small;~~
  - ~~(ii) Automatic throttle control, unless it can be shown that speed control does not add excessively to the crew workload;~~
  - ~~(iii) Automatic or flight director go-around or suitable attitude indicators.~~

~~or~~

~~(12)~~

- (i) Fail-passive automatic landing system or HUDLS head-up display guidance landing system;
- (ii) Automatic throttle control, unless it can be shown that speed control does not add excessively to the flight crew workload.
- (iii) Automatic or flight director go-around or suitable attitude indicators.

or

(23)

- (i) Super Fail-passive automatic landing system, provided that:
  - (A) it is demonstrated that a manual go-around can be made without excessive flight crew workload following loss of automatic landing capability; and
  - (B) the aeroplane has a low approach speed, is easily manoeuvrable and the height of the pilot's eyes above the wheels is small;
- (ii) Automatic throttle control, unless it can be shown that speed control does not add excessively to the flight crew workload;
- (iii) Fail-passive automatic go-around;
- (iv) Automatic ground roll control or head up ground roll guidance, for control or guidance, along the runway during the ground roll down to a safe speed for taxiing.

(c) Decision height DH below 15 m (50 ft):

- (1) Fail-operational automatic landing system or fail-operational hybrid landing system;
- (2) Fail-passive automatic go-around;
- (3) Automatic throttle control; and
- (4) Automatic ground roll control or head-up ground roll guidance (see ~~CS-AWO 304~~ [CS AWO.B.CATIII.105](#)).

(d) No decision height DH:

- (1) Fail-operational automatic landing system;
- (2) Fail-passive automatic go-around;
- (3) Automatic throttle control; and
- (4) Fail-operational or fail-passive automatic ground roll control or head-up ground roll guidance (see ~~CS-AWO 304~~ [CS AWO.B.CATIII.105](#)). and
- ~~(5) Anti-skid braking system.~~

#### **CS AWO.B.CATIII.114 Minimum equipment**

The minimum equipment, which must be serviceable at the beginning of an approach for compliance with the general criteria of this section ~~Subpart 3~~ and those relating to performance and failure conditions, ~~must shall~~ be established and articulated.

## PERFORMANCE

### CS AWO.B.CATIII.115 Performance demonstration

(See [AMC AWO.B.CATIII.115](#))

- (a) Flight path and speed control ~~must~~ shall comply with the provisions of ~~CS-AWO-231~~ [CS AWO.B.CATII.113](#) and ~~243~~ [CS AWO.B.SACATII.116](#). (See [AMC AWO.B.CATII.113](#))
- (b) Touchdown performance of automatic landing systems ~~must~~ shall comply with the provisions of ~~CS-AWO-131~~ [CS AWO.A.ALS.106](#), ~~132~~ [CS AWO.A.ALS.107](#), ~~142~~ and [CS AWO.A.ALS.109](#). For operation with no decision height DH, compliance with the lateral touchdown performance criteria ~~must~~ shall be demonstrated at main wheel and nose wheel touchdown.
- (c) The automatic throttle system ~~must~~ shall comply with the provisions of ~~CS-AWO-123~~ [CS AWO.A.ALS.105](#).
- (d) Compliance with ~~CS-AWO-337~~ [CS AWO.B.CATIII.116](#) and ~~338~~ [CS AWO.B.CATIII.117](#) (a) ~~may~~ shall be demonstrated primarily by flight test. Compliance with paragraphs (a) and (b) of this provision and ~~CS-AWO-338~~ [CS AWO.B.CATIII.117](#) (b) ~~must~~ shall be demonstrated by analysis and simulator tests supported by flight tests. Flight testing and any associated analysis ~~must~~ shall include a sufficient number of approaches and landings conducted in conditions which are reasonably representative of actual operating conditions and ~~must~~ shall cover the range of parameters affecting the behaviour of the aeroplane (e.g. wind conditions, runway and ~~xLS ILS or MLS~~ ground facility characteristics, aeroplane configurations, weight, and centre of gravity).
- (e) In showing compliance with points (a) and (b), when a HUDLS is used for primary guidance, the following additional variables shall be included in the performance demonstration (see [AMC AWO.A.HUD.107](#)):
  - (1) ambient lighting conditions and approach and runway lighting;
  - (2) variations of the reported RVR; and
  - (3) individual flight crew performance.

### CS AWO.B.CATIII.116 Head-up display fail-operational hybrid landing system

Where a ~~head-up display~~ HUDLS is fitted as part of a hybrid system, its performance need not meet the same criteria as the primary system provided that it:

- (a) ~~it~~ meets the overall performance requirements, taking into account the probability that it will be used; and
- (b) ~~it~~ is sufficiently compatible with the primary system so as to retain pilot confidence.

### CS AWO.B.CATIII.117 Automatic ground roll control

(See [AMC AWO.B.CATIII.115](#))

- (a) When automatic ground roll control or head-up ground roll guidance is being used, the probability ~~must be less than 5%~~ that the point on the aeroplane centre line between the main wheels will deviate more than 8.2 m (27 ft) from the runway centre line on any one landing ~~shall be less than 5%~~.

- (b) Additionally, when the operation is predicated on the provision of fail-operational ground roll control, the probability ~~must be less than  $10^{-6}$~~  that the outboard landing gear will deviate to a point more than 21.3 m (70 ft) from the runway centre line while the speed is greater than 74 km/h (40 kt) ~~shall be less than  $10^{-6}$~~ .

#### CS AWO.B.CATIII.118 Landing distance

If there is any feature of the system or the associated procedures which would result in an increase to the landing distance ~~required~~, the appropriate increment ~~must~~ **shall** be established and scheduled in the ~~aeroplane flight manual~~ **AFM**.

#### CONTROLS, INDICATORS AND ~~WARNINGS~~ **ALERTS**

#### CS AWO.B.CATIII.119 Mode selection and switching

- ~~(a) A positive and continuous indication must be provided of the modes actually in operation. In addition, where engagement of a mode is automatic (e.g. localiser and glide path acquisition), clear indication must be given when the mode has been armed by a member of the flight crew.~~
- ~~(b) Where reliance is placed on the pilot to detect non-engagement of go-around mode when it is selected, an appropriate indication or warning must be given.~~

The system ~~must~~ **shall** be designed so that no manual selections or changes of switch settings need be made below a height of 150 m (500 ft) in normal operation, other than system disengagement or selection of automatic go-around as necessary.

#### CS AWO.B.CATIII.120 Indications and ~~warnings~~ **alerts**

(See [AMC1 AWO.B.CATIII.121](#) and [AMC AWO.A.ALS.110](#))

- (a) The display of information to the **flight** crew, including that required to monitor the approach, flare and ground roll, ~~must~~ **shall** be compatible with the procedures specified in the ~~aeroplane flight manual~~ **AFM** or flight crew operating manual as appropriate and with normal **flight** crew tasks. ~~All indications must be designed to minimise crew errors.~~
- ~~b) Essential information and warnings necessary to the crew in the use of the landing system must be so located and designed as to permit both their accurate use in normal operation and the rapid recognition of malfunctions in all expected lighting conditions.~~
- (b) Any malfunction of the landing system or of the ~~xLS~~ **I**LS or ~~MLS~~ **g**round facility which requires a missed approach ~~must~~ **shall be** ~~annunciate~~ **annunciate** positively and unambiguously **annunciated** to each pilot, so that pilot action may be initiated promptly without further interpretation. (See AMC 25.1322).
- (c) Notwithstanding ~~paragraphs~~ **points** (a), ~~(b)~~ and (b ~~e~~) of this ~~paragraph~~ **provision**, for fail-operational systems, failure warnings may be inhibited below alert height if:
- (1) the failure does not preclude continuation of an automatic landing; and
  - (2) the failure requires no specific action of the flight crew; and
  - (3) information on the occurrence of any failure warnings so inhibited is subsequently available to flight and maintenance crews.

- (d) Where the capability of the aeroplane is dependent on equipment serviceability and modes selected, means ~~must~~ shall be provided whereby the pilot can readily determine the capability at alert height (e.g. fail-operational status, ground roll availability).

## FAILURE CONDITIONS

### CS AWO.B.CATIII.121 General

(See CS 25.1309 and its AMC, [AMC1 AWO.B.CATIII.121](#) and [AMC2 AWO.B.CATIII.121](#))

- (a) ~~The automatic landing system must comply with the provisions of CS-AWO 161 and 172.~~
- (a) The effects of failures of the flight guidance system including the navigation means shall be considered in accordance with the requirements of CS 25.1309 and CS 25.1329.
- (b) The radio altimeter (or other device capable of providing equivalent performance and integrity level), and excess-deviation alerts ~~must~~ shall comply with the provisions of ~~CS-AWO-268~~ [CS AWO.B.CATII.120](#) and ~~269~~ [CS AWO.B.CATII.121](#) respectively.

### CS AWO.B.CATIII.122 Fail-passive automatic landing system (including super fail-passive system)

(See [AMC1 AWO.B.CATIII.122\(a\)](#) and [AMC2 AWO.B.CATIII.122\(a\)](#))

- (a) For a fail-passive automatic landing system, failure conditions resulting in the loss of automatic landing control capability below the decision height DH ~~may~~ shall not be frequent. ~~(See AMC No. 1 and No. 2 to AWO 364(a) and AMC No. 2 to CS-AWO 361)~~ occur more frequently than once every thousand approaches.
- (b) For a fail-passive automatic landing system, any failure condition, which is not extremely remote, ~~must~~ shall be automatically detected and neutralised before it has a significant effect on the trim, flight path or attitude. ~~(See AMCs No. 1 and 2 to CS-AWO 361)~~

### CS AWO.B.CATIII.123 Fail-operational landing system (automatic or hybrid)

(See [AMC2 AWO.B.CATIII.121](#))

- (a) For a fail-operational landing system, the probability of total loss of the landing system below the alert height ~~must~~ shall be extremely remote. Demonstration of compliance ~~must~~ shall be by means of a suitable analysis programme supported, where necessary, by a simulation and flight test programme (see [AMC1 AWO.B.CATIII.122\(a\)](#) and [AWO.B.CATIII.123\(a\)](#)). Special precautions ~~must~~ shall be taken to ensure that redundant subsystems are not vulnerable to simultaneous disengagement or failure warning. ~~(See AMC AWO 161(b) paragraph 1.3(c).)~~
- (b) A fail-operational landing system ~~must~~ shall operate as a fail-passive system following a first failure, which leads to loss of fail-operational capability. ~~(See AMC No. 1 to CS-AWO 361)~~
- (c) A fail-operational automatic throttle system ~~must~~ shall be provided unless the effect of loss of automatic throttle control is minor. ~~(See AMC No. 1 to CS-AWO 361)~~

### CS AWO.B.CATIII.124 Head-up display (or other form of guidance display) fail-operational hybrid landing system

(See [AMC1 AWO.B.CATIII.121](#) and [AMC2 AWO.B.CATIII.121](#))

Where a ~~head-up display or other form of guidance display~~ HUDLS is fitted for use in the event of automatic landing system failure, the combination of the two systems ~~must~~ shall comply with ~~CS-AWO~~



~~161~~ [CS AWO.A.ALS.111](#) and ~~172~~ [CS AWO.A.ALS.112](#). In addition, the failure modes of the display ~~may~~ shall not be such as might lead a pilot to disengage a satisfactorily functioning autopilot and obey the malfunctioning display.

#### **CS AWO.B.CATIII.125 Nose-wheel steering**

(See [AMC1 AWO.B.CATIII.121](#) and [AMC2 AWO.B.CATIII.121](#))

In showing that the nose-wheel steering system complies with CS 25.745(c), account ~~must~~ shall be taken of the effect of the visibility conditions on the ability of the pilot to detect steering faults and to take over control.

#### **CS AWO.B.CATIII.126 Automatic go-around**

Total failure (shutdown) of the ~~xLS ILS or MLS ground~~ facility ~~may~~ shall not result in loss of automatic go-around capability.

### **AEROPLANE FLIGHT MANUAL**

#### **CS AWO.B.CATIII.127 General**

(See [AMC AWO.B.CATIII.127\(a\)](#))

The aeroplane flight manual AFM ~~must~~ shall state:

- (a) limitations, including the minimum crew, alert height, the DHs for which the aeroplane is ~~certificated~~ certified, etc. (see [AMC AWO.B.CATIII.127\(a\)](#));
- (b) the permitted configurations (e.g. flap setting, number of engines operating);
- (c) the normal and abnormal procedures (see [AMC2 AWO.B.CATIII.121](#));
- (d) changes to the performance information, if necessary (e.g. the approach speed, landing distance required, go-around climb); ~~and~~
- (e) ~~the~~ minimum required equipment including flight instrumentation (see ~~CS AWO 321~~ [CS AWO.B.CATIII.113](#) and ~~322~~ [CS AWO.B.CATIII.114](#));
- (f) the height losses for go-around initiation heights below 30 m (100 ft), determined in accordance with [AMC AWO.B.CATIII.112](#) paragraph 2a-; ~~and~~
- (g) the type of xLS navigation means (facilities external to the aircraft) and associated limitations (if any) which have been used as the basis for certification (see [AMC AWO.B.CATIII.127\(g\)](#)).

## CERTIFICATION DOCUMENTATION

### CS AWO.B.CATIII.128 Documentation required

Documentation providing the following information is required for certification:

- (a) A specification of the aeroplane and the airborne equipment.
- (b) Evidence that the equipment and its installation comply with the applicable standards.
- (c) A failure analysis and an assessment of system safety (see AMC 25.1309).
- (d) A performance analysis demonstrating compliance with the performance criteria of ~~CS-AWO-331~~ [CS AWO.B.CATIII.115](#), ~~337~~ [CS AWO.B.CATIII.116](#) and ~~338~~ [CS AWO.B.CATIII.117](#) (see ~~CS-AWO-131~~ [CS AWO.A.ALS.106 \(b\)](#)).
- (e) Flight test results including validation of any simulation.
- (f) Limitations on the use of the system and crew procedures to be incorporated in the ~~aeroplane flight manual~~ [AFM](#).
- (g) Evidence that the crew workload complies with CS 25.1523. ~~and~~
- (h) Inspection and maintenance procedures shown to be necessary by the SSA (see CS 25.1529)

## SECTION 5

### AIRWORTHINESS CERTIFICATION OF AEROPLANES FOR OPERATIONAL CREDITS FOR VISUAL SEGMENT IN REDUCED RUNWAY VISUAL RANGE (RRVR)

#### CS AWO.B.RRVR.101 Applicability

An aeroplane shall be considered to be eligible to apply for certification for operational credit for the visual segment of approach and landing in reduced runway visual range (RRVR) conditions if the aeroplane has demonstrated compliance with Subpart A [Section 3 \(EFVS\)](#) of this certification specification and by inference the applicable provisions of Subpart A [Section 2 \(HUD\)](#).

**SUBPART C — TAKE-OFF****SECTION 1****DIRECTIONAL GUIDANCE FOR TAKE-OFF IN LOW VISIBILITY****AIRWORTHINESS CERTIFICATION OF AEROPLANES FOR TAKE-OFF OPERATIONS IN LOW VISIBILITY  
(TOO)****CS AWO.C.TOO.101 Applicability and terminology**

- a) ~~This Subpart 4 C of this airworthiness code certification specification~~ is applicable to aeroplanes for which certification is sought to allow the performance of take-off in lower visibilities than those which are sufficient to ensure that the pilot will at all times have sufficient visibility to complete or abandon the take-off safely. It is only concerned with directional guidance during the ground-borne portion of the take-off (i.e. from start to main wheel lift-off, or standstill in the event of abandoned take-off). (See [AMC AWO.C.TOO.101](#))
- b) ~~Take-off Guidance System: A take-off guidance system provides directional guidance information to the pilot during the take-off or abandoned take-off. It includes all the airborne sensors, computers, controllers and indicators necessary for the display of such guidance. Guidance normally takes the form of command information, but it may alternatively be situation (or deviation) information.~~

**CS AWO.C.TOO.102 Safety level**

The safety level in take-off in low visibility ~~must~~ shall not be less than the average safety level achieved in take-off in good visibility. ~~Hence, in showing compliance with the performance and failure requirements, the probabilities of performance or failure effects may not be factored by the proportion of take-offs that are made in low visibility.~~

**CS AWO.C.TOO.103 Guidance information**

The take-off guidance system ~~must~~ shall provide guidance information which will, in the event of loss of visibility during the take-off, enable the pilot to control the aeroplane to the runway centre line during the take-off or abandoned take-off using the normal steering controls. Its use ~~must~~ shall not require exceptional piloting skill or alertness.

**CS AWO.C.TOO.104 Guidance display**

- (a) The take-off guidance information ~~must~~ shall be provided in such a form that it is immediately usable by the pilot who is making the take-off. Its use ~~must~~ shall not require the pilot ~~him~~ to refer to ~~his~~ the instrument panel for this information, nor ~~must~~ shall it require the other pilot to take control of the aeroplane. Reversion to the system ~~must~~ shall be easy and natural.
- (b) The information display ~~must~~ shall be usable in all appropriate conditions of ambient light, runway lighting and visibility.
- (c) The system ~~must~~ shall be designed to minimise crew errors. (See [AWO.C.TOO.104\(c\)](#)).

## EQUIPMENT

### CS AWO.C.TOO.105 Minimum equipment

The minimum equipment, which ~~must~~ shall be serviceable at the start of the take-off for compliance with the general criteria of this ~~Subpart 4~~ and those relating to performance and failure conditions, ~~must~~ shall be established and articulated.

## PERFORMANCE

### CS AWO.C.TOO.106 Performance demonstration

(See [AMC AWO.C.TOO.106](#) and Figure 1)

- (a) It ~~must~~ shall be demonstrated that the performance of the take-off guidance system is such that the aeroplane will not deviate significantly from the runway centre line during take-off while the system is being used within the limitations established for it. Compliance may be demonstrated by flight test, or by a combination of flight test and simulation. Flight testing ~~must~~ shall cover those factors affecting the behaviour of the aeroplane, ~~e.g. wind conditions, ILS and/or MLS ground facility characteristics, aeroplane configurations, weight, and centre of gravity.~~
- (b) In the event that the aeroplane is displaced from the runway centre line at any point during the take-off or abandoned take-off, the system ~~must~~ shall provide such guidance as would enable the pilot to control the aeroplane smoothly back to the runway centre line without any sustained nuisance oscillation.
- (c) In the event of an engine failure, if the pilot follows the guidance information and disregards external visual reference, the lateral deviation of the aeroplane ~~must~~ shall remain safely within the confines of the runway.

### CS AWO.C.TOO.107 Limitations and procedures

Limitations on the use of the system and appropriate procedures ~~must~~ shall be established, where these are necessary for compliance with the criteria of ~~CS-AWO-431~~ [CS AWO.C.TOO.106](#). Account should be taken of the method by which the system defines the runway centre line and associated errors or delays.

## CONTROLS, INDICATORS AND ~~WARNINGS~~ ALERTS

### CS AWO.C.TOO.108 ~~Warnings~~ Alerts

(See [AMC AWO.C.TOO.108](#))

- (a) System ~~warnings~~ alerts ~~must~~ shall be so designed and located as to ensure rapid recognition of failures.
- (b) The information display and system ~~warnings~~ alerts ~~must~~ shall not distract the pilot making the take-off or significantly degrade forward view.

**FAILURE CONDITIONS**

(See AMC 25.1309)

**CS AWO.C.TOO.109 Guidance system**

- (a) The take-off guidance system ~~must~~ shall be such that the display of incorrect guidance information to the pilot during the take-off run is assessed as remote. In demonstrating compliance with this criterion, account need only be taken of incorrect guidance of such magnitude that it would lead to the aeroplane deviating from the runway, if it is followed.
- (b) Probability of loss of take-off guidance during the take-off ~~must~~ shall be assessed as remote.

**CS AWO.C.TOO.110 Aeroplane failures**

Any single failure of the aeroplane which disturbs the take-off path (e.g. engine failure) ~~must~~ shall not cause loss of guidance information or give incorrect guidance information.

**AEROPLANE FLIGHT MANUAL****CS AWO.C.TOO.111 General**

(See [AMC AWO.C.TOO.111](#))

In relation to the approval of the aeroplane for take-off in reduced visibility, the ~~aeroplane flight manual~~ AFM ~~must~~ shall state:

- (a) the limitations;
- (b) the normal and abnormal procedures, including where appropriate, the most critical conditions demonstrated; and
- (c) the minimum required equipment.

## CS-AWO BOOK 2

## SUBPART A — GENERAL

## AMC TO SECTION 1

## AUTOMATIC LANDING SYSTEMS (ALS)

**AMC AWO.A.ALS.101(a) Applicability and terminology**

MLS and GLS are assumed to have equivalent operational characteristics to those of a conventional ILS. The terms 'localiser' and 'glide path' have been retained for use with either ILS, or MLS or GLS.

The term 'automatic landing system' refers to the airborne equipment, which provides automatic control of the aeroplane during the approach and landing. It includes all of the sensors, computers, actuators and power supplies necessary to control the aeroplane to touchdown. It also includes provisions to control the aeroplane along the runway during the landing roll-out. In addition, it includes the indications and control necessary for its management and supervision by the pilot.

**AMC AWO.A.ALS.105(b)(1) Automatic throttle control**

The approach speed may be selected manually or automatically.

**AMC AWO.A.ALS.106 Performance demonstration**

## 1 General

1.1 The analysis referred to in [CS AWO.A.ALS.106](#) (b)(1) should:

- a. establish compliance with the performance limits specified in [CS AWO.A.ALS.106](#) (c);

NOTE: When systems employing automatic control ground roll are provided, additional analysis may be required.

- b. determine any limitations on the use of the system for compliance with performance limits of [CS AWO.A.ALS.106](#) (c) (see [CS AWO.A.ALS.114](#)); and
- c. provide, if appropriate, information necessary for the calculation of the required landing distance (see [CS AWO.A.ALS.109](#)).

1.2 Account should be taken of the variation of wind speed, turbulence, ~~xLS ILS and/or MLS~~ beam characteristics, system performance variation and flight crew procedures. System performance variations due to equipment tolerances (e.g. datum shifts and gain changes) should be investigated taking into account setting-up procedures and monitoring practices. Acceptable models of wind, turbulence and wind shear are given in paragraph 3. ~~ILS and MLS~~ ~~xLS~~ signal-in-space characteristics are given in paragraph 4.

1.3 In accordance with [CS AWO.A.ALS.107](#), the effects of aerodrome conditions (e.g. elevation, ambient temperature, runway slope and ground profile under the approach path) are to be investigated and, if necessary, appropriate limitations derived for inclusion in the ~~aeroplane flight manual~~ AFM. Guidance is given in paragraph 5.

1.4 Acceptable values for the probabilities of exceedance of the limits of [CS AWO.A.ALS.106](#) (c) are as follows. These values may be varied where the characteristics of a particular aeroplane justify such variation.

	Average	Limit
a. <i>Longitudinal touchdown</i> earlier than a point on the runway 60 m (200 ft) from the threshold.	$10^{-6}$	$10^{-5}$
b.		
(i). <i>Longitudinal touchdown</i> beyond the end of the TDZ lighting, 823 m (2 700 ft) from the threshold.	$10^{-6}$	Not applicable
(ii). <i>Longitudinal touchdown</i> beyond the end of the TDZ lighting, 914 m (3 000 ft) from the threshold.	Not applicable	$10^{-5}$
c. <i>Lateral touchdown</i> with the outboard landing gear greater than 21 m (70 ft) from the runway centre line, assuming a 45 m (150 ft) runway.	$10^{-6}$	$10^{-5}$
d. <i>Sink rate</i> for structural limit load (See paragraph 1.4.1).	$10^{-6}$	$10^{-5}$
e. <i>Bank angle</i> such that wing tip, engine nacelle or propeller touches the ground before wheels.	$10^{-8-7}$	$10^{-7-6}$
f. <del><i>Lateral velocity or slip angle</i> for structural limit load.</del>	$10^{-6}$	$10^{-5}$

NOTE: The 'Average' column is the probability of occurrence if all variables vary according to their probability distributions. The 'Limit' column is the probability of occurrence if one variable is held at its most adverse value, while the other variables vary according to their probability distributions.

NOTE 1: The 'Average' column is the acceptable probability of exceedance where all the variables vary according to their probability distributions. The 'Limit' column is the acceptable probability of exceedance if one variable is held at its most adverse value, while the other variables vary according to their probability distributions. In the case where a wind variable is held at its most adverse value, the acceptable probability of exceedance should be taken as the average column factored by the cumulative probability of reported wind as defined in Figure 15 of [Appendix 1 to AMC to Subpart A 'MODELS'](#).

NOTE 2: For HUDLSs, an alternative means of compliance for [CS AWO.A.ALS.106](#) (c) may be used. One acceptable means of compliance is given in paragraph 1.4.2 of this AMC.

1.4.1 An acceptable means of establishing that the structural limit load is not exceeded is to show separately and independently that:

- a. the sink rate at touchdown does not exceed the limit rate of descent used for certification under CS 25 Subpart C, or 10 ft per second, whichever is the greater; and
- b. the lateral side load does not exceed the limit value determined for the lateral drift landing condition defined in CS 25.479(d)(2).



1.4.2 For HUDLSs, where total wind strength has been shown to be the most critical parameter affecting performance, an alternative means of compliance for [CS AWO.A.ALS.106](#) (c) may be used.

An acceptable method, based on the demonstration of 80 approaches performed in a simulator at limiting wind conditions using a representative wind model, covering eight cardinal points has been shown to provide adequate demonstration of system robustness, provided that the resulting go-around rate does not exceed 20 %.

1.5 Acceptance limits for automatic throttle speed holding are  $\pm 9.3$  km/h ( $\pm 5$  kt) (two standard deviations) of programmed airspeed (disregarding rapid airspeed fluctuations associated with turbulence) under all intended flight conditions.

## 2 Flight demonstrations

2.1 A programme of landings should be completed and be sufficient to demonstrate the validity of the simulation and support the conclusions of the analysis.

NOTE: Typically, programmes of 100 landings have been used.

Data taken during demonstration flight tests should be used to validate the simulation(s). The objective of a flight test programme should be to demonstrate performance of the system to 100 % of the steady state wind limit values that are used in the simulation statistical performance analysis.

Nevertheless, if during flight test campaign, it is not possible to flight test 100 % of the steady state wind limit, the applicant may request acceptance that the simulation is validated, if at least four landings are accomplished during flight test at no less than 80 % of the intended limit steady state wind value (i.e. mean wind), and if it has been shown that the landing system is sufficiently robust near the desired AFM wind limits for which application is made.

The robustness of autoland will be assessed as sufficient if:

- analysis of the automatic landing system behaviour encountered during flight tests for the four landings selected by the applicant shows satisfactory margins in authority and performance;
- analysis of the matching between flight test and simulation for the four landings selected by applicant shows satisfactory correlation. If the four landings flight tested show satisfactory margins and performances, the matching requested may be limited to a subset of the four landings selected;
- aircraft loading conditions flown during the four landings (weight and centre of gravity) are sufficiently close to the sizing conditions, that would have an influence on wind demonstration limits (sizing conditions as defined in the certification flight test programme); and
- analysis of the automatic landing system behaviour during simulation with the steady state wind value (i.e. mean wind) at the wind limit requested, shows remaining margins for performance.

The steady state wind value can be determined by either of the following:

- a. mean wind value + half gust, as reported by air traffic control (ATC); or

b. mean wind recorded by the flight test instrumentation, i.e. average of the wind recorded for 20 sec around the touchdown point and recomputed at 33 ft, with the following additional considerations:

- Additional credit can be taken for the max average wind demonstrated during flight test if the gust encountered during flight test shows a higher intensity than the one tested during simulation (meaning the wind increase to the average wind is higher during flight test compared to the simulation).
- In this case, to give a revised max average wind demonstrated during flight test, the mean wind recorded by the flight test instrumentation may be increased by the difference between flight tested and simulation tested gust intensity.

2.2 Individual landings should be carried out to demonstrate that errors, which can reasonably be expected to occur, are not hazardous. For example:

- landing with approach speed 9.3 km/h (5 kt) below the specified speed; and
- landing with approach speed 18.5 km/h (10 kt) above the specified speed.

### 3 Wind model for approach simulation

In carrying out the analysis described in paragraph 1, one of the wind, turbulence and wind shear following models contained in [Appendix 1 to AMC to Subpart A](#) of wind, turbulence and wind shear may be used:

#### 3.1 ~~Wind Model Number 1~~

~~3.1.1 Mean Wind. It may be assumed that the cumulative probability of reported mean wind speed at landing, and the crosswind component of that wind are as shown in Figure 1. Normally, the mean wind which is reported to the pilot, is measured at a height, which may be between 6 m (20 ft) and 10 m (33 ft) above the runway. The models of wind shear and turbulence given in paragraphs 3.2 and 3.3 assume this reference height is used.~~

#### ~~3.1.2 Wind Shear~~

~~3.1.2.1 Normal Wind Shear. Wind shear should be included in each simulated approach and landing, unless its effect can be accounted for separately. The magnitude of the shear should be defined by the expression:~~

~~$$u = 0.43 U \log_{10}(z) + 0.57 U \quad (1)$$~~

~~where u is the mean wind speed at height z metres (z ≥ 1m) and U is the mean wind speed at 10 m (33 ft).~~

~~3.1.2.2 Abnormal Wind Shear. The effect of wind shears exceeding those of paragraph 3.1.2.1 should be investigated using known severe wind shear data.~~

#### ~~3.1.3 Turbulence~~

~~3.1.3.1 Horizontal Component of Turbulence. It may be assumed that the longitudinal component (in the direction of mean wind) and lateral component of turbulence may each be represented by a Gaussian process having a spectrum of the form:~~

$$\Phi(\Omega) = \frac{2\sigma^2}{\pi} \cdot \frac{L}{1 + \Omega^2 L^2} \quad (2)$$

where

$\Phi$  (er = a spectral density [[metres/sec]<sup>2</sup> per [radian/metre]].

$\sigma$  = root mean square (rms) turbulence intensity = 0.15 U.

L = scale length = 183 m (600 ft)

$\Omega$  = frequency [radians/metre].

3.1.3.2 *Vertical Component of Turbulence.* It may be assumed that the vertical component of turbulence has a spectrum of the form defined by equation (2) in paragraph 3.1.3.1. The following values have been in use:

$\sigma$  = 2.8 km/h (1.5 knots) with L = 9.2 m (30 ft)

or alternatively

$\sigma$  = 0.09 U with L = 4.6m (15 ft) when  $z < 9.2$  m (30 ft)

and L = 0.5 z when  $9.2 < z < 305$  m ( $30 < z < 1\,000$  ft.)

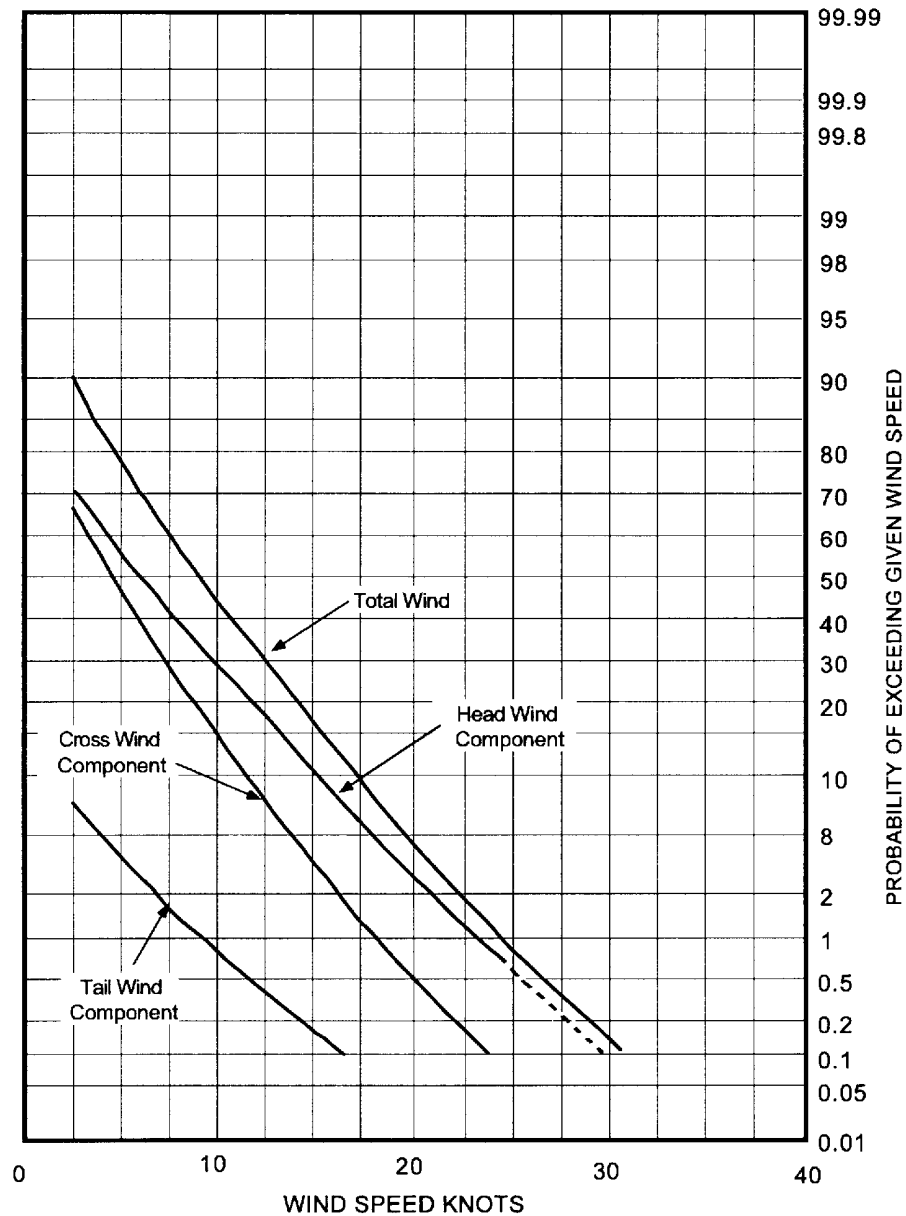

NOTE: This data is based on world-wide in-service operations of UK airlines (Sample size about 2000)

**Figure 1: Cumulative probability of reported mean wind and headwind, tailwind and crosswind components when landing**

3.2 Wind Model Number 2

3.2.1 Mean Wind. The mean wind is the steady state wind measured at landing. This mean wind is composed of a **downwind** component (headwind and tailwind) and a **crosswind** component. The cumulative probability distributions for these components are provided in Figure 2 (downwind) and Figure 3 (crosswind). Alternatively, the mean wind can be defined with magnitude and direction. The cumulative probability for the mean wind magnitude is provided in Figure 4, and the histogram of the mean wind direction is provided in Figure 5. The mean wind is measured at a reference altitude of 20 feet AGL. The models of the wind shear and turbulence given in sections 3.2.2 and 3.2.3 assume this reference altitude of 20 feet AGL is used.

~~3.2.2 Wind Shear. When stable and steady horizontal wind blows over the ground surface, terrain irregularities and obstacles such as trees and buildings alter the steady wind near the surface and a boundary layer will cause a form of windshear. The magnitude of this shear is defined by the following expression:~~

$$\cancel{V_{wref}} = \cancel{0.204 * V_{20} * \ln((h + 0.15)/0.15)}$$

~~where  $V_{wref}$  is the mean wind speed measured at h feet and  $V_{20}$  is the mean wind speed (feet/sec) at 20 feet AGL.~~

~~NOTE: This expression does not represent the violent windshears created by unstable airmass conditions.~~

### ~~3.2.3 Turbulence~~

~~3.2.3.1 Turbulence Spectra. The turbulence spectra are of the Von Karman form.~~

~~The vertical component of turbulence (perpendicular to the earth's surface) has a spectrum of the form defined by the following equation:~~

$$\cancel{\Phi_w(\Omega)} = \cancel{\frac{\sigma_w^2 L_w}{2\pi} \frac{1 + \frac{8}{3} (1.339 L_w \Omega)^2}{(1 + (1.339 L_w \Omega)^2)^{1/6}}}$$

~~The horizontal component of turbulence (in the direction of the mean horizontal wind) has a spectrum of the form defined by the following equation:~~

$$\cancel{\Phi_u(\Omega)} = \cancel{\frac{\sigma_u^2 L_u}{\pi} \frac{1}{(1 + (1.339 L_u \Omega)^2)^{5/6}}}$$

~~The lateral component of turbulence (perpendicular to the mean horizontal wind) has a spectrum of the form defined by the following equation:~~

$$\cancel{\Phi_v(\Omega)} = \cancel{\frac{\sigma_v^2 L_v}{2\pi} \frac{1 + \frac{8}{3} (1.339 L_v \Omega)^2}{(1 + (1.339 L_v \Omega)^2)^{1/6}}}$$

~~where~~

~~$\Phi$  = spectral density [feet/sec]<sup>2</sup>~~

~~$\sigma$  = root mean square (rms) turbulence intensity [feet/sec]~~

~~$L$  = scale length~~

~~$\Omega$  = spatial frequency [radians/foot] =  $\omega/V_T$~~

~~$\omega$  = temporal frequency [radians/sec]~~

~~$V_T$  = aircraft speed [feet/sec]~~

~~3.2.3.2 Turbulence Intensities and Scale Lengths. At or above an altitude  $h_1$ , turbulence is considered to be isotropic i.e. the statistical properties of the turbulence components are independent. This means that one can consider the turbulence components to have equal intensities.~~

Below  $h_1$ , turbulence varies with altitude. In this case, intensity and scale length are expressed as functions of  $V_{20}$  (feet/sec ... see above) and altitude.

#### Turbulence Intensities

$$\sigma_W = 0.1061 V_{20}$$

For  $h < h_1$ ,

$$\sigma_U = \sigma_V = \frac{\sigma_W}{\left(0.177 + \frac{0.823h}{h_1}\right)^{0.4}}$$

For  $h \geq h_1$ ,

$$\sigma_U = \sigma_V = \sigma_W$$

where  $h_1 = 1\,000$  ft.

#### Scale Lengths

For  $h < h_1$ ,

$$L_W = h$$

$$L_U = L_V = L_W \left(\frac{\sigma_U}{\sigma_W}\right)^3 = \frac{h}{\left(0.177 + \frac{0.823h}{h_1}\right)^{1.2}}$$

For  $h \geq h_1$

$$L_W = L_U = L_V = h_1$$

where  $h_1 = 1\,000$  ft.

3.2.3.3 Fixed turbulence intensities for pilot in the loop simulations. The following fixed levels of turbulence intensity [feet/sec] have been found to be representative when used to program low altitude simulations with the pilot in the loop.

Turbulence Intensity	Light	Medium	Heavy
$\sigma_U = \sigma_V$	2.5	5.0	8.3
$\sigma_W$	1.25	2.5	4.17

Turbulence scale lengths vary with altitude according to the equations of para 3.2.3.2.

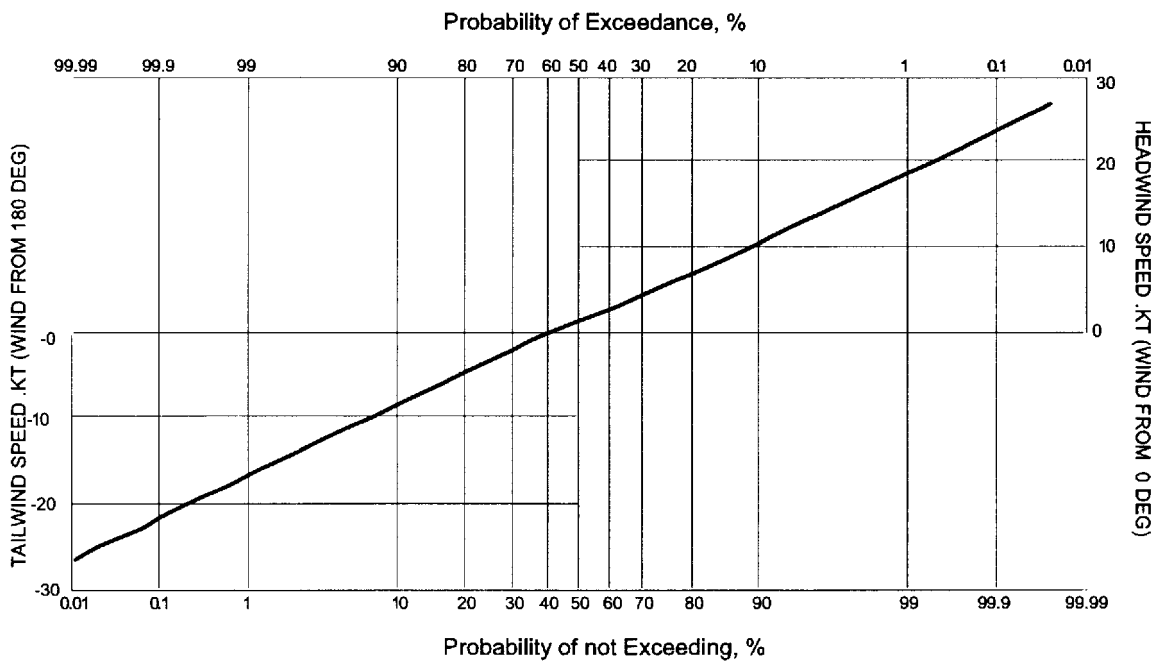

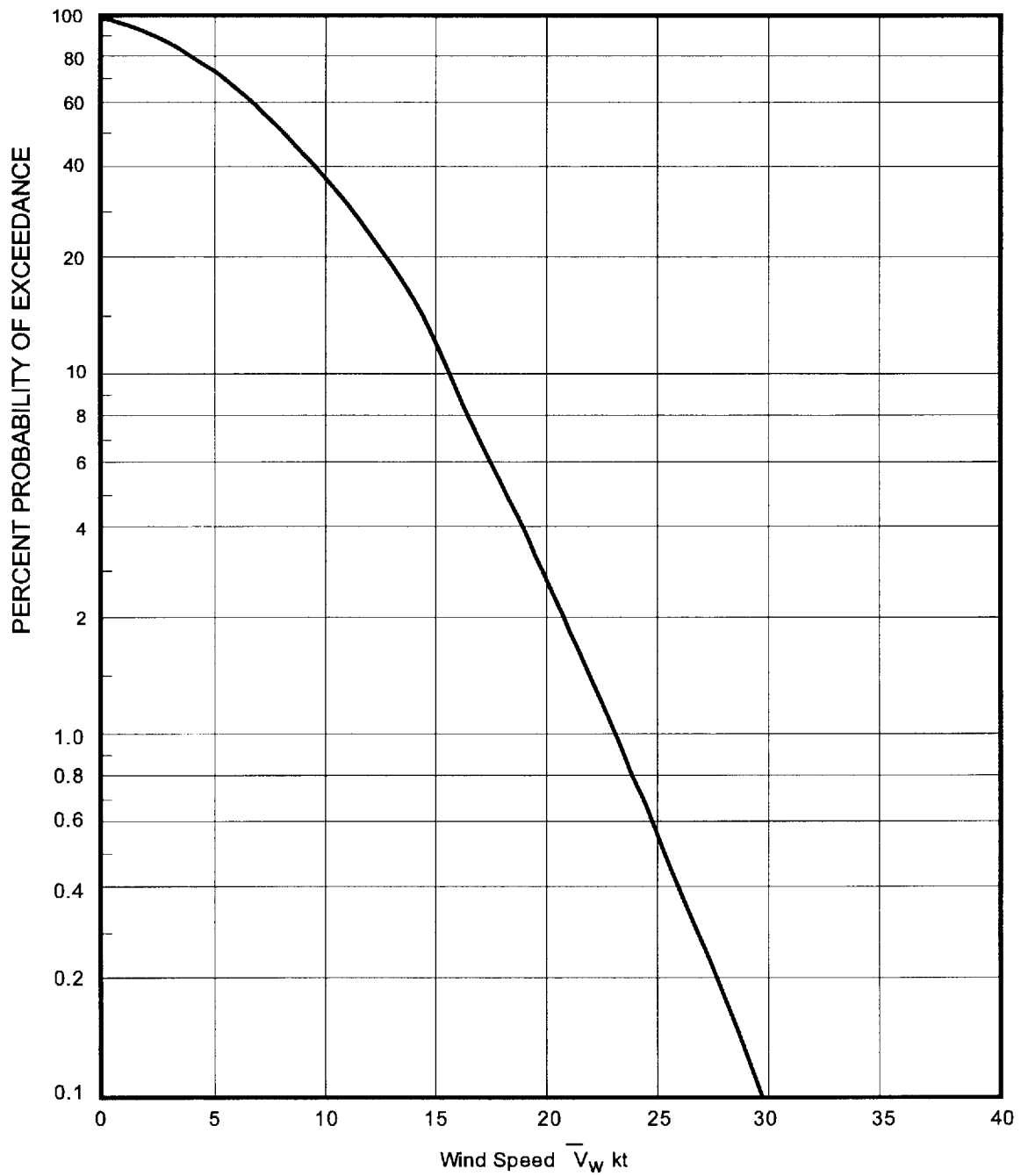
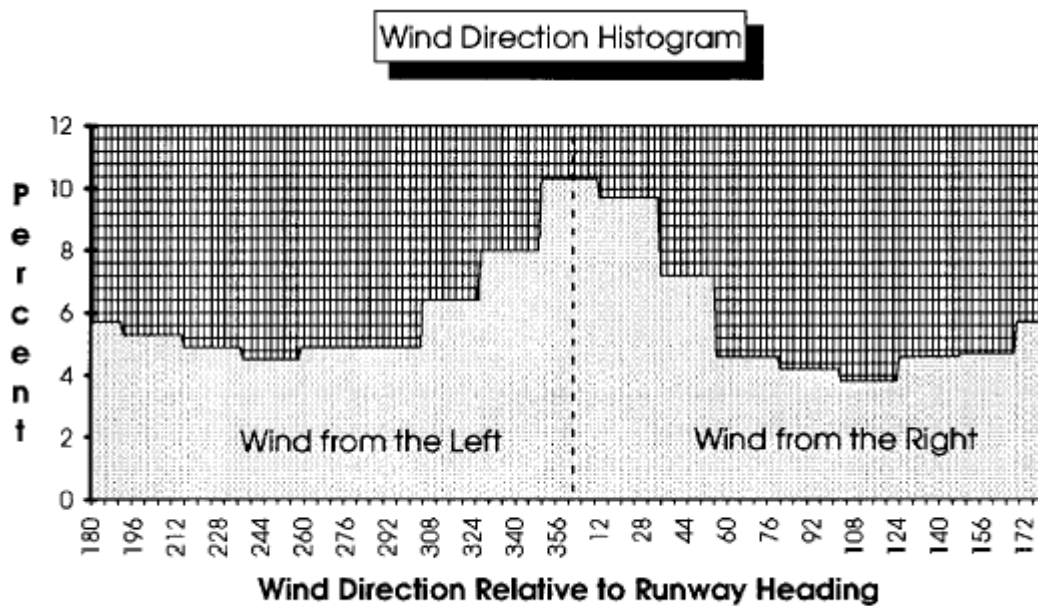

**FIGURE 2 Headwind – Tailwind Description**

**FIGURE 3 Crosswind Description**

**FIGURE 4 Annual percent probability of Mean Wind Speed equalling or exceeding given values**





**FIGURE 5 Wind direction relative to Runway Heading**

4 Models of ~~xLS ILS~~ and ~~MLS~~ signals in space for use in approach simulations

4.1 ~~ILS Model~~

4.1.1 ~~General~~

4.1.1.1 ~~Automatic landing system evaluation, including computer analysis of system performance, should be based on the use of ~~xLS ILS~~ ground facilities, which meet the performance characteristics, listed herein.~~

4.1.1.2 ~~The values given are derived from the performance characteristics for Category II ILS, contained in ICAO Annex 10, Volume 1, Third Edition dated July 1972 at Amendment No. 58 except where indicated.~~

4.21.1.3 ~~Analysis of results of in-flight demonstrations may include subtraction of measured ~~xLS ILS~~ beam distortions, and treatment of the contribution of the ~~xLS ILS~~ beam on a probability basis using the information that follows (See [CS AWO.A.ALS.106](#) (b)(2))~~

4.1.2 ~~Glide Path~~

4.1.2.1 ~~Glide Path Angles. It should be assumed that the operationally preferred glide path angle is 3°. The automatic landing system should be shown to meet all applicable requirements with promulgated glide path angles from 2.5° to 3°. Where certification is requested for the use of a larger beam angle, performance on such a beam should be assessed.~~

4.1.2.2 ~~Height of ILS Reference Datum (height of glide path at threshold). For establishing compliance with the longitudinal touchdown performance limits it may be assumed that the height of the ILS Reference Datum is 15 m (50 ft).~~

4.1.2.3 ~~Glide Path Alignment Accuracy. It should be assumed that the standard deviation of beam angle about the nominal angle ( $\sigma$ ) is 0.025  $\sigma$ .~~

4.1.2.4 ~~Displacement Sensitivity. It should be assumed that the angular displacement from the nominal glide path for 0.0875 DDM has the value of 0.12  $\sigma$ .~~

~~4.1.2.5 *Glide Path Structure.* For the purposes of simulation, the noise spectrum of ILS glide path may be represented by a white noise passed through a low pass first order filter of time constant 0.5 sec. For the whole of the approach path the output of the filter should be set to a two-sigma level of 0.023-DDM.~~

~~(Background: An interpretation of Annex 10, paragraph 3.1.5.4.2.)~~

~~NOTE: This model is primarily intended to simulate the characteristics of beams at low altitude, and therefore results derived from its use should not be relied on for heights above 150 m (500 ft).~~

#### ~~4.1.3 *Localizer*~~

~~4.1.3.1 *Course Alignment Accuracy.* It should be assumed that at the threshold the standard deviation of the course line about the centreline is 1.5 m (5 ft).~~

~~NOTE: This value is in between those given in Annex 10, paragraph 3.1.3 for Category II and Category III ILS which are assumed to be three-sigma values, 2.5 m (8.3 ft) and 1.0 m (3.3 ft) respectively.~~

~~4.1.3.2 *Displacement Sensitivity.* It should be assumed that the nominal displacement sensitivity at the threshold has the value of 0.00145-DDM/m.~~

~~4.1.3.3 *Course Structure.* For the purposes of simulation, the noise spectrum of ILS localizers may be represented by a white noise passed through a low pass first order filter of time constant 0.5 sec. For the whole of the approach path the output of the filter should be set to a two-sigma level of 0.005-DDM. (See Note to paragraph 4.2.5.)~~

~~(Background: An interpretation of Annex 10, paragraph 3.1.3.4.2.)~~

## 4.2 — ~~MLS Ground Facility Model.~~

~~The MLS models defined by the ICAO All Weather Operations Panel (AWOP), reference AWOP/14-WP/659, dated 4/2/93 should be used for approach simulations. Alternatively, if certification of MLS is only sought for ILS look-alike operations, the applicant may use the ILS model defined in section 4.1. This is based on the assertion that the MLS quality is equal to or better than that of ILS and requires no further substantiation.~~

## 5 Aerodrome conditions

### 5.1 Elevation and temperature

The effects of aerodrome elevation and ambient temperature should be examined where operation is envisaged at aerodromes **above** ~~about~~ 750 m (2 500 ft) or in temperatures greater than **international standard atmosphere (ISA) + 15°C.**

#### 5.1.1 High-altitude landing system demonstration using simulation

5.1.1.1 The following describes an acceptable means to demonstrate performance of landing systems **at high altitude with a combination of flight test results and validated simulation.** The **aerodrome elevation at which satisfactory performance of the landing system has been demonstrated by this method may then be documented in the AFM.** The **flight test demonstration is considered as the primary source of data, which can then be supplemented with data from a validated simulation.**

5.1.1.2 The minimum required altitude or elevation for the flight test which is used to demonstrate a desired AFM elevation value, by this method, is shown in Figure 6 and the accompanying table, below. For example, the applicant may document an AFM elevation value of 8 000 ft, by a successful flight demonstration at 8 000 ft, or by a flight demonstration at a minimum elevation of 5 000 ft with a simulation to the desired 8 000 ft. (Note: The lines in Figure 6 converge at 11 000 ft, indicating that credit for simulation is not available at 11 000 ft or above.)

The atmospheric temperature and pressure during the flight test, for either method, should not be more favourable than the international standard atmosphere (ISA) conditions, to ensure that the density altitude is not less than the aerodrome elevation. When the density altitude value of the flight test is less than the aerodrome elevation, then the density altitude value should be used as the effective flight test demonstrated elevation which will decrease the maximum AFM elevation value.

5.1.1.3 Establishing a baseline of landing system performance, for the purposes of then using simulation to obtain a high-altitude approval, will require a sufficient programme of landings at the flight test demonstrated elevation shown in Figure 2, to demonstrate the validity of the simulation and to support the conclusions of the analysis.

Note: Typically, programmes of 10-15 landings should be used.

An alternative method for simulation validation may be used if found acceptable by the Agency.

5.1.1.4 A simulation may then be conducted with cases at the selected AFM elevation value with the range of atmospheric conditions listed below. A sensitivity analysis should be conducted to assure that performance is not unsafe near any limits. Unless otherwise found acceptable by the Agency, simulation cases should typically include the following:

- a. temperatures ranging from ISA value to ISA +40°C;
- b. barometric pressure ranging from ISA value for that elevation to ISA -50 hPa; and
- c. mean wind variations, including:
  - headwinds to at least 25 kt;
  - crosswinds to at least 15 kt; and
  - tailwinds to at least 10 kt.

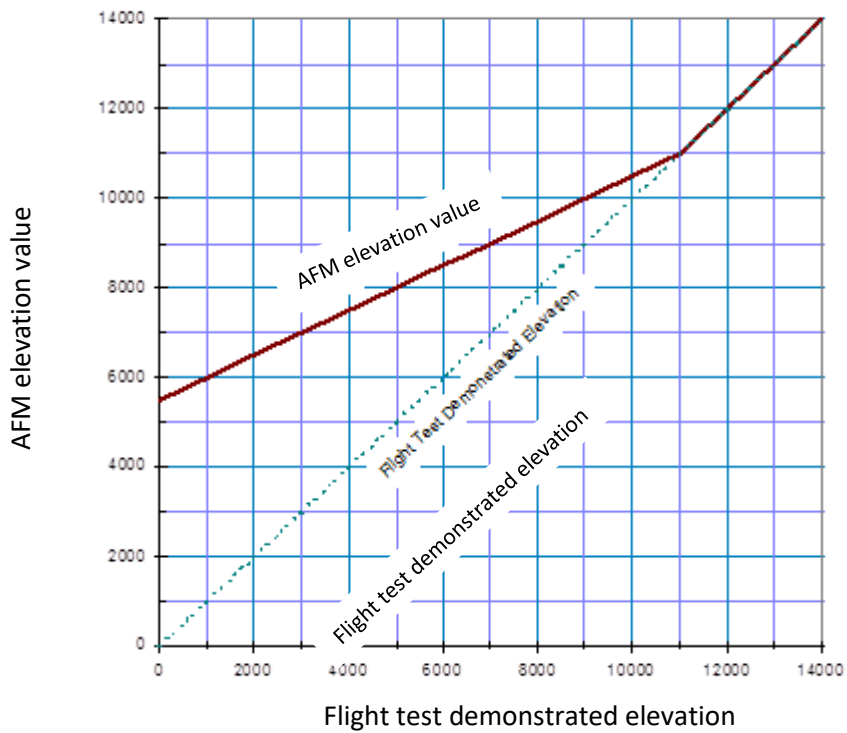

Figure 2: AFM elevation value from flight test and validated simulation

AFM elevation value from flight	Required elevation of flight
Test and validated simulation	Test demonstration
(feet above mean sea level)	(feet above mean sea level)
5 500	0
6 000	1 000
6 500	2 000
7 000	3 000
8 000	5 000
9 000	7 000
10 000	9 000
11 000	11 000

Table associated with Figure 2

### 5.1.2 High-altitude landing system demonstration using flight test only

For applicants that want to demonstrate landing system performance at high-elevation runways on the basis of flight tests only, i.e. without use of simulation to extrapolate from the demonstrated elevation, a flight test programme should be presented to the Agency for approval.

An acceptable programme should include approximately 10-15 approaches and landings, conducted with an instrumented aircraft, in conditions covering the range of operational weight, centre of gravity and aircraft configuration. One-engine-inoperative conditions should also be considered if relevant. The recorded data should allow the assessment of touchdown performance (i.e. touchdown distance, lateral deviation and vertical speed).

### 5.2 Ground profile

5.2.1 Where use is made of radio altimeter signals in the automatic landing system, any effects of ground profile before the runway or along the runway on the performance of the system should be examined.

5.2.2 The family of profiles to be investigated should take due account of the way in which the system uses the radio altimeter signals at different heights on the approach. Terrain and runway up slopes, down slopes and other terrain irregularities should be investigated.

NOTE: The information on characteristics of aerodromes is contained in ICAO Annex 14. Examination of a number of airports used for automatic landing has shown that the following features may be encountered:

- a. sloping runway — slopes of 0.8 %;
- b. hilltop runway — 12.5 % slope up to a point 60 m prior to the threshold; or
- c. sea-wall — 6 m (20 ft) step up to threshold elevation at a point 60 m prior to the threshold.

## 6 Fog model

For simulator testing associated with the certification of HUDLS certifications, the applicant may propose a fog model. The proposed fog model will have to be acceptable to the Agency.

### AMC AWO.A.ALS.108 Approach and automatic landing with an inoperative engine — Performance demonstration

- (a) Identification of a critical engine should consider the effects on performance, handling, loss of systems, and autoland status. More than one engine may be critical for different reasons.
- (b) If the aeroplane configuration and operation are the same as those used in the performance demonstration of [CS AWO.A.ALS.106](#) for the all-engine operating case, compliance with [CS AWO.A.ALS.108](#) may be demonstrated by, typically, 10 to 15 landings, or by statistical analysis supported by flight test if the aeroplane configuration or operation is changed significantly from the all-engine operating case.
- (c) If the aeroplane configuration and operation are not the same as for the all-engine operating case, the effect on landing distance will need to be considered.

- (d) To aid planning for automatic landing with an inoperative engine, appropriate procedures, performance, and obstacle clearance information will need to be established enabling a safe go-around at any point in the approach.
- (e) For the purposes of this requirement, demonstration of automatic landing and go-around performance in the event of a second engine failure need not be considered.

#### **AMC AWO.A.ALS.109 Automatic landing distance**

The landing distance referred to in [CS AWO.A.ALS.109](#) may be derived as follows:

- (a) The configuration procedure and speed should be those recommended for an automatic landing.
- (b) The distance from the runway threshold to the touchdown point should be the distance from the runway threshold to the glide-slope origin ( $S_0$ ) plus the mean distance from the glide-slope origin to touchdown ( $S_{TD}$ ) plus three times the standard deviation of the distance from the glide-slope origin to touchdown  $\sigma(S_{TD})$ .
- (c) The gross distance from touchdown to a complete stop should be determined in accordance with CS 25.125, assuming a touchdown speed equal to the main touchdown speed plus three standard deviations of the touchdown speed.

Note: The main values and standard deviations considered in points (b) and (c) should be based on random variations. Systematic variation of parameters should cover the normal range of flight manual conditions.

- (d) The landing distance required should be taken as the distance from the runway threshold to the touchdown point, as defined in (b) above, factored by 1.15 (i.e.  $1.15(S_0 + S_{TD} + 3\sigma(S_{TD}))$ ), plus the ground roll distance defined in (c) above multiplied by a factor of 1.15.
- (e) The landing distance required should include corrections for variations in glide-slope angle and variations in glide-slope height at the threshold. Alternatively, these effects may be included by use of conservative assumptions in the basic presentation of data, with the applicable ranges stated in the flight manual.

Note: The landing distance as derived under (a) to (e) above should be compared with the normal landing distance according to CS 25.125.

#### **AMC AWO.A.ALS.110 Controls, indicators and ~~Warnings~~ alerts — General**

Where certification of installations involving more than one type of precision approach system (e.g. ~~MLS and ILS~~ and ~~MLS and/or GLS~~) is requested, the following considerations should be taken into account:

- (a) Where practicable, the flight deck procedure for the ~~xLS ILS and MLS~~ precision approach should be the same.
- (b) The loss of deviation data should be indicated on the deviation display. The failure indication on the deviation display for each axis of the ~~xLS ILS and MLS~~ may be common.
- (c) The specific ~~ILS or MLS~~ precision approach system selected as the navigation source for the approach and automatic landing should be indicated positively in the primary field of view (FOV) at each pilot station.
- (d) The ILS frequency or ~~MLS/GLS~~ channel data for the selected approach should be displayed to each pilot.

- (e) Means should be provided to enable the flight crew to confirm that the intended type of approach system has been correctly selected.
- (f) A common set of mode indications for the armed and active conditions is recommended.
- (g) The capability of each element of a multi-mode landing system should be available to the flight crew to support dispatch of the aeroplane.
- (h) A failure of each element of a multi-mode landing system should be indicated to the flight crew as either an advisory or a caution during en route operation.
- (i) A failure of the selected element of a multi-mode landing system during an approach should be accompanied by a warning or caution, as appropriate. These alerts may be inhibited at the alert height, if appropriate to the operation.
- (j) If an indication of a failure in each non-selected element of a multi-mode landing system during an approach and landing is provided, it should be available to the flight crew as an advisory and should not produce a caution or warning. These advisories may be inhibited at the alert height, if appropriate to the operation.
- (k) Failure indications should not mislead the flight crew through a possible incorrect association with the navigation source. For example, it would be unacceptable for 'ILS FAIL' to be displayed when the selected navigation source is MLS and the failure affects the MLS receiver.

#### **AMC AWO 161(b) Failure Conditions**

##### ~~1 — Analysis of Failure Conditions and their Effects~~

~~1.1 — Analysis. An analysis should be carried out to define the failure conditions and their effects and to show that the probability of each failure condition is such that the requirements of CS-AWO 161 (a) are achieved.~~

##### ~~1.2 — Failure conditions and their effects~~

~~1.2.1 — The effect of a failure condition on the aeroplane and occupants should be established, taking into account the stage of flight. There should be a flight demonstration (see paragraph 2) taking account of the warning cues and the information available to the pilot making the corrective action.~~

~~1.2.2 — Where the effect of a failure condition is neither readily apparent nor deducible by analysis, either the most adverse consequence should be assumed, or such testing should be carried out as may be required to establish the effect.~~

~~1.2.3 — All failures and combinations of failures leading to the same or a similar effect on the functioning of the system should be regarded as the same failure conditions.~~

~~1.3 — Probability of failure conditions. The probability of a failure condition should be based on engineering judgement of evidence relevant to the components used, and account should be taken of previous experience on similar systems. The analysis should take account of the following:~~

~~a. — A single failure of a system or component may only be accepted when the system or component is assessed to have the necessary order of reliability based on:~~

~~i. — Service experience which can be shown to be applicable, normally supported by analysis and/or testing of the particular design; or~~

- ~~ii. A detailed engineering evaluation of the design supported by testing.~~
- ~~b. A single failure may only be assessed to be an Extremely Improbable failure when it applies to a particular mode of failure and it can be shown from the aspects of design, construction and installation, that such a failure need not be considered as a practical possibility.~~
- ~~c. In systems, which rely for their airworthiness on redundancy techniques, particular attention should be given in the analysis to common mode failures (i.e. multiple failures arising from a single cause). The following are typical examples of common mode failures:~~
  - ~~i. A local fire causing multiple failures;~~
  - ~~ii. Electro-magnetic interference or electrical transients causing multiple malfunctions;~~
  - ~~iii. Mechanical vibration causing multiple failures or malfunctions;~~
  - ~~iv. Leakage of water or other liquids (e.g. from a galley or from cargo) causing multiple electrical failures;~~
  - ~~v. The failure of a cooling system or the leakage of hot air causing multiple failures in other systems;~~
  - ~~vi. Lightning strike; and~~
  - ~~vii. Software errors in digital systems.~~

#### ~~1.4 Numerical probabilities~~

~~1.4.1 Where numerical analyses are used in assessing compliance with CS-AWO 161 (a) the probability values given in AMC 25.1309 should be used in providing a common point of reference. The analysis should take into account the period in the landing for which the particular failure condition is critical.~~

~~1.4.2 Combinations of failures may be accepted on the basis of assessed numerical values only where these values can be substantiated and a suitable analysis technique has been employed.~~

~~1.4.3 Statistical methods should be used to complement engineering judgement and should not be regarded as a substitute.~~

~~1.5 Dormant failures (latent). When the failure of a device can remain undetected in normal operation, the frequency with which the device is checked will directly influence the probability that such a failure is present on any particular occasion. This should be taken into account when assessing the probabilities of any failure conditions which include the dormant failures of monitoring devices or unchecked redundant items.~~

~~1.6 Cascade failures. When failure of a component or equipment can be expected to result in other failures, account should be taken in the analysis of these further failures. In assessing which failures may follow, consideration should be given to any change in the equipment operating conditions for other components or equipment consequential on the first failure.~~

~~1.7 Damage from external sources. In considering damage from external sources, account should be taken of the location of the equipment in the aeroplane and other features of the installation.~~

## ~~2 Flight Demonstrations~~

~~2.1 Simulation tests, and the assessed probability of the failure condition should be taken into account in determining which failure conditions should be demonstrated in flight.~~



~~2.2 — Where system tolerances significantly affect the consequences of failure, the system should be adjusted for flight testing to the most adverse tolerances, which can be maintained in service.~~

~~2.3 — The effects of failures of the ILS and/or MLS ground facilities should, if necessary, be demonstrated in flight.~~

### ~~3 — Consideration of the Effects of Engine Failure~~

~~3.1 — Where the landing system provides automatic control of the rudder pedals, a demonstration should be made to show that, for automatic approaches initiated with all engines operating:~~

~~a. — automatic go-around, and~~

~~b. — automatic landing,~~

~~can be performed safely after the failure of any single engine at any point during the approach down to touchdown without the pilot needing to intervene and assume control.~~

~~3.2 — The automatic pilot should remain engaged following the failure of any single engine, taking account of the loss of systems associated with the failed engine (e.g. electrical and hydraulic systems).~~

#### **AMC AWO.A.ALS.112 xLS navigation means (including signal-in-space) failure**

The effects of failures of the xLS navigation means (including signal in space) should, if necessary, be demonstrated in flight.

Description of the fault modes of the elected navigation means derived from ICAO Annex 10 Volume I can be found in [Appendix 1 to AMC to Subpart A](#).

#### **AMC AWO.A.ALS.113(f) Aeroplane flight manual**

The aeroplane flight manual AFM should define the categories of xLS ILS and/or MLS ground facilities or space facilities (if applicable), which have been used as the basis for certification. The aeroplane flight manual AFM should also contain a statement on possible usage of automatic landing on lower than some Category of xLS ILS and/or MLS ground facilities or space facilities (if applicable). suitable for automatic landing

**AMC TO SECTION 2****HEADS UP DISPLAYS (HUD)****GENERAL****AMC AWO.A.HUD.101 Applicability and terminology**

A HUD or an equivalent display should comply with the relevant requirements of AMC 25-11.

**AMC AWO.A.HUD.103 Head-up display information**

It is acceptable to remove information from the HUD, provided that doing so does not cause a distraction.

**AMC AWO.A.HUD.105(a)(i) Failure alerting**

The requirements of CS 25.1322 with respect to colour coding for warnings (red) or cautions (amber) may be impossible to meet whilst only a monochrome display is provided on a HUD. Since a pilot using a HUD will have their attention fixed in a well-defined display area, it is accepted that an alternative means of alerting, other than change of colour, may be provided (e.g. flashing or boxing of parameter, additional aural, blanking of display area or removal of feature, etc.). A consistent alerting philosophy should be developed which provides distinction between caution, warning and advisory information. Conflicts of meaning with head-down display alerts should be avoided.

**AMC AWO.A.HUD.105(a)(ii) Indications and alerts**

The removal of the total display may be an acceptable way of indicating a failure of the system.

**AMC AWO.A.HUD.105(a)(iii) Monitoring pilot indications**

As is indicated in CS 25.1329, it is essential that both pilots are aware of the mode of flight guidance being used at all times. Unless the format of the display on the HUD is unique to a particular guidance mode, the pilot using the HUD (whether in automatic or manual flight) will need to have their attention brought to any changes of mode (normal or uncommanded) as soon as they occur.

**AMC AWO.A.HUD.107 Performance demonstration**

Where approval is sought for the use of a HUDLS, in order to show compliance with [CS AWO.B.CATIII.115](#), it will be necessary to use a simulator with an acceptable visual system which accurately represents the real aeroplane, in particular the handling qualities, the ground effect, the fog structure and the cut-off angle. A moving-base simulator is thought to be necessary and consideration of the effect of the structural response of the airframe to turbulence may be necessary to achieve a realistic simulation of the effect of turbulence on the flight deck.

Where a head-up guidance landing system is used for primary guidance for Category 3 operations, it may be expected that at least 500 simulated landings will be necessary and that 100 or more landings by the real aeroplane will be made. At least 10 pilots of varying background and experience should be used both in simulator and flight tests. They should be given appropriate training in the use of the HUDLS. No pilot should make more than 8 consecutive landings without a break of at least 1 hour.

Monte Carlo techniques should be considered where applicable.

The limit risk demonstration, whilst suitable for autoland certification, has been found to be unsuitable for head-up guidance certification. An acceptable alternative, assuming that wind is the most critical parameter, is to perform 10 simulated approaches and landings in limiting winds from each of the 8 cardinal points of the compass (total 80 runs) and demonstrate that the failure rate does not exceed 20 %.

**AMC AWO.A.HUD.112 Head-up display landing distance**

- (a) The flare guidance provided by the HUD during landing and any procedure associated with using the HUD may result in an increase to the landing distance.
- (b) The HUD landing distance should be established as follows:
  - (1) The requirements of CS 25.125 should be applied, except that the configuration, procedure and speed should be those recommended in the associated procedures for using a HUD.
  - (2) The landing distance as derived under (a) above should be compared with the normal landing distance as per CS 25.125. If the HUD landing distance is longer than without using a HUD, then the HUD landing distance should be established and articulated in the AFM. This landing distance may not be shorter than the landing distance established in accordance with CS 25.125 without using a HUD.
  - (3) The operating procedures, aeroplane configuration, approach speed, thrust management, piloting control techniques and the landing distance data applicable for HUD landings should be established and articulated in the AFM.

**AMC TO SECTION 3****ENHANCED FLIGHT VISION SYSTEMS (EFVS)****AMC AWO.A.EFVS.101 General**

The intended functions of the EFVS should be defined. This definition should include what features will be displayed and the criticality of pilot decision-making using the display features. The additional intended functions (for example, terrain alerting) should be defined according to AMC 25-11 and CS 23.1301 and 25.1301.

This should include its use to visually acquire the visual references required to operate below the DA/H or MDA and the criticality of pilot decision-making based on what is visible using the EFVS display. The purpose of the EFVS is to provide a visual advantage over the pilot's out-the-window view using natural vision. In low-visibility conditions, the 'enhanced flight visibility' should exceed the 'flight visibility' and the required visual references should become visible to the pilot at a longer distance with an EFVS than they would out-the-window using natural vision. Visual advantage using an EFVS should be demonstrated before descending below the DA/H or the MDA because this is the point in an instrument approach procedure where the operating rules permit an EFVS to be used in lieu of natural vision for operational benefit.

Note 1: The EFVS is not intended to replace the technologies or procedures already used to safely fly the aircraft down to the MDA/H or DA/H.

Note 2: While the goal of EFVS is to exceed the natural flight visibility in the majority of cases/weather conditions, there may be meteorological conditions where the EFVS does not provide a significant advantage.

Note 3: The HUD (or equivalent display) is separately certified and should remain subject to all applicable rules and guidance for the category of aircraft and operation.

**AMC AWO.A.EFVS.103 EFVS depiction**

The EFVS image is in the centre of the pilot's regulated 'pilot compartment view'. It should be free of interference, distortion, and glare that would adversely affect the pilot's normal performance and workload. A video image can be more difficult for the pilot to see through than symbols also displayed on the HUD. Unlike symbology, the video image illuminates, to some degree, most of the total display area of the HUD with much greater potential interference with the pilot compartment view. It is sufficient for the pilot to see around the video image, but the outside scene must be visible through and around it.

Unlike the pilot's external view, the enhanced flight vision image is a monochrome, two-dimensional display. Some, but not all, of the depth cues found in the natural view are also found in the imagery. The quality of the enhanced flight vision image and the level of enhanced flight vision sensor performance could depend significantly on the atmospheric and external light source conditions. Gain settings of the sensor, and brightness or contrast settings of the HUD (or equivalent display), can significantly affect image quality. Certain system characteristics could create distracting and confusing display artefacts. Finally, this is a sensor-based system that is intended to provide a conformed perspective.

The sensor image, combined with the required aeroplane state and position reference symbology, are presented to the flight crew on a HUD (or an equivalent display), so that they are clearly visible to the pilot flying in their normal position and line of vision looking forward along the flight path.

The integration of the major components should include the installed sensor, its interconnections with the sensor display processor, the display device, pilot interface, and aircraft mechanical interface, which can include the radome for the sensor.

#### Flare cue

An EFVS-L should have a flare cue because it is intended to enable landing in low visibility. The flare cue, whether a flare prompt or flare guidance, should demonstrate compliance with the landing criteria found in [CS AWO.A.EFVS.109](#). For some aircraft, flare guidance may be required because a flare prompt is not sufficient.

#### **AMC AWO.A.EFVS.104 EFVS display**

The EFVS imagery should not degrade the presentation of essential flight information on the HUD. The pilot's ability to see and use the required primary flight display information such as primary attitude, airspeed, altitude, and command bars should not be hindered or compromised by the EFVS image on the HUD.

The EFVS imagery displayed on the HUD or equivalent display must account for the pilot compartment view requirements found in CS 25.773 or CS 23.773, including validation that the display of imagery does not conflict with the pilot compartment view. The display of EFVS sensor imagery should be on a system that compensates for the interference caused by the provided imagery. Additionally, the system should provide an undistorted and conformal view of the external scene, a means to deactivate the display and should not restrict the pilot from performing specific manoeuvres. The following tasks associated with the use of the pilot's view should not be degraded below the level of safety that existed without the video imagery:

- (a) Detection, accurate identification and manoeuvring, as necessary, to avoid traffic, terrain, obstacles, and other hazards of flight.
- (b) Accurate identification and utilisation of visual references required for every task relevant to the phase of flight.

Note: Although, the EFVS image requirements relate primarily to the approach and landing phases of flight, the EFVS image when viewed head up during ground operations should not create unacceptable distractions due to sensor proximity to the taxiway surface.

For EFVSs that are implemented on a HUD, the image should be compatible with the FOV and head motion box of a HUD designed against SAE ARP 5288 (transport category HUD systems). When used in a given phase of flight, the HUD and EFVS FOR must provide a conformal image with the visual scene over the range of aircraft attitudes and wind conditions.

EFVS display criteria must meet the airworthiness certification provisions in CS-23 or CS-25 (as applicable) (see [Appendix 1 to AMC to Section 3 of Subpart A](#)). Some of these provisions could be specific to EFVS and could be in addition to all other requirements applicable to the HUD and the basic avionics installation. The amount of new test data can be determined by the individual application, availability, and relevance of data.

The current certification specifications for HUDs apply with respect to EFVS. These criteria include well-established military as well as civil aviation standards for HUDs as defined in MIL-STD-1787C, Aircraft Display Symbology, and AMC 25-11. SAE design standards for HUD symbology, optical elements, and video imagery are also prescribed within SAE AS 8055, SAE ARP 5288 and SAE ARP 5287. The specific design standards for image size, resolution and line width, luminance and contrast ratio, chromaticity, and grayscale should be applied.

A HUD modified to display EFVS imagery should continue to meet the conditions of the original approval and be adequate for the intended function in all phases of flight in which the EFVS is used. An accurate, easy, quick-glance interpretation of attitude should be possible for all unusual attitude situations and other 'non-normal' manoeuvres to permit the pilot to recognise the unusual attitude and initiate recovery within 1 second. The use of chevrons, pointers, and/or permanent ground-sky horizon on all attitude indications to perform effective manual recovery from unusual attitudes is recommended. Refer to AMC 25-11 for guidance on electronic flight deck displays.

EFVS latency should be no greater than 100 milliseconds (msec). Latency should not be discernible to the pilot and should not affect control performance or increase pilot workload. EFVS latency causes, at best, undesirable oscillatory image motion in response to pilot control inputs or turbulence. At worst, EFVS latency may cause pilot-induced oscillations if the pilot attempts to use the EFVS for active control during precision tracking tasks or manoeuvres in the absence of other visual cues.

#### EFVS FOR

The minimum fixed FOR should be 20 degrees horizontal and 15 degrees vertical. In applications where the FOR is centred on the FPV, the minimum vertical FOR should be 5 degrees ( $\pm 2.5$  degrees) and 20 degrees horizontal.

- (a) The minimum EFVS FOR should not only consider the HUD FOV (i.e. the size of the area that is displayed), but also the area over which this area subtends (i.e. what is shown on the conformal display). The FOR portrayed on the HUD is established by three primary aspects:
- (1) HUD and EFVS sensor FOV;
  - (2) orientation of the HUD with respect to the aircraft frame of reference (for example, boresight and proximity to pilot's eye); and
  - (3) orientation (for example, attitude) of the aircraft.
- (b) SAE ARP 5288 states 'The design of the HUD installation should provide adequate display fields-of-view in order for the HUD to function correctly in all anticipated flight attitudes, aircraft configurations, or environmental conditions such as crosswinds for which it is approved. Limitations should be clearly specified in the AFM if the HUD cannot be used throughout the full aircraft flight envelope.' A quantitative EFVS FOR should be established as a minimum design criterion to be qualitatively checked during the certification flight test for sufficiency in meeting its intended function. The EFVS FOR should result from consideration of the minimum FOR criteria for various aircraft attitudes and wind conditions using a critical altitude of 200 ft height above TDZE for EFVS visibility.
- (c) A variable FOR is permissible assuming a slewable sensor (i.e. variable FOR), centred on the FPV, with a minimum  $\pm 2.5$  degrees about the FPV to allow for momentary flight path perturbations and to allow sufficient fore/aft view of the required visual references.

#### Off-axis rejection

A source in object space that is greater than 1 degree outside the FOV should not result in any perceptible point or edge-like image within the FOV. The EFVS should preclude off-axis information from folding into the primary FOR imagery, creating the potential for misleading or distracting imagery.

#### Jitter

When viewed from the HUD eye reference point, the displayed EFVS image jitter amplitude should be less than 0.6 mrad. Jitter for this use is defined in SAE ARP 5288. This implies that the EFVS and HUD cannot exhibit jitter greater than that of the HUD itself.

### Flicker

Flicker is brightness variations at frequency above 0.25 Hz per SAE ARP 5288. The minimum standard for flicker should meet the criteria of SAE ARP 5288. Flicker can cause mild fatigue and reduced crew efficiency. Therefore the EFVS and HUD should not exhibit flicker greater than that of the HUD itself.

### Image artefacts

The EFVS should not exhibit any objectionable noise, local disturbances, or an artefact that hazardously detracts from the use of the system. The EFVS design should minimise display characteristics or artefacts (for example, internal system noise, 'burlap' overlay, or running water droplets) which obscure the desired image of the scene, impair the pilot's ability to detect and identify visual references, mask flight hazards, distract the pilot, or otherwise degrade task performance or safety.

### Image conformality

The accuracy of the integrated EFVS and HUD image should not result in a greater than 5 mrad display error at the centre of the display at a range of 2 000 ft (100 ft altitude on a 3-degree glideslope). In accordance with SAE ARP 5288, the total HUD system display accuracy error as measured from the HUD eye reference point, should be less than 5.0 mrad at the HUD boresight, with increasing error allowable toward the outer edges of the HUD. Errors away from the boresight should be as defined in SAE ARP 5288. The primary EFVS error components include the installation misalignment of the EFVS sensor from aircraft/HUD boresight and sensor parallax. A range parameter is used in the EFVS conformability requirement to account for the error component associated with parallax. There is no error allowed for the EFVS sensor, since it is assumed that any error can be electronically compensated during installation. With EFVS operations, the aircraft is flown essentially irrespective of the EFVS/HUD dynamic error, to the MDA or DA. From this point to 100 ft height above TDZE, the EFVS conformality error introduces error in the pilot's ability to track along the extended centre line/vertical glide path as the pilot flies the FPV and glide path reference line toward the EFVS image of the runway.

### Dynamic range

The minimum required dynamic range for passive EFVS should be 48 dB. For active EFVS, side lobes should be 23 dB below the main beam, and 40 dB dynamic range plus sensitivity time control.

### Sensor image calibration

Visible image calibrations and other built-in tests that cannot be achieved within a total latency of 100 msec should occur only either on pilot command or be coordinated by aircraft data to only occur in non-critical phases of flight. If other than normal imagery is displayed during the non-uniformity correction (NUC) or other built-in tests, the image should be removed from the pilot's display. This prohibits excessive times to complete maintenance or calibration functions which would remove or degrade the EFVS imagery during critical phases of flight, unless the pilot commands the action (with full knowledge of effect based on training and experience). Abnormal imagery should be removed from the display to eliminate the potential for any misleading information.

### Passive sensor optical distortion

Optical distortion should be 5 % or less across the minimal FOR and no greater than 8% outside the minimal FOR.

### Sensor sensitivity



In this context, the EFVS sensor sensitivity should be at least a noise-equivalent temperature difference (NETD) of 50° mK tested at an appropriate ambient temperature for passive EFVSs or -20 dB sm/sm (square metre/square metre) surface at  $R_{max}$  from 200 ft height above TDZE with a typical 3-degree glideslope for active EFVSs. Passive sensors for different visible or short-wave infrared sources can require very sensitive detectors, as specified by low noise-equivalent powers.

#### Blooming

The sensor should incorporate features to minimise blooming, which can create an unusable or objectionable image. Objectionable blooming is defined as the condition that obscures the required visual cues. Blooming to the extent the required visual references are no longer distinctly visible and identifiable is unacceptable.

#### Image persistence

The image persistence time constant should be less than 100 msec. However, burn-in or longer image persistence caused by high-energy sources (for example, the sun saturating the infrared sensor elements) should be removed from the image. Image artefacts should be removed by a secondary on-demand process (for example, the non-uniformity correction process).

#### Dead pixels

Dead pixels or sensor elements replaced by a 'bad pixel' replacement algorithm should be limited to 1 % average of the total display area, with no cluster greater than 0.02 % within the minimum FOR. A small number of disparate dead pixel elements can be effectively replaced by image processing but eventually the algorithms will degrade the image quality and accuracy due to the sheer number and closely-spaced location of the element.

#### Parallax

The effects of parallax caused by lateral, vertical, and longitudinal offset of the sensor from the pilots' design eye points should not impede the EFVS from performing its intended function, as evaluated during flight test. Parallax should not cause unsatisfactory landing performance parameters (e.g. flare height, sink rate, touchdown location, groundspeed during landing, exit and taxi) between EFVS operations and visual operations in the same aircraft.

### **AMC AWO.A.EFVS.105 HUD EFVS symbology**

#### Flare prompt

A flare prompt is intended to notify the pilot that it is time to initiate the flare manoeuvre but does not guide the pilot's manual pitch control inputs. The pilot should use situational information (e.g. altitude, vertical rate, attitude, FPV, perspective view of the runway) from the EFVS to judge the magnitude and rate of manual pitch control inputs. The appearance and dynamic behaviour of the flare prompt should be distinguishable from command guidance. The flare prompt should appear timely and conspicuously to the pilot using the HUD so that the flare manoeuvre will be neither too early nor too late and within the TDZ as described in [AMC AWO.A.EFVS.109](#).

**AMC AWO.A.EFVS.106 EFVS display controls**

There should be a means to allow the pilot using the display to immediately deactivate and reactivate the vision system imagery, on demand, without requiring the pilot to remove their hands from the primary flight and power controls, or their equivalent. (Refer to CS 25.775(e)(3)).

The EFVS installation and image should have an effective control of EFVS display brightness without causing excessive pilot workload and not cause adverse physiological effects such as fatigue or eyestrain.

**AMC AWO.A.EFVS.107 EFVS safety assessment**

The safety assessment should show that the applicant's specific installation meets all the integrity criteria for the aircraft systems and for the EFVS. All aircraft configurations to be certified should be addressed.

The applicant may need to demonstrate by flight test or simulation combinations of EFVS malfunctions that are not shown to be extremely improbable ( $10^{-9}$  per FH).

The overall level of safety of the aircraft is based on installed equipment. A complete system safety assessment (SSA) should be conducted. The SSA should consider the potential for hazardously misleading information (HMI) being presented to the flight crew. Examples of HMI that should be considered include at least information providing attitude, altitude, and distance cues as outside terrain imagery, frozen and offset imagery.

**EFVS fail-safe features**

The normal operation of the EFVS may not adversely affect, or be adversely affected by other normally operating aircraft systems. Malfunctions of the EFVS which could cause display of misleading information should be annunciated and the misleading information removed. The criticality of the EFVS's function to display imagery, including the potential to display HMI, should be assessed according to CS 25.1309 and AMC 25-11. Likewise, the hazard effects of any malfunction of the EFVS that could adversely affect interfaced equipment or associated systems should be determined and assessed according to CS 25.1309 and AMC 25-11. Similar criteria can be found in CS 23.1309. This requirement should be met through an SSA and documented via fault tree analysis, failure mode and effects analysis (FMEA), and failure mode and effects analysis substantiation (FMEA substantiation), or equivalent safety documentation.

**AMC AWO.A.EFVS.108 EFVS level of safety**

During the development and design of an EFVS-A, the safety design goals for airworthiness approval should be established. The safety criteria for each phase of flight, including approach and landing systems, should be defined in terms of accuracy, continuity, availability, and integrity. Appropriate design guidance should be used to determine the overall required level of safety for the aircraft, in any mode of flight, and for any combination of failures which can cause an unsafe condition in order for them to be fully assessed and categorised. This should include the ability of the pilot(s) to cope with these failures. The hazard level for any aircraft system will depend on the ability of the pilot(s) to cope with failures. For failures where the SSA assumes a particular pilot intervention to limit the hazard effects, for example from catastrophic or hazardous to major or minor, it should be shown that the pilot can be relied on to perform that intervention. For example, the pilot might be assumed to detect a system error because of other displays or view out the window. It should be demonstrated that pilots can detect the error in a timely fashion and not be hazardously misled. The demonstration must validate the hazard classification contained in either CS 23.1309 or CS 25.1309 as appropriate.

The applicant should demonstrate a satisfactory safety (failure and performance) level which should not be less than the safety level required for precision and NPAs with decision altitudes (DAs) of 200 ft or above without the use of an EFVS-A. In showing compliance, probabilities cannot be factored by the fraction of approaches which are made using EFVS. Consideration, however, can be given to the EFVS-A critical flight time, such as from the highest DH that can be expected for an approach to 100 ft above the TDZE using an EFVS-A.

The selected DALs are directly linked to the specific intended use and to the specific EFVS-A installation as an integrated part of the cockpit flight information system.

There are expected to be failure modes within an EFVS-A which will determine that software and hardware DALs which should comply with RTCA/DO-178C (or latest version) or RTCA/DO-254 (or latest version).

In showing compliance with these safety criteria, the probabilities of failure conditions of an EFVS-L should not be factored by the fraction of approaches which require an EFVS-L. The probabilities of failure conditions of an EFVS-L should also not be factored by a statistical distribution of visibility conditions. The exposure time used for failure calculations of an EFVS-L should be the elapsed time from descent below the highest expected DA/H for the approach using an EFVS-L to completion of roll-out to a safe taxi speed.

Any malfunction, fault detection and annunciation schemes should satisfy the required levels of safety and should perform their intended functions.

#### **AMC AWO.A.EFVS.109 EFVS performance**

The performance of EFVS imaging systems does not solely depend upon system design, but also depends upon the target scene characteristics such as the runway, light structures, electromagnetic radiation, and atmospheric conditions.

Since the purpose of the EFVS sensor is to provide a visual advantage over the pilot's out-the-window view, the design should include a general performance analysis. This analysis should include the calculated performance, which indicates the viability of the system to meet the proposed intended function, specifically including the calculated performance of the sensor operation within the range of the environment proposed.

Likewise, since the purpose of the EFVS sensor is to provide a visual advantage over the pilot's out-the-window view, the general performance analysis should include the calculated transmission of electromagnetic energy in the visible spectrum and other relevant frequencies. The analysis should portray the length of transmission over a path with generalised extinction coefficients at a given wavelength.

Note: Examples of acceptable sensor models are MODTRAN and LOWTRAN which can be used to estimate the performance of infrared systems. Other models (FASCODE) for radar systems may be used for these types of sensors and provide a basic measure of signal attenuation helpful in assessing performance and viability for the required functions.

Both the installed system and the individual system components should be verified to ensure compliance with the provisions in Book 1 Subpart A Section 3.

Airframe and equipment manufacturer-based tests or analyses, as applicable, should be developed and conducted to validate the detailed system criteria. No specific test procedures are cited because alternative methods can be used. Alternate procedures can be utilised if it can be demonstrated that they provide the totality of the required information. System performance tests are the most important tests as they relate to operational capability. Subsystem tests are used as subsystems are added during system build-up to ensure appropriate subsystem performance as it relates to overall system performance.

An evaluation of the system used during anticipated operational scenarios should be conducted.

The minimum detection EFVS range (Figure 1 below) can be derived by using an assumed minimum distance of the aircraft at the nominal Category I (200 ft) DA before which the EFVS should image the runway threshold. On a 3-degree glideslope, the horizontal distance from the aircraft to the runway threshold is approximately 2 816 ft (3 816 ft from the precision TDZ markers) based upon the visual cues required by AMC7 SPA.LVO.105(c) point (e). This range should be used as a minimum performance value. These values do not take into account pilot decision time or actual atmospheric conditions, the use of NPAs which can require greater distances, or the use of approaches with higher DAs, DHs, or MDAs.

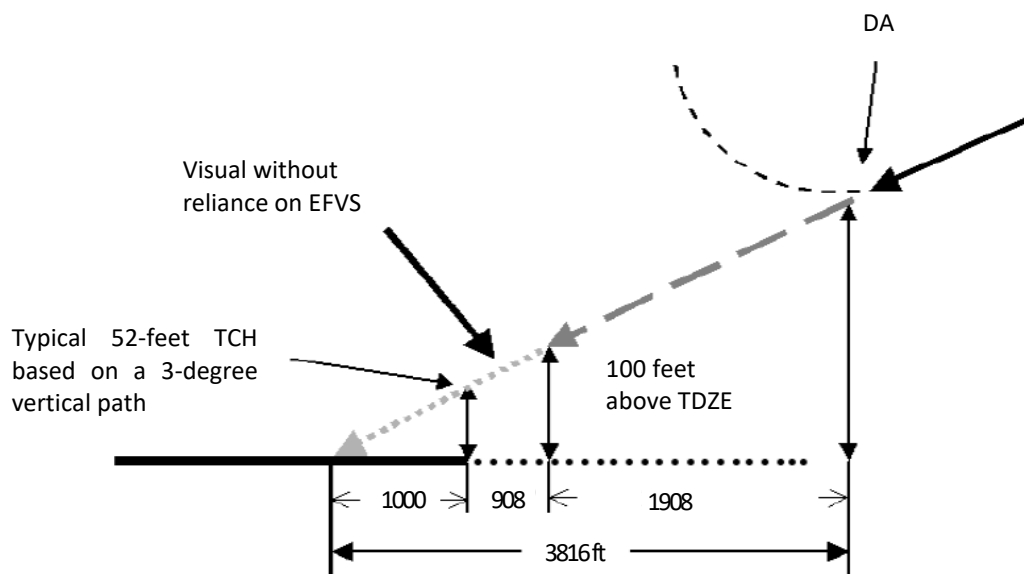

Figure 1: Minimum detection range

### Sensor resolution

As a minimum, EFVS resolution performance shall adequately resolve (for pilot identification) the runway threshold and the TDZ to enable the intended function. For example, an EFVS should resolve a 60 ft-wide runway from 200 ft height above TDZE with a typical 3-degree glideslope. The sensor resolution has been established by providing this resolution at a minimum range, allowing the pilot to continue the descent below DA or MDA. (These values do not take into account pilot decision time or actual atmospheric conditions, or the use of NPAs which may require greater distances.) A 60 ft-wide runway has been chosen as the ICAO minimum runway width to support an instrument approach procedure.

### Display resolution

Since the sensor can be active or passive, the EFVS display should adequately resolve a 60 ft-wide runway from 200 ft height above TDZE with a typical 3-degree glideslope. The pilot needs to be able to detect and accurately identify the visual references in the image.

The performance demonstration, establishing aircraft system compliance, typically includes bench testing, simulation flight testing, data collection, and data reduction to show that the proposed performance criteria

can be met. Minimal performance standards necessitate an evaluation of the system used during anticipated operational scenarios. The performance evaluations should therefore include demonstrations of taxi, take-off, missed approaches, failure conditions, crosswind conditions, and approaches into specific airports as appropriate for the system's intended function. For EFVS, performance at the lateral and vertical limits for the type of approach (for example, precision, non-precision, and approach with vertical guidance) for which operational credit is being sought should be demonstrated.

The applicant should demonstrate compliance through flight test using an aircraft that is fully representative for the purpose of the test in terms of flight deck geometry, instrumentation, alerts, indications, and controls (in the air or on the ground).

In addition, the applicant should use any of these three general verification methods to supplement flight test:

- (a) Analysis. Demonstrate compliance using an engineering analysis.
- (b) Laboratory Test. Demonstrate compliance using an engineering bench representative of the final EFVS being certified.
- (c) Simulation. Demonstrate compliance using a flight simulator.

The individual verification methods that are to be used should be specified in the certification plan to be agreed by the Agency. For extensions, features, and design decisions not explicitly specified in this CS, human factors evaluations should be conducted through analyses, bench, simulation, or flight testing.

Final approach course offsets greater than 3 degrees should be subject to additional flight test evaluation. The maximum allowable final approach course offset is established by flight testing. This testing should include the factors related to the offset, such as HUD/EFVS FOV, crosswinds, and the maximum drift angle for a conformal FPV.

Benchmark data establishing equivalence to normal visual operations with the specific aircraft should not normally be necessary. However, if flight test results show deviations from the standard criteria listed above, then benchmark data might be used to establish the equivalence of operations with EFVS-L to normal visual operations for that specific aircraft.

The image/symbology of EFVS-L should provide the visual cues for the pilot to perform the following actions without requiring exceptional pilot skill, alerting, strength, or excessive workload:

- (a) Speed control within +10/-5 kt of the approach speed, whether manually controlled or with auto-throttle, up to the point where the throttles are retarded for landing.
- (b) A smooth transition through flare to landing.
- (c) Approach, flare, and landing at a normal sink rate for the aircraft.
- (d) All touchdowns in the TDZ. Lateral touchdown performance should be demonstrated to be no worse than that achieved in visual operations for the specific aircraft. Longitudinal touchdown performance must be demonstrated within the TDZ which is the first one third, or the first 3 000 ft, of the usable runway, whichever is more restrictive, and demonstrated to be equivalent to or better than that achieved in visual operations for the specific aircraft.
- (e) Prompt and predictable correction of any lateral deviation away from the runway centre line to smoothly intercept the centre line.
- (f) Touchdowns with a bank angle that is not hazardous to the aeroplane.

- (g) Demonstrated performance of the installed EFVS at representative visibilities for operations conducted with EFVS-A and EFVS-L, as described in this document, will determine any additional limitation (for example, crosswind and offset).
- (h) A normal derotation.
- (i) Satisfactory and smooth control of the aeroplane from touchdown to a safe taxi speed.
- (j) Satisfactory and smooth control of the path of the aeroplane along the runway centre line through roll-out to a safe taxi speed.
- (k) A safe go-around at any time, including up to touchdown in all configurations to be certified.

#### Performance demonstration of EFVS-L

For EFVS-Ls and where appropriate for the performance demonstration, the non-visual conditions can be achieved either by natural obscuration or by use of a visibility-limiting device in front of the pilot. Caution should be used if the use of a visibility-limiting device for system performance demonstrations is selected. Visibility-limiting devices may not adequately simulate low-visibility conditions for all performance demonstrations of EFVS-Ls because of the unrealistically good external visibility outside the HUD FOV and the unrealistic image performance of EFVS-Ls in good atmospheric conditions.

#### **AMC AWO.A.EFVS.109 EFVS performance — landing distance**

- (a) The flare guidance provided by the HUD during landing and any procedure associated with using the HUD in EFVS-L, may result in an increase to the landing distance.
- (b) The EFVS landing distance referred to should be established as follows:
  - (1) The requirements of CS 25.125 should be applied, except that the configuration, procedure and speed should be that recommended in the associated procedures for using an EFVS.
  - (2) The landing distance as derived under (a) above should be compared with the normal landing distance as per CS 25.125. If the EFVS landing distance is longer than without using an EFVS, the EFVS landing distance should be furnished in the AFM. This landing distance may not be shorter than the landing distance established in accordance with CS 25.125 without using EFVS.
  - (3) The operating procedures, aeroplane configuration, approach speed, thrust management, piloting control techniques and the landing distance data applicable for EFVS-Ls should be furnished in the AFM.

#### **AMC AWO.A.EFVS.110 EFVS monitoring, annunciation and alerting**

##### Failure messages

EFVS malfunctions detected by the system, and which can adversely affect the normal operation of the EFVS, should be annunciated. As a minimum, specific in-flight failure message(s) for sensor failure and frozen image should be displayed to the flight crew.

##### EFVS annunciations

Any modes of EFVS operation should be annunciated on the flight deck and visible to the crew. The modes of the EFVS operation should be made available to the flight data recorder as required.

**Appendix 1 to AMC to Section 3 of Subpart A**

## EFVS compliance

The following is a non-exhaustive list of CSs in CS-25 that could be affected by an EFVS installation.

Applicants for normal-category aeroplanes (CS-23) can use the list below to establish if the equivalent aspects in CS-23 are affected and address them accordingly.

## Note:

As of Amendment 5 of CS-23, the referenced CS-23 requirement numbers are reflected in the AMC to CS-23.

Certification Specification	Description
25.251	Vibration and buffeting
25.301	Loads
25.303	Factor of safety
25.307	Proof of structure
25.561/25.562(c)(5)	Emergency landing conditions; head injury criterion (HIC)
25.571	Damage-tolerance and fatigue evaluation of structure
25.581	Lightning protection
25.601	Design and Construction - General
25.603	Materials
25.605	Fabrication methods
25.609	Protection of structure
25.611	Accessibility provisions
25.613	Material strength properties and material design values
25.619	Special factors

Certification Specification	Description
25.625	Fitting factors
25.629(d)(8)	Aeroelastic stability
25.631	Bird strike damage
25.771	Pilot compartment
25.773	Pilot compartment view
25.777	Cockpit controls
25.1301	Function and installation
25.1309	Equip, systems, and installations
25.1316	Electrical and electronic system lightning protection
23.1308 and 25.1317	High-intensity radiated fields (HIRF) protection
25.1321	Arrangement and visibility
25.1322	Flight crew alerting
25.1323	Airspeed indicating systems
25.1329	Flight guidance system
25.1353	Electrical equipment and installations
25.1357	Circuit protective devices
25.1381	Instrument lights
25.1419	Ice protection



---

Certification Specification	Description
25.1431(a)(c)	Electronic equipment
25.1459(e)	Flight data recorders
25.1501	Operating limitations and information; General
25.1523	Minimum flight crew
25.1525	Kinds of operation
25.1529	Instructions for Continued Airworthiness
25.1581	Aeroplane flight manual; General
25.1583	Operating limitations
25.1585	Operating procedures

**AMC TO SECTION 4**

**SYNTHETIC VISION GUIDANCE SYSTEMS (SVGS)**

**GENERAL**

**AMC AWO.A.SVGS.101 General**

Further guidance on the integration of an SVGS is contained within RTCA DO-379.

**APPENDIX 1 TO AMC TO SUBPART A 'MODELS'****Signal-in-space models for approach and landing simulation and fault analysis****1 Purpose**

The purpose of this AMC is to provide acceptable models of signal in space based on known navigation means that can be used to demonstrate in simulation system performance in approach and landing. To be noted that system performance depends on navigation means performance (nominal limit and fault) and a performance demonstration done using one navigation means may not be valid when using another navigation means due to different nominal, limit and fault characteristics.

**2 ILS CAT I/II/III signal-in-space model**

The values given are derived from the performance characteristics for Category II ILS, contained in ICAO Annex 10, Volume I, Sixth Edition, dated July 2006, at Amendment 89 except where otherwise indicated.

ICAO Annex 10, Volume I (Attachment C, paragraph 2.14) defines a standard classification of ILS by using three characters:

- (1) Facility performance (I, II or III);
- (2) ILS points (A, B, C, T, D or E — see definition below) to which the localiser structure conforms to the course structure of a CAT II/III localiser; and
- (3) Level of integrity and continuity of service (1, 2, 3 or 4).

**ILS point 'A'**

A point on the ILS glide path measured along the extended runway centre line in the approach direction at a distance of 7.5 km (4 NM) from the threshold.

**ILS Point 'B'**

A point on the ILS glide path measured along the extended runway centre line in the approach direction at a distance of 1 050 m (3 500 ft) from the threshold.

**ILS Point 'C'**

A point through which the downward extended straight portion of the nominal ILS glide path passes at a height of 30 m (100 ft) above the horizontal plane containing the threshold.

**ILS reference datum (point 'T')**

A point at a specified height located above the intersection of the runway centre line and the threshold and through which the downward extended straight portion of the ILS glide path passes.

**ILS Point 'D'**

A point 4 m (12 ft) above the runway centre line and 900 m (3 000 ft) from the threshold in the direction of the localiser.

**ILS Point 'E'**

A point 4 m (12 ft) above the runway centre line and 600 m (2 000 ft) from the stop end of the runway in the direction of the threshold.

Depending on the intended operation, the minimum class of ILS elected will define the detailed characteristics of the ILS to be used for:

- nominal and limit case analysis;
- failure cases to be considered; and
- integrity and continuity analysis.

## 2.1 Glide path

### 2.1.1 Glide path angles

It should be assumed that the operationally preferred glide path angle is 3°. The system should be shown to meet all applicable requirements with promulgated glide path angles from 2.5° to 3°. Where certification is requested for the use of a larger beam angle, performance on such a beam should be assessed.

- The system should define minimum and maximum glides path angle slope considered in the demonstrations and shall meet all applicable requirements with the defined limits. For CAT I operations, it is recommended to cover at least a 2.5° to 3.5° glideslope range.
- For CAT II or CAT III operations, it is recommended to cover a 2.5° to 3° glideslope range.

### 2.1.2 Height of ILS reference datum (height of glide path at threshold)

For establishing compliance with the longitudinal touchdown performance limits, it may be assumed that the height of the ILS reference datum is 15 m (50 ft).

### 2.1.3 Glide path alignment accuracy

It should be assumed that the standard deviation of the beam angle about the nominal angle ( $\ominus$ ) is 0.025  $\ominus$ .

### 2.1.4 Displacement sensitivity

It should be assumed that the angular displacement from the nominal glide path for 0.0875 DDM has the value of 0.12  $\ominus$ .

### 2.1.5 Glide path structure

For the purposes of simulation, the noise spectrum of ILS glide path may be represented by a white noise passed through a low-pass first-order filter of time constant 0.5 sec. For the whole of the approach path, the output of the filter should be set to a two-sigma level of:

- 0.035 DDM for facility performance type I; and
- 0.023 DDM for facility performance types II or III.

(Background: An interpretation of Annex 10, Volume I, paragraph 3.1.5.4.1 & 3.1.5.4.2)

Note: This model is primarily intended to simulate the characteristics of beams at low altitude, and therefore results derived from its use should not be relied on for heights above 150 m (500 ft).

### 2.1.6 Glide fault mode

The effect of a glideslope malfunction can be modelled as a ramp with a start time, a ramp rate, a glide monitoring threshold and a time to alert as illustrated in Figure 1. As the effect of the glide fault may differ depending on start time and ramp rate, the combination that provides the most severe effect on aircraft deviation shall be considered.

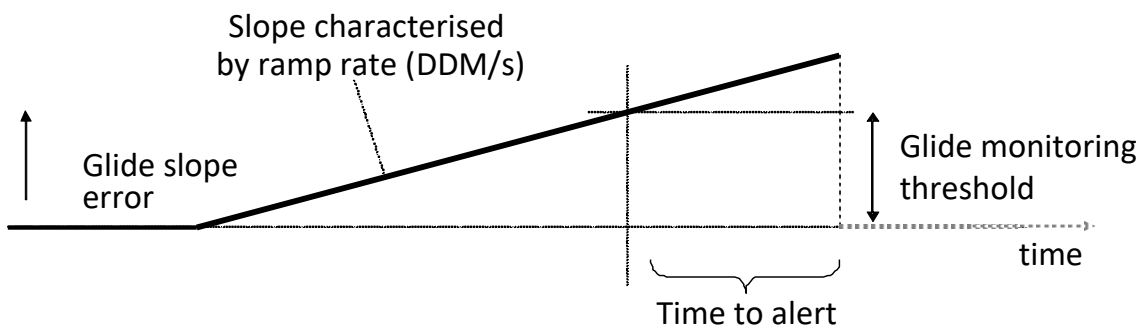

Figure 1: ILS glide malfunction transient

The glide malfunction transient depends on the facility performance type:

	Facility performance Type I	Facility performance Types II or III
Glide monitoring threshold (maximum shift of the mean glide path)	minus 0.075 $\theta$ (below nominal glide) plus 0.10 $\theta$ (above nominal glide)	
Time to alert	6 s	2 s

Table 1: Glideslope monitoring threshold and time to alert based on facility performance

2.2 Localiser

2.2.1 Course alignment accuracy

It should be assumed that at the threshold the standard deviation of the course line about the centre line is:

- 4.5 m (15 ft) for facility performance type I; and.
- 1.5 m (5 ft) for facility performance types II or III.

NOTE: The Type II or III value is in between those given in Annex 10, paragraph 3.1.3.6 for Category II and Category III ILS which are assumed to be three-sigma values, 2.5 m (8.3 ft) and 1.0 m (3.3 ft) respectively.

2.2.2 Displacement sensitivity

It should be assumed that the nominal displacement sensitivity at the threshold has the value of 0.00145 DDM/m.

2.2.3 Course structure

For the purposes of simulation, the noise spectrum of ILS localisers may be represented by a white noise passed through a low-pass first-order filter of time constant 0.5 sec.

- Facility performance type I: For initial approach path, the output of the filter should be set to a two-sigma level of 0.005 DDM up to ILS point (A, B, C, T, D or E) elected as minimum required for the operation.

- If minimum required for the operation is ‘A’ or ‘B’, for final approach path, the output of the filter should be set to a two-sigma level of 0.015 DDM up to point ‘C’. After point ‘C’, localiser signal performance is unknown and should not be used.
- If minimum required for the operation is ‘C’, ‘T’, ‘D’ or ‘E’, after the elected point, localiser signal performance is unknown and should not be used.
- Facility performance types II or III: For the whole of the approach path, the output of the filter should be set to a two-sigma level of 0.005 DDM.

2.2.4 Localiser fault mode

The effect of a localiser malfunction can be modelled as a ramp with a start time, a ramp rate, a localiser monitoring threshold and a time to alert as illustrated in

Figure 2. As the effect of the localiser fault may differ depending on start time and ramp rate, the combination that provides the most severe aircraft deviation shall be considered.

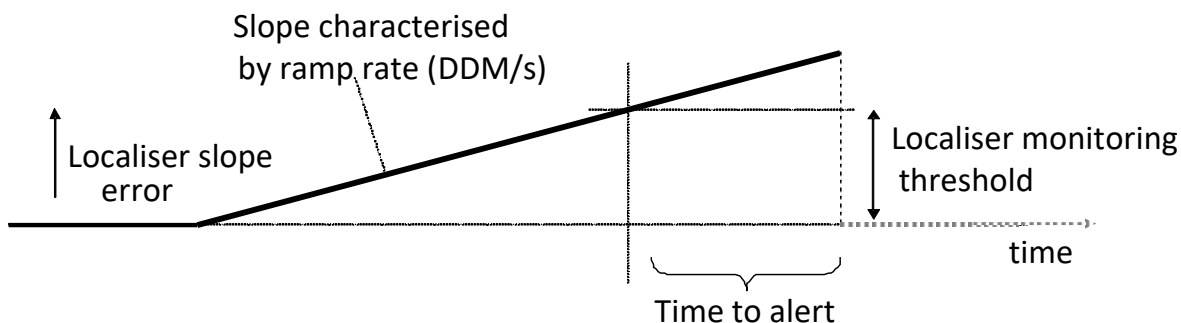

Figure 2: ILS localiser malfunction transient

The localiser malfunction transient depends on the facility performance type:

	Facility performance Type I	Facility performance Type II	Facility performance Type III
Localiser monitoring threshold (maximum shift of the mean course line from runway centre line)	10.5 m (35 ft)	7.5 m (25 ft)	6 m (20 ft)

Time to alert	10 s	5 s	2 s
---------------	------	-----	-----

**Table 2: Localiser monitoring threshold and time to alert based on facility performance**

### 2.2.5 Integrity and continuity

The probability of radiating false ILS localiser or glide guidance can be assumed to be:

- for integrity level 1 ILS: no demonstrated values;
- for integrity level 2 ILS:  $1.0 \times 10^{-7}$  in any one landing; and
- for integrity levels 3 & 4 ILS:  $0.5 \times 10^{-9}$  in any one landing.

The probability of losing ILS guidance localiser or glide can be assumed to be:

- for integrity level 1 ILS: no demonstrated values;
- for integrity level 2 ILS:  $4.0 \times 10^{-6}$  in any period of 15 s;
- for integrity level 3 ILS:  $2.0 \times 10^{-6}$  in any period of 15 s; and
- for integrity level 4 ILS:  $2.0 \times 10^{-6}$  in any period of 30s (localiser) or 15 s (glide)

### 3 MLS signal-in-space model

The MLS models defined by the ICAO All Weather Operations Panel (AWOP) (reference AWOP/14-WP/659, dated 4/2/93) should be used for approach simulations. Alternatively, if certification of MLS is only sought for ILS lookalike operations, the applicant may use the ILS model defined in paragraph 2 above. This is based on the assertion that the MLS quality is equal to or better than that of the ILS and requires no further substantiation.

### 4 GLS-in-space model

What follows describes one acceptable model for the assumed characteristics of GLS guidance errors. Applicants using an alternate model are responsible for documenting the alternate model, its basis (including a mapping to ICAO Annex 10 characteristics and any additional assumptions made), and its validity.

The ground-based augmentation system (GBAS) performance model simulates the outputs of a fault-free GBAS airborne receiver when used in conjunction with a GBAS ground station categorised as either GAST C or GAST D.

The architecture of the GLS model is illustrated in Figure 3. The GLS model includes a navigation system error (NSE) generator which generates NSEs representative of a GBAS providing approach service type C or D as defined by the applicable requirements [i, ii, iii]. The position calculator adds NSEs to the true position of the GLS reference point (GRP). The deviation calculator computes the deviations of the GRP given the FAS data. A latency model is applied to each output of the GLS model.

Development of all components of the GLS model is documented in [iv], [v] and [vi]. The NSE generator and NSE step generator are discussed below.

#### 4.1 GBAS NSE generator

The GBAS NSE generator produces NSEs in the along-track, cross-track and vertical directions. The block diagram of the GBAS NSE generator is shown in Figure 4. The Gaussian white noise (GWN) generator produces three independent noise sequences with zero, mean and unity variance. Each sequence is filtered by a second-

order Butterworth filter. The compensation gain which brings the root mean square (rms) of the filtered noise back to unity is obtained as:

$$G_x = \sqrt{\frac{2\sqrt{2}}{\Delta T \omega_n}} \quad [1]$$

The filter output is scaled by NSE scale factors  $K_{atr}$ ,  $K_{xtr}$ , and  $K_{ver}$ . At the beginning of each run, the NSE generator filter should be initialised at a value sampled from a Gaussian distribution consistent with these scale factors.

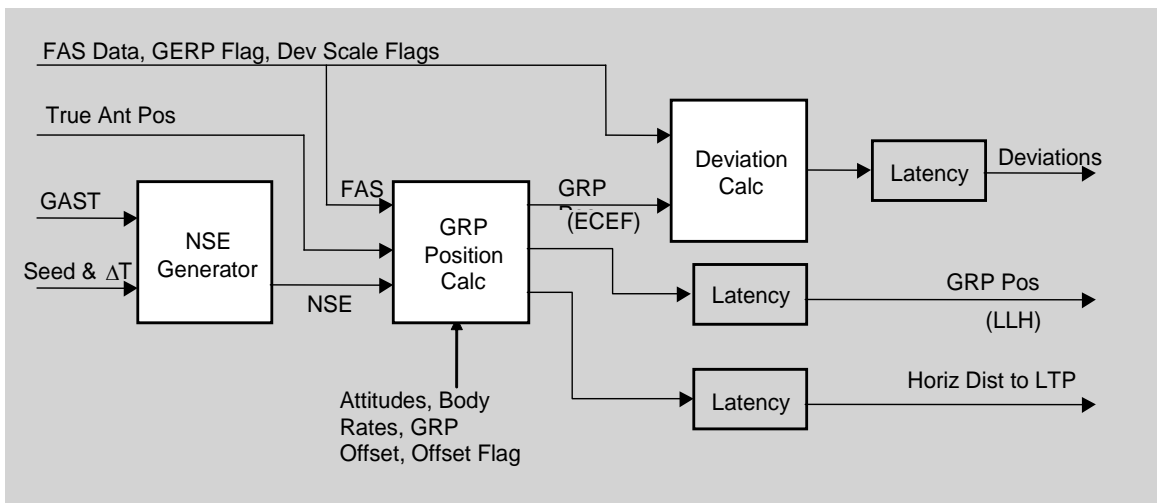

Figure 3: GBAS signal model

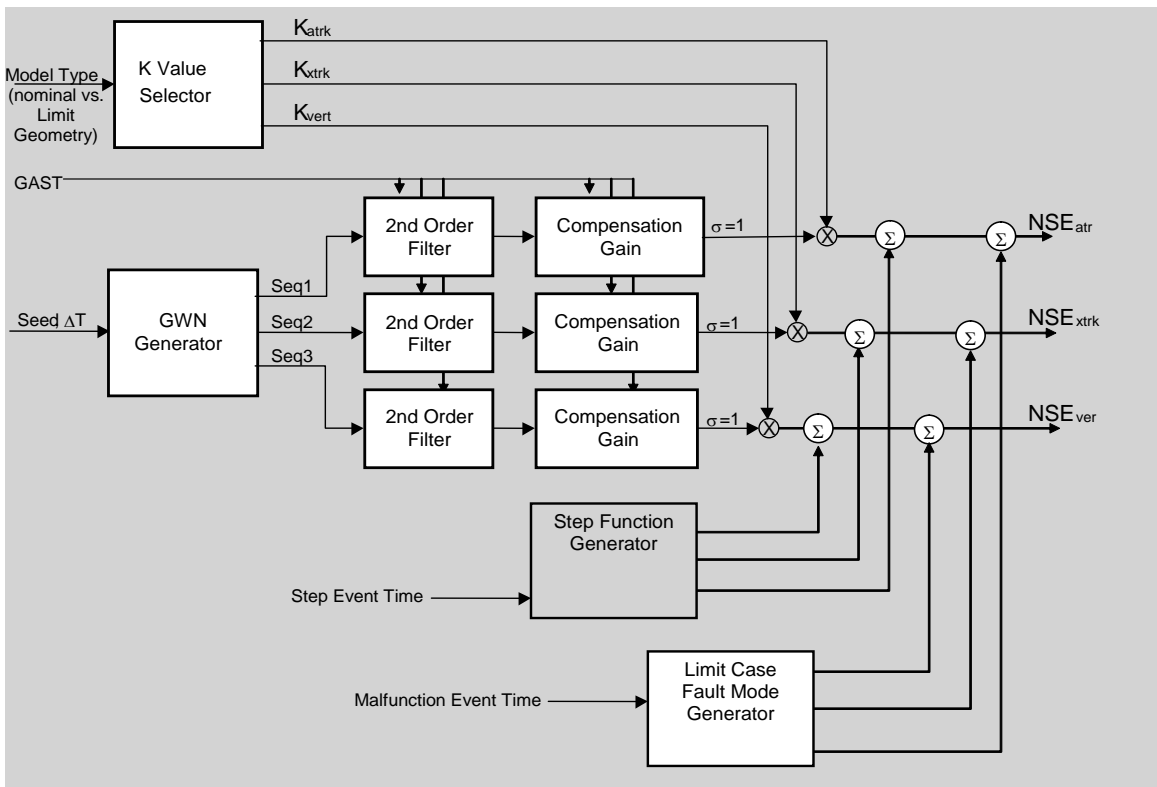



Figure 4: GLS NSE generator

4.2 Second-order filter of GBAS NSE generator

The second-order filter to be implemented in the GBAS NSE generator is characterised by:

$$H(s) = \frac{\omega_n^2}{s^2 + \sqrt{2}\omega_n s + \omega_n^2} \quad [2]$$

where  $\omega_n$  is the natural frequency given by:

- for GAST C:  $\omega_n = 0.01$  rad/sec
- for GAST D:  $\omega_n = 0.033$  rad/sec

4.3 Noise scale factor

The model accounts for the variation in accuracy due to satellite geometry by setting the noise scale factor to a constant which is sampled from a distribution. For each run, the value of  $K_{vert}$  is determined by selecting a sample,  $x$ , from a uniform distribution between 0 and 1. The value of  $K_{vert}$  is then given by the following function of  $x$ :

$$K_{vert} = f(x) = a_1 + a_2 x - \frac{a_3}{x-1} \quad [3]$$

Where the parameters of the function are dependent on the GBAS approach service type as given in Table 3 below:

Service type	$a_1$	$a_2$	$a_3$	$K_{vert\_max}$
GAST C	0.4	0.2	0.006	10/5.762=1.736
GAST D	0.52	0.47	0.005	10/5.762=1.736

Table 3: GAST dependent parameters for  $K_{vert}$

If the random pick from a distribution between 0 and 1 results in  $K_{vert} > K_{vert\_max}$ , then the value should be discarded and another sample should be selected from the uniform distribution set to the maximum value from the table<sup>9</sup>. An alternative acceptable means for computing the NSE scale factors is given in Section 2 below.

For each run, the value of  $K_{xtrk}$  is determined by selecting a sample,  $x_1$ , from a uniform distribution between 0 and 1. For each run, the value of  $K_{atrk}$  is determined by selecting a sample,  $x_2$ , from a uniform distribution between 0 and 1. The cross-track and along-track scale factors are then computed by:

$$K_{xtrk} = f(x_1) = a_1 + a_2 x_1 - \frac{a_3}{x_1-1} \quad [4]$$

<sup>9</sup> This corresponds to the case where VPL>10 m and therefore the system is not available.

$$K_{atrk} = f(x_2) = a_1 + a_2 x_2 - \frac{a_3}{x_2 - 1} \quad [5]$$

where the parameters of the function are dependent on the GBAS approach service type as given in Table 3:

Service type	a <sub>1</sub>	a <sub>2</sub>	a <sub>3</sub>	K <sub>xtrk_max</sub> , K <sub>atrk_max</sub>
GAST C	0.2	0.1	0.003	40/5.762=6.942
GAST D	0.21	0.12	0.003	17/5.762=2.951

Table 4: GAST dependent parameters for K<sub>xtrk</sub>

If the random pick from a distribution between 0 and 1 results in  $K_{xtrk} > K_{xtrk\_max}$  or  $K_{atrk} > K_{atrk\_max}$ , then the value should be discarded and another sample should be selected from the uniform distribution.

#### 4.4 NSE step generator

The NSE step generator is illustrated in Figure 5. Step errors will occur when individual satellites are removed from the position solution (e.g. a satellite fails and stops transmitting or the user receiver stops tracking a satellite for any reason). The step generator produces representative step errors in the vertical, along-track and cross-track directions. This is accomplished by scaling a unit step function by factors that are derived from representative statistical distributions. First, three random samples, one for each axis, are selected from a zero mean unit variance normal distribution. Then, these samples are multiplied by scale factors that are chosen to simulate the statistical variation in the size of an error that would result from normal variations in the relative geometry between the user and the satellites. Finally, the resultant constant factors are multiplied with a unit step function time sequence.

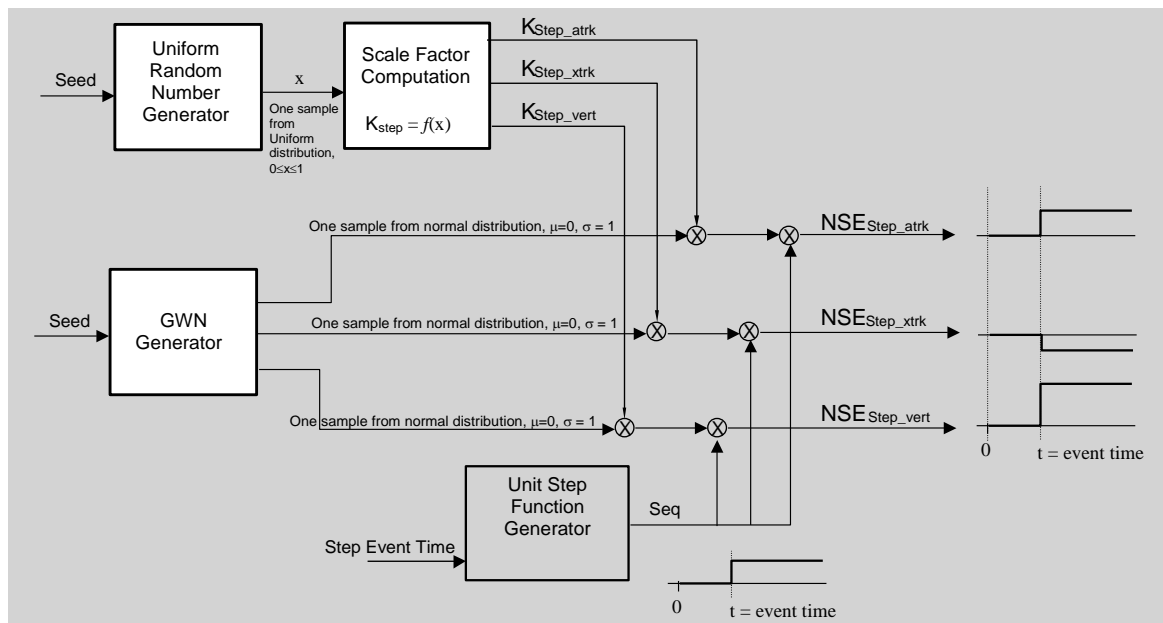

Figure 5: NSE step generator

#### 4.5 NSE step generator scale factor computation

For each run, the value of  $\sigma_{\text{step\_vert}}$  is determined by selecting a sample,  $x$ , from a uniform distribution between 0 and 1. The value of  $\sigma_{\text{step\_vert}}$  is then given by the following function of  $x$ :

$$\sigma_{\text{step\_vert}} = f(x) = b_1 + b_2x - \frac{b_3}{x - 1.01} \quad [6]$$

where the parameters of the function are dependent on the GBAS approach service type as given in Table 5:

Service type	b <sub>1</sub>	b <sub>2</sub>	b <sub>3</sub>	σ <sub>step_vert_max</sub>
GAST C	0.4	0.8	0.07	FASVAL/2
GAST D	0.5	0.8	0.05	3.5

Table 5: GAST dependent parameters for σ<sub>step\_vert</sub>

If the random pick from a distribution between 0 and 1 results in σ<sub>step\_vert</sub> > σ<sub>step\_vert\_max</sub>, then the value should be discarded and another sample should be selected from the uniform distribution.

For each run, the value of σ<sub>step\_xtrk</sub> is determined by selecting a sample, x<sub>1</sub>, from a uniform distribution between 0 and 1. The value of σ<sub>step\_atrk</sub> is determined by selecting a sample, x<sub>2</sub>, from a uniform distribution between 0 and 1. The cross-track and along-track NSE step scale factors are then computed by:

$$\sigma_{step\_xtrk} = f(x_1) = b_1 + b_2 x_1 - \frac{b_3}{x_1 - 1} \quad [7]$$

$$\sigma_{step\_atrk} = f(x_2) = b_1 + b_2 x_2 - \frac{b_3}{x_2 - 1} \quad [8]$$

where the parameters of the function are dependent on the GBAS approach service type as given in Table 6:

Service type	b <sub>1</sub>	b <sub>2</sub>	b <sub>3</sub>	σ <sub>step_axtrk_max</sub>
GAST C	0.32	0.32	0.05	20 m
GAST D	0.35	0.35	0.35	5.5 m

Table 6: GAST dependent parameters for σ<sub>step\_xtrk</sub> or σ<sub>step\_atrk</sub>

If the random pick from a distribution between 0 and 1 results in σ<sub>step\_xtrk</sub> > σ<sub>step\_xtrk\_max</sub>, or σ<sub>step\_atrk</sub> > σ<sub>step\_axtrk\_max</sub>, then the value should be discarded and another sample should be selected from the uniform distribution.

The scale factor, K<sub>step\_vert</sub>, of the magnitude of the vertical error is then selected from a normal distribution with 0 mean and a standard deviation of σ<sub>step\_vert</sub>. The scale factor, K<sub>step\_xtrk</sub>, of the cross-track deviation is selected from a normal distribution with 0 mean and a standard deviation of σ<sub>step\_xtrk</sub>.

#### 4.6 Latency model

The latency of the GLS output should be delayed for a period of 400 msec.

#### 4.7 Fault mode generator

The fault mode generator produces a ramp error with characteristics as illustrated in

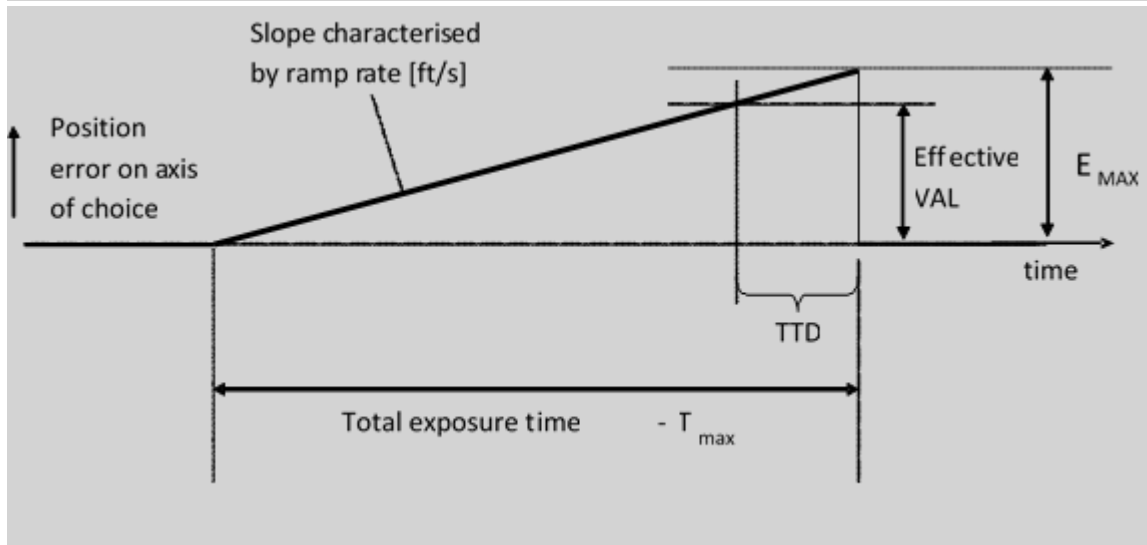

Figure 7. The effect of a malfunction is modelled as a ramp, with a start time, a ramp rate and a total exposure time,  $T_{max}$ . The maximum value of the ramp depends on the ramp rate and time to alert. The ramp is assumed to increase to the level of the maximum value and then to exceed that value for a period equal to the time-to-detect and mitigate the failure. The erroneous satellite is isolated and the error returns to the nominal value (i.e. the fault error is set to zero). The model may alternatively produce step errors where the maximum change in error due to the step is specified rather than the ramp rate. (See reference [vii] for more details regarding GLS fault modelling).

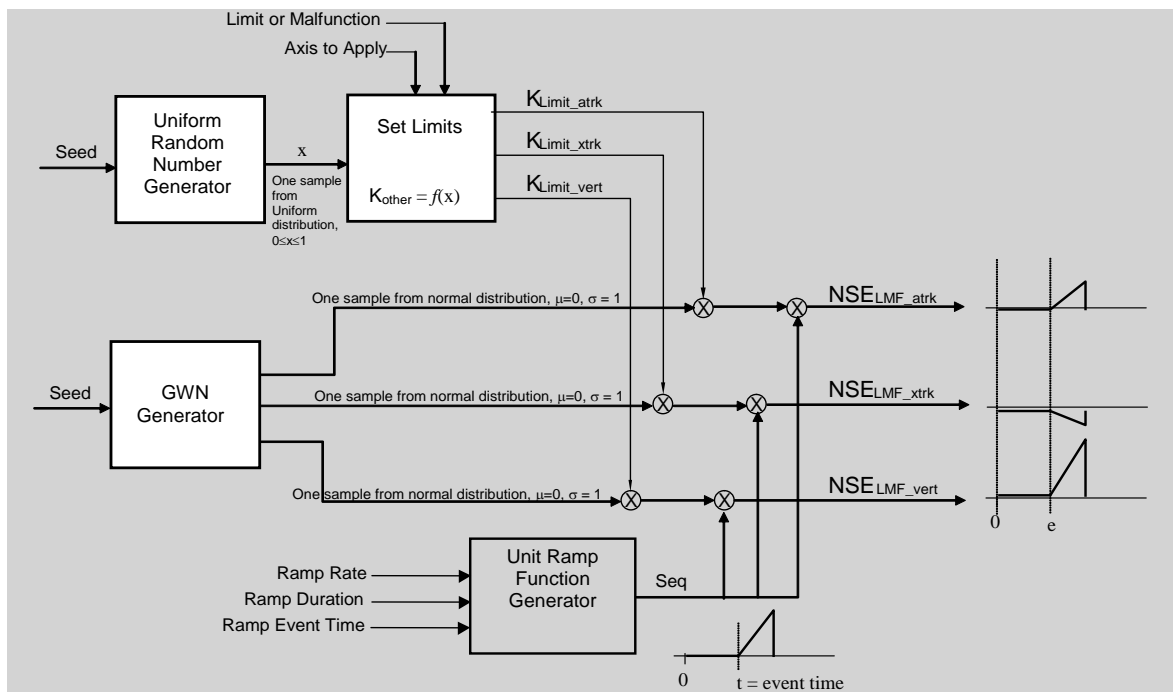
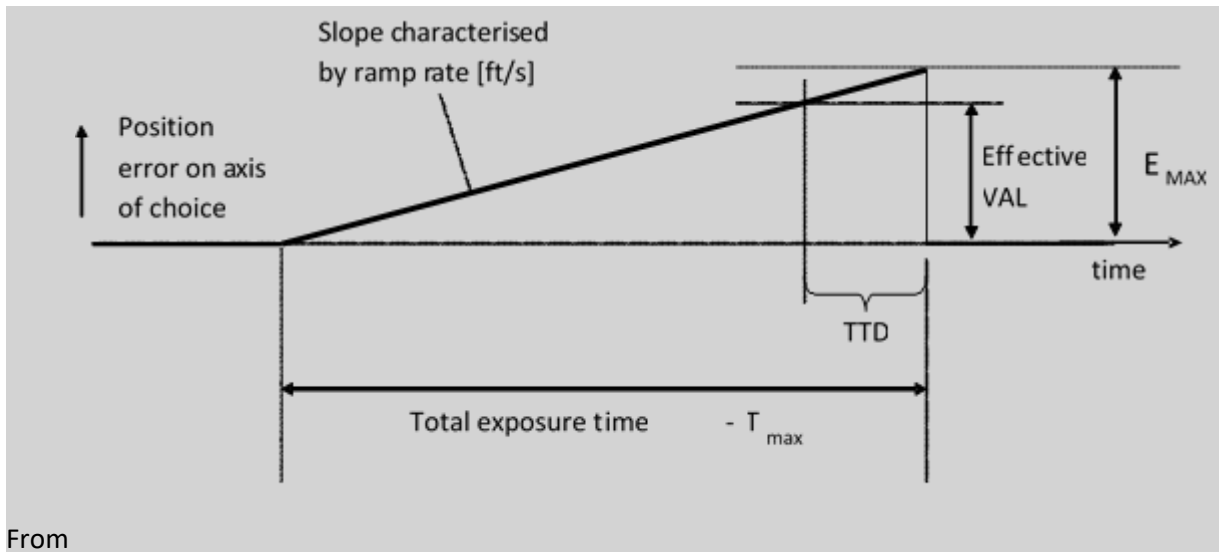

Figure 6: Limit malfunction generator



From Figure 7, it can be seen that for the ramp:

$$T_{MAX} = TTD + \frac{\text{Effective VAL}}{RR} \quad [9]$$

$E_{MAX}$  and the effective vertical alert limit (VAL) depend on the type of malfunction. For satellite ranging sources, the effective VAL is a function of the maximum error allowable with probability greater than  $1 \times 10^{-9}$  by the  $P_{md}$  performance constrain with conditional probability (reference [Error! Bookmark not defined.], Appendix B, Section 3.6.7.3.3.3), (i.e. 1.6 m) multiplied by the geometry screening limit.

$$E_{MAX} = 1.6 \cdot S_{vert\_max} \quad [10]$$

where:  $S_{vert\_max}$  is the maximum vertical projection for any satellite allowed by geometry screening. This value is set by the aircraft manufacturer to limit the size of  $E_{MAX}$  by specifying  $S_{vert}$  and  $S_{vert2}$  as described in reference [viii].

For ground segment reference receiver failures, the effective VAL will depend on the geometry screening applied in the airborne equipment. If no additional geometry screening is applied other than  $VPL < VAL$ , the maximum effective VAL is 9.35 [m] (see Table 7). If additional geometry screening is applied, a lower effective VAL may result. Reference [viii] explains how to compute the effective VAL given additional geometry screening. Figure 8 shows a plot of maximum vertical and lateral errors as a function of vertical and lateral alert limit screening. The calculations to produce the plot in Figure 8 are described in detail in reference [Error! Bookmark not defined.].

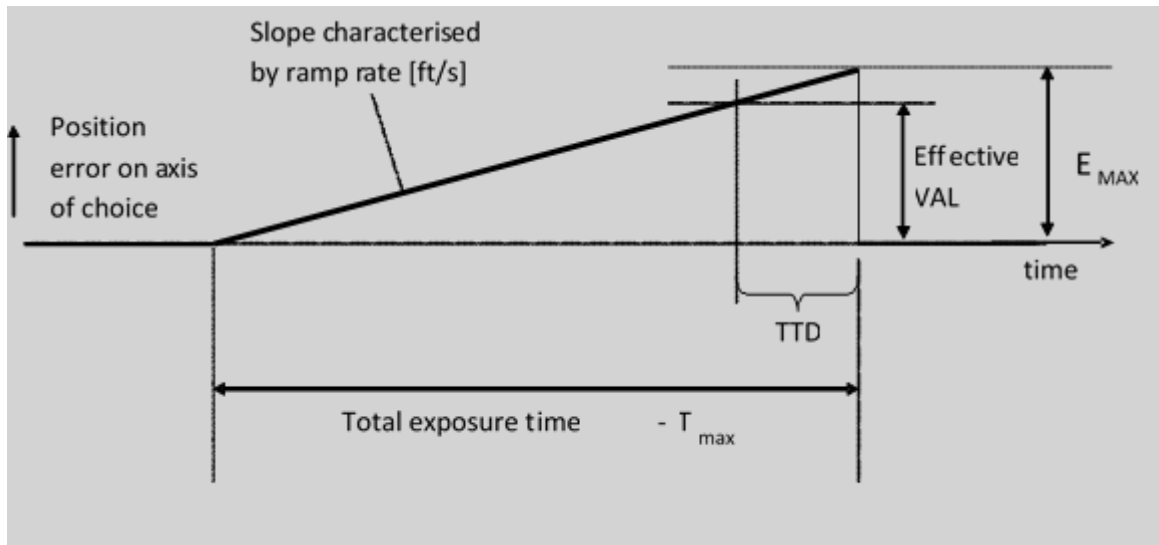

Figure 7: Malfunction transient

For ionospheric anomalies, the maximum error  $E_{max}$  is less than or equal to  $EIG \times S_{vert}$  or  $EIG \times S_{vert2}$ , whichever is larger.  $S_{vert}$  and  $S_{vert2}$  are geometry screening parameters set in the airborne equipment as described in [ix]. The  $E_{max}$  will be limited by the airborne equipment, which will limit the  $EIG \times S_{vert}$  and  $EIG \times S_{vert2}$  to a maximum value for the airborne installation for each axis, vertical and lateral. For example, if an aircraft can be certified with an  $E_{max} = 12$  m, then it will limit  $S_{vert}$  and  $S_{vert2}$  to 12 m divided by the broadcast EIG.

Table 7 and Table 8 give the characteristics for transient errors in the vertical and horizontal directions respectively for each of the three major identified fault types.

Fault type	Service type	Ramp rates [m/s]	Effective VAL [m]	$E_{max}$ [m]	Time to detect (TTD) [s]
Ranging source failures	GAST C	0-∞	10	Dependent	6
	GAST D	0-∞	$1.6 \times S_{vert}$	Dependent	2.5
Iono anomaly	GAST C	0-4	N/A	N/A	N/A
	GAST D	0-4	N/A	Max ( $EIG \times S_{vert}$ ) Max ( $EIG \times S_{vert2}$ ) [note 2]	N/A
Single-reference receiver failure	GAST C	0-∞	10	Dependent	6
	GAST D	0-∞	9.35 [note 1]	Dependent	2.5

Table 7: Malfunction transient characteristics in the vertical direction

Note 1: These values are an absolute worst case assuming no geometry screening is done based on  $T_{B\_air\_vert}$  or M. Only geometry screening of  $VPL < VAL = 10$  m is assumed. Smaller maximum values can be obtained by using additional geometry screening as per reference [x].

Note 2: EIG is the uplink parameter for the ionospheric error monitor.

Fault type	Service type	Ramp rates [m/s]	Effective LAL [m]	$E_{max}$ [m]	Time to detect (TTD) [s]
Ranging source failures	GAST C	0–∞	40	Dependent	6
	GAST D	0–∞	$1.6 \times S_{lat}$	Dependent	2.5
Iono anomaly	GAST C	0–4	N/A	N/A	N/A
	GAST D	0–4	N/A	Max (EIG × $S_{lat}$ ) Max (EIG × $S_{lat2}$ ) [note 2]	N/A
Single ref receiver failure	GAST C	0–∞	40	Dependent	6
	GAST D	0–∞	35.9 [note 1]	Dependent	2.5

Table 8: Malfunction transient characteristics in the lateral direction

Note 1: These values are an absolute worst case assuming no geometry screening is done based on  $T_{B\_air\_lat}$  or M. Only geometry screening of  $LPL < LAL = 40$  m is assumed. If geometry screening of  $LPL < LAL = 10$  m is applied, then the values for effective LAL would be the same as the value given in Table 7 for effective VAL. Smaller maximum values can be obtained by using additional geometry screening per reference [Error! Bookmark not defined.] (e.g. a limitation on  $T_{B\_air\_lat}$  or M).

Note 2: EIG is the broadcast parameter for the ionospheric error monitor.



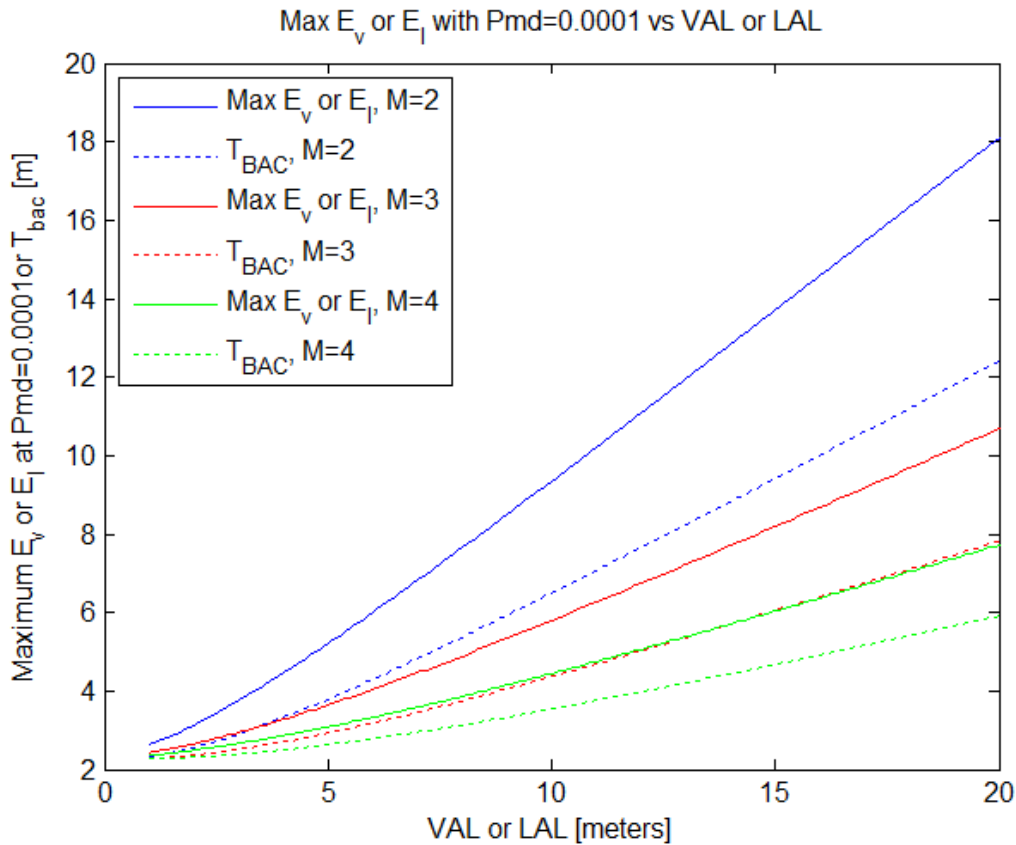

Figure 8: Maximum error and T<sub>bac</sub> as a function of alert limits

4.8 Integrity and continuity

The probability of issuing false GLS guidance can be assumed to be:

- for GAST C:  $2.0 \times 10^{-7}$  in any one landing; and
- for GAST D:  $1 \times 10^{-9}$  in any period of 15 s.

The probability of losing GLS guidance is can be assumed to be:

- for GAST C:  $8.0 \times 10^{-6}$  in any period of 15 s;
- for GAST D:  $2 \times 10^{-6}$  in any period of 15 s.

4.9 Alternative method for calculating and using NSE model scale factors

4.9.1 Estimation of 10-point piecewise linear interpolation of GBAS NSE — GAST D

An alternative method to use the NSE model is to compute, before launching any run of the Monte-Carlo autoland simulations, the distributions of the scale factors,  $K_{vert}$  and  $K_{xtr} = K_{atrk}$ . For these two last quantities, we conservatively allocate the worst horizontal sigma. These distributions have been computed using assumptions described in [xi] and [xii]. Then, for each run of the Monte-Carlo simulations, we draw, from these two distributions, a sigma vertical =  $K_{vert}$  and a worst horizontal sigma for  $K_{xtrk}$  and  $K_{atrk}$ , at the beginning of the approach, which are kept constant during the approach.

In order to facilitate the use of these distributions, the 10-point piecewise linear interpolation of  $K_{vert}$  and  $K_{worst\_horizontal\_sigma}$  are provided on the histograms and using a dual entry table X-axis corresponding to Sigma vert or worst\_sigma\_horizontal in metres.

4.9.2 Sigma vertical

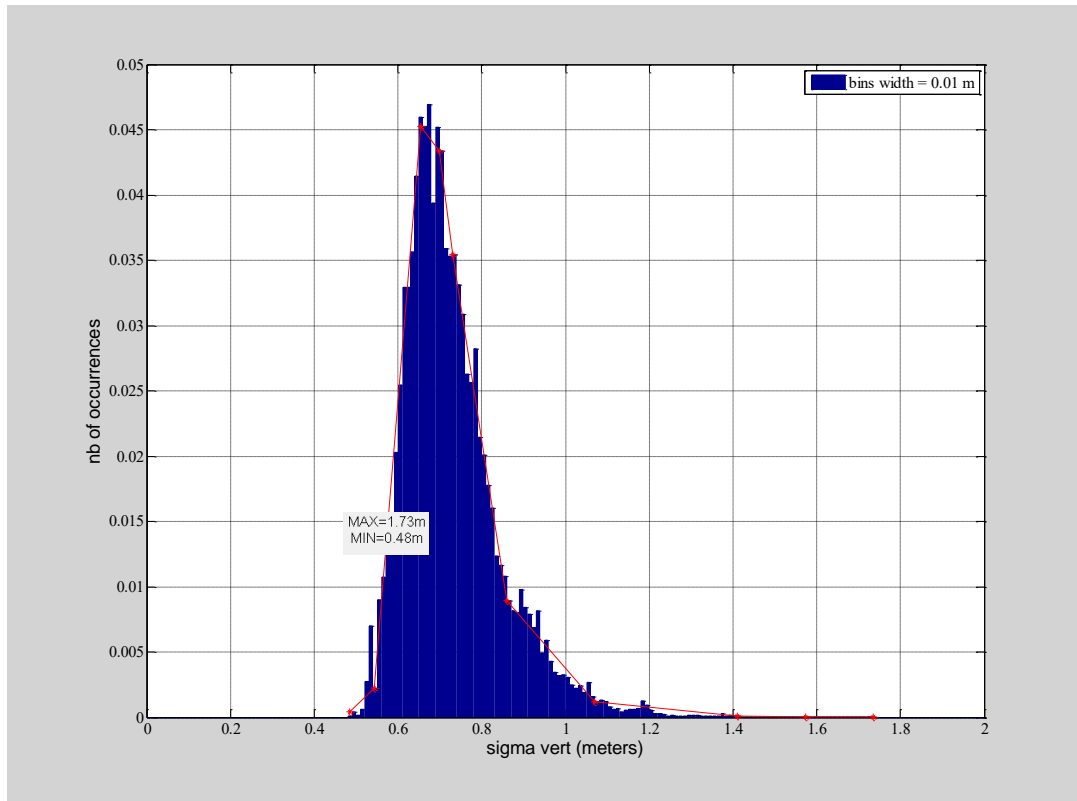

Figure 9: Sigma vertical samples

Sigma_vert	Number of occurrences
0.4850000000000000	0.000429191837945
0.543326533206011	0.002257116788039
0.655055242735278	0.045229563598357
0.699018742036146	0.043376936959747
0.731326218889690	0.035448466874264
0.860858976217526	0.008926572687034
1.070145122860493	0.001211926592757
1.409975954322260	0.000073333137778
1.573104102697827	0.000010035060959
1.7350000000000000	0.000008491205427

4.9.3 Worst horizontal sigma

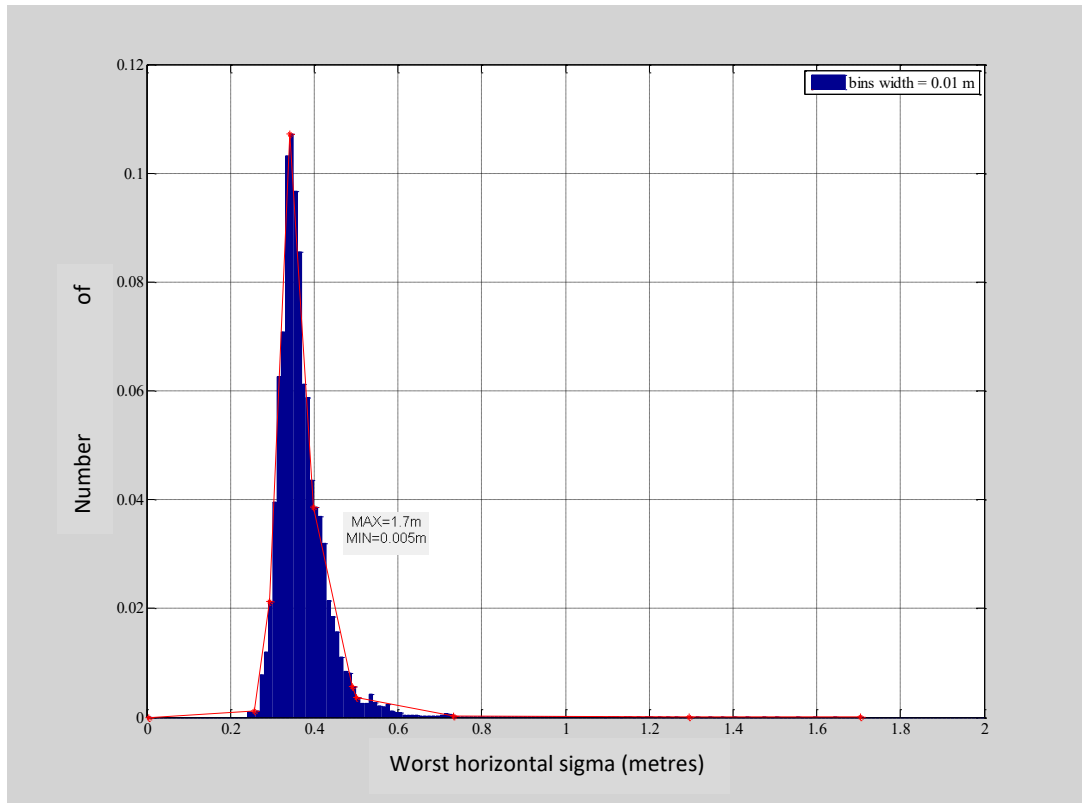

Figure 10: Worst horizontal sigma samples

Sigma_worst_horizontal	Number of occurrences
0.0050000000000000	0
0.257665870406134	0.001235856353506
0.293780182441118	0.021311381766140
0.341769349550846	0.107172907188037
0.398519584681962	0.038574002399152
0.489966724012817	0.005669037514146
0.501954763905412	0.003652762189125
0.733255508608094	0.000223859052165
1.294724573608414	0.000000771927766
1.7050000000000000	0.000000771927766

As with the NSE noise scale factors, an alternative way of using the step function is to derive scale factors sigma\_step\_vert and worst\_sigma\_step horizontal to take into account steps induced by loss of tracking of satellites by the receiver due to geometry (rise/set of satellites) or due to satellite failures. The distributions and the 10-point piecewise linear interpolations are provided below for these two cases for the two dimensions.

4.9.4 Rise/set sigma step vertical

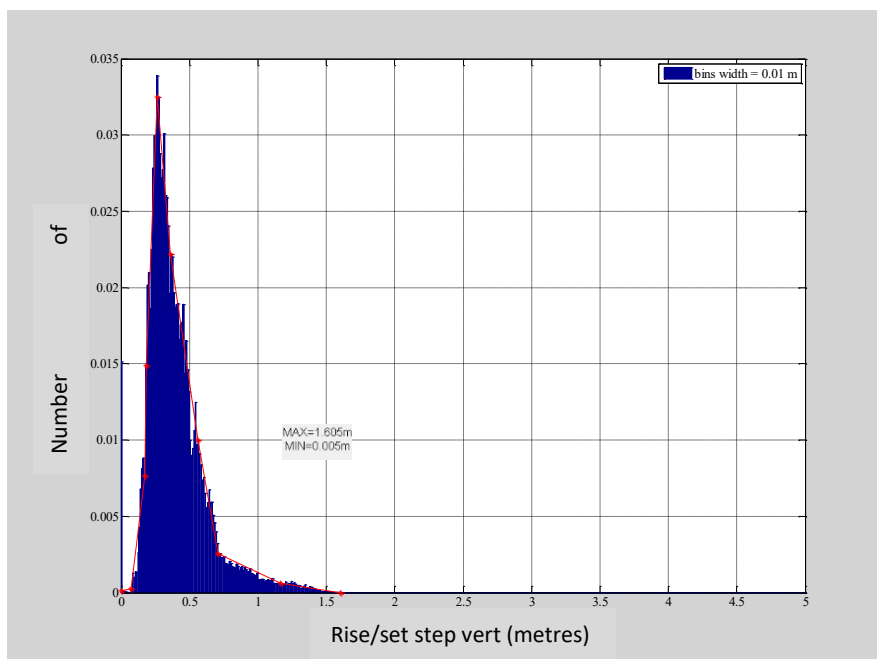

Figure 11: Rise/set sigma samples

Rise/Set Sigma_step_vert	Number of occurrences
0.005000000000000	0.000102160167567
0.072435248412769	0.000251314012215
0.173069321361968	0.007640899466239
0.183661728498818	0.014862132304962
0.266851710720950	0.032471159430220
0.360116883106780	0.022183880145120
0.560386526870370	0.010022935263488
0.707103250848933	0.002542678888367
1.168108921989317	0.000590218235325
1.605000000000000	0

4.9.5 Rise/set worst sigma step horizontal

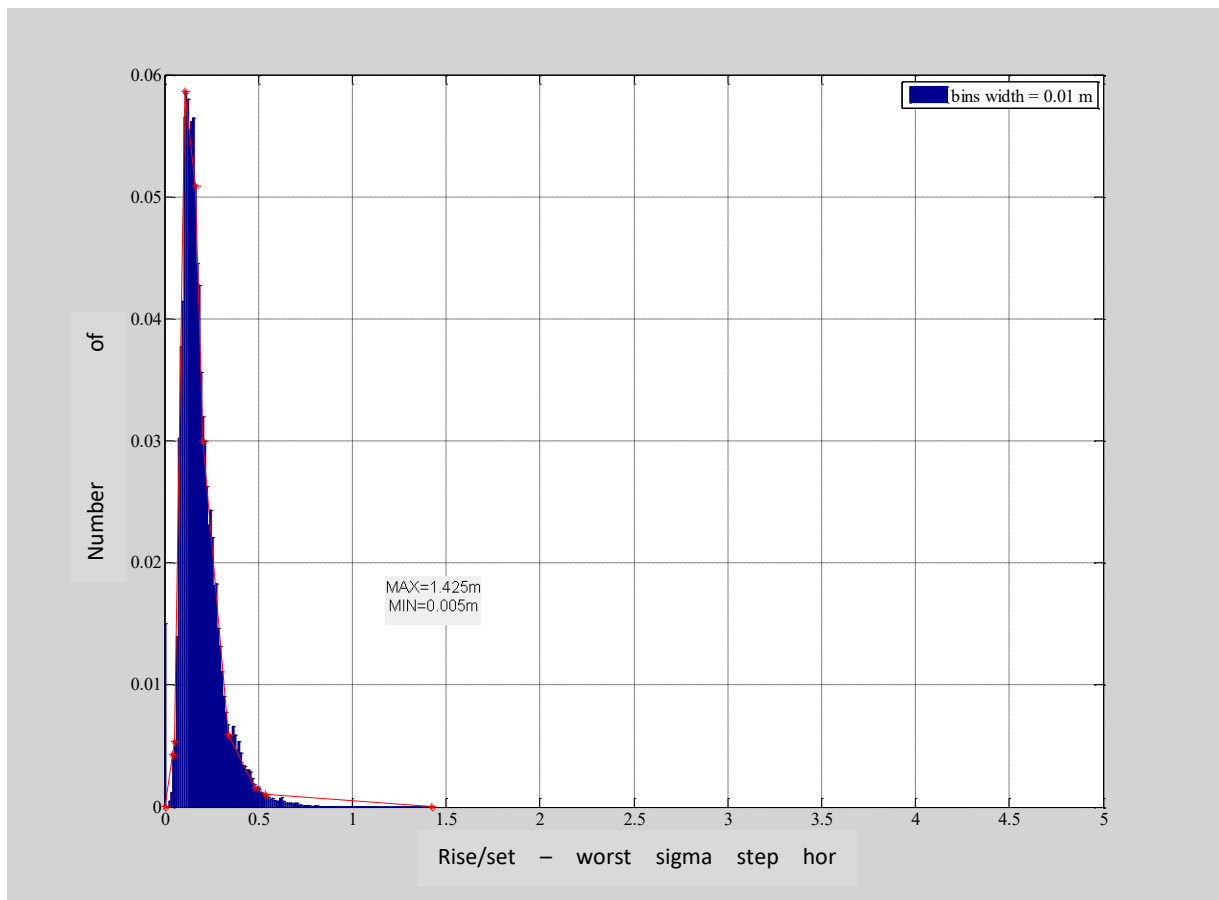

Figure 12: Rise/set worst step horizontal sigma samples

Rise/Set Worst Sigma_Step_Hor	Number of occurrences
0.005000000000000	0.000002897188944
0.041875996448845	0.004326488398194
0.054920944044943	0.005392271389607
0.109250543156205	0.058667264538146
0.163832898257929	0.050878995869548
0.205763067528231	0.030017730600579
0.339826367851692	0.005884118967452
0.481495931510671	0.001622467406624
0.537593983881708	0.001038030498786
1.425000000000000	0.000000090537154

4.9.6 Signal loss sigma step vertical

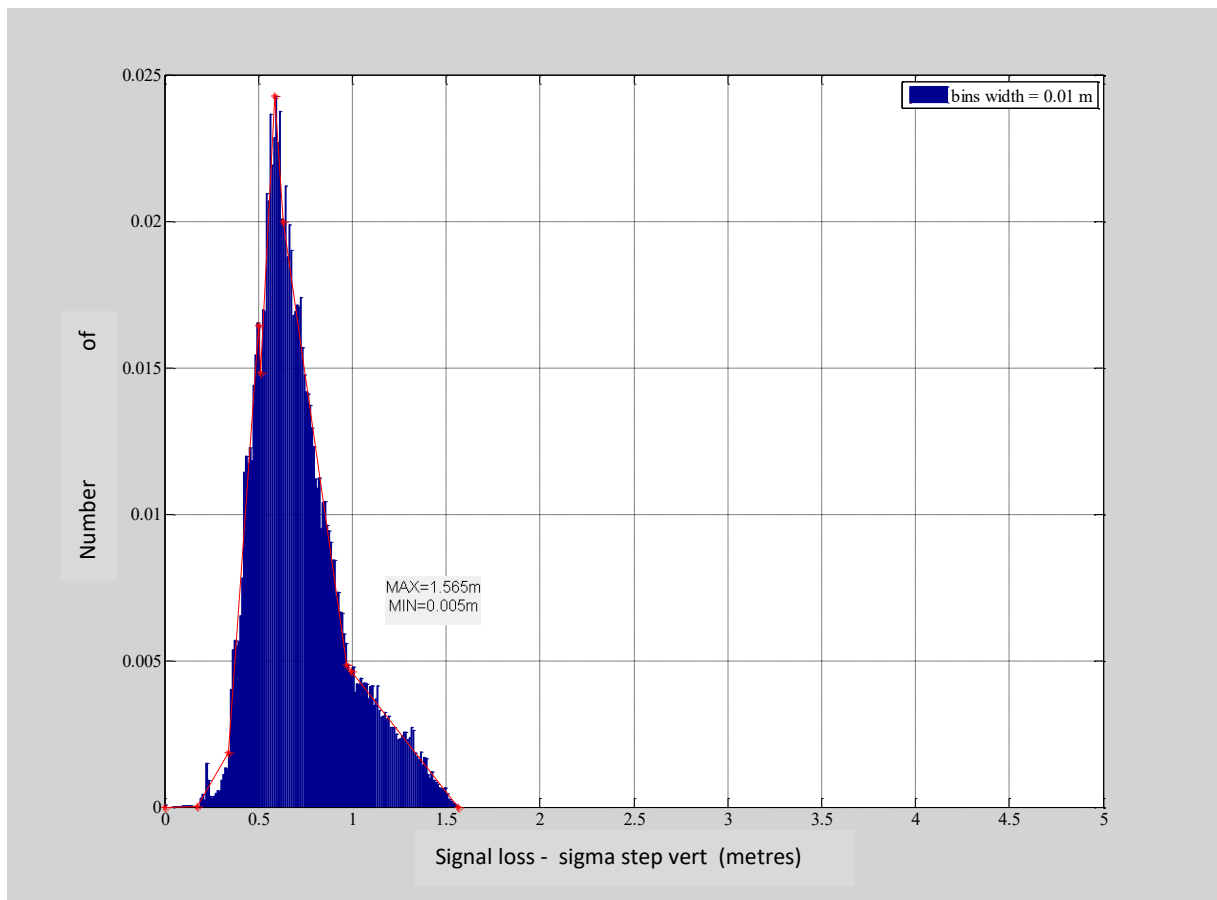

Figure 13: Signal loss sigma step vertical sigma samples

Signal loss Sigma_Step_Vert	Number of occurrences
0.0050000000000000	0
0.175788354389016	0.000006172962943
0.341225896607212	0.001849289916083
0.501345966346395	0.016428884464905
0.509272880272156	0.014817130740563
0.585415172749149	0.024277512141267
0.634728223925139	0.019985074857159
0.971964045257760	0.004855442265040
0.993665191757176	0.004618156897366
1.5650000000000000	0

4.9.7 Signal loss worst sigma step horizontal

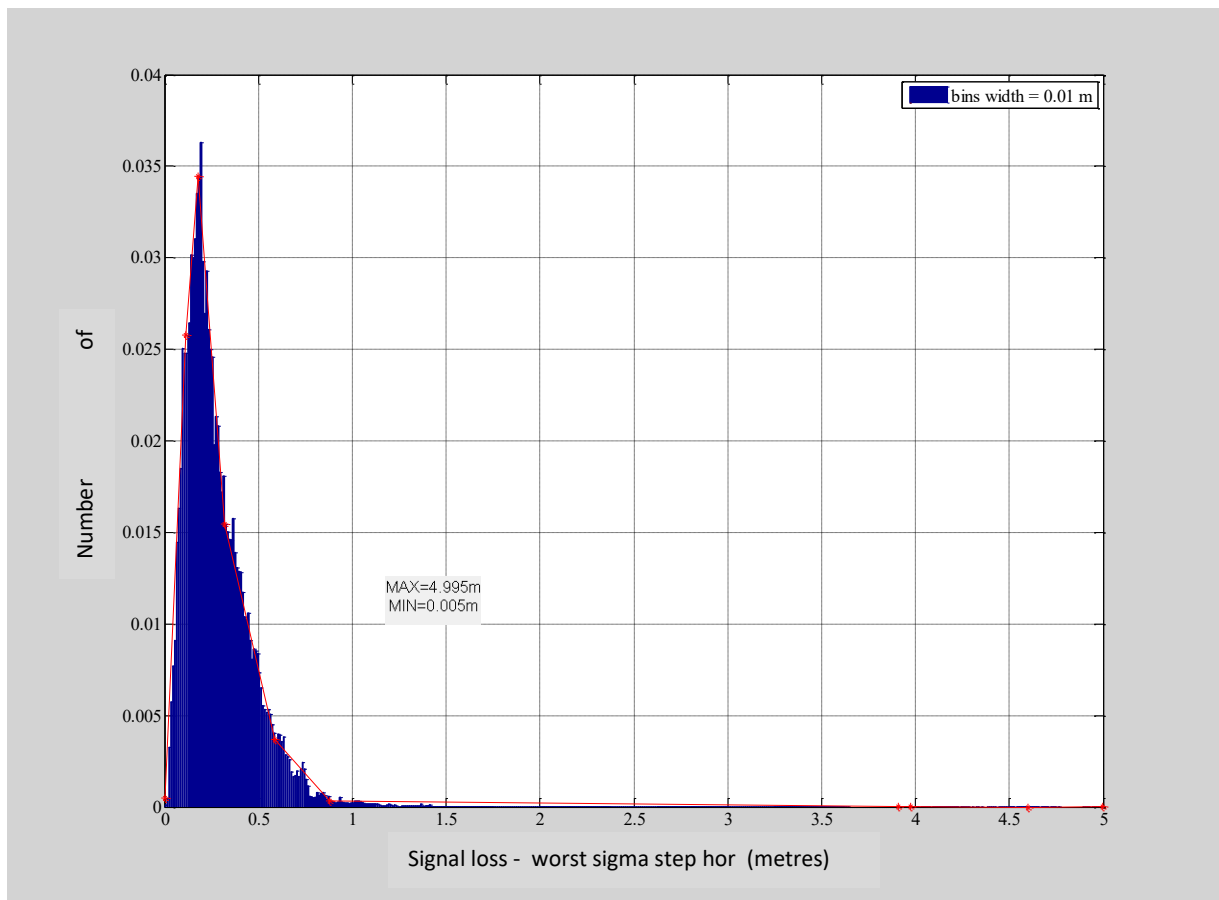

Figure 14: Signal loss worst sigma step horizontal sigma samples

---

Signal loss worst Sigma_Step_Hor	Number of occurrences
0.0050000000000000	0.000476007789371
0.115610839554299	0.025790440689983
0.180148721789614	0.034439075056633
0.320833114781513	0.015472307517217
0.586810140697307	0.003675003851236
0.880744610706960	0.000358424380494
3.908283843494504	0.000000000123437
3.975118428756177	0.000000000123437
4.601736622281720	0
4.9950000000000000	0.000000016910875



## Wind models for approach and landing simulation

### 1 Purpose

The purpose of this AMC is to provide acceptable wind models, turbulence and wind shear that can be used to demonstrate in simulation system performance in approach and landing.

### 2.1 Wind model number 1

#### 2.1.1 Mean wind

It may be assumed that the cumulative probability of reported mean wind speed at landing, and the crosswind component of that wind are as shown in Figure 15. Normally, the mean wind which is reported to the pilot, is measured at a height, which may be between 6 m (20 ft) and 10 m (33 ft) above the runway. The models of wind shear and turbulence given in paragraphs 3.2 and 3.3 assume this reference height is used.

#### 2.1.2 Wind shear

##### 2.1.2.1 Normal wind shear

Wind shear should be included in each simulated approach and landing unless its effect can be accounted for separately. The magnitude of the shear should be defined by the expression:

$$u = 0.43 U \log_{10}(z) + 0.57 U \quad (1)$$

where 'u' is the mean wind speed at height z metres ( $z \geq 1$  m) and 'U' is the mean wind speed at 10 m (33 ft).

##### 2.1.2.2 Abnormal wind shear

The effect of wind shears exceeding those of paragraph 2.1.2.1 should be investigated using known severe wind shear data.

#### 2.1.3 Turbulence

##### 2.1.3.1 Horizontal component of turbulence

It may be assumed that the longitudinal component (in the direction of mean wind) and lateral component of turbulence may each be represented by a Gaussian process having a spectrum of the form:

$$\Phi(\Omega) = \frac{2\sigma^2}{\pi} \frac{L}{1 + \Omega^2 L^2} \quad (2)$$

where:

$\Phi(\Omega)$  = a spectral density [[metres/sec]<sup>2</sup> per [radian/metre]].

$\sigma$  = root mean square (rms) turbulence intensity = 0.15 U.

L = scale length = 183 m (600 ft)

$\Omega$  = frequency [radians/metre].

##### 2.1.3.2 Vertical component of turbulence

It may be assumed that the vertical component of turbulence has a spectrum of the form defined by equation (2) in paragraph 3.1.3.1. The following values have been in use:

$\sigma$  = 2.8 km/h (15 kt) with L = 9.2 m (30 ft)

or alternatively

$\sigma = 0.09 U$  with  $L = 4.6 \text{ m (15 ft)}$  when  $z < 9.2 \text{ m (30 ft)}$

and  $L = 0.5 z$  when  $9.2 < z < 305 \text{ m (30 < z < 1 000 ft)}$

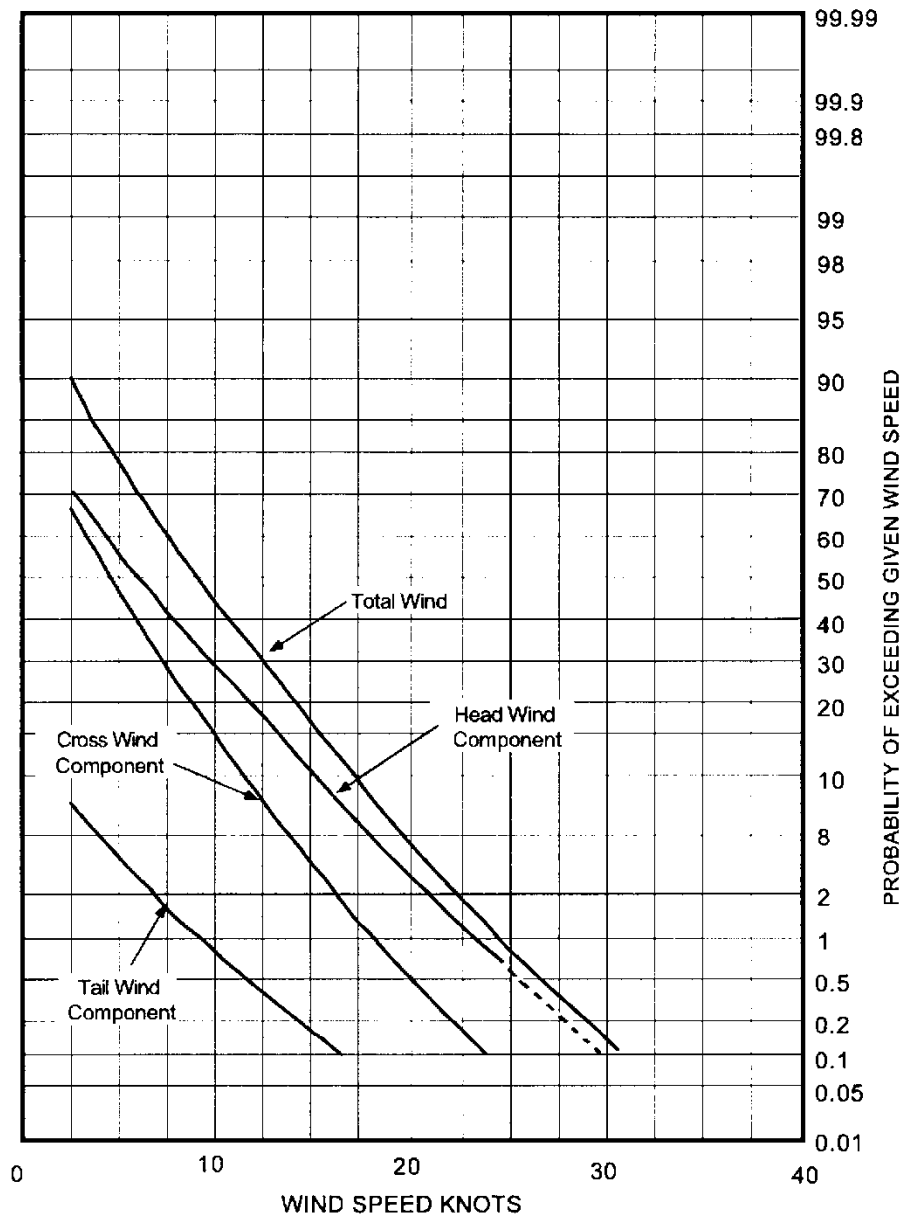

Figure 15: Cumulative probability of reported mean wind and headwind, tailwind and crosswind components when landing

NOTE: This data is based on worldwide in-service operations of UK airlines (sample size: about 2 000)

2.2 Wind model number 2

2.2.1 Mean wind

The mean wind is the steady state wind measured at landing. This mean wind is composed of a **downwind** component (headwind and tailwind) and a **crosswind** component. The cumulative probability distributions for these components are provided in Figure 16 (downwind) and Figure 17 (crosswind).

Alternatively, the mean wind can be defined with magnitude and direction. The cumulative probability for the mean wind magnitude is provided in Figure 18, and the histogram of the mean wind direction is provided in Figure 19. The mean wind is measured at a reference altitude of 20 ft above ground level (AGL). The models of the wind shear and turbulence given in Sections 2.2.2 and 2.2.3 assume this reference altitude of 20 ft AGL is used.

### 2.2.2 Wind shear

When stable and steady horizontal wind blows over the ground surface, terrain irregularities and obstacles such as trees and buildings alter the steady wind near the surface and a boundary layer will cause a form of windshear. The magnitude of this shear is defined by the following expression:

$$V_{wref} = 0.204 \cdot V_{20} \cdot \ln((h + 0.15)/0.15)$$

where  $V_{wref}$  is the mean wind speed measured at  $h$  ft and  $V_{20}$  is the mean wind speed (ft/sec) at 20 ft AGL.

Note: This expression does not represent the violent windshears created by unstable air mass conditions.

### 2.2.3 Turbulence

#### 2.2.3.1 Turbulence spectra

The turbulence spectra are of the Von Karman form.

The vertical component of turbulence (perpendicular to the earth's surface) has a spectrum of the form defined by the following equation:

$$\Phi_w(\Omega) = \frac{\sigma_w^2 L_w}{2\pi} \frac{1 + \frac{8}{3} (1.339 L_w \Omega)^2}{(1 + (1.339 L_w \Omega)^2)^{11/6}}$$

The horizontal component of turbulence (in the direction of the mean horizontal wind) has a spectrum of the form defined by the following equation:

$$\Phi_u(\Omega) = \frac{\sigma_u^2 L_u}{\pi} \frac{1}{(1 + (1.339 L_u \Omega)^2)^{5/6}}$$

The lateral component of turbulence (perpendicular to the mean horizontal wind) has a spectrum of the form defined by the following equation:

$$\Phi_v(\Omega) = \frac{\sigma_v^2 L_v}{2\pi} \frac{1 + \frac{8}{3} (1.339 L_v \Omega)^2}{(1 + (1.339 L_v \Omega)^2)^{11/6}}$$

where

$\Omega$  = spectral density [ft/sec]<sup>2</sup>

$\sigma$  = root mean square (rms) turbulence intensity [ft/sec]

$L$  = scale length

$\Omega$  = spatial frequency [radians/foot] =  $\omega/V_T$

$\omega$  = temporal frequency [radians/sec]

$V_T$  = aircraft speed [ft/sec]

2.2.3.2 Turbulence intensities and scale lengths

At or above an altitude  $h_1$ , turbulence is considered to be isotropic, i.e. the statistical properties of the turbulence components are independent. This means that one can consider the turbulence components to have equal intensities.

Below  $h_1$ , turbulence varies with altitude. In this case, intensity and scale length are expressed as functions of  $V_{20}$  (ft/sec) and altitude.

Turbulence intensities

$\sigma_W = 0.1061 V_{20}$

For  $h < h_1$ ,

$$\frac{\sigma_W}{\left(0.177 + \frac{0.823h}{h_1}\right)^{0.4}}$$

$\sigma_U = \sigma_V =$

For  $h \geq h_1$ ,

$\sigma_U = \sigma_V = \sigma_W$

where  $h_1 = 1\ 000$  ft

Scale lengths

For  $h < h_1$ ,

$L_W = h$

$L_U = L_V = L_W \left(\frac{\sigma_U}{\sigma_W}\right)^3 = \frac{h}{\left(0.177 + \frac{0.823h}{h_1}\right)^{1.2}}$

For  $h \geq h_1$

$L_W = L_U = L_V = h_1$

where  $h_1 = 1\ 000$  ft

2.2.3.3 Fixed turbulence intensities for pilot-in-the-loop simulations

The following fixed levels of turbulence intensity [ft/sec] have been found to be representative when used to programme low-altitude simulations with the pilot in the loop.

Turbulence intensity		Light	Medium	Heavy
$\sigma_u = \sigma_v$	2.5	5.0	8.3	
$\sigma_w$	1.25	2.5	4.17	

Turbulence scale lengths vary with altitude according to the equations of paragraph 2.2.3.2.

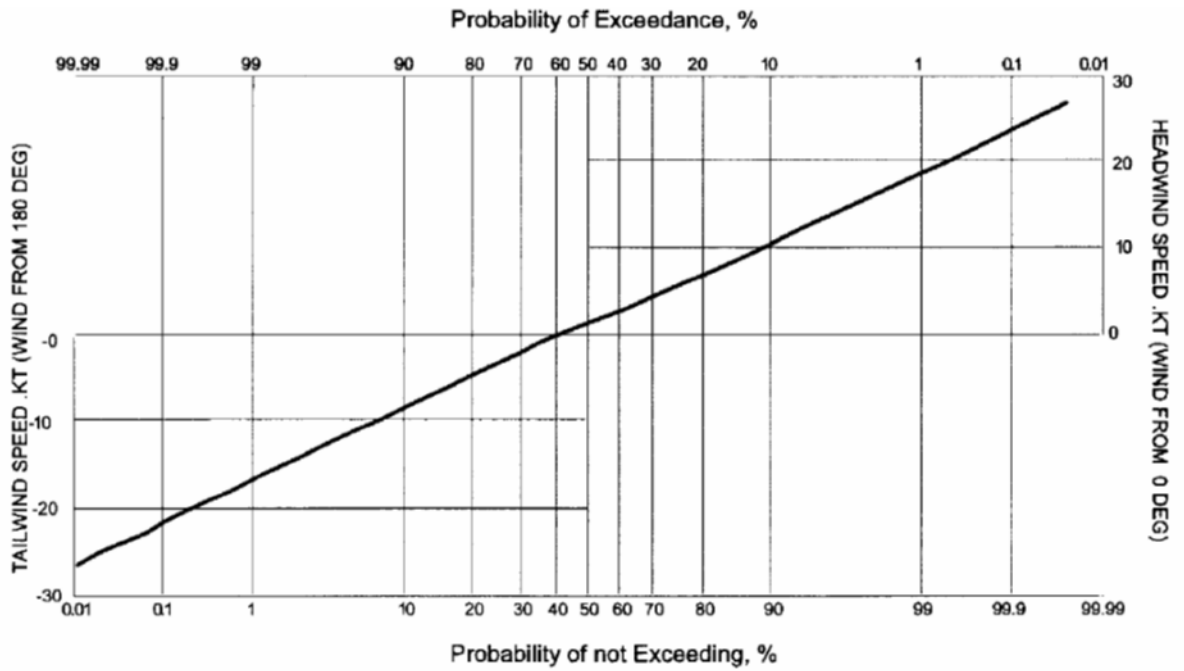

Figure 16: Headwind — tailwind description

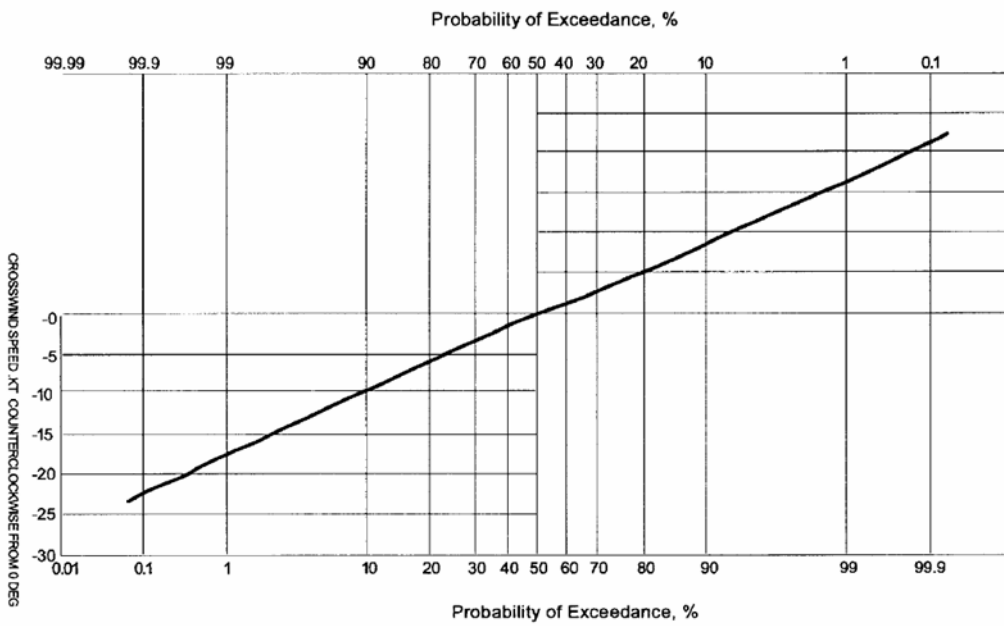

Figure 17: Crosswind description

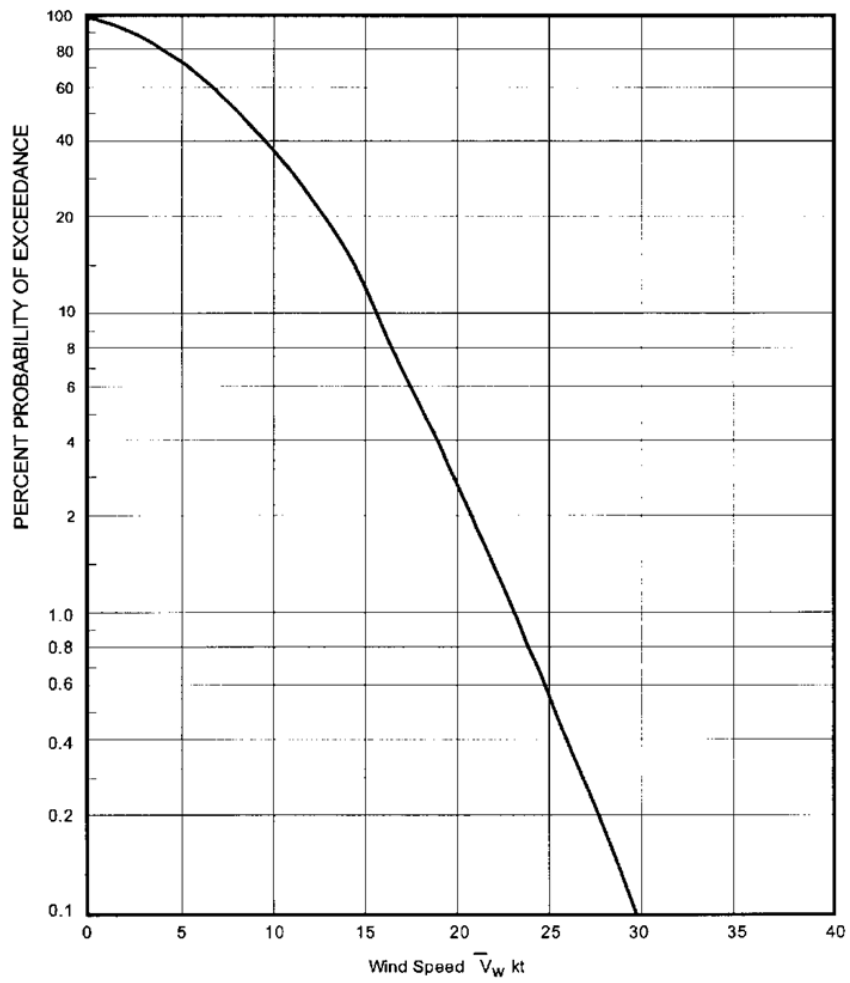

Figure 18: Annual percent probability of mean wind speed equalling or exceeding given values

**Wind direction histogram**

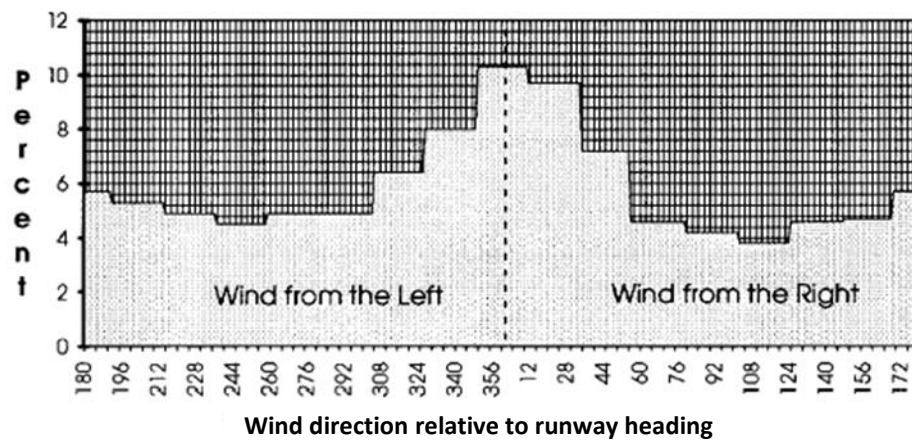

Figure 19: Histogram of the mean wind direction relative to runway heading

### 2.3. Wind model number 3

This wind model is a derivative of wind model number 2. The changes are a result of experience from pilot-in-the-loop simulator tests for Category 3 HUD certification, where the wind shear and turbulence intensities were found to be more representative.

The changes to wind model 2 are as follows:

(a) Para 2.2.2.

Change  $V_{wref} = 0.204 \times V_{20} \log n [(h+0.15) \div 0.15]$

to  $V_{wref} = 0.165 \times V_{20} \log n [(h + 0.046) \div 0.046]$

(b) Para 2.2.3.2.

Change  $\sigma_w = 0.1061 V_{20}$

to  $\sigma_w = 0.0625 V_{20}$

(c) Para 2.2.3.2.

Change

Lu to Lu = 600 ft

**SUBPART B — APPROACH AND LANDING**

**AMC TO SECTION 1**

**AIRWORTHINESS CERTIFICATION OF AEROPLANES FOR TYPE B OPERATIONS WITH DECISION HEIGHTS/ALTITUDES BELOW 250 FT DOWN TO 200 FT — CATEGORY 1 OPERATIONS (CAT I)**

**GENERAL**

**AMC AWO.B.CATI.101**

Book 2 of CS-25 provides the acceptable means of compliance for an aeroplane to be eligible to perform xLS approaches down to a DH of 60 m (200 ft).



**AMC TO SECTION 2****AIRWORTHINESS CERTIFICATION OF AEROPLANES FOR OPERATIONS WITH DECISION HEIGHTS BELOW 60 M (200 FT) AND DOWN TO 45 M (150 FT) — SPECIAL AUTHORISATION CATEGORY 1 OPERATIONS (SA CAT I)****AMC AWO.B.SACATI.101(a) Applicability and terminology**

An aeroplane with a basic airworthiness approval for IFR operations is eligible to perform ILS (or equivalent) precision approaches down to a DH of 60 m (200 ft), assuming that the necessary navigation receiver(s) and instruments and their installation have been approved. The purpose of this Section is to specify the supplementary airworthiness requirements for the performance of approaches on authorised Category 1 ILS (or equivalent) runways with DHs below 60 m (200 ft) down to 45 m (150 ft). Authorised runway criteria include ILS (or equivalent) beam suitability for the operation and pre-threshold terrain compatibility with the use of a radio altimeter (or other device capable of providing equivalent performance and integrity level) at a DH of 45 m (150 ft).

Terminology

- (a) The term ‘approach system’ refers only to the airborne system. It includes the equipment listed in [AMC AWO.B.SACATI.111](#) and all related sensors, instruments and power supplies.
- (b) ‘Decision height (DH)’ is the wheel height above the runway elevation by which a go-around must be initiated unless adequate visual reference has been established and the aircraft position and approach path have been visually assessed as satisfactory to continue the approach and landing in safety. Where it is used in this Section, it means the minimum DH at which compliance with the requirements of this Section have been demonstrated.
- (c) A ‘go-around’ is the transition from an approach to a stabilised climb.
- (d) ‘Failure condition’ and terms describing the probabilities and effects of failure conditions are defined in [AMC 25.1309](#).
- (e) The terms ‘localiser’, ‘glide path’ and ‘beam’ have been retained for use with either ILS or equivalent.
- (f) ‘ILS or equivalent’ is understood as ILS, MLS and GLS. It may include GNSS approaches if they demonstrate the same global level of precision, integrity and continuity as an ILS CAT II operation with a DH of 150 ft.
- (g) ‘HUD or equivalent’ is understood as HUD or head-worn display (HWD).

Guidance on controls, indicators and alerts that are associated with installations that incorporate more than one type of approach system can be found in [AMC AWO.A.ALS.110](#).

System concept

The principle of SA CAT I operations is to provide a lower DH than the standard CAT I operation by mitigating ILS category 1 beam and reduced runway lighting by additional approach system requirements. These requirements intend to compensate for lower accuracy, integrity and time to alert of category 1 beams compared to those of category 2 beams, and provide assistance to acquire the visual cues required to complete the landing with reduced lighting.

Systems that have shown or can demonstrate compliance with CS-AWO [Subpart B — Section 3](#) (CAT II) are considered to be eligible for SA CAT I operations if they are demonstrated to be safely used in a CAT I environment. Other systems can be considered if suitable justification and mitigation means can be provided.

Due to low-visibility procedures being required to be in place for SA CAT I operations, the following non-exhaustive list of approach systems may be considered for SA CAT I operation:

- (a) HUD (or equivalent) with flight guidance which is approved for ILS (or equivalent) manual operation down to 36 m (120 ft).
- (b) SVGS, as a combination of a synthetic vision system (SVS) and flight guidance based on ILS (or equivalent) displayed on the primary flight display or HUD (or equivalent), and high-precision position assurance monitoring.
- (c) Automatic approach system coupled down to 36 m (120 ft) with a HUD (or equivalent) to ease manual transition at the DH, thanks to the control of the FPV in the visual segment.
- (d) Automatic landing system alone, provided it is demonstrated that failures linked to category 1 beam can be recognised by pilot in low-visibility conditions.
- (e) visibility conditions.
- (f) Automatic landing system with a HUD (or equivalent) to monitor the autoland path along the category 1 beam before and after the DH.

#### **AMC AWO.B.SACATI.102 Safety level**

In showing compliance with the performance and failure requirements, the probabilities of performance or failure effects should not be factored by the proportion of approaches, which are made with the DH below 60 m (200 ft).

#### **AMC AWO.B.SACATI.103 Go-around rate**

On the assumption that system failures will not significantly reduce the success rate, compliance with this provision may be demonstrated by means of the continuous method of [AMC AWO.B.CATII.113](#) using the following interpretation:

- (a) A localiser excess deviation alert will occur between 90 m (300 ft) and 45 m (150 ft) in no more than 5 % of the approaches.
- (b) A glide path excess deviation alert will occur between 90 m (300 ft) and 45 m (150 ft) in no more than 5 % of the approaches.

#### **AMC AWO.B.SACATI.107 Manual control**

A change in the means of control is considered to be a change from the automatic to manual control.

#### **AMC AWO.B.SACATI.111 Installed equipment**

- (a) ILS and MLS airborne equipment standards

Acceptable standards for airborne receiver equipment include:

- (1) Localiser receivers complying with the minimum performance standards of EUROCAE ED-46B or later revision, or an equivalent standard, and glide path receivers complying with the minimum performance standards of EUROCAE ED-47A or RTCA DO-192 or later revision.

Note: The aforementioned localiser specifications are in accordance with the FM Broadcast Interference Immunity requirements of ICAO Annex 10, Volume I, Chapter 3, and paragraph 3.1.4.

- (2) MLS receivers complying with the minimum performance standards of EUROCAE ED-36A or later revision, or an equivalent standard, and DME/P or DME/N transceivers complying with the minimum performance standards of EUROCAE ED-54 or RTCA DO-189.
- (3) Combined ILS/MLS receivers complying with the minimum performance standards of EUROCAE ED-74 or equivalent standard.
- (4) Combined ILS/MLS/GPS receivers complying with the minimum performance standards of EUROCAE ED-88 or equivalent standard.

(b) Flight guidance system

Potentially acceptable flight guidance systems for SA CAT I include:

- (1) HUD (or equivalent) with flight guidance complying with CS-AWO Subpart A, Section 2 and Subpart B, Section 3.
- (2) SVGS complying with CS-AWO Subpart A, Section 4.
- (3) Automatic approach system complying with CS-AWO Subpart A, Section 1, with a HUD (or equivalent) complying with AMC 25.11, to help flight path monitoring and control after the DH.
- (4) Automatic landing system complying with CS-AWO Subpart A, Section 1 with ILS CAT 1 beam model, and CS-AWO Subpart B, Section 3.
- (5) Automatic landing system as defined in (4) with a HUD (or equivalent) complying with AMC 25-11 to help flight path monitoring before and after the DH.
- (6) Any other flight guidance system that can demonstrate the required performance of Subpart B, Section 2.

(c) Radio altimeter equipment standard

The airborne equipment used to provide height above terrain may be a radio altimeter complying with the minimum performance standards of EUROCAE ED-30 or RTCA DO-155. Alternatively, another device capable of providing equivalent performance and integrity level may be used.

**AMC AWO.B.SACATI.113 Flight demonstration**

Refer to [AMC AWO.B.CATII.113](#) for AMC for performance demonstration of SA CAT I.

In addition to [AMC AWO.B.CATII.113](#), for novel or new combinations of navigation means and visual displays/cues, it should be demonstrated that it is possible to successfully and safely land the aircraft after the DA/H using the selected navigation means and visual displays/cues. This could be achieved by a proof of concept demonstration in representative weather and visual conditions in at least a simulated environment.

**AMC AWO.B.SACATI.117 Mode selection and switching**

If a transition from automatic mode to manual control is required by the approach system, it should be demonstrated that this transition can be made without excessive workload in the actual visual references available on a SA CAT I (or equivalent type sought) runway.

If the demonstration is to be performed with a simulator, the simulator should be:

- (a) equipped with a visual system that provides an acceptable representation of the actual visibility conditions for which operational approval is sought; and
- (b) suitably validated by flight test demonstrations for the intended operation.

**AMC AWO.B.SACATI.119 Failure conditions**

In compliance with CS 25.1309 and CS 25.1329, failures of the flight guidance system, including on-board navigation receivers, which would require pilot recognition in relation with external references required by AMC5 SPA.LVO.105(c) point (d), should be demonstrated in the actual visual references available on a SA CAT I (or equivalent type sought) runway (See [CS AWO.B.SACATI.117](#)).

**AMC AWO.B.SACATI.120 xLS navigation means (including signal-in-space) failure**

The effect of detected and undetected failures of the navigation means (including signal in space) intended to be used for the operation should be considered. The guidance of this Section is intended to address non-aircraft system errors. Due to LVPs being in place for SA CAT I operations, the effects of interruption or disturbance of the ground navigation means by surface movement in sensitive or critical aerodrome areas does not need to be considered.

A description of the possible fault modes of navigation means (including signal in space) that are derived from ICAO Annex 10 Volume I can be found in [Appendix 1 to AMC to Subpart A](#). It includes a description of detected failures and the probability of undetected failures. In the demonstration, credit may be taken for the ground subsystem's probability of undetected failures.

Note: Detected localiser and glide (or equivalent) threshold and time to alert and probability of undetected failures depend on the class of the navigation means. Demonstration made for CAT II/III system may not be applicable for lower-class navigation means.

Navigation means (including signal-in-space) failures which would require pilot recognition in relation with external references (required by AMC5.SPA.LVO.105(c) point (d), should be demonstrated in the actual visual references available on a SA CAT I (or equivalent type sought) runway. (See [CS AWO.B.SACATI.117](#))

Navigation means (including signal-in-space) should ensure a minimum vertical clearance of 1 m (3 ft) from the obstacle clearance surface including height loss during the missed approach if applicable in the event of a failure (detected or undetected). If crew action is required to trigger a missed approach procedure, a standard delay of 1 s should be considered after crew detection. Probability of exceeding the 1 m (3 ft) clearance from the obstacle clearance surface due to navigation means shall be demonstrated lower than  $10^{-7}$  per approach. In addition, if automatic landing is provided, it should be demonstrated that the probability of landing outside the limits that define a safe landing due to navigation means is lower than  $10^{-7}$ .

The effect of the probability of failure of the navigation means (including signal in space) should be considered and the effect on the go-around rate should be investigated.

**AMC TO SECTION 3****AIRWORTHINESS CERTIFICATION OF AEROPLANES FOR OPERATIONS WITH DECISION HEIGHTS  
BELOW 60 M (200 FT) AND DOWN TO 30 M (100 FT) — CATEGORY 2 OPERATIONS (CAT II)****AMC AWO.B.CATII.101(a) Applicability and terminology**

A precision approach system as defined in ICAO Annex 10 is considered to be an xLS (ILS, MLS, or GLS) which has outputs indicating the magnitude and sense of deviation from a preset azimuth and elevation angle giving equivalent operational characteristics to those of a conventional ILS.

An aeroplane with a basic airworthiness approval for IFR operations is eligible to perform xLS ~~ILS or MLS~~ precision approaches down to a ~~decision height~~ DH of 60 m (200 ft), assuming that the necessary xLS ~~ILS/MLS~~ receiver(s) and instruments and their installation have been approved. The purpose of **Subpart B Section 3** is to specify the supplementary airworthiness requirements for the performance of xLS ~~ILS or~~ MLS approaches with ~~decision height~~ DHs below 60 m (200 ft) down to 30 m (100 ft). This material may not be appropriate to for other precision approach aids.

**Terminology**

- (a) The term 'approach system' used here refers only to the airborne system. It includes the equipment listed in [CS AWO.B.CATII.111](#) and all related sensors, instruments and power supplies.
- (b) 'DH' is the wheel height above the runway elevation by which a go-around must be initiated unless adequate visual reference has been established and the aircraft position and approach path have been visually assessed as satisfactory to continue the approach and landing in safety. Where it is used in **Section 3**, it means the minimum DH at which compliance with the requirements of **Section 3** has been demonstrated.
- (c) A 'go-around' is the transition from an approach to a stabilised climb.
- (d) 'Failure condition' and terms describing the probabilities and effects of failure conditions are defined in [AMC 25.1309](#).

The terms 'localiser' and 'glide path' have been retained for use with either ILS, ~~or~~ MLS or GLS.

Cross reference is made in this Subpart to [AMC AWO.A.ALS.110](#) which provides guidance on controls, indicators and ~~warnings~~ alerts associated with installations incorporating more than one type of approach system (e.g. ILS and MLS ~~and/or~~ GLS).

**AMC AWO.B.CATII.102 Safety level**

In showing compliance with the performance and failure requirements, the probabilities of performance or failure effects should not be factored by the proportion of approaches, which are made with the ~~decision height~~ DH below 60 m (200 ft).

**AMC AWO.B.CATII.103 Go-around rate**

On the assumption that system failures will not significantly reduce the success rate, compliance with this ~~requirement~~ provision may be demonstrated by means of the continuous method of [AMC AWO.B.CATII.113](#) using the following interpretation:

- (a) ~~On no more than 5 % of approaches will~~ A localiser excess deviation alert ~~will~~ occur between 90 m (300 ft) and 30 m (100 ft) ~~in no more than 5% of approaches.~~
- (b) ~~On no more than 5 % of approaches will~~ A glide path excess deviation alert ~~will~~ occur between 90 m (300 ft) and 30 m (100 ft) ~~in no more than 5% of approaches.~~

**AMC AWO.B.CATII.107 Manual control**

A change in the means of control is considered to be a change from the automatic to manual control.

**AMC AWO.B.CATII.111 Installed equipment**

- (a) ~~ILS and MLS~~ xLS airborne equipment standards

Acceptable standards for airborne receiver equipment include:

- (1) Localiser receivers complying with the minimum performance standards of EUROCAE ED-46B or later revision, or an equivalent standard, and glide path receivers complying with the minimum performance standards of EUROCAE ED-47A or RTCA DO-192 or later revision.

Note: The aforementioned localiser specifications are in accordance with the FM Broadcast Interference Immunity requirements of ICAO Annex 10, Volume I, Chapter 3, and paragraph 3.1.4.

- (2) MLS receivers complying with the minimum performance standards of EUROCAE ED-36A or later revision, or an equivalent standard, and DME/P or DME/N transceivers complying with the minimum performance standards of EUROCAE ED-54 or RTCA DO-189.
- (3) Combined ILS/MLS receivers complying with the minimum performance standards of EUROCAE ED-74 or equivalent standard.
- (4) Combined ILS/MLS/GPS receivers complying with the minimum performance standards of EUROCAE ED-88 or equivalent standard.
- (5) ~~Combined ILS/MLS/GPS/GLS receivers, or combined ILS/GPS/GLS receivers, complying with the minimum performance standards of EUROCAE ED-88, RTCA DO-246E, and RTCA DO-253D, or equivalent standards.~~

- (b) Radio altimeter equipment standard

The airborne equipment used to provide height above terrain may be a radio altimeter complying with the minimum performance standards of EUROCAE ED-30 or RTCA DO-155. ~~Alternatively, another device capable of providing equivalent performance and integrity level may be used.~~

**AMC AWO.B.CATII.112 Minimum equipment**

~~One xLS receiver may be unserviceable if it is justified by an SSA.~~

**AMC AWO.B.CATII.113 Flight demonstration**

- 1 Flight path control

Compliance with ~~AWO-231~~ [CS AWO.B.CATII.113](#) may be shown by a flight test programme covering a representative range of weight, ~~centre of gravity~~ ~~CofG~~ position, ~~ILS and/or MLS ground facility characteristics,~~ aeroplane configurations and wind speed. At least three ILS ground facilities

and/or at least two MLS/GLS ground facilities should be used with an approximately equal number of approaches to each. The aeroplane and its equipment should be representative of the production standard in relevant areas. For handflown approaches conducted using a flight director displayed on a HUD, at least three different pilots flying should be used with the total number of approaches flown being approximately evenly divided among them.

Since it is not economically possible to make a large number of approaches to show compliance with [AMC AWO.B.CATII.113](#), it is necessary to impose a confidence level on the results of the programme. A confidence level of 90 % has been selected to allow a reasonable number of approaches. Two methods of demonstrating compliance are given: the 'continuous method' and the 'pass or fail method'. The mathematical derivation of these two methods is given in [Appendix 1 to AMC AWO.B.CATII.113](#).

### 1.1 Continuous method (analysis of maximum value)

If this method is used, a minimum of 30 approaches should be made to provide an adequate sample. If more than one type of precision approach system is installed, approximately equal numbers of approaches should be carried out for each type of approach system being certified. The maximum glide path and localiser deviations occurring between 90 m (300 ft) and 30 m (100 ft) should be recorded using test instrumentation and the results analysed in one of the following two ways.

#### 1.1.1 Numerical analysis

a. Calculate  $\lambda = \sqrt{\frac{1}{2n} \sum_{i=1}^n (x_i)^2}$

where:  $x_i$  is the maximum glide path (or localiser) deviation recorded between 90 m (300 ft) and 30 m (100 ft) on the approach, and  $n$  is the number of approaches.

b. Calculate  $\alpha = \frac{x_0}{\lambda} \sqrt{1 - \left(\frac{1.28}{\sqrt{n}}\right)^2}$

where  $x_0$  is the excess deviation alert setting

c. Calculate the probability of success,  $P(\alpha)$ , where:

:

$$P(\alpha) = 100 \left( 1 - e^{-\alpha^2} \right)$$

If  $P(\alpha)$  is 95 % or more, the aeroplane meets the criteria with the required levels of confidence.



### 1.1.2 Graphical analysis

This is essentially the same as the numerical analysis but it allows inspection of the results as the programme progresses so as to give an early indication of the likelihood of success.

- a. Calculate  $\sum_{i=1}^n (x_i)^2$  as the programme progresses

and plot the result against the number of approaches completed on Figure 1.

Note: Figure 1 is based on excessive glideslope and localiser deviation thresholds of 75  $\mu$ A and 25  $\mu$ A, respectively, as specified in [AMC AWO.B.CATII.115\(a\)](#). If lower thresholds are used, Figure 1 should be amended using the method specified in [Appendix 1 to AMC AWO.B.CATII.113](#), paragraph 3, 'Graphical analysis'.

- b. When the plotted line enters the 'pass' region, the programme may be stopped.

### 1.2 Pass or fail method

This method is suitable for use when it is not practicable to install recording equipment. A total of at least 46 successful approaches are necessary to pass this method. If more than one type of precision approach system is installed, approximately equal numbers of approaches should be carried out for each type of approach system being ~~certified~~ ~~certificated~~. Each approach is made using category 2 procedures and a record is kept of any unsatisfactory approaches due to ~~ILS or MLS~~ ~~xLS~~ tracking performance or airborne system malfunctions. The success of the programme is judged against the criterion shown in Figure 2.

### 1.3 Numerical analysis by simulation

This method is suitable for use when a simulation has been demonstrated valid by flight tests (i.e. simulation tools to demonstrated CAT III automatic landing as per [AMC AWO.A.ALS.106](#)).

The numerical analysis method proposed in paragraph 1.1 can be used provided that:

- deviation is computed from aircraft position to intended flight path;
- signal-in-space model use for simulation is representative of the elected navigation means for the operation. Signal-in-space models representative of navigation means can be found in [Appendix 1 to AMC to Subpart A](#); and
- Wind models used for simulation are representative. Acceptable representative wind models can be found in [Appendix 1 to AMC to Subpart A](#).

### 2 Speed control

Where an automatic throttle is used, airspeed should be recorded and shown to remain within  $\pm 9.3$  Km/h ( $\pm 5$  kt) of the intended value, disregarding rapid fluctuations due to turbulence.

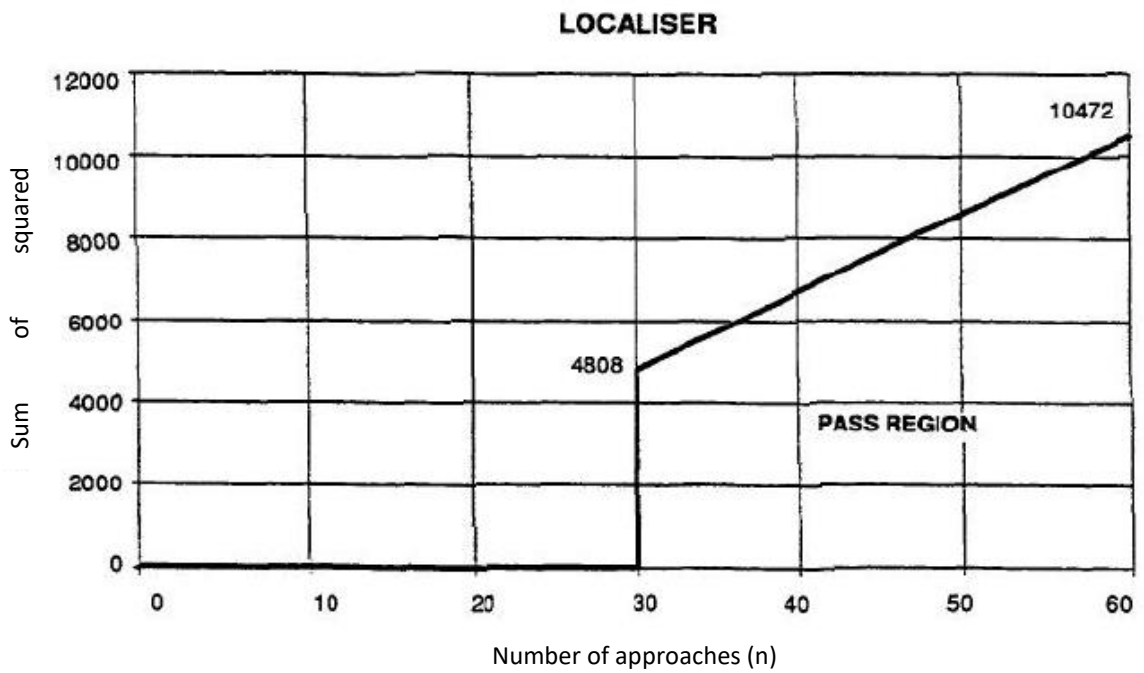
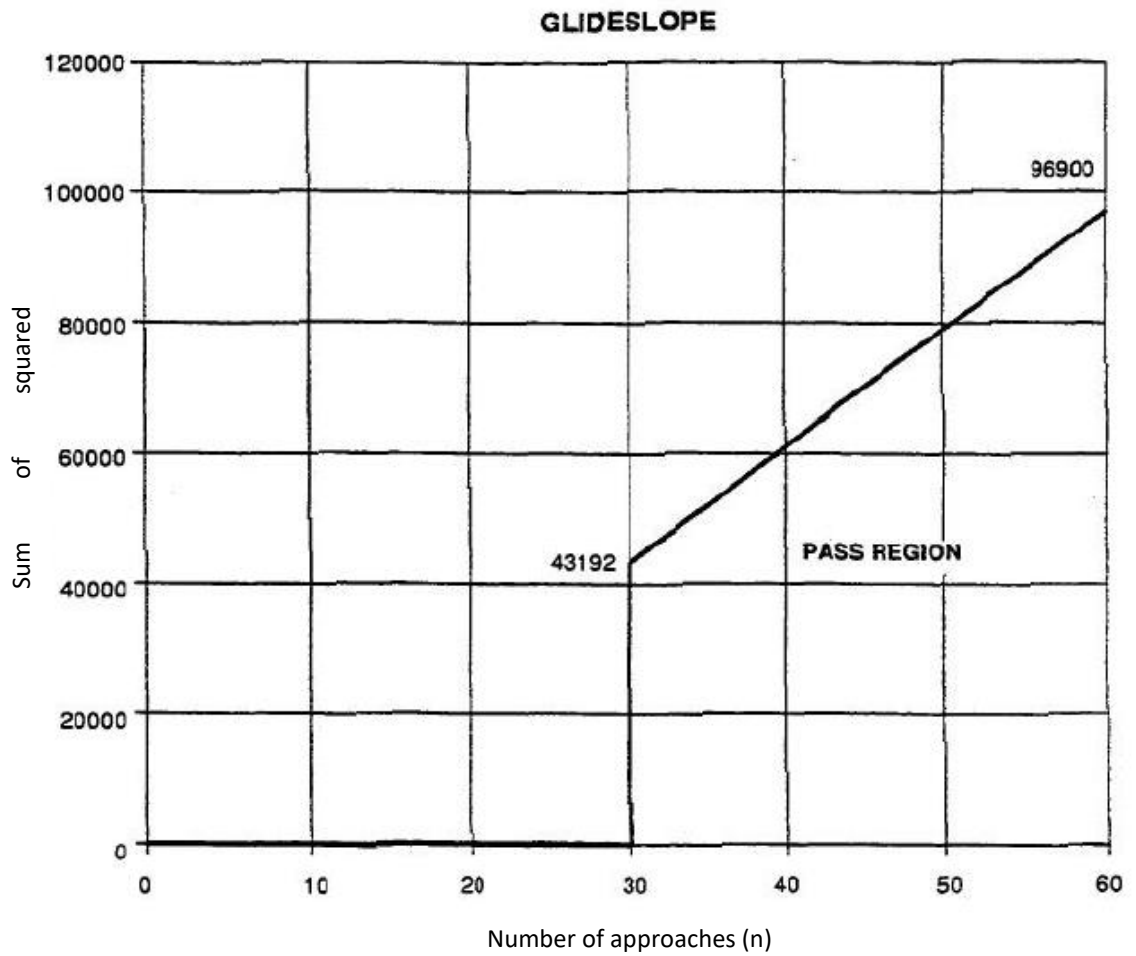
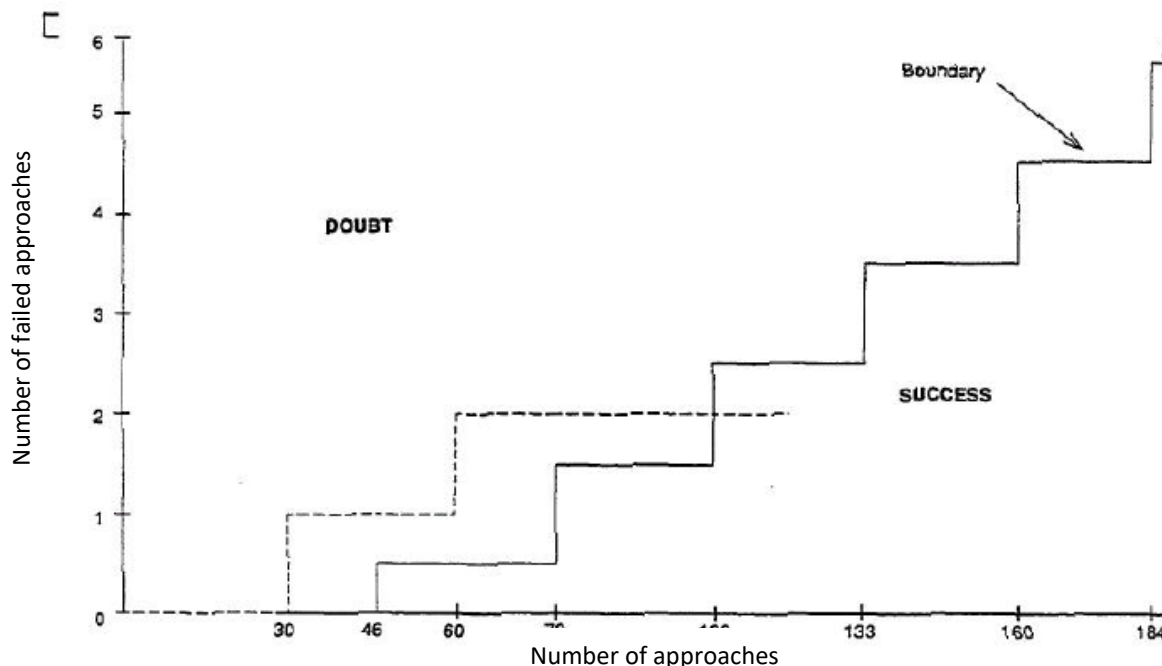

Figure 1: Graphical analysis



The dashed line illustrates achieved progress with failures on approaches 30 and 60.

**Figure 2: Pass or fail method**

#### **AMC AWO.B.CATII.115(a) Excess-deviation alerts**

The excess deviation alerts should be set to operate when the xLS HLS or MLS deviation exceeds not more than:

- 75  $\mu$ A for the glide path; and
- 25  $\mu$ A for the localiser.

#### **AMC AWO.B.CATII.122 Aeroplane flight manual**

The AFM may contain a statement to the effect that the categories of xLS navigation means which have been used as the basis for certification should not be taken as a limitation. In that case, the AFM should also contain a statement that some CAT I xLS navigation means may not be suitable for use by the approach system.

## APPENDIX 1 TO AMC AWO.B.CATII.113

Category 2 ~~xLS ILS and MLS~~ tracking performance

## 1 Introduction

[AMC AWO.B.CATII.113](#) gives acceptable methods of demonstrating acceptable ~~xLS ILS and/or MLS~~ tracking performance. This appendix gives the mathematical derivation of these methods.

## 2 Numerical analysis

The maximum glide path or localiser deviation recorded during an ILS or MLS approach will vary from one approach to another and may be treated as a statistical variable. If it is assumed that the glideslope and localiser deviations recorded during an ILS or MLS approach have a normal distribution with mean zero, then it can be shown that the maximum deviations (ignoring the sign of the maximum value) during a certain approach interval follow a Rayleigh distribution of the form:

$$P(x) = \frac{x}{\lambda_0^2} e^{-\frac{1}{2} \left( \frac{x}{\lambda_0} \right)^2}$$

where  $x$  is the maximum glideslope or localiser deviation and  $\lambda_0$  is the scale parameter of the Rayleigh distribution function.

It follows that the probability of recording a maximum deviation less than some specified value  $x_0$  is:

$$P(x_0) = \int_0^{x_0} P(x) dx = 1 - e^{-\frac{1}{2} \left( \frac{x_0}{\lambda_0} \right)^2}$$

It can be shown that:

$$\lambda_0^2 = \frac{1}{2} \int_0^x x^2 P(x) dx$$

and, to a good approximation:

$$\lambda^2 = \frac{1}{2n} \sum_{i=1}^n (x_i)^2$$

where  $n$  is the number of approaches and  $x_i$  the maximum deviation recorded on each approach.

If large numbers of approaches were made,  $\lambda_0$  could be calculated and used to find the probability that the maximum ILS and/or MLS deviation will not exceed the excess deviation alert setting. For example, if:

$$\lambda_0^2 = \frac{1}{2n} \sum_{i=1}^n (x_i)^2 = 625$$

and the excess deviation alert setting is 75  $\mu\text{A}$ , then:

$$\frac{x_0}{\lambda_0} = 3.0$$

and

$$P(x_0) = 98.9\%$$

However, it is not economically practicable to make large numbers of approaches and the effects of small sample sizes should be considered. The usual method of doing so is to impose a confidence level (in this case, 90 %) on the results of the measured sample.

If values of  $\lambda^2$  are calculated from a number of samples, sampling theory shows that they will be normally distributed with a mean value  $\lambda_0^2$  and a standard deviation of where  $n$  is the number of approaches in each sample.

$$\frac{\lambda_0^2}{\sqrt{n}}$$

Parameter  $\mu = \frac{(\lambda^2 - \lambda_0^2) \sqrt{n}}{\lambda_0^2}$  is normally distributed with a mean value 0 and a standard deviation 1.

The probability (or confidence level) that a value of  $\mu$  is greater (or smaller) than a certain value is given by the probability distribution function of the normal distribution N (0,1):

$$P(\mu > -\mu_1) = P(\mu < \mu_1) = \tau = \frac{1}{\sqrt{2\pi}} \int_{-\infty}^{\mu_1} e^{-\frac{\mu^2}{2}} d\mu$$

Figure A1–1 shows numerical solutions of this integral, in percentages of the integral from  $-\infty$  to  $\infty$ , representing one-sided exceedance probabilities (or confidence levels)  $\tau$  for a range of  $\mu_1$  values.

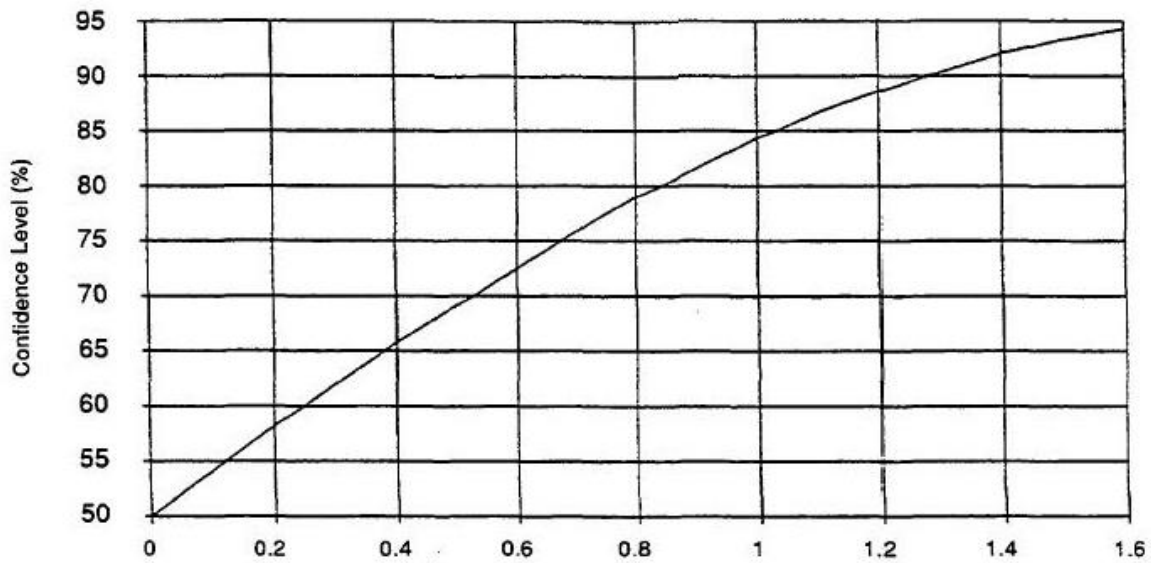

Figure A1-1: Confidence level

From this figure, it can be seen that for  $\tau = 90\%$ ,  $\mu_1 = 1.28$ .

Thus, there is a given level of confidence  $\tau$  that:

$$\mu = \left( \frac{\lambda^2 - \lambda_0^2}{\lambda_0^2} \right) \sqrt{n} > -\mu_1$$

from which  $\lambda_0^2 < \frac{\lambda^2}{1 - \frac{\mu_1}{\sqrt{n}}}$

The value of  $\lambda^2$  for the sample is, as shown earlier:

$$\lambda^2 = \frac{1}{2n} \sum_{i=1}^n (x_i)^2$$

Hence, the maximum value of  $\lambda_0$  can be calculated, followed by the minimum value of

$$\alpha = x_0 \sqrt{\frac{1 - \frac{\mu_1}{\sqrt{n}}}{\lambda^2}}$$

where, as before,  $x_0$  is the excess deviation alert setting.

The minimum probability of not exceeding the excess deviation alert setting is found by using the probability equation:

$$P(\alpha) = 100 \left( 1 - e^{-\frac{\alpha^2}{2}} \right)$$

### 3 Graphical analysis

As before, the distribution of the maximum deviation on an approach is assumed to be such that the probability that it is less than a value  $x_0$  is given by:

$$P(x_0) = 1 - e^{-\frac{1}{2} \left( \frac{x_0}{\lambda_0} \right)^2}$$

From this equation, given that the required probability is 95 %, the value of can be calculated as:

$$\frac{x_0}{\lambda_0} = 2.4477$$

The limiting deviations ( $x_0$ ) are the excess deviation alert settings; 75  $\mu$ A for the glide path and 25  $\mu$ A for the localiser. Hence:

$$\lambda_0 = 30.64 \text{ for the glide path}$$

$$\lambda_0 = 10.21 \text{ for the localiser}$$

As given earlier:

$$\lambda = \sqrt{\frac{1}{2n} \sum_{i=1}^n (x_i)^2}$$

so that:

$$\sum_{i=1}^n (x_i)^2 = 2n\lambda^2$$

$$= 1\,878\,n \text{ for the glide path}$$

$$= 209\,n \text{ for the localiser}$$

Thus, a 95 % success rate can be represented graphically as in Figure A1–2 showing  $\sum x_i^2$  plotted against  $i$ :

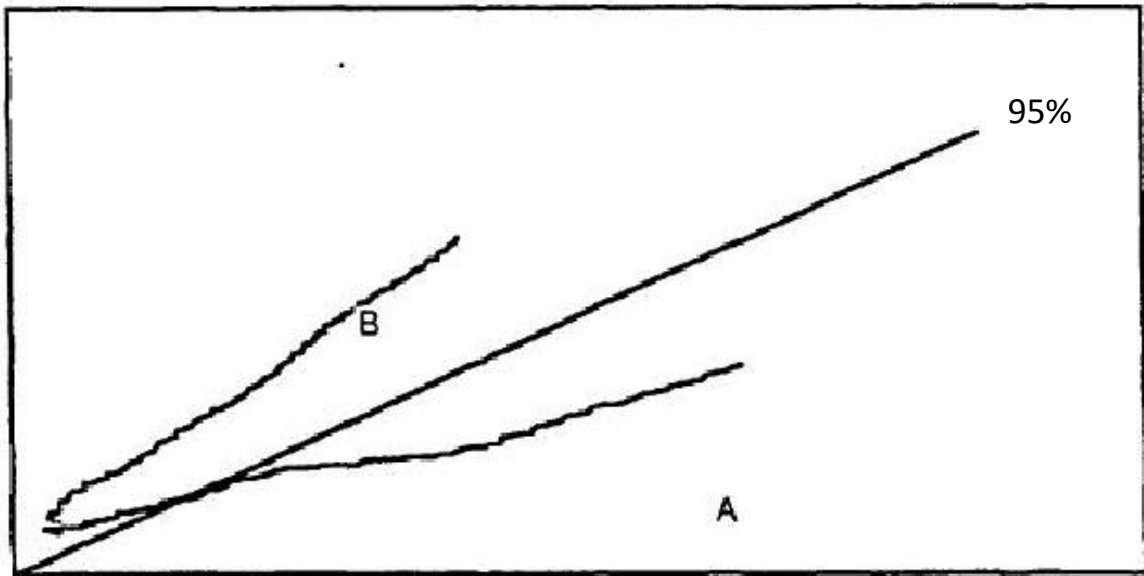

Figure A1-2: Examples of results of flight trials

If, now, a flight trials programme is carried out and the accuracy of the results needs to be checked against the 95 % success criterion, this can be achieved by plotting the value of  $\sum x_i^2$ , the sum of the squares of the maximum recorded deviations, against  $n$ , and the number of runs as the trial progresses. If the results are better than required, the graph will cross the 95 % line as shown by line A above. If they are worse, the results will appear as line B.

So far, the effect of sample size has not been considered. Its effect is to lower the 95 % success line.

For the sample:

$$\lambda = \sqrt{\frac{1}{2n} \sum_{i=1}^n (x_i)^2}$$

As shown earlier:

$$\lambda_0^2 < \frac{\lambda^2}{1 - \frac{\mu_1}{\sqrt{n}}}$$

which, in the limiting case becomes:

$$\lambda^2 = \lambda_0^2 \left( 1 - \frac{\mu_1}{\sqrt{n}} \right)$$

Hence:

$$\lambda_0^2 \left( 1 - \frac{\mu_1}{\sqrt{n}} \right) = \frac{1}{2n} \sum_{i=1}^n (x_i)^2$$

or



$$\sum_{i=1}^n (x_i)^2 = 2n\lambda_0^2 \left( 1 - \frac{\mu_1}{\sqrt{n}} \right)$$

$\lambda_0 = 30.64$  for the glide path

$\lambda_0 = 10.21$  for the localiser

$\mu_1 = 1.28$  for 90 % confidence level

$$\sum_{i=1}^n (x_1)^2 = 1\,878\,n - 2\,403\,\sqrt{n} \text{ for the glide path}$$

$$= 209\,n - 267\,\sqrt{n} \text{ for the localiser}$$

These expressions have been used to produce Figure 1 of [AMC AWO.B.CATII.113](#).

#### 4 Pass or fail method

Suppose the rate of failed approaches measured over a large number of approaches is  $r$ .

In a number of approaches  $T$ , the expected number of failures is  $n = rT$ .

In any given period of time, the number of failures occurring may be greater or less than  $n$ , and the small sample may not be typical.

If the failures are randomly distributed with respect to time, the probability  $p$  of observing  $F$  failures when the expected number is  $n$  is given by the various terms of the Poisson distribution, viz.:

F	0	1	2	3	F
P	$e^{-n}$	$e^{-n}n$	$\frac{e^{-n}n^2}{2!}$	$\frac{e^{-n}n^3}{3!}$	$\frac{e^{-n}n^F}{F!}$

This is a convenient form when the long-term average  $n$  is known and the probability of an occurrence of abnormally high or low numbers of failures over short periods is to be found. The problem here is the reverse of this. The observed number  $F$  is known and the value of  $n$ , which is consistent with it, is required.

In this case,  $n$  can have any value above zero and less than infinity. By considering all values of  $n$  from zero to some selected maximum  $N$ , the Poisson distribution can be used to find the probability of occurrence of each value of  $n$ . Summing all these probabilities gives the cumulative probability  $P$  that, for an observed value of  $F$ , the expected value is not in excess of  $N$ . Thus:

$$P = \int_0^N \frac{n^F}{F!} e^{-n} dn$$

As F is a known whole number then, for various values of F, the value of P may be determined as follows:

$$F = 0, P = \int_0^N e^{-n} dn = 1 - e^{-N}$$

$$F = 1, P = \int_0^N ne^{-n} dn = 1 - (N + 1)e^{-N}$$

$$F = 2, P = \int_0^N \frac{n^2 e^{-n}}{2!} dn = 1 - \left( N^2 + 2N + 2 \right) \frac{e^{-N}}{2}$$

and generally for any value of F,

$$P = 1 - \left( \frac{N^F}{F!} + \frac{N^{F-1}}{(F-1)!} + \frac{N^{F-2}}{(F-2)!} + \dots + N + 1 \right) e^{-N}$$

By evaluating the integral for various values of N, the variation of P with N is obtained. Then, for a given confidence level P, the value of N corresponding to the observed value F is obtained. Thus if the observed rate is F/T, then, for a selected confidence level, it is possible to determine the maximum value for the failure rate N/T.

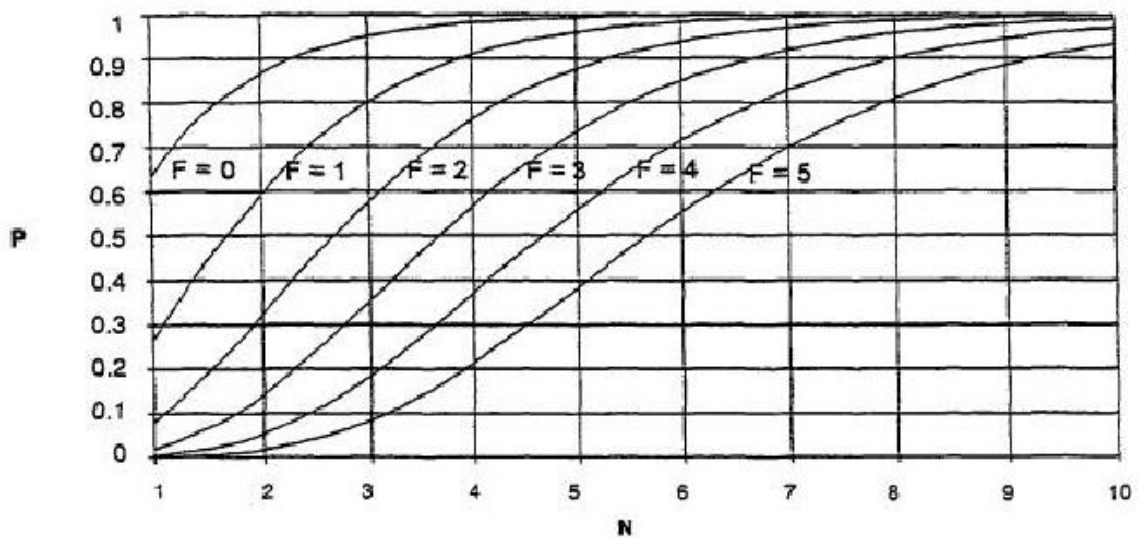

Figure A1-3: P, N and F relationships

From Figure A1-3, it can be seen that for a failure rate r of 5 % and a 90 % confidence level, the required number of approaches T is:

F	N	T
0	2.30	46
1	3.9	78
2	5.3	106
3	6.65	133
4	8	160
5	9.2	184

For example, it is necessary to make 46 approaches without a failure, 78 if one failure occurs and so on as shown in Figure 2 of [AMC AWO.B.CATII.113](#).

**AMC TO SECTION 4****AIRWORTHINESS CERTIFICATION OF AEROPLANES FOR OPERATIONS WITH DECISION HEIGHTS BELOW 30 M (100 FT) OR NO DECISION HEIGHT — CATEGORY 3 OPERATIONS (CAT III)****AMC AWO.B.CATIII.101(a) Applicability and terminology**

A precision approach system as defined in ICAO Annex 10 is considered to be an xLS (ILS, MLS, or GLS) which has outputs indicating the magnitude and sense of deviation from a preset azimuth and elevation angle giving equivalent operational characteristics to that of a conventional ILS.

An aeroplane with a basic airworthiness approval for IFR operations is eligible to perform xLS ILS or MLS precision approaches down to a decision height DH of 60 m (200 ft), assuming that the necessary xLS ILS and/or MLS receiver(s) and instruments and their installation have been approved. The supplementary airworthiness criteria for aeroplanes to perform precision approaches down to a decision height DH below 60 m (200 ft) and down to 30 m (100 ft) are contained in Subpart 2 B [Section 3](#).

The purpose of this Section is to specify the supplementary airworthiness criteria for aeroplanes to perform precision approaches with decision height DHs below 30 m (100 ft) or with no decision height DH.

This material may not be appropriate to precision approach aids other than xLS ILS and MLS. It should be noted that when other guidance information is used to supplement the xLS ILS or MLS (e.g. inertial navigation systems), some reduction may be acceptable in the standard of xLS ILS or MLS ground facility indicated below.

**Terminology**

- (a) The term 'landing system' used here refers only to the airborne system. It includes the equipment listed in [CS AWO.B.CATIII.113](#) and also all related sensors, instruments and power supplies.
- (b) Automatic landing system: The airborne equipment which provides automatic control of the aeroplane during the approach and landing.
- (c) Fail-passive automatic landing system: An automatic landing system is fail-passive if, in the event of a failure, there is no significant out-of-trim condition or deviation of flight path or attitude but the landing is not completed automatically.
- (d) For a fail-passive automatic landing system, the pilot assumes control of the aircraft after a failure.

The following are typical arrangements:

- (1) A monitored automatic pilot in which automatic monitors will provide the necessary failure detection and protection.
  - (2) Two automatic pilots with automatic comparison to provide the necessary failure detection and protection.
- (e) Super fail-passive automatic landing system: An automatic landing system which meets the requirements of point (c) above but has additional features such as automatic align, roll-out and go-around modes which, along with other aircraft characteristics defined under [CS AWO.B.CATIII.113 \(b\)\(2\)](#), permit operations in lower RVRs than less sophisticated fail-passive landing systems.

(f) Fail-operational automatic landing system: An automatic landing system is fail-operational if, in the event of a failure, the approach, flare and landing can be completed by the remaining part of the automatic system.

In the event of a failure, the automatic landing system will operate as a fail-passive system.

The following are typical arrangements:

(1) Two monitored automatic pilots, one remaining operative after a failure.

(2) Three automatic pilots, two remaining operative (to permit comparison and provide necessary failure detection and protection) after a failure.

(g) Fail-operational hybrid landing system: A system which consists of a primary fail-passive automatic landing system and a secondary independent guidance system enabling the pilot to complete a landing manually after failure of the primary system.

A typical secondary independent guidance system consists of a monitored HUD providing guidance which normally takes the form of command information, but it may alternatively be situation (or deviation) information.

(h) The alert height is a specified radio height, based on the characteristics of the aeroplane and its fail-operational landing system. In operational use, if a failure occurred above the alert height in one of the required redundant operational systems in the aeroplane (including, where appropriate, ground roll guidance and the reversionary mode in a hybrid system), the approach would be discontinued and a go-around executed unless reversion to a higher DH is possible. If a failure in one of the required redundant operational systems occurred below the alert height, it would be ignored and the approach continued.

(i) DH is the wheel height above the runway elevation by which a go-around must be initiated unless adequate visual reference has been established and the aircraft position and approach path have been assessed as satisfactory to continue the approach and landing in safety.

Where it is used in this document, it means the minimum DH determined in the airworthiness certification.

(j) A go-around is the transition from an approach to a stabilised climb.

(k) Head-up display landing system (HUDLS)

The term 'HUDLS' refers to the total airborne system which provides head-up guidance to the pilot during the approach and landing or go-around. It includes all the sensors, computers, power supplies, indications and controls. Typically, a HUDLS is used for primary approach guidance for DHs down to 15 m (50 ft).

The terms 'localiser' and 'glide path' have been retained for use with either ILS, or MLS or GLS.

Cross reference is made in this Subpart Section to [AMC AWO.A.ALS.110](#) which provides guidance on controls, indicators and warnings alerts associated with installations incorporating more than one type of approach system (e.g. ILS and MLS and/or GLS).

### Characteristics of the types of operation

~~Background~~ Additional and more detailed information regarding the characteristics of the types of operation as distinguished in sub-paragraphs (a)(1), (a)(2) and (a)(3) is presented in more detail in the paragraphs that follow is provided below:

- (a) ~~Decision height~~ DH below 30 m (100 ft) but not less than 15 m (50 ft)

The ~~Runway Visual Range (RVR)~~ required by a pilot to make the decision to land from a ~~decision height~~ DH below 30 m (100 ft) is less than that needed at 30 m (100 ft). Furthermore, the time from the ~~decision height~~ DH to the start of the flare manoeuvre will be less.

Consequently, in order to achieve the desired success rate and to preserve the safety level, it has been considered necessary that the aeroplane be fitted with an automatic landing system or a head-up landing guidance system. Use of such a systems also ensures that the aeroplane is within the obstacle-free zone specified in ICAO Annex 14 during approach and any go-around so that there is no need to take obstacle clearance into account in determining the ~~decision height~~ DH. This is chosen to give an acceptably low probability of touching the ground during go-around. The RVR limit is set by the responsible national authority in accordance with applicable operating regulations and provides visibility at and below the ~~decision height~~ DH so that, if either the automatic landing system the ILS or the xLS MLS ground facility fails when the aeroplane is below the ~~decision height~~ DH, the pilot can carry out a manual landing with an acceptable safety level.

The ground guidance system is either:

- (1) a Category III or a Category II ILS complying with the Category III standards of ICAO Annex 10, Chapter 3-1 in respect of all significant performance parameters, at least down to ILS point D, 900 m (3 000 ft) from the runway threshold.

or

- (2) a Category III MLS complying with the requirements of ICAO Annex 10, Chapter 3.11.

or

- (3) a GAST D GLS complying with the requirements of 10 ICAO Annex 10.

- (b) DH below 15 m (50 ft)

Aeroplanes which have a fail-operational landing system can be ~~certified~~ certified for operation with a ~~decision height~~ DH below 15 m (50 ft).

In this type of operation, the RVR needs not only to be sufficient for the pilot to make the decision at the ~~decision height~~ DH, but also to be sufficient to enable the pilot to control the aeroplane during the ground roll. The main purpose of the ~~decision height~~ DH is so that the pilot he can assess the adequacy of the visibility before touchdown and prepare to take over visual manual control. It is desirable that the ~~decision height~~ DH be late in the flare after the major pitch changes have taken place, and that an automatic go-around system be fitted. There exists an unknown probability that, although the visibility is reported to be adequate, denser patches of fog may lie on the runway, and it is thought prudent to add a margin to the bare minimum required to control the ground roll. The RVR limit is set by the responsible national authority in accordance with applicable operating regulations.

The ground guidance system (XLS ILS and MLS) is as described in point paragraph b (a)(1) above, and, additionally, complies with a continuity of service objective (failure survival capability) of  $1-(2 \times 10^{-6})$ . It is assumed that the pilot is promptly notified by air traffic control (ATC) of a failure or degradation of the required ground equipment (e.g. loss of stand-by XLS ILS or MLS transmitter).

(c) ~~No Decision Height DH~~

An aeroplane with a fail-operational landing system with automatic ground roll control (or ground roll guidance) may be certified ~~certificated~~ for operation without a ~~decision height DH~~ (operations when the pilot is not required to make a decision described in the definition of the ~~Decision Height DH~~). Any required RVR limit is set by the responsible national authority in accordance with applicable operating regulations.

In these visibility conditions, the pilot is likely to brake hard during the ground roll and therefore an anti-skid braking system is considered to be essential. Distance and ground speed indications and automatic braking would obviously be useful, but are not considered to be essential and are not required.

The ground guidance system (Category III ILS, ~~or~~ Category III MLS or GAST D GLS) complies with the Standards of ICAO Annex 10 and, additionally, complies with an integrity objective of  $1-(0.5 \times 10^{-9})$  and a continuity of service objective of  $1-(2 \times 10^{-6})$

#### AMC AWO.B.CATIII.102 Safety level

In showing compliance with the performance and failure requirements, the probabilities of performance or failure effects should not be factored by the proportion of approaches, which are made with the ~~decision height DH~~ below 30 m (100 ft).

#### AMC AWO.B.CATIII.109 Alert height

(See [CS AWO.B.CATIII.109](#))

It may be operationally useful for the alert height to be somewhat higher than 30 m (100 ft) since this would permit reversion to a higher ~~decision height DH~~ in the event of system failure. A maximum value should be established during certification and it should not normally be above 90 m (300 ft).

#### AMC AWO.B.CATIII.112 Go-around

##### 1 Safety considerations

##### 1.1 Effects of contact with the runway

For aircraft in which a go-around from a very low altitude may result in inadvertent runway contact, the safety of the procedure should be established giving consideration to at least the following:

- a. The guidance information and control provided by the go-around mode should be retained and be shown to have safe and acceptable characteristics throughout the manoeuvre.
- b. Other systems (e.g. automatic throttle, brakes, spoilers, reverse thrust and alerting systems) should not operate in a way that would adversely affect the safety of the go-around manoeuvre.

## 1.2 Inadvertent go-around selection

Inadvertent selection of go-around mode after touchdown should have no adverse effect on the ability of the aircraft to safely roll out and stop.

## 2 Performance

Height losses from a range of altitudes during the approach and flare should be determined when under automatic control and when using the landing guidance system as appropriate.

- a. Height losses may be determined by flight testing (with typically 10 flight-demonstrated go-arounds) supported by simulation.
- b. The simulation should evaluate the effects of variation in parameters, such as weight, centre of gravity, configuration and wind, and show correlation with the flight test results.
- c. Normal procedures for a go-around with all engines operating should be followed.

### AMC AWO.B.CATIII.113 Installed equipment

(a) The list of items of equipment required to be installed for certification to the ~~decision height~~ **DHs** specified, is based on experience with conventional medium and large jet transports and it is recognised that changes may be appropriate in significantly different applications.

(b) ~~ILS and MLS~~ **ILS** airborne equipment standards

Acceptable standards for airborne receiver equipment include:

- (1) Localiser receivers with centring accuracy for automatic landing complying with the minimum performance standards of EUROCAE ED-46B or later revision, or an equivalent standard, and glide path receivers complying with the minimum performance standards of EUROCAE ED-47A or RTCA DO-192 or later revision.

Note: The aforementioned localiser specifications are in accordance with the FM Broadcast Interference Immunity requirements of ICAO Annex 10, Volume I, Chapter 3, Paragraph 3.1.4.

- (2) MLS receivers complying with the minimum performance standards of EUROCAE ED-36A or later revision, or an equivalent standard, and DME/P transceivers complying with the minimum performance standards of EUROCAE ED-54 or RTCA DO-189.
- (3) Combined ILS/MLS receivers complying with the minimum performance standards of EUROCAE ED-74 or equivalent standard.
- (4) Combined ILS/MLS/GPS receivers complying with the minimum performance standards of EUROCAE ED-88 or equivalent standard.
- (5) **Combined ILS/MLS/GPS/GLS receivers, or combined ILS/GPS/GLS receivers, complying with the minimum performance standards of EUROCAE ED-88, RTCA DO-246E, and RTCA DO-253D, or equivalent standards.**

(c) Radio altimeter equipment standards

The airborne equipment used to provide height above terrain may be a radio altimeter complying with the minimum performance standards of EUROCAE ED-30 or RTCA DO-155. **Alternatively, another device capable of providing equivalent performance and integrity level may be used.**



**(d) Anti-skid braking systems**

An anti-skid braking system may not be required depending on the braking characteristics of the aeroplane, its susceptibility to tyre failure during heavy braking, and susceptibility to tyre failure during operations with reduced runway surface friction.

**(e) Means to determine, assess or manage stopping performance**

In showing compliance with [CS AWO.B.CATIII.113](#) (a)(8), at least one of the following means should be used:

- (1) An automatic braking system together with information for the flight crew about appropriate automatic brake settings to be used for landing or which provides landing distance information for use by the flight crew to determine which automatic brake setting may or may not be appropriate.
- (2) A ground speed indicating system together with acceptable procedures for its use. Knowledge of the aircraft position on the runway is assumed.
- (3) A display showing the adequacy of aircraft deceleration for stopping within the confines (e.g. width and length) of the available runway.
- (4) A display showing the length of remaining runway after touchdown.
- (5) A procedural means, acceptable to the regulatory authority, to ensure that a safe stop can be made (without the assistance of an aircraft system). However, a procedural means is not appropriate for minima less than 300 ft RVR (100 m). For an RVR less than 100 m, consideration should be given to the availability of auto-roll-out and anti-skid and if manual braking can be accepted with a contingency procedure (e.g. max braking).

**AMC AWO.B.CATIII.113(b)(2) Suitability of aircraft for fail-passive operations with a decision height of 50 ft or greater**

Operations in accordance with [CS AWO.B.CATIII.113](#) (b)(2) and (3) may not be suitable for all aircraft types. When assessing the suitability of an aircraft type in respect of size and approach speed, the following should be taken into account:

- (a) landing gear track;
- (b) wingspan;
- (c) pilot's eye to wheel height;
- (d) distance from the cockpit to the main wheels; and
- (e) approach speed at maximum landing weight.

The following provides additional guidance in order to assist in the determination of whether an aircraft is suitable for super fail-passive operations:

**(a) Landing gear track, wingspan and distance from cockpit to the main wheels**

The landing gear track, wingspan and distance from the cockpit to the main wheels should be considered in relation to the safety of the go-around which is likely to be conducted from a height where ground contact is likely. If the results of the simulator tests show potential for wing tip

strikes or runway excursions during go-around, then it is unlikely that the aircraft can be approved for super-fail-passive operations.

(b) Pilot's eye-to-wheel height

The pilot's eye-to-wheel height has a direct bearing on the height of the pilot's eyes above the runway at the DH. This, along with the angle of vision cut-off of the pilot's downward view, determines the visual segment available in low visibility.

The visual segment and number of visible approach lights required are explained in AMC4 SPA.LVO.105(c). It is likely that the size of the visual segment will be determined by the pilot's need to see at least one barrette of the TDZ lighting in order to have a suitable roll reference in the event of having to perform a manual go-around due to autopilot failure. Since the TDZ lighting is spaced at a maximum of 60 m intervals on Category III runways, a visual segment of 60 m must always be available at and below the DH for super-fail-passive operations.

The eye-to-wheel height is affected not only by aeroplane size and geometry, but also by the pitch attitude during approach (which itself, is weight-, centre-of-gravity- and configuration-dependent). Typical eye-to-wheel height values for narrow body turbojets lie between 4 and 5 metres. Aeroplanes with significantly higher values may not be suitable for super-fail-passive operations since the visual segment might be insufficient.

It is important to ensure that any pitch attitude changes which may occur as a result of the automatic landing flare are taken into account when determining the eye-to-wheel height. See also [CS AWO.B.CATIII.110](#).

(c) Approach speed at maximum landing weight

The approach speed should be sufficiently low such that the limited visual references used to verify the aircraft flight path at and below the DH, during continued approach or go-around, can be easily interpreted by the pilot.

Experience has shown that super fail-passive operations may safely be conducted on some aircraft types up to a maximum approach speed of 140 kt. This value equates to the upper limit of Category C aeroplanes as defined by CAT.OP.MPA.320 point (b) Table 1 and may be used as a general guide but it may not be limiting.

(d) Other aeroplane characteristics

The requirement for the aircraft to be easily manoeuvrable relates mainly to the ability of the pilot to safely perform a manual go-around close to the ground, with limited external cues following an autopilot failure below the DH. The assumption is that the more manoeuvrable the aircraft is, the safer the go-around is likely to be.

Areas to consider when assessing the manoeuvrability of the aircraft with respect to the manual go-around manoeuvre should include engine spool-up characteristics and trim changes due to thrust (directional and in pitch), trim changes due to flap and gear, and the ability to control airspeed.

The aeroplane should also be assessed from the point of view of being able to be safely controlled along the runway from the point at which the automatic landing system is normally disengaged, down to a safe taxi speed in the minimum RVR proposed.



**AMC AWO.B.CATIII.115 Performance demonstrations**

## 1 Approach

The supporting flight tests to show compliance with [CS AWO.B.CATIII.115 \(a\)](#) in respect of approach performance may be to a programme of flight demonstrations carried out in accordance with [AMC AWO.B.CATII.113](#).

## 2 Touchdown

For compliance with [CS AWO.B.CATIII.115 \(b\)](#) in respect of touchdown performance, a programme of flight demonstrations will be required to support the simulation and analysis. (See [AMC AWO.A.ALS.106](#)).

## 3 Ground roll

3.1 A programme of landings should be carried out to ensure that there is a confidence level of 90 % that the criterion of [CS AWO.B.CATIII.117\(a\)](#) is complied with. This programme and the analysis of results should be in accordance with the procedures established for approach performance. (See [AMC AWO.B.CATII.113](#) paragraph 2)

3.2 When operation is based on fail-operational ground roll, a programme of flight demonstration landings is necessary to support the simulation and analysis programme which is required to demonstrate compliance with [CS AWO.B.CATIII.117\(b\)](#). (See [AMC AWO.A.ALS.106](#))

## 4 Considerations for GLS

4.1 Compatibility with rare undetected non-aircraft system error conditions (See [Appendix 1 to AMC to Subpart A](#))

The criteria below establish the compatibility of the ICAO standardised ground monitoring performance for satellite faults and single ground-reference receiver faults with the aircraft performance including satellite geometry screening. The criteria ensure that undetected faults or rare normal errors in the non-aircraft GBAS when combined with all other nominal factors affecting landing performance do not result in an unacceptably high probability of landing outside the limits that define a safe landing.

Note: [Appendix 1 to AMC.AWO.B.CATIII.115](#)— GBAS performance model for approach and landing simulation contains a list of references that have been used to derive the signal model. These references describe undetected non-aircraft system error conditions, rare normal performance and faults as well as the ICAO standardised ground system monitoring requirements. The aircraft requirements in this Section are intended to address non-aircraft system errors that are below the ground monitoring thresholds. The existence of such errors is not considered a malfunction of the non-aircraft system.

For any value of GLS NSE, including the effects of undetected satellite faults and undetected faulted conditions at a single ground reference receiver, it must be shown that the touchdown performance will be such that the exceedance of any of the limits prescribed in [CS AWO.A.ALS 106 \(c\)](#) will be less than that prescribed in [AMC AWO.A.ALS.106](#) paragraph 1.4, for the limit condition.

Other non-GLS variables effecting performance shall vary according to their expected distributions when assessing this compatibility. Credit for the prior probability of the fault cannot be taken

when evaluating the required landing probabilities; however, credit may be taken for the ground subsystem's probability of detection for satellite faults and the aircraft's probability of detection for single-reference receiver faults.

Note: It is assumed that operations will be approved with knowledge of the runway specific glide path and threshold crossing height values and the aircraft's capability. Therefore, it is not necessary to determine compliance with this Section using the glide path and threshold crossing height values set to limit allowed for the aircraft.

#### 4.2 Compatibility with worst-case undetected guidance errors

Rare ionosphere events and undetected satellite or ground station failures could result in significant vertical (and lateral) position errors. Under certain conditions, such errors may go undetected by the system and could result in erroneous guidance if not mitigated. The effect of such errors may not be observable by the flight crew.

All undetected errors that are not extremely improbable shall not prevent a safe landing and/or go-around when all other variables effecting performance are at their nominal values. The effect of worst-case undetected errors on landing system performance shall be assessed via simulation using the GLS noise model provided in [Appendix 1 to AMC to Subpart A](#). The worst-case undetected errors shall be simulated by using the maximum range domain error given in Table 5 of [Appendix 1 to AMC to Subpart A](#) in conjunction with the appropriate geometry screening factors used by the aircraft. The certification plan must specify how the demonstration will be conducted, including the number of cases and variables with pass/fail criteria. The aeroplane performance shall be assessed in the presence of the full range of bias and ramp type failures produced by the fault mode generator described in [Appendix 1 to AMC to Subpart A](#).

#### **AMC AWO.B.CATIII.118 Landing distance**

This AMC applies when using HUD in manual CAT III operations. A relevant feature of the HUD system to consider would be flare guidance.

Relevant procedural elements associated with using the HUD would be any specific aeroplane configuration, approach speed increment, thrust management or ATHR speed target.

The increment of the landing distance referred to in [CS.AWO.B.CATIII.118](#) when using a HUD may be derived as follows:

- (a) The configuration, procedure and speed should be those recommended in the associated procedures.
- (b) The distance from the runway threshold to the touchdown point should be the distance from the runway threshold to the glide-slope origin (SO) plus the mean distance from the glide-slope origin to touchdown (STD) plus three times the standard deviation of the distance from the glide-slope origin to touchdown ( $\sigma$ STD).
- (c) The gross distance from touchdown to come to a complete stop should be determined in accordance with the requirements of CS 25.125 (b) (1) through (5), assuming a touchdown speed equal to the main touchdown speed plus three standard deviations of the touchdown speed.

Note: The main values and standard deviations considered in paragraphs (b) and (c) should be based on random variations as determined by [AMC AWO.A.HUD.107](#). Systematic variation of parameters should cover the normal range of AFM conditions.

- (d) The landing distance should be taken as the distance from the runway threshold to the touchdown point, as defined in (b) above, i.e.,  $(SO + STD + 3\sigma(STD))$ , plus the ground roll distance defined in (c) above.
- (e) The landing distance should include corrections for variations in glide-slope angle and variations in glide-slope height at the threshold. Alternatively, these effects may be included by use of conservative assumptions in the basic presentation of data, with the applicable ranges stated in the AFM.

#### **AMC1 AWO.B.CATIII.121 Flight demonstrations of failure conditions**

##### 1 Failures

1.1 Indications and ~~warnings~~ alerts. Failure indications and ~~warnings~~ alerts should be demonstrated. (See AMC 25.1309.)

##### 1.2 Effects

For compliance with CS 25.1309, the effects of failure conditions will need to be demonstrated including not only failures of the landing system but also failures in other aeroplane equipment which could affect the landing (e.g. engines, reverse thrust, nose-wheel steering) and failures in the ~~xLS ILS and/or MLS~~ ground facility. Although this demonstration may be done primarily by using a ground simulation, some cases should also be demonstrated in flight to confirm the conclusions of the simulation. (See AMC 25.1309.)

##### 2 Crew errors

Individual landings additional to those of [AMC AWO.A.ALS.106](#) paragraph 2.1 should be carried out to demonstrate that errors, which can reasonably be expected to occur, are not hazardous (e.g. asymmetric braking or reverse thrust, incorrect approach speed). (See [AMC AWO.A.ALS.106](#) paragraph 2.2.)

#### **AMC2 AWO.B.CATIII.121 Flight crew and maintenance checks**

When exposure times relevant to failure probability calculations are dependent on flight crew and maintenance checks (i.e. preflight, first flight of the day, pre-land, etc.) and/or inspection intervals for dormant (latent) failures, these tasks, time intervals and the recommended component monitoring programme should be specified in the ~~flight manual~~ AFM or maintenance manual as appropriate.

#### **AMC1 AWO.B.CATIII.122(a) and AWO.B.CATIII.123(a) Loss of system function**

For compliance with [CS AWO.B.CATIII.122\(a\)](#) and [CS AWO.B.CATIII.123\(a\)](#), it may be necessary to measure monitored variables in flight to determine the probability that any will reach a warning threshold. (See [AMC AWO.B.CATII.113](#))

#### **AMC2 AWO.B.CATIII.122(a) Safety of the manual landing and go-around manoeuvres following loss of automatic control capability for super fail-passive systems**

##### 1 Reliability

Certification flight test data may need to be supplemented by either in-service data or analysis, to establish the required level of reliability.

## ~~21~~ Manual go-around

### ~~21.1~~ Safety considerations

~~21.1.1~~ Following loss of the automatic pilot below ~~the decision height~~ ~~DH~~, the aircraft should be capable of safely executing a manual go-around from any point on the approach down to touchdown, in all configurations to be ~~certified~~ ~~certificated~~. The manoeuvre ~~may~~ ~~should~~ not require exceptional piloting skill, alertness or strength and should ensure that the aeroplane remains within the obstacle limitation surface specified in ICAO Annex 14, for a precision approach runway Category II or III.

~~21.1.2~~ For aircraft in which a go-around from a very low altitude may result in inadvertent runway contact, the safety of the procedure should be established giving consideration to at least the following:

- a. Where the guidance information provided by the go-around mode is retained, it should be shown to have safe and acceptable characteristics throughout the manoeuvre.
- b. Other systems (e.g. automatic throttle, brakes, spoilers and reverse thrust) should not operate in a way that would adversely affect the safety of the go-around manoeuvre.

~~21.1.3~~ Non-normal procedures applicable following loss of a fail-passive automatic landing system (see subparagraph ~~2~~ ~~3~~)), may require reversion to manual control using primary display information such as attitude and airspeed, to perform a manual go-around. Where applicable, consideration should be given to failure conditions that could result in loss of both the automatic landing system and relevant primary display information.

### ~~21.2~~ Performance

The safety of the go-around manoeuvre may be determined by flight testing (typically 10 go-arounds) supported where necessary by simulator testing.

If loss of the automatic pilot can result in loss of the flight director guidance, this should be considered during the performance demonstration.

## ~~32~~ Manual landing

Following loss of the automatic control capability below ~~decision height~~ ~~the DH~~, a safe landing should be demonstrated in accordance with established procedures.

- a. The demonstration should take into account at least the following variables:
  - i. centre of gravity;
  - ii. landing weight; and
  - iii. wind conditions.
- b. If the demonstration is to be performed with a simulator, the simulator should be:
  - i. equipped with a visual system that provides an acceptable representation of the actual visibility conditions for which operational approval is sought; and
  - ii. suitably validated by flight test demonstrations for the landing manoeuvre.
- c. The number of manual landings to be performed should be related to the probability of loss of the automatic landing system below ~~decision height~~ ~~the DH~~.



**4 Consideration of the effects of engine failure**

4.1 Where the landing system provides automatic control of the rudder pedals, a demonstration should be made to show that, for automatic approaches initiated with all engines operating:

a. automatic go-around; and

b. automatic landing,

can be performed safely after the failure of any single engine at any point during the approach down to touchdown without the pilot needing to intervene and assume control.

4.2 The automatic pilot should remain engaged following the failure of any single engine, taking account of the loss of systems associated with the failed engine (e.g. electrical and hydraulic systems).

**AMC AWO.B.CATIII.127(a) Aeroplane flight manual**

Actual RVR minima to be used are subject to operating operational regulations and and may vary from one Member State to another taking account of local circumstances. For this reason, RVR minima should not be included in the ~~aeroplane flight manual~~ AFM as limitations. To aid operational assessment and the establishment of landing minima, the RVR values encountered during airworthiness certification may be given.

**AMC AWO.B.CATIII.127(g) Aeroplane flight manual**

The AFM may contain a statement that the categories of xLS ground facilities which have been used as the basis for certification should not be taken as a limitation. In that case, the AFM should also contain a statement that some Category 1 xLS ground facilities may be suitable for use by the approach and landing system.

**APPENDIX 1 TO AMC AWO.B.CATIII.115****1 Limit case analysis**

Demonstration of compliance with sub-paragraph 4.1 of [AMC AWO.B.CATIII.115](#) may be done by analysis to show that for all possible sizes of navigation error, the joint probability that the error is not detected and that the error results in the aeroplane landing outside of the safe landing box as defined in [CS AWO.A.ALS.106](#) is less than  $1 \times 10^{-5}$ . The analysis uses the nominal touchdown distributions (lateral and longitudinal) along with the geometry factors ( $S_{\text{vert}}$  and  $S_{\text{lat}}$ ), and the maximum allowable  $P_{\text{md}}$  performance of the monitors for satellite ranging source failures and for the reference receiver fault monitor (RRFM). The nominal touchdown distribution is used to compute a probability of an unsuccessful landing given a particular size of error  $P_{UL|E}(E)$ . This probability is then multiplied by the probability of an error not being detected as a function of E,  $P_{\text{md}}(E)$ . The probability of an unsuccessful landing given in error is the joint probability that the fault that causes an error, E, is not detected and the landing will be unsuccessful given an error, E:

$$P_{UL}(E) = P_{UL|E}(E) \cdot P_{\text{md}}(E) < 10^{-5} \quad [1]$$

To form the conditional unsuccessful landing probability,  $P_{UL|E}(E)$ , a conditional touchdown distribution should be used that would result from a constant bias error in addition to the fault-free NSE and flight technical error distributions. This should be done for the full range of relevant error sizes to form the total conditional probability of an unsuccessful landing as a function of the error. The conditional unsuccessful landing probability is expressed as follows for the land short and land long cases:

$$\text{Land short} \quad P_{(UL|E)(E)} = \int_{-\infty}^{LSC} P_{TSE\_LON|E}(x, E) dx \quad [2]$$

$$\text{Land long} \quad P_{UL|E}(E) = \int_{LLC}^{\infty} P_{TSE\_LON|E}(x, E) dx \quad [3]$$

Land with wheels less than 5 ft from the edge of the runway:

$$P_{UL|E}(E) = \int_{RWE-GW/2}^{\infty} P_{TSE\_LAT|E}(x, E) dx + \int_{-\infty}^{-RWE+GW/2} P_{TSE\_LAT|E}(x, E) dx \quad [4]$$

Where:

*LSC* is the land short criteria (i.e. 200 ft)

*LLC* is the land long criteria (i.e. 3 000 ft)

*RWE* is the lateral landing criteria (i.e. 70 ft)

*GW* is the lateral distance between the main landing gear

$P_{TSE\_LON|E}(x, E)$  is the probability density function for the longitudinal touchdown given a bias of magnitude E.

$P_{TSE\_LAT|E}(x, E)$  is the probability density function for the lateral touchdown given a bias of magnitude E.

Note: Care should be taken to insure consistency of units when making these calculations.

**1.1 Computing  $P_{\text{md}}$  for ranging source errors**

A bound on the probability of missed detection for the ranging source error,  $P_{\text{md}}(E_R)$  is defined by the performance constraint region given in Annex 10 Appendix B section 3.6.7.3.3.2. The  $P_{\text{md}}$  performance should lie below the curve defined by Table B-76A in the SARPs, repeated here for convenience.



Table B-76 A:  $P_{md\_limit}$  parameters

Probability of missed detection	Pseudorange error (metres)
$P_{md\_limit} \leq 1$	$0 \leq  E_r  < 0.75$
$P_{md\_limit} \leq 10^{(-2.56 \times  E_r  + 1.92)}$	$0.75 \leq  E_r  < 2.7$
$P_{md\_limit} \leq 10^{-5}$	$2.7 \leq  E_r  < \infty$

For example, in the case of the longitudinal touchdown requirement, the vertical position error has the largest effect on the touchdown location. The worst-case projection of a range error into vertical error,  $\max(|S_{Apr_{vert-i}}|)$ , may be used to determine the resulting limit on  $P_{md}(E_V)$  by substituting  $E_R = E_V / \max(|S_{Apr_{vert-i}}|)$ .

Figure 1 illustrates the relationship between  $P_{md\_limit}$  and the  $P_{md}(E_V)$  for  $\max(|S_{Apr_{vert-i}}|) = 5$ .

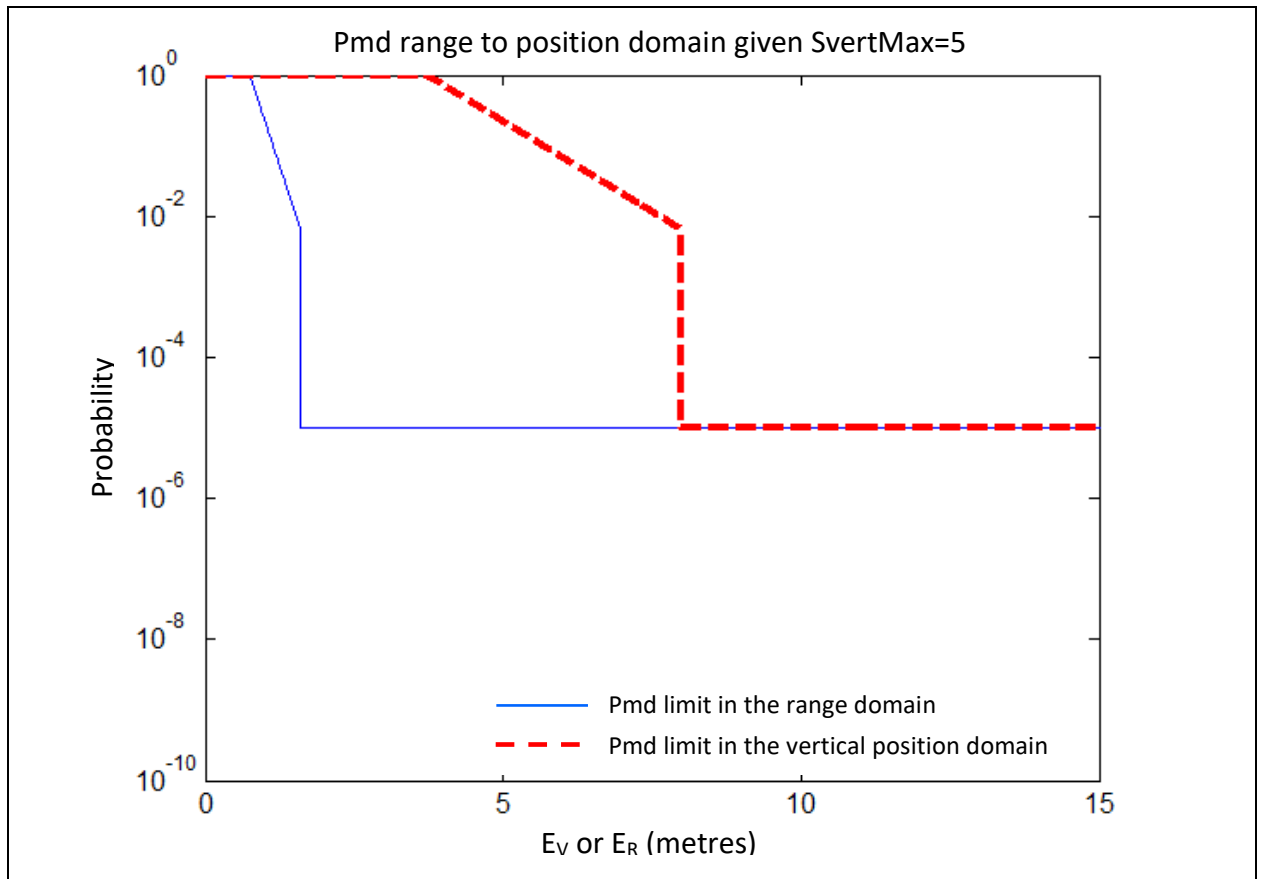

Figure 1: Example of the satellite ranging source  $P_{md}$  in the range domain and position domain

1.2 Computing  $P_{md}$  for reference receiver fault monitoring

The  $P_{md}$  for the RRFM is given by:

$$P_{mdApprox}(E_V) = \int_0^{T_{BAC}} P_{Bmd}(x, E_V) dx \tag{5}$$

where:

$T_{BAC}$  is the maximum threshold for the RRFM monitor given by:

$$T_{BAC} = 5.5 \times \sqrt{\left(\frac{0.0842 \times VAL}{\sqrt{m-1}}\right)^2 + 0.4^2} \text{ Metres} \quad [6]$$

where:

VAL is the vertical alert limit that is used by airborne equipment to screen geometry expressed in metres.

And  $p_{Bmd}(x, E_V)$  is the probability density function (pdf) of  $|B_{i,vert}(E_V)|$  in the faulted circumstance given by:

$$p_{Bmd}(x, E_V) = \begin{cases} x \geq 0; & dnorm\left(x, E_V, \frac{0.0842 \times VAL}{\sqrt{M-1}\sqrt{M}}\right) \\ & + dnorm\left(-x, E_V, \frac{0.0842 \times VAL}{\sqrt{M-1}\sqrt{M}}\right) \\ x < 0; & 0 \end{cases} \quad [7]$$

where  $dnorm(x, \mu, \sigma)$  is the Gaussian pdf

$$dnorm(x, \mu, \sigma) = \frac{e^{-\frac{(x-\mu)^2}{2\sigma^2}}}{\sqrt{2\pi}\sigma} \quad [8]$$

For a derivation of these expressions, see reference [Error! Bookmark not defined.] of [Appendix 1 to AMC to Subpart A](#).

### 1.3 Example assessments

Figure 2 illustrates a landing short assessment for a hypothetical aeroplane with a nominal longitudinal touchdown point of 1 500 ft from the threshold and a dispersion that can be bounded by a Gaussian distribution with  $\sigma=220$  ft. Also, a  $\max(|S_{Apr,vert,i}|)$  of 5, VAL of 10 metres and GPA of 3 degrees is used. Rearranging equation [1]:

$$P_{UL|E}(E) < \frac{10^{-5}}{P_{md}(E)} \quad [9]$$

Hence by dividing  $10^{-5}$  by the  $P_{md}$  curves for satellite ranging sources and RRFM, the grey 'keep out regions' shown in Figure 2 can be obtained. The assessment is then simple. If the curve for  $P_{UL|E}(E)$  does not enter the keep out regions, then the requirement that  $P_{UL}(E) < 10^{-5}$  is met for all values of E.

An alternative approach to the analysis is illustrated in Figure 3 where the probability of an unsuccessful landing is explicitly calculated for both monitor types (ranging sources and RRFM).

Extension of these examples to the land long and lateral cases is straightforward.

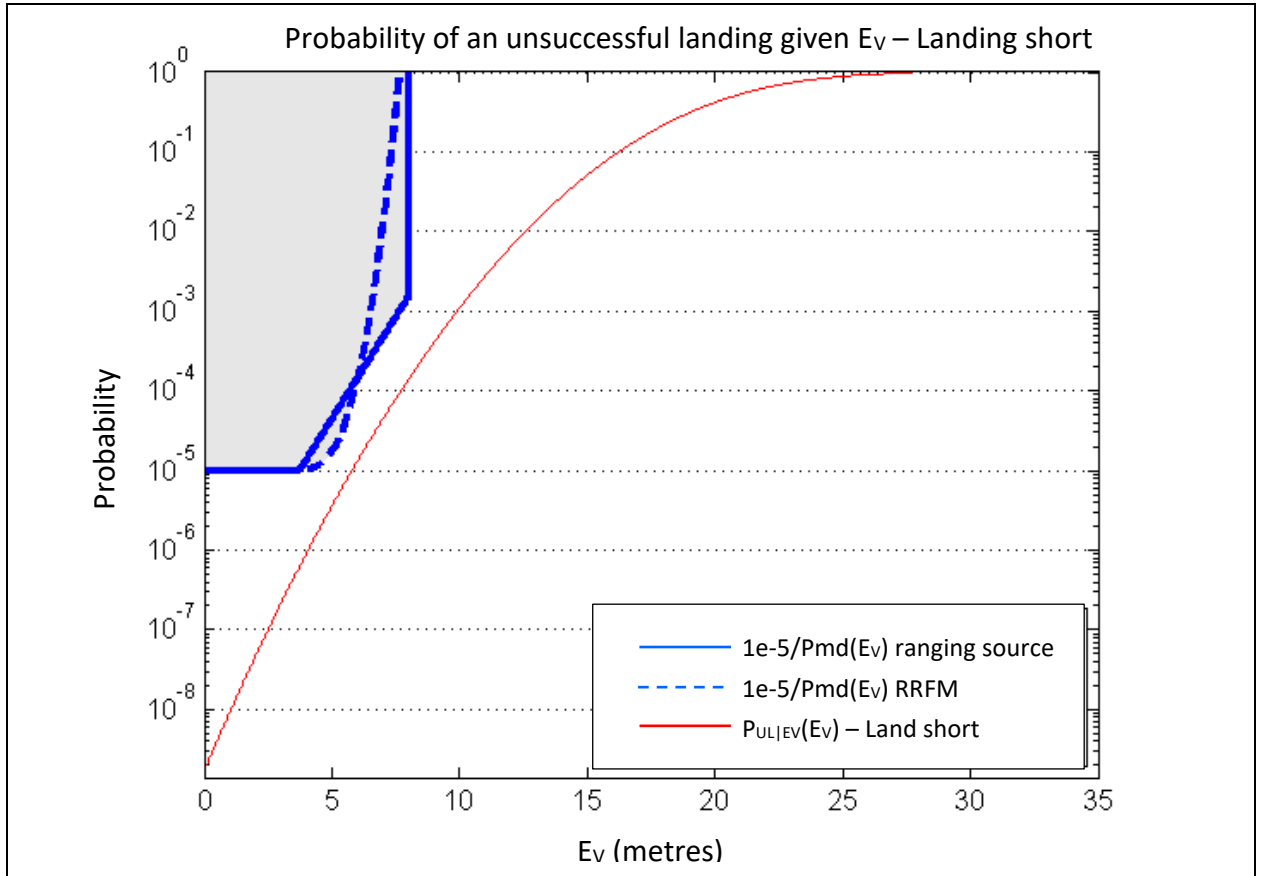

Figure 2: Example assessment of landing short performance

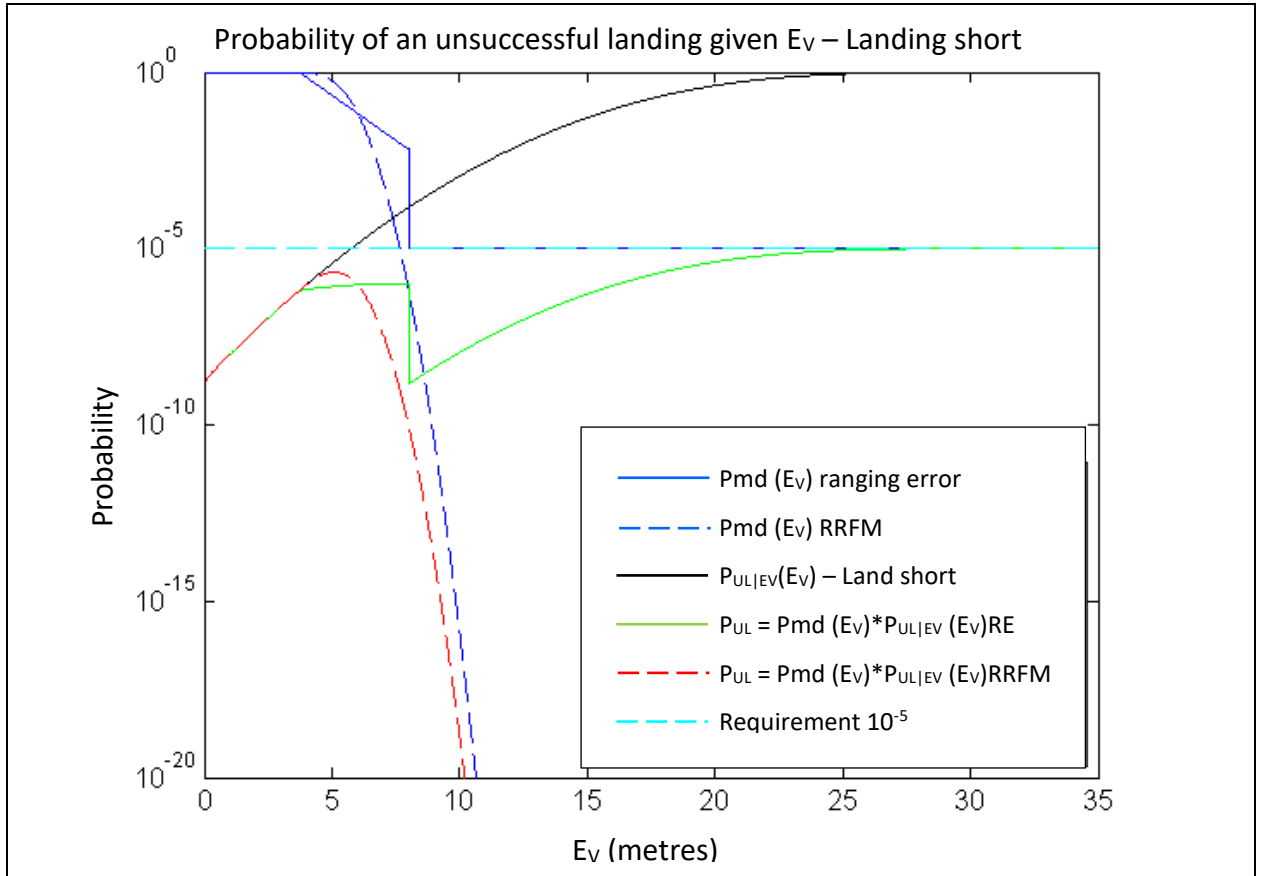

Figure 3: Explicit calculation of  $P_{UL}$  for the land short example above

**SUBPART C — TAKE-OFF****AMC TO SECTION 1****AIRWORTHINESS CERTIFICATION OF AIRCRAFT FOR TAKE-OFF OPERATIONS IN LOW VISIBILITY  
(TOO)****AMC AWO.C.TOO.101 Applicability and terminology**

An aeroplane with a basic airworthiness approval is eligible for take-off in reported visibilities which are sufficient to ensure that the pilot will at all times have sufficient visibility to complete or abandon the take-off safely. The purpose of this Subpart is to specify the supplementary airworthiness criteria for aeroplanes equipped to take-off in lower visibilities. It is only concerned with directional guidance during the ground-borne portion of the take-off (i.e. from start to main wheel lift-off, or standstill in the event of abandoned take-off).

The RVR limits for take-off of transport aircraft are set by the responsible national authority in accordance with applicable operating regulations. The purpose of the guidance system, which is the subject of these requirements, is to permit a reduction of these limits but not to allow a take-off in visibility below the minimum necessary for a normal take-off using visual reference.

The requirements are based on the assumption that, if the take-off guidance system is based on ILS or MLS information, operational precautions are taken to ensure that the localiser signal is suitable (e.g. in each case the ILS, the localiser is Category III, or the airborne system has been shown to perform satisfactorily on that installation).

**Terminology**

**Take-off guidance system:** A take-off guidance system provides directional guidance information to the pilot during the take-off or abandoned take-off. It includes all the airborne sensors, computers, controllers and indicators necessary for the display of such guidance. Guidance normally takes the form of command information, but it may alternatively be situation (or deviation) information.

**System concept**

The criteria for a take-off guidance system given in the ~~points paragraphs~~ that follow are intended to provide for a reduction in take-off minima to a level where the pilot can normally line up on the runway centre line and carry out the take-off by visual reference, but where the visibility is sufficiently low that:

- (a) any further reductions in the visibility which may be encountered during the take-off run would make directional control by visual reference alone difficult; or
- (b) significant deviations from the runway centre line may be difficult to correct by visual reference alone.

Visual reference remains the primary means of guidance, with the system providing reversionary guidance. The pilot would therefore not commence the take-off run unless ~~he had~~ the prescribed visual reference ~~had been aquired~~ and the values of ~~the~~ RVR reported were adequate.

Experience indicates that pilots are able to hold the centre line in very low visibilities (e.g. one or two lights visible at one time), and that this ability improves as the speed increases. However, in



such low visibilities the pilot may over-control in attempting to return to the centre line if the aeroplane deviates for any reason, and the reducing speed of an abandoned take-off may be the most critical phase in this respect.

**AMC AWO.C.TOO.102 Safety level**

In showing compliance with the performance and failure requirements, the probabilities of performance or failure effects may not be factored by the proportion of take-offs that are made in low visibility.

**AMC AWO.C.TOO.104(c) Guidance display**

The system should be so designed that it is obvious if the pilot has not taken all the actions necessary for its correct operation.

**AMC AWO.C.TOO.106 Performance (See also Figure 1)**

The factors affecting the behaviour of the aeroplane include, for example, wind conditions, ILS and/or MLS ground facility characteristics, aeroplane configurations, weight, and centre of gravity and should be covered by flight testing.

The demonstration of system performance should comprise at least the following:

- (a) 10 all-engine take-offs;
- (b) take-offs with simulated failure of the critical engine at  $V_{1MIN} + 10$  kt; and
- (c) 2 rejected take-offs with simulated failure of the critical engine at  $V_1$ .

Half of the all-engines take-offs and two of each of the engine failure conditions should be carried out in crosswinds equal to or greater than the level being sought for certification with optional aeroplane and runway configurations. The remainder should be carried out in optional winds in the most adverse aeroplane configuration at two different runways, which represent the reasonable extremes of those likely to be used in service.

In the engine failure take-offs,  $V_R$  should not be less than 28 km/h (15 kt) above the engine failure speed and should be delayed until the path of the aeroplane has stabilised and the aeroplane is converging with the centre line.

The take-off may be begun using external visual reference but, from a speed no greater than 50 % of  $V_1$ , the guidance commands should be followed as accurately as possible without using the external view. To ensure that this is done, it is recommended that the windscreen is blanked.

For ILS- and/or MLS-based systems, compliance may be shown using an ILS and/or MLS, which complies with the requirements for Category III operations in relation to centring error and beam bends along the runway. Allowance may be made for long-term perturbations of the ILS or MLS localiser.

**AMC AWO.C.TOO.108 Warnings**

- (a) The system should be so designed that wherever practicable, a failure will cause the immediate removal of incorrect guidance information from view.
- (b) If failure indications are provided during take-off, these should not be such as to distract the pilot when controlling the aeroplane by visual reference (e.g. a persistent flashing light).

**AMC AWO.C.TOO.111 Aeroplane flight manual — general**

- (a) The flight manual AFM should contain a statement that a system complying with the provisions of this Subpart 4 is approved for reversionary use only. Visual reference should be the primary means of guidance and the pilot should not commence the take-off run unless the visual reference and the reported RVR are within prescribed limits.
- (b) Actual RVR minima to be used are subject to operating operational regulations and may vary from one Member State to another taking account of local circumstances. For this reason, RVR minima should not be included in the aeroplane flight manual AFM as limitations. To aid operational assessment and the establishment of take-off minima, the RVR values encountered during airworthiness certification may be given.

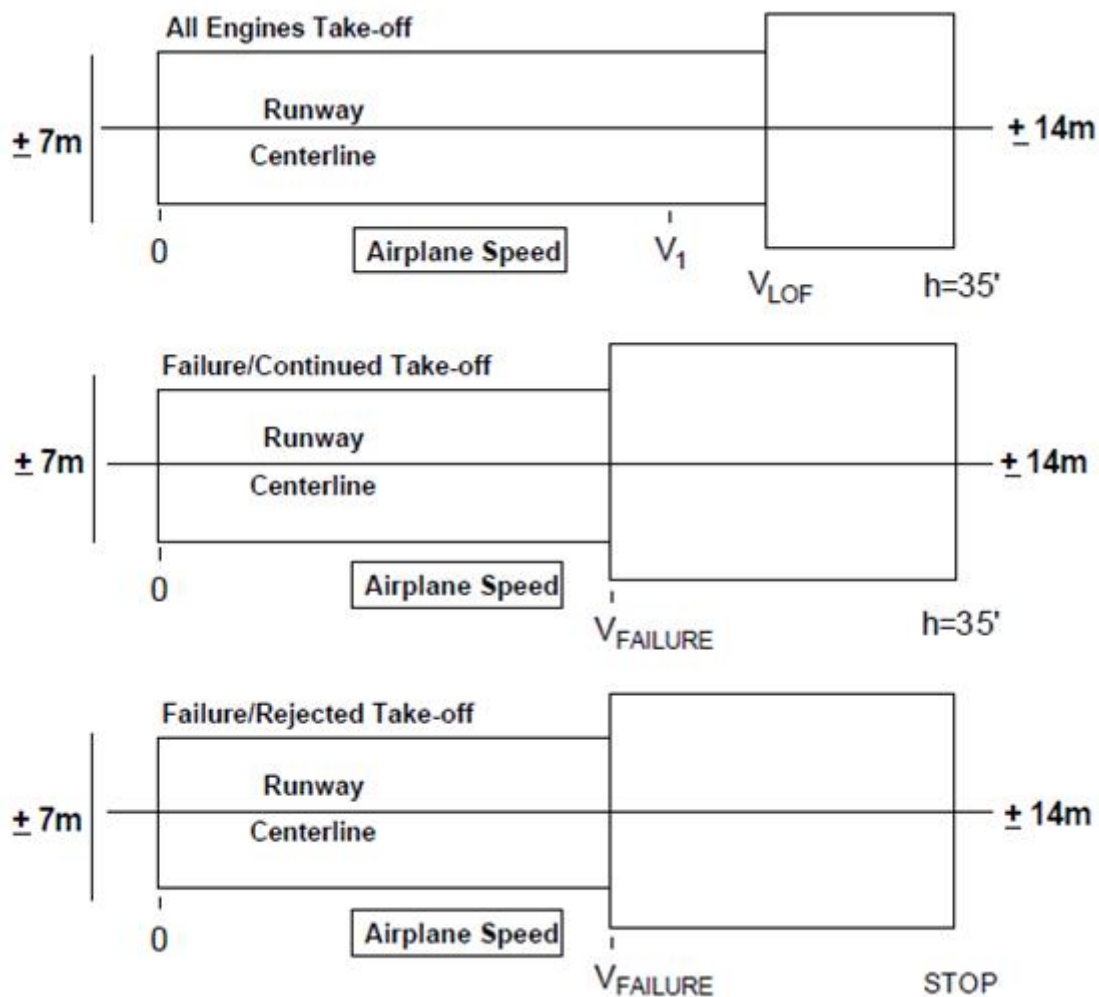

**FIGURE 1: DEVIATION ENVELOPES (CENTRE OF MAINWHEELS)**

INTENTIONALLY LEFT BLANK

## GENERAL ACCEPTABLE MEANS OF COMPLIANCE

### AMC AWO-1 All-weather operations re-certification following the installation of new or modified navigation receivers providing ILS/MLS xLS capability

#### 1 Purpose

The purpose of this AMC is to provide acceptable means of compliance for retrofit certifications, addressing the certification of MLS xLS receivers in the so-called ILS lookalike applications, and the certification of ILS installations with either new or modified receivers, ~~e.g. those designed to provide improved FM immunity.~~

#### 2 Scope

CS-AWO already provides acceptable means of compliance for the certification of new ILS ~~or~~ MLS xLS installations. Where, for an already certificated installation, it is established that the proposed new or modified navigation receiver configuration can be considered to have ILS lookalike characteristics, the contents of this AMC may be used as an alternative for that part of the certification affected by the revised installation.

~~Possible receiver configurations for retrofit applications include:-~~

- ~~a) An ILS receiver from a new supplier.~~
- ~~b) A modified ILS receiver from the same supplier (e.g. for purposes of providing improved FM immunity).~~
- ~~c) A re-packaged receiver from the same supplier (e.g. the ILS partition in an MMR, or the transition from ARINC 700 to 900 series equipment).~~
- ~~d) A stand alone MLS receiver ('ILS look alike').~~
- ~~e) An MLS partition in an MMR ('ILS look alike').~~

This AMC provides acceptable means of compliance for all-weather operations approval. Other generic certification processes (such as software, equipment, and radio approvals etc.) remain equally applicable to new and retrofit applications. These general certification considerations are summarised for reference in paragraph 56 below..

#### 3 ~~Background~~

~~The member States of ICAO agreed to extend the ILS protection date to 2010, to support regional implementation of MLS and to pursue a transition to a GNSS based approach, landing and departure system (GLS) at the COM/OPS 1995 meeting. This decision establishes the need for the incorporation of potentially three approach and landing systems in current and future aircraft. The level of equipage will be an economic decision of the operators. Multi-mode Receiver (MMR) characteristics have been developed by ARINC to provide ILS, MLS and GLS (provisions) functions, as one means of implementing this capability.~~

~~Based on the work of the FAA/JAA AWO Harmonisation Working Group, the JAA has introduced changes to JAR AWO, to define the airworthiness requirements for MLS certification. However the~~

industry also has a requirement to be able to introduce installations such as Multi-Mode Receivers (MMRs) containing one or more types of landing system, to aircraft with an existing all-weather operations airworthiness approval. The JAA has concluded that while the requirement material for new certifications is equally applicable to retrofit applications, the means of compliance required for certification can be simplified, provided the necessary justification is provided.

The work required for certification will be dependent on the justification provided, usually in a certification plan. Within this AMC the justification is termed an 'impact assessment'.

#### 34 Definitions

'ILS lookalike' is the ability of a non-ILS-based navigation receiver function to provide operational characteristics and interface functionality to the rest of the aircraft equivalent to that provided by an ILS-based receiver function. Specifically, in the case of an MLS- or GNSS-based receiver function, the output should be in DDM/micro amps, with a sensitivity equivalent to an ILS receiver taking account of the effects of runway length.

'impact assessment' is the justification that is provided, usually in a certification plan, to determine the scope of work and certification activity that is required for a retrofit certification.

#### 45 Related requirements and documents

This AMC provides ~~alternative~~ **another** means of compliance for retrofit certifications to the following CS-AWO and CS-25 AMC material.

<a href="#">AMC AWO.A.ALS.106</a>	Paragraph 2.1	Flight demonstration — Programme of landings for certification
<del>AMC AWO 161(b)</del>		<del>Failure Conditions</del>
<a href="#">AMC AWO.B.CATII.113</a>	Paragraph 1.1	Flight demonstration — Continuous method (analysis of maximum value)
<a href="#">AMC AWO.B.CATIII.115</a>		Performance demonstrations
<a href="#">AMC1 AWO.B.CATIII.121</a>		Flight demonstrations of failure conditions
<a href="#">AMC AWO.C.TOO.106</a>		Performance (interpretative material)
AMC 25.1329 Paragraph 5.3.4.	Paragraph 5.3.4.	Flight demonstration of autopilot failure conditions coupled to an ILS glide path.

#### 56 General certification considerations

##### 56.1 Certification process

An 'impact assessment' is required to determine the tasks required to achieve approval of new receiver functionality in a retrofit application. Based on the 'impact assessment', the certification plan should consider:

- (a) differences between the current basis of certification and that requested (if applicable);
- (b) the functionality being added; and

- (c) the credit that can be taken for the existing approval.

#### 56.2 Equipment approval

Suitable procedures for equipment approval should be employed. CS-ETSO compliance should be demonstrated where appropriate, including software qualification and receiver environmental qualification to the appropriate levels.

#### 56.3 Aircraft installation approval (CS-25)

The following should be considered for approval of the installation:

- (a) impact on aeroplane SSAs;
- (b) radio approval (e.g. antenna positions, range, polar diagrams, coverage, compatibility between receiver and antenna);
- (c) electromagnetic interference (EMI)/electromagnetic compatibility (EMC) testing;
- (d) functional integration aspects of the receiver with respect to other systems, controls, warnings, and displays;
- (e) electrical loading;
- (f) flight data recorder requirements;
- (g) impact on the aircraft flight manual; and
- (h) certification means of compliance for the receiver installation e.g. ground and/or flight testing; and

#### 67 CS-AWO re-certification of the ~~HS~~ xLS function following the introduction of a new or modified ~~HS~~ xLS navigation receiver installation.

The magnitude of the certification programme will be based upon an 'impact assessment' of the differences between the configuration offered for certification and the pre-existing ~~HS~~ xLS receiver system installed in a given aircraft type. The 'impact assessment' should establish the basis and rationale for the work to be accomplished to obtain certification.

#### 67.1 Impact assessment

The impact assessment should assess the following aspects of the new or modified ~~HS~~ xLS receiver, or receiver function, for equivalence with the existing ~~HS~~ xLS receiver configuration:

- (a) hardware design;
- (b) software design;
- (c) signal processing and functional performance;
- (d) failure analysis; and
- (e) receiver function, installation and integration (e.g. with controls, indicators and ~~warnings~~ alerts)

The impact assessment should also identify any additional considerations. This may include:

- (a) any functionality, or provisions for future functionality, which have no impact on the functionality for which certification is sought; and

(b) any shared resources, which will support future functionality.

Based upon the assumption that the ~~ILS~~ xLS receiver, or receiver function, can be shown to be equivalent to the current ~~ILS~~ xLS configuration, it may be proposed that the new installation be treated as a new ~~ILS~~ xLS receiver for approval on a given aeroplane type.

#### 6.7.2 Failure analysis

The failure characteristics of the new or modified installation should be reviewed in the context of the safety assessments of systems using ~~ILS~~ xLS data, to ensure that the failure characteristics are equivalent to, or are compatible with and do not invalidate, the current safety assessments.

#### 6.7.3 Flight testing

For an installation which can be treated as a new ~~ILS~~ xLS receiver, a flight test programme of typically a minimum of eight ~~10–15~~ approaches terminating in an automatic landing and roll-out (if applicable) using the flight control/guidance system, including a minimum of two ~~ILS~~ xLS facilities should be carried out. The approaches should include captures from both sides of the beam.

The approach and landing performance (flight path deviation, touchdown data, etc.), as appropriate, should be shown to be equivalent to that achieved in the original ~~ILS~~ xLS certification. Recorded flight test data may be required to support the equivalency demonstration.

A demonstration of take off guidance performance should be included where applicable.

#### 6.4 Antenna location

The implication of differences in position of the xLS aircraft antennas should be assessed for their impact on:

- (a) wheel-to-threshold crossing height; and
- (b) lateral and vertical performance.

#### 6.5 Statistical performance assessment

The statistical performance assessment of a currently certificated automatic landing system or HUD system should not have to be re-assessed for the addition of xLS functionality to the aircraft provided the xLS receiver (or the xLS partition of a multi-mode receiver (MMR)) is shown to have satisfactory 'ILS lookalike' characteristics. This assumes that the flight control/guidance system control algorithms are unchanged.

#### 6.6.7.4 Documentation

The following documentation should be provided for certification:

- (a) an impact assessment including effects on SSAs;
- (b) a flight test report; and
- (c) revisions to the flight manual where appropriate.

### ~~7 CS AWO Re-certification following the Introduction of an MLS Navigation Receiver Installation~~

#### ~~7.1 Impact Assessment~~

~~The MLS receiver or receiver function, can be certificated with an 'impact assessment' similar to that required for the re-certification of a new or modified ILS receiver, provided that the unit has~~

~~been shown to have satisfactory 'ILS Look alike' characteristics. The 'impact assessment' should assess the following aspects of the MLS receiver or receiver function, for equivalence with the existing ILS receiver configuration:-~~

- ~~a) Hardware design.~~
- ~~b) Software design.~~
- ~~c) Signal processing and functional performance.~~
- ~~d) Failure analysis.~~
- ~~e) Receiver function, installation and integration (e.g. with controls, indicators and warnings).~~

~~The impact assessment should also identify any additional considerations. This may include:-~~

- ~~a) Any functionality, or provisions for future functionality, which have no impact on the functionality for which certification is sought.~~
- ~~b) Any shared resources, which will support future functionality.~~

~~Based upon the assumption that the MLS receiver or receiver function, can be shown to have "ILS look alike" characteristics, it may be proposed that the new installation be treated as a new ILS receiver for approval on a given aeroplane type.~~

#### ~~7.2 Failure Analysis~~

~~The failure characteristics of the new or modified installation should be reviewed in the context of the safety assessments of systems using ILS data to ensure that either the failure characteristics are equivalent to an ILS receiver or are compatible with and do not invalidate, the current safety assessments.~~

#### ~~7.3 Statistical Performance Assessment~~

~~The statistical performance assessment of a currently certificated automatic landing system or Head Up Display system should not have to be re-assessed for the addition of MLS functionality to the aircraft provided the MLS receiver, or the MLS partition of an MMR, is shown to have satisfactory 'ILS Look alike' characteristics. This assumes that the flight control/guidance system control algorithms are unchanged.~~

#### ~~7.4 Antenna Location~~

~~The implication of differences in position of the MLS and ILS aircraft antennas should be assessed e.g. impact on:-~~

- ~~a) wheel to threshold crossing height.~~
- ~~b) lateral and vertical performance.~~

#### ~~7.5 Flight testing~~

~~For an installation which can be treated as a new ILS receiver, a flight test program of typically a minimum of 10-15 approaches terminating in a landing and rollout (if applicable) using the flight control/guidance system, including a minimum of two MLS facilities should be carried out. The approaches should include captures from the both sides of the beam, and representative wind conditions where antenna positions may impact performance.~~



~~The approach and landing performance (flight path deviation, touchdown data etc.) as appropriate, should be shown to be equivalent to that achieved in the original ILS certification. Recorded flight test data may be required to support the equivalency demonstration.~~

~~A demonstration of take off guidance performance should be included where applicable.~~

#### ~~7.6 Documentation~~

~~The following documentation should be provided for certification:-~~

- ~~1. An Impact Assessment including effects on System Safety Assessments.~~
- ~~2. A Flight Test Report.~~
- ~~3. Revisions to the Flight Manual where appropriate.~~

- 
- i ICAO Standards and Recommended Practices (SARPS) for the Global Navigation Satellite System (GNSS). Annex 10 to the Chicago Convention, Vol 1.
  - ii RTCA / DO-245, Minimum Aviation System Performance Standards (MASPS) for the Local Area Augmentation System (LAAS).
  - iii RTCA / DO-253C, Minimum Operational Performance Standards (MOPS) for GPS Local Area Augmentation System (LAAS) Airborne Equipment.
  - iv ICAO Paper GNSSP-WP-8, Validation of GBAS CAT I Accuracy: A GLS Model and Autoland Simulations for Boeing Airplanes, presented at the ICAO Global Navigation Satellite Systems Panel, Working Group B Meeting, Seattle, WA, May 29 - June 9, 2000.
  - v ICAO NSP Mar 2009 WG/ WP 30 "SARPS Support for Airworthiness Assessments GLS Signal Modeling", presented by Tim Murphy, Bretigny, 17-27 March 2009.
  - vi ICAO NSP May 2010 WG/ WP 19, " SARPS Support for Airworthiness Assessments - More on GLS Signal Modeling" Prepared by Tim Murphy
  - vii T. Murphy, M Harris, C. Shively, L. Azoulai , M. Brenner "Fault Modeling for GBAS Airworthiness Assessments", Proceedings of the Institute of Navigation Global Navigation Satellite System Conference, 2010.
  - viii M. Harris, T. Murphy, "Geometry Screening for GBAS to Meet CAT III Integrity and Continuity Requirements", Proceedings of the Institute of Navigation International Technical Meeting 2007
  - ix DO-253C, "Minimum operational Performance Standards for GPS Local Area Augmentation Airborne Equipment", Section 2.3.9.4
  - x ICAO NSP May10 WG/ WP16, "Computation of Maximum Undetected Error for RRFM in Support of Airworthiness Assessments".
  - xi Neri, P., Macabiau, C., Azoulai, L., "Study of a GBAS Model for CAT II/III Simulations," *Proceedings of the 22nd International Technical Meeting of The Satellite Division of the Institute of Navigation (ION GNSS 2009)*, Savannah, GA, September 2009
  - xii Use of GNSS signals and their augmentations for civil Aviation Navigation during Approaches with Vertical Guidance and Precision Approaches – PhD Thesis P. Neri - 2011