



# Easy Access Rules for Acceptable Means of Compliance for Airworthiness of Products, Parts and Appliances (AMC-20) (Amendment 6)

## **EASA eRules: aviation rules for the 21st century**

Rules and regulations are the core of the European Union civil aviation system. The aim of the **EASA eRules** project is to make them **accessible** in an efficient and reliable way to stakeholders.

**EASA eRules** will be a comprehensive, single system for the drafting, sharing and storing of rules. It will be the single source for all aviation safety rules applicable to European airspace users. It will offer easy (online) access to all rules and regulations as well as new and innovative applications such as rulemaking process automation, stakeholder consultation, cross-referencing, and comparison with ICAO and third countries' standards.

To achieve these ambitious objectives, the **EASA eRules** project is structured in ten modules to cover all aviation rules and innovative functionalities.

The **EASA eRules** system is developed and implemented in close cooperation with Member States and aviation industry to ensure that all its capabilities are relevant and effective.

Published November 2018<sup>1</sup>

---

<sup>1</sup> The published date represents the date when the consolidated version of the document was generated.

## **DISCLAIMER**

This version is issued by the European Aviation Safety Agency (EASA) in order to provide its stakeholders with an updated and easy-to-read publication. It has been prepared by putting together all applicable acceptable means of compliance (AMC). However, this is not an official publication and EASA accepts no liability for damage of any kind resulting from the risks inherent in the use of this document.

---

## NOTE FROM THE EDITOR

AMC paragraph titles are colour-coded and can be identified according to the illustration below. The EASA Executive Director (ED) decision through which the paragraph was introduced or last amended is indicated below the paragraph title(s) *in italics*.

**Acceptable means of compliance**

*ED decision*

The format of this document has been adjusted to make it user-friendly and for reference purposes. Any comments should be sent to [erules@easa.europa.eu](mailto:erules@easa.europa.eu).

## INCORPORATED AMENDMENTS

### AMC (ED DECISIONS)

Incorporated ED Decision	AMC Issue No, Amendment No	Applicability date
<a href="#">ED Decision 2003/12/RM</a>	AMC-20/ Initial issue	5/11/2003
<a href="#">ED Decision 2006/012/R</a>	AMC-20/ Amendment 1	29/12/2006
<a href="#">ED Decision 2007/019/R</a>	AMC-20/ Amendment 2	26/12/2007
<a href="#">ED Decision 2008/004/R</a>	AMC-20/ Amendment 3	2/5/2008
<a href="#">ED Decision 2008/007/R</a>	AMC-20/ Amendment 4	5/9/2008
<a href="#">ED Decision 2009/019/R</a>	AMC-20/ Amendment 5	23/12/2009
<a href="#">ED Decision 2010/003/R</a>	AMC-20/ Amendment 6	26/07/2010

*Note: To access the official versions, please click on the hyperlinks provided above.*

---

## TABLE OF CONTENTS

<b>Disclaimer .....</b>	<b>3</b>
<b>Note from the editor .....</b>	<b>4</b>
<b>Incorporated amendments .....</b>	<b>5</b>
<b>Table of contents .....</b>	<b>6</b>
<b>Preamble .....</b>	<b>11</b>
<b>AMC-20-1 .....</b>	<b>13</b>
<b>AMC 20-1 Certification of Aircraft Propulsion Systems Equipped with Electronic Control     Systems.....</b>	<b>13</b>
<b>AMC 20-2 .....</b>	<b>18</b>
<b>AMC 20-2 Certification of Essential APU Equipped with Electronic Controls.....</b>	<b>18</b>
Appendix to AMC 20-2 .....	23
<b>AMC 20-3 .....</b>	<b>24</b>
<b>AMC 20-3 Certification of Engines Equipped with Electronic Engine Control Systems.....</b>	<b>24</b>
<b>AMC 20-4 .....</b>	<b>54</b>
<b>AMC 20-4 Airworthiness Approval and Operational Criteria For the Use of Navigation     Systems in European Airspace Designated For Basic RNAV Operations.....</b>	<b>54</b>
Annex 1 to AMC 20-4 – GPS Integrity Monitoring (RAIM) Prediction Program.....	60
<b>AMC 20-5 .....</b>	<b>61</b>
<b>AMC 20-5 Airworthiness Approval and Operational Criteria for the use of the Navstar Global     Positioning System (GPS) .....</b>	<b>61</b>
Appendix A to AMC 20-5 .....	68
<b>AMC 20-6 .....</b>	<b>70</b>
<b>AMC 20-6 Extended Range Operation with Two-Engine Aeroplanes ETOPS Certification and     Operation.....</b>	<b>70</b>
Appendix 1 to AMC 20-6 – Propulsion System Reliability Assessment .....	97
Appendix 2 to AMC 20-6 – Aircraft Systems Reliability Assessment.....	103
Appendix 3 to AMC 20-6 – Suitable en-route alternate aerodromes .....	106
Appendix 4 to AMC 20-6 – ETOPS Maintenance Requirements.....	109

---

Appendix 5 to AMC 20-6 – 90 minutes or less ETOPS Operational Program Criteria ....	112
Appendix 6 to AMC 20-6 – Not used .....	114
Appendix 7 to AMC 20-6 – Reduction of operator's in-service experience requirement prior to the granting of an ETOPS Operational Approval ('Accelerated ETOPS Operational Approval') .....	115
<b>AMC 20-8 .....</b>	<b>121</b>
<b>AMC 20-8 Occurrence Reporting .....</b>	<b>121</b>
Annex 1 to AMC 20-8 – Reportable occurrences to specific systems .....	136
<b>AMC 20-9 .....</b>	<b>139</b>
<b>AMC 20-9 Acceptable Means of Compliance for the Approval of Departure Clearance via     Data Communications over ACARS.....</b>	<b>139</b>
Appendix 1 to AMC 20-9 PDC versus DCL: A Comparison.....	146
Appendix 2 to AMC 20-9 Common Terms.....	147
<b>AMC 20-10 .....</b>	<b>148</b>
<b>AMC 20-10 Acceptable Means of Compliance for the Approval of Digital ATIS via Data Link     over ACARS .....</b>	<b>148</b>
Appendix 1 to AMC 20-10 Common Terms.....	155
<b>AMC 20-11 .....</b>	<b>156</b>
<b>AMC 20-11 Acceptable Means of Compliance for the Approval of use of Initial Services for     Air-Ground Data Link in Continental Airspace.....</b>	<b>156</b>
Appendix 1 to AMC 20-11 Common Terms.....	164
<b>AMC 20-12 .....</b>	<b>166</b>
<b>AMC 20-12 Recognition of FAA Order 8400.12a for RNP-10 Operations.....</b>	<b>166</b>
<b>AMC 20-13 .....</b>	<b>172</b>
<b>AMC 20-13 Certification of Mode S Transponder Systems for Enhanced Surveillance.....</b>	<b>172</b>
Annex 1 to AMC 20-13 .....	182
Annex 2 to AMC 20-13 Template for Aircraft Flight Manual (AFM) Supplement.....	185
Annex 3 to AMC 20-13 Extract from EUROCAE Document ED-26: Table 13: Altitude Encoding Transition Points .....	186
<b>AMC 20-20 .....</b>	<b>187</b>
<b>AMC 20-20 Continuing Structural Integrity Programme .....</b>	<b>187</b>
Appendix 1 to AMC 20-20 Guidelines for the development of a Supplementary Structural Inspection Programme .....	199

---

Appendix 2 to AMC 20-20 Guidelines for the development of a programme to preclude the occurrence of widespread fatigue damage .....	206
Appendix 3 to AMC 20-20 Guidelines for establishing instructions for continued airworthiness of structural repairs and modifications .....	226
Annex 1 to Appendix 3 to AMC 20-20: Approval Process for New Repairs .....	243
Annex 2 to Appendix 3 to AMC 20-20: Assessment of Existing Repairs.....	244
Annex 3 to Appendix 3 to AMC 20-20: Repairs and Modifications to Removable Structural Components.....	250
Annex 4 to Appendix 3 to AMC 20-20: Service Bulletin Review Process.....	253
Annex 5 to Appendix 3 to AMC 20-20: List of Significant STCs that may Adversely Affect Fatigue Critical Structure.....	257
Appendix 4 to AMC 20-20 Guidelines for the development of a corrosion control programme .....	258
Appendix 5 to AMC 20-20 Guidelines for the development of a SB review and mandatory modification programme .....	270
<b>AMC 20-21 .....</b>	<b>275</b>
<b>AMC 20-21 Programme to enhance aeroplane Electrical Wiring Interconnection System (EWIS) maintenance .....</b>	<b>275</b>
Appendix A to AMC 20-21 Enhanced Zonal Analysis Logic Diagram and Steps.....	291
Appendix B to AMC 20-21 Examples of Typical EZAP Worksheets .....	299
Appendix C to AMC 20-21 Determination if a major change to an aircraft should be specifically subjected to an EZAP .....	306
Appendix D to AMC 20-21 .....	309
Appendix E to AMC 20-21 Causes of Wire Degradation .....	310
<b>AMC 20-22 .....</b>	<b>312</b>
<b>AMC 20-22 Aeroplane Electrical Wiring Interconnection System Training Programme .....</b>	<b>312</b>
Appendix A to AMC 20-22 – EWIS Minimum Initial Training Programme for Group 1 and 2.....	319
Appendix B to AMC 20-22 – EWIS Minimum Initial Training Programme for Group 3 through 8.....	321
Appendix C to AMC 20-22 – Curriculum and Lessons Plan .....	323
<b>AMC 20-23 .....</b>	<b>338</b>
<b>AMC 20-23 Development of Electrical Standard Wiring Practices documentation.....</b>	<b>338</b>
Appendix A: Groups, Major Topics, Standardised Sequence and Description of Minimum Content.....	345



---

<b>AMC 20-24 .....</b>	<b>347</b>
<b>AMC 20-24 Certification Considerations for the Enhanced ATS in Non-Radar Areas using ADS-B Surveillance (ADS-B-NRA) Application via 1090 MHz Extended Squitter .....</b>	<b>347</b>
Appendix 1 to AMC 20-24 .....	361
Appendix 2 to AMC 20-24 .....	362
Appendix 3 to AMC 20-24 .....	363
Appendix 4 to AMC 20-24 .....	365
<b>AMC 20-26 .....</b>	<b>367</b>
<b>AMC 20-26 Airworthiness Approval and Operational Criteria for RNP Authorisation Required (RNP AR) Operations .....</b>	<b>367</b>
Appendix 1 to AMC 20-26 Glossary .....	394
Appendix 2 to AMC 20-26 Training and Crew Qualification Issues .....	397
Appendix 3 to AMC 20-26 RNP Operational Considerations .....	403
Appendix 4 to AMC 20-26 Acceptable Methods for Flight Technical Error Assessment for RNP .....	408
Appendix 5 to AMC 20-26 Flight Operation Safety Assessments .....	412
Appendix 6 AMC 20-26/PBN Manual/AC90-101 Comparison .....	415
<b>AMC 20-27 .....</b>	<b>423</b>
<b>AMC 20-27 Airworthiness Approval and Operational Criteria for RNP APPROACH (RNP APCH) Operations Including APV BARO-VNAV Operations .....</b>	<b>423</b>
Appendix 1 to AMC 20-27 Glossary .....	445
Appendix 2 to AMC 20-27 Operational Characteristics of the Procedure and its Operational Use .....	448
Appendix 3 to AMC 20-27 Alternate Navigation Database Integrity Check .....	449
Appendix 4 to AMC 20-27 Operational Procedures .....	451
Appendix 5 to AMC 20-27 Flight Crew Training Syllabus .....	456
<b>AMC 20-29 .....</b>	<b>458</b>
<b>AMC 20-29 Composite Aircraft Structure .....</b>	<b>458</b>
Appendix 1 to AMC 20-29 – Applicable CSs and Relevant Guidance .....	485
Appendix 2 to AMC 20-29 – Definitions .....	488
Appendix 3 to AMC 20-29 – Change of Composite Material and/or Process .....	491
<b>AMC 20-115B .....</b>	<b>495</b>
<b>AMC 20-115B Recognition of Eurocae ED-12B / RTCA DO-178B .....</b>	<b>495</b>

---

<b>AMC 20-128A .....</b>	<b>496</b>
<b>AMC 20-128A Design Considerations for Minimizing Hazards Caused by Uncontained Turbine Engine and Auxiliary Power Unit Rotor Failure .....</b>	<b>496</b>
Appendix 1 to AMC 20-128A User's Manual .....	514

## PREAMBLE

ED Decision 2010/003/R

### Amendment 6

The following is a list of paragraphs affected by this amendment:

AMC 20-29	Created ( <a href="#">NPA 2009-06</a> )
-----------	---

ED Decision 2009/019/R

### Amendment 5

The following is a list of paragraphs affected by this amendment:

AMC 20-26	Created ( <a href="#">NPA 2008-14</a> )
AMC 20-27	Created ( <a href="#">NPA 2008-14</a> )

ED Decision 2008/007/R

### Amendment 4

The following is a list of paragraphs affected by this amendment:

AMC 20-21	Created ( <a href="#">NPA 2007-01</a> )
AMC 20-22	Created ( <a href="#">NPA 2007-01</a> )
AMC 20-23	Created ( <a href="#">NPA 2007-01</a> )

ED Decision 2008/004/R

### Amendment 3

The following is a list of paragraphs affected by this amendment:

AMC 20-24	Created ( <a href="#">NPA 2007/05</a> )
-----------	---

ED Decision 2007/019/R

### Amendment 2

The following is a list of paragraphs affected by this amendment:

AMC 20-1	Amended ( <a href="#">NPA 04/2005</a> )
AMC 20-3	Created ( <a href="#">NPA 04/2005</a> )
AMC 20-11	Created ( <a href="#">NPA 11/2005</a> )
AMC 20-20	Created ( <a href="#">NPA 05/2006</a> )

ED Decision 2006/012/R

### Amendment 1

The following is a list of paragraphs affected by this amendment:

AMC 20-9	Created
AMC 20-10	Created
AMC 20-12	Created
AMC 20-13	Created



# AMC-20-1

## AMC 20-1 Certification of Aircraft Propulsion Systems Equipped with Electronic Control Systems

ED Decision 2007/019/R

### 1 GENERAL

The existing specific regulations for Engine, Propeller and aircraft certification may require special interpretation for Engines and Propellers equipped with electronic control systems. Because of the nature of this technology and because of the greater interdependence of engine, propeller and aircraft systems, it has been found necessary to prepare acceptable means of compliance specifically addressing the certification of these control systems.

This AMC 20-1 addresses the compliance tasks relating to certification of the installation of propulsion systems equipped with electronic control systems. [AMC 20-3](#) is dedicated to certification of Engine Control Systems but identifies some engine installation related issues, that should be read in conjunction with this AMC 20-1.

Like any acceptable means of compliance, it is issued to outline issues to be considered during demonstration of compliance with the certification specifications.

### 2 RELEVANT SPECIFICATIONS

For aircraft certification, the main related certification specifications are:

For aeroplanes in CS-25 (and, where applicable, CS-23)

- Paragraphs, 33, 581, 631, 899, 901, 903, 905, 933, 937, 939, 961, 994, 995, 1103(d), 1143 (except (d)), 1149, 1153, 1155, 1163, 1181, 1183, 1189, 1301, 1305, 1307(c), 1309, 1337, 1351(b)(d), 1353(a)(b), 1355(c), 1357, 1431, 1461, 1521(a), 1527.
- For rotorcraft: equivalent specifications in CS-27 and CS-29.

### 3 SCOPE

This acceptable means of compliance is relevant to certification specifications for aircraft installation of Engines or Propellers with electronic control systems, whether using electrical or electronic (analogue or digital) technology.

It gives guidance on the precautions to be taken for the use of electrical and electronic technology for Engine and Propeller control, protection and monitoring, and, where applicable, for integration of functions specific to the aircraft.

Precautions have to be adapted to the criticality of the functions. These precautions may be affected by the degree of authority of the system, the phase of flight, and the availability of a back-up system.

This document also discusses the division of compliance tasks between the applicants for Engine, Propeller (when applicable) and aircraft type certificates. This guidance relates to issues to be considered during aircraft certification.

It does not cover APU control systems APU, which are not used as “propulsion systems”, are addressed in the dedicated [AMC 20-2](#).

## 4 PRECAUTIONS

### (a) General

The introduction of electrical and electronic technology can entail the following:

- A greater dependence of the Engine or Propeller on the aircraft owing to the use of electrical power and/or data supplied from the aircraft.
- an increased integration of control and related indication functions,
- an increased risk of significant failures common to more than one Engine or Propeller of the aircraft which might, for example, occur as a result of -
  - Insufficient protection from electromagnetic disturbance (lightning, internal or external radiation effects),
  - Insufficient integrity of the aircraft electrical power supply,
  - Insufficient integrity of data supplied from the aircraft,
  - Hidden design faults or discrepancies contained within the design of the propulsion system control software or complex electronic hardware, or
  - Omissions or errors in the system/software specification.

Special design and integration precautions should therefore be taken to minimise these risks.

### (b) Objective

The introduction of electronic control systems should provide for the aircraft at least the equivalent safety, and the related reliability level, as achieved in aircraft equipped with Engine and Propellers using hydromechanical control and protection systems.

When possible, early co-ordination between the Engine, Propeller and aircraft applicants is recommended in association with the Agency as discussed under paragraph (5) of this AMC.

### (c) Precautions relating to electrical power supply and data from the aircraft

When considering the objectives of paragraph 4 (a) or (b), due consideration should be given to the reliability of electrical power and data supplied to the electronic control systems and peripheral components. The potential adverse effects on Engine and Propeller operation of any loss of electrical power supply from the aircraft or failure of data coming from the aircraft are assessed during the Engine and Propeller certification.

During aircraft certification, the assumptions made as part of the Engine and Propeller certification on reliability of aircraft power and data should be checked for consistency with the actual aircraft design.

Aircraft should be protected from unacceptable effects of faults due to a single cause, simultaneously affecting more than one Engine or Propeller. In particular, the following cases should be considered:

- Erroneous data received from the aircraft by the Engine/Propeller control system if the data source is common to more than one Engine/Propeller (e.g. air data sources, autothrottle synchronising), and

- Control system operating faults propagating via data links between Engine/Propellers (e.g. maintenance recording, common bus, cross-talk, autofeathering, automatic reserve power system).

Any precautions needed may be taken either through the aircraft system architecture or by logic internal to the electronic control system.

(d) Local events

For Engine and Propeller certification, effects of local events should be assessed.

Whatever the local event, the behaviour of the electronic control system should not cause a hazard to the aircraft. This will require consideration of effects such as the control of the thrust reverser deployment, the over-speed of the Engine, transients effects or inadvertent Propeller pitch change under any flight condition.

When the demonstration that there is no hazard to the aircraft is based on the assumption that there exists another function to afford the necessary protection, it should be shown that this function is not rendered inoperative by the same local event (including destruction of wires, ducts, power supplies).

Such assessment should be reviewed during aircraft certification.

(e) Software and Programmable Logic Devices

The acceptability of levels and methods used for development and verification of software and Programmable Logic Devices which are part of the Engine and Propeller type designs should have been agreed between the aircraft, Engine and Propeller designers prior to certification activity.

(f) Environmental effects

The validated protection levels for the Engine and Propeller electronic control systems as well as their emissions of radio frequency energy are established during the Engine and Propeller certification and are contained in the instructions for installation. For the aircraft certification, it should be substantiated that these levels are adequate.

## **5 INTER-RELATION BETWEEN ENGINE, PROPELLER AND AIRCRAFT CERTIFICATION**

(a) Objective

To satisfy the aircraft certification specifications, such as CS 25.901, CS 25.903 and CS 25.1309, an analysis of the consequences of failures of the system on the aircraft has to be made. It should be ensured that the software levels and safety and reliability objectives for the electronic control system are consistent with these requirements.

(b) Interface Definition

The interface has to be identified for the hardware and software aspects between the Engine, Propeller and the aircraft systems in the appropriate documents.

The Engine/Propeller/aircraft documents should cover in particular -

- The software quality level (per function if necessary),
- The reliability objectives for loss of Engine/Propeller control or significant change in thrust, (including IFSD due to control system malfunction), of faulty parameters,
- The degree of protection against lightning or other electromagnetic effects (e.g. level of induced voltages that can be supported at the interfaces),

- Engine, Propeller and aircraft interface data and characteristics, and
- Aircraft power supply and characteristics (if relevant).

(c) Distribution of Compliance Demonstration

The certification tasks of the aircraft propulsion system equipped with electronic control systems may be shared between the Engine, Propeller and aircraft certification. The distribution between the different certification activities should be identified and agreed with the Agency and/or the appropriate Engine and aircraft Authorities: (an example is given in paragraph (6)).

Appropriate evidence provided for Engine and Propeller certification should be used for aircraft certification. For example, the quality of any aircraft function software and aircraft/Engine/Propeller interface logic already demonstrated for Engine or Propeller certification should need no additional substantiation for aircraft certification.

Aircraft certification should deal with the specific precautions taken in respect of the physical and functional interfaces with the Engine/Propeller.

**6. TABLE**

An example of distribution between Engine and aircraft certification. (When necessary, a similar approach should be taken for Propeller applications).

TASK	SUBSTANTIATION UNDER CS-E	SUBSTANTIATION UNDER CS-25	
		with engine data	with aircraft data
ENGINE CONTROL AND PROTECTION	<ul style="list-style-type: none"> <li>– Safety objective</li> <li>– Software level</li> </ul>	<ul style="list-style-type: none"> <li>– Consideration of common mode effects (including software)</li> <li>– Reliability</li> <li>– Software level</li> </ul>	–
MONITORING	<ul style="list-style-type: none"> <li>– Independence of control and monitoring parameters</li> </ul>	<ul style="list-style-type: none"> <li>– Monitoring parameter reliability</li> </ul>	<ul style="list-style-type: none"> <li>– Indication system reliability</li> <li>– Independence engine/ engine</li> </ul>
AIRCRAFT DATA	<ul style="list-style-type: none"> <li>– Protection of engine from aircraft data failures</li> <li>– Software level</li> </ul>	–	<ul style="list-style-type: none"> <li>– Aircraft data reliability</li> <li>– Independence engine/ engine</li> </ul>
THRUST REVERSER CONTROL/ MONITORING	<ul style="list-style-type: none"> <li>– Software level</li> </ul>	<ul style="list-style-type: none"> <li>– System reliability</li> <li>– Architecture</li> <li>– Consideration of common mode effects (including software)</li> </ul>	<ul style="list-style-type: none"> <li>– Safety objectives</li> </ul>



TASK	SUBSTANTIATION UNDER CS-E	SUBSTANTIATION UNDER CS-25	
		with engine data	with aircraft data
CONTROL SYSTEM ELECTRICAL SUPPLY	– Reliability or quality Requirement of aircraft supply, if used		– Reliability of quality of aircraft supply, if used – Independence engine/ engine
ENVIRONMENTAL CONDITIONS	– Equipment protection	– Declared capability	– Aircraft design
LIGHTNING AND OTHER ELECTROMAGNETIC EFFECTS	– Equipment protection Electromagnetic emissions	– Declared capability – Declared emissions	– Aircraft wiring protection and electromagnetic compatibility
FIRE PROTECTION	– Equipment protection	– Declared capability	– Aircraft design

[Amdt 20/2]

## AMC 20-2

### AMC 20-2 Certification of Essential APU Equipped with Electronic Controls

*ED Decision 2003/12/RM*

#### 1 GENERAL

The existing regulations for APU and aircraft certification may require special interpretation for essential APU equipped with electronic control systems. Because of the nature of this technology it has been found necessary to prepare acceptable means of compliance specifically addressing the certification of these control systems.

Like any acceptable means of compliance, the content of this document is not mandatory. It is issued for guidance purposes, and to outline a method of compliance with the airworthiness code. In lieu of following this method, an alternative method may be followed, provided that this is agreed by the Agency as an acceptable method of compliance with the airworthiness code.

This document discusses the compliance tasks relating to both the APU and the aircraft certification.

#### 2 REFERENCE SPECIFICATIONS

##### 2.1 APU Certification

CS-APU

Book 1, paragraph 2(c)

Book 1, Section A, paragraphs 10(b), 20, 80, 90, 210, 220, 280 and 530

Book 2, Section A, AMC CS-APU 20

##### 2.2 Aircraft Certification

Aeroplane: CS-25

Paragraphs 581, 899, 1301, 1307(c), 1309, 1351(b)(d), 1353(a)(b), 1355(c), 1357, 1431, 1461, 1524, 1527

A9011, A903, A939, A1141, A1181, A1183, A1189, A1305, A1337, A1521, A1527, B903, B1163

#### 3 SCOPE

This acceptable means of compliance provides guidance for electronic (analogue and digital) essential APU control systems, on the interpretation and means of compliance with the relevant APU and aircraft certification requirements.

It gives guidance on the precautions to be taken for the use of electronic technology for APU control, protection and monitoring and, where applicable, for integration of functions specific to the aircraft.

Precautions have to be adapted to the criticality of the functions. These precautions may be affected by -

Degree of authority of the system,

Phase of flight,  
Availability of back-up system.

This document also discusses the division of compliance tasks between the APU and aircraft certification.

## **4 PRECAUTIONS**

### **4.1 General**

The introduction of electronic technology can entail the following:

- (a) A greater dependence of the APU on the aircraft owing to the use of electrical power and/or data supplied from the aircraft,
- (b) Risk of significant failures which might, for example, occur as a result of -
  - (i) Insufficient protection from electromagnetic disturbance (lightning, internal or external radiation effects),
  - (ii) Insufficient integrity of the aircraft electrical power supply,
  - (iii) Insufficient integrity of data supplied from the aircraft,
  - (iv) Hidden design faults or discrepancies contained within the design of the APU control software, or
  - (v) Omissions or errors in the system specification.

Special design and integration precautions must therefore be taken to minimise these risks.

### **4.2 Objective**

The introduction of electronic control systems should provide for the aircraft at least the equivalent safety, and the related reliability level, as achieved by essential APU equipped with hydromechanical control and protection systems.

This objective, when defined during the aircraft/APU certification for a specific application, will be agreed with the Agency.

### **4.3 Precautions relating to APU control, protection and monitoring**

The software associated with APU control, protection and monitoring functions must have a quality level and architecture appropriate to their criticality (see paragraph 4.2).

For digital systems, any residual errors not activated during the software development and certification process could cause an unacceptable failure. (RTCA DO178A (or the equivalent EUROCAE ED 12A) constitutes an acceptable means of compliance for software development and certification. The APU software should be at least level 2 according to this document. In some specific cases, level 1 may be more appropriate.

It should be noted, however, that the DO178A states in section 3.3 -

"It is appreciated that, with the current state of knowledge, the software disciplines described in this document may not, in themselves, be sufficient to ensure that the overall system safety and reliability targets have been achieved. This is particularly true for certain critical systems, such as fully authority fly-by-wire systems. In such cases it is accepted that other measures, usually within the system, in addition to a high level of software discipline may be necessary to achieve these safety objectives and demonstrate that they have been met.

It is outside the scope of this document to suggest or specify these measures, but in accepting that they may be necessary, it is also the intention to encourage the development of software techniques which could support meeting the overall system safety objectives."

#### 4.4 Precautions relating to APU independence from the aircraft

##### 4.4.1 Precautions relating to electrical power supply and data from the aircraft

When considering the objectives of paragraph 4.2, due consideration must be given to the reliability of electrical power and data supplied to the electronic controls and peripheral components. Therefore the potential adverse effects on APU operation of any loss of electrical power supply from the aircraft or failure of data coming from the aircraft must be assessed during the APU certification.

###### (a) Electrical power

The use of either the aircraft electrical power network or electrical power sources specific to the APU, or the combination of both, may meet the objectives.

If the aircraft electrical system supplies power to the APU control system at any time, the power supply quality, including transients or failures, must not lead to a situation identified during the APU certification which is considered during the aircraft certification to be a hazard to the aircraft.

###### (b) Data

The following cases should be considered:

- (i) Erroneous data received from the aircraft by the APU control system, and
- (ii) Control system operating faults propagating via data links.

In certain cases, defects of aircraft input data may be overcome by other data references specific to the APU in order to meet the objectives.

##### 4.4.2 Local Events

- (a) In designing an electronic control system to meet the objectives of paragraph 4.2, special consideration needs to be given to local events.

Examples of local events include fluid leaks, mechanical disruptions, electrical problems, fires or overheat conditions. An overheat condition results when the temperature of the electronic control unit is greater than the maximum safe design operating temperature declared during the APU certification. This situation can increase the failure rate of the electronic control system.

- (b) Whatever the local event, the behaviour of the electronic control system must not cause a hazard to the aircraft. This will require consideration of effects such as the overspeed of the APU.

When the demonstration that there is no hazard to the aircraft is based on the assumption that there exists another function to afford the necessary protection, it must be shown that this function is not rendered inoperative by the same local event (including destruction of wires, ducts, power supplies).

- (c) Specific design features or analysis methods may be used to show compliance with respect to hazardous effects. Where this is not possible, for example due to the variability or the complexity of the failure sequence, then testing may be required. These tests must be agreed with the Agency.

#### 4.4.3 Lightning and other electromagnetic effects

Electronic control systems are sensitive to lightning and other electromagnetic interference. The system design must incorporate sufficient protection in order to ensure the functional integrity of the control system when subjected to designated levels of electric or electromagnetic inductions, including external radiation effects.

The validated protection levels for the APU electronic control system must be detailed during the APU certification in an approved document. For aircraft certification, it must be substantiated that these levels are adequate.

#### 4.5 Other functions integrated into the electronic control system

If functions other than those directly associated with the control of the APU are integrated into the electronic control system, the APU certification should take into account the applicable aircraft requirements.

## 5 INTER-RELATION BETWEEN APU AND AIRCRAFT CERTIFICATION

### 5.1 Objective

To satisfy the CS aircraft requirements, such as CS 25A901, CS 25A903 and CS 25.1309, an analysis of the consequences of failures of the system on the aircraft has to be made. It should be ensured that the software levels and safety and reliability objectives for the electronic control system are consistent with these requirements.

### 5.2 Interface definition

The interface has to be identified for the hardware and software aspects between the APU and aircraft systems in the appropriate documents.

The APU documents should cover in particular -

- (a) The software quality level (per function if necessary),
- (b) The reliability objectives for - APU shut-down in flight, Loss of APU control or significant change in performance, Transmission of faulty parameters,
- (c) The degree of protection against lightning or other electromagnetic effects (e.g. level of induced voltages that can be supported at the interfaces),
- (d) APU and aircraft interface data and characteristics, and
- (e) Aircraft power supply and characteristics (if relevant).

### 5.3 Distribution of compliance demonstrations

The certification of the APU equipped with electronic controls and of the aircraft may be shared between the APU certification and aircraft certification. The distribution between the APU certification and the aircraft certification must be identified and agreed with the Agency and/or the appropriate APU and aircraft Authorities (an example is given in appendix).

Appropriate evidence provided for APU certification should be used for aircraft certification. For example, the quality of any aircraft function software and aircraft/APU

---

interface logic already demonstrated for APU certification should need no additional substantiation for aircraft certification.

Aircraft certification must deal with the specific precautions taken in respect of the physical and functional interfaces with the APU.

## Appendix to AMC 20-2

ED Decision 2003/12/RM

An example of tasks distribution between APU and aircraft certification

FUNCTIONS OR INSTALLATION CONDITIONS	SUBSTANTIATION UNDER CS-APU	SUBSTANTIATION UNDER CS-25	
APU CONTROL AND PROTECTION	<ul style="list-style-type: none"> <li>– Safety objective</li> <li>– Software level</li> </ul>	<ul style="list-style-type: none"> <li>– Reliability</li> <li>– Software level</li> </ul>	
MONITORING	<ul style="list-style-type: none"> <li>– Independence of control and monitoring parameters</li> </ul>	<ul style="list-style-type: none"> <li>– Monitoring parameter reliability</li> </ul>	<ul style="list-style-type: none"> <li>– Indication system reliability</li> </ul>
AIRCRAFT DATA	<ul style="list-style-type: none"> <li>– Protection of APU from aircraft data failures</li> <li>– Software level</li> </ul>		<ul style="list-style-type: none"> <li>– Aircraft data reliability</li> </ul>
CONTROL SYSTEM ELECTRICAL SUPPLY			<ul style="list-style-type: none"> <li>– Reliability and quality of aircraft supply if used</li> </ul>
ENVIRONMENTAL CONDITIONS, LIGHTNING AND OTHER ELECTRO-MAGNETIC EFFECTS	<ul style="list-style-type: none"> <li>– Equipment protection</li> </ul>	<ul style="list-style-type: none"> <li>– Declared capability</li> </ul>	<ul style="list-style-type: none"> <li>– Aircraft design</li> <li>– Aircraft wiring protection</li> </ul>

## AMC 20-3

### AMC 20-3 Certification of Engines Equipped with Electronic Engine Control Systems

*ED Decision 2007/019/R*

#### (1) PURPOSE

The existing certification specifications of CS-E for Engine certification may require specific interpretation for Engines equipped with Electronic Engine Control Systems (EECS), with special regard to interface with the certification of the aircraft and/or Propeller when applicable. Because of the nature of this technology, it has been considered useful to prepare acceptable means of compliance specifically addressing the certification of these control systems.

Like any acceptable means of compliance, it is issued to outline issues to be considered during demonstration of compliance with the Engine certification specifications.

#### (2) SCOPE

This acceptable means of compliance is relevant to Engine certification specifications for EECS, whether using electrical or electronic (analogue or digital) technology. This is in addition to other acceptable means of compliance such as AMC E 50 or AMC E 80.

It gives guidance on the precautions to be taken for the use of electrical and electronic technology for Engine control, protection, limiting and monitoring functions, and, where applicable, for integration of aircraft or Propeller functions. In these latter cases, this document is applicable to such functions integrated into the EECS, but only to the extent that these functions affect compliance with CS-E specifications.

The text deals mainly with the thrust and power functions of an EECS, since this is the prime function of the Engine. However, there are many other functions, such as bleed valve control, that may be integrated into the system for operability reasons. The principles outlined in this AMC apply to the whole system.

This document also discusses the division of compliance tasks for certification between the applicants for Engine, Propeller (when applicable) and aircraft type certificates. This guidance relates to issues to be considered during engine certification. [AMC 20-1](#) addresses issues associated with the engine installation in the aircraft.

The introduction of electrical and electronic technology can entail the following:

- a greater dependence of the Engine on the aircraft owing to the increased use of electrical power or data supplied from the aircraft,
- an increased integration of control and related indication functions,
- an increased risk of significant Failures common to more than one Engine of the aircraft which might, for example, occur as a result of:
  - Insufficient protection from electromagnetic disturbance (lightning, internal or external radiation effects) (see CS-E 50(a)(1), CS E-80 and CS-E 170),
  - Insufficient integrity of the aircraft electrical power supply (see CS-E 50(h)),
  - Insufficient integrity of data supplied from the aircraft (see CS-E 50(g)),



- Hidden design Faults or discrepancies contained within the design of the propulsion system control software or complex electronic hardware (see CS-E 50(f)), or
- Omissions or errors in the system/software specification (see CS-E 50(f)).

Special design and integration precautions should therefore be taken to minimise any adverse effects from the above.

### (3) RELEVANT SPECIFICATIONS AND REFERENCE DOCUMENTS

Although compliance with many CS-E specifications might be affected by the Engine Control System, the main paragraphs relevant to the certification of the Engine Control System itself are:

CS-E Specification	Turbine Engines	Piston Engines
CS-E 20 (Engine configuration and interfaces)	✓	✓
CS-E 25 (Instructions for Continued Airworthiness),	✓	✓
CS-E 30 (Assumptions),	✓	✓
CS-E 50 (Engine Control System)	✓	✓
CS-E 60 (Provision for instruments)	✓	✓
CS-E 80 (Equipment)	✓	✓
CS-E 110 (Drawing and marking of parts - Assembly of parts)	✓	✓
CS-E 130 (Fire prevention)	✓	✓
CS-E 140 (Tests-Engine configuration)	✓	✓
CS-E 170 (Engine systems and component verification)	✓	✓
CS-E 210 (Failure analysis)		✓
CS-E 250 (Fuel System)		✓
CS-E 390 (Acceleration tests)		✓
CS-E 500 (Functioning)	✓	
CS-E-510 (Safety analysis)	✓	
CS-E 560 (Fuel system)	✓	
CS-E 745 (Engine Acceleration)	✓	
CS-E 1030 (Time limited dispatch)	✓	✓

The following documents are referenced in this AMC 20-3:

- International Electrotechnical Commission (IEC), Central Office, 3, rue de Varembé, P.O. Box 131, CH - 1211 GENEVA 20, Switzerland
  - IEC/PAS 62239, Electronic Component Management Plans, edition 1.0, dated April 2001.
  - IEC/PAS 62240, Use of Semiconductor Devices Outside Manufacturers' Specified Temperature Ranges, edition 1.0, dated April 2001.
- RTCA, Inc. 1828 L Street, NW, Suite 805, Washington, DC 20036 or EUROCAE, 17, rue Hamelin, 75116 Paris, France
  - RTCA DO-178A/EUROCAE ED-12A, Software Considerations in Airborne Systems and Equipment Certification, dated March 1985
  - RTCA DO-178B/EUROCAE ED-12B, Software Considerations in Airborne Systems and Equipment Certification, dated December 1, 1992

- RTCA DO-254/ EUROCAE ED-80, Design Assurance Guidance for Airborne Electronic Hardware, dated April 19, 2000.
- RTCA DO-160/EUROCAE ED 14, Environmental Conditions and Test Procedures for Airborne Equipment.
- Aeronautical Systems Center, ASC/ENOI, Bldg 560, 2530 Loop Road West, Wright-Patterson AFB, OH, USA, 45433-7101
  - MIL-STD-461E, Requirements for the Control of Electromagnetic Interference Characteristics, dated August 20, 1999
  - MIL-STD-810 E or F, Test Method Standard for Environmental Engineering, E dated July 14, 1989, F dated January 1, 2000
- U.S. Department of Transportation, Subsequent Distribution, Office Ardmore East Business Center, 3341 Q 75<sup>th</sup> Ave, Landover, MD, USA, 20785
  - AC 20-136, Protection of Aircraft Electrical/Electronic Systems Against the Indirect Effects of Lightning, dated March 5, 1990
- Society of Automotive Engineers (SAE), 400 Commonwealth Drive, Warrendale, PA 15096-0001 USA or EUROCAE, 17, rue Hamelin, 75116 Paris, France
  - SAE ARP 5412 / EUROCAE ED-84, with Amendment 1 & 2, Aircraft Lightning Environment and Related Test Waveforms, February 2005/May 2001 respectively.
  - SAE ARP 5413 / EUROCAE ED-81, with Amendment 1, Certification of Aircraft Electrical/Electronic Systems for the Indirect Effects of Lightning, November 1999/August 1999 respectively.
  - SAE ARP 5414 / EUROCAE ED-91, with Amendment 1, Aircraft Lightning Zoning, February 2005/June 1999 respectively.
  - SAE ARP 5416 / EUROCAE ED-105, Aircraft Lightning Test Methods, March 2005/April 2005 respectively.

#### **(4) DEFINITIONS**

The words defined in CS-Definitions and in CS-E 15 are identified by capital letter.

The following figure and associated definitions are provided to facilitate a clear understanding of the terms used in this AMC.

**DEFINITIONS VISUALISED**

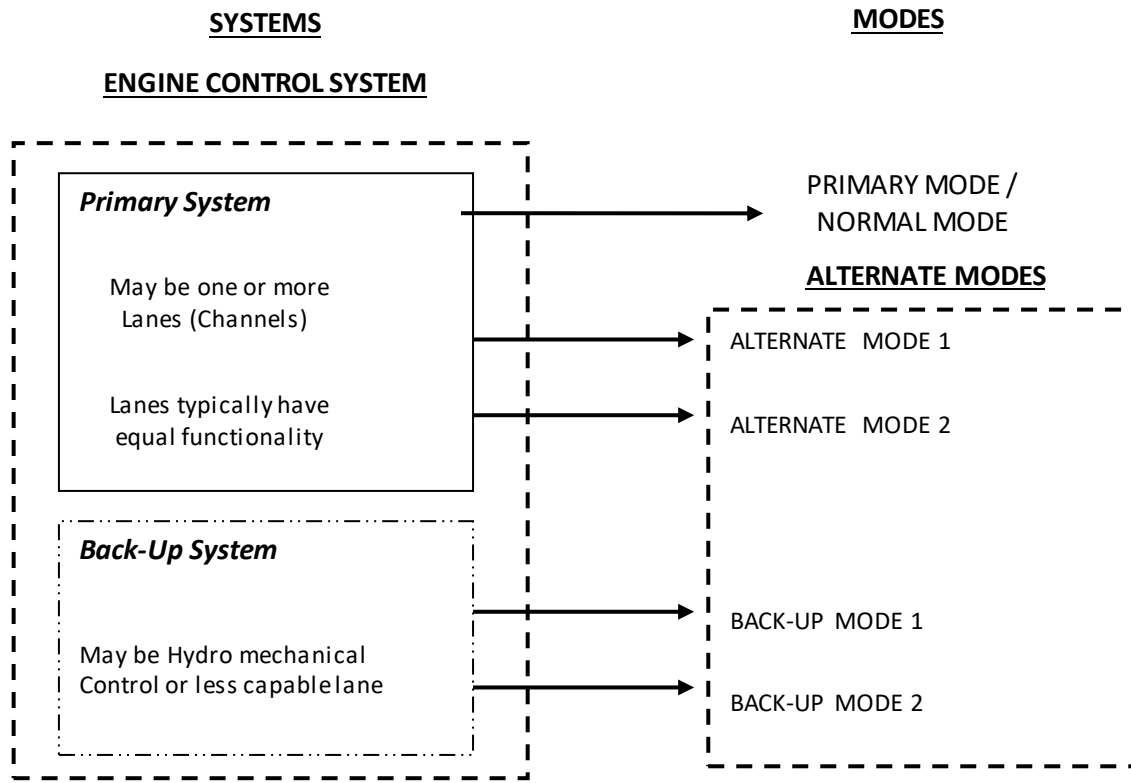

**(5) GENERAL**

It is recognised that the determination of compliance of the Engine Control System with applicable aircraft certification specifications will only be made during the aircraft certification.

In the case where the installation is unknown at the time of Engine certification, the applicant for Engine certification should make reasonable installation and operational assumptions for the target installation. Any installation limitations or operational issues will be noted in the instructions for installation or operation, and/or the Type Certificate Data Sheet (TCDS) (see CS-E 30).

When possible, early co-ordination between the Engine and the aircraft applicants is recommended in association with the relevant authorities as discussed under paragraph (15) of this AMC.

**(6) SYSTEM DESIGN AND VALIDATION**

**(a) Control Modes - General**

Under CS-E 50(a) the applicant should perform all necessary testing and analysis to ensure that all Control Modes, including those which occur as a result of control Fault Accommodation strategies, are implemented as required.

The need to provide protective functions, such as over-speed protection, for all Control Modes, including any Alternate Modes, should be reviewed under the specifications of CS-E 50 (c), (d) and (e), and CS-E 210 or CS-E 510.

Any limitations on operations in Alternate Modes should be clearly stated in the Engine instructions for installation and operation.

Descriptions of the functioning of the Engine Control System operating in its Primary and any Alternate Modes should be provided in the Engine instructions for installation and operation.

Analyses and/or testing are necessary to substantiate that operating in the Alternate Modes has no unacceptable effect on Engine durability or endurance. Demonstration of the durability and reliability of the control system in all modes is primarily addressed by the component testing of CS-E 170. Performing some portion of the Engine certification testing in the Alternate Mode(s) and during transition between modes can be used as part of the system validation required under CS-E 50(a).

(i) Engine Test Considerations

If the Engine certification tests defined in CS-E are performed using only the Engine Control System's Primary Mode in the Full-up Configuration and if approval for dispatch in the Alternate Mode is requested by the applicant under CS-E 1030, it should be demonstrated, by analysis and/or test, that the Engine can meet the defined test-success criteria when operating in any Alternate mode that is proposed as a dispatchable configuration as required by CS E-1030.

Some capabilities, such as operability, blade-off, rain, hail, bird ingestion, etc, may be lost in some control modes that are not dispatchable. These modes do not require engine test demonstration as long as the installation and operating instructions reflect this loss of capability.

(ii) Availability

Availability of any Back-up Mode should be established by routine testing or monitoring to ensure that the Back-up Mode will be available when needed. The frequency of establishing its availability should be documented in the instructions for continued airworthiness.

(b) Crew Training Modes

This acceptable means of compliance is not specifically intended to apply to any crew training modes. These modes are usually installation, and possibly operator, specific and need to be negotiated on a case-by-case basis. As an example, one common application of crew training modes is for simulation of the 'failed-fixed' mode on a twin-engine rotorcraft. Training modes should be described in the Engine instructions for installation and operation as appropriate. Also, precautions should be taken in the design of the Engine Control System and its crew interfaces to prevent inadvertent entry into any training modes. Crew training modes, including lock-out systems, should be assessed as part of the System Safety Analysis (SSA) of CS-E 50(d).

(c) Non-Dispatchable Configurations and Modes

For control configurations which are not dispatchable, but for which the applicant seeks to take credit in the system LOTC/LOPC analysis, it may be acceptable to have specific operating limitations. In addition, compliance with CS-E 50(a) does not imply strict compliance with the operability specifications of CS-E 390, CS-E 500 and CS-E 745 in these non-dispatchable configurations, if it can be demonstrated that, in the intended installation, no likely pilot control system inputs will result in Engine surge, stall, flame-out or unmanageable delay in power recovery. For example, in a twin-engine rotorcraft, a rudimentary Back-up System may be adequate since frequent and rapid changes in power setting with the Back-up System may not be necessary.

In addition to these operability considerations, other factors which should be considered in assessing the acceptability of such reduced-capability Back-up Modes include:

- The installed operating characteristics of the Back-up Mode and the differences from the Primary Mode.
- The likely impact of the Back-up Mode operations on pilot workload, if the aircraft installation is known.
- The frequency of transfer from the Primary Mode to the Back-up Mode (i.e. the reliability of the Primary Mode). Frequencies of transfer of less than 1 per 20 000 engine flight hours have been considered acceptable.

(d) Control Transitions

The intent of CS-E 50(b) is to ensure that any control transitions, which occur as a result of Fault Accommodation, occur in an acceptable manner.

In general, transition to Alternate Modes should be accomplished automatically by the Engine Control System. However, systems wherein pilot action is required to engage the Back-up Mode may also be acceptable. For instance, a Fault in the Primary System may result in a “failed-fixed” fuel flow and some action is required by the pilot to engage the Back-up System in order to modulate Engine power. Care should be taken to ensure that any reliance on manual transition is not expected to pose an unacceptable operating characteristic, unacceptable crew workload or require exceptional skill.

The transient change in power or thrust associated with transfer to Alternate Modes should be reviewed for compliance with CS-E 50(b). If available, input from the installer should be considered. Although this is not to be considered a complete list, some of the items that should be considered when reviewing the acceptability of Control Mode transitions are:

- The frequency of occurrence of transfers to any Alternate Mode and the capability of the Alternate Mode. Computed frequency-of-transfer rates should be supported with data from endurance or reliability testing, in-service experience on similar equipment, or other appropriate data.
- The magnitude of the power, thrust, rotor or Propeller speed transients.
- Successful demonstration, by simulation or other means, of the ability of the Engine Control System to control the Engine safely during the transition. In some cases, particularly those involving rotorcraft, it may not be possible to make a determination that the mode transition provides a safe system based solely on analytical or simulation data. Therefore, a flight test programme to support this data will normally be expected.
- An analysis should be provided to identify those Faults that cause Control Mode transitions either automatically or through pilot action.
- For turboprop or turboshaft engines, the transition should not result in excessive over-speed or under-speed of the rotor or Propeller which could cause emergency shutdown, loss of electrical generator power or the setting-off of warning devices.

The power or thrust change associated with the transition should be declared in the instructions for installing the Engine.

(i) Time Delays

Any observable time delays associated with Control Mode, channel or system transitions or in re-establishing the pilot's ability to modulate Engine thrust or power should be identified in the Engine instructions for installation and operation (see CS-E 50(b)). These delays should be assessed during aircraft certification.

(ii) Annunciation to the Flight Crew

If annunciation is necessary to comply with CS-E 50(b)(3), the type of annunciation to the flight crew should be commensurate with the nature of the transition. For instance, reversion to an Alternate Mode of control where the transition is automatic and the only observable changes in operation of the Engine are different thrust control schedules, would require a very different form of annunciation to that required if timely action by the pilot is required in order to maintain control of the aircraft.

The intent and purpose of the cockpit annunciation should be clearly stated in the Engine instructions for installation and operation, as appropriate.

(e) Environmental conditions

Environmental conditions include EMI, HIRF and lightning. The environmental conditions are addressed under CS E-80 and CS-E 170. The following provides additional guidance for EMI, HIRF and lightning.

(i) Declared levels

When the installation is known during the Engine type certification programme, the Engine Control System should be tested at levels that have been determined and agreed by the Engine and aircraft applicants. It is assumed that, by this agreement, the installation can meet the aircraft certification specifications. Successful completion of the testing to the agreed levels would be accepted for Engine type certification. This, however, may make the possibility of installing the Engine dependent on a specific aircraft.

If the aircraft installation is not known or defined at the time of the Engine certification, in order to determine the levels to be declared for the Engine certification, the Engine applicant may use the external threat level defined at the aircraft level and use assumptions on installation attenuation effects.

If none of the options defined above are available, it is recommended that the procedures and minimum default levels for HIRF testing are agreed with the Agency.

(ii) Test procedures

(A) General

The installed Engine Control System, including representative Engine-aircraft interface cables, should be the basis for certification testing.

Electro-Magnetic Interference (EMI) test procedures and test levels conducted in accordance with MIL-STD-461 or EUROCAE ED 14/DO-160 have been considered acceptable.

The applicant should use the HIRF test guidelines provided in EUROCAE ED 14/RTCA DO-160 or equivalent. However, it should be recognised that the tests defined in EUROCAE ED 14/RTCA DO-160 are applicable at a component test level, requiring the applicant to adapt these test procedures to a system level HIRF test to demonstrate compliance with CS-E 80 and CS-E 170.

For lightning tests, the guidelines of SAE ARP 5412, 5413, 5414, and 5416 and EUROCAE ED 14/RTCA DO-160 would be applicable.

Pin Injection Tests (PIT) are normally conducted as component tests on the EECS unit and other system components as required. PIT levels are selected as appropriate from the tables of EUROCAE ED 14/DO-160.

Environmental tests such as MIL-STD-810 may be accepted in lieu of EUROCAE ED-14/DO-160 tests where these tests are equal to or more rigorous than those defined in EUROCAE ED 14/DO-160.

(B) Open loop and Closed loop Testing

HIRF and lightning tests should be conducted as system tests on closed loop or open loop laboratory set-ups.

The closed loop set-up is usually provided with hydraulic pressure to move actuators to close the inner actuating loops. A simplified Engine simulation may be used to close the outer Engine loop.

Testing should be conducted with the Engine Control System controlling at the most sensitive operating point, as selected and detailed in the test plans by the applicant. The system should be exposed to the HIRF and lightning environmental threats while operating at the selected condition. There may be a different operating point for HIRF and lightning environmental threats.

For tests in open and closed loop set ups, the following factors should also be considered:

- If special EECS test software is used, that software should be developed and implemented by guidelines defined for software levels of at least Level 2 in DO-178A, Level C in DO-178B, or equivalent. In some cases, the application code is modified to include the required test code features.
- The system test set-up should be capable of monitoring both the output drive signals and the input signals.
- Anomalies observed during open loop testing on inputs or outputs should be duplicated on the Engine simulation to determine whether the resulting power or thrust perturbations comply with the pass/fail criteria.

(iii) Pass/Fail Criteria

The pass/fail criteria of CS-E 170 for HIRF and lightning should be interpreted as "no adverse effect" on the functionality of the system.

The following are considered adverse effects:

- A greater than 3 % change of Take-off Power or Thrust for a period of more than two seconds.
- Transfers to alternate channels, Back-up Systems, or Alternate Modes.
- Component damage.
- False annunciation to the crew which could cause unnecessary or inappropriate crew action.
- Erroneous operation of protection systems, such as over-speed or thrust reverser circuits.

Hardware or Software design changes implemented after initial environmental testing should be evaluated for their effects with respect to the EMI, HIRF and lightning environment.

(iv) Maintenance Actions

CS-E 25 requires that the applicant prepare Instructions for Continued Airworthiness (ICA). This includes a maintenance plan. Therefore, for any protection system that is part of the type design of the Engine Control System and is required by the system to meet the qualified levels of EMI, HIRF and lightning, a maintenance plan should be provided to ensure the continued airworthiness for the parts of the installed system which are supplied by the Engine type certificate holder.

.The maintenance actions to be considered include periodic inspections or tests for required structural shielding, wire shields, connectors, and equipment protection components. Inspections or tests when the part is exposed may also be considered. The applicant should provide the engineering validation and substantiation of these maintenance actions.

(v) Time Limited Dispatch (TLD) Environmental Tests

Although TLD is only an optional requirement for certification (see CS-E 1000 and CS-E 1030), EMI, HIRF and lightning tests for TLD are usually conducted together with tests conducted for certification. Acceptable means of compliance are provided in AMC E 1030.

## **(7) INTEGRITY OF THE ENGINE CONTROL SYSTEM**

(a) Objective

The intent of CS-E 50(c) is to establish Engine Control System integrity requirements consistent with operational requirements of the various installations. (See also paragraph (4) of AMC E 50).

(b) Definition of an LOTC/LOPC event

(i) For turbine Engines intended for CS-25 installations

An LOTC/LOPC event is defined as an event where the Engine Control System:

- has lost the capability of modulating thrust or power between idle and 90% of maximum rated power or thrust, or
- suffers a Fault which results in a thrust or power oscillation greater than the levels given in paragraph (7)(c) of this AMC, or



- has lost the capability to govern the Engine in a manner which allows compliance with the operability specifications given in CS-E 500(a) and CS-E 745.

(ii) For turbine Engines intended for rotorcraft

An LOPC event is defined as an event where the Engine Control System:

- has lost the capability of modulating power between idle and 90% of maximum rated power at the flight condition, except OEI power ratings, or
- suffers a Fault which results in a power oscillation greater than the levels given in paragraph (7)(c) of this AMC, or
- has lost the capability to govern the Engine in a manner which allows compliance with the operability specifications given in CS-E 500(a) and CS-E 745, with the exception that the inability to meet the operability specifications in the Alternate Modes may not be included as LOPC events.
- Single Engine rotorcraft will be required to meet the operability specifications in the Alternate Mode(s), unless the lack of this capability is demonstrated to be acceptable at the aircraft level. Engine operability in the Alternate Mode(s) is considered a necessity if:
  - the control transitions to the Alternate Mode more frequently than the acceptable LOPC rate, or
  - normal flight crew activity requires rapid changes in power to safely fly the aircraft.
- For multi-Engine rotorcraft, the LOPC definition may not need to include the inability to meet the operability specifications in the Alternate Mode(s). This may be considered acceptable because when one Engine control transitions to an Alternate Mode, which may not have robust operability, that Engine can be left at reasonably fixed power conditions. The Engine(s) with the normally operating control(s) can change power – as necessary – to complete aircraft manoeuvres and safely land the aircraft. Demonstration of the acceptability of this type of operation may be required at aircraft certification.

(iii) For turbine Engines intended for other installations

A LOTC/LOPC event is defined as an event where the Engine Control System:

- has lost the capability of modulating thrust or power between idle and 90% of maximum rated power or thrust, or
- suffers a Fault which results in a thrust or power oscillation that would impact controllability in the intended installation, or
- has lost the capability to govern the Engine in a manner which allows compliance with the operability specifications given in CS-E 500(a) and CS-E 745, as appropriate.

## (iv) For piston Engines

An LOPC event is defined as an event where the Engine Control System:

- has lost the capability of modulating power between idle and 85% of maximum rated power at all operating conditions, or
- suffers a Fault which results in a power oscillation greater than the levels given in paragraph (7)(c) of this AMC, or
- has lost the capability to govern the Engine in a manner which allows compliance with the operability specifications given in CS-E 390.

## (v) For engines incorporating functions for Propeller control integrated in the EECS

The following Faults or Failures should be considered as additional LOPC events:

- inability to command a change in pitch,
- uncommanded change in pitch,
- uncontrollable Propeller torque or speed fluctuation.

## (c) Uncommanded thrust or power oscillations

Any uncommanded thrust or power oscillations should be of such a magnitude as not to impact aircraft controllability in the intended installation. Thrust or power oscillations less than 10% peak to peak of Take-off Power and/or Thrust have been considered acceptable in some installations, where the failure affects one engine only. Regardless of the levels discussed herein, if the flight crew has to shut down an Engine because of unacceptable thrust or power oscillations caused by the control system, such an event would be deemed an in-service LOTC/LOPC event.

## (d) Acceptable LOTC/LOPC rate

The applicant may propose an LOTC/LOPC rate other than those below. Such a proposal should be substantiated in relation to the criticality of the Engine and control system relative to the intended installation. The intent is to show equivalence of the LOTC/LOPC rate to existing systems in comparable installations.

## (i) For turbine Engines

The EECS should not cause more than one LOTC/LOPC event per 100 000 engine flight hours.

## (ii) For piston Engines

An LOPC rate of 45 per million engine flight hours (or 1 per 22,222 engine flight hours) has been shown to represent an acceptable level for the most complex EECS. As a result of the architectures used in many of the EECS for these engines, the functions are implemented in independent system elements. These system elements or sub-systems can be fuel control, or ignition control, or others. If a system were to contain only one element such as fuel control, then the appropriate total system level would be 15 LOPC events per million engine flight hours. So the system elements are then additive up to a max of 45 LOPC events per million hours. For example, an EEC system comprised of fuel, ignition, and wastegate control functions should meet a total system reliability of  $15+15+15 = 45$  LOPC events per million engine flight hours. This criterion is then applied to the entire system and not allocated to each of the subsystems. Note that a maximum of 45 LOPC events

per million engine flight hours are allowed, regardless of the number of subsystems. For example, if the EEC system includes more than three subsystems, the sum of the LOPC rates for the total system should not exceed 45 LOPC events per million engine flight hours for all of the electrical and electronic elements.

(e) LOTC/LOPC Analysis

A system reliability analysis should be submitted to substantiate the agreed LOTC/LOPC rate for the Engine Control System. A numerical analysis such as a Markov model analysis, fault tree analysis or equivalent analytical approach is expected.

The analysis should address all components in the system that can contribute to LOTC/LOPC events. This includes all electrical, mechanical, hydromechanical, and pneumatic elements of the Engine Control System. This LOTC/LOPC analysis should be done in conjunction with the System Safety Assessment required under CS-E 50(d). Paragraph (8) of this AMC provides additional guidance material.

The engine fuel pump is generally not included in the definition of the Engine Control System. It is usually considered part of the fuel delivery system.

The LOTC/LOPC analysis should include those sensors or elements which may not be part of the Engine type design, but which may contribute to LOTC/LOPC events. An example of this is the throttle or power lever transducer, which is usually supplied by the installer. The effects of loss, corruption or Failure of Aircraft-Supplied Data should be included in the Engine Control System's LOTC/LOPC analysis. The reliability and interface requirements for these non-Engine type design elements should be contained in the Engine instructions for installation. It needs to be ensured that there is no double counting of the rate of Failure of non-engine parts within the aircraft system safety analyses.

The LOTC/LOPC analysis should consider all Faults, both detected and undetected. Any periodic maintenance actions needed to find and repair both Covered and Uncovered Faults, in order to meet the LOTC/LOPC rate, should be contained in the Engine instructions for continued airworthiness.

(f) Commercial or Industrial Grade Electronic Parts

When the Engine type design specifies commercial or industrial grade electronic components, which are parts not manufactured to military standards, the applicant should have the following data available for review, as applicable:

- Reliability data that substantiates the Failure rate for each component used in the LOTC/LOPC analysis and the SSA for each commercial and industrial grade electrical component specified in the design.
- The applicant's procurement, quality assurance, and process control plans for the vendor-supplied commercial and industrial grade parts. These plans should ensure that the parts will be able to maintain the reliability level specified in the approved Engine type design.
- Unique databases for similar components obtained from different vendors, because commercial and industrial grade parts may not all be manufactured to the same accepted industry standard, such as military component standards.
- Commercial and industrial grade parts have typical operating ranges of 0 degrees to +70 degrees Celsius and -40 degrees to +85 degrees Celsius, respectively. Military grade parts are typically rated at -54 degrees to 125 degrees Celsius.

Commercial and industrial grade parts are typically defined in these temperature ranges in vendor parts catalogues. If the declared temperature environment for the Engine Control System exceeds the stated capability of the commercial or industrial grade electronic components, the applicant should substantiate that the proposed extended range of the specified components is suitable for the installation and that the Failure rates used for those components in the SSA and LOTC/LOPC analyses is appropriately adjusted for the extended temperature environment. Additionally, if commercial or industrial parts are used in an environment beyond their specified rating and cooling provisions are required in the design of the EECS, the applicant should specify these provisions in the instructions for installation to ensure that the provisions for cooling are not compromised. Failure modes of the cooling provisions included in the EECS design that cause these limits to be exceeded should be considered in determining the probability of Failure.

- Two examples of industry published documents which provide guidance on the application of commercial or industrial grade components are:
  - IEC/PAS 62239, Electronic Component Management Plans
  - IEC/PAS 62240, Use of Semiconductor Devices Outside Manufacturers' Specified Temperature Ranges

When any electrical or electronic components are changed, the SSA and LOTC/LOPC analyses should be reviewed with regard to the impact of any changes in component reliability. Component, subassembly or assembly level testing may be required by the Agency to substantiate a change that introduces a commercial or industrial part(s). However, such a change would not be classified as 'significant' with respect to Part 21.A.101(b)1.

(g) Single Fault Accommodation

Compliance with the single Fault specifications of CS-E 50(c)(2) and (3) may be substantiated by a combination of tests and analyses. The intent is that single Failures or malfunctions in the Engine Control System's components, in its fully operational condition, do not result in a Hazardous Engine Effect. In addition, in its full-up configuration the control system should be essentially single Fault tolerant of electrical/electronic component Failures with respect to LOTC/LOPC events. For dispatchable configurations refer to CS-E 1030 and AMC E 1030.

It is recognised that to achieve true single Fault tolerance for LOTC/LOPC events could require a triplicated design approach or a design approach with 100% Fault detection. Currently, systems have been designed with dual, redundant channels or with Back-up Systems that provide what has been called an "essentially single Fault tolerant" system. Although these systems may have some Faults that are not Covered Faults, they have demonstrated excellent in-service safety and reliability, and have proven to be acceptable.

The objective, of course, is to have all the Faults addressed as Covered Faults. Indeed, the dual channel or Back-up system configurations do cover the vast majority of potential electrical and electronic Faults. However, on a case-by-case basis, it may be appropriate for the applicant to omit some coverage because detection or accommodation of some electrical/electronic Faults may not be practical. In these cases, it is recognised that single, simple electrical or electronic components or circuits can be employed in a reliable

manner, and that requiring redundancy in some situations may not be appropriate. In these circumstances, Failures in some single electrical or electronic components, elements or circuits may result in an LOTC/LOPC event. This is what is meant by the use of the term “essentially”, and such a system may be acceptable.

(h) Local Events

Examples of local events to be considered under CS-E 50(c)(4) include:

- Overheat conditions, for example, those resulting from hot air duct bursts,
- Fires, and
- Fluid leaks or mechanical disruptions which could lead to damage to control system electrical harnesses, connectors, or the control unit(s).

These local events would normally be limited to one Engine. Therefore, a local event is not usually considered to be a common mode event, and common mode threats, such as HIRF, lightning and rain, are not considered local events.

When demonstration that there is no Hazardous Engine Effect is based on the assumption that another function exists to afford the necessary protection, it should be shown that this function is not rendered inoperative by the same local event on the Engine (including destruction of wires, ducts, power supplies).

It is considered that an overheat condition exists when the temperature of the system components is greater than the maximum safe design operating temperature for the components, as declared by the Engine applicant in the Engine instructions for installation. The Engine Control System should not cause a Hazardous Engine Effect when the components or units of the system are exposed to an overheat or over-temperature condition. Specific design features or analysis methods may be used to show compliance with respect to the prevention of Hazardous Engine Effects. Where this is not possible, for example, due to the variability or the complexity of the Failure sequence, then testing may be required.

The Engine Control System, including the electrical, electronic and mechanical parts of the system, should comply with the fire specifications of CS-E 130 and the interpretative material of AMCE 130 is relevant. This rule applies to the elements of the Engine Control System which are installed in designated fire zones.

There is no probability associated with CS-E 50(c)(4). Hence, all foreseeable local events should be considered. It is recognised, however, that it is difficult to address all possible local events in the intended aircraft installation at the time of Engine certification. Therefore, sound Engineering judgement should be applied in order to identify the reasonably foreseeable local events. Compliance with this specification may be shown by considering the end result of the local event on the Engine Control System. The local events analysed should be well documented to aid in certification of the Engine installation.

The following guidance applies to Engine Control System wiring:

- Each wire or combination of wires interfacing with the EECS that could be affected by a local event should be tested or analysed with respect to local events. The assessment should include opens, shorts to ground and shorts to power (when appropriate) and the results should show that Faults result in identified responses and do not result in Hazardous Engine Effects.

- Engine control unit aircraft interface wiring should be tested or analysed for shorts to aircraft power, and these “hot” shorts should result in an identified and non-Hazardous Engine Effect. Where aircraft interface wiring is involved, the installer should be informed of the potential effects of interface wiring Faults by means of information provided in the Engine instructions for installation. It is the installer’s responsibility to ensure that there are no wiring Faults which could affect more than one Engine. Where practical, wiring Faults should not affect more than one channel. Any assumptions made by the Engine applicant regarding channel separation should be included in the LOTC/LOPC analysis.
- Where physical separation of conductors is not practical, co-ordination between the Engine applicant and the installer should ensure that the potential for common mode Faults between Engine Control Systems is eliminated, and between channels on one Engine is minimised.

The applicant should assess by analysis or test the effects of fluid leaks impinging on components of the Electronic Engine Control System. Such conditions should not result in a Hazardous Engine Effect, nor should the fluids be allowed to impinge on circuitry or printed circuit boards and result in a potential latent Failure condition.

## **(8) SYSTEM SAFETY ASSESSMENT**

### **(a) Scope of the assessment**

The system safety assessment (SSA) required under CS-E 50(d) should address all operating modes, and the data used in the SSA should be substantiated.

The LOTC/LOPC analysis described in Section 7 is a subset of the SSA. The LOTC/LOPC analysis and SSA may be separate or combined as a single analysis.

The SSA should consider all Faults, both detected and undetected, and their effects on the Engine Control System and the Engine itself. The intent is primarily to address the Faults or malfunctions which only affect one Engine Control System, and therefore only one Engine. However, Faults or malfunctions in aircraft signals, including those in a multi-engine installation that could affect more than one Engine, should also be included in the SSA; these types of Faults are addressed under CS-E 50(g).

The Engine Control System SSA and LOTC/LOPC analysis, or combined analyses, should identify the applicable assumptions and installation requirements and establish any limitations relating to Engine Control System operation. These assumptions, requirements, and limitations should be stated in the Engine instructions for installation and operation as appropriate. If necessary, the limitations should be contained in the airworthiness limitations section of the instructions for continued airworthiness in accordance with CS-E 25(b)(1).

The SSA should address all Failure effects identified under CS-E 510 or CS-E 210, as appropriate. A summary should be provided, listing the malfunctions or Failures and their effects caused by the Engine Control System, such as:

- Failures affecting power or thrust resulting in LOTC/LOPC events.
- Failures which result in the Engine’s inability to meet the operability specifications. If these Failure cases are not considered as LOPC events according to paragraph (7)(b)(ii) of this AMC, the expected frequency of occurrence for these events should be documented.

- Transmission of erroneous parameters which could lead to thrust or power changes greater than 3% of Take-off Power or Thrust (10% for piston engines installations) (e.g., false high indication of the thrust or power setting parameter) or to Engine shutdown (e.g., high EGT or turbine temperatures or low oil pressure).
- Failures affecting functions included in the Engine Control System, which may be considered aircraft functions (e.g. Propeller control, thrust reverser control, control of cooling air, control of fuel recirculation)
- Failures resulting in Major Engine Effects and Hazardous Engine Effects.

The SSA should also consider all signals used by the Engine Control System, in particular any cross-Engine control signals and air signals as described in CS-E 50(i).

The criticality of functions included in the Engine Control System for aircraft level functions needs to be defined by the aircraft applicant.

(b) Criteria

The SSA should demonstrate or provide the following:

- (i) Compliance with CS-E 510 or CS-E 210, as appropriate.
- (ii) For Failures leading to LOTC/LOPC events, compliance with the agreed LOTC/LOPC rate for the intended installation (see paragraph (7)(d) of this AMC).
- (iii) For Failures affecting Engine operability but not leading to LOPC events, compliance with the expected total frequency of occurrence of Failures that result in Engine response that is non-compliant with CS-E 390, CS-E 500(a) and CS-E 745 specifications (as appropriate). The acceptability of the frequency of occurrence for these events - along with any aircraft flight deck indications deemed necessary to inform the flight crew of such a condition - will be determined at aircraft certification.
- (iv) The consequence of the transmission of a faulty parameter

The consequence of the transmission of a faulty parameter by the Engine Control System should be identified and included, as appropriate, in the LOTC/LOPC analysis. Any information necessary to mitigate the consequence of a faulty parameter transmission should be contained in the Engine operating instructions.

For example, the Engine operating instructions may indicate that a display of zero oil pressure be ignored in-flight if the oil quantity and temperature displays appear normal. In this situation, Failure to transmit oil pressure or transmitting a zero oil pressure signal should not lead to an Engine shutdown or LOTC/LOPC event. Admittedly, flight crew initiated shutdowns have occurred in-service during such conditions. In this regard, if the Engine operating instructions provide information to mitigate the condition, then control system Faults or malfunctions leading to the condition do not have to be included in the LOTC/LOPC analysis. In such a situation, the loss of multiple functions should be included in the LOTC/LOPC analysis. If the display of zero oil pressure and zero oil quantity (or high oil temperature) would result in a crew initiated shutdown, then those conditions should be included in the systems LOTC/LOPC analysis.

(c) Malfunctions or Faults affecting thrust or power

In multi-engine aeroplanes, Faults that result in thrust or power changes of less than approximately 10% of Take-off Power or Thrust may be undetectable by the flight crew.

This level is based on pilot assessment and has been in use for a number of years. The pilots indicated that flight crews will note the Engine operating differences when the difference is greater than 10% in asymmetric thrust or power.

The detectable difference level for Engines for other installations should be agreed with the installer.

When operating in the take-off envelope, Uncovered Faults in the Engine Control System which result in a thrust or power change of less than 3% (10% for piston engines installations), are generally considered acceptable. However, this does not detract from the applicant's obligation to ensure that the full-up system is capable of providing the declared minimum rated thrust or power. In this regard, Faults which could result in small thrust changes should be random in nature and detectable and correctable during routine inspections, overhauls or power-checks.

The frequency of occurrence of Uncovered Faults that result in a thrust or power change greater than 3% of Take-off Power or Thrust, but less than the change defined as an LOTC/LOPC event, should be contained in the SSA documentation. There are no firm specifications relating to this class of Faults for Engine certification; however the rate of occurrence of these types of Faults should be reasonably low, in the order of  $10^{-4}$  events per Engine flight hour or less. These Faults may be required to be included in aircraft certification analysis.

Signals sent from one Engine Control System to another in an aeroplane installation, such as signals used for an Automatic Take-off Thrust Control System (ATTCS), synchrophasing, etc., are addressed under CS-E 50(g). They should be limited in authority by the receiving Engine Control System, so that undetected Faults do not result in an unacceptable change in thrust or power on the Engine using those signals. The maximum thrust or power loss on the Engine using a cross-Engine signal should generally be limited to 3% absolute difference of the current operating condition.

Note: It is recognised that ATTCS, when activated, may command a thrust or power increase of 10% or more on the remaining Engine(s). It is also recognised that signals sent from one Engine control to another in a rotorcraft installation, such as load sharing and One Engine Inoperative (OEI), can have a much greater impact on Engine power when those signals fail. Data of these Failure modes should be contained in the SSA.

When operating in the take-off envelope, detected Faults in the Engine Control System, which result in a thrust or power change of up to 10% (15% for piston engines) may be acceptable if the total frequency of occurrence for these types of Failures is relatively low. The predicted frequency of occurrence for this category of Faults should be contained in SSA documentation. It should be noted that requirements for the allowable frequency of occurrence for this category of Faults and any need for a flight deck indication of these conditions would be reviewed during aircraft certification. A total frequency of occurrence in excess of  $10^{-4}$  events per Engine flight hour would not normally be acceptable.

Detected Faults in signals exchanged between Engine Control Systems should be accommodated so as not to result in greater than a 3% thrust or power change on the Engine using the cross-Engine signals.



**(9) PROTECTIVE FUNCTIONS****(a) Rotor Over-speed Protection.**

Rotor over-speed protection is usually achieved by providing an independent over-speed protection system, such that it requires two independent Faults or malfunctions (as described below) to result in an uncontrolled over-speed.

The following guidance applies if the rotor over-speed protection is provided solely by an Engine Control System protective function.

For dispatchable configurations, refer to CS-E 1030 and AMC E 1030.

The SSA should show that the probability per Engine flight hour of an uncontrolled over-speed condition from any cause in combination with a Failure of the over-speed protection system to function is less than one event per hundred million hours (a Failure rate of  $10^{-8}$  events per Engine flight hour).

The over-speed protection system would be expected to have a Failure rate of less than  $10^{-4}$  Failures per engine flight hour to ensure the integrity of the protected function.

A self-test of the over-speed protection system to ensure its functionality prior to each flight is normally necessary for achieving the objectives. Verifying the functionality of the over-speed protection system at Engine shutdown and/or start-up is considered adequate for compliance with this requirement. It is recognised that some Engines may routinely not be shut down between flight cycles. In this case this should be accounted for in the analyses.

Because in some over-speed protection systems there are multiple protection paths, there will always be uncertainty that all paths are functional at any given time. Where multiple paths can invoke the over-speed protection system, a test of a different path may be performed each Engine cycle. The objective is that a complete test of the over-speed system, including electro-mechanical parts, is achieved in the minimum number of Engine cycles. This is acceptable so long as the system meets a  $10^{-4}$  Failure rate.

The applicant may provide data that demonstrates that the mechanical parts (this does not include the electro-mechanical parts) of the over-speed protection system can operate without Failure between stated periods, and a periodic inspection may be established for those parts. This data is acceptable in lieu of testing the mechanical parts of the sub-system each Engine cycle.

**(b) Other protective functions**

The Engine Control System may perform other protective functions. Some of these may be Engine functions, but others may be aircraft or Propeller functions. Engine functions should be considered under the guidelines of this AMC. The integrity of other protective functions provided by the Engine Control System should be consistent with a safety analysis associated with those functions, but if those functions are not Engine functions, they may not be a part of Engine certification.

As Engine Control Systems become increasingly integrated into the aircraft and Propeller systems, they are incorporating protective functions that were previously provided by the aircraft or Propeller systems. Examples are reducing the Engine to idle thrust if a thrust reverser deploys and providing the auto-feather function for the Propeller when an Engine fails.

The reliability and availability associated with these functions should be consistent with the top level hazard assessment of conditions involving these functions. This will be completed during aircraft certification.

For example, if an Engine Failure with loss of the auto-feather function is catastrophic at the aircraft level - and the auto-feather function is incorporated into the Engine Control System - the applicant will have to show for CS-25 installations (or CS-23 installations certified to CS-25 specifications) that an Engine Failure with loss of the auto-feather function cannot result from a single control system Failure, and that combinations of control system Failures, or Engine and control system Failures, which lead to a significant Engine loss of thrust or power with an associated loss of the autofeather function may be required to have an extremely improbable event rate (i.e.,  $10^{-9}$  events per Engine flight hour).

Although these functions await evaluation at the aircraft level, it is strongly recommended that, if practicable, the aircraft level hazard assessment involving these functions be available at the time of the Engine Control System certification. This will facilitate discussions and co-ordination between the Engine and aircraft certification teams under the conditions outlined in paragraph (15) of this AMC. It is recognised that this co-ordination may not occur for various reasons. Because of this, the applicant should recognise that although the Engine may be certified, it may not be installable at the aircraft level.

The overall requirement is that the safety assessment of the Engine Control System should include all Failure modes of all functions incorporated in the system. This includes those functions which are added to support aircraft certification, so that the information of those Failure modes will get properly addressed and passed on to the installer for inclusion in the airframe SSA. Information concerning the frequencies of occurrence of those Failure modes may be needed as well.

## **(10) SOFTWARE DESIGN AND IMPLEMENTATION**

### **(a) Objective**

For Engine Control Systems that use software, the objective of CS-E 50(f) is to prevent as far as possible software errors that would result in an unacceptable effect on power or thrust, or any unsafe condition.

It is understood that it may be impossible to establish with certainty that the software has been designed without errors. However, if the applicant uses the software level appropriate for the criticality of the performed functions and uses an approved software development method, the Agency would consider the software to be compliant with the requirement to minimise errors. In multiple Engine installations, the possibility of software errors common to more than one Engine Control System may determine the criticality level of the software.

### **(b) Approved Methods**

Methods for developing software, compliant with the guidelines of documents RTCA DO-178A/EUROCAE ED-12A and RTCA DO-178B/EUROCAE ED-12B, hereafter referred to as DO-178A and DO-178B, respectively, are acceptable methods. Alternative methods for developing software may be proposed by the applicant and are subject to approval by the Agency.

Software which is not developed using DO-178B is referred to as legacy software. In general, changes made to legacy software applicable to its original installation are assured in the same manner as the original certification. When legacy software is used in a new aircraft installation that requires DO-178B, the original approval of the legacy software is still valid, assuming equivalence to the required software level can be ascertained. If the software equivalence is acceptable to the Agency, the legacy software can be used in the new installation that requires DO-178B software. If equivalence cannot be substantiated, all the software changes should be assured using DO-178B.

(c) Level of software design assurance

In multiple Engine installations, the design, implementation and verification of the software in accordance with Level 1 (DO-178A) or Level A (DO-178B) is normally needed to achieve the certification objectives for aircraft to be type certificated under CS-25, CS-27-Category A and CS-29-Category A.

The criticality of functions on other aircraft may be different, and therefore, a different level of software design assurance may be acceptable. For example, in the case of a piston engine in a single-engine aircraft, level C (DO-178B) software has been found to be acceptable.

Determination of the appropriate software level may depend on the Failure modes and consequences of those Failures. For example, it is possible that Failures resulting in significant thrust or power increases or oscillations may be more severe than an Engine shutdown, and therefore, the possibility of these types of Failures should be considered when selecting a given software level.

It may be possible to partition non-critical software from the critical software and design and implement the non-critical software to a lower level as defined by the RTCA documents. The adequacy of the partitioning method should be demonstrated. This demonstration should consider whether the partitioned lower software levels are appropriate for any anticipated installations. Should the criticality level be higher in subsequent installations, it would be difficult to raise the software level.

(d) On-Board or Field Software Loading and Part Number Marking

The following guidelines should be followed when on-board or field loading of Electronic Engine Control software and associated Electronic Part Marking (EPM) is implemented.

For software changes, the software to be loaded should have been documented by an approved design change and released with a service bulletin.

For an EECS unit having separate part numbers for hardware and software, the software part number(s) need not be displayed on the unit as long as the software part number(s) is(are) embedded in the loaded software and can be verified by electronic means. When new software is loaded into the unit, the same verification requirement applies and the proper software part number should be verified before the unit is returned to service.

For an EECS unit having only one part number, which represents a combination of a software and hardware build, the unit part number on the nameplate should be changed or updated when the new software is loaded. The software build or version number should be verified before the unit is returned to service.

The configuration control system for an EECS that will be onboard/field loaded and using electronic part marking should be approved. The drawing system should provide a compatibility table that tabulates the combinations of hardware part numbers and

software versions that have been approved by the Agency. The top-level compatibility table should be under configuration control, and it should be updated for each change that affects hardware/software combinations. The applicable service bulletin should define the hardware configurations with which the new software version is compatible.

The loading system should be in compliance with the guidelines of DO-178B.

If the applicant proposes more than one source for loading, (e.g., diskette, mass storage, etc.), all sources should comply with these guidelines.

The service bulletin should require verification that the correct software version has been loaded after installation on the aircraft.

(e) **Software Change Category**

The processes and methods used to change software should not affect the design assurance level of that software. For classification of software changes, refer to §4 in Appendix A of GM 21.A.91.

(f) **Software Changes by Others than the TC Holder**

There are two types of potential software changes that could be implemented by someone other than the original TC holder:

- option-selectable software, or
- user-modifiable software (UMS).

Option-selectable changes would have to be pre-certified utilising a method of selection which has been shown not to be capable of causing a control malfunction.

UMS is software intended for modification by the aircraft operator without review by the certification authority, the aircraft applicant, or the equipment vendor. For Engine Control Systems, UMS has generally not been applicable. However, approval of UMS, if required, would be addressed on a case-by-case basis.

The necessary guidance for UMS is contained in DO-178B, paragraph 2.4. In essence, it conveys the position that others than the TC holder may modify the software within the modification constraints defined by the TC holder, if the system has been certified with the provision for software user modifications. To certify an Electronic Engine Control System with the provision for software modification by others than the TC holder, the TC holder should (1) provide the necessary information for approval of the design and implementation of a software change, and (2) demonstrate that the necessary precautions have been taken to prevent the user modification from affecting Engine airworthiness, whether the user modification is correctly implemented or not.

In the case where the software is changed in a manner not pre-allowed by the TC holder as “user modifiable”, the “non-TC holder” applicant will have to comply with the requirements given in Part 21, subpart E.

**(11) PROGRAMMABLE LOGIC DEVICES**

CS-E 50 (f) applies to devices referred to as Programmable Logic Devices.

Because of the nature and complexity of systems containing digital logic, the Programmable Logic Devices should be developed using a structured development approach, commensurate with the hazard associated with Failure or malfunction of the system in which the device is contained.

RTCA DO-254/ EUROCAE ED-80 which describes the standards for the criticality and design assurance levels associated with Programmable Logic Devices development, is an acceptable means, but not the only means, for showing compliance with CS-E 50 (f).

For off-the-shelf equipment or modified equipment, service experience may be used in showing compliance to these standards. This should be acceptable provided the worst case Failure or malfunction of the device for the new installation is no more severe than that for original installation of the same equipment on another installation. Consideration should also be given to any significant differences related to environmental, operational or the category of the aircraft where the original system was installed and certified.

## (12) AIRCRAFT-SUPPLIED DATA

### (a) Objective

As required by CS-E 50(g), in case of loss, interruption, or corruption of Aircraft-Supplied Data, the Engine should continue to function in a safe and acceptable manner, without unacceptable effects on thrust or power, Hazardous Engine Effects, or loss of ability to comply with the operating specifications of CS-E 390, CS-E 500(a) and CS-E 745, as appropriate.

### (b) Background

Historically, regulatory practice was to preserve the Engine independence from the aircraft. Hence even with very reliable architecture, such as triply redundant air data computer (ADC) systems, it was required that the Engine Control System provided an independent control means that could be used to safely fly the aircraft should all the ADC signals be lost.

However, with the increased Engine-aircraft integration that is currently occurring in the aviation industry and with the improvement in reliability and implementation of Aircraft-Supplied Data, the regulatory intent is being revised to require that Fault Accommodation be provided against single Failures of Aircraft-Supplied Data. This may include Fault Accommodation by transition into another Control Mode that is independent of Aircraft-Supplied Data.

The Engine Control System's LOTC/LOPC analysis should contain the effects of air data system Failures in all allowable Engine Control System and air data system dispatch configurations.

When Aircraft-Supplied Data can affect Engine Control System operation, the applicant should address the following items, as applicable, in the SSA or other appropriate documents:

- Software in the data path to the EECS should be at a level consistent with that defined for the EECS. The data path may include other aircraft equipment, such as aircraft thrust management computers, or other avionics equipment.
- The applicant should state in the instructions for installation that the aircraft applicant is responsible for ensuring that changes to aircraft equipment, including software, in the data path to the Engine do not affect the integrity of the data provided to the Engine as defined by the Engine instructions for installation.
- The applicant should supply the effects of faulty and corrupted Aircraft-Supplied Data on the EECS in the Engine instructions for installation.

- The instructions for installation should state that the installer should ensure that those sensors and equipment involved in delivering information to the EECS are capable of operating in the EMI, HIRF and lightning environments, as defined in the certification basis for the aircraft, without affecting their proper and continued operation.
- The applicant should state the reliability level for the Aircraft-Supplied Data that was used as part of the SSA and LOTC/LOPC analysis as an “assumed value” in the instructions for installation.

As stated in CS-E 50(g), thrust and power command signals sent from the aircraft are not subject to the specifications of CS-E 50(g)(2). If the aircraft thrust or power command system is configured to move the Engine thrust or power levers or transmit an electronic signal to command a thrust or power change, the Engine Control System merely responds to the command and changes Engine thrust or power as appropriate. The Engine Control System may have no way of knowing that the sensed throttle or power lever movement was correct or erroneous.

In both the moving throttle (or power lever) and non-moving throttle (or power lever) configurations, it is the installer’s responsibility to show that a proper functional hazard analysis is performed on the aircraft system involved in generating Engine thrust or power commands, and that the system meets the appropriate aircraft’s functional hazard assessment safety related specifications. This task is an aircraft certification issue, however Failures of the system should be included in the Engine’s LOTC/LOPC analysis.

(c) Design assessment

The applicant should prepare a Fault Accommodation chart that defines the Fault Accommodation architecture for the Aircraft-Supplied Data.

There may be elements of the Engine Control System that are mounted in the aircraft and are not part of the Engine type design, but which are dedicated to the Engine Control System and powered by it, such as a throttle position resolver. In these instances, such elements are considered to be an integral component of the Electronic Engine Control System and are not considered aircraft data.

In the case where the particular Failure modes of the aircraft air data may be unknown, the typical Failure modes of loss of data and erroneous data should be assumed. The term “erroneous data” is used herein to describe a condition where the data appears to be valid but is incorrect.

Such assumptions and the results of the evaluation of erroneous aircraft data should be provided to the installer.

The following are examples of possible means of accommodation:

- Provision of an Alternate Mode that is independent of Aircraft-Supplied Data.
- Dual sources of aircraft-supplied sensor data with local Engine sensors provided as voters and alternate data sources.
- Use of synthesised Engine parameters to control or as voters. When synthesised parameters are used for control or voting purposes, the analysis should consider the impact of temperature and other environmental effects on those sensors whose data are used in the synthesis. The variability of any data or information necessary to relate the data from the sensors used in the synthesis to the parameters being synthesised should also be assessed.

- Triple redundant ADC systems that provide the required data.

If for aircraft certification it is intended to show that the complete loss of the aircraft air data system itself is extremely improbable, then it should be shown that the aircraft air data system is unaffected by a complete loss of aircraft generated power, for example, backed up by battery power. (See [AMC 20-1](#))

(d) Effects on the Engine

CS-E 510 defines the Hazardous Engine Effects for turbine Engines.

CS-E 50(g) is primarily intended to address the effects of aircraft signals, such as aircraft air data information, or other signals which could be common to all Engine Control Systems in a multi-Engine installation. The control system design should ensure that the full-up system is capable of providing the declared minimum rated thrust or power throughout the Engine operating envelope.

CS-E 50(g) requires the applicant to provide an analysis of the effect of loss or corruption of aircraft data on Engine thrust or power. The effects of Failures in Aircraft-Supplied Data should be documented in the SSA as described in Section (8) above. Where appropriate, aircraft data Failures or malfunctions that contribute to LOTC/LOPC events should be included in the LOTC/LOPC analysis.

(e) Validation

Functionality of the Fault Accommodation logic should be demonstrated by test, analysis, or combination thereof. In the case where the aircraft air data system is not functional because of the loss of all aircraft generated power, the Engine Control System should include validated Fault Accommodation logic which allows the Engine to operate acceptably with the loss of all aircraft-supplied air data. Engine operation in this system configuration should be demonstrated by test.

For all dispatchable Control Modes, see CS-E 1030 and AMC E 1030.

If an Alternate Mode, independent of Aircraft-Supplied Data, has been provided to accommodate the loss of all data, sufficient testing should be conducted to demonstrate that the operability specifications have been met when operating in this mode. Characteristics of operation in this mode should be included in the instructions for installation and operation as appropriate. This Alternate Mode need not be dispatchable.

### (13) AIRCRAFT SUPPLIED ELECTRICAL POWER

(a) Objective

The objective is to provide an electrical power source that is single Fault tolerant (including common cause or mode) in order to allow the EECS to comply with CS-E 50(c)(2). The most common practice for achieving this objective has been to provide a dedicated electrical power source for the EECS. When aircraft electrical power is used, the assumed quality and reliability levels of this aircraft power should be contained in the instructions for installation.

(b) Electrical power sources

An Engine dedicated power source is defined herein as an electric power source providing electrical power generated and supplied solely for use by a single Engine Control System. Such a source is usually provided by an alternator(s), mechanically driven by the Engine or the transmission system of rotorcraft. However, with the increased integration of the Engine-aircraft systems and with the application of EECS to small Engines, both piston

and turbine, use of an Engine-mounted alternator may not necessarily be the only design approach for meeting the objective.

Batteries are considered an Aircraft-Supplied Power source except in the case of piston Engines. For piston Engines, a battery source dedicated solely to the Engine Control System may be accepted as an Engine dedicated power source. In such applications, appropriate information for the installer should be provided including, for example, health status and maintenance requirements for the dedicated battery system.

(c) Analysis of the design architecture

An analysis and a review of the design architecture should identify the requirements for Engine dedicated power sources and Aircraft-Supplied Power sources. The analysis should include the effects of losing these sources. If the Engine is dependent on Aircraft-Supplied Power for any operational functions, the analysis should result in a definition of the requirements for Aircraft-Supplied Power.

The following configurations have been used:

- EECS dependent on Aircraft-Supplied Power
- EECS independent of Aircraft-Supplied Power (Engine dedicated power source)
- Aircraft-Supplied Power used for functions, switched by the EECS
- Aircraft-Supplied Power directly used for Engine functions, independently from the EECS
- Aircraft-Supplied Power used to back up the Engine dedicated power source

The capacity of any Engine dedicated power source, required to comply with CS-E 50(h)(2), should provide sufficient margin to maintain confidence that the Engine Control System will continue to function in all anticipated Engine operating conditions where the control system is designed and expected to recover Engine operation automatically in-flight. The autonomy of the Engine Control System should be sufficient to ensure its functioning in the case of immediate automatic relight after unintended shutdown. Conversely, the autonomy of the Engine Control System in the whole envelope of restart in windmilling conditions is not always required. This margin should account for any other anticipated variations in the output of the dedicated power source such as those due to temperature variations, manufacturing tolerances and idle speed variations. The design margin should be substantiated by test and/or analysis and should also take into account any deterioration over the life of the Engine.

(d) Aircraft-Supplied Power Reliability

Any Aircraft-Supplied Power reliability values used in system analyses, whether supplied by the aircraft manufacturer or assumed, should be contained in the instructions for installation.

When Aircraft-Supplied Power is used in any architecture, if aircraft power Faults or Failures can contribute to LOTC/LOPC or Hazardous Engine Effects, these events should be included in the Engine SSA and LOTC/LOPC analyses.

When compliance with CS-E 50(h)(1) imposes an Engine dedicated power source, Failure of this source should be addressed in the LOTC/LOPC analysis required under CS-E 50 (c). While no credit is normally necessary to be given in the LOTC/LOPC analysis for the use of Aircraft-Supplied Power as a back-up power source, Aircraft-Supplied Power has typically been provided for the purpose of accommodating the loss of the Engine



dedicated power source. However, LOTC/LOPC allowance and any impact on the SSA for the use of Aircraft-Supplied Power as the sole power source for an Engine control Back-up System or as a back-up power source would be reviewed on a case-by-case basis.

In some system architectures, an Engine dedicated power source may not be required and Aircraft-Supplied Power may be acceptable as the sole source of power.

An example is a system that consists of a primary electronic single channel and a full capability hydromechanical Back-up System that is independent of electrical power (a full capability hydromechanical control system is one that meets all CS-E specifications and is not dependent on aircraft power). In this type of architecture, loss or interruption of Aircraft-Supplied Power is accommodated by transferring control to the hydromechanical system. Transition from the electronic to the hydromechanical control system is addressed under CS-E 50(b).

Another example is an EECS powered by an aircraft power system that could support a critical fly-by-wire flight control system. Such a power system may be acceptable as the sole source of power for an EECS. In this example, it should be stated in the instructions for installation that a detailed design review and safety analysis is to be conducted to identify latent failures and common cause failures that could result in the loss of all electrical power. The instructions should also state that any emergency power sources must be known to be operational at the beginning of the flight. Any emergency power sources must be isolated from the normal electrical power system in such a way that the emergency power system will be available no matter what happens to the normal generated power system. If batteries are the source of emergency power, there must be a means of determining their condition prior to flight, and their capacity must be shown to be sufficient to assure exhaustion will not occur before getting the aircraft safely back on the ground.

This will satisfy that appropriate reliability assumptions are provided to the installer.

(e) Aircraft-Supplied Power Quality

When Aircraft-Supplied Power is necessary for operation of the Engine Control System, CS-E 50(h)(3) specifies that the Engine instructions for installation contain the Engine Control System's electrical power supply quality requirements. This applies to any of the configurations listed in paragraph (13)(c) or any new configurations or novel approach not listed that use Aircraft-Supplied Power. These quality requirements should include steady state and transient under-voltage and over-voltage limits for the equipment. The power input standards of RTCA DO-160/EUROCAE ED-14 are considered to provide an acceptable definition of such requirements. If RTCA DO-160/EUROCAE ED-14 is used, any exceptions to the power quality standards cited for the particular category of equipment specified should be stated.

It is recognised that the electrical or electronic components of the Engine Control System when operated on Aircraft-Supplied Power may cease to operate during some low voltage aircraft power supply conditions beyond those required to sustain normal operation, but in no case should the operation of the Engine control result in a Hazardous Engine Effect. In addition, low voltage transients outside the control system's declared capability should not cause permanent loss of function of the control system, or result in inappropriate control system operation which could cause the Engine to exceed any operational limits, or cause the transmission of unacceptable erroneous data.

When aircraft power recovers from a low-voltage condition to a condition within which the control system is expected to operate normally, the Engine Control System should

resume normal operation. The time interval associated with this recovery should be contained in the Engine instructions for installation. It is recognised that Aircraft-Supplied Power conditions may lead to an Engine shutdown or Engine condition which is not recoverable automatically. In these cases the Engine should be capable of being restarted, and any special flight crew procedures for executing an Engine restart during such conditions should be contained in the Engine instructions for operation. The acceptability of any non-recoverable Engine operating conditions - as a result of these Aircraft-Supplied Power conditions - will be determined at aircraft certification.

If Aircraft-Supplied Power supplied by a battery is required to meet an "all Engines out" restart requirement, the analysis according to paragraph 13(c) should result in a definition of the requirements for this Aircraft-Supplied Power. In any installation where aircraft electrical power is used to operate the Engine Control System, such as low Engine speed in-flight re-starting conditions, the effects of any aircraft electrical bus-switching transients or power transients associated with application of electrical loads, which could cause an interruption in voltage or a decay in voltage below that level required for proper control functioning, should be considered.

(f) Effects on the Engine

Where loss of aircraft power results in a change in Engine Control Mode, the Control Mode transition should meet the specifications of CS-E 50(b).

For some Engine control functions that rely exclusively upon Aircraft-Supplied Power, the loss of electrical power may still be acceptable. Acceptability is based on evaluation of the change in Engine operating characteristics, experience with similar designs, or the accommodation designed into the control system.

Examples of such Engine control functions that have traditionally been reliant on aircraft power include:

- Engine start and ignition
- Thrust Reverser deployment
- Anti-Icing (Engine probe heat)
- Fuel Shut-Off
- Over-speed Protection Systems
- Non-critical functions that are primarily performance enhancement functions which, if inoperative, do not affect the safe operation of the Engine.

(g) Validation

The applicant should demonstrate the effects of loss of Aircraft-Supplied Power by Engine test, system validation test or bench test or combination thereof.

**(14) PISTON ENGINES**

Piston Engines are addressed by the sections above; no additional specific guidance is necessary.

CS-E 50 specifications are applicable to these Engines but, when interpretation is necessary, the conditions which would be acceptable for the aircraft installation should be considered.

**(15) ENGINE, PROPELLER AND AIRCRAFT SYSTEMS INTEGRATION AND INTER-RELATION BETWEEN ENGINE, PROPELLER AND AIRCRAFT CERTIFICATION ACTIVITIES****(a) Aircraft or Propeller Functions Integrated into the Engine Control System**

This involves the integration of aircraft or Propeller functions (i.e., those that have traditionally not been considered Engine control functions), into the Electronic Engine Control System's hardware and software.

Examples of this include thrust reverser control systems, Propeller speed governors, which govern speed by varying pitch, and ATTCS. When this type of integration activity is pursued, the EECS becomes part of - and should be included in the aircraft's SSA, and although the aircraft functions incorporated into the EECS may receive review at Engine certification, the acceptability of the safety analysis involving these functions should be determined at aircraft certification.

The EECS may be configured to contain only part of the aircraft system's functionality, or it may contain virtually all of it. Thrust reverser control systems are an example where only part of the functionality is included in the EECS. In such cases, the aircraft is configured to have separate switches and logic (i.e., independent from the EECS) as part of the thrust reverser control system. This separation of reverser control system elements and logic provides an architectural means to limit the criticality of the functions provided by the EECS.

However, in some cases the EECS may be configured to incorporate virtually all of a critical aircraft function. Examples of this "virtual completeness" in aircraft functionality are EECS which contain full authority to govern Propeller speed in turboprop powered aircraft and ATTCS in turbofan power aircraft.

The first of these examples is considered critical because, if an Engine fails, the logic in the Engine Control System should be configured to feather the Propeller on that Engine. Failure to rapidly feather the Propeller following an Engine Failure results in excessive drag on the aircraft, and such a condition can be critical to the aircraft. When functions like these are integrated into the Engine control such that they render an EECS critical, special attention should be paid to assuring that no single (including common cause/mode) Failures could cause the critical Failure condition, e.g. exposure of the EECS to overheat should not cause both an Engine shutdown and Failure of the Propeller to feather.

The second example, that of an ATTCS, is considered critical because the system is required to increase the thrust of the remaining Engine(s) following an Engine Failure during takeoff, and the increased thrust on the remaining Engines is necessary to achieve the required aircraft performance.

All of the above examples of integration involve aircraft functionality that would receive significant review during aircraft certification.

**(b) Integration of Engine Control Functions into Aircraft Systems**

The trend toward systems integration may lead to aircraft systems performing functions traditionally considered part of the Engine Control System. Some designs may use aircraft systems to implement a significant number of the Engine Control System functions. An example would be the complex integrated flight and Engine Control Systems – integrated in aircraft avionics units - which govern Engine speed, rotor speed, rotor pitch angle and rotor tilt angle in tilt-rotor aircraft.

In these designs, aircraft systems may be required to be used during Engine certification. In such cases, the Engine applicant is responsible for specifying the requirements for the EECS in the instructions for installation and substantiating the adequacy of those requirements.

An example of limited integration would be an Engine control which receives a torque output demand signal from the aircraft and responds by changing the Engine's fuel flow and other variables to meet that demand. However, the EECS itself, which is part of the type design, provides all the functionality required to safely operate the Engine in accordance with CS-E or other applicable specifications.

(c) Certification activities

(i) Objective

To satisfy the aircraft specifications, such as CS 25.901, CS 25.903 and CS 25.1309, an analysis of the consequences of Failures of the Engine Control System on the aircraft has to be made. The Engine applicant should, together with the aircraft applicant, ensure that the software levels and safety and reliability objectives for the Engine electronic control system are consistent with these specifications.

(ii) Interface Definition and System Responsibilities

System responsibilities as well as interface definitions should be identified for the functional and hardware and software aspects between the Engine, Propeller and the aircraft systems in the appropriate documents.

The Engine/Propeller/aircraft documents should cover in particular:

- Functional requirements and criticality (which may be based on Engine, Propeller and aircraft considerations)
- Fault Accommodation strategies
- Maintenance strategies
- The software level (per function if necessary),
- The reliability objectives for:
- LOTC/LOPC events
- Transmission of faulty parameters
- The environmental requirements including the degree of protection against lightning or other electromagnetic effects (e.g. level of induced voltages that can be supported at the interfaces)
- Engine, Propeller and aircraft interface data and characteristics
- Aircraft power supply requirements and characteristics (if relevant).

(iii) Distribution of Compliance Tasks

The tasks for the certification of the aircraft propulsion system equipped with Electronic Engine Control Systems may be shared between the Engine, Propeller and aircraft applicants. The distribution of these tasks between the applicants should be identified and agreed with the appropriate Engine, Propeller and aircraft authorities. For further information refer to [AMC 20-1](#).

The aircraft certification should deal with the overall integration of the Engine and Propeller in compliance with the applicable aircraft specifications.

The Engine certification will address the functional aspects of the Engine Control System in compliance with the applicable Engine specifications.

Appropriate evidence provided for Engine certification should be used for aircraft certification. For example, the quality of any aircraft function software and aircraft/Engine interface logic already demonstrated for Engine certification should need no additional substantiation for aircraft certification.

Two examples are given below to illustrate this principle.

- (A) Case of an EECs performing the functions for the control of the Engine and the functions for the control of the Propeller.

The Engine certification would address all general requirements such as software quality assurance procedures, EMI, HIRF and lightning protection levels, effects of loss of aircraft-supplied power.

The Engine certification would address the functional aspects for the Engine functions (safety analysis, rate for LOTC/LOPC events, effect of loss of Aircraft-Supplied Data, etc.). The Fault Accommodation logic affecting the control of the Engine, for example, will be reviewed at that time.

The Propeller certification will similarly address the functional aspects for the Propeller functions. The Fault Accommodation logic affecting the control of the Propeller, for example, will be reviewed at that time.

In this example, the Propeller functions and characteristics defined by the Propeller applicant, that are to be provided by the Engine Control System, would normally need to be refined by flight test. The Propeller applicant is responsible for ensuring that these functions and characteristics, that are provided for use during the Engine certification programme, define an airworthy Propeller configuration, even if they have not yet been refined by flight test.

With regard to changes in design, agreement by all parties involved should be reached so that changes to the Engine Control System that affect the Propeller system, or vice versa, do not lead to any inadvertent effects on the other system.

- (B) Case of an aircraft computer performing the functions for the control of the Engine.

The aircraft certification will address all general requirements such as software quality assurance procedures, EMI, HIRF and lightning protection levels.

The aircraft certification will address the functional aspects for the aircraft functions.

The Engine certification will address the functional aspects for the Engine functions (safety analysis, rate for LOTC/LOPC events, effect of loss of Aircraft-Supplied Data, etc.) The Fault Accommodation logic affecting the control of the Engine, for example, will be reviewed at that time.

## AMC 20-4

### AMC 20-4 Airworthiness Approval and Operational Criteria For the Use of Navigation Systems in European Airspace Designated For Basic RNAV Operations

*ED Decision 2003/12/RM*

This AMC presents Acceptable means of Compliance relative to the implementation of Basic RNAV operations within European designated Airspace, from January 1998. This AMC has been co-ordinated with EUROCONTROL.

#### 1 PURPOSE

This document provides acceptable means of compliance for airworthiness approval and operational criteria for the use of navigation systems in European airspace designated for Basic RNAV operations. The document establishes an acceptable means, but not the only means, that can be used in the airworthiness approval process, and provides guidelines for operators where GPS stand-alone equipment is used as the means for Basic RNAV operations. The document is in accordance with the April 1990 directive issued by the Transport Ministers of ECAC member states and with regard to the Basic RNAV operations as defined within the EUROCONTROL Standard 003-93 Edition 1 and satisfies the intent of ICAO Doc. 9613-AN/937 Manual on Required Navigation Performance (RNP) First Edition - 1994. It is consistent also with Regional Supplementary Procedures contained within ICAO Doc 7030.

#### 2 SCOPE

This document provides guidance related to navigation systems intended to be used for Basic RNAV operations and considers existing airworthiness approval standards as providing acceptable means of compliance. The content is limited to general certification considerations including navigation performance, integrity, functional requirements and system limitations.

Compliance with the guidance in this Leaflet does not constitute an operational authorisation/approval to conduct Basic RNAV operations. Aircraft operators should apply to their Authority for such an authorisation/approval.

ICAO RNP-4 criteria are outside the scope of this AMC, but it is expected that navigation systems based on position updating from traditional radio aids and approved for Basic RNAV operations in accordance with this AMC will have an RNP-4 capability.

#### Related specifications

CS/FAR 25.1301, 25.1307, 25.1309, 25.1321, 25.1322, 25.1431

CS/FAR 23.1301, 23.1309, 23.1311, 23.1321, 23.1322, 23.1431

CS/FAR 27.1301, 27.1309, 27.1321, 27.1322

CS/FAR 29.1301, 29.1309, 29.1321, 29.1322, 29.1431

operating requirements

#### ATC Documents

EUROCONTROL Standard Document 003-93 Edition 1

ICAO Doc. 9613-AN/937 - Manual on Required Navigation Performance (RNP) First Edition - 1994

**Related navigation documents**EASA Acceptable means of Compliance

- AMC 25-11      Electronic Display Systems
- AMC 20-5      Acceptable Means of Compliance for Airworthiness Approval and Operational Criteria for the use of the NAVSTAR Global Positioning System (GPS)

FAA Advisory Circulars

- AC 20-121 A    Airworthiness Approval of LORAN C for use in the U.S. National Airspace System
- AC 20-130()    Airworthiness Approval of Multi-sensor Navigation Systems for use in the U.S. National Airspace System
- AC 20-138      Airworthiness Approval of NAVSTAR Global Positioning System (GPS) for use as a VFR and IFR Supplemental Navigation System
- AC 25-4        Inertial Navigation Systems (INS)
- AC 25-15       Approval of FMS in Transport Category Airplanes
- AC 90-45 A     Approval of Area Navigation Systems for use in the U.S. National Airspace System

ETSOs

- ETSO-C115b    Airborne Area Navigation Equipment Using Multi Sensor Inputs
- ETSO-C129a    Airborne Supplemental Navigation Equipment Using the Global Positioning System (GPS)
- ETSO-C145     Airborne Navigation Sensors Using the Global Positioning System (GPS) Augmented by the Wide Area Augmentation System (WAAS).
- ETSO-C146     Stand-Alone Airborne Navigation Equipment Using the Global Positioning System (GPS) Augmented by the Wide Area Augmentation System (WAAS)

EUROCAE/RTCA documents

- ED-27          Minimum Operational Performance Requirements (MOPR) for Airborne Area Navigation Systems, based on VOR and DME as sensors
- ED-28          Minimum Performance Specification (MPS) for Airborne Area Navigation Computing Equipment based on VOR and DME as sensors
- ED-39          MOPR for Airborne Area Navigation Systems, based on two DME as sensors
- ED-40          MPS for Airborne Computing Equipment for Area Navigation System using two DME as sensors
- ED-58          Minimum Operational Performance Specification (MOPS) for Area Navigation Equipment using Multi-Sensor Inputs
- ED-72()        MOPS for Airborne GPS Receiving Equipment
- DO-180()      Minimum Operational Performance Standards (MOPS) for Airborne Area Navigation Equipment Using a Single Collocated VOR/DME Sensor Input
- DO-18          MOPS for Airborne Area Navigation Equipment Using Multi Sensor Inputs
- DO-200        Preparation, Verification and Distribution of User-Selectable Navigation Data Bases

---

DO-20	User Recommendations for Aeronautical Information Services
DO-208	MOPS for Airborne Supplemental Navigation Equipment Using Global Positioning System (GPS)

### **3 SYSTEMS CAPABILITY**

Area navigation (RNAV) is a method which permits aircraft navigation along any desired flight path within the coverage of either station referenced navigation aids or within the limits of the capability of self-contained aids, or a combination of both methods.

In general terms, RNAV equipment operates by automatically determining aircraft position from one, or a combination, of the following together with the means to establish and follow a desired path:

VOR/DME

DME/DME

INS\* or IRS

LORAN C\*

GPS\*

Equipment marked with an asterisk \*, is subject to the limitations contained in paragraph 4.4.2.

### **4 AIRWORTHINESS APPROVAL**

#### **4.1 Criteria For Basic RNAV System**

##### **4.1.1 Accuracy**

The navigation performance of aircraft approved for Basic RNAV operations within European airspace requires a track keeping accuracy equal to or better than +/- 5 NM for 95% of the flight time. This value includes signal source error, airborne receiver error, display system error and flight technical error.

This navigation performance assumes the necessary coverage provided by satellite or ground based navigation aids is available for the intended route to be flown.

##### **4.1.2 Availability and Integrity**

Acceptable means of compliance for assessment of the effects associated with the loss of navigation function or erroneous display of related information is given in AMC 25-11 paragraph 4 a (3)(viii).

The minimum level of availability and integrity required for Basic RNAV systems for use in designated European airspace can be met by a single installed system comprising one or more sensors, RNAV computer, control display unit and navigation display(s) (e.g. ND, HSI or CDI) provided that the system is monitored by the flight crew and that in the event of a system failure the aircraft retains the capability to navigate relative to ground based navigation aids (e.g. VOR, DME and NDB).



## 4.2 Functional Criteria

### 4.2.1 Required Functions

The following system functions are the minimum required to conduct Basic RNAV operations.

- (a) Continuous indication of aircraft position relative to track to be displayed to the pilot flying on a navigation display situated in his primary field of view  
In addition where the minimum flight crew is two pilots, indication of aircraft position relative to track to be displayed to the pilot not flying on a navigation display situated in his primary field of view
- (b) Display of distance and bearing to the active (To) waypoint
- (c) Display of ground speed or time to the active (To) waypoint
- (d) Storage of waypoints; minimum of 4
- (e) Appropriate failure indication of the RNAV system, including the sensors.

### 4.2.2 Recommended Functions

In addition to the requirements of paragraph 4.2.1, the following system functions and equipment characteristics are recommended:

- (a) Autopilot and/or Flight Director coupling
- (b) Present position in terms of latitude and longitude
- (c) "Direct To" function
- (d) Indication of navigation accuracy (e.g. quality factor)
- (e) Automatic channel selection of radio navigation aids
- (f) Navigation data base
- (g) Automatic leg sequencing and associated turn anticipation

## 4.3 Aircraft Flight Manual - MMEL (Master Minimum Equipment List)

The basis for certification should be stated in the Aircraft Flight Manual (AFM), together with any RNAV system limitations. The AFM may also provide the appropriate RNAV system operating and abnormal procedures applicable to the equipment installed, including, where applicable, reference to required mode and systems configuration necessary to support an RNP capability.

The (Master) Minimum Equipment List MMEL/MEL should identify the minimum equipment necessary to satisfy the Basic RNAV criteria defined in paragraphs 4.1 and 4.2.

## 4.4. Basic RNAV Systems - Acceptable Means Of Compliance

### 4.4.1 Acceptable Means of Compliance

Navigation systems which are installed on aircraft in accordance with the advisory material contained within FAA AC 90-45A, AC 20-130(), AC 20-138 or AC 25-15, are acceptable for Basic RNAV operations. Where reference is made in the AFM to either the above advisory material or the specific levels of available navigation performance (RNP), no further compliance statements will be required.

Compliance may be based also on the lateral navigation standards defined in ETSO-C115b, ETSO-C129a, ED-27/28, ED-39/40, DO-187/ED-58 or DO-180(). However, qualification of the equipment to these standards, in itself, is not considered as sufficient for the airworthiness approval.

#### 4.4.2 Limitations on the Use of Navigation Systems

The following navigation systems, although offering an RNAV capability, have limitations for their use in Basic RNAV operations.

##### 4.4.2.1 INS

INS without a function for automatic radio updating of aircraft position and approved in accordance with AC 25-4, when complying with the functional criteria of paragraph 4.2.1, may be used only for a maximum of 2 hours from the last alignment/position update performed on the ground. Consideration may be given to specific INS configurations (e.g. triple mix) where either equipment or aircraft manufacturer's data, justifies extended use from the last on-ground position update.

INS with automatic radio updating of aircraft position, including those systems where manual selection of radio channels is performed in accordance with flight crew procedures, should be approved in accordance with AC 90-45A or equivalent material.

##### 4.4.2.2 LORAN C

No EASA advisory material currently exists for operational or airworthiness approval of LORAN C system within European airspace. Where LORAN C coverage within European Airspace permits use on certain Basic RNAV routes, AC 20-121A may be adopted as a compliance basis.

##### 4.4.2.3 GPS

The use of GPS to perform Basic RNAV operations is limited to equipment approved to ETSO-C129a, ETSO-C 145, or ETSO-C 146 and which include the minimum system functions specified in paragraph

4.2.1. Integrity should be provided by Receiver Autonomous Integrity Monitoring (RAIM) or an equivalent means within a multi-sensor navigation system. The equipment should be approved in accordance with the [AMC 20-5](#). In addition, GPS stand-alone equipment should include the following functions:

- (a) Pseudorange step detection
- (b) Health word checking.

These two additional functions are required to be implemented in accordance with ETSO-C129a criteria.

Traditional navigation equipment (e.g. VOR, DME and ADF) will need to be installed and be serviceable, so as to provide an alternative means of navigation.

Note: Where GPS stand-alone equipment provides the only RNAV capability installed onboard the aircraft, this equipment, on its own, may be incompatible with a future airspace infrastructure such as Precision RNAV routes, terminal procedures, and where implementation of an augmented satellite navigation system will allow, the decommissioning of traditional ground based radio navigation aids.

## 5 OPERATIONAL CRITERIA FOR USE OF GPS STAND-ALONE EQUIPMENT

### 5.1 General Criteria

GPS stand-alone equipment approved in accordance with the guidance provided in this Leaflet, may be used for the purposes of conducting Basic RNAV operations, subject to the operational limitations contained herein. Such equipment should be operated in accordance with procedures acceptable to the Authority. The flight crew should receive appropriate training for use of the GPS stand-alone equipment for the normal and abnormal operating procedures detailed in paragraphs 5.2 and 5.3.

### 5.2 Normal Procedures

The procedures for the use of navigational equipment on Basic RNAV routes should include the following:

- (a) During the pre-flight planning phase, given a GPS constellation of 23 satellites or less (22 or less for GPS stand-alone equipment that incorporate pressure altitude aiding), the availability of GPS integrity (RAIM) should be confirmed for the intended flight (route and time). This should be obtained from a prediction program either ground-based, or provided as an equipment function (see [Annex 1](#)), or from an alternative method that is acceptable to the Authority.

Dispatch should not be made in the event of predicted continuous loss of RAIM of more than 5 minutes for any part of the intended flight.

- (b) Where a navigation data base is installed, the data base validity (current AIRAC cycle) should be checked before the flight;
- (c) Traditional navigation equipment (e.g. VOR, DME and ADF) should be selected to available aids so as to allow immediate cross-checking or reversion in the event of loss of GPS navigation capability.

### 5.3 Abnormal Procedures in the event of loss of GPS navigation capability

The operating procedures should identify the flight crew actions required in the event of the GPS stand-alone equipment indicating a loss of the integrity monitoring detection (RAIM) function or exceedance of integrity alarm limit (erroneous position). The operating procedures should include the following:

- (a) In the event of loss of the RAIM detection function, the GPS stand-alone equipment may continue to be used for navigation. The flight crew should attempt to cross-check the aircraft position, where possible with VOR, DME and NDB information, to confirm an acceptable level of navigation performance. Otherwise, the flight crew should revert to an alternative means of navigation.
- (b) In the event of exceedance of the alarm limit, the flight crew should revert to an alternative means of navigation.

## Annex 1 to AMC 20-4 – GPS Integrity Monitoring (RAIM) Prediction Program

ED Decision 2003/12/RM

Where a GPS Integrity Monitoring (RAIM) Prediction Program is used as a means of compliance with paragraph 5.2(a) of this document, it should meet the following criteria:

1. The program should provide prediction of availability of the integrity monitoring (RAIM) function of the GPS equipment, suitable for conducting Basic RNAV operations in designated European airspace.
2. The prediction program software should be developed in accordance with at least RTCA DO 178B/EUROCAE 12B, level D guidelines.
3. The program should use either a RAIM algorithm identical to that used in the airborne equipment, or an algorithm based on assumptions for RAIM prediction that give a more conservative result.
4. The program should calculate RAIM availability based on a satellite mask angle of not less than 5 degrees, except where use of a lower mask angle has been demonstrated to be acceptable to the Authority.
5. The program should have the capability to manually designate GPS satellites which have been notified as being out of service for the intended flight.
6. The program should allow the user to select:
  - a) the intended route and declared alternates;
  - b) the time and duration of the intended flight.

## AMC 20-5

### AMC 20-5 Airworthiness Approval and Operational Criteria for the use of the Navstar Global Positioning System (GPS)

*ED Decision 2003/12/RM*

#### 1 PURPOSE

This AMC establishes an acceptable means, but not the only means that can be used for airworthiness approval and provides guidelines for operators in the use of the NAVSTAR Global Positioning System (GPS).

#### 2 RELATED MATERIAL

<u>Document-ID</u>	<u>Title of Document</u>
EUROCAE ED 72A	Minimum Operational Performance Specification for Airborne GPS Receiving Equipment used for Supplemental Means of Navigation
ETSO-C115b/ FAA TSO-C115 ( )	Airborne Area Navigation Equipment using Multi-sensor Inputs
ETSO-C129a/ FAA TSO-C129( )	Airborne Supplemental Navigation Equipment using the Global Positioning System (GPS)
ETSO-C145	Airborne Navigation Sensors Using the Global Positioning System (GPS) Augmented by the Wide Area Augmentation System (WAAS).
ETSO-C146	Stand-Alone Airborne Navigation Equipment Using the Global Positioning System (GPS) Augmented by the Wide Area Augmentation System (WAAS)
RTCA DO 208	Minimum Operational Performance Standards for Airborne Supplemental Navigation Equipment using Global Positioning System (GPS)
FAA AC 20-138	Airworthiness Approval of Global Positioning System (GPS) Navigation Equipment for use as a VFR and IFR Supplemental Navigation System (formerly FAA Notice 8110-47).
FAA AC 20-130A	Airworthiness Approval of Navigation or Flight Management Systems Integrating Multiple Navigation Sensors (formerly FAA Notice 8110-48).
FAA AC 90-94	Guidelines for using GPS Equipment for IFR En-route and Terminal Area Operations and for Non-precision Instrument Approaches in the US National Airspace System
FAA Notice 8110.60	GPS as Primary Means of Navigation for Oceanic/Remote Operations
DOT/FAA/AAR-95/3	FAA Aircraft Certification Human Factors and Operations Checklist for Stand Alone GPS Receivers (TSO C129 Class A)
FAA Order 8400.10	HBAT 95-09, Guidelines for Operational Approval of Global Positioning System (GPS) to Provide the Primary Means of Class II Navigation in Oceanic and Remote Areas of Operation

#### 3 BACKGROUND

3.1 The declaration of Full Operational Capability (FOC) for the NAVSTAR GPS constellation, by the United States Department of Defense (DOD) and Department of Transportation (DOT) gives the civil aviation community the opportunity to use the navigation information provided by the constellation.

- 3.2 Acceptable Means of Compliance for the use of GPS, will assist in the future development of satellite based systems. The aim is to create a Global Navigation Satellite System (GNSS) under civilian control. In the transition to the GNSS, and in order to obtain early benefits, it will be necessary to augment the present military controlled systems - GPS and GLONASS - for example with a combination of geostationary satellites, ground based integrity monitors, civilian funded satellites in conjunction with airborne integrity monitoring techniques such as Receiver Autonomous Integrity Monitoring (RAIM). Other techniques whereby the navigation system determines the integrity of the GPS navigation signals by using other installed aircraft sensor inputs such as INS, DME or other appropriate sensors may be accepted.

Note: Full Operational Capability for GLONASS the Russian navigation system has been declared since 05.02.1996.

- 3.3 Wherever possible, EASA AMC on the use of GPS will follow that authorised by the FAA. However, some differences will be inevitable due to differences in the organisation of national airspace and the datum used to determine position on the earth's surface.
- 3.4 It is assumed that the State's bodies responsible for ATM and aerodromes, will take the necessary steps to authorise/publish the use of GPS.
- 3.5 In the context of this AMC the use of the term „approach“ means „non-precision approach“.

#### 4 TERMINOLOGY

**GPS Class A ( ) equipment** Equipment incorporating both the GPS sensor and navigation capability. This equipment incorporates RAIM as defined by FAA TSO-C129( ).

**GPS Class B ( ) equipment** Equipment consisting of a GPS sensor that provides data to an integrated navigation system e.g. flight management navigation system, multi-sensor navigation system, (FAA TSO-C129( )).

**GPS Class C ( ) equipment** Equipment consisting of a GPS sensor that provides data to an integrated navigation system (e.g. flight management navigation system, multi-sensor navigation system) which provides enhanced guidance to an autopilot or flight director in order to reduce the flight technical error (FAA TSO-C129( )).

**Receiver Autonomous Integrity Monitoring (RAIM)** A technique whereby a GPS receiver processor determines the integrity of the GPS navigation signals using only GPS signals or GPS signals augmented with altitude. This determination is achieved by a consistency check among redundant pseudorange measurements. At least one satellite in addition to those required for navigation should be in view for the receiver to perform the RAIM function (FAA AC 20-138, AC 90-94).

**Stand-Alone GPS Navigation System** Stand-alone GPS equipment is equipment that is not combined with other navigation sensors or navigation systems such as DME, Loran-C, Inertial. Standalone GPS equipment can, however, include other augmentation features such as altimetry smoothing, clock coasting. (FAA AC 20-138).

## **5 AIRWORTHINESS APPROVAL**

The following airworthiness criterion is applicable to the installation of GPS equipment intended for IFR operation, certified according to CS-23, -25, -27 and -29 or the corresponding FAR or national requirements on any aircraft registered in a member state.

### **5.1 General**

This AMC uses FAA Advisory Circulars AC 20-130A and AC 20-138 as the basis for airworthiness approval of GPS.

For certifications granted prior to the issue of these AC's, the corresponding FAA Notices are recognised as being equivalent. The feasibility of this course of action has already been shown: the two Notices have been used within Europe to approve aircraft installations. This AMC is intended to prevent the proliferation of installations of systems non-compliant with the current Advisory Circulars (based for example on the former FAA interim policy dated July 20th 1992).

For multi-sensor navigation systems using GPS inputs, qualified prior to the publication of FAA TSO-C129, where the intent of the TSO may be demonstrated, authorisation for the use of the equipment for the purposes described in this interim guidance may be granted.

The FAA AC's are to be used as Interpretative Material to show compliance with the applicable CS, on each application e.g. 25.1301 and 25.1309.

In the AC's, where reference is made to FAA rules and approval procedures, national or EASA equivalent material should be substituted as appropriate.

### **5.2 Airworthiness Criteria**

The following FAA AC's are to be used as the basis for approval of the GPS equipment installation:

AC 20-130A for multi-sensor navigation systems using GPS inputs

AC 20-138 for stand-alone GPS equipment.

In addition to AC 20-138 stand-alone GPS equipment will need to be approved to FAA TSO-C129.

For all classes of equipment, integrity should be provided either by Receiver Autonomous Integrity Monitoring (RAIM) or an equivalent method, e.g. by comparison within a multi-sensor navigation system with other approved sensors. The following Table summarises the Classes and sub class definitions. The types of equipment are specified in FAA TSO C-129( ). Refer to section 4 of this AMC for the definition of Class A, B or C.

### **5.3 Additional Criteria for all GPS installations**

In showing compliance with the FAA AC material when verifying GPS accuracy by flight test evaluations, position information should be referenced in WGS-84 coordinates.

Class	Stand Alone	Multi Sensor	RAIM	RAIM Equiv.	En Route	Terminal	Non- Precision Approach
A1	X		X		X	X	X
A2	X		X		X	X	
B1		X	X		X	X	X
B2		X	X		X	X	
B3		X		X	X	X	X
B4		X		X	X	X	
C1		X	X		X	X	X
C2		X	X		X	X	
C3		X		X	X	X	X
C4		X		X	X	X	

#### 5.4 Additional Criteria for Stand-alone GPS equipment only.

The following points need to be taken into consideration as part of the airworthiness approval:

- (a) For IFR operations, Class A equipment, is required to be approved to either:
  - (i) FAA TSO-C129a or
  - (ii) FAA TSO-C129 and the additional paragraphs (a).(3),(xv).5 and (a).(6) of TSO C- 129a.
- (b) Where other navigation sources, apart from the stand-alone GPS equipment, provide display and/or guidance to a Flight Director/Autopilot, means should be provided for:
  - a navigation source selector as the only means of selection;
  - clear annunciation of the selected navigation source;
  - display guidance information appropriate to the selected and navigation source; and
  - guidance information to a Flight Director/Autopilot appropriate to the selected and navigation source.

Annunciations for Flight Director, Autopilot and navigation source should be consistent, and compatible with the original design philosophy of the cockpit.
- (c) Loss of navigation capability should be indicated to the flight crew.
- (d) If altitude input is used, loss of altitude information should be indicated by the GPS equipment.
- (e) Installation configuration features provided by the GPS equipment which affect airworthiness or operational approval, such as
  - external CDI selection;
  - external CDI calibration;
  - entering of GPS antenna height above ground;
  - serial Input/Output port configuration;
  - reference datum



should not be selectable by the pilot. Instructions on how to configure the GPS equipment for the particular installation should be listed in the appropriate manual.

- (f) Controls, displays, operating characteristics and pilot interface to GPS equipment should be assessed in relation to flight crew workload, particularly in the approach environment.

The FAA checklist concerning the pilot system interface characteristics (ref. DOT/FAA/AAR-95/3) or an equivalent checklist should be applied for GPS approval.

## 6 OPERATIONAL CRITERIA

This AMC describes acceptable operational criteria for oceanic, en-route, terminal and approach operations, subject to the limitations given below. The operational criteria assumes that the corresponding installation/airworthiness approval has been granted.

Operations of GPS equipment should be in accordance with the AFM or AFM supplement. The (Master) Minimum Equipment List (MMEL/MEL) should identify the minimum equipment necessary to satisfy operations using GPS.

Compliance with the guidance material of this AMC, by itself, is not sufficient to meet the airworthiness or operational criteria specified for Precision RNAV (P-RNAV) operations (See A&GM Section 1, Part 3, TGL 10).

The use of GPS for vertical navigation should not be authorised.

### 6.1 Use of GPS for Oceanic, En-route and Terminal areas

The following table summarises the operational conditions for the use of GPS for IFR oceanic, domestic en-route and terminal area operations.

OCEANIC/REMOTE	EN-ROUTE	TERMINAL
Refer to chapter 7 for specific operational criteria.	Traditional IFR approved navigation equipment will need to be available to continue the flight when integrity* is lost. * Integrity may be provided by RAIM or equivalent See Note 1	Traditional IFR approved navigation equipment will need to be available to continue the flight when integrity* is lost. * Integrity may be provided by RAIM or equivalent See Notes 1, 2 and 3

Notes:

- (1) When applying these conditions, they mean
  - a) The ground based aids on the route to be flown or ground based aids for RNAV-Routes are operational, and
  - b) Aircraft equipment, other than GPS, suitable for the route to be flown, is serviceable
- (2) The SID/STAR will need to be selectable from the navigation data base. The coding of the data base will need to support the officially published SID/STAR.  
Caution: Some navigation data bases may not contain all required flight path parameters to ensure compliance with the published procedure.
- (3) When flying SID/STARs,
  - a) the procedure established by the State of the aerodrome has to be authorised/published by that State for the use of GPS.

- b) the state of operator/registry (as applicable) has to approve the operator for such operations.

## 6.2 Use of GPS Equipment for Non-precision Approaches

In addition to the paragraph 6.1, GPS-based navigation equipment can be used to fly any part of instrument non-precision approaches provided each of the following conditions are met and checked, as required during pre-flight planning:

- (a) The State of operator/registry (as applicable) has authorised the use of multi-sensor equipment using GPS as one sensor or GPS Class A1 equipment for this purpose;
- (b) the State of the aerodrome has authorised/published an approach for use with GPS;
- (c) the published approach procedure is referenced to WGS-84 co-ordinates;
- (d) the navigation database contains current information on the non-precision approach to be flown (actual AIRAC cycle);
- (e) the approach to be flown is retrievable from the database and defines the location of all navigation aids and all waypoints required for the approach;
- (f) the information stored in the data base is presented to the crew in the order shown on the published non-precision approach plate;
- (g) the navigation data base waypoints showing the non-precision approach cannot be changed by the flight crew;
- (h) the appropriate airborne equipment required for the route to be flown from the destination to any required alternate airport and for an approach at this airport, is installed in the aircraft and is operational. Also, the associated ground-based nav aids are operational.
- (i) The approach is selectable from the navigation data base. The coding of the data base will need to support the officially published approach.

Caution: Some navigation data bases may not contain all required flight path parameters to ensure compliance with the published procedure.

### 6.2.1 'Overlay' Approaches

An overlay approach is one which allows pilots to use GPS equipment to fly existing non-precision instrument approach procedures. For the purpose of this document, this is restricted to overlay of approaches based on VOR, VOR/DME or VORTAC, NDB, NDB/DME and RNAV.

In addition to paragraphs 6.2 above, compliance with the published procedure will need to be checked against raw data from ground based nav aids, if

- (a) the integrity monitoring function (RAIM or equivalent) is not available or
- (b) for Class A1 equipment approved prior to this AMC the requirements of paragraph 5.4(a) are not satisfied.

The ground-based nav aids and the associated airborne equipment required for the published approach procedure, will need to be operational.

### 6.2.2 GPS Stand-Alone Approaches

A GPS stand-alone approach refers to a non-precision approach procedure based solely on GPS without reference to conventional ground nav aids.

In addition to paragraphs 6.2 above, each of the following conditions apply:

- (a) the integrity monitoring function (RAIM or equivalent) is available,
- (b) Class A1 equipment complies with the requirements of paragraph 5.4(a) of this AMC;
- (c) the published approach procedure is identified as a GPS approach (e.g.: GPS RWY 27;
- (d) during the pre-flight planning stage for an IFR flight:
  - (i) where a destination alternate is required, a non-GPS based approach procedure is available at the alternate;
  - (ii) where a destination alternate is not required, at least one non-GPS based approach procedure is available at the destination aerodrome;
  - (ii) predictive RAIM or an equivalent prediction tool is used, and the monitoring capability (RAIM or equivalent) is available at the destination aerodrome at the expected time of arrival.
- (e) where a take off and/or en-route alternate is required, at least one non-GPS based approach procedure is available at the alternate(s).
- (f) a missed approach procedure is available based on traditional navigation.

## 7 CRITERIA FOR USE OF GPS IN OCEANIC/REMOTE OPERATIONS

EASA recognises that this operation is a specific application for the use of GPS

FAA Notice 8110.60, titled „GPS as a Primary Means of Navigation for Oceanic/Remote Operations“ proposes interim guidance for approving the installation of GPS equipment to be used for oceanic/remote operations. The notice contains criteria for the GPS equipment in addition to that required for FAA TSO-C129( ) approval, including capability to automatically detect and exclude a GPS satellite failure by means of a fault detection and exclusion (FDE) algorithm. Guidance is included for the detection of a failure which causes a pseudorange step function and for monitoring the use of GPS navigation data. A prediction program to support operational departure restrictions, is defined.

Where GPS is to be used for oceanic/remote operations as an approved Long Range Navigation System (LRNS), then it should be installed in compliance with FAA Notice 8110.60.

For operations in airspace where an aircraft is required to be equipped with two independent LRNS (i.e. dual control display unit, dual GPS antenna, dual power sources, dual GPS sensors, etc.), such as in North Atlantic Minimum Navigation Performance Specification (MNPS) Airspace, both GPS installations should be approved in accordance with FAA Notice 8110.60.

Compliance with the guidance in this notice does not constitute an operational approval. Operators should apply to their Authority for this approval.

## Appendix A to AMC 20-5

*ED Decision 2003/12/RM*

### **A.1 Description of GPS**

- 1.1 The Navstar Global Positioning System (GPS) of the United States Department of Defence (DOD) is a satellite based radio navigation system. Today, twenty-four satellites are in various orbits approximately 11,000 nautical miles above the surface of the earth. Each satellite broadcasts a timing signal and data message. A portion of the data message gives a GPS receiver the orbital details of each satellite. The receiver measures the time taken for the signal to arrive from the satellites in view and from this information computes a position and velocity.
- 1.2 Three satellites are needed to determine a two dimensional position, and four for a three dimensional position. The elevation and geometry of each satellite relative to the receiver should satisfy certain criteria before the designed system accuracy can be achieved. Accuracy in predictable horizontal positions of 100 meters or better should be available on 95% of time and 300 meters or better on 99.99% of time.
- 1.3 The figures quoted for accuracy are based on the assumption that the position given is referenced to the World Geodetic System 1984 (WGS 84) Datum. This datum relates position on the earth's surface or in space to a mathematically defined ellipsoid that approximates the complex shape of the Earth. The point of origin of the WGS 84 Datum is the Earth's centre of mass. This allows position information to be derived for the world from one reference. ICAO adopted WGS 84 as a world standard, to be in use by 1998.
- 1.4 Currently, position information throughout the world is derived from local or regional datums; for example, European Datum 1950 and Nouvelle Triangulation de France (NTF) 1970. These datums use different ellipsoids that approximate the shape of the Earth over a selected area, but are not valid on a global scale. Conversion between datums is possible, but inherent inaccuracies present in National datums can result in large residual errors.
- 1.5 Consequently, a given position today could be referenced to one of many datums and that position may be significantly displaced from the co-ordinates of the same position when measured against WGS 84. Differences of several hundred meters are not uncommon. With the accuracy provided by today's ground based navigation aids - other than precision approach aids - these discrepancies in position between datums become important when flying a non-precision approach. The introduction of position information provided by satellites for more precise navigation changes this situation, but only when all positions world-wide are based on one datum can the full potential of satellite navigation be realised. Until this stage is reached it is necessary to place some restrictions on the airborne use of the Navstar GPS constellation.

### **A.2 Limitations of the GPS Constellation and Equipment**

- 2.1 Currently, this AMC is consistent with the use of GPS as authorised by the FAA in most areas, but certain differences in the characteristics of different airspace leads to differences in application.
- 2.2 Even with FOC, when flying under IFR, the system will not provide the continuity, availability and integrity needed for a Sole Means Air Navigation System. Continuity and availability can be forecast, but determining the integrity of the signals requires other means.
- 2.3 Most existing ground based navigation aids are flight calibrated and can signal an alarm if erroneous signals are being radiated. For example, VOR signal characteristics are monitored and where the set tolerances are not met the VOR automatically stops transmitting. The GPS constellation is monitored from the ground and it may take some considerable time before

users become aware of a malfunction within the system. Several possibilities for providing signal integrity equivalent to that obtained from conventional navigation aids are under consideration, but it will be some years before these possibilities are realised. At present, two methods exist within airborne equipment to provide the integrity of navigation when using GPS signals: Receiver Autonomous Integrity Monitoring (RAIM) and that given by an integrated navigation system where other sensors are used in addition to GPS.

- 2.4 In airborne equipment incorporating both the GPS sensor and navigation capability, determination of a 3D position requires four satellites with adequate elevation and suitable geometry. An additional satellite is needed to perform the RAIM function. A sixth satellite is required to isolate a faulty satellite and to remove it from the navigation solution (FDE function). Where a GPS receiver uses barometric altitude or clock aiding as an augmentation to RAIM, the number of satellites needed for the receiver to perform the RAIM function may be reduced by one, given appropriate geometry. Not all GPS receivers possess RAIM, but in stand-alone GPS equipment this function is essential for airborne use when flying under IFR.
- 2.5 In airborne equipment where a GPS sensor provides data to an integrated navigation system, e.g. FMS or a multi-sensor navigation system, either the GPS sensor is required to provide RAIM, or the multi-sensor navigation system should possess a level of integrity equivalent to that provided by RAIM. This level of integrity is required when flying under IFR.
- 2.6 The availability of six satellites is less than 100%. Consequently, the RAIM function (including FDE) may be interrupted. However, predictive RAIM may be used to predict such interruptions and higher availability figures may be achieved by multi-sensor systems using certain equivalent integrity techniques.
- 2.7 Without proper airborne integrity monitoring implementations, potential for unannounced failures may exist.
- 2.8 At this time, the only GPS NOTAM system available is provided by US Government services.

### **A.3 The Future**

- 3.1 At present, GPS and GLONASS are the only satellite-based system capable of giving a usable service to aviation. It is anticipated that GLONASS, the Russian Global Navigation Satellite System, will provide the same service as GPS, in the future. Combinations of GPS and GLONASS plus other civil satellites and ground augmentation facilities are possible components for a civil Global Navigation Satellite System (GNSS).
- 3.2 This AMC will be extended to the use of GLONASS as soon as applicable.
- 3.3 ICAO has established working groups to develop the principles governing the operation of GNSS. Many technical and institutional issues require resolution before GPS can be used without any restrictions. When GNSS as defined by ICAO becomes available (e.g. GPS augmented by other orbiting satellites, geostationary satellites, ground reference stations and differential techniques, either as individual items or in combination), additional applications will be defined.

## AMC 20-6

### AMC 20-6 Extended Range Operation with Two-Engine Aeroplanes ETOPS Certification and Operation

*ED Decision 2003/12/RM*

#### 1 PURPOSE

This AMC states an acceptable means but not the only means for obtaining approval for two-engine aeroplanes to operate over a route that contains a point further than one hour flying time at the approved one-engine inoperative cruise speed (under standard conditions in still air) from an adequate aerodrome. This AMC allows a continuous curve of diversion time versus propulsion system reliability, however steps of diversion time may be necessary for practical reasons (e.g., 90 minutes, 120 minutes, etc.). Operational requirements may also be related to diversion time.

The content of the AMC will be related to diversion time as follows:

- a. by having three sets of design criteria for 75 minutes or less, more than 75 but less than 90 minutes or above 90 minutes, except that diversion time may be a parameter for the assessment of certain systems;
- b. by applying the same set of criteria for maintenance;
- c. by having three sets of operational criteria: greater than 60 but less than or equal to 90 minutes: greater than 90 minutes but less than or equal to 120 minutes: greater than 120 minutes up to a maximum of 180 minutes.

Accelerated ETOPS.

Operational Approval

Factors to allow reduction or substitution of operator's in-service experience when applying for Accelerated ETOPS, are contained in [Appendix 7](#) of this AMC. Each application will be dealt with by the Authority on a case by case basis and will be based on a specific approved plan. (see [Appendix 7](#))

Type Design Approval (TDA)

- i. 180 minutes ETOPS Approval is considered feasible at the introduction to service of an airframe/engine combination, as long as the Agency is totally satisfied that all aspects of the Approval Plan (CRI) have been completed. The Agency must be satisfied that an approval plan achieves an equivalent level of safety to that intended in that AMC.
- ii. Any deficiency in compliance with the Approved Plan can result in some lesser approval than that sought.
- iii. Operators and Manufacturers will be required to respond to any incident or occurrence in the most expeditious manner. A serious single event or series of related events could result in immediate revocation of ETOPS approval. Any isolated problem not justifying immediate withdrawal of approval, must be included in a Certification Authority approved plan within 30 days.

#### 2 RELATED CERTIFICATION SPECIFICATIONS

CS 25.901, 25.903, 25.1309, 25.1351 d, CS 25 Subpart J, CS-E 510, CS-E 515, CS-E 520, operational requirements.

**3 RESERVED****4 TERMINOLOGY****a. Aerodrome**

(1) Adequate. For the purpose of this AMC, an adequate aerodrome is an aerodrome, which the operator and the Authority consider to be adequate, having regard to the performance requirements applicable at the expected landing weight or mass. In particular, it should be anticipated that at the expected time of use:

(i) The aerodrome will be available, and equipped with necessary ancillary services, such as ATC, sufficient lighting, communications, weather reporting, navaid and emergency services. Rescue and Fire Fighting Services (RFFS) equivalent to ICAO category 4 (for RFFS not located on the aerodrome; capable of meeting the aeroplane with 30 minutes notice) or the relevant aeroplane category if lower, is acceptable for planning purposes only, when being considered as an ETOPS en-route alternate; and

(ii) At least one letdown aid (ground radar would so qualify) will be available for an instrument approach.

(2) Suitable. For the purpose of this AMC a suitable aerodrome is an adequate aerodrome with weather reports, or forecasts, or any combination thereof, indicating that the weather conditions are at or above operating minima and the field condition reports indicate that a safe landing can be accomplished at the time of the intended operation (see [Appendix 3](#)).

**b. Auxiliary Power Unit (APU)**

A gas turbine engine intended for use as a power source for driving generators, hydraulic pumps and other aeroplane accessories and equipment and/or to provide compressed air for aeroplane pneumatic systems.

**c. ETOPS Configuration, Maintenance and Procedures (CMP) Standard**

The particular aeroplane configuration minimum requirements including any special inspection, hardware life limits, Master Minimum Equipment List (MMEL) constraints, and maintenance practices found necessary by the Authority to establish the suitability of an airframe-engine combination for extended range operation.

**d. Engine**

The basic engine assembly as supplied by the engine manufacturer.

**e. Extended Range Operations**

For the purpose of this AMC, extended range operations are those flights conducted over a route that contains a point further than one hour flying time at the approved one-engine-inoperative cruise speed (under standard conditions in still air) from an adequate aerodrome.

**f. Extended Range Entry Point**

The extended range entry point is the point on the aeroplane's outbound route which is one hour flying time at the approved one-engine-inoperative cruise speed (under standard conditions in still air) from an adequate aerodrome.

- g. Maintenance Personnel  
Mechanics, Licensed Ground Engineers, Maintenance Support Personnel.
- h. In-flight Shutdown (IFSD)  
When an engine ceases to function in flight and is shutdown, whether self-induced, crew initiated or caused by some other external influence (i.e., In Flight Shutdown (IFSD) for all causes; for example: due to flameout, internal failure, crew-initiated shutoff, foreign object ingestion, icing, inability to obtain and/or control desired thrust).
- i. ETOPS significant system
- (1) A system for which the fail-safe redundancy characteristics are directly linked to the number of engines, e.g., hydraulic system, pneumatic system, electrical system.
  - (2) A system that may affect the proper functioning of the engines to the extent that it could result in an in-flight shutdown or uncommanded loss of thrust, e.g., fuel system, thrust reverser or engine control or indicating system, engine fire detection system.
  - (3) A system which contributes significantly to the safety of flight and a diversion with one engine inoperative, such as back-up systems used in case of additional failure during the diversion. These include back-up or emergency generator, APU or systems essential for maintaining the ability to cope with prolonged operation at single engine altitudes, such as anti-icing systems.
  - (4) A system for which certain failure conditions may reduce the safety of a diversion, e.g. navigation, communication, equipment cooling, time limited cargo fire suppression, oxygen system.  
  
A system includes all elements of equipment necessary for the control and performance of a particular major function. It includes both the equipment specifically provided for the function in question and other basic equipment such as that necessary to supply power for the equipment operation.
    - (i) Airframe System. Any system on the aeroplane that is not a part of the propulsion system.
    - (ii) Propulsion System. The aeroplane propulsion system includes: each component that is necessary for propulsion; components that affect the control of the major propulsion units; and components that affect the safe operation of the major propulsion units.
- j. Approved One-Engine-Inoperative Cruise Speed
- (1) The approved one-engine-inoperative cruise speed for the intended area of operation must be a speed, within the certificated limits of the aeroplane, selected by the operator and approved by the authority.
  - (2) The operator must use this speed in
    - (i) establishing the outer limit of the area of operation and any dispatch limitation
    - (ii) calculation of single engine fuel requirements under paragraph 10.d.(4) Fuel and Oil Supply of this AMC and



(iii) establishing the level off altitude (net performance) data. This level off altitude (net performance) must clear any obstacle en route by margins as specified in the operational requirements.

(3) As permitted under paragraph 10.f.(3) of this AMC, based on evaluation of the actual situation, the pilot in command has the authority to deviate from the planned one-engine-inoperative cruise speed.

## 5 DISCUSSION

To be eligible for extended range operations, the specified airframe-engine combination should have been certificated to the airworthiness standards of Large Aeroplanes and should be evaluated considering the concepts in paragraph 7, evaluated considering the type design considerations in paragraph 8 and [Appendix 2](#), evaluated considering in-service experience for ETOPS type design discussed in paragraph 9 or Approval Plan (CRI) for Accelerated ETOPS Type Design Approval and evaluated considering the continuing airworthiness and operational concepts outlined in paragraph 10.

## 6 APPLICABILITY AND GRANDFATHER CLAUSES

Applicability and grandfather clauses will be found, when appropriate, in the operational requirements.

## 7 CONCEPTS

Although it is self-evident that the overall safety of an extended range operation cannot be better than that provided by the reliability of the propulsion systems, some of the factors related to extended range operation are not necessarily obvious.

For example, cargo compartment fire suppression/containment capability could be a significant factor, or operational/maintenance practices may invalidate certain determinations made during the aeroplane type design certification or the probability of system failures could be a more significant problem than the probability of propulsion system failures. Although propulsion system reliability is a critical factor, it is not the only factor which should be seriously considered in evaluating extended range operation. Any decision relating to extended range operation with two-engine aeroplanes should also consider the probability of occurrence of any conditions which would reduce the capability of the aeroplane or the ability of the crew to cope with adverse operating conditions.

The following is provided to define the concepts for evaluating extended range operation with two-engine aeroplanes. This approach ensures that two-engine aeroplanes are consistent with the level of safety required for current extended range operation with three and four-engine turbine powered aeroplanes without unnecessarily restricting operation.

### a. Airframe Systems

A number of airframe systems have an effect on the safety of extended range operation; therefore, the type design certification of the aeroplane should be reviewed to ensure that the design of these systems are acceptable for the safe conduct of the intended operation.

### b. Propulsion Systems

In order to maintain a level of safety consistent with the overall safety level achieved by modern aeroplanes, it is necessary for two-engine aeroplanes used in extended range operation to have an acceptably low risk of significant loss of power/thrust for all design and operation related causes (see [Appendix 1](#)).

c. Maintenance and Reliability Programme Definition

Since the quality of maintenance and reliability programmes can have an appreciable effect on the reliability of the propulsion system and the airframe systems required for extended range operation, an assessment should be made of the proposed maintenance and reliability programme's ability to maintain a satisfactory level of propulsion and airframe system reliability for the particular airframe-engine combination.

d. Maintenance and Reliability Programme Implementation

Following a determination that the airframe systems and propulsion systems are designed to be suitable for extended range operation, an in-depth review of the applicant's training programmes, operations and maintenance and reliability programmes should be accomplished to show ability to achieve and maintain an acceptable level of systems reliability to safely conduct these operations.

e. Human Factors

System failures or malfunctions occurring during extended range operation could affect flight crew workload and procedures. Since the demands on the flight crew may increase, an assessment should be made to ensure that more than average piloting skills or crew co-ordination are not required.

f. Approval Basis

Each applicant (manufacturer or operator as appropriate) for extended range Approval should show that the particular airframe-engine combination is sufficiently reliable. Systems required for extended range operation should be shown by the manufacturer to be designed to a fail-safe criteria and should be shown by the operator to be continuously maintained and operated at levels of reliability appropriate for the intended operation.

(1) Type Design ETOPS Approval

- (i) The process which will normally lead to the type design ETOPS Approval can be divided into two steps:
  - (A) Eligibility for ETOPS: The applicant should show that the design features of the particular airframe-engine combination are suitable for the intended operations (see paragraph 8).
  - (B) Capability for ETOPS: The applicant should show that the particular airframe-engine combination, having been recognised eligible for ETOPS, can achieve a sufficiently high level of reliability in service so that safe extended range operation may be conducted. The achievement of the required level of propulsion system reliability is determined in accordance with [Appendix 1](#) (see paragraph 9). The reliability of the airframe systems is determined in accordance with [Appendix 2](#) (see paragraph 8).
- (ii) Evidence that the type design of the aeroplane is approved for extended range operation is normally reflected by a statement in the Authority approved Aeroplane Flight Manual (AFM) and Type Certificate Data sheet which references the CMP standard requirements for extended range operations.

(2) In-service experience

It is also necessary for each operator desiring approval for extended range operation to show that it has obtained sufficient maintenance and operations experience with that particular airframe-engine combination to conduct safely these operations (see paragraph 10.a).

(3) Operations Approval

The type design approval does not reflect a continuing airworthiness or operational approval to conduct extended range operations. Therefore, before approval, each operator should demonstrate the ability to maintain and operate the aeroplane so as to achieve the necessary reliability and to train its personnel to achieve the competence in extended operation. The operational approval to conduct an extended range operation is made by amendment to the operator certificate issued by the appropriate Authority (see paragraph 10) which includes requisite items provided in the AFM.

(4) Continuing Airworthiness

The type design ETOPS Approval holder and the Agency should periodically review the in-service reliability of the airframe-engine combination. Further to these reviews and every time that an urgent problem makes it necessary, the Agency may require that the type design CMP standard be revised to achieve and maintain the desired level of reliability and, therefore safety of the extended range operation. The CMP standard in effect prior to revision will no longer be considered suitable for continued extended range operation. The CMP standard and its revisions, may require priority actions to be implemented before the next ETOPS flight and other actions to be implemented according to a schedule accepted by the Agency.

Note: See also [Appendix 1](#) paragraph e Continuing Airworthiness for Aircraft Systems. Periodically means in this context typically two years. This means that reviews are conducted every 24 months.

## **8 TYPE DESIGN APPROVAL CONSIDERATION FOR ELIGIBILITY**

When a two-engine type design aeroplane is intended to be used in extended range operations, a determination should be made that the design features are suitable for the intended operation. In some cases modifications to systems may be necessary to achieve the desired reliability. The essential airframe systems and the propulsion system for the particular airframe-engine combination should be shown to be designed to fail-safe criteria and through service experience it must be determined that it can achieve a level of reliability suitable for the intended operation.

a. Request for Approval

An aeroplane manufacturer or other civil airworthiness Authorities, requesting a determination that a particular airframe-engine combination is a suitable type design for extended range operation, should apply to the Certification Authority. The Certification Authority will then initiate an assessment of the airframe-engine combination in accordance with paragraphs 8, 9 and [Appendix 1](#) & [2](#) of this AMC.

b. Criteria

The applicant should conduct an evaluation of failures and failure combinations based on engineering and operational consideration as well as acceptable fail-safe methodology.

The analysis should consider effects of operations with a single engine, including allowance for additional stress that could result from failure of the first propulsion system. Unless it can be shown that equivalent safety levels are provided or the effects of failure are minor, failure and reliability analysis should be used as guidance in verifying that the proper level of fail-safe design has been provided. The following criteria are applicable to the extended range operation of aeroplanes with two engines:

- (1) Airframe systems should be shown to comply with CS 25.1309.
- (2) The propulsion systems should be shown to comply with CS 25.901.
  - (i) Engineering and operational judgement applied in accordance with the guidance outlined in paragraph 9 and [Appendix 1](#) should be used to show that the propulsion system can achieve the desired level of reliability.
  - (ii) Contained engine failure, cascading failures, consequential damage or failure of remaining systems or equipment should be assessed in accordance with CS 25.901.
  - (iii) It should be shown during type design evaluation that adequate engine limit margins exist (i.e., rotor speed, exhaust gas temperatures) for conducting extended duration single-engine operation during the diversion at all approved power levels and in all expected environmental conditions. The assessment should account for the effects of additional engine loading demands (e.g., anti-icing, electrical, etc.) which may be necessary during the single-engine flight phase associated with the diversion (see [Appendix 4](#)).

Note: Adequate, as referred to in first line of 8.b.(2)(iii), means that engine limits margins after allowing for the effects of additional loading demands associated with single-engine flight will not exceed the approved engine limits at a particular power setting.

- (3) The safety impact of an uncontained engine failure should be assessed in accordance with CS 25.903, CS-E 510 and CS-E 520.
- (4) The APU installation, if required for extended range operations, should meet the applicable CS 25 provisions (Subpart J, APU) and any additional requirements necessary to demonstrate its ability to perform the intended function as specified by the Authority following a review of the applicant's data. If a certain extended range operation may necessitate in-flight start and run of the APU, it must be substantiated that the APU has adequate capability and reliability for that operation.
- (5) Extended duration, single-engine operations should not require exceptional piloting skills and/or crew co-ordination. Considering the degradation of the performance of the aeroplane type with an engine inoperative, the increased flight crew workload, and the malfunction of remaining systems and equipment, the impact on flight crew procedures should be minimised.

Consideration should also be given to the effects of continued flight with an engine and/or airframe system inoperative on the flight crew's and passengers' physiological needs (e.g., cabin temperature control).

- (6) It should be demonstrated for extended duration single-engine operation, that the remaining power (electrical, hydraulic, pneumatic) will continue to be available at

levels necessary to permit continued safe flight and landing, and to provide those services necessary for the overall safety of the passengers and crew.

Unless it can be shown that cabin pressure can be maintained on single-engine operation at the altitude necessary for continued flight to a suitable aerodrome, oxygen should be available to sustain the passengers and crew for the maximum diversion time.

- (7) In the event of any single failure, or any combination of failures not shown to be Extremely Improbable, it should be shown that electrical power is provided for essential flight instruments, warning systems, avionics, communications, navigation, required route or destination guidance equipment, supportive systems and/or hardware and any other equipment deemed necessary for extended range operation to continue safe flight and landing at a suitable aerodrome. Information provided to the flight crew should be of sufficient accuracy for the intended operation.

Functions to be provided may differ between aeroplanes and should be agreed with the Authority/Agency. These should normally include:

- (i) attitude information;
- (ii) adequate radio communication and intercommunication capability;
- (iii) adequate navigation capability (including weather radar);
- (iv) adequate cockpit and instrument lighting, Emergency lighting and landing lights;
- (v) sufficient captain and first officer instruments, provided cross-reading has been evaluated;
- (vi) heading, airspeed and altitude including appropriate pitot/static heating;
- (vii) adequate flight controls including auto-pilot;
- (viii) adequate engine controls, and restart capability with critical type fuel (from the stand-point of flame out and restart capability) and with the aeroplane initially at the maximum relight altitude;
- (ix) adequate fuel supply system capability including such fuel boost and fuel transfer functions that may be necessary;
- (x) adequate engine instrumentation;
- (xi) such warning, cautions, and indications as are required for continued safe flight and landing;
- (xii) fire protection (cargo, APU and engines);
- (xiii) adequate ice protection including windshield de-icing;
- (xiv) adequate control of cockpit and cabin environment including heating and pressurisation; and,
- (xv) ATC Transponder.

Note: For 90 minutes or less ETOPS operations, the functions to be provided must satisfy the requirements of CS 25.1351(d)(2) as interpreted by AMC 25.1351(d)(4) and (5).

- (8) Three or more reliable and independent electrical power sources should be available. As a minimum, following failure of any two sources, the remaining source should be capable of powering the items specified in paragraph 8.b.(7). If one or more of the required electrical power sources are provided by an APU, hydraulic system, or ram air turbine, the following criteria apply as appropriate:
- (i) The APU, when installed, should meet the criteria in paragraph 8.b.(4).
  - (ii) The hydraulic power source should be reliable. To achieve this reliability, it may be necessary to provide two or more independent energy sources (e.g., bleed air from two or more pneumatic sources).
  - (iii) The Ram Air Turbine (RAT) should be demonstrated to be sufficiently reliable in deployment and use. The RAT should not require engine dependent power for deployment.

Note: For 75 minutes or less ETOPS operations, if one of the required electrical power sources is provided by batteries, the following criteria apply:

The electrical power and distribution system including the standby or alternate power system, should comply with the requirements of CS 25.1351 and associated AMC's. Where the alternate power source provided to comply with CS 25.1351(d) is time limited (e.g. batteries), such a power source should have a capability to enable the items required by the verifying authority in paragraph 8.b.(7) to be powered for the maximum certificated diversion time in still air conditions, plus an allowance for holding, approach and landing, and the likely prevailing weather conditions for the planned routes, (e.g. an allowance for headwinds).

- (9) It should be shown that adequate status monitoring information and procedures on all critical systems are available for the flight crew to make pre-flight, in-flight go/no-go and diversion decisions.
- (10) Extended range operations are not permitted with time-related cargo fire limitations less than the approved maximum diversion time in still air conditions (plus an allowance for 15 minutes holding an approach and landing, and the likely prevailing weather conditions for the planned route, e.g. allowance for headwinds) determined by considering other relevant failures, such as an engine inoperative, and combinations of failures not shown to be Extremely Improbable.
- (11) Airframe and propulsion ice protection should be shown to provide adequate capability (aeroplane controllability, etc.) for the intended operation. This should account for prolonged exposure to lower altitudes associated with the single engine diversion, cruise, holding, approach and landing.
- (12) Solutions to achieve required reliability
- The permanent solution to a problem should be, as far as possible, a hardware/design solution. However, if scheduled maintenance, replacement, and/or inspection are utilised to obtain type design approval for extended range operation, and therefore are required in the CMP standard document, this type of solution should normally be temporary and the specific maintenance information should be easily retrievable and clearly referenced and identified in an appropriate maintenance document.

## c. Analysis of Failure Effects and Reliability

## (1) General

The analysis and demonstration of airframe and propulsion system failure effects and reliability provided by the applicant as required by paragraph 8.b. should be based on in-service experience as required by paragraph 9, and the expected longest diversion time for extended range routes likely to be flown with the aeroplane. If it is necessary in certain failure scenarios to consider less time due to time limited systems, the latter will be established as the maximum diversion time.

## (2) Propulsion systems

(i) An assessment of the propulsion system's reliability for particular airframe-engine combinations should be made in accordance with paragraph 9 and [Appendix 1](#).

(ii) The analysis should consider:

(A) Effects of operation with a single-propulsion system (i.e., high-power demands including extended use of MCT and bleed requirements, etc.) and include possible damage that could result from failure of the first propulsion system.

(B) Effects of the availability and management of fuel for propulsion system operation (i.e., cross-feed valve failures, fuel mismanagement, ability to detect and isolate leaks, etc.).

(C) Effects of other failures, external conditions, maintenance and crew errors, that could jeopardise the operation of the remaining propulsion system, should be examined.

(D) Effect of inadvertent thrust reverser deployment, if not shown to be Extremely Improbable (includes design and maintenance).

## (3) Hydraulic Power and Flight Control

An analysis should be carried out taking into account the criteria detailed in paragraph 8.b.(6).

Consideration of these systems may be combined, since many commercial aeroplanes have full hydraulically powered controls. For aeroplanes with all flight controls being hydraulically powered, evaluation of hydraulic system redundancy should show that single failures or failure combinations, not shown to be Extremely Improbable, do not preclude continued safe flight and landing at a suitable aerodrome. As part of this evaluation, the loss of any two hydraulic systems and any engine should be assumed to occur unless it is established during failure evaluation that there are no sources of damage or the location of the damage sources are such that this failure condition will not occur.

Note: For 75 minutes or less ETOPS approval, additional analysis to show compliance with paragraph 8.b will not be required for airframe systems, where for basic (non ETOPS) Type Design Approval (TDA), compliance with CS 25.1309, or its equivalent, has already been shown.

(4) Services Provided by Electrical Power

An analysis should show that the criteria detailed in paragraphs 8.b.(6), (7) and (8) are satisfied taking into account the exposure times established in paragraph 8.c.(1).

Note: For 75 minutes or less ETOPS approval, additional analysis to show compliance with paragraph 8.b will not be required for airframe systems, where for basic (non ETOPS) Type Design Approval (TDA), compliance with CS 25.1309, or its equivalent, has already been shown.

(5) Equipment Cooling

An analysis should establish that the equipment (including avionics) necessary for extended range operation has the ability to operate acceptably following failure modes in the cooling system not shown to be Extremely Improbable. Adequate indication of the proper functioning of the cooling system should be demonstrated to ensure system operation prior to dispatch and during flight.

Note: For 75 minutes or less ETOPS approval, additional analysis to show compliance with paragraph 8.b will not be required for airframe systems, where for basic (non ETOPS) Type Design Approval (TDA), compliance with CS 25.1309, or its equivalent, has already been shown.

(6) Cargo Compartment

It should be shown that the cargo compartment design and fire protection system capability (where applicable) is consistent with the following:

(i) Design

The cargo compartment fire protection system integrity and reliability should be suitable for the intended operation considering fire detection sensors, liner materials, etc.

(ii) Fire Protection

An analysis or tests should be conducted to show, considering approved maximum diversion in still air (including an allowance for 15-minute holding and/or approach and land), that the ability of the system to suppress or extinguish fires is adequate to ensure safe flight and landing at a suitable aerodrome.

(7) Reserved

(8) Cabin Pressurisation

A review of fail-safe and redundancy features should show that the loss of cabin pressure is Improbable under single-engine operating conditions. Authority/Agency approved aeroplane performance data should be available to verify the ability to continue safe flight and landing after loss of pressure and subsequent operation at a lower altitude (see also paragraph 8.b.(6)).

(9) Cockpit and Cabin Environment

The analysis should show that an adequate cockpit and cabin environment is preserved following all combinations of propulsion and electrical system failures which are not shown to be Extremely Improbable.



Note: For 75 minutes or less ETOPS approval, additional analysis to show compliance with paragraph 8.b will not be required for airframe systems, where for basic (non ETOPS) Type Design Approval (TDA), compliance with CS 25.1309, or its equivalent, has already been shown.

d. Assessment of Failure Conditions

In assessing the fail-safe features and effects of failure conditions, account should be taken of:

- (1) The variations in the performance of the system, the probability of the failure(s), the complexity of the crew action.
- (2) Factors alleviating or aggravating the direct effects of the initial failure condition, including consequential or related conditions existing within the aeroplane which may affect the ability of the crew to deal with direct effects, such as the presence of smoke, aeroplane accelerations, interruption of air-to-ground communication, cabin pressurisation problems, etc.
- (3) A flight test should be conducted to validate expected aeroplane flying qualities and performance considering propulsion system failure, electrical power losses, etc. The adequacy of remaining aeroplane systems and performance and flight crew ability to deal with the emergency, considering remaining flight deck information, will be assessed in all phases of flight and anticipated operating conditions. Depending on the scope, content, and review by the Agency of the manufacturer's data base, this flight test could also be used as a means for approving the basic aerodynamic and engine performance data used to establish the aeroplane performance identified in paragraph 10.d.(6).

e. Authority Aeroplane Assessment Report

The assessment of the reliability of propulsion and airframe systems for a particular airframe-engine combination will be contained in an Authority - approved Aeroplane Assessment Report. This report will be approved by the Certification Authority after review and concurrence by the Authority responsible for Operations. In the case of a subsequent Certification Authority, the report may incorporate partly or totally the report established by the original Authority.

Following approval of the report, the propulsion and airframe system recommendations will be included in an Authority-approved document that establishes the CMP standard requirements for the candidate aeroplane. This document will then be referenced in the Operation Specification and the Aeroplane Flight Manual.

f. ETOPS Type Design Approval

Upon satisfactory completion of the aeroplane evaluation through an engineering inspection and test programme consistent with the type certification procedures of the Agency and sufficient in-service experience data. (see [Appendix 1 & 2](#))

- (1) The type design approval will be reflected in the approved AFM or supplement, and Type Certification Data Sheet or Supplemental Type Certificate which contain directly or by reference the following pertinent information, as applicable:
  - (i) special limitations (if necessary), including any limitations associated with a maximum diversion time established in accordance with paragraph 8.c.(1);
  - (ii) additional markings or placards (if required);

- (iii) revision to the performance section in accordance with paragraph 10.d.(6);
- (iv) the airborne equipment, installation, and flight crew procedures required for extended range operations;
- (v) description or reference to a document containing the approved aeroplane configuration CMP standard;
- (vi) a statement to the effect that:

"The type design reliability and performance of this airframe-engine combination has been evaluated in accordance with AMC 20-6 and found suitable for (state maximum diversion time) extended range operations with the incorporation of the approved aeroplane configuration CMP standard. This finding does not constitute approval to conduct extended range operations".

g. Type Design Change Process

- (1) The Agency will include the consideration of extended range operation in its normal monitoring and design change approval functions.
- (2) The Propulsion System Reliability Assessment Board (PSRAB) will periodically check that the propulsion system reliability requirements for extended range operation (see [Appendix 1](#)) are achieved or maintained.

Note: Periodically means in this context two years.

- (3) Any significant problems which adversely affect extended range operation will be corrected. Modifications or maintenance actions to achieve or maintain the reliability objective of extended range operations for the airframe-engine combination will be incorporated into the design CMP standard document. The Agency/Authority will co-ordinate this action with the affected manufacturer and operator.
- (4) The Airworthiness Directive process may be utilised as necessary to implement a CMP standard change.

h. Continued Airworthiness

The type design CMP standard which establishes the suitability of an aeroplane for extended range operation defines the minimum standard for the operation.

Additional modifications or maintenance actions generated by an operator or manufacturer to enhance or maintain the continued airworthiness of the aeroplane must be made through the normal approval process.

The operator or manufacturer (as appropriate) should thoroughly evaluate such changes to ensure that they do not adversely affect reliability or conflict with requirements for extended range approval.

## 9 IN-SERVICE EXPERIENCE FOR ETOPS TYPE DESIGN APPROVAL

In establishing the suitability of a type design in accordance with paragraph 8 of this AMC and as a pre-requisite to obtaining any operational approval in accordance with the criteria of paragraph 10 of this AMC, it should be shown that an acceptable level of propulsion system and airframe systems reliability can be or has been achieved in service by the world fleet for the particular airframe-engine combination.

For this purpose, prior to the type design approval, paragraph 8, it should be shown that the world fleet of the particular airframe-engine combination for which approval is sought can

achieve or has achieved, as determined by the Agency (see [Appendix 1](#)), an acceptable and reasonably stable level of single propulsion system in-flight shutdown (IFSD) rate and airframe system reliability. Engineering and operational judgement applied in accordance with the guidance outlined in [Appendix 1](#) will then be used to determine that the IFSD rate objective for all independent causes can be or has been achieved. This assessment is an integral part of the determination in paragraph 8.b.(2) for type design approval. This determination of propulsion system reliability is derived from a world fleet data base containing, in accordance with requirements of [Appendix 1](#), all in-flight shutdown events, all significant engine reliability problems, design and test data and available data on cases of significant loss of thrust, including those where the propulsion system failed or the engine was throttled back or shut down by the pilot. This determination will take due account of the approved maximum diversion time, proposed rectification of all identified propulsion and ETOPS significant systems problems, as well as events where in-flight starting capability may be degraded.

## 10 OPERATIONAL APPROVAL CONSIDERATIONS

Three sets of criteria are to be used:

- Operational approval criteria for extended range operations with a maximum diversion time of 90 minutes or less to an en-route alternate (at the approved one-engine-inoperative cruise speed under standard conditions in still air). Paragraphs 10.a. to 10.i. and [Appendix 5](#) apply.
- Operational approval for extended range operations with a maximum diversion time above 90 minutes up to 120 minutes to an en-route alternate (at the approved one-engine-inoperative cruise speed under standard conditions in still air). Paragraph 10.a. to 10.i. applies.
- Operational approval for extended range operations with a maximum diversion time above 120 minutes up to 180 minutes to an en-route alternate (at the approved one-engine-inoperative cruise speed under standard conditions in still air). Paragraph 10j applies in addition to 10.a. to 10.i.

Purposes of Appendices:

Appendices 3, 4 and 5 provide additional and expanded explanations on the requirements for en-route alternates and maintenance requirements respectively.

### a. Requesting Approval

Any operator requesting approval for extended range operations with two-engine aeroplanes (after the satisfaction of the considerations in paragraphs 8 and 9) should submit the requests, with the required supporting data, to the Authority at least 3 months prior to the proposed start of extended range operation with the specific airframe-engine combination.

#### (1) In-service Experience for Operational Approval

Each operator requesting Approval will be required to have appropriate experience. A summary must be provided to the Authority, indicating the operator's capability to maintain and operate the specific airframe-engine combination for the intended extended range operation. This summary should include experience with the engine type or related engine types, experience with the aeroplane systems or related aeroplane systems, or experience with the particular airframe-engine combination on non-extended range routes. Approval would be based on a review of this information.

Note 1: Additional information regarding Reduction of Operator's in-service experience is contained in [Appendix 7](#).

Note 2: The operator's authorised maximum diversion time may be progressively increased by the Authority as the operator gains experience on the particular airframe-engine combination. Not less than 12 consecutive months experience will normally be required before authorisation of 120 minutes maximum diversion time, unless the operator can show compensating factors. The factors to consider may include calendar time, total number of flights, operator's diversion events, record of the airframe-engine combination with other operators, quality of operator's programmes and route structure. However, the operator will still need, in the latter case, to demonstrate his capability to maintain and operate the new airframe-engine combination at a similar level of reliability.

- (2) In considering an application from an operator to conduct extended range operations, an assessment should be made of the operator's overall safety record, past performance, flight crew training and experience, and maintenance programme. The data provided with the request should substantiate the operator's ability and competence to safely conduct and support these operations and should include the means used to satisfy the considerations outlined in this paragraph. (Any reliability assessment obtained, either through analysis or service experience, should be used as guidance in support of operational judgements regarding the suitability of the intended operation.)

b. Assessment of the Operator's Propulsion System Reliability

Following the accumulation of adequate operating experience by the world fleet of the specified airframe-engine combination and the establishment of an IFSD rate objective in accordance with [Appendix 1](#) for use in ensuring the propulsion system reliability necessary for extended range operations, an assessment should be made of the applicant's ability to achieve and maintain this level of propulsion system reliability.

This assessment should include trend comparisons of the operator's data with other operators as well as the world fleet average values, and the application of a qualitative judgement that considers all of the relevant factors. The operator's past record of propulsion system reliability with related types of power units should also be reviewed, as well as its record of achieved systems reliability with the airframe-engine combination for which authorisation is sought to conduct extended range operations.

Note: Where statistical assessment alone may not be applicable, e.g., when the fleet size is small, the applicant's experience will be reviewed on a case-by-case basis.

c. Engineering Modifications and Maintenance Programme Considerations

Although these considerations are normally part of the operator's continuing airworthiness programme, the maintenance and reliability programme may need to be supplemented in consideration of the special requirements of extended range operation (Appendix 4). The following items, as part of the operator's programme will be reviewed to ensure that they are adequate for extended range operations:

(1) Engineering Modifications

The operator should provide to the Authority all titles and numbers of all modifications, additions, and changes which were made in order to substantiate the incorporation of the CMP standard in the aeroplanes used in extended range operation.

(2) Maintenance Procedures

Following Approval of the changes in the maintenance and training procedures, substantial changes to maintenance and training procedures, practices, or limitations established to qualify for extended range operations should be submitted to the Authority at least two months before such changes may be adopted.

(3) Reliability Reporting

The reliability reporting programme as supplemented and approved, should be implemented prior to and continued after approval of extended range operation. Data from this process should result in a suitable summary of problem events, reliability trends and corrective actions and be provided regularly to the Authority and to the relevant airframe and engine manufacturers. [Appendix 4](#) contains additional information concerning propulsion and airframe system reliability monitoring and reporting.

(4) Implementation

Approved modifications and inspections which would maintain the reliability objective for the propulsion and airframe systems as a consequence of Airworthiness Directive (AD) actions and/or revised CMP standards should be promptly implemented.

Note: In principle, the CMP does not repeat Airworthiness Directives. An operator thus needs to ensure compliance with both the ADs applicable in its country and the CMP standards when operating ETOPS.

Other recommendations made by the engine and airframe manufacturers should also be considered for prompt implementation. This would apply to both installed and spare parts.

The ETOPS operational approval of each ETOPS operator will require it to keep its ETOPS fleets in conformity with the current CMP standards, taking into account implementation delays (see paragraph 7.f.(4)).

(5) Control Process

Procedures and a centralised control process should be established which would preclude an aeroplane being released for extended range operation after propulsion system shutdown or primary airframe system failure on a previous flight, or significant adverse trends in system performance, without appropriate corrective action having been taken. Confirmation of such action as being appropriate, in some cases, may require the successful completion of one or more non-revenue or non-ETOPS revenue flights (as appropriate) prior to being released on an extended range operation.

(6) Programmes

The maintenance programme used, will ensure that the airframe and propulsion systems will continue to be maintained at the level of performance and reliability necessary for extended range operation, including such programmes as engine condition monitoring and engine oil consumption monitoring.

d. Flight Preparation and In-flight Considerations

(1) General

The flight release considerations specified in this paragraph are in addition to, or amplify, the operational requirements and specifically apply to extended range operations. Although many of the considerations in this AMC are currently incorporated into approved programmes for other aeroplanes or route structures, the unique nature of extended range operations with two-engine aeroplanes necessitates a re-examination of these operations to ensure that the Approved programmes are adequate for this purpose.

(2) Minimum Equipment List (MEL)

System redundancy levels appropriate to extended range operations should be reflected in the Master Minimum Equipment List (MMEL). An operator's MEL may be more restrictive than the MMEL considering the kind of extended range operation proposed and equipment and service problems unique to the operator. Systems considered to have a fundamental influence on flight safety may include, but are not limited to, the following:

- (i) electrical, including battery;
- (ii) hydraulic;
- (iii) pneumatic;
- (iv) flight instrumentation;
- (v) fuel;
- (vi) flight control;
- (vii) ice protection;
- (viii) engine start and ignition;
- (ix) propulsion system instruments;
- (x) navigation and communications;
- (xi) auxiliary power-unit;
- (xii) air conditioning and pressurisation;
- (xiii) cargo fire suppression;
- (xiv) engine fire protection;
- (xv) emergency equipment; and
- (xvi) any other equipment necessary for extended range operations.

(3) Communication and Navigation Facilities

An aeroplane should not be released on an extended range operation unless:

- (i) Communications facilities are available to provide under normal conditions of propagation at the appropriate one-engine-inoperative cruise altitudes, reliable two-way voice communications between the aeroplane and the appropriate air traffic control unit over the planned route of flight and the routes to any suitable alternate to be used in the event of diversion.

- (ii) Non-visual ground navigation aids are available and located so as to provide, taking account of the navigation equipment installed in the aeroplane, the navigation accuracy necessary for the planned route and altitude of flight, and the routes to any alternate and altitudes to be used in the event of an engine shutdown; and
- (iii) Visual and non-visual aids are available at the specified alternates for the anticipated types of approaches and operating minima.

(4) Fuel and Oil Supply

(i) General

An aeroplane should not be released on an extended range operation unless it carries sufficient fuel and oil to meet the operational requirements and any additional fuel that may be determined in accordance with paragraph 10.d.(4)(ii). In computing fuel requirements, at least the following should be considered as applicable:

- (A) Current forecast winds and meteorological conditions along the expected flight path at the appropriate one-engine-inoperative cruise altitude and throughout the approach and landing;
- (B) Any necessary operation of ice protection systems and performance loss due to ice accretion on the unprotected surfaces of the aeroplane;
- (C) Any necessary operation of Auxiliary Power Unit (APU);
- (D) Loss of aeroplane pressurisation and air conditioning; consideration should be given to flying at an altitude meeting oxygen requirements in the event of loss of pressurisation;
- (E) An approach followed by a missed approach and a subsequent approach and landing;
- (F) Navigational accuracy necessary; and
- (G) Any known Air Traffic Control (ATC) constraints.

Note: APU oil consumption should also be considered as necessary.

(ii) Critical Fuel Reserves

In establishing the critical fuel reserves, the applicant is to determine the fuel necessary to fly to the most critical point and execute a diversion to a suitable alternate under the conditions outlined in paragraph 10.d.(4)(iii), the 'Critical Fuel Scenario'. These critical fuel reserves should be compared to the normal applicable operational rule requirements for the flight. If it is determined by this comparison that the fuel to complete the critical fuel scenario exceeds the fuel that would be on board at the most critical point, as determined by applicable operational rule requirements, additional fuel should be included to the extent necessary to safely complete the critical fuel scenario. In consideration of the items listed in paragraph 10.d.(4)(i), the critical fuel scenario should allow for a contingency figure of 5 per cent added to the calculated fuel burn from the critical point to allow for errors in wind forecasts, a 5 per cent penalty in fuel mileage \*\*, any Configuration Deviation List items, both airframe and engine anti-icing; and account for ice

accumulation on unprotected surfaces if icing conditions are likely to be encountered during the diversion. If the APU is a required power source, then its fuel consumption should be accounted for during the appropriate phase(s) of flight.

(\*\* or operator's demonstrated value for in-service deterioration in cruise fuel mileage)

(iii) Critical Fuel Scenario

The following describes a scenario for a diversion at the most critical point. The applicant should confirm the scenario to be used when calculating the critical fuel reserve necessary. It is operationally the most critical when considering both time and aeroplane configuration (e.g., two-engine versus one-engine at 3048 m (10 000 feet) non-standard aeroplane configuration not shown to be Extremely Improbable, paragraph 8.c.(2)(ii)(D)):

- (A) At the critical point, consider simultaneous failure of one propulsion system and the pressurisation system (critical point based on time to a suitable alternate at the approved one-engine-inoperative cruise speed).
- (B) Immediate descent to and continued cruise at 3048 m (10 000 feet) at the relevant one-engine-inoperative cruise speed or continued cruise above 3048 m (10 000 feet) if the aeroplane is equipped with sufficient supplemental oxygen in accordance with the operational requirements.
- (C) Upon approaching the ETOPS en-route alternate, descent to 457 m (1 500 feet) above destination, hold for 15 minutes, initiate an approach followed by a missed approach and then execute a normal approach and landing.

(5) Alternate Aerodromes

An aeroplane should not depart on an extended range operation unless the required take-off, destination and alternate aerodromes, including suitable en-route alternate aerodromes, to be used in the event of propulsion system failure or aeroplane system failure(s) which require a diversion, are listed in the cockpit documentation (e.g. computerised flight plan). Suitable en-route alternates should also be identified and listed in operational flight plan for all cases where the planned route of flight contains a point more than one hour flying time at the one-engine-inoperative speed from an adequate aerodrome. Since these suitable en-route alternates serve a different purpose than the destination alternate aerodrome and would normally be used only in the event of an engine failure or the loss of primary aeroplane systems, an aerodrome should not be listed as a suitable en-route alternate unless:

- (i) The landing distances required as specified in the AFM for the altitude of the aerodrome, for the runway expected to be used, taking into account wind conditions, runway surface conditions, and aeroplane handling characteristics, permit the aeroplane to be stopped within the landing distance available as declared by the aerodrome authorities and computed in accordance with the operational requirements.



- (ii) The aerodrome services and facilities are adequate to permit the conduct of an instrument approach procedure to the runway expected to be used while complying with the applicable aerodrome operating minima.
- (iii) The latest available forecast weather conditions for a period commencing one hour before the established earliest time of landing and ending one hour after the established latest time of landing at that aerodrome, equals or exceeds the authorised weather minima for en-route alternate aerodromes in [Appendix 3](#). In addition, for the same period, the forecast crosswind component, including gusts, for the landing runway expected to be used should not exceed the maximum permitted crosswind for single engine landing taking into account the runway condition (dry, wet or contaminated).
- (iv) During the course of the flight, the flight crew are to continue to remain informed of any significant changes in conditions at designated en-route alternates. Prior to proceeding beyond the extended range entry point, the forecast weather for the time periods established in paragraph 10.d.(5)(iii), aeroplane status, fuel remaining, runway surface conditions, landing distances and aerodrome services and facilities at designated en-route alternates should be evaluated. If any conditions are identified (such as weather forecast below landing minima) which would preclude safe approach and landing, then the pilot should take an appropriate course of action.
- (v) In addition, the operator's programme should provide flight crews with information on adequate aerodromes appropriate to the route to be flown which are not forecast to meet [Appendix 3](#) en-route alternate weather minima. Aerodrome facility information and other appropriate planning data concerning these aerodromes should be provided to flight crews for use when executing a diversion.

Note: The alternate aerodromes should be chosen in order to make it possible for the aeroplane to reach the alternate while complying with the requirements, especially with regard to performance (flight over obstacles) and/or oxygen considerations.

(6) Aeroplane Performance Data

No aeroplane should be released on an extended range flight unless the operator's Operations Manual contains sufficient data to support the critical fuel reserve and area of operations calculation. The following data should be based on Agency/Authority-approved information (see paragraph 8.d.(3)) provided or referenced in the Aeroplane Flight Manual (AFM).

- (i) Detailed one-engine-inoperative performance data including fuel flow for standard and non-standard atmospheric conditions and as a function of airspeed and power setting, where appropriate, covering:
  - (A) driftdown (includes net performance);
  - (B) cruise altitude coverage including 3048 m (10 000 feet);
  - (C) holding;
  - (D) altitude capability (includes net performance); and

- (E) missed approach.
  - (ii) Detailed all-engine-operating performance data, including nominal fuel flow data, for standard and non-standard atmospheric conditions and as a function of airspeed and power setting, where appropriate, covering:
    - (A) Cruise (altitude coverage including 3048 m (10 000 feet)); and
    - (B) Holding.
  - (iii) Details of any other conditions relevant to extended range operation which can cause significant deterioration of performance, such as ice accumulation on the unprotected surfaces of the aeroplane, Ram Air Turbine (RAT) deployment, thrust reverser deployment, etc.
  - (iv) The altitudes, airspeeds, thrust settings, and fuel flow used in establishing the ETOPS area of operations for each airframe-engine combination must be used in showing the corresponding terrain and obstruction clearances in accordance with the operational requirements.
- e. Flight Crew Training, Evaluation, and Operating Manuals
- (1) Adequacy of Flight Crew Training and Operating Manuals

The Authority will review in-service experience of significant aeroplane systems. The review will include system reliability levels and individual event circumstances, including crew actions taken in response to equipment failures or unavailabilities. The aviation industry should provide information for and participate in these reviews. The Authority will use the information resulting from these reviews to modify or update flight crew training programmes, operating manuals and checklists, as necessary.
  - (2) Flight Crew Training and Evaluation Programme

The operator's training programme in respect to extended range operations should provide training for flight crew members followed by subsequent evaluations and proficiency checks as well as refresher training in the following areas:

    - (i) Introduction to ETOPS regulations
    - (ii) Routes and aerodromes intended to be used in the ETOPS area of operations
    - (iii) Performance:
      - (A) Flight planning, including all contingencies.
      - (B) Flight performance progress monitoring.
    - (iv) Procedures:
      - (A) Diversion Procedures and Diversion 'Decision making'. Special initial and recurrent training to prepare flight crews to evaluate probable propulsion and airframe systems failures should be conducted. The goal of this training should be to establish crew competency in dealing with the most probable operating contingencies.
      - (B) Use of appropriate navigation and communication systems, including appropriate flight management devices.
      - (C) The flight crew should be provided with detailed initial and recurrent training which emphasises abnormal and emergency procedures to be

followed in the event of foreseeable failures for each area of operation, including:

- (1) Procedures for single and multiple failures in flight that would precipitate go/no-go and diversion decisions. If standby sources of electrical power significantly degrade cockpit instrumentation to the pilots, then approved training which simulates approach with the standby generator as the sole power source should be conducted during initial and recurrent training.
  - (2) Operational restrictions associated with these failures including any applicable Minimum Equipment List (MEL) considerations.
  - (3) Procedures for air start of the propulsion systems, including the APU, if required.
  - (4) Crew incapacitation
- (D) Use of emergency equipment including protective breathing and ditching equipment.
- (E) Procedures to be followed in the event that there is a change in conditions at designated en-route alternates which would preclude safe approach and landing.
- (F) Understanding and effective use of approved additional or modified equipment required for extended range operations.
- (G) Fuel Management
- Flight crew should be trained on the fuel management procedures to be followed during the en-route portion of the flight. These procedures should provide for an independent cross-check of fuel quantity indicators. For example fuel flows could be used to calculate fuel burned and compared to indicated fuel remaining.
- (H) Operators should develop and incorporate annual ETOPS refresher training programmes for flight crew qualified for ETOPS operations.

(3) ETOPS Check Programme

The objective of the ETOPS check programme should be to ensure standardised flight crew practices and procedures and also to emphasise the special nature of ETOPS operations. Only pilots with a demonstrated understanding of the unique requirements of ETOPS should be designated as check pilots for ETOPS.

f. Operational Limitations

(1) Area of Operation

- (i) An operator may be authorised to conduct extended range operations within an area where the diversion time, at any point along the proposed route of flight to an adequate aerodrome, is up to a maximum of 180 minutes in still air at the approved one-engine-inoperative cruise speed. Appendices 1 and 4 provide criteria for such operations.

- (ii) In the case of operations cleared up to 120 minutes maximum diversion time, small increases in the diversion time for specific routes may be approved as needed, if it can be shown that the resulting routing will provide an enhancement of overall safety.

Such increases:

- (A) Will require the Authority to assess overall type design including time limited systems, demonstrated reliability;  
and
- (B) to establish an appropriate MEL related to the diversion time required; and
- (C) Will not be more than 15 per cent of the original maximum diversion time approved in accordance with paragraph 10.f.

The area which meets the considerations in paragraph 8.f.(1)(i) may be approved for extended range operations with two-engine aeroplanes and should be specified in the operator certificate issued by the appropriate Authority.

(2) Flight Release Limitation

The flight release limitation should specify the maximum diversion time from a suitable aerodrome for which an operator can conduct a particular extended range operation. The maximum diversion time at the approved one-engine-inoperative cruise speed (under standard conditions in still air) should not be any greater than the value established by paragraph 10.f.(1)(i).

(i) Use of Maximum Diversion Time

The procedures established by the operator should ensure that extended range operation is limited to flight plan routes where the approved maximum diversion time to suitable aerodromes can be met under standard conditions in still air. Operators should provide for:

- (A) Company procedures to state that upon occurrence of an in-flight shutdown of an engine, the pilot should promptly initiate diversion to fly to and land at the nearest aerodrome, in terms of time, determined to be suitable by the flight crew.
- (B) A practice to be established such that in the event of a single or multiple primary system failure, the pilot will initiate the diversion procedure to fly to and land at the nearest aerodrome in terms of time, determined to be suitable by the flight crew, unless it has been justified that no substantial degradation of safety results from continuation of the planned flight.

- (3) Contingency procedures should not be interpreted in any way which prejudices the final authority and responsibility of the pilot in command for the safe operation of the aeroplane.

- g. ETOPS Operational Approval Issued by the Appropriate Authority
- (1) An operator's two-engine aeroplane should not be operated on an extended range flight unless authorised by the operator certificate issued by the appropriate Authority (both maintenance and operations).
  - (2) The operator certificate issued by the appropriate Authority for extended range operations should specifically include provisions covering at least the following:
    - (i) Definition of the particular airframe-engine combinations, including the current approved CMP standard required for extended range operation as normally identified in the AFM (Paragraph 8.f.);
    - (ii) authorised area of operation;
    - (iii) minimum altitudes to be flown along planned and diversionary routes;
    - (iv) the maximum diversion time, at the approved one-engine-inoperative cruise speed (under standard conditions in still air), that at any point on the route the aeroplane may be from a suitable aerodrome for landing;
    - (v) aerodromes nominated for use, including alternates, and associated instrument approaches and operating minima;
    - (vi) the approved maintenance and reliability programme ([Appendix 4](#)) for extended range operation including those items specified in the type design approved CMP standard;
    - (vii) identification of those aeroplanes designated for extended range operation by make and model as well as serial number and registration;
    - (viii) aeroplane performance reference.
- h. Validation of Operator ETOPS Maintenance and Operations Capability
- (1) The operator should demonstrate that it has the competence and capability to conduct safely and support adequately the intended operation.
  - (2) Prior to being granted ETOPS operational approval, the operator should demonstrate that the ETOPS maintenance checks, servicing, and programmes called for in [Appendix 4](#) are being properly conducted at representative departure and destination aerodromes.
  - (3) The operator should also demonstrate that ETOPS flight release practices, policies, and procedures are established for operations to and from representative departure and destination aerodromes.
  - (4) The operator should also demonstrate to the Authority, using the specified airframe-engine combination or preferably by use of an approved simulator, that he has the competence and capability to safely conduct and adequately support the intended operation. The following emergency conditions should be demonstrated during the validation flight unless successful demonstration of these conditions have previously been carried out in an approved simulator:
    - (i) total loss of thrust of one engine, (simulated, in the aeroplane, by setting zero thrust on the simulated failed engine);
    - (ii) total loss of normal generated electrical power;

(iii) any other condition considered to be equivalent in airworthiness, crew work-load or performance risk.

i. Extended Range Operations Approval

Following a type design approval for extended range operations in accordance with paragraph 8 and satisfactory application of the criteria in paragraphs 9 and 10 and prior to the issuance by the appropriate Authority of the ETOPS approval, the operator's application and supporting data should be forwarded to the appropriate Authority for review and concurrence. Following the review and

concurrence by the appropriate Authority, the operational validation flight should be conducted in accordance with any additional guidance specified in the review and concurrence. When the operational validation flight has been evaluated and found acceptable, an applicant may be authorised to conduct extended range operation with the specified airframe-engine combination. Approval to conduct ETOPS is made by the issuance of the operator certificate by the appropriate Authority containing appropriate limitations.

j. Criteria for Operations above 120 minutes and up to 180 minutes

Each operator requesting Approval to conduct extended range operations beyond 120 minutes should have approximately 12 consecutive months of operational in-service experience with the specified ETOPS configured airframe-engine combination in the conduct of 120 minute operations. The amount of service experience may be increased or decreased after a review of operator's experience taking into account all factors including the number of sectors. Prior to approval, the operator's capability to conduct operations and implement effective ETOPS programmes in accordance with the criteria detailed in paragraph 10 will be examined. The record of the operator in conducting its 120 minute programme will be considered when granting Approvals beyond 120 minutes diversion time. These operators should also demonstrate the additional capabilities discussed in this paragraph. Approval will be given on a case-by-case basis for an increase to their area of operation beyond 120 minutes. The area of operation will be defined by a maximum diversion time of 180 minutes to an adequate aerodrome at approved one-engine-inoperative cruise speed (under standard conditions in still air). The release limitation will be a maximum diversion time of 180 minutes to a suitable aerodrome at the approved one-engine-inoperative speed (under standard conditions in still air).

(1) Release Considerations

(i) Minimum Equipment List (MEL)

The MEL should reflect adequate levels of primary system redundancy to support 180 minutes (still air) operations. The systems listed in paragraph 10.d.(2)(i) through (xvi) should be considered.

(ii) Weather

An operator should substantiate that the weather information system which it utilises can be relied upon to forecast terminal and en-route weather with a reasonable degree of accuracy and reliability in the proposed area of operation.

(iii) Fuel

The critical fuel scenario should also consider fuel required for all-engine-operations at 3048 m (10 000 feet) or above 3048 m (10 000 feet) if the aeroplane is equipped with sufficient supplemental oxygen.

(2) Flight Planning

The effects of wind and temperature at the one-engine-inoperative cruise altitude should be accounted for in the calculation of equal-time point. In addition, the operator's programme should provide flight crews with information on adequate aerodromes appropriate to the route to be flown which are not forecast to meet [Appendix 3](#) en-route alternate weather minima. Aerodrome facility information and other appropriate planning data concerning these aerodromes should be provided to flight crews for use when executing a diversion.

(i) Crew Training and Evaluation

If standby sources of electrical power significantly degrade cockpit instrumentation to the pilots, then approved training, that simulates an instrument approach with the standby generator as the sole power source, should be conducted during initial and recurrent training.

(ii) Contingency Procedures

Flight crews should be provided with detailed initial and recurrent training, that emphasises established contingency procedures, for each area of operation intended to be used.

(iii) Diversion Decision Making

Special initial and recurrent training to prepare flight crews to evaluate probable propulsion and airframe systems failures should be conducted. The goal of this training should be to establish crew competency in dealing with the most probable operating contingencies.

Note: Although already required for maximum diversion time between 60 and 120 minutes under standard conditions in still air, the requirements of paragraph 10.j.(2) are emphasised for maximum diversion time beyond 120 minutes.

(iv) Specific instruction should be included in the company operational procedures so that paragraph 10.d.(5)(iv) is applied, with the additional proviso that an alternate should be selected that is within 180 minutes maximum diversion time, at the approved one-engine-inoperative speed (under standard conditions in still air).

(3) Equipment

(i) VHF/HF, Data Link where available

Operators should consider enhancements to their operational control system as soon as they become feasible.

(ii) Automated System Monitoring

The provision of automated aeroplane system status monitoring should be considered in order to enhance the flight crew's ability to make timely diversion decisions.

## **11 CONTINUING SURVEILLANCE**

The fleet average In Flight Shut Down (IFSD) rate for the specified airframe-engine combination will continue to be monitored in accordance with Appendices 1 and 4. As with all other operations, the appropriate Authority should also monitor all aspects of the extended range operations that it has authorised to ensure that the levels of reliability achieved in extended range operations remain at the necessary levels as provided in [Appendix 1](#), and that the operation continues to be conducted safely. In the event that an acceptable level of reliability is not maintained, if significant adverse trends exist, or if significant deficiencies are detected in the type design or the conduct of the ETOPS operation, then the appropriate Authority should initiate a special evaluation, impose operational restrictions, if necessary, and stipulate corrective action for the operator to adopt in order to resolve the problems in a timely manner. The appropriate Authority should alert the Certification Authority when a special evaluation is initiated and provide for their participation.



## Appendix 1 to AMC 20-6 – Propulsion System Reliability Assessment

*ED Decision 2003/12/RM*

### ASSESSMENT PROCESS

To establish whether a particular airframe-engine combination has satisfied the propulsion systems reliability requirements for extended range operation, an assessment will be made by the Agency, using all pertinent propulsion system data. To accomplish the assessment, the Agency will need world fleet data, and data from various sources (the operator, the engine manufacturer and the aeroplane manufacturer) which should be extensive enough and of sufficient maturity to enable the Agency to assess with a high level of confidence, using engineering and operational judgement and standard statistical methods where appropriate, that the risk of total power loss from independent causes is sufficiently low. The Agency will state whether or not the current propulsion system reliability of a particular airframe-engine combination satisfies the relevant criteria. Included in the statement, if the operation is approved, will be the engine build standard, propulsion system configuration, operating condition and limitations required to qualify the propulsion system as suitable for extended range operation.

If an approved engine CMP is maintained by the responsible engine Authority and is duly referenced on the engine Type Certificate Data Sheet, then this must be made available to the Authority conducting the aeroplane propulsion system reliability assessment. Such a CMP must be produced taking into account all the requirements of paragraphs 8 and 9 and should be incorporated or referenced in the aeroplane CMP.

#### a. Service Experience

When considering the acceptability of a propulsion system for extended range operation, maturity should be assessed not only in terms of total fleet hours but also take account of fleet leader time over a calendar time but, also to the extent to which test data and design experience can be used as an alternative.

There are two extremes in the ETOPS process with respect to maturity; one is the demonstration of stable reliability by the accumulation of service experience and the other is by an agreed design and test program between the manufacturers and authorities. The extent to which a propulsion system is a derivative of previous ETOPS-rated systems is also a factor of the level of maturity.

There is justification for the view that modern propulsion systems achieve a stable reliability level by 100 000 hours for new types and 50 000 hours for derivatives. 3 000 to 4 000 hours is considered to be the necessary time in service for a specific unit to indicate problem areas.

Normally, the service experience will be:

- (1) For new propulsion systems: 100 000 hours and 12 months service. Where experience on another aeroplane is applicable, a significant portion of the 100 000 hours should normally be obtained on the candidate aeroplane.

On a case-by-case basis, relevant test and design experience, and maximum diversion time requested, could be taken into account when arriving at the in-service experience required.

- (2) For derivative propulsion systems: 50 000 hours and 12 months service. These values may vary according to the degree of commonality. To this end in determining the derivative status of a propulsion system, consideration should be given to technical criteria referring to the commonality with previous ETOPS-rated engines. Prime areas of concern include:

- (i) Turbomachinery
- (ii) Controls and accessories and control logic
- (iii) Configuration hardware (piping, cables etc.)
- (iv) Aircraft to engine interfaces and interaction
  - (A) Fire
  - (B) Thrust reverser
  - (C) Avionics
  - (D) etc.

The extent to which the in-service experience might be reduced would depend upon the degree of commonality with previous ETOPS-rated engines using the above criteria, and would be decided on a case-by-case basis.

Also on a case-by-case basis, relevant test and design experience and maximum diversion time requested, could be taken into account when arriving at the in-service experience required.

Thus, the required experience to demonstrate propulsion system reliability should be determined by

- (i) The extent to which previous service experience of common ETOPS-rated propulsion systems can be considered.
- (ii) To what extent compensating factors such as design similarity and test evidence can be used.
- (iii) The two preceding considerations would then determine the amount of service experience needed for a particular propulsion system proposed for ETOPS.

These considerations would be made on a case-by-case basis and would need to provide a demonstrated level of propulsion system reliability in terms of in flight shut down IFSD rate of the order of 0.05 per 1 000 hours, as is necessary also for new propulsion systems.

b. Data Required for the Assessment

- (1) A list of all engine shutdown events, both ground and inflight, for all causes (excluding normal training events) including flameout. The list should provide the following for each event:
  - (i) date;
  - (ii) airline;
  - (ii) aeroplane and engine identification (model and serial number);
  - (iv) power-unit configuration and modification history;
  - (v) engine position;
  - (vi) symptoms leading up to the event, phase of flight or ground operation;
  - (vii) weather/environmental conditions and reason for shutdown and any comment regarding engine restart potential.

- (2) All occurrences where the intended thrust level was not achieved, or where crew action was taken to reduce thrust below the normal level, for whatever reason:
- (3) Unscheduled engine removals/shop visit rates;
- (4) Total engine hours and aeroplane cycles;
- (5) All events should be considered to determine their effects on ETOPS operations;
- (6) Additional data as required.
- (7) The Agency will also consider relevant design and test data.

c. Risk Management and Risk Model

Propulsion systems approved for extended range operation must be sufficiently reliable to assure that defined safety targets are achieved.

A review of information for modern fixed wing jet powered aircraft shows that the rate of fatal accidents for all causes is in the order of  $0.3 \times 10^{-6}$  per flying hour. The reliability of aeroplane types approved for extended range operation should be such that they achieve at least as good an accident record as equivalent technology equipment. The overall target of  $0.3 \times 10^{-6}$  per flying hour has therefore been chosen as the all-causes safety target.

When considering safety targets, an accepted practice is to allocate appropriate portions of the total to the various potential contributing factors. By applying this practice to the overall target of  $0.3 \times 10^{-6}$  per flying hour, in the proportions previously considered appropriate, the probability of a catastrophic

accident due to complete loss of thrust from independent causes must be no worse than  $0.3 \times 10^{-8}$  per flying hour.

Propulsion system related accidents may result from independent cause events but, based on historical evidence, result primarily from events such as uncontained engine failure events, common cause events, engine failure plus crew error events, human error related events and other. The majority of these factors are not specifically exclusive to ETOPS.

Using an expression developed by ICAO, (ref. AN-WP/5593 dated 15/2/84) for the calculation of engine in-flight shutdown rate, together with the above safety objective and accident statistics, a relationship between target engine in-flight shutdown rate for all independent causes and maximum diversion time has been derived. This is shown in Figure 1.

In order that type design approval may be granted for extended operation range, it will be necessary to satisfy the Agency that after application of the corrective actions identified during the engineering assessment (see Appendix 1, paragraph 1.d.), the target engine in-flight shutdown rates will be achieved. This will provide assurance that the probability objective for loss of all thrust due to independent causes will be met.

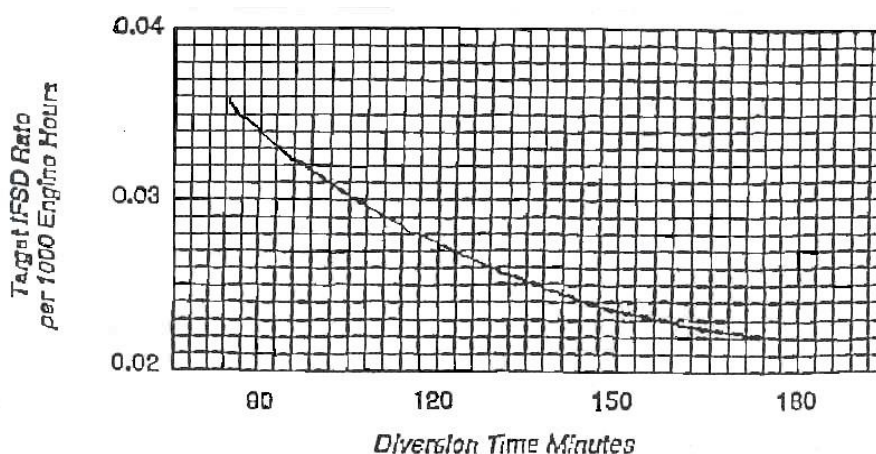

Figure 1: Target IFSD Rate versus Diversion Time

d. Engineering Assessment

- (1) There are maintenance programmes, engine on-wing health monitoring programmes, and the promptness and completeness in incorporating engine service bulletins, etc., that influence an operator's ability to maintain a level of reliability. The data and information required will form a basis from which a world-fleet engine shutdown rate will be established for use in determining whether a particular airframe-engine combination complies with criteria for extended range operation.
- (2) An analysis will be made on a case-by-case basis, of all significant failures, defects and malfunctions experienced in service (or during testing) for the particular airframe-engine combination. Significant failures are principally those causing or resulting in in-flight shutdown or flameout of the engine(s), but may also include unusual ground failures and/or unscheduled removal of engines. In making the assessment, consideration will be given to the following:
  - (i) The type of propulsion system, previous experience, whether the power-unit is new or a derivative of an existing model, and the operating thrust level to be used after one engine shutdown.
  - (ii) The trends in the cumulative twelve month rolling average, updated quarterly, of in-flight shutdown rates versus propulsion system flight hours and cycles.
  - (iii) The demonstrated effect of corrective modifications, maintenance, etc. on the possible future reliability of the propulsion system.
  - (iv) Maintenance actions recommended and performance and their effect on propulsion system and APU failure rates.
  - (v) The accumulation of operational experience which covers the range of environmental conditions likely to be encountered.
  - (vi) Intended maximum flight duration, and maximum diversion in the ETOPS segment, used in the extended range operation under consideration.
- (3) Engineering judgement will be used in the analysis of paragraph 1.d.(2) such that the potential improvement in reliability, following the introduction of corrective actions identified during the analysis, can be quantified.

- (4) The resultant predicted reliability level and the criteria developed in accordance with paragraph 1.c will together be used to determine the maximum diversion time for which the particular airframe-engine combination qualifies.
- (5) The type design standard for type approval of the airframe-engine combination for extended range operations will include all modifications and maintenance actions for which full or partial credit is taken in paragraph 1.d.(3) and other such actions required by the Agency to enhance reliability. The schedule for incorporation of type design standard items should normally be established in the Configuration Maintenance Procedures (CMP) for example in terms of calendar time, hours or cycles.
- (6) When a foreign manufacturer's and/or operator's data are evaluated, the respective foreign Airworthiness Authority will be offered the opportunity to participate in the assessment.
- (7) Propulsion System Reliability Assessment Board (PSRAB) Findings. Once an assessment has been completed and the PSRAB has documented its findings, the Agency will declare whether or not the particular combination satisfies the relevant considerations of this AMC. Items recommended to qualify the propulsion system, such as maintenance requirements and limitations will be included in the Assessment Report (paragraph 8.e.).
- (8) In order to establish that the predicted propulsion system reliability level is achieved, and subsequently maintained, the aircraft manufacturer should submit to the Agency an assessment of the reliability of the propulsion system on a quarterly basis. The assessment should concentrate on the ETOPS configured fleet and should include ETOPS related events from the non-configured fleet of the subject airframe-engine combination, and from other combinations utilising a related engine model.

e. Continuing Airworthiness

The Agency will periodically review its original findings. In addition, the Agency document containing the CMP standard will be revised as necessary.

The periodic meetings of the ETOPS Reliability Tracking Board prescribed in this AMC are normally frequent at the start of the assessment of a new product, the periodicity is adjusted by the Agency upon accumulation of substantial service experience if there is evidence that the reliability of the product is sufficiently stable. The periodic meetings of the board are discontinued once an ETOPS product or family of products has been declared mature by the Agency.

(1) Mature ETOPS products

A family of ETOPS products with a high degree of similarity is considered as mature once:

- (i) The product family has accumulated at least 250 000 flight hours for an aircraft family or 500 000 operating hours for an engine family;
- (ii) The product family has accumulated service experience covering a comprehensive spectrum of operating conditions (e.g. cold, hot, humid,..);
- (iii) Each ETOPS approved model or variant in the family has achieved the reliability objectives for ETOPS and has remained stable at or below the objectives fleet-wide for at least two years;

New models or significant design changes may not be considered mature until they have individually satisfied the condition of paragraph (i) here-before.

The Reliability Tracking Board Chairman and the Project Certification Manager make the determination of when a product or a product family is considered mature.

(2) Surveillance of mature ETOPS products

The Manufacturer of an ETOPS product which the Agency has found mature should institute a process to monitor the reliability of the product in accordance with the objectives defined in Appendix 1 and 2 of this AMC. In case of occurrence of an event or a series of events or a statistical trend that implies a deviation of the reliability of the ETOPS fleet or a portion of the ETOPS fleet (e.g. one model or a range of serial numbers) above the limits specified for ETOPS in this AMC, the Manufacturer must:

- (i) Inform the Agency and define a means to restore the reliability through a Minor Revision of the CMP, with a compliance schedule to be agreed with the Agency if the situation has no immediate safety impact;
- (ii) Inform the Agency and propose an ad-hoc follow-up by the Agency until the concern has been alleviated or confirmed if the situation requires further assessment;
- (iii) Inform the Agency and propose the necessary corrective action(s) to be mandated by the Agency through an AD if a direct safety concern exists.

In the absence of a specific event or trend requiring action, the Manufacturer must provide the Agency with the basic statistical indicators prescribed in Appendix 1 and 2 of this AMC on a yearly basis.

(3) Design Organisation Approval

Manufacturers of products approved for ETOPS must hold a Design Organisation Approval (DOA) conforming to IR 21. Their approved Design Organisation Manual (DOM) must contain appropriate organisation and procedures covering the tasks and responsibilities of this AMC.

Foreign manufacturers not approved as JAA-DOA must present an equivalent organisation and procedures that satisfies the intent of this paragraph. FAA DER system is considered acceptable.

(4) Minor Revision of the ETOPS CMP Document

A Minor Revision of the ETOPS CMP document is one that contains only editorial adjustments, configurations, maintenance and procedures equivalent to those already approved by the Agency or new reliability improvements which have no immediate impact on the safety of ETOPS flights and are introduced as a means to control the continued compliance with the reliability objectives of ETOPS.

Minor revisions of the ETOPS CMP Document may be approved by designated personnel of the Manufacturer under the provisions of its approved DOM.

Foreign manufacturers not approved as JAA-DOA who operate under the FAA DER system may use their DER to approve Minor Revisions of the CMP.

## Appendix 2 to AMC 20-6 – Aircraft Systems Reliability Assessment

*ED Decision 2003/12/RM*

### ASSESSMENT PROCESS

The intent of this Appendix is to provide additional clarification to paragraphs 8b, 8c,(1) and 7.f.(4). Airframe systems are required to show compliance with CS 25.1309. To establish whether a particular airframe-engine combination has satisfied the reliability requirements concerning the aircraft systems for extended range operations an assessment will be made by the Agency, using all pertinent systems data provided by the applicant. To accomplish this assessment the Agency will need world fleet data, and data from various sources (the operators, the equipment manufacturers, and the aeroplane manufacturer). This data should be extensive enough and of sufficient maturity to enable the Agency to assess with a high level of confidence, that the risk of systems failures during a normal ETOPS flight or a diversion, is sufficiently low in direct relationship with the consequence of such failure conditions, under the operational environment of ETOPS missions.

The Agency will declare whether or not the current system reliability of a particular airframe-engine combination satisfies the relevant criteria.

Included in the declaration will be the airframe build standard, systems configuration, operating conditions and limitations required to qualify the ETOPS significant systems as suitable for extended range operations.

#### a. ETOPS Significant Systems

##### (1) An ETOPS significant system is:

- (i) A system for which the fail-safe redundancy characteristics are directly linked to the number of engines, e.g. hydraulic system, pneumatic system, electrical system.
- (ii) A system that may affect the proper functioning of the engines to the extent that it could result in an inflight shutdown or uncommanded loss of thrust, e.g. fuel system, thrust reverser or engine control or indicating system, engine fire detection system.
- (iii) A system which contributes significantly to the safety of flight and a diversion with one engine inoperative, such as back-up systems used in case of additional failure during the diversion. These include back-up or emergency generator, APU or systems essential for maintaining the ability to cope with prolonged operation at single engine altitudes, such as anti-icing systems.
- (iv) A system for which certain failure conditions may reduce the safety of a diversion, e.g. navigation, communication, equipment cooling, time limited cargo fire suppression, oxygen system.

##### (2) The list of ETOPS significant systems should be agreed with the Agency.

#### b. Reliability Assessment for Systems

The reliability assessment for systems must determine which systems are significant to ETOPS and assure that the reliability of such systems is sufficient in direct relationship with the consequences of their potential malfunctions during ETOPS missions.

The assessment also requires a review of the Systems Safety Assessment (SSA) established in compliance with AMC 25.1309-1 and specific ETOPS requirements in this AMC (e.g., loss of cabin pressurisation during Single Engine Operation), to take into account the particular conditions and requirements applicable to ETOPS missions.

In order to achieve the level of confidence intended for ETOPS, the analytical assessment in the SSA must be confirmed by statistical data from a sufficient data base of directly applicable service experience and by an engineering assessment of the service experience of the airframe systems under review.

Statistical indicators (MTBF/MTBUR) and engineering judgement applied to the individual events must be used to evaluate the maturity and the reliability of all ETOPS significant systems.

c. Analytical Assessment

The SSA conducted in accordance with CS 25.1309 of all ETOPS significant systems must be reviewed as follows:

- (1) Conduct a (supplemental) Functional Hazard Assessment (FHA) considering the ETOPS missions. In determining the effect of a failure condition during an ETOPS mission, the following should also be reviewed:
  - (i) Crew workload over a prolonged period of time
  - (ii) Operating conditions at single engine altitude
  - (iii) Lesser crew familiarity with the procedures and conditions to fly to and land at diversion airfields.
- (2) Introduce any additional failure scenario/objectives necessary to comply with this AMC.
- (3) Consider maximum ETOPS flight duration and maximum ETOPS diversion time for all probability calculations. (The probability calculations for those systems that cannot affect the proper functioning of the engines or systems where fail safe/redundancy is not affected by the number of engines, but which could cause a diversion or contribute to the safety of a diversion, may be based on average fleet risk mission time for ETOPS operated aircraft, assuming a maximum diversion time.  
(Note - not average risk mission time for whole fleet.)
- (4) Consider effects of prolonged time and single engine altitude in terms of continued operation of remaining systems following failures.
- (5) Specific ETOPS maintenance tasks and/or intervals or specific ETOPS flight procedures necessary to attain the safety objectives must be included in the appropriate approved document (e.g. CMP document, MMEL).

d. Service Experience/Systems Safety Assessment (SSA)

When considering the acceptability of airframe systems for extended range operations, maturity should be assessed in terms of the maturity of the technology being used and the maturity of the particular design under review.

In performing the SSA's particular account will be taken of the following:

- (1) For equipment identical or close to equipment used on other aircraft, the SSA failure rates will be validated by in-service experience.

The amount of service experience (either direct or related) must be indicated for each equipment of an ETOPS significant system.

Where related service experience is used to validate failure modes and rates, an analysis must be produced to show the validity of the service experience.



In particular, if the same equipment is used on a different aircraft type, it must be shown that there is no difference in operating conditions (vibrations, pressure, temperature) or that these differences do not adversely affect the failure modes and rates.

If service experience on similar equipment on other aircraft is claimed to be applicable an analysis must be produced substantiating the reliability figures used on the quantitative analysis. This substantiation analysis should include details of the differences between the similar and new equipment, details of the service experience of the similar equipment and details of any "lessons learnt" modifications introduced and included in the new equipment.

For certain equipment, (e.g., IDGs, TRUs, bleeds, emergency generator) this analysis may have to be backed up by tests. This must be agreed with the Agency.

- (2) For new or substantially modified equipment, account will be taken in the SSA for the lack of validation of the failure rates by service experience.

A study should be conducted to determine the sensitivity of the assumed SSA failure condition probabilities to the failure rates of that equipment.

Should a failure case probability be sensitive to this equipment failure rate and close to the required safety objective, particular provision precautions may be applied (e.g. temporary despatch restrictions, inspections, maintenance procedures, crew procedures...) to account for the uncertainty until the failure rate has been appropriately validated by service experience.

- (3) In order to confirm that the predicted system reliability level is achieved and maintained, the aircraft manufacturer should monitor the reliability of airframe (ETOPS significant) systems after entry into service. The manufacturer should submit a report to the Agency initially on a quarterly basis (for the first year of operation) and thereafter on a periodic basis and for a time to be agreed with the Agency (see 7.f.(4) and 8.g.(3)). The monitoring task should include ETOPS significant events from both the ETOPS and non-ETOPS fleet of the subject family of airframes. This additional reliability monitoring is required only for those systems that could effect the proper functioning of the engines or systems where the fail-safe/redundancy is affected by the number of engines and back-up systems used in the case of additional failure during the diversion.

Note: See also [Appendix 1](#) paragraph e Continuing Airworthiness for aircraft systems.

## Appendix 3 to AMC 20-6 – Suitable en-route alternate aerodromes

ED Decision 2003/12/RM

### 1 GENERAL

- a. One of the distinguishing features of two-engine extended range operations is the concept of a suitable en-route alternate aerodrome being available to which an aeroplane can divert after a single failure or failure combinations which require a diversion. Whereas most two-engine aeroplanes operate in an environment where there is usually a choice of diversion aerodromes available, the extended range aeroplane may have only one alternate within a range dictated by the endurance of a particular airframe system (e.g., cargo fire suppressant), or by the approved maximum diversion time for that route.
- b. It is, therefore, important that any aerodrome designated as an en-route alternate has the capabilities, services and facilities to support safely that particular aeroplane, and that the weather conditions at the time of arrival provide a high assurance that adequate visual references are available upon arrival at decision height (DH) or minimum descent altitude (MDA), and that the surface conditions are within acceptable limits to permit the approach and landing to be completed safely with one propulsion system and/or airframe systems inoperative.
- c. As well as satisfying the ICAO Annex 6 requirements in relation to crew qualification for operations on such routes, operators should show that these facilities and services specified are available for the proposed operations.

### 2 SUITABLE AERODROME SELECTION

For an aerodrome to be suitable for the purpose of this AMC, it should have the capabilities, services, a minimum of ICAO category 4, or the relevant aeroplane category if lower, Rescue and Fire Fighting Services (RFFS) and facilities necessary to designate it as an adequate aerodrome, (for RFFS not located on the aerodrome; capability of meeting the aeroplane within 30 minutes notice) and have weather and field conditions at the time of that particular operation which provide a high assurance that an approach and landing can be safely completed with one propulsion system and/or airframe systems inoperative, in the event that a diversion to the en-route alternate becomes necessary. Due to the natural variability of weather conditions with time, as well as the need to determine the suitability of a particular en-route aerodrome prior to departure, the en-route alternate weather minima for planning purposes are generally higher than the weather minima necessary to initiate an instrument approach. This is necessary to assure that the instrument approach can be conducted safely if the flight has to divert to the alternate aerodrome. Additionally, since the visual reference necessary to safely complete an approach and landing is determined, among other things, by the accuracy with which the aeroplane can be controlled along the approach path by reference to instrument aids, as well as by the tasks the pilot is required to accomplish to manoeuvre the aeroplane so as to complete the landing, the weather minima for non-precision approaches are generally higher than for precision approaches.

### 3 STANDARD EN-ROUTE ALTERNATE AERODROME PRE-DEPARTURE WEATHER MINIMA

The following are established for flight planning and release purposes with two-engine aeroplanes in extended range operations.

A particular aerodrome may be considered a suitable aerodrome for flight planning and release purposes for extended range operation if it meets the criteria of paragraph 3 of this Appendix and has one of the following combinations of instrument approach capabilities and en-route

alternate aerodrome weather minima at the time of the particular operation. An operator should include in his Operations Manual either Table 1 or Table 2, but not a combination of both, for use in determining the operating minima at the planned en-route alternate aerodrome.

**Table 1 Planning minima - ETOPS**

Approach Facility Configuration	Alternate Airfield Ceiling	Weather Minima Visibility/RVR
For aerodromes with at least one operational navigation facility, providing a precision or non-precision runway approach procedure or a circling manoeuvre from an instrument approach procedure	A ceiling derived by adding 122 m (400 feet) to the authorised DH, MDH (DA/MDA) or circling minima	A visibility derived by adding 1 500 meters to the authorised landing minima.
The weather minima below apply at aerodromes which are equipped with precision or non-precision approaches on at least two separate runways (two separate landing surfaces)		
For aerodromes with at least two operational navigation facilities providing a precision or non-precision runway approach procedure to separate suitable runways	A ceiling derived by adding 61 m (200 feet) to the higher of the authorised DH/MDH (DA/MDA) for the approaches	A visibility derived by adding 800 meters to the higher of the two authorised landing minima

**Table 2 Planning minima – ETOPS**

Type of Approach	Planning Minima (RVR visibility required & ceiling if applicable)			
	Aerodrome with			
	at least 2 separate approach procedures based on 2 separate aids serving 2 separate runways	at least 2 separate approach procedures based on 2 separate aids serving 1 runway	or	at least 1 approach procedure based on 1 aid serving 1 runway
Precision Approach Cat II, III (ILS, MLS)	Precision Approach Cat I Minima	Non-Precision Approach Minima		
Precision Approach Cat I (ILS, MLS)	Non-Precision Approach Minima	Circling minima or, if not available, non-precision approach minima plus 200 ft / 1 000 m		
Non-Precision Approach	The lower of non-precision approach minima plus 200 ft / 1 000 m or circling minima	The higher of circling minima or non-precision approach minima plus 200 ft / 1 000 m		
Circling Approach	Circling minima			

**4 EN-ROUTE ALTERNATE AERODROME PRE-DEPARTURE WEATHER MINIMA TAKING ADVANTAGE OF ADVANCED LANDING SYSTEMS**

It is recognised that the development of advanced landing systems may lead to certified capability for planned single engine Category II and/or Category III approach and landings.

Before advantage of any such capability can be used in the pre-flight selection of an en-route alternate aerodrome the appropriate Authority must be satisfied that the operator has demonstrated that when an ETOPS aircraft has encountered any failure condition in the airframe and/or propulsion system that would result in a diversion to an en-route alternate

aerodrome, subsequent failures during the diversion, that would result in the loss of the capability to safely conduct and complete the Category II/III approach and landing are Improbable. The certificated capability of the airframe-engine combination should be evaluated considering the approved maximum diversion time.

Approval of the planned use of these advanced systems to nominate en-route alternate aerodromes will be on a case-by-case basis and will use the table of paragraph 4 of this Appendix.

#### 5 EN-ROUTE ALTERNATE SUITABILITY IN FLIGHT

See paragraphs 10.d.(5)(iv) and 10.j.(2)(iv).

## Appendix 4 to AMC 20-6 – ETOPS Maintenance Requirements

*ED Decision 2003/12/RM*

### 1 GENERAL

The maintenance programme should contain the standards, guidance and direction necessary to support the intended operations. Maintenance personnel and other personnel involved should be made aware of the special nature of ETOPS and have the knowledge, skills and ability to accomplish the requirements of the programme.

### 2 ETOPS MAINTENANCE PROGRAMME

The basic maintenance programme for the aeroplane being considered for ETOPS is the continuous airworthiness maintenance schedule currently approved for that operator, for the make and model airframe-engine combination. This schedule should be reviewed to ensure that it provides an adequate basis for development of ETOPS maintenance requirements. These should include maintenance procedures to preclude identical action being applied to multiple similar elements in any ETOPS significant system (e.g., fuel control change on both engines).

- a. ETOPS related tasks should be identified on the operator's routine work forms and related instructions.
- b. ETOPS related procedures, such as involvement of centralised maintenance control, should be clearly defined in the operator's programme.
- c. An ETOPS service check should be developed to verify that the status of the aeroplane and certain critical items are acceptable. This check should be accomplished by an authorised and trained person prior to an ETOPS flight. Such a person may be a member of the flight crew.
- d. Log books should be reviewed and documented, as appropriate, to ensure proper MEL procedures, deferred items and maintenance checks, and that system verification procedures have been properly performed.

### 3 ETOPS MANUAL

The operator should develop a manual for use by personnel involved in ETOPS. This manual need not include, but should at least reference, the maintenance programme and other requirements described by this Appendix, and clearly indicate where they are located in the operator's manual system.

All ETOPS requirements, including supportive programmes, procedures, duties, and responsibilities, should be identified and be subject to revision control. This manual should be submitted to the Authority 30 days before implementation of ETOPS flights.

Alternatively, the operator may include this information in existing manuals used by personnel involved in ETOPS.

### 4 OIL CONSUMPTION PROGRAMME

The operator's oil consumption programme should reflect the manufacturer's recommendations and be sensitive to oil consumption trends. It should consider the amount of oil added at the departing ETOPS stations with reference to the running average consumption; i.e., the monitoring must be continuous up to, and including, oil added at the ETOPS departure station. If oil analysis is meaningful to this make and model, it should be included in the programme. If the APU is required for ETOPS operation, it should be added to the oil consumption programme.

## 5 ENGINE CONDITION MONITORING

This programme should describe the parameters to be monitored, method of data collection and corrective action process. The programme should reflect manufacturer's instructions and industry practice. This monitoring will be used to detect deterioration at an early stage to allow for corrective action before safe operation is affected. The programme should ensure that engine limit margins are maintained so that a prolonged single-engine diversion may be conducted without exceeding approved engine limits (i.e., rotor speeds, exhaust gas temperature) at all approved power levels and expected environmental conditions. Engine margins preserved through this programme should account for the

effects of additional engine loading demands (e.g., anti-icing, electrical, etc.) which may be required during the single-engine flight phase associated with the diversion.

## 6 VERIFICATION PROGRAMME AFTER MAINTENANCE

The operator should develop a verification programme or procedures should be established to ensure corrective action following an engine shutdown, primary system failure or adverse trends or any prescribed events which require a verification flight or other action and establish means to assure their accomplishment. A clear description of who must initiate verification actions and the section or group responsible for the determination of what action is necessary should be identified in the programme. Primary systems or conditions requiring verification actions should be described in the operator's ETOPS manual.

## 7 RELIABILITY PROGRAMME

An ETOPS reliability programme should be developed or the existing reliability programme supplemented. This programme should be designed with early identification and prevention of ETOPS related problems as the primary goal. The programme should be event-orientated and incorporate reporting procedures for significant events detrimental to ETOPS flights. This information should be readily available for use by the operator and Authority to help establish that the reliability level is adequate, and to assess the operator's competence and capability to safely continue ETOPS. The Authority should be notified within 96 hours of events reportable through this programme.

a. In addition to the items required to be reported by other regulations, the following items should be included:

- (i) in-flight shutdowns;
- (ii) diversion or turnback;
- (iii) uncommanded power changes or surges;
- (iv) inability to control the engine or obtain desired power; and
- (v) problems with systems critical to ETOPS.

b. The report should identify the following:

- (i) aeroplane identification;
- (ii) engine identification (make and serial number);
- (iii) total time, cycles and time since last shop visit;
- (iv) for systems, time since overhaul or last inspection of the defective unit;
- (v) phase of flight; and
- (vi) corrective action.

## 8 PROPULSION SYSTEM MONITORING

The operator's assessment of propulsion systems reliability for the extended range fleet should be made available to the Authority (with the supporting data) on at least a monthly basis, to ensure that the approved maintenance programme continues to maintain a level of reliability necessary for extended range operation.

The assessment should include, as a minimum, engine hours flown in the period, in flight shut-down rate for all causes and engine removal rate, both on a 12 month moving average basis. Where the combined extended range fleet is part of a larger fleet of the same airframe-engine combination, data from the operator's total fleet will be acceptable. However, the reporting requirements of paragraph 7 of this Appendix must still be observed for the extended range fleet.

Any adverse sustained trend would require an immediate evaluation to be accomplished by the operator in consultation with the Authority. The evaluation may result in corrective action or operational restrictions being applied.

Note: Where statistical assessment alone may not be applicable, e.g., when the fleet size is small, the operator's performance will be reviewed on a case-by-case basis.

## 9 MAINTENANCE TRAINING

The Maintenance training should focus on the special nature of ETOPS. This programme should be included in the normal maintenance training. The goal of this programme is to ensure that all personnel involved in ETOPS are provided with the necessary training so that the ETOPS maintenance tasks are properly accomplished and to emphasise the special nature of ETOPS maintenance requirements. Qualified maintenance personnel are those that have completed the operator's extended range training programme and have satisfactorily performed extended range tasks under supervision, within the framework of the operator's approved procedures for Personnel Authorisation.

## 10 ETOPS PARTS CONTROL

The operator should develop a parts control programme with support from the manufacturer, that ensures the proper parts and configuration are maintained for ETOPS. The programme includes verification that parts placed on an ETOPS aeroplane during parts borrowing or pooling arrangements, as well as those parts used after repair or overhaul, maintain the necessary ETOPS configuration for that aeroplane.

## Appendix 5 to AMC 20-6 – 90 minutes or less ETOPS Operational Program Criteria

ED Decision 2003/12/RM

(Note: 180 min provisions are included in the main text)

### 1. GENERAL

Paragraphs 10.a. through 10.i. of this AMC detail the criteria for operational approval of extended range operations with a maximum diversion time between 60 and 120 minutes to an en route alternate (at approved single-engine inoperative cruise speed). This appendix serves the function of differentiating the criteria for approval of operations up to 90 minutes diversion time.

### 2. 90 - MINUTE OPERATION

Since 1976, two-engine aeroplane operations up to 90 minutes diversion time (two engine speed) were approved over Africa, the Indian Ocean, the Bay of Bengal and the North Atlantic using ICAO recommendations of the time and the applicable operational rule. The aeroplanes performing these missions were not designed to meet all the design and reliability criteria now in Paragraphs 8, 9 and Appendix 1&2 of this AMC and were not subjected to the operational approval criteria detailed in Paragraph 10, Appendices 3, 4 and 7 of this AMC. However, these operations have proven to be safe and successful due to the short duration of the concerned ETOPS sectors, the short diversion time, the favourable operating characteristics of the route and the built-in reliability of the initial product. This experience, along with the ETOPS operational experience gathered since 1985, has led to the development of the 90 minute criteria detailed below. This criteria bridges the gap between the 60 min, non-ETOPS, requirements and the current requirements defined in this AMC. It defines specifically what needs to be accomplished in order to obtain an operational approval with a maximum diversion time of 90 minutes or less.

### 3. CRITERIA FOR APPROVAL TO OPERATE UP TO 90 MINUTES

#### a. Type Design

Compliance must be shown to all applicable paragraphs. Where relevant, specific 90 min, or less, criteria is denoted directly in the text of paragraphs 8 and [Appendix 1](#).

#### b. Operational Approval

Consideration may be given to the approval of extended range operations up to 90-minutes for operators with minimal or no in-service experience with the airframe-engine combination. This determination considers such factors as the proposed area of operations, the operator's demonstrated ability to successfully introduce aeroplanes into operations, the quality of the proposed maintenance and operations programs.

##### (1) Maintenance

Maintenance programs should be instituted which follow the guidance in [Appendix 4](#).

##### (2) Operations

(i) Operation programs should be instituted which follow the guidance in paragraphs 10.d., 10.e. and 10.f. and [Appendix 3](#).



- 
- (ii) Minimum Equipment List (MEL): Provision of the JAA Master Minimum Equipment List (MMEL), including 90 minute or less "Extended Range" provisos.

## Appendix 6 to AMC 20-6 – Not used

ED Decision 2003/12/RM

## Appendix 7 to AMC 20-6 – Reduction of operator's in-service experience requirement prior to the granting of an ETOPS Operational Approval ('Accelerated ETOPS Operational Approval')

ED Decision 2003/12/RM

### A General

The purpose of this appendix is to establish the factors which the Authority may consider in exercising its authority to allow reduction or substitution of operator's in-service experience requirement in granting ETOPS Operational Approval.

Paragraph 7 of this AMC states that "...the concepts for evaluating extended range operations with two-engine aeroplanes....ensures that two-engine aeroplanes are consistent with the level of safety required for current extended range operations with three and four-engine turbine powered aeroplanes without unnecessarily restricting operation".

It is apparent that the excellent propulsion related safety record of two-engine aeroplanes has not only been maintained, but potentially enhanced, by the process related provisions associated with ETOPS Type Design and Operational Approvals. Further, currently available data shows that these process related benefits are achievable without extensive in-service experience. Therefore, reduction or elimination of in-service experience requirements may be possible when the operator shows to the Authority that adequate and validated ETOPS processes are in place.

The Accelerated ETOPS Operational Approval Programme with reduced in-service experience does not imply that any reduction of existing levels of safety should be tolerated but rather acknowledges that an operator may be able to satisfy the objectives of this AMC by a variety of means of demonstrating that operator's capability.

This Appendix permits an operator to start ETOPS operations when the operator has established that those processes necessary for successful ETOPS operations are in place and are considered to be reliable. This may be achieved by thorough documentation of processes, demonstration on another aeroplane/validation (as described in Paragraph G of this Appendix) or a combination of these.

### B Background

When ETOPS requirements were first released in 1985 ETOPS was a new concept, requiring extensive in-service verification of capability to assure the concept was a logical approach. At the time, the Authorities recognised that a reduction in the in-service requirements or substitution of in-service experience, on another aeroplane, would be possible.

The ETOPS concept has been successfully applied for close to a decade; ETOPS is now widely employed. The number of ETOPS operators has increased dramatically, and in the North Atlantic US airlines have more twin operations than the number of operations accomplished by three and four engine aeroplanes. ETOPS is now well established.

Under the AMC, an operator is generally required to operate an airframe-engine combination for one (1) year, before being eligible for 120 minute ETOPS; and another one (1) year, at 120 minute ETOPS, before being granted 180 minute ETOPS approval. For example, an operator who currently has 180 minute ETOPS approval on one type of airframe-engine or who is currently operating that route with an older generation three or four engine aeroplane could be required to wait for up to two (2) years for such an approval. Such a requirement creates undue economic burden on operators and may not contribute to safety. Data indicates that compliance with

processes has resulted in successful ETOPS operation at earlier than the standard time provided for in the AMC.

ETOPS operational data indicates that twins have maintained a high degree of reliability due to heightened awareness of specific maintenance, engineering and flight operation process related requirements. Compliance with ETOPS processes is crucial in assuring high levels of reliability of twins. Data shows that previous experience on an airframe-engine combination prior to operating ETOPS, does not necessarily make a significant difference in the safety of such operations. Commitment to establishment of reliable ETOPS processes has been found to be a much more significant factor. Such commitment, by operators, to ETOPS processes has, from the outset, resulted in operation of twins at a mature level of reliability.

ETOPS experience of the past decade shows that a firm commitment by the operator to establish proven ETOPS processes prior to the start of actual ETOPS operations and to maintain that commitment throughout the life of the programme is paramount to ensuring safe and reliable ETOPS operations.

### **C Terminology Process:**

A process is a series of steps or activities that are accomplished, in a consistent manner, to ensure that a desired result is attained on an ongoing basis. Paragraph D documents ETOPS processes that should be in place to ensure a successful Accelerated ETOPS programme.

Proven Process:

A process is considered to be 'proven' when the following elements are developed and implemented:

- (1) Definition and documentation of process elements
- (2) Definition of process related roles and responsibilities
- (3) Procedure for validation of process elements
  - Indications of process stability/reliability
  - Parameters to validate process and monitor (measure) success
  - Duration of necessary evaluation to validate process
- (4) Procedure for follow-up in-service monitoring to assure process remains reliable/stable. Methods of process validation are provided in paragraph G.

### **D ETOPS Processes**

The two-engine airframe-engine combination for which the operator is seeking Accelerated ETOPS Operational Approval must be ETOPS Type Design approved prior to commencing ETOPS. The operator seeking Accelerated ETOPS Operational Approval must demonstrate to the Authority that it has an ETOPS programme in place that addresses the process elements identified in this paragraph

The following are the ETOPS process elements:

- (1) Aeroplane/engine compliance to Type Design Build Standard (CMP)
- (2) Compliance with the Maintenance Requirements as defined in Paragraph 10 and [Appendix 4](#) of this AMC:
  - Fully developed Maintenance Programme (Appendix 4, paragraph 2) which includes a tracking and control programme.

- ETOPS manual (Appendix 4, paragraph 3) in place.
  - A proven Oil Consumption Monitoring Programme. (Appendix 4, paragraph 4)
  - A proven Engine Condition Monitoring and Reporting system. (Appendix 4, paragraph 5) A proven Plan for Resolution of Aeroplane Discrepancies. (Appendix 4, paragraph 6)
  - A proven ETOPS Reliability Programme. (Appendix 4, paragraph 7)
  - Propulsion system monitoring programme (Appendix 4, paragraph 8) in place. The operator should establish a programme that results in a high degree of confidence that the propulsion system reliability appropriate to the ETOPS diversion time would be maintained.
  - Training and qualifications programme in place for ETOPS maintenance personnel. (Appendix 4, paragraph 9).
  - Established ETOPS parts control programme (Appendix 4, paragraph 10)
- (3) Compliance with the Flight Operations Programme as defined in Paragraph 10 of this AMC. Proven flight planning and dispatch programmes appropriate to ETOPS. of meteorological information and MEL appropriate to ETOPS.
- Initial and recurrent training and checking programme in place for ETOPS flight operations personnel.
- Flight crew and dispatch personnel familiarity assured with the ETOPS routes to be flown; in particular the requirements for, and selection of, en-route alternates.
- (4) Documentation of the following elements:
- Technology new to the operator and significant difference in primary and secondary power (engines, electrical, hydraulic and pneumatic) systems between the aeroplanes currently operated and the two- engine aeroplane for which the operator is seeking Accelerated ETOPS Operational Approval.
- The plan to train the flight and maintenance personnel to the differences identified in 1 above.
- The plan to use proven or manufacturer validated Training and Maintenance and Operations Manual procedures relevant to ETOPS for the two-engine aeroplane for which the operator is seeking Accelerated ETOPS Operational Approval.
- Changes to any previously proven or manufacturer validated Training, Maintenance or Operations Manual procedures described above. Depending on the nature of any changes, the operator may be required to provide a plan for validating such changes.
- The validation plan for any additional operator unique training and procedures relevant to ETOPS, if any.
- Details of any ETOPS programme support from the airframe manufacturer, engine manufacturer, other operators or any other outside agency.
- The control procedures when maintenance or flight dispatch support is provided by an outside party as described above.

**E Application**

Paragraph 10a of this AMC requires that requests for extended range operations be submitted at least 3 months prior to the start of extended range operations. Normally, the operator should submit an 'Accelerated ETOPS Operational Approval Plan' to the Authority six (6) months before the proposed start of extended range operations. This additional time will permit the Authority to review the documented plans and assure adequate ETOPS processes are in place.

The operator's application for Accelerated ETOPS should:

- Define proposed routes and the ETOPS diversion time necessary to support those routes.
  - Define processes and related resources being allocated to initiate and sustain ETOPS operations in a manner which demonstrates commitment by management and all personnel involved in ETOPS maintenance and operational support.
  - Identify, where required, the plan for establishing compliance with the build standard required for Type Design Approval, e.g. CMP (Configuration, Maintenance and Procedures Document) compliance.
  - Document plan for compliance with requirements in Paragraph D.
5. Define Review Gates. A Review Gate is a milestone tracking plan to allow for the orderly tracking and documentation of specific requirements of this Appendix. Each Review Gate should be defined in terms of the tasks to be satisfactorily accomplished in order for it to be successfully passed. Items for which the Authority visibility is required or the Authority approval is sought should be included in the Review Gates. Normally, the Review Gate process will start six (6) months before the proposed start of extended range operations and should continue at least six (6) months after the start of extended range operations. Assure that the proven processes comply with the provisions of Paragraph C of this Appendix.

**F Operational Approvals**

Operational approvals which are granted with reduced in-service experience should be limited to those areas agreed by the Authority at approval of the Accelerated ETOPS Operational Approval Plan. When an operator wishes to add new areas to the approved list, Authority concurrence is required.

Operators will be eligible for ETOPS Operational Approval up to the Type Design Approval limit, provided the operator complies with all the requirements in Paragraph D.

**G Process Validation.**

Paragraph D identifies those process elements that are needed to be proven prior to the start of Accelerated ETOPS. For a process to be considered proven, the process must first be defined. Typically this will include a flow chart showing elements of the process. Roles and responsibilities of the personnel who will be managing this process should be defined including any training requirement. The operator should demonstrate that the process is in place and functions as intended. The operator may accomplish this by thorough documentation and analysis, or by demonstrating on an aeroplane that the process works and consistently provides the intended results. The operator should also show that the feedback loop exists to illustrate need for revision of the process, if required, based on in-service experience.

Normally the choice to use, or not to use, demonstration on an aeroplane as a means of validating the process should be left up to the operator. With sufficient preparation and dedication of resources such validation may not be necessary to assure processes should

produce acceptable results. However, in any case where the proposed plan to prove the processes is determined by the Authority to be inadequate or the plan does not produce acceptable results, validation of the process in an aeroplane may be required.

If any operator is currently operating ETOPS with a different airframe and/or engine combination it may be able to document that it has proven ETOPS processes in place and only minimal further validation may be necessary. It will, however, be necessary to demonstrate that means are in place to assure equivalent results will occur on the aeroplane being proposed for Accelerated ETOPS Operational Approval.

The following elements which, while not required, may be useful or beneficial in justifying a reduction in the requirements of ETOPS processes:

1. Experience with other airframes and/or engines.
2. Previous ETOPS experience.
3. Experience with long range, overwater operations with two, three or four engine aeroplanes.

Any experience gained by flight crews, maintenance personnel and flight dispatch personnel while working with other ETOPS approved operators.

Process validation may be done in the airframe-engine combination which will be used in Accelerated ETOPS operation or in a different aeroplane type than that for which approval is being sought, including those with three and four engines.

A process may be validated by first demonstrating the process produces acceptable results on a different aeroplane type or airframe-engine combination. It should then be necessary to demonstrate that means are in place to assure equivalent results should occur on the aeroplane being proposed for Accelerated ETOPS Operational Approval.

Any validation programme should address the following:

The operator should show that it has considered the impact of the ETOPS validation programme with regard to safety of flight operations. The operator should state in its application any policy guidance to personnel involved in the ETOPS process validation programme. Such guidance should clearly state that ETOPS process validation exercises should not be allowed to adversely impact the safety of actual operations especially during periods of abnormal, emergency, or high cockpit workload operations. It should emphasise that during periods of abnormal or emergency operation or high cockpit workload ETOPS process validation exercises may be terminated.

The validation scenario should be of sufficient frequency and operational exposure to validate maintenance and operational support systems not validated by other means.

A means must be established to monitor and report performance with respect to accomplishment of tasks associated with ETOPS process elements. Any recommended changes to ETOPS maintenance and operational process elements should be defined.

Prior to the start of the process validation programme, the following information should be submitted to the Authority:

- Validation periods, including start dates and proposed completion dates.
- Definition of aeroplane to be used in the validation. List should include registration numbers, manufacturer and serial number and model of the airframe and engines.

- 
- Description of the areas of operation (if relevant to validation objectives) proposed for validation and actual operations.
  - Definition of designated ETOPS validation routes. The routes should be of duration required to ensure necessary process validation occurs.
  - Process validation reporting. The operator should compile results of ETOPS process validation. The operator should:
    - Document how each element of the ETOPS process was utilised during the validation.
    - Document any shortcomings with the process elements and measures in place to correct such shortcomings.
    - Document any changes to ETOPS processes which were required after an in-flight shut down (IFSD), unscheduled engine removals, or any other significant operational events.
  - Provide periodic Process Validation reports to the Authority. This may be addressed during Review Gates.



## AMC 20-8

### AMC 20-8 Occurrence Reporting

*ED Decision 2003/12/RM*

#### 1. INTENT

This AMC is interpretative material and provides guidance in order to determine which occurrences should be reported to the Agency, national authorities and to other organisations, and it provides guidance on the timescale for submission of such reports.

It also describes the objective of the overall occurrence reporting system including internal and external functions

#### 2. APPLICABILITY

- (a) This AMC only applies to occurrence reporting by persons/organisations regulated by Regulation (EC) No 1592/2002 of the European Parliament and of the Council. It does not address reporting by aerodrome organisations, air navigation service providers and authorities themselves.
- (b) In most cases the obligation to report is on the holders of a certificate or approval, which in most cases are organisations, but in some cases can be a single person. In addition some reporting requirements are directed to persons. However, in order not to complicate the text, only the term 'organisation' is used.
- (c) The AMC also does not apply to dangerous goods reporting. The definition of reportable dangerous goods occurrences is different from the other occurrences and the reporting system is also separate. This subject is covered in specific operating requirements and guidance and ICAO Documents namely:
  - (i) ICAO Annex 18, The safe Transport of Dangerous Goods by Air, Chapter 12
  - (ii) ICAO Doc 9284-AN/905, Technical Instructions for the Safe Transport of Dangerous Goods by Air

#### 3. OBJECTIVE OF OCCURRENCE REPORTING

- (a) The occurrence reporting system is an essential part of the overall monitoring function. The objective of the occurrence reporting, collection, investigation and analysis systems described in the operating rules, and the airworthiness rules is to use the reported information to contribute to the improvement of aviation safety, and not to attribute blame, impose fines or take other enforcement actions.
- (b) The detailed objectives of the occurrence reporting systems are:
  - (i) To enable an assessment of the safety implications of each occurrence to be made, including previous similar occurrences, so that any necessary action can be initiated. This includes determining what and why it had occurred and what might prevent a similar occurrence in the future.
  - (ii) To ensure that knowledge of occurrences is disseminated so that other persons and organisations may learn from them.
- (c) The occurrence reporting system is complementary to the normal day to day procedures and 'control' systems and is not intended to duplicate or supersede any of them. The

occurrence reporting system is a tool to identify those occasions where routine procedures have failed.

- (d) Occurrences should remain in the database when judged reportable by the person submitting the report as the significance of such reports may only become obvious at a later date.

#### **4. REPORTING TO THE AGENCY AND NATIONAL AUTHORITIES**

##### **(a) Requirements**

- (i) As detailed in the operating rules, occurrences defined as an incident, malfunction, defect, to prevent similar occurrences in the future. Known and planned preventive actions should be included within the report.
  - (ii) The products and part and appliances design rules prescribe that occurrences defined as a failure, malfunction, defect or other occurrence which has resulted in or may result in an unsafe condition must be reported to the Agency.
  - (iii) According to the product and part and appliances production rules occurrences defined as a deviation which could lead to an unsafe condition must be reported to the Agency and the national authority.
  - (iv) The maintenance rules stipulate that occurrences defined as any condition of the aircraft or aircraft component that has resulted or may result in an unsafe condition that could seriously hazard the aircraft must be reported to the national authority.
  - (v) Reporting does not remove the reporter's or organisation's responsibility to commence corrective actions to prevent similar occurrences in the future. Known and planned preventive actions should be included within the report.
- (b) Paragraph 10.g. of this AMC provides guidance as to what should be reported by an organisation to the authority. The list of criteria provided may be used as guidance for establishing which occurrences shall be reported by which organisation. For example, the organisation responsible for the design will not need to report certain operational occurrences that it has been made aware of, if the continuing airworthiness of the product is not involved.

#### **5. NOTIFICATION OF ACCIDENTS AND SERIOUS INCIDENTS**

In addition to the requirement to notify the appropriate accident investigating authorities directly of any accident or serious incident, operators should also report to the national authority in charge of supervising the reporting organisation

#### **6. REPORTING TIME**

- (a) The period of 72 hours is normally understood to start from when the occurrence took place or from the time when the reporter determined that there was, or could have been, a potentially hazardous or unsafe condition.
- (b) For many occurrences there is no evaluation needed; it must be reported. However, there will be occasions when, as part of a Flight Safety and Accident Prevention programme or Quality Programme, a previously non-reportable occurrence is determined to be reportable
- (c) Within the overall limit of 72 hours for the submission of a report, the degree of urgency should be determined by the level of hazard judged to have resulted from the occurrence:

- (i) Where an occurrence is judged to have resulted in an immediate and particularly significant hazard the Agency and/or national authority expects to be advised immediately, and by the fastest possible means (e.g. telephone, fax, telex, e-mail) of whatever details are available at that time. This initial notification should then be followed up by a report within 72 hours.
- (ii) Where the occurrence is judged to have resulted in a less immediate and less significant hazard, report submission may be delayed up to the maximum of 72 hours in order to provide more details or more reliable information.

## **7. CONTENT OF REPORTS**

- (a) Notwithstanding other required reporting means as promulgated in national requirements (e.g. AIRPROX reporting), reports may be transmitted in any form considered acceptable to the Agency and/or national authority. The amount of information in the report should be commensurate with the severity of the occurrence. Each report should at least contain the following elements, as applicable to each organisation:
  - (i) Organisation name
  - (ii) Approval reference (if relevant)
  - (iii) Information necessary to identify the aircraft or part affected.
  - (iv) Date and time if relevant
  - (v) A written summary of the occurrence
  - (vi) Any other specific information required
- (b) For any occurrence involving a system or component, which is monitored or protected by a warning and/or protection system (for example: fire detection/extinguishing) the occurrence report should always state whether such system(s) functioned properly.

## **8. NOTIFICATION TO OTHER AGENCIES**

For approved operations organisations, in addition to reporting occurrences to the national authority, the following agencies should also be notified in specific cases:

- (a) Reports relating to 'security incidents' should also be notified to the appropriate local security agency
- (b) Reports relating to air traffic, aerodrome occurrences or bird strikes should also be notified to the appropriate air navigation, aerodrome or ground agency
- (c) Requirements for reporting and assessment of safety occurrences in ATM within the ECAC Region are harmonised within EUROCONTROL document ESARR 2.

## **9. REPORTING BETWEEN ORGANISATIONS**

- (a) Requirements exist that address the reporting of data relating to unsafe or unairworthy conditions. These reporting lines are:
  - (i) Production Organisation to the organisation responsible for the design;
  - (ii) Maintenance organisation to the organisation responsible for the design;
  - (iii) Maintenance organisation to operator;
  - (iv) Operator to organisation responsible for the design;

- (v) Production organisation to production organisation.
- (b) The 'Organisation responsible for the design' is a general term, which can be any one or a combination of the following organisations
  - (i) Holder of Type Certificate (TC) of an Aircraft, Engine or Propeller;
  - (ii) Holder of a Supplemental Type Certificate (STC) on an Aircraft, Engine or Propeller;
  - (iii) Holder of a European Technical Standard Order (ETSO) Authorisation; or
  - (iv) Holder of a European Part Approval (EPA)
- (c) If it can be determined that the occurrence has an impact on or is related to an aircraft component which is covered by a separate design approval (TC, STC, ETSO or EPA), then the holders of such approval/authorisation should be informed. If an occurrence happens on a component which is covered by an TC, STC, ETSO or EPA (e.g. during maintenance), then only that TC, STC, ETSO Authorisation or EPA holder needs to be informed.
- (d) The form and timescale for reports to be exchanged between organisations is left for individual organisations to determine. What is important is that a relationship exists between the organisations to ensure that there is an exchange of information relating to occurrences.
- (e) Paragraph 10.g. of this AMC provides guidance as to what should be reported by an organisation to the authority. The list of criteria provided may be used as guidance for establishing which occurrences shall be reported to which organisation. For example, certain operational occurrences will not need to be reported by an operator to the design or production organisation.

## **10. REPORTABLE OCCURRENCES**

- (a) General. There are different reporting requirements for operators (and/or commanders), maintenance organisations, design organisations and production organisations. Moreover, as explained in paragraph 4. and 9. above, there are not only requirements for reporting to the Agency and national authority, but also for reporting to other (private) entities. The criteria for all these different reporting lines are not the same. For example the authority will not receive the same kind of reports from a design organisation as from an operator. This is a reflection of the different perspectives of the organisations based on their activities.

Figure 1 presents a simplified scheme of all reporting lines.

Figure 1

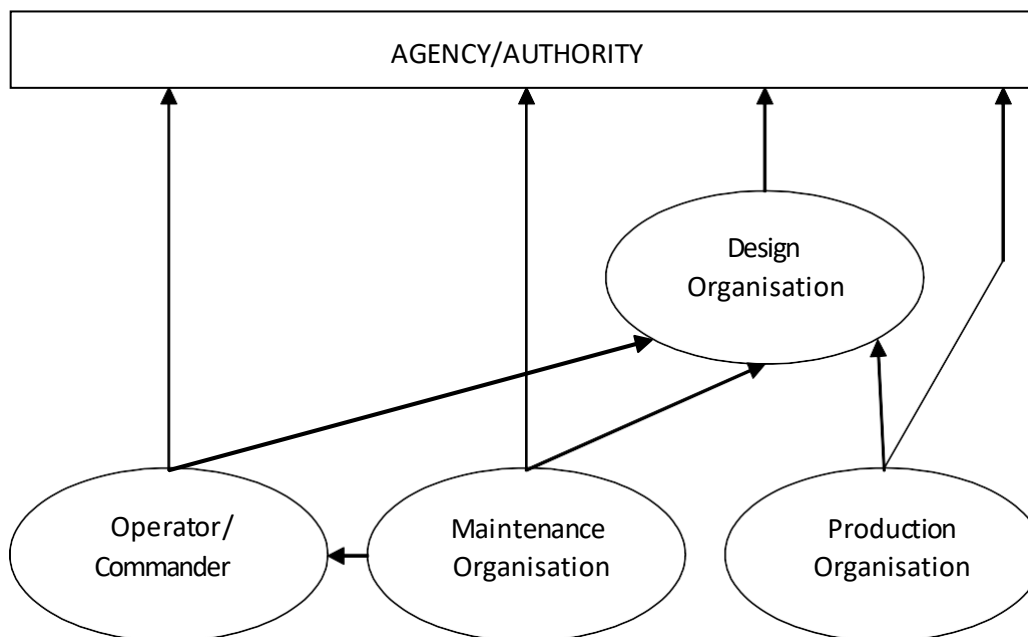

- (b) Operations and Maintenance. The list of examples of reportable occurrences offered below under g. is established from the perspective of primary sources of occurrence information in the operational area (operators and maintenance organisations) to provide guidance for those persons developing criteria for individual organisations on what they need to report to the Agency and/or national authority. The list is neither definitive nor exhaustive and judgement by the reporter of the degree of hazard or potential hazard involved is essential.
- (c) Design. The list of examples will not be used by design organisations directly for the purpose of determining when a report has to be made to the authority, but it can serve as guidance for the establishment of the system for collecting data. After receipt of reports from the primary sources of information, designers will normally perform some kind of analysis to determine whether an occurrence has resulted or may result in an unsafe condition and a report to the authority should be made. An analysis method for determining when an unsafe condition exists in relation to continuing airworthiness is detailed in the AMC's regarding the issuance of Airworthiness Directives.
- (d) Production. The list of examples is not applicable to the reporting obligation of production organisations. Their primary concern is to inform the design organisation of deviations. Only in cases where an analysis in conjunction with that design organisation shows that the deviation could lead to an unsafe condition, should a report be made to the Agency and/or national authority (see also c. above).
- (e) Customised list. Each approval, certificate, authorisation other than those mentioned in sub paragraph c and d above, should develop a customised list adapted to its aircraft, operation or product. The list of reportable occurrences applicable to an organisation is usually published within the organisation's expositions/handbooks/manuals
- (f) Internal reporting. The perception of safety is central to occurrence reporting. It is for each organisation to determine what is safe and what is unsafe and to develop its reporting system on that basis. The organisation should establish an internal reporting system whereby reports are centrally collected and reviewed to establish which reports

meet the criteria for occurrence reporting to the Agency and/or national authority and other organisations, as required.

(g) List of examples of reportable occurrences

The following is a generic list. Not all examples are applicable to each reporting organisation. Therefore each organisation should define and agree with the Agency and/or national authority a specific list of reportable occurrences or a list of more generic criteria, tailored to its activity and scope of work (see also 10.e above). In establishing that customised list, the organisation should take into account the following considerations:

Reportable occurrences are those where the safety of operation was or could have been endangered or which could have led to an unsafe condition. If in the view of the reporter an occurrence did not hazard the safety of the operation but if repeated in different but likely circumstances would create a hazard, then a report should be made. What is judged to be reportable on one class of product, part or appliance may not be so on another and the absence or presence of a single factor, human or technical, can transform an occurrence into a serious incident or accident.

Specific operational approvals, e.g. RVSM, ETOPS, RNAV, or a design or maintenance programme, may have specific reporting requirements for failures or malfunctions associated with that approval or programme.

A lot of the qualifying adjectives like 'significant' have been deleted from the list. In stead it is expected that all examples are qualified by the reporter using the general criteria that are applicable in his field, and specified in the requirement. (e.g. for operators: 'hazards or could have hazarded the operation')

CONTENTS:

I. AIRCRAFT FLIGHT OPERATIONS

II. AIRCRAFT TECHNICAL

III. AIRCRAFT MAINTENANCE AND REPAIR

IV. AIR NAVIGATION SERVICES, FACILITIES AND GROUND SERVICES

**I. AIRCRAFT FLIGHT OPERATIONS**

**A. Operation of the Aircraft**

- (1)
  - (a) Risk of collision with an aircraft, terrain or other object or an unsafe situation when avoidance action would have been appropriate.
  - (b) An avoidance manoeuvre required to avoid a collision with an aircraft, terrain or other object.
  - (c) An avoidance manoeuvre to avoid other unsafe situations.
- (2) Take-off or landing incidents, including precautionary or forced landings. Incidents such as under-shooting, overrunning or running off the side of runways. Take-offs, rejected take-offs, landings or attempted landings on a closed, occupied or incorrect runway. Runway incursions.

- (3) Inability to achieve predicted performance during take-off or initial climb.
- (4) Critically low fuel quantity or inability to transfer fuel or use total quantity of usable fuel.
- (5) Loss of control (including partial or temporary loss of control) from any cause.
- (6) Occurrences close to or above V1 resulting from or producing a hazardous or potentially hazardous situation (e.g. rejected take-off, tail strike, engine power loss etc.).
- (7) Go-around producing a hazardous or potentially hazardous situation.
- (8) Unintentional significant deviation from airspeed, intended track or altitude. (more than 91 m (300 ft)) from any cause.
- (9) Descent below decision height/altitude or minimum descent height/altitude without the required visual reference.
- (10) Loss of position awareness relative to actual position or to other aircraft.
- (11) Breakdown in communication between flight crew (CRM) or between Flight crew and other parties (cabin crew, ATC, engineering).
- (12) Heavy landing - a landing deemed to require a 'heavy landing check'.
- (13) Exceedance of fuel imbalance limits.
- (14) Incorrect setting of an SSR code or of an altimeter subscale.
- (15) Incorrect programming of, or erroneous entries into, equipment used for navigation or performance calculations, or use of incorrect data.
- (16) Incorrect receipt or interpretation of radiotelephony messages.
- (17) Fuel system malfunctions or defects, which had an effect on fuel supply and/or distribution.
- (18) Aircraft unintentionally departing a paved surface.
- (19) Collision between an aircraft and any other aircraft, vehicle or other ground object.
- (20) Inadvertent and/or incorrect operation of any controls.
- (21) Inability to achieve the intended aircraft configuration for any flight phase (e.g. landing gear and doors, flaps, stabilisers, slats etc).
- (22) A hazard or potential hazard which arises as a consequence of any deliberate simulation of failure conditions for training, system checks or training purposes.
- (23) Abnormal vibration.
- (24) Operation of any primary warning system associated with manoeuvring of the aircraft e.g. configuration warning, stall warning (stick shake), over speed warning etc. unless:

- (a) the crew conclusively established that the indication was false. Provided that the false warning did not result in difficulty or hazard arising from the crew response to the warning; or
  - (b) operated for training or test purposes.
- (25) GPWS/TAWS 'warning' when:
- (a) the aircraft comes into closer proximity to the ground than had been planned or anticipated; or
  - (b) the warning is experienced in IMC or at night and is established as having been triggered by a high rate of descent (Mode 1); or
  - (c) the warning results from failure to select landing gear or land flap by the appropriate point on the approach (Mode 4); or
  - (d) any difficulty or hazard arises or might have arisen as a result of crew response to the 'warning' e.g. possible reduced separation from other traffic. This could include warning of any Mode or Type i.e. genuine, nuisance or false.
- (26) GPWS/TAWS 'alert' when any difficulty or hazard arises or might have arisen as a result of crew response to the 'alert'.
- (27) ACAS RAs.
- (28) Jet or prop blast incidents resulting in significant damage or serious injury.

## **B. Emergencies**

- (1) Fire, explosion, smoke or toxic or noxious fumes, even though fires were extinguished.
- (2) The use of any non-standard procedure by the flight or cabin crew to deal with an emergency when:
  - (a) the procedure exists but is not used; or
  - (b) a procedure does not exist; or
  - (c) the procedure exists but is incomplete or inappropriate; or
  - (d) the procedure is incorrect; or
  - (e) the incorrect procedure is used.
- (3) Inadequacy of any procedures designed to be used in an emergency, including when being used for maintenance, training or test purposes.
- (4) An event leading to an emergency evacuation.
- (5) Depressurisation.
- (6) The use of any emergency equipment or prescribed emergency procedures in order to deal with a situation.
- (7) An event leading to the declaration of an emergency ('Mayday' or 'Pan').



- (8) Failure of any emergency system or equipment, including all exit doors and lighting, to perform satisfactorily, including when being used for maintenance, training or test purposes.
  - (9) Events requiring any emergency use of oxygen by any crew member.
- C. Crew Incapacitation**
- (1) Incapacitation of any member of the flight crew, including that which occurs prior to departure if it is considered that it could have resulted in incapacitation after take-off.
  - (2) Incapacitation of any member of the cabin crew which renders them unable to perform essential emergency duties.
- D. Injury**
- (1) Occurrences, which have or could have led to significant injury to passengers or crew but which are not considered reportable as an accident.
- E. Meteorology**
- (1) A lightning strike which resulted in damage to the aircraft or loss or malfunction of any essential service.
  - (2) A hail strike which resulted in damage to the aircraft or loss or malfunction of any essential service.
  - (3) Severe turbulence encounter – an encounter resulting in injury to occupants or deemed to require a ‘turbulence check’ of the aircraft.
  - (4) A windshear encounter.
  - (5) Icing encounter resulting in handling difficulties, damage to the aircraft or loss or malfunction of any essential service.
- F. Security**
- (1) Unlawful interference with the aircraft including a bomb threat or hijack.
  - (2) Difficulty in controlling intoxicated, violent or unruly passengers.
  - (3) Discovery of a stowaway.
- G. Other Occurrences**
- (1) Repetitive instances of a specific type of occurrence which in isolation would not be considered 'reportable' but which due to the frequency at which they arise, form a potential hazard.
  - (2) A bird strike which resulted in damage to the aircraft or loss or malfunction of any essential service.
  - (3) Wake turbulence encounters.
  - (4) Any other occurrence of any type considered to have endangered or which might have endangered the aircraft or its occupants on board the aircraft or on the ground.

## **II. AIRCRAFT TECHNICAL**

### **A. Structural**

Not all structural failures need to be reported. Engineering judgement is required to decide whether a failure is serious enough to be reported. The following examples can be taken into consideration:

- (1) Damage to a Principal Structural Element that has not been qualified as damage tolerant (life limited element). Principal Structural Elements are those which contribute significantly to carrying flight, ground, and pressurisation loads, and whose failure could result in a catastrophic failure of the aircraft. Typical examples of such elements are listed for large aeroplanes in AC/AMC 25.571(a) "damage tolerance and fatigue evaluation of structure", and in the equivalent AMC material for rotorcraft.
- (2) Defect or damage exceeding admissible damages to a Principal Structural Element that has been qualified as damage tolerant.
- (3) Damage to or defect exceeding allowed tolerances of a structural element which failure could reduce the structural stiffness to such an extent that the required flutter, divergence or control reversal margins are no longer achieved.
- (4) Damage to or defect of a structural element, which could result in the liberation of items of mass that may injure occupants of the aircraft.
- (5) Damage to or defect of a structural element, which could jeopardise proper operation of systems. See paragraph II.B. below.
- (6) Loss of any part of the aircraft structure in flight.

### **B. Systems**

The following generic criteria applicable to all systems are proposed:

- (1) Loss, significant malfunction or defect of any system, subsystem or set of equipment when standard operating procedures, drills etc. could not be satisfactorily accomplished.
- (2) Inability of the crew to control the system, e.g.:
  - (a) uncommanded actions;
  - (b) incorrect and or incomplete response, including limitation of movement or stiffness;
  - (c) runaway;
  - (d) mechanical disconnection or failure.
- (3) Failure or malfunction of the exclusive function(s) of the system (one system could integrate several functions).
- (4) Interference within or between systems.
- (5) Failure or malfunction of the protection device or emergency system associated with the system.
- (6) Loss of redundancy of the system.

- (7) Any occurrence resulting from unforeseen behaviour of a system.
- (8) For aircraft types with single main systems, subsystems or sets of equipment: Loss, significant malfunction or defect in any main system, subsystem or set of equipment.
- (9) For aircraft types with multiple independent main systems, subsystems or sets of equipment: The loss, significant malfunction or defect of more than one main system, subsystem or set of equipment
- (10) Operation of any primary warning system associated with aircraft systems or equipment unless the crew conclusively established that the indication was false provided that the false warning did not result in difficulty or hazard arising from the crew response to the warning.
- (11) Leakage of hydraulic fluids, fuel, oil or other fluids which resulted in a fire hazard or possible hazardous contamination of aircraft structure, systems or equipment, or risk to occupants.
- (12) Malfunction or defect of any indication system when this results in the possibility of misleading indications to the crew.
- (13) Any failure, malfunction or defect if it occurs at a critical phase of flight and relevant to the operation of that system.
- (14) Occurrences of significant shortfall of the actual performances compared to the approved performance which resulted in a hazardous situation (taking into account the accuracy of the performance calculation method) including braking action, fuel consumption etc.
- (15) Asymmetry of flight controls; e.g. flaps, slats, spoilers etc.

Annex 1 to this AMC gives a list of examples of reportable occurrences resulting from the application of these generic criteria to specific systems

### **C. Propulsion (including Engines, Propellers and Rotor Systems) and APUs**

- (1) Flameout, shutdown or malfunction of any engine.
- (2) Overspeed or inability to control the speed of any high speed rotating component (for example: Auxiliary power unit, air starter, air cycle machine, air turbine motor, propeller or rotor).
- (3) Failure or malfunction of any part of an engine or powerplant resulting in any one or more of the following:
  - (a) non containment of components/debris;
  - (b) uncontrolled internal or external fire, or hot gas breakout;
  - (c) thrust in a different direction from that demanded by the pilot;
  - (d) thrust reversing system failing to operate or operating inadvertently;
  - (e) inability to control power, thrust or rpm;
  - (f) failure of the engine mount structure;
  - (g) partial or complete loss of a major part of the powerplant;

- (h) Dense visible fumes or concentrations of toxic products sufficient to incapacitate crew or passengers;
  - (i) inability, by use of normal procedures, to shutdown an engine;
  - (j) inability to restart a serviceable engine.
- (4) An uncommanded thrust/power loss, change or oscillation which is classified as a loss of thrust or power control (LOT) as defined in AMC 20-1:
- (a) for a single engine aircraft; or
  - (b) where it is considered excessive for the application, or
  - (c) where this could affect more than one engine in a multi-engine aircraft, particularly in the case of a twin engine aircraft; or
  - (d) for a multi engine aircraft where the same, or similar, engine type is used in an application where the event would be considered hazardous or critical.
- (5) Any defect in a life controlled part causing retirement before completion of its full life.
- (6) Defects of common origin which could cause an in flight shut down rate so high that there is the possibility of more than one engine being shut down on the same flight.
- (7) An engine limiter or control device failing to operate when required or operating inadvertently.
- (8) exceedance of engine parameters.
- (9) FOD resulting in damage.

#### Propellers and -transmission

- (10) Failure or malfunction of any part of a propeller or powerplant resulting in any one or more of the following:
- (a) an overspeed of the propeller;
  - (b) the development of excessive drag;
  - (c) a thrust in the opposite direction to that commanded by the pilot;
  - (d) a release of the propeller or any major portion of the propeller;
  - (e) a failure that results in excessive unbalance;
  - (f) the unintended movement of the propeller blades below the established minimum in-flight low-pitch position;
  - (g) an inability to feather the propeller;
  - (h) an inability to command a change in propeller pitch;
  - (i) an uncommanded change in pitch;
  - (j) an uncontrollable torque or speed fluctuation;
  - (k) The release of low energy parts.

Rotors and -transmission

- (11) Damage or defect of main rotor gearbox / attachment which could lead to in flight separation of the rotor assembly, and /or malfunctions of the rotor control.
- (12) Damage to tail rotor, transmission and equivalent systems.

APUs

- (13) Shut down or failure when the APU is required to be available by operational requirements, e.g. ETOPS, MEL.
- (14) Inability to shut down the APU.
- (15) Overspeed.
- (16) Inability to start the APU when needed for operational reasons.

**D. Human Factors**

- (1) Any incident where any feature or inadequacy of the aircraft design could have led to an error of use that could contribute to a hazardous or catastrophic effect.

**E. Other Occurrences**

- (1) Any incident where any feature or inadequacy of the aircraft design could have led to an error of use that could contribute to a hazardous or catastrophic effect.
- (2) An occurrence not normally considered as reportable (for example, furnishing and cabin equipment, water systems), where the circumstances resulted in endangering of the aircraft or its occupants.
- (3) A fire, explosion, smoke or toxic or noxious fumes.
- (4) Any other event which could hazard the aircraft, or affect the safety of the occupants of the aircraft, or people or property in the vicinity of the aircraft or on the ground.
- (5) Failure or defect of passenger address system resulting in loss or inaudible passenger address system.
- (6) Loss of pilots seat control during flight.

**III. AIRCRAFT MAINTENANCE AND REPAIR**

- A. Incorrect assembly of parts or components of the aircraft found during an inspection or test procedure not intended for that specific purpose.
- B. Hot bleed air leak resulting in structural damage.
- C. Any defect in a life controlled part causing retirement before completion of its full life.
- D. Any damage or deterioration (i.e. fractures, cracks, corrosion, delamination, disbonding etc) resulting from any cause (such as flutter, loss of stiffness or structural failure) to:
  - (1) primary structure or a principal structural element (as defined in the manufacturers' Repair Manual) where such damage or deterioration

- exceeds allowable limits specified in the Repair Manual and requires a repair or complete or partial replacement of the element;
- (2) secondary structure which consequently has or may have endangered the aircraft;
  - (3) the engine, propeller or rotorcraft rotor system.
- E. Any failure, malfunction or defect of any system or equipment, or damage or deterioration found as a result of compliance with an Airworthiness Directive or other mandatory instruction issued by a Regulatory Authority, when:
- (1) it is detected for the first time by the reporting organisation implementing compliance;
  - (2) on any subsequent compliance where it exceeds the permissible limits quoted in the instruction and/or published repair/rectification procedures are not available.
- F. Failure of any emergency system or equipment, including all exit doors and lighting, to perform satisfactorily, including when being used for maintenance or test purposes.
- G. Non compliance or significant errors in compliance with required maintenance procedures.
- H. Products, parts, appliances and materials of unknown or suspect origin.
- I. Misleading, incorrect or insufficient maintenance data or procedures that could lead to maintenance errors.
- J. Failure, malfunction or defect of ground equipment used for test or checking of aircraft systems and equipment when the required routine inspection and test procedures did not clearly identify the problem when this results in a hazardous situation.

#### **IV. AIR NAVIGATION SERVICES, FACILITIES AND GROUND SERVICES**

##### **A. Air Navigation Services**

- (1) Provision of significantly incorrect, inadequate or misleading information from any ground sources, e.g. Air Traffic Control (ATC), Automatic Terminal Information Service (ATIS), Meteorological Services, navigation databases, maps, charts, manuals, etc.
- (2) Provision of less than prescribed terrain clearance.
- (3) Provision of incorrect pressure reference data (i.e. altimeter setting).
- (4) Incorrect transmission, receipt or interpretation of significant messages when this results in a hazardous situation.
- (5) Separation minima infringement.
- (6) Unauthorised penetration of airspace.
- (7) Unlawful radio communication transmission.
- (8) Failure of ANS ground or satellite facilities.

- 
- (9) Major ATC/ Air Traffic Management (ATM) failure or significant deterioration of aerodrome infrastructure.
  - (10) Aerodrome movement areas obstructed by aircraft, vehicles, animals or foreign objects, resulting in a hazardous or potentially hazardous situation.
  - (11) Errors or inadequacies in marking of obstructions or hazards on aerodrome movement areas resulting in a hazardous situation.
  - (12) Failure, significant malfunction or unavailability of airfield lighting.
- B. Aerodrome and Aerodrome Facilities**
- (1) Significant spillage during fuelling operations.
  - (2) Loading of incorrect fuel quantities likely to have a significant effect on aircraft endurance, performance, balance or structural strength.
  - (3) unsatisfactory ground de-icing / anti-icing
- C. Passenger Handling, Baggage and Cargo**
- (1) Significant contamination of aircraft structure, or systems and equipment arising from the carriage of baggage or cargo.
  - (2) Incorrect loading of passengers, baggage or cargo, likely to have a significant effect on aircraft mass and/or balance.
  - (3) Incorrect stowage of baggage or cargo (including hand baggage) likely in any way to hazard the aircraft, its equipment or occupants or to impede emergency evacuation.
  - (4) Inadequate stowage of cargo containers or other substantial items of cargo.
  - (5) Dangerous goods incidents reporting: see operating rules.
- D. Aircraft Ground Handling and Servicing**
- (1) Failure, malfunction or defect of ground equipment used for test or checking of aircraft systems and equipment when the required routine inspection and test procedures did not clearly identify the problem when this results in a hazardous situation.
  - (2) Non compliance or significant errors in compliance with required servicing procedures.
  - (3) Loading of contaminated or incorrect type of fuel or other essential fluids (including oxygen and potable water).

## Annex 1 to AMC 20-8 – Reportable occurrences to specific systems

*ED Decision 2003/12/RM*

The following subparagraphs give examples of reportable occurrences resulting from the application of the generic criteria to specific systems listed in paragraph 10.g. II.B of this AMC.

1. Air conditioning/ventilation
  - (a) complete loss of avionics cooling
  - (b) depressurisation
2. Autoflight system
  - (a) failure of the autoflight system to achieve the intended operation while engaged
  - (b) significant reported crew difficulty to control the aircraft linked to autoflight system functioning
  - (c) failure of any autoflight system disconnect device
  - (d) Uncommanded autoflight mode change
3. Communications
  - (a) failure or defect of passenger address system resulting in loss or inaudible passenger address
  - (b) total loss of communication in flight
4. Electrical system
  - (a) loss of one electrical system distribution system (AC or DC)
  - (b) total loss or loss or more than one electrical generation system
  - (c) failure of the back up (emergency) electrical generating system
5. Cockpit/Cabin/Cargo
  - (a) pilot seat control loss during flight
  - (b) failure of any emergency system or equipment, including emergency evacuation signalling system, all exit doors, emergency lighting, etc
  - (c) loss of retention capability of the cargo loading system
6. Fire protection system
  - (a) fire warnings, except those immediately confirmed as false
  - (b) undetected failure or defect of fire/smoke detection/protection system, which could lead to loss or reduced fire detection/protection
  - (c) absence of warning in case of actual fire or smoke
7. Flight controls
  - (a) Asymmetry of flaps, slats, spoilers etc.
  - (b) limitation of movement, stiffness or poor or delayed response in the operation of primary flight control systems or their associated tab and lock systems
  - (c) flight control surface run away
  - (d) flight control surface vibration felt by the crew



- (e) mechanical flight control disconnection or failure
  - (f) significant interference with normal control of the aircraft or degradation of flying qualities
8. Fuel system
- (a) fuel quantity indicating system malfunction resulting in total loss or erroneous indicated fuel quantity on board
  - (b) leakage of fuel which resulted in major loss, fire hazard , significant contamination
  - (c) malfunction or defects of the fuel jettisoning system which resulted in inadvertent loss of significant quantity, fire hazard, hazardous contamination of aircraft equipment or inability to jettison fuel
  - (d) fuel system malfunctions or defects which had a significant effect on fuel supply and/or distribution
  - (e) inability to transfer or use total quantity of usable fuel
9. Hydraulics
- (a) loss of one hydraulic system (ETOPS only)
  - (b) failure of the isolation system to operate
  - (c) loss of more than one hydraulic circuits
  - (d) failure of the back up hydraulic system
  - (e) inadvertent Ram Air Turbine extension
10. Ice detection/protection system
- (a) undetected loss or reduced performance of the anti-ice/de-ice system
  - (b) loss of more than one of the probe heating systems
  - (c) inability to obtain symmetrical wing de icing
  - (d) abnormal ice accumulation leading to significant effects on performance or handling qualities
  - (e) crew vision significantly affected
11. Indicating/warning/recording systems
- (a) malfunction or defect of any indicating system when the possibility of significant misleading indications to the crew could result in an inappropriate crew action on an essential system
  - (b) loss of a red warning function on a system
  - (c) for glass cockpits: loss or malfunction of more than one display unit or computer involved in the display/warning function
12. Landing gear system /brakes/tyres
- (a) brake fire
  - (b) significant loss of braking action
  - (c) unsymmetrical braking leading to significant path deviation
  - (d) failure of the L/G free fall extension system (including during scheduled tests)

- 
- (e) unwanted gear or gear doors extension/retraction
  - (f) multiple tyres burst
13. Navigation systems (including precision approaches system) and air data systems
- (a) total loss or multiple navigation equipment failures
  - (b) total failure or multiple air data system equipment failures
  - (c) significant misleading indication
  - (d) Significant navigation errors attributed to incorrect data or a database coding error
  - (e) Unexpected deviations in lateral or vertical path not caused by pilot input.
  - (f) Problems with ground navigational facilities leading to significant navigation errors not associated with transitions from inertial navigation mode to radio navigation mode.
14. Oxygen
- (a) for pressurised aircraft: loss of oxygen supply in the cockpit
  - (b) loss of oxygen supply to a significant number of passengers (more than 10%), including when found during maintenance or training or test purposes
15. Bleed air system
- (a) hot bleed air leak resulting in fire warning or structural damage
  - (b) loss of all bleed air systems
  - (c) failure of bleed air leak detection system

## AMC 20-9

### AMC 20-9 Acceptable Means of Compliance for the Approval of Departure Clearance via Data Communications over ACARS

*ED Decision 2006/012/R*

#### 1 PREAMBLE

- 1.1 This AMC is issued in response to the EUROCONTROL Convergence and Implementation Plan that recommends an interim deployment of air-to-ground and ground-to-air data link applications based on the existing airline ACARS technology. One such application is Departure Clearance (DCL) data link now operational at various airports in Europe (as indicated in AIPs). Aircraft operators, on a voluntary basis, may take advantage of DCL over ACARS where it is available, subject to any arrangements that may be required by their responsible operations authority.
- 1.2 The use of ACARS for data link purposes is a transitional step to data link applications that will use VDL Mode 2 and the Aeronautical Telecommunications Network (ATN), compliant with ICAO SARPS, as proposed in the EUROCONTROL LINK2000+ programme<sup>1</sup>.
- 1.3 Described in EUROCAE document ED-85A (hereafter "ED-85A"), Data Link Application System document (DLASD) for the "Departure Clearance" Data Link Service, DCL over ACARS is a control tower application providing direct communication between the flight crew and the air traffic controller. ED-85A addresses three domains: airborne, ground ATC, and communication service providers. It deals also with associated flight crew and controller procedures. ED-85A takes account of EUROCAE document ED-78 which describes the global processes including approval planning, co-ordinated requirements determination, development and qualification of a system element, entry into service, and operations.

#### 2 PURPOSE

- 2.1 This AMC is intended for operators seeking to use Departure Clearance via data link over ACARS as described in ED-85A. It may assist also other stakeholders such as airspace planners, air traffic service providers, ATS system manufacturers, communication service providers, aircraft and equipment manufacturers, and ATS regulatory authorities to advise them of the airborne requirements and procedures, and the related assumptions.
- 2.2 This AMC provides a method for evaluating compliance of a data link system to the requirements of ED-85A, and the means by which an aircraft operator can satisfy an authority that operational considerations have been addressed.

#### 3 SCOPE

- 3.1 This AMC addresses DCL over ACARS using the ARINC 623 protocol as elaborated in EUROCAE document ED-85A and promoted by the EUROCONTROL Convergence and Implementation Plan as an interim data link application pending maturity of the LINK2000+ programme. The AMC is not directly applicable to Pre-Departure Clearance (PDC) as used in the USA and some other states. For PDC approval, guidance may be found in FAA document Safety and Interoperability Requirements for Pre-Departure

<sup>1</sup> Information on LINK2000+ is available at web site [www.eurocontrol.int/link2000](http://www.eurocontrol.int/link2000)

Clearance, issued by AIR-100 on April 21, 1998. A comparison of PDC with DCL may be found in Appendix 1.

- 3.2 This AMC is not applicable to the phased implementation of data link services within the EUROCONTROL LINK2000+ programme, in particular, DCL over the Aeronautical Telecommunications Network via VHF Digital Data Link (VDL) Mode 2. In this case, the Safety and Performance Requirements (EUROCAE ED-120) and the Interoperability Requirements (EUROCAE ED-110) are established using EUROCAE document ED-78A, Guidelines for Approval of the Provision and use of Air Traffic Services supported by Data Communications. Guidance for the implementation of DCL over ATN may be found in EASA document AMC 20-11.
- 3.3 The operational requirements for the DCL application are published in the EUROCONTROL document OPR/ET1/ST05/1000, Edition 2, October 15, 1996, Transition guidelines for initial air ground data communication services. The EUROCONTROL document includes the re-issued clearance capability, however document ED-85A does not address this capability and it is not included in the scope of this AMC.
- 3.4 For the remainder of this document, the acronym DCL should be interpreted to mean DCL over ACARS using the ARINC 623 protocol unless stated otherwise.

#### 4 REFERENCE DOCUMENTS

##### 4.1 Related Requirements

CS/FAR 25.1301, 25.1307, 25.1309, 25.1322, 25.1431, 25.1581, or equivalent requirements of CS 23, 27 and 29 if applicable.

##### 4.2 Related Standards and Guidance Material

ICAO	Doc 9694 AN/955	Manual of Air Traffic Services (ATS) Data Link Applications
	Doc 4444	Rules of the Air and Air Traffic Services
	Draft Proposal	PANS-Air Traffic Management
	Annex 11	Air Traffic Services
	Doc 8585	Designators for Aircraft Operating agencies, Aeronautical Authorities and Services
	Doc 8643	Aircraft Type Designators
EASA	AMC 25-11	Electronic Display Systems
EUROCONTROL	CIP: COM. ET2.SO4; 2.1.5	Implement Air/Ground Communication Services- Interim step on non-ATN (ACARS) services.
	OPR/ET1/ST05/1000	Transition guidelines for initial air ground data communication services
	ESARR 4	Risk assessment and mitigation in ATM
FAA	AC 25-11	Electronic Display Systems.
	AC 120-COM	Initial Air Carrier Operational Approval for use of Digital Communication Systems
	AC 20-140	Guidelines for design approval of aircraft data communications systems
	98-Air-PDC	Safety and Interoperability requirement for Pre-Departure-Clearance (PDC). (Air-100, April 21,1998)
EUROCAE	ED 78	Guidance material for the establishment of data link supported ATS Services

	ED-85A	Data Link Application System document (DLASD) for the “ departure Clearance ” data link service
	ED-112	Minimum operational performance specification for Crash protected airborne recorder systems
RTCA	DO 224	Minimum Aviation System Performance Standards (MASPS) for Advanced VHF Digital Data Communications Including Compatibility with Digital Voice Techniques.
SAE	ARP 4791	Human Machine Interface on the flight deck

## 5 ASSUMPTIONS

Applicants should note that this AMC is based on the assumptions stated in Chapter 3 of ED-85A together with the following that concern the measures taken by the responsible airspace authorities to safeguard DCL operations.

### 5.1 ATS Provider

5.1.1 The data link service for DCL has been shown to satisfy applicable airspace safety regulations and the relevant ATS domain performance, safety and interoperability requirements of ED-85A.

5.1.2 Procedures for the use of DCL take account of the performance limitations of ACARS and the airborne implementation capabilities meeting at least the provisions of this AMC.

Note: Some aircraft ACARS installations approved to earlier standards are classified as “Non Essential” without guarantees of performance or integrity. Consequently, procedures are necessary to compensate for any deficiency and to safeguard operations. ED-85A addresses this issue.

5.1.3 Appropriate procedures are established to minimise the possibility of failure to detect inconsistency in the case of a complex clearance.

5.1.4 Each ATS provider has published a list of communication service providers that may be used by aircraft operators for the DCL application. The list should take account of internetworking arrangements between service providers.

5.1.5 The procedures of the ATS provider state the actions that should be taken in the event of an inadequate communication service from the communications service provider (CSP).

### 5.2 Communications Service Provider

The communications service provider does not modify the operational information (content and format) exchanged between the ATS provider and the airborne equipment.

### 5.3 Aeronautical Information Service

Each State offering a DCL service by data link publishes in its AIP, or equivalent notification, availability of the service, relevant procedures, and confirmation of compliance with ED-85A.

### 5.4 Message Integrity

The Cyclic Redundancy Check (CRC) is implemented as required by ED-85A and is providing integrity of the end-to-end data link transmission path. On this basis, Performance Technical Requirement PTR\_3 of ED-85A need not be demonstrated.

## **6 AIRWORTHINESS CONSIDERATIONS**

### **6.1 General**

- 6.1.1 The installation will need to be shown compliant with the airborne domain requirements allocated as per ED-85A (§7.1) covering the Interoperability Operational Requirements, the Interoperability Technical Requirements, the Performance Technical Requirements, the Safety Operational & Technical Requirements.
- 6.1.2 If multiple ATS data link applications are available to the aircraft, the crew interface and related crew procedures will need to be based on a common and compatible philosophy.

### **6.2 Required Functions**

An acceptable minimum airborne installation comprises the following functions:

- (a) A means of data communication appropriate to the area of operation, e.g. plain old ACARS over AVLC (Aviation VHF Link Control) through VHF or SATCOM;  
Note: VDL Mode 2 equipment can be used provided that radio transceiver is compliant with ED-92A.
- (b) A means to manage data communications and to control the data communications system;
- (c) A means to easily check and modify the parameters of the DCL request;
- (d) “Visual” alerting of an incoming message, visible to both pilots;
- (e) Means to display the text message, e.g. a single display readable by both crewmembers or a dedicated display for each pilot.
- (f) A means to accept the DCL delivered by the ATS.

### **6.3 Recommended Functions**

- (a) “Audible” alerting of an incoming message;
- (b) A means to print the messages;
- (c) Recording of DCL messages and flight crew responses on an accident flight recorder.

Note: Data Link recording may be required in accordance with OPS rules.

## **7 ACCEPTABLE MEANS OF AIRWORTHINESS COMPLIANCE**

### **7.1 Airworthiness**

- 7.1.1 When demonstrating compliance with this AMC, the following specific points should be noted:
- (a) Compliance with the airworthiness requirements for intended function and safety may be demonstrated by equipment qualification, safety analysis of the interface between the communications management system and data sources, structural analyses of new antenna installations, equipment cooling verification, and evidence of a suitable human to machine interface. The DCL function will need to be demonstrated by end-to-end ground testing that verifies system operation, either with an appropriate ATS unit, or by means

of test equipment that has been shown to be representative of the actual ATS unit.

Note: This limited testing assumes that the communication systems (VHF or SATCOM) have been shown to satisfactorily perform their intended functions in the flight environment in accordance with applicable requirements.

- (b) The safety analysis of the interface between the communications management system and its data sources should show that, under normal or fault conditions, no unwanted interaction which adversely affects essential systems can occur.

7.1.2 To minimise the certification effort for follow-on installations credit may be granted for applicable certification and test data obtained from equivalent aircraft installations.

## **7.2 Performance**

The installation should be shown to meet the airborne domain performance requirements allocated by ED-85A (§7.1). Demonstration of Performance Technical Requirement PTR\_A1 may be difficult for some airborne installations. The applicant may choose an alternative acceptable means of compliance for PTR\_A1 consisting in an end-to-end demonstration of PTR\_5 & PTR-6 of ED-85A (§5.2) with an appropriate ATS unit and communication service provider.

## **7.3 Aircraft Flight Manual**

The Flight Manual should state the following limitation.

Note: This limited entry assumes that a detailed description of the installed system and related operating instructions are available in other operating or training manuals and that operating procedures take account of ED-85A.

Limitation: The Departure Clearance (DCL) over ACARS application has been demonstrated with data link services declared compliant with EUROCAE document ED-85A.

## **7.4 Existing installations**

The applicant will need to submit a compliance statement that shows how the criteria of this AMC have been satisfied for existing installations. Compliance may be established by inspection of the installed system to confirm the availability of required features and functionality.

Note: It is not intended that aircraft which have received airworthiness approval in compliance with ED-85 requirement should be reinvestigated where the installation is compliant with Section 6, 7 and 8 of this AMC.

# **8 OPERATIONAL CONSIDERATIONS**

## **8.1 Flight Plan Information**

8.1.1 The Aircraft Identification transmitted by data link will need to conform to the ICAO format and correspond with the flight identity as entered in the applicable flight plan.

8.1.2 Aircraft type designator includes both Aircraft Type and Sub-type and shall be coded in accordance with the format described in ICAO document 8643 at its latest

edition. However, certain ACARS equipment can be pre-programmed only with Aircraft Type with the possibility of manual insertion of Sub-type via the system control panel. Absence of the Sub-type information may lead either to a rejected departure clearance request at some airports, or the issue of an inappropriate clearance where the aircraft performance capability is not taken into account. Where, to obtain the DCL service, Sub-type needs to be entered manually, the entry should be verified.

## 8.2 Operational Safety Aspects

8.2.1 Failure Conditions are presented in ED-85A (§6) together with the resulting safety requirements and operational means of mitigation. Failure Condition FC3 (undetected erroneous SID) is discussed further in the following paragraphs.

8.2.2 When a SID construct is simple and unambiguous (e.g. only one SID for one runway magnetic orientation (QFU) and one destination) so allowing the flight crew and the ATS controller to independently detect any inconsistency in the DCL, then additional means of mitigation are not required.

8.2.3 For other, more complex cases where the SID construction prevents the flight crew and the controller from readily detecting any inconsistency, a specific flight crew to controller procedure will need to be implemented to verify the clearance. This may be stated in the AIP or other notification issued by the State where aircraft will operate and use DCL service.

Note (1): In some countries (e.g. United Kingdom, AIC 125/1999, France AIC A19/00), following the investigation of level violations, voice confirmation of cleared altitude or flight level and SID identification is already required even for voice delivered departure clearance on the first contact with the approach control/departure radar. In such cases, no additional confirmation procedure is required.

Note (2): The ATS may agree that voice confirmation is not required where the data link function is certificated with an integrity level corresponding to the Essential category of CS25.1309.

8.2.4 In all cases, flight crews will need to comply with any mitigating procedures published by the States where aircraft will operate and use DCL service.

8.2.5 The assumptions of Section 5 need to be satisfied as a condition for operational use.

## 8.3 Operations Manual and Training

8.3.1 The Operations Manual shall reflect the Flight Manual statement of paragraph 7.3 and define operating procedures for use of the DCL.

8.3.2 Flight crew training should address:

- (a) The different data link services available using the same airborne equipment (e.g. differences between DCL and PDC applications as described in Annex 1);
- (b) ATS procedures for DCL; and
- (c) The required format for the flight identification input.



8.3.3 Subject to any arrangements that may be required by the responsible operations authority in respect of amendments to the Operations Manual, and the approval of training programmes, the aircraft operator may implement operations using DCL over ACARS.

#### **8.4 Incident reporting**

Significant incidents associated with a departure clearance transmitted by data link that affects or could affect the safe operation of the aircraft will need to be reported in accordance with applicable operational rules, and to the authority responsible for the airport where the DCL service was provided.

#### **AVAILABILITY OF DOCUMENTS**

EUROCAE documents may be purchased from EUROCAE, 17 rue Hamelin, 75783 Paris Cedex 16, France, (Fax: 33 1 45 05 72 30). Web site: [www.eurocae.org](http://www.eurocae.org).

JAA documents are available from the JAA publisher Information Handling Services (IHS). Information on prices, where and how to order is available on both the JAA web site [www.jaa.nl](http://www.jaa.nl) and the IHS web site [www.avdataworks.com](http://www.avdataworks.com).

EUROCONTROL documents may be requested from EUROCONTROL, Documentation Centre, GS4, Rue de la Fusee, 96, B-1130 Brussels, Belgium; (Fax: 32 2 729 9109 or web site [www.eurocontrol.int](http://www.eurocontrol.int)).

ICAO documents may be purchased from Document Sales Unit, International Civil Aviation Organisation, 999 University Street, Montreal, Quebec, Canada H3C 5H7, (Fax: 1 514 954 6769, e-mail: [sales\\_unit@icao.org](mailto:sales_unit@icao.org)) or through national agencies.

FAA documents may be obtained from Department of Transportation, Subsequent Distribution Office SVC-121.23, Ardmore East Business Centre, 3341 Q 75th Avenue, Landover, MD 20785, USA. Web site [www.faa.gov](http://www.faa.gov)

RTCA documents may be obtained from RTCA Inc, 1828 L Street, NW., Suite 805, Washington, DC 20036, USA., (Tel: 1 202 833 9339; Fax 1 202 833 9434). Web site: [www.rtca.org](http://www.rtca.org).

SAE documents may be obtained from SAE World Headquarters, 400 Commonwealth Drive, Warrendale, PA 15096-0001, USA. Telephone 1-877-606-7323 (U.S. and Canada only) or 724/776-4970 (elsewhere). Web site [www.sae.org](http://www.sae.org).

[Amdt 20/1]

## Appendix 1 to AMC 20-9 PDC versus DCL: A Comparison

ED Decision 2006/012/R

### The US Pre-Departure Clearance.

In the United States, the concept of Pre-departure Clearance is used where PDC messages are delivered via the airlines own ACARS network and operational host computer. The airline host, or the flight crew, initiates the process for the generation of the PDC by submitting the flight plan information to the air traffic service, which in turn forwards the flight strip information to the appropriate airport control tower. Approximately 30 minutes before the aircraft is scheduled to depart, the approved PDC is transmitted from the tower via ground-ground data link to the airline host computer. The airline host responds with an acknowledgement that ultimately feeds back to the tower PDC workstation. Depending upon the airline capabilities, the PDC may then be transmitted directly to the aircraft flight deck via the ACARS data link. If the aircraft is not equipped with ACARS, the approved PDC is sent to an airport gate printer for delivery by hand in printed format to the aircraft. For a clearance requested from the aircraft, the flight crew will initiate a PDC request via the ACARS data link network to the airline host computer. The host will then respond via the ACARS network with the approved PDC.

Thus, the airline is responsible for ensuring that the clearance is delivered to the flight crew. Without PDC, Instrument Flight Rule (IFR) clearances for departing aircraft are provided by the clearance-delivery controller via a tower voice channel.

The PDC is pre-formatted in an ARINC 620 free text message. The ARINC 623 standard also may be used but it is not required. All failures are classified Minor by the fact that flight crew has to follow a procedure to verify the information with the initial flight plan and, by voice communication, with departure control.

Guidance on the use of PDC may be found in FAA document *Safety and Interoperability Requirements for Pre-Departure Clearance*, issued by AIR-100 on April 21, 1998.

### The European Departure Clearance.

In Europe, departure clearance over ACARS is a direct ATC to pilot data link communication based on the EUROCAE ED-85A and ARINC 623 standards. The clearance delivered by data link is fully considered as an ATC departure clearance and it is not the responsibility of the airline to ensure delivery via its own facilities. ARINC 623 provides enhanced integrity of end-to-end communication, compared to ARINC 620 as used in the USA. However, flight crew verification procedures may still be required due to departure clearance options such as alternative SIDs, or to satisfy AIP requirements for local safety reasons.

Current operational implementation in Europe does not include a re-issued clearance capability, which is under study by some ATS providers.

[Amdt 20/1]

## Appendix 2 to AMC 20-9 Common Terms

*ED Decision 2006/012/R*

Reference should be made to EUROCAE document ED-85A for definition of terms.

### Abbreviations

ACARS	Aircraft Communication, Addressing and Reporting System
AIP	Aeronautical Information Publication
ARINC	Aeronautical Radio Inc.
ATS	Air Traffic Services
CPDLC	Controller-Pilot Data Link Communication
DCL	Departure Clearance
ESARR	EUROCONTROL Safety Regulatory Requirement
EUROCAE	European Organisation for Civil Aircraft Equipment
PDC	Pre-departure Clearance (as used in USA)
PTR	Performance Technical Requirement
RTCA	RTCA Inc.
SAE	Society of Automotive Engineers
SARPS	ICAO Standards and Recommended Practices
SID	Standard Instrument Departure
VDL	VHF Digital Link

[Amdt 20/1]

## AMC 20-10

### AMC 20-10 Acceptable Means of Compliance for the Approval of Digital ATIS via Data Link over ACARS

ED Decision 2006/012/R

#### 1 PREAMBLE

- 1.1 This AMC is issued in response to the EUROCONTROL Convergence and Implementation Plan that recommends an interim deployment of air-to-ground and ground-to-air data link applications based on the existing airline ACARS technology. One such application is Digital Automated Terminal Information Services (D-ATIS) now planned to be operational at various airports in Europe. Aircraft operators, on a voluntary basis, may take advantage of D-ATIS where it is available, provided the service is verified in accordance with operational procedures acceptable to the responsible operations authority.
- 1.2 The use of ACARS for data link purposes is a transitional step to data link applications that will use VHF Digital Link (VDL) Mode 2 and the Aeronautical Telecommunications Network (ATN), compliant with ICAO SARPS, as proposed in the EUROCONTROL LINK2000+ programme<sup>1</sup>.
- 1.3 Described in EUROCAE document ED-89A, *Data Link Application System document (DLASD) for the "ATIS" Data Link Service*, D-ATIS is a control tower application providing direct communication of ATIS information to the flight crew and, optionally automatic updating of this information. The ED-89A document addresses three domains: airborne, ground ATC, and communication service providers. It deals also with associated flight crew and air traffic service provider procedures. ED-89A incorporates the protocols and message formats formerly published in ARINC Specification 623, and takes account of EUROCAE document ED-78 which describes the global processes including approval planning, co-ordinated requirements determination, development and qualification of a system element, entry into service, and operations.

#### 2. PURPOSE

- 2.1 This AMC is intended for operators intending to use Digital ATIS over ACARS as described in document EUROCAE ED-89A. It may assist also other stakeholders such as airspace planners, air traffic service providers (ATSP), ATS system manufacturers, communication service providers (CSP), aircraft and equipment manufacturers, and ATS regulatory authorities to advise them of the airborne requirements and procedures, and the related assumptions.
- 2.2 This AMC provides a method for evaluating compliance of a data link system to the requirements of ED-89A, and the means by which an aircraft operator can satisfy an authority that operational considerations have been addressed.

#### 3 SCOPE

- 3.1 This AMC addresses D-ATIS over ACARS using the ARINC 623 protocol as elaborated in EUROCAE document ED-89A and promoted by the EUROCONTROL Convergence and Implementation Plan as an interim data link application pending maturity of the LINK 2000+ programme.

<sup>1</sup> Information on LINK2000+ is available at web site [www.eurocontrol.int/link2000](http://www.eurocontrol.int/link2000)

- 3.2 Other implementation of D-ATIS service may exist in the world. They are not necessarily identical to the service defined within this AMC and EUROCAE document ED-89A. For example, application message formats may differ. Similarly, the ATSP may send ATIS information to an ACARS communication service provider who then distributes it to subscriber operators. This should not be considered as an air traffic service offered directly by an ATSP. In the USA, guidance on ATIS data link approval for use in the US airspace, may be found in FAA document 98-AIR D-ATIS: *Safety and Interoperability Requirements for ATIS*.
- 3.3 This AMC is not applicable to the phased implementation of data link services within the EUROCONTROL LINK2000+ programme, in particular, D-ATIS over the Aeronautical Telecommunications Network via VHF Digital Link (VDL) Mode 2. In this case, the Safety and Performance Requirements (EUROCAE ED-120) and the Interoperability Requirements (EUROCAE ED-110) have been established using EUROCAE document ED-78A, *Guidelines for Approval of the Provision and use of Air Traffic Services supported by Data Communications*. Guidance for the implementation of data link over ATN may be found in EASA document AMC 20-11.
- 3.4 The operational requirements for the D-ATIS application are published in EUROCONTROL document OPR/ET1/ST05/1000, *Transition guidelines for initial air ground data communication services*.
- 3.5 For the remainder of this document, the acronym D-ATIS should be interpreted to mean D-ATIS over ACARS using the ARINC 623 protocol in accordance with ED-89A unless stated otherwise.

#### 4 REFERENCE DOCUMENTS

##### 4.1 Related Requirements

CS/FAR 25.1301, 25.1307, 25.1309, 25.1322, 25.1431, 25.1581, or equivalent requirements of CS 23, 27 and 29, if applicable.

##### 4.2 Related Standards and Guidance Material

ICAO	Doc 9694 AN/955	Manual of Air Traffic Services (ATS) Data Link Applications
	Doc 4444	Rules of the Air and Air Traffic Services
	Annex 11	Air Traffic Services
	Doc 8585	Designators for Aircraft Operating agencies, Aeronautical Authorities and Services.
EASA	AMC 25-11	Electronic Display Systems
EUROCONTROL	CIP: COM. ET2.SO4; 2.1.5	Implement Air/Ground Communication Services - Interim step on non-ATN (ACARS) services.
	OPR/ET1/ST05/1000	Transition guidelines for initial air ground data communication services
	ESARR 4	Risk assessment and mitigation in ATM
FAA	AC 25-11	Electronic Display Systems.
	AC 120-70	Initial Air Carrier Operational Approval for use of Digital Communication Systems
	AC 20-140	Guidelines for design approval of aircraft data communications systems
	98-Air-D-ATIS	Safety and Interoperability requirement for D-ATIS (Air-100, April 21, 1998)

<b>EUROCAE</b>	ED 78	Guidance material for the establishment of data link supported ATS Services
	ED-89A	Data Link Application System document (DLASD) for the "ATIS" data link service
	ED-92A	Minimum Operational Performance specification for an airborne VDL Mode 2 Transceiver
	ED-112	Minimum operational performance specification for Crash protected airborne recorder systems Note: Includes criteria for recording of data link messages.
<b>RTCA</b>	DO-224	Minimum Aviation System Performance Standards (MASPS) for Advanced VHF Digital Data Communications Including Compatibility with Digital Voice Techniques.
<b>SAE</b>	ARP 4791	Human Machine Interface on the flight deck

## 5 ASSUMPTIONS

Applicants should note that this AMC is based on the assumptions stated in Chapter 3 of document ED-89A together with the following that concern the measures taken by the responsible airspace authorities to safeguard operations affected by the transmission of D-ATIS.

### 5.1 ATS Provider

- 5.1.1 The data link service for ATIS has been shown to satisfy applicable airspace safety regulations and the relevant ATS domain performance, safety and interoperability requirements of ED-89A.
- 5.1.2 The ATS Provider ensures that information provided through D-ATIS service is fully consistent with the voice information broadcast over VHF.
- 5.1.3 Appropriate procedures are established to minimise the possibility of failure to detect any inconsistency in ATIS information for approach, landing and take off.
- 5.1.4 Each ATS provider has published a list of communication service providers that may be used by aircraft operators for the D-ATIS application. The list should take account of internetworking arrangements between service providers.
- 5.1.5 The procedures of the ATS provider state the actions that should be taken in the event of an inadequate communication service from the communications service provider.

### 5.2 Communications Service Provider

The communications service provider does not modify the operational information (content and format) exchanged between the ATS provider and the airborne equipment.

### 5.3 Aeronautical Information Service

The availability of the D-ATIS service, a statement of compliance with ED-89A, and additional relevant procedures are published in the AIP or other notification issued by the States where D-ATIS is offered.

### 5.4 Message Integrity

The Cyclic Redundancy Check (CRC) is implemented as required by ED-89A and is providing integrity of the end-to-end data link transmission path. On this basis, Performance Technical Objective PTO\_3 of ED-89A need not be demonstrated by end

systems. The PTO\_3 requirement is applicable only to the Communication Service Provider and limits the amount of corrupted messages that would be detected and rejected by end-systems.

Note: The CRC is described in ARINC Specification 622 Chapter 5.

## **6 AIRWORTHINESS CONSIDERATIONS**

### **6.1 General**

6.1.1 The installation will need to meet the airborne domain requirements allocated as per ED-89A (§7.1) covering the Interoperability Operational Requirements, the Interoperability Technical Requirements, the Performance Technical Requirements, and the Safety Operational & Technical Requirements.

6.1.2 If multiple ATS data link applications are available to the aircraft, the crew interface and related crew procedures will need to be based on a common and compatible philosophy.

### **6.2 Required Functions**

An acceptable minimum airborne installation comprises the following functions:

(a) A means of data communication appropriate to the area of operation, e.g. plain old ACARS over AVLC (Aviation VHF Link Control) through VHF or SATCOM;

Note: VDL Mode 2 equipment can be used provided that radio transceiver is compliant with ED-92A.

(b) A means to manage data communications and to control the data communications system.

(c) A means to easily check and modify the D-ATIS request parameters.

(d) A means of attracting the attention of the flight crew to an incoming message.

Notes:

(1) Activation of a printer may suffice to meet this need.

(2) The means used will need to be such as to avoid confusion with other, non-data link, flight deck alerting devices.

(3) The need for temporary suppression of the attention-getter during critical flight phases should be considered.

(e) Means to display the text message, e.g. a single display readable by both pilots or a dedicated display for each pilot. For the interim deployment of D-ATIS over ACARS, a printer may serve as the primary display for messages subject to compliance with paragraph 7.3 of this AMC.

### **6.3 Recommended Functions**

(a) A means to print the message.

(b) Recording of D-ATIS messages and flight crew requests on an accident flight recorder.

Note: Data Link recording may be required in accordance with OPS rules.

## **7 ACCEPTABLE MEANS OF AIRWORTHINESS COMPLIANCE**

### **7.1 Airworthiness**

7.1.1 When demonstrating compliance with this AMC, the following should be noted:

- (a) Compliance with the airworthiness requirements for intended function and safety may be demonstrated by equipment qualification, safety analyses of the interfaces between components of the airborne communications equipment, structural analyses of new antenna installations, equipment cooling verification, and evidence of a suitable human to machine interface. The D-ATIS function will need to be demonstrated by end-to-end ground testing that verifies system operation, either with an appropriate ATS unit, or by means of test equipment that has been shown to be representative of an actual ATS unit.

Note:

This limited testing assumes that the communication systems (VHF or SATCOM) have been shown to satisfactorily perform their intended functions in the flight environment in accordance with applicable requirements.

- (b) The safety analysis of the interface between the ACARS and other systems should show that, under normal or fault conditions, no unwanted interaction that adversely affects essential systems can occur.
- (c) Where a printer is used as the primary display of the ATIS message, its readability should be shown to be adequate for this purpose, and that it does not present an unacceptable risk of an erroneous display.

Note:

This does not preclude the use of a printer classified as non-essential provided it has demonstrated a satisfactory in-service record that supports compliance with paragraph 7.3 of this AMC.

7.1.2 To minimise the certification effort for follow-on installations, the applicant may claim credit, from the responsible authority, for applicable certification and test data obtained from equivalent aircraft installations.

## 7.2 Performance

The installation will need to be shown compliant with the airborne domain performance requirements allocated by ED-89A (§7.1). Demonstration of Performance Technical Requirement PTR\_A1 may be difficult for some airborne installations. The applicant may choose an alternative acceptable means of compliance for PTR\_A1 consisting in an end-to-end demonstration of PTR\_5 & PTR\_6 of ED-89A (§5.2) with an appropriate ATS unit and communication service provider.

## 7.3 Safety Objectives

7.3.1 Failure Conditions are presented in ED-89A (§6) together with the resulting safety objectives and operational means of mitigation. Failure Condition FC3 (Non-detected corrupted ATIS presented to an aircrew) requires that the occurrence of such a hazard at the aircraft level be demonstrated improbable.

7.3.2 ED-89A takes into account the possibility of using ACARS approved to earlier standards and classified as “non-essential” without guarantees of performance or integrity. Consequently, additional procedures are necessary to compensate for any deficiency and to safeguard operations. (See §8 of this AMC)



#### 7.4 Aircraft Flight Manual

The Aircraft Flight Manual (AFM) or the Pilot's Operating Handbook (POH), whichever is applicable, should identify the D-ATIS over ACARS application as having been demonstrated with data link services declared compliant with EUROCAE document ED-89A.

If certification was not achieved at the level "essential", the AFM or POH, whichever is applicable, shall remind the crew that they are responsible for checking the D-ATIS information received over ACARS is consistent with their request, or revert to a voice ATIS.

#### 7.5 Existing installations

The applicant will need to submit a compliance statement that shows how the criteria of this AMC have been satisfied for existing installations. Compliance may be established by inspection of the installed system to confirm the availability of required features and functionality.

Note: It is not intended that aircraft which have received airworthiness approval in compliance with ED 89 requirement should be reinvestigated where the installation is compliant with Section 6, 7 and 8 of this AMC.

### **8 OPERATIONAL CONSIDERATIONS**

#### 8.1 Operational Safety Aspects

8.1.1 Failure Conditions are presented in ED-89A (§6) together with the resulting safety requirements and operational means of mitigation. Failure Condition FC3 (Non-detected corrupted ATIS presented to an aircrew) is discussed further in the following paragraphs.

8.1.2 Applying existing ICAO operational procedures can independently verify the majority of ATIS parameters. Certain information may need to be verified by additional operational procedures. Examples include runway surface conditions, air and dew point temperatures, and other essential operational information.

8.1.3 If the aircraft system is classified and certified as "non-essential", additional flight crew verification procedures will need to be defined to compensate for this deficiency.

8.1.4 When the airborne system is certified as "essential", then integrity and performance can be considered as acceptable without a voice ATIS cross check unless otherwise required by the AIP.

8.1.5 It is important that crew are aware that they remain responsible for checking that received ATIS information corresponds to their request in terms of airfield name, date, type of ATIS (D or A) and type of contract. In case of inconsistency, reversion to voice ATIS is required.

Note: ED-89A (§6) SOR-A1 (check of name of airfield), SOR-A2 (ATIS letter acknowledgement at first contact) and SOR-A3 (check of global consistency of information) require checks irrespective of the level of classification of the data link system

8.1.6 Flight crews will need to comply with any additional mitigating procedures published by the States where aircraft will operate and use a D-ATIS service.

- 8.1.7 The assumptions of Section 5 of this AMC need to be satisfied as a condition for operational use.
- 8.2 Operations Manual and Training
- 8.2.1 The Operations Manual shall reflect the Flight Manual statement of paragraph 7.4, and to define operating procedures for the use of D-ATIS via ACARS taking into account the Operational Considerations discussed in paragraph 8 of this AMC.
- 8.2.2 Similarly, flight crew training shall address:
- (a) The different data link services available using the same airborne equipment (e.g. differences between ATIS provided through D-ATIS service that are declared to conform to ED-89A requirements, and ATIS received through other means such as ACARS AOC).
  - (b) The procedures for safe use of D-ATIS over ACARS.
- 8.2.3 Subject to any arrangements that may be required by the responsible operations authority in respect of amendments to the Operations Manual, and the approval of training programmes, the aircraft operator may implement operations using D-ATIS over ACARS without the need for further formal operational approval.
- 8.3 Incident reporting
- Significant incidents associated with a D-ATIS transmitted by data link that affects or could affect the safe operation of the aircraft will need to be reported in accordance with applicable operational rules. The incident should be reported also to the ATS authority responsible for the airport where the D-ATIS service is provided.

#### **AVAILABILITY OF DOCUMENTS**

EUROCAE documents may be purchased from EUROCAE, 17 rue Hamelin, 75783 Paris Cedex 16, France, (Fax: 33 1 45 05 72 30). Web site: [www.eurocae.org](http://www.eurocae.org)

JAA documents are available from the JAA publisher Information Handling Services (IHS). Information on prices, where and how to order is available on both the JAA web site: [www.jaa.nl](http://www.jaa.nl) and the IHS web site: [www.avdataworks.com](http://www.avdataworks.com). JAA documents transposed to publications of the European Aviation Safety Agency (EASA) are available on the EASA web site [www.easa.europa.eu](http://www.easa.europa.eu)

EUROCONTROL documents may be requested from EUROCONTROL, Documentation Centre, GS4, Rue de la Fusee, 96, B-1130 Brussels, Belgium; (Fax: 32 2 729 9109). Web site: [www.eurocontrol.int](http://www.eurocontrol.int)

ICAO documents may be purchased from Document Sales Unit, International Civil Aviation Organisation, 999 University Street, Montreal, Quebec, Canada H3C 5H7, (Fax: 1 514 954 6769, e-mail: [sales\\_unit@icao.org](mailto:sales_unit@icao.org)) or through national agencies.

FAA documents may be obtained from Department of Transportation, Subsequent Distribution Office SVC-121.23, Ardmore East Business Centre, 3341 Q 75<sup>th</sup> Avenue, Landover, MD 20785, USA.

RTCA documents may be obtained from RTCA Inc, 1828 L Street, NW. Suite 805, Washington, DC 20036, USA., (Tel: 1 202 833 9339; Fax 1 202 833 9434). Web site: [www.rtca.org](http://www.rtca.org)

SAE documents may be obtained from SAE World Headquarters, 400 Commonwealth Drive, Warrendale, PA 15096-0001, USA. Telephone 1-877-606-7323 (U.S. and Canada only) or 724/776-4970 (elsewhere). Web site: [www.sae.org](http://www.sae.org)

[Amdt 20/1]

## Appendix 1 to AMC 20-10 Common Terms

ED Decision 2006/012/R

Reference should be made to EUROCAE document ED-89A for definition of terms.

### Abbreviations

ACARS	Aircraft Communication, Addressing and Reporting System
AIP	Aeronautical Information Publication
ATIS	Automatic Terminal Information Service
ATSP	Air Traffic Service Provider
D-ATIS	Digital ATIS
ARINC	Aeronautical Radio Inc.
ATS	Air Traffic services
CPDLC	Controller-Pilot Data Link Communication
ESARR	EUROCONTROL Safety Regulatory Requirement
EUROCAE	European Organisation for Civil Aircraft Equipment
NAS	National Airspace System (USA)
PTR	Performance Technical Requirement
PTO	Performance Technical Objective
RTCA	RTCA Inc.
SAE	Society of Automotive Engineers
SARPS	ICAO Standards and Recommended Practices
VDL	VHF Digital Link

[Amdt 20/1]

## AMC 20-11

### AMC 20-11 Acceptable Means of Compliance for the Approval of use of Initial Services for Air-Ground Data Link in Continental Airspace

*ED Decision 2007/019/R*

#### 1 PREAMBLE

Controller Pilot Data Link Communications, CPDLC is identified in the ATM Strategy for the years 2000+ as an enabler for operational improvement. They reduce controller workload and increase sector capacity. Simulations show that the sector capacity is increased by 11% if 75% of all controlled flights have CPDLC data link capability. The deployment strategy of CPDLC data link services is a three-step plan:

- Pioneer support for at least the first 150 aircraft.
- Incentives mechanisms for aircraft with CPDLC capability to foster the aircraft equipage with data link capability.
- Single European Sky interoperability implementing rules on data link services.

#### 2 PURPOSE

This AMC is for aircraft operators seeking approval to use initial data link services in continental airspace. It contains:

- a set of assumptions relating to the implementation of data link services by air navigation service providers, communications service providers, aeronautical information service providers;
- an initial basis relating to the implementation of data link services in the flight deck to guide the airworthiness certification process;
- an initial basis relating to the operational use of data link services by aircraft operators to guide the operational approval process.

#### 3 SCOPE

3.1 This AMC is applicable to services for with the following capabilities:

- a) Data Link Initiation Capability (DLIC) enables initial contact between the aircraft and an ATC unit that supports data communications, to unambiguously identify the aircraft, and to ensure compatibility of aircraft equipage with ATC. It is a prerequisite to any other operational data link services.
- b) ATC Communication Management (ACM) provides the necessary information to the aircraft to enable transfer of frequencies for both voice and data communications, either within the same sector, between two sectors or between two ATC centres.
- c) ATC Clearances (ACL) enables uplink of a set of clearance and information messages and downlink of pilot responses and requests.
- d) ATC Microphone Check (AMC) enables the controller to send a message to data link equipped aircraft (of appropriate interoperability) to request a stuck microphone check.

- e) Departure Clearance (DCL) enables the request and the delivery of departure information and clearance.
- f) Downstream Clearance (DSC) enables the request and the delivery of clearance with a downstream ATC centre (i.e. oceanic clearance).
- g) D-ATIS enables the request and the delivery of ATIS via data link.

Note: Implementations of DCL, D-ATIS and OCL over ACARS are not the subject of this AMC. Reference should be made to other applicable JAA or EASA documents based on ED85A, ED89A and ED106A.

#### 4 REFERENCE DOCUMENTS

##### 4.1 Related Requirements

CS/FAR 25.1301, 25.1307, 25.1309, 25.1322, 25.1431, 25.1581, or equivalent requirements of CS 23, 27 and 29, if applicable.

##### 4.2 Related Standards and Guidance Material

<b>ICAO</b>	Annex 2	Rules of the Air.
	Annex 6	Operation of Aircraft, Part I - International Commercial Air Transport – Aeroplanes.
	Annex 10	Aeronautical Telecommunications - Volume II (Communications Procedures including those with PANS status).
	Annex 11	Air Traffic Services.
	Annex 15	Aeronautical Information Services.
	Doc 4444	Procedures for Air Navigation Services - Air Traffic Management (PANS-ATM)
	Doc 8585	Designators for Aircraft Operating agencies, Aeronautical Authorities and Services.
	Doc 9694	Manual of Air Traffic Services (ATS) Data Link Applications.
<b>EASA</b>	AMC 25-11	Electronic Display Systems.
<b>EUROCONTROL</b>	LINK 2000+/PM/BASELINE/	LINK Baseline, Version 1.4, November 2006
	AGC-ORD-01	EATCHIP/ODIAC Operational Requirements for Air ground cooperative air traffic services Edition 1.0. 2 April 2001.
	ESARR 4	Risk assessment and mitigation in ATM.
<b>FAA</b>	AC 25-11	Electronic Display Systems.
	AC 120-70	Initial Air Carrier Operational Approval for use of Digital Communication Systems.
	AC 20-140	Guidelines for design approval of aircraft data communications systems.
<b>EUROCAE</b>	ED-78A	Guidelines for Approval of the Provision and Use of Air Traffic Services supported by Data communications.
	ED-92A	Minimum Operational Performance Specification for an Airborne VDL System.
	ED-112	Minimum operational performance specification for Crash protected airborne recorder systems
	ED-110B	Interoperability Requirements Standard for ATN Baseline 1 (INTEROP ATN B1).

	ED-120	Safety and Performance Requirements Standard for Initial Data Link Services In Continental Airspace (SPR IC) including change 1 and change 2.
RTCA	DO-224A	Signal-in-Space Minimum Aviation System Performance Standards (MASPS) for Advanced VHF Digital Data Communications Including Compatibility with Digital Voice Techniques.
	DO-264	Guidelines for Approval of the Provision and Use of Air Traffic Services Supported by Data Communications. (Equivalent to ED-78A)
	DO-280B	Interoperability Requirements Standard for ATN B1 (Equivalent to ED-110B)
	DO-290	Safety and Performance Requirements Standard for Air Traffic Data Link Services in Continental Airspace (Continental SPR Standard) including change 1 and change 2. (Equivalent to ED-120)
SAE	ARP 4791	Human Machine Interface on the flight deck.

## 5 ASSUMPTIONS

Applicants should note that this AMC is based on the following assumptions.

### 5.1 Air Navigation Service Provider (ANSP)

5.1.1 Air navigation service providers implement all services or a subset compliant with relevant requirements of:

- the Safety and Performance Requirements of EUROCAE standard SPR ED-120,
- and the interoperability requirements of EUROCAE standard INTEROP ED-110B.

Deviations from these standards are assessed by ANSPs. Deviations that potentially impact the airborne domain should be assessed in coordination with relevant stakeholders as per ED-78A.

5.1.2 ANSP procedures specify the actions to be taken in case of failure of data link communication.

### 5.2 Communications Service Provider (CSP)

5.2.1 The CSP is committed to provide communication services to ANSPs and aircraft operators with the expected Quality of Service as defined in a specific Service Level Agreement. The Service Level Agreement is bilaterally agreed between the CSP and an ANSP. The terms of reference of the Service Level Agreement are consistent with the performance requirements of the SPR ED-120 document.

5.2.2 The CSP does not modify intentionally the operational information (content and format) of messages exchanged between the ANSP and the aircraft

### 5.3 Aeronautical Information Service (AIS)

5.3.1 Each State publishes in its AIP/NOTAM, or equivalent notification, information related to the data link service provisions, service schedule, relevant procedures, and confirmation of compliance with EUROCAE standard SPR, ED-120 and INTEROP ED-110B.

- 5.3.2 The publication will comprise a list of communication service providers that may be used by aircraft operators for the Link 2000+ services, taking into account internetworking arrangements between service providers.

## **6 AIRWORTHINESS CONSIDERATIONS**

### **6.1 General**

Qualification criteria requiring coordination is provided in ED-78A.

- 6.1.2 The installation should be shown to meet the safety and performance requirements allocated to the aircraft as provided in SPR ED-120, and the applicable interoperability requirements INTEROP ED-110B.

- 6.1.3 The VDL mode 2 radio transceiver should be compliant with ED-92A.

- 6.1.4 The airborne ATN router should be compliant with an ATN MOPS acceptable to the certification authority. In the absence of a published generic MOPS, the applicant may propose alternative minimum performance criteria for which interoperability and testability can be demonstrated.

- 6.1.5 Recording of ATS messages for accident investigation will need to be implemented when required by the applicable operational rules or by national regulation.

### **6.2 Human-machine interface on the flight deck**

- 6.2.1 Compatibility. The human-machine interface should be compatible with the crew interface and flight deck design of the particular aircraft in which the data communications system and applications are installed.

- 6.2.1.1 If multiple ATS data link applications are available to the aircraft, the crew interface and related crew procedures should be based on a common and compatible philosophy.

- 6.2.2 Flight deck annunciation. The data communications system should have the following annunciation capability, which should be integrated into the flight deck so as to be compatible with the overall alerting scheme of the aircraft.

- 6.2.2.1 Unless otherwise substantiated by means acceptable to the certification authority, an audible and visual indication should be given for each uplink ATS message intended to be displayed to the flight crew, including those messages not be displayed immediately because of lack of crew acknowledgement to an earlier ATS message. Visual alerts alone may be used for non-ATS messages

- 6.2.2.2 The status of the data communications system should be available to the flight crew, e.g., loss of the data communications connection with communications management unit or its equivalent.

- 6.2.2.3 If message storage and/or printing capability is provided, the system should indicate when storage and/or printing is not possible.

- 6.2.2.4 Annunciation of the receipt of a message during critical flight phases (e.g., takeoff and landing) should be inhibited until after the critical flight phase. The criteria that define critical flight phases should be consistent with the particular flight deck philosophy and the particular data link services supported.

- 6.2.3 Flight deck controls. Control capability for the data communications system and applications should meet the following criteria:
- 6.2.3.1 Means should be provided for the flight crew to activate or deactivate each of the data communication applications.
  - 6.2.3.2 Means should be provided to the aircrew to know in real time the identity of the ATS provider(s) connecting with the aircraft, and the applications involved with each connection.
  - 6.2.3.3 Means should be provided for the flight crew to acknowledge receipt of ATS messages.
  - 6.2.3.4 Means should be provided for the flight crew to list, select, and retrieve the most recent (e.g. ten) ATS messages received and sent by the flight crew during the flight segment. The status of each message, the time it was received or sent, should be accessible.
  - 6.2.3.5 Means should be provided for the flight crew to clear uplinked messages from the display. However this capability should be protected against inadvertent clearing.
  - 6.2.3.6 Means should be provided for the flight crew to create, store, retrieve, edit, delete, and send messages.
  - 6.2.3.7 If a direct interface exists between the data communications application and other computer functions, (e.g. flight planning and navigation), a means should be provided for the flight crew to activate the computer function to use the data contained in the message. The means provided should be separate from that used to acknowledge receipt of a message.
- 6.2.4 Flight deck displays. Display capability of the data communications system and applications should meet the following criteria:
- 6.2.4.1 All messages should be displayed, without being truncated, in a format that the flight crew can comprehend without the need for translation from English into another language.
  - 6.2.4.2 The flight crew should be able to read displayed messages without leaving their seats.
  - 6.2.4.3 Except for the ATIS, messages from the ATS should be displayed without the need for flight crew action, and remain displayed until acknowledged, unless the flight crew selects another message or, in the case of a multi-function display, another display format or function. In these cases a reminder should indicate that pending messages are waiting for a response.
  - 6.2.4.4 ATS messages should be displayed so that messages are distinguishable from each other. The status of each message (i.e. source, time sent, open/closed) should be displayed together with the message.
  - 6.2.4.5 When the data communications application is sharing a display with other aircraft functions, the aircraft system should ensure appropriate priority for the information to be displayed.
  - 6.2.4.6 If a message intended for visual display is greater than the available display area and only part of the message is displayed, a visual indication shall be provided to the pilot to indicate the presence of the message remainder.



6.2.5 Flight deck Printer. A flight deck printer may be used as a means of storing data communications messages received or sent during the current flight. It should satisfy integrity and interface design criteria appropriate for this purpose

## **7 ACCEPTABLE MEANS OF AIRWORTHINESS COMPLIANCE**

### **7.1 Airworthiness**

7.1.1 When showing compliance with this AMC, the following points should be noted:

- a) The applicant will need to submit, to the Agency, a certification plan and a compliance statement that shows how the criteria of this AMC have been satisfied, together with evidence resulting from the activities described in the following paragraphs.
- b) Compliance with the certification specifications (e.g. CS 25) for intended function and safety may be demonstrated by equipment qualification, safety analysis of the interface between the communications management system and other systems, structural analyses of new antenna installations, equipment cooling verification, and evidence of a human to machine interface, suitable for ATC initial continental data link services, and taking account of the criteria of paragraph 6.
- c) The aircraft data communications system and applications should be demonstrated by end-to-end ground testing that verifies system operation interoperability and performance, either with an appropriate ATS unit, or by means of test equipment that has been shown to be representative of the actual ATS unit. The testing should verify system operation, interoperability, and performance.

Notes:

- 1 EUROCAE ED-78A gives guidance on test equipment for this purpose.
  - 2 This limited testing assumes that the communication systems have been shown to satisfactorily perform their intended functions in the flight environment in accordance with applicable requirements.
- d) When showing compliance with CS 25.1309, consideration should be given to the possibility of unacceptable interaction between the communications management system and other essential systems.

7.1.2 To minimise the certification effort for follow-on installations, the applicant may claim credit, from the responsible authority, for applicable certification and test data obtained from equivalent aircraft installations.

### **7.2 Performance**

Where compliance with a performance requirement cannot readily be demonstrated by a test, then the performance may be verified by an alternative method such as analysis.

### **7.3 Aircraft Flight Manual**

7.3.1 The Normal Procedures section of the Flight Manual shall provide a statement as follows:

“The aircraft ATC data link system has been demonstrated to comply with the applicable safety and performance requirements of EUROCAE ED-120, the interoperability requirements of ED-110B and with AMC 20-11. This AFM entry

does not, by itself, constitute an operational approval where such an approval is required.”

7.3.2 The following information, as applicable to the specific services approved for the aircraft, will need to be included in either the Flight Manual or other operational documents.

“The aircraft ATC data link system is intended for the following data link services:

- a) Data Link Initiation Capability (DLIC) enabling initial contact between the aircraft and an ATC unit that supports data communications, to unambiguously identify the aircraft, and to ensure compatibility of aircraft equipage with ATC. It is a prerequisite to any other operational data link services.
- b) ATC Communication Management (ACM) providing the necessary information to the aircraft to enable transfer of frequencies for both voice and data communications, either within the same sector, between two sectors or between two ATC centres.
- c) ATC Clearances (ACL) enabling uplink of a set of clearance and information messages and downlink of pilot responses and requests.
- d) ATC Microphone Check (AMC) enabling the controller to send a message to data link equipped aircraft (of appropriate interoperability) to request a stuck microphone check.
- e) Departure Clearance (DCL) enabling the request and the delivery of departure information and clearance.
- f) Downstream Clearance (DSC) enabling the request and the delivery of clearance with a downstream ATC centre (i.e. oceanic clearance).
- g) D-ATIS “enabling the request and the delivery of ATIS via data link.”

#### 7.4 Existing installations

The applicant will need to submit, to the responsible authority, a compliance statement, which shows how the criteria of this AMC have been satisfied for existing installations. Compliance may be supported by design review and inspection of the installed system to confirm the availability of required features, functionality and acceptable human-machine interface.

7.4.2 Where this design review finds items of non-compliance, the applicant may offer mitigation that demonstrates an equivalent level of safety and performance. Items presented by the applicant which impact safety, performance and interoperability requirements allocation will need to be coordinated in accordance with ED-78A.

## **8 OPERATIONAL CONSIDERATIONS**

Reserved.

## **9 AVAILABILITY OF DOCUMENTS**

102 rue Etienne Dolet – 92240 Malakoff - France.

Telephone: +33 1 40 92 79 30; FAX +33 1 46 55 62 65;. Web site: [www.eurocae.eu](http://www.eurocae.eu).

JAA documents are available from the JAA publisher Information Handling Services (IHS). Information on prices, where and how to order is available on both the JAA web site [www.jaa.nl](http://www.jaa.nl) and the IHS web site [www.ihs.com](http://www.ihs.com).

EUROCONTROL documents may be requested from EUROCONTROL, Documentation Centre, GS4, Rue de la Fusee, 96, B-1130 Brussels, Belgium; (Fax: 32 2 729 9109 or web site [www.eurocontrol.int](http://www.eurocontrol.int)).

ICAO documents may be purchased from Document Sales Unit, International Civil Aviation Organisation, 999 University Street, Montreal, Quebec, Canada H3C 5H7, (Fax: 1 514 954 6769, e-mail: [sales\\_unit@icao.org](mailto:sales_unit@icao.org)) or through national agencies.

FAA documents may be obtained from Department of Transportation, Subsequent Distribution Office SVC-121.23, Ardmore East Business Centre, 3341 Q 75th Avenue, Landover, MD 20785, USA.

RTCA documents may be purchased from RTCA, Incorporated, 1828 L Street, Northwest, Suite 820, Washington, D.C. 20036-4001 U.S.A. Web site: [www.rtca.org](http://www.rtca.org).

SAE documents may be obtained from SAE World Headquarters, 400 Commonwealth Drive, Warrendale, PA 15096-0001, USA. Telephone 1-877-606-7323 (U.S. and Canada only) or 724/776-4970 (elsewhere). Web site [www.sae.org](http://www.sae.org).

[Amdt 20/2]

## Appendix 1 to AMC 20-11 Common Terms

*ED Decision 2007/019/R*

Reference should be made to EUROCAE document ED-110B and ED-120 for definitions of terms.

### Abbreviations

AAC	Aeronautical Administrative Communications
ACARS	Aircraft Communications Addressing and Reporting System
ACC	Area Control Centre
ACL	ATC Clearances
ACM	ATC Communication Management
ADS	Automatic Dependent Surveillance
AIP	Aeronautical Information Publication
AMC	ATC Microphone Check (service)
AMJ	Advisory Material Joint
ANS	Air Navigation Service
ARINC	Aeronautical Radio Incorporated (USA)
ATC	Air Traffic Control
ATIS	Automatic Terminal Information Service
ATM	Air Traffic Management
ATN	Aeronautical Telecommunication Network
ATS	Air Traffic Services
ATSU	Air Traffic Service Unit
CAA	Civil Aviation Authority
CFR	Code of Federal Regulations
CM	Configuration (Context) Management
CMU	Communications Management Unit
CNS	Communication, Navigation and Surveillance
CNS/ATM	Communication, Navigation and Surveillance / Air Traffic Management
CPDLC	Controller Pilot Data Link Communications
CS	Certification Specifications
CSP	Communication Service Provider
D-ATIS	Data Link ATIS
DCL	Departure Clearance
DFIS	Data Link Flight Information Service (ICAO)
DLIC	Data Link Initiation Capability
DSC	Downstream Clearance
EATCHIP	European Air Traffic Control Harmonisation and Integration Programme (see EATMP)
EATMP	European Air Traffic Management Programme
ECIP	European Convergence and Implementation Plan
EFIS	Electronic Flight Instrument System
ESARR	Eurocontrol Safety Regulatory Requirements
EUROCAE	EUROpean Organisation for Civil Aviation Equipment
EUROCONTROL	European Organisation for the Safety of Air Navigation
FAA	Federal Aviation Administration
FANS	Future Air Navigation Systems (ICAO)
FMS	Flight Management System

---

ICAO	International Civil Aviation Organisation
INTEROP	Interoperability
JAA	Joint Aviation Authorities
JAR-OPS	Joint Aviation Requirements- Operations
MASPS	Minimum Aircraft System Performance Specification or Minimum Aviation System Performance Standards
MCDU	Multi-purpose Control and Display Unit
MOPS	Minimum Operational Performance Specification or Minimum Operational Performance Standards
NOTAM	Notice to Airmen
OSED	Operational Services and Environment Definition
REF	Reference
RTCA	RTCA Inc
SAE	Society of Automotive Engineers
SARPs	Standards and Recommended Practices (ICAO)
SATCOM	Satellite Communications
SC	Standing Committee
SLA	Service Level Agreement
SPR	Safety and Performance Requirements
VDL	VHF Digital Link
VDR	VHF Digital/Data Radio
VHF	Very High Frequency
WG	Working Group

[Amdt 20/2]

# AMC 20-12

## AMC 20-12 Recognition of FAA Order 8400.12a for RNP-10 Operations

ED Decision 2006/012/R

### 1. PURPOSE

This AMC calls attention to the FAA Order 8400.12A "Required Navigation Performance 10 (RNP-10) Operational Approval", issued 9<sup>th</sup> February 1998. FAA Order 8400.12A addresses RNP-10 requirements, the operational approval process, application principles, continuing airworthiness and operational requirements. This AMC explains how the technical content and the operational principles of the Order may be applied as a means, but not the only means, to obtain EASA approval for RNP-10 operations.

### 2. REFERENCE DOCUMENTS

#### 2.1 Related Requirements

CS/FAR 25.1301, 25.1307, 25.1309, 25.1316, 25.1321, 25.1322, 25.1329, 25.1431, 25.1335 25.1581.

CS/FAR 23.1301, 23.1309, 23.1311, 23.1321, 23.1322, 23.1329, 23.1335, 23.1431, 23.1581.

#### 2.2 Related Guidance Material

##### 2.2.1 ICAO

ICAO Doc 7030/4	Regional Supplementary Procedures
ICAO Doc 9613-AN/937	Manual on Required Navigational Performance

##### 2.2.2 EASA/JAA

EASA AMC 25-11	Electronic Display Systems.
EASA AMC 20-5	Airworthiness Approval and Operational Criteria for the use of the Navstar Global Positioning System (GPS).
JAA Leaflet No 9	Recognition of EUROCAE Document ED-76 (RTCA DO-200A): Standards for Processing Aeronautical Data.

##### 2.2.3 FAA

Order 8400.12A	Required Navigation Performance 10 (RNP-10) Operational Approval, issued February 1998.
Order 8110.60	GPS as Primary Means of Navigation for Oceanic/Remote Operations.
AC 25-4	Inertial Navigation Systems (INS).
AC 25-11	Electronic Display Systems.
AC 25-15	Approval of Flight Management Systems in Transport Category Airplanes.
AC 20-130A	Airworthiness Approval of Navigation or Flight Management Systems Integrating Multiple Navigation Sensors.

AC 20-138	Airworthiness Approval of NAVSTAR Global Positioning System (GPS) for use as a VFR and IFR Supplemental Navigation System.
14 CFR Part 121 Appendix G	Doppler Radar and Inertial Navigation System (INS): Request for Evaluation; Equipment and Equipment Installation; Training Program; Equipment Accuracy and Reliability; Evaluation Program.

#### 2.2.4 Technical Standard Orders

ETSO-2C115() / TSO-C115()	Airborne Area Navigation Equipment Using Multi-sensor Inputs.
ETSO-C129a / TSO-C129()	Airborne Supplemental Navigation Equipment Using the Global Positioning System (GPS)
ETSO-C145/ TSO-C145()	Airborne Navigation Sensors Using the Global Positioning System (GPS) Augmented by the Wide Area Augmentation System (WAAS).
ETSO-C146/ TSO-C146()	Stand-Alone Airborne Navigation Equipment Using the Global Positioning System (GPS) Augmented by the Wide Area Augmentation System (WAAS).

#### 2.2.5 EUROCAE / RTCA and ARINC

ED-75A / DO-236A	Minimum Aviation System Performance Standards: Required Navigation Performance for Area Navigation.
ED-76 / DO-200A	Standards for Processing Aeronautical Data.
ED-77 / DO-201A	Standards for Aeronautical Information.
DO-229B	Minimum Operational Performance Standards for Global Positioning System/Wide Area Augmentation System Airborne equipment.
ARINC 424	Navigation System Data Base.

### 3. BACKGROUND

- 3.1 Airspace in various oceanic and remote regions of the world is being restructured progressively to provide capacity and operating benefits for the aircraft traffic. This restructuring involves reduced route spacing (e.g. 50NM in place of 100NM) that, in turn, demands improved aircraft navigational performance. Airspace for this purpose is designated as RNP-10 airspace.
- 3.2 The RNP-10 implementation is for the oceanic and remote phases of flight where ground based navigation aids do not exist except possibly at isolated locations. Hence aircraft navigation will need to be based on a long range navigation capability of acceptable performance using inertial navigation and/or global positioning systems.
- 3.3 Aircraft may qualify for RNP-10 airspace operational approval on the basis of compliance with an appropriate RNP build standard. The navigation performance of aircraft already in service also may qualify and this AMC provides a means of determining their eligibility.
- 3.4 It is not intended that RNP-10 operational approvals already granted by national authorities in compliance with FAA Order 8400.12A should be re-investigated.

## 4 CERTIFICATION CRITERIA

### 4.1 Airworthiness Approval

FAA Order 8400.12A discusses required system performance (paragraphs 10 and 15), certification actions (paragraph 16), continued airworthiness considerations (paragraph 14), and provides guidance (paragraph 12) for demonstrating eligibility for RNP-10 approval. Key aspects of the FAA Order are summarised in the following paragraphs of this AMC. These should be applied in conjunction with the technical content of the Order for the purposes of obtaining RNP-10 approval under EASA regulations.

### 4.2 Required Equipment and Performance

4.2.1 Aircraft operating in RNP-10 airspace shall have a 95% cross-track error of less than 10 NM. This includes positioning error, flight technical error (FTE), path definition error and display error. The aircraft shall have also a 95% along-track positioning error of less than 10 NM.

4.2.2 Loss of all long range navigation information should be Improbable (Remote), and displaying misleading navigational or positional information simultaneously on both pilot's displays should be Improbable (Remote). This requirement can be satisfied by the carriage of at least dual independent, long range navigation systems compliant with the criteria of this AMC and the FAA Order. See also EASA AMC 25-11.

### 4.3 Eligibility for RNP-10 Operations

In respect of system navigational performance, the Order defines three aircraft groups, which may be eligible for RNP-10 operations:

- Aircraft eligibility through RNP certification (Eligibility Group 1).
- Aircraft eligibility through prior navigation system certification (Eligibility Group 2).
- Aircraft eligibility through Data Collection (Eligibility Group 3).

In all cases, where navigation relies on inertial systems, a usage limit of 6.2 hours is set from the time the inertial system is placed into the navigation mode. The FAA Order explains, in paragraph 12d, the options available to extend the time limits for use of inertial systems.

RNP containment integrity/continuity, as defined in EUROCAE ED-75( ) (or RTCA DO-236( ) “MASPS for RNP Area Navigation”), are not required functions for RNP-10 operations.

#### 4.3.1 Aircraft eligibility through RNP certification (Eligibility Group 1).

Group 1 aircraft are those that have obtained formal certification and approval of RNP capable systems integrated in the aircraft.

If RNP compliance is stated in the Aircraft Flight Manual (AFM), the operational approval of Group 1 aircraft will be based upon the performance defined in that statement.

Note: RNP value in AFM is typically not limited to RNP-10. The AFM will state RNP levels that have been demonstrated. An airworthiness approval specifically addressing only RNP-10 performance may be requested and granted.



#### 4.3.2 Aircraft eligibility through prior navigation system certification (Eligibility Group 2).

Group 2 represents aircraft that can equate their level of performance, certified against earlier standards, to the RNP-10 criteria. Group 2 aircraft are sub-divided into three parts:

(a) Aircraft equipped with Inertial Systems

These aircraft are considered to meet all of the RNP-10 requirements for up to 6.2 hours of flight time if the inertial systems have been shown to meet the intent of CFR Part 121, Appendix G<sup>1</sup>, or equivalent criteria. This time starts when the system is placed in the navigation mode and no en-route facility for radio updating is available. Operators may seek approval to extend this time limit by demonstrating inertial system accuracy, better than the assumed 2 NM per hour radial error, by means of an additional data collection.

If systems are updated en-route (radio navigation updating), the 6.2 hour limit can be extended taking account of the accuracy of the update. See paragraph 4.5 of this AMC.

(b) Aircraft where GPS provides the only means of long range navigation.

For aircraft in this group where GPS provides the only means of long range navigation (i.e. inertial systems are not carried) when out of range of conventional ground stations (VOR/DME), the aircraft flight manual should indicate that the GPS installation is approved as a primary means of navigation for oceanic and remote operations in accordance with FAA Notice 8110.60<sup>2</sup>. These aircraft are considered to meet the RNP-10 requirements without time limitations. At least dual GPS equipment, compliant with ETSO-C129a/TSO-C129(), are required, together with an approved availability prediction program for fault detection and exclusion (FDE) for use prior to dispatch. For RNP-10 operations, the maximum allowable period of time for which the FDE capability is predicted to be unavailable is 34 minutes.

(c) Multisensor Systems Integrating GPS with Inertial Data.

Multisensor systems integrating GPS with RAIM, FDE or an equivalent integrity method that are approved in accordance with FAA AC 20-130A are considered to meet RNP-10 requirements without time limitations. In this case, the inertial system will need to meet the intent of CFR Part 121, Appendix G, or equivalent criteria.

#### 4.3.3 Aircraft eligibility through Data Collection (Eligibility Group 3).

Group 3 represents older out-of-production aircraft that contain widely varying navigation capability.

A data collection program, acceptable to the Agency, may be used by the applicant to demonstrate that the aircraft and navigation systems provide the flight crew with acceptable navigational situational awareness relative to the intended RNP-

<sup>1</sup> See Annex 2

<sup>2</sup> Notice 8110.60 is recognised by AMC 20-5. The material is now incorporated in AC 20-138A as Appendix 1

10 route. The Order describes the essential aspects of a data collection programme.

The Agency will accept as evidence, inertial system performance data obtained and analysed during previous programmes for RNP-10 approval including data that validates extended flight time.

#### 4.4 Operational Approval and Procedures.

The operational principles given in the FAA Order may be used as the basis for RNP-10 operational approval. To obtain approval, the applicant should address at least the following:

##### 4.4.1 Eligibility for RNP-10.

Evidence should be made available confirming that the aircraft has an approved RNP-10 navigation capability.

##### 4.4.2 Aircraft Equipment and Minimum Equipment List.

The applicant should provide a configuration list of equipment to be used for RNP-10 operations. The MEL (MMEL) should be reviewed to ensure its compatibility with RNP-10 operations. Specific attention should be directed to the need for three inertial navigation units for dispatch if RNP-10 approval is based on a triple-mix solution.

##### 4.4.3 Operational Procedures and Training.

4.4.3.1 Applicant should demonstrate to the responsible authority that the training items related to RNP-10 operations are incorporated into flight crew training. Training for other personnel should be included where appropriate (e.g., dispatchers and maintenance personnel).

4.4.3.2 Operating manuals and checklists should be revised to include information and guidance appropriate to RNP-10 operations. The manuals should include operating instructions for the navigation equipment, and RNP-10 operational procedures (see Appendix 4 of the Order).

4.4.3.3 Operating procedures will need to take account of the RNP-10 time limit declared for the inertial system, if applicable, considering also the effect of weather conditions that could affect flight duration in RNP-10 airspace. Where an extension to the time limit is permitted, the flight crew will need to ensure en-route radio facilities are serviceable before departure, and to apply radio updates in accordance with any Flight Manual limits.

4.4.3.4 Manuals and checklists will need to be submitted to the responsible authority for review as part of the approval process.

#### 4.5 Position Updating

Subject to approval, operators may extend their RNP-10 inertial navigation time by position updating as discussed in paragraph 12e and Appendix 7 of the Order. For position updating approval, aircraft operators will need to calculate, using statistically based typical winds for each planned route, points at which updates can be made, and the points at which further updates will not be possible.

#### 4.5.1 Automatic radio position update.

Automatic radio position updating is acceptable for operations in RNP-10 airspace as discussed in paragraph 12f of the Order.

#### 4.5.2 Manual radio position update.

Subject to an approved procedure, manual radio updating is permitted as discussed in the paragraph 12g and Appendix 7, of the Order.

#### 4.6 Incident reporting.

Significant incidents associated with the operation of the aircraft that affect or could affect the safety of RNP-10 operations (i.e. navigation error) will need to be reported in accordance with applicable operational rules.

### 5. AVAILABILITY OF DOCUMENTS

JAA documents are available from the JAA publisher Information Handling Services (IHS). Information on prices, where and how to order is available on the JAA website and at [www.avdataworks.com](http://www.avdataworks.com)).

EUROCAE documents may be purchased from EUROCAE, 17 rue Hamelin, 75783 Paris Cedex 16, France, (Fax: 33 1 45 05 72 30). Web site: [www.eurocae.org](http://www.eurocae.org)

FAA documents may be obtained from Department of Transportation, Subsequent Distribution Office SVC-121.23, Ardmore East Business Centre, 3341 Q 75th Avenue, Landover, MD 20785, USA. Web site [www.faa.gov](http://www.faa.gov)

RTCA documents may be obtained from RTCA Inc, 1828 L Street, NW., Suite 805, Washington, DC 20036, USA., (Tel: 1 202 833 9339; Fax 1 202 833 9434). [Web site www.rtca.org](http://www.rtca.org)

ICAO documents may be purchased from Document Sales Unit, International Civil Aviation Organisation, 999 University Street, Montreal, Quebec, Canada H3C 5H7, (Fax: 1 514 954 6769, e-mail: [sales\\_unit@icao.org](mailto:sales_unit@icao.org)) or through national agencies.

ARINC documents may be purchased from ARINC Incorporated; Document Section, 2551 Riva Road, Annapolis, MD 21401-7465, USA, web site [www.ARINC.com](http://www.ARINC.com)

[Amdt 20/1]

## AMC 20-13

### AMC 20-13 Certification of Mode S Transponder Systems for Enhanced Surveillance

*ED Decision 2006/012/R*

#### 1 PREAMBLE

Operating regulations require that an operator shall not operate an aircraft unless it is equipped with;

- (1) a pressure altitude reporting SSR transponder; and
- (2) any other SSR transponder capability required for the route being flown.

In accordance with the European Air Traffic Management Plan, the implementation of Enhanced Surveillance requires aircraft to have the capability to down-link aircraft derived data via a Mode S transponder.

#### 2 PURPOSE

2.1 This AMC has been prepared to provide guidance for the installation, certification and maintenance of Mode S SSR transponder systems for Enhanced Surveillance. It provides a method by which equipment installers and aircraft operators can satisfy an authority that the transponder capability required by airspace regulations has been addressed. This AMC is not mandatory and does not constitute a regulation. In lieu of following this method without deviation, an alternative method may followed provided it is found by the responsible authority to be in compliance with applicable airworthiness certification specifications, operational and airspace requirements This document does not change, create, authorise, or permit deviations from, regulatory requirements.

2.2 Where required, the units of measurement used in this document are in accordance with the International System of Units (SI) specified in Annex 5 to the Convention on International Civil Aviation. Non-SI units are shown in parentheses following the base units. Where two sets of units are quoted, it should not be assumed that the pairs of values are equal and interchangeable. It may be inferred, however, that an equivalent level of safety is achieved when either set of units is used exclusively.

#### 3 SCOPE

This AMC addresses only the Mode S transponder for Enhanced Surveillance purposes used in conjunction with interrogating ground stations. It does not deal with Mode S elementary surveillance, or automatic dependent surveillance (ADS-B or ADS-C), or the use of the transponder as a data link component of the Aeronautical Telecommunication Network (ATN), or security aspects relating to unlawful interference with aircraft operation.

#### 4 REFERENCE MATERIAL

##### 4.1 JAA/EASA

- (a) EASA ETSO-2C112b, Minimum Operational Performance Specification for SSR Mode S Transponders. (adopts EUROCAE ED-73B,).
- (b) JAA JTSO-C112A, EASA ETSO-2C112a, Minimum Operational Performance Specification for SSR Mode S Transponders. (Adopts EUROCAE ED-73A).

- (c) EASA AMC 20-18 Certification of Mode S Transponder Systems for Elementary Surveillance
- (d) JAR-OPS 1: Amendment 6: 1.845 and 1.866 and associated AMCs.
- (e) JAR-OPS 3: Amendment 2: 3.845, 3.860, 3.865, and associated AMCs.
- (f) JAR-OPS 1/3: MEL Policy Document.
- (g) EASA Certification Specifications CS-23, CS-25, CS-27, and CS-29, as applicable.

#### 4.2 FAA

- (a) FAR 121.345, Radio equipment.
- (b) TSO-C112, 1986, (Based on RTCA DO-181). This standard of transponder does not provide the full functionality required for the European Region. However, the RTCA document has been updated to DO-181C that defines an acceptable standard. It is expected that the FAA TSO will be updated to reflect this standard.
- (c) FAR 25, 25, 27 and FAR 29 as applicable.

#### 4.3 EUROCONTROL

- (a) Document SUR.ET2.ST02.1000-CNP-01-00, Edition 2, Nov 1996 The Concept of Operations - Mode S in Europe.
- (b) Document (Mode S/OHA/001) Edition 1.1, April 2004, Operational Hazard Assessment of Elementary & Enhanced Surveillance.
- (c) Document Mode S/SAF/002, Edition 1.1, dated April 2004, Preliminary System Safety Analysis for the Controller Access Parameter Service delivered by Mode S Enhanced Surveillance.
- (d) Document SUR/Mode S/ES 3SP MP, Edition 1.0, 30 August 2002, Mode S Three States Project Master Plan.
- (e) Document SUR-EHS/02-001, Edition 2.0, July 2003, Common Framework for the Regulation of Mode S Enhanced Surveillance.

#### 4.4 ICAO

- (a) Annex 10, Amd. 77, Aeronautical Communications (Digital Data Communication Systems), Volume III, July 2002.
- (b) Annex 10, Amd. 77, Aeronautical Communications (Surveillance Radar and Collision Avoidance Systems), Volume IV, July 2002.
- (c) Manual of the Secondary Surveillance Radar System, Doc 9684, Third Edition 2004.
- (d) EUR Regional Supplementary Procedures, ICAO Doc 7030/4, as amended.

#### 4.5 EUROCAE

- (a) Minimum Operational Performance Specification for SSR Mode S Transponders, ED-73B, January 2003.
- (b) Minimum Operational Performance Specification for SSR Mode S Transponders, ED-73A, February 1999.
- (c) Minimum Operational Performance Specification for Aircraft Data Link Processors, ED-82A, November 1999.

- (d) Minimum Operational Performance Specification for Mode S Specific Service Applications, ED-101, September 2000.
- (e) Minimum Operational Performance Specification for Light Aviation SSR Transponder, ED-115, August 2002

#### 4.6 RTCA

- (a) Minimum Operational Performance Specification for Air Traffic Control Radar Beacon System/ Mode Select (ATCRBS/Mode S) Airborne Equipment, RTCA DO-181C, June 2001.
- (b) Minimum Operational Performance Specification for the Mode S Airborne Data Link Processor, RTCA DO-218B, June 2001

#### 4.7 ARINC

- (a) Mark 4 Air Traffic Control Transponder (ATCRBS/MODE S), ARINC 718A-1, March 2004

## 5 ASSUMPTIONS

5.1 Applicants should note that this AMC takes account of EUROCONTROL document, Mode S/OHA/001, Operational Hazard Assessment of Elementary and Enhanced Surveillance (reference 4.3.b), and is based on the following assumptions concerning the proposed use of aircraft derived data by the air traffic services:

- (a) The data is intended for display to the air traffic controller (referred to as controller accessed parameters (CAPs)) and that means are implemented, where appropriate, by the air traffic services to verify the validity of received data (e.g. as currently performed by means of the ICAO required controller-pilot verification procedure for the altitude report).
- (b) A safety review is performed to identify the measures needed to confirm an acceptable level of integrity for aircraft derived data, prior to such data being used by the ATC systems (referred to as system accessed parameters (SAPS)) such as safety nets.
- (c) Loss of any parameter is readily detectable by the air traffic controller and/or the ATC system (as applicable).
- (d) The Air Traffic Service Provider supplements the Preliminary System Safety Analysis (reference 4.3(c)) with such additional studies and mitigation as may be necessary to comply with EUROCONTROL Safety and Regulatory Requirements (ESARR) for the introduction of Mode S Enhanced Surveillance.

5.2 On this basis, for the purposes of system certification, Failure Conditions involving lost or erroneous aircraft derived data can be classified as shown in [Annex 1](#), table 2 of this AMC.

5.3 Enhanced Surveillance is not applicable to helicopters. They are only required to install Elementary Surveillance. This does not preclude a helicopter from voluntary installation of Enhanced Surveillance.

## 6 SYSTEM DESCRIPTION

6.1 The transponder Level is defined by ICAO and identifies the communication protocol capabilities of the transponder.

Level 1 This is the basic transponder permitting surveillance based on Modes A and C as well as Mode S. With a Mode S aircraft address, it has the minimum features for

compatible operation with the Mode S system. It has no data communication capability, is not prescribed for international flights, and does not satisfy the European requirement.

Level 2 has the capabilities as Level 1 but permits standard length digital communication from ground to air and air to ground using Comm A and Comm B protocols. It includes automatic aircraft identification reporting.

Level 3 has the capabilities as level 2 but permits extended data communications from the ground to the aircraft using the Comm C protocol. The usefulness of this standard of transponder has been largely overtaken by technological advances.

Level 4 has the capabilities as level 3 but permits extended data communications from the aircraft to the ground using the Comm D protocol.

Level 5 extends these protocols to permit Comm B and extended length and simultaneous data communications with multiple interrogators. This level of transponder has a higher minimum data communication capability than transponders of lower levels.

In addition to the above designations, the letters “e” and “s” are added to indicate that the transponder includes extended squitter functionality and surveillance interrogator (SI) code capability.

Basic functionality with SI code capability is the minimum level permitted for operations in European airspace hence the transponder required is designated ICAO Level 2s. (Amd 77 to ICAO Annex 10, Vol IV, paragraph 2.1.5.1.7).

- 6.2 The transponder Mark is assigned by ARINC/ EUROCAE and defines required equipment characteristics for the interface between the transponder and other aircraft systems. Equipment characteristics have the objective of standardising those aspects of equipment design which affect interchangeability between different brands.

Mark 3 corresponds to ARINC Characteristic 718.

Mark 4 corresponds to the ARINC Characteristic 718A. This standard of equipment includes extended interface functions which provide for the access of aircraft derived data necessary to fulfil the functions of automatic dependent surveillance -broadcast (ADS-B), extended (112 bit) squitter functions for passive surveillance, the surveillance capabilities specified in the ICAO Manual on Mode S Specific Services, and dedicated communication functions.

Notes:

1. The Mark 4 transponder does not support altitude data in Gillham’s code format and is not backward compatible with the Mark 3 equipment.
  2. Compliance with an ARINC Characteristic is not required for certification.
- 6.3 A detailed technical definition of the aircraft derived data is given in Amd 77 to ICAO Annex 10, Vol III, Part 1, Appendix 1 to Chapter 5, ‘Tables for Section 2’.

## **7 AIRWORTHINESS CERTIFICATION OBJECTIVES**

- 7.1 For the purposes of certification of an installed transponder system for Enhanced Surveillance, the demonstration of intended function (CS-25.1301) will need to be shown that, except as permitted by the Coordinated Exemptions Policy, aircraft derived data can be transmitted to meet the objectives of the Common Framework (reference 4.3(e)).

Note: The Coordinated Exemptions Policy is determined by the responsible airspace authorities and managed by EUROCONTROL in accordance with the Guidance Material of

Reference 4.3(e). Further advice may be obtained by contacting the Mode S Exemptions Coordination Cell at [www.eurocontrol.int/mode\\_s](http://www.eurocontrol.int/mode_s) or [modes.reg@eurocontrol.int](mailto:modes.reg@eurocontrol.int).

- 7.2 The minimum required characteristics of aircraft derived data are shown in Table 1 of [Annex 1](#) to this AMC. Similarly, the criticality classifications of the data that need to be met are shown in Table 2. These classifications take account of the assumptions of Section 5, and correspond with the definitions of EASA Certification Specification CS-25.1309 and associated AMC.

## 8 FUNCTIONAL CRITERIA

- 8.1 The Enhanced Surveillance functionality will need to ensure, through Ground Initiated Comm-B (GICB) protocols as defined in ICAO Annex 10 (Amendment 77), Volume III, Part 1, Appendix to Chapter 5, the extraction and transmission of information contained in the following standardised transponder registers (designated by BDS x, y and which may be composed of up to 4 different aircraft data):

BDS Register	Contents of BDS Register
a) BDS 6,0	Heading and Speed report
b) BDS 5,0	Track and Turn report
c) BDS 4,0	Selected vertical intention

- 8.2 As a minimum, unless a specific exemption has been granted, the data transmitted for Mode S Enhanced Surveillance will need to be:

- |    |                                       |   |
|----|---------------------------------------|---|
| a) | BDS 6,0 (Heading and Speed Report)    | Magnetic heading<br>Indicated airspeed<br>Mach no.<br>Vertical rate (Barometric rate of climb/descend or baro-inertial) |
| b) | BDS 5,0 (Track and Turn Report)       | Roll angle<br>Track angle rate (or True Airspeed – see Note 2)<br>True track angle<br>Ground speed                      |
| c) | BDS 4,0 (Selected Vertical Intention) | Selected altitude   |

### Notes:

1. For aircraft that require ACAS II, the Resolution Advisory Report will need to be transmitted also by the transponder (ICAO Annex 10, Volume IV) in BDS 3.0.
  2. See Table 1 of [Annex 1](#) for further details relating to the data requirements.
- 8.3 The transponder capability report, as defined in ICAO Annex 10, Volume IV, 3.1.2.6.10.2 and Volume III, Part 1, Appendix to Chapter 5, 2.5.4, will need to be updated to reflect the Enhanced Surveillance capability as implemented and supported in the aircraft. The affected BDS to be appropriately filled are: BDS 1,0; BDS 1,7; BDS 1,8 to 1,C; and BDS 1,D to 1,F. For implementations not supporting MSP services, the correct servicing of register 1,D to 1,F corresponds to at least transmitting 0 in response to extraction of these registers. In such case the setting of the bits corresponding to BDS 1,D to 1,F in BDS 1,8 may be accepted either as being 1 or 0.

## 9 ACCEPTABLE MEANS OF AIRWORTHINESS COMPLIANCE

- 9.1 The criteria for Mode S Elementary Surveillance will need to be satisfied prior to, or concurrently with, the certification tasks for Enhanced Surveillance.



- 9.2 The Mode S Transponder will need to be approved in accordance with EASA European Technical Standard Order ETSO-2C112b, or an equivalent standard that is consistent with applicable ICAO SARPS and which is acceptable to the responsible certification authority. The transponder manufacturer should state in their Declaration of Design and Performance (DDP) whether or not they are fully compliant with the requirements of ED-73B, ED-82A and ICAO Annex 10 amendment 77.

Note: Transponders approved to ETSO-2C112a or ETSO-2C112a may be acceptable if they are fully compliant with ED-73B, ED-82A and ICAO Annex 10 amendment 77. Compliance should be stated in the transponder DDP.

- 9.3 For the processing of data parameters, information may be found in EUROCAE Minimum Operational Performance Specification for Aircraft Data Link Processors, ED-82A, November 1999. This specification is applicable to the processing within a Mark 4 transponder, or, to the processing within an Aircraft Data Link Processor or equivalent when this function is performed separately from the transponder.

- 9.4 When demonstrating compliance with this AMC, the following specific points should be noted:

- (a) The applicant will need to submit, to the responsible authority, a compliance statement that shows how the criteria of this AMC have been satisfied, together with evidence resulting from the activities described in the following paragraphs.
- (b) Compliance with the airworthiness certification specifications for intended function and safety may be demonstrated by equipment qualification, safety analysis of the interface between the transponder and data sources, equipment cooling verification, and ground tests. To support the approval application, design data will need to be submitted showing that the objectives and criteria of Sections 7 and 8 of this AMC have been satisfied.
- (c) The safety analysis of the interface between the transponder and its data sources should show no unwanted interaction under normal or fault conditions.

- 9.5 On the assumption that the transponder installation has been shown to meet the existing criteria for Modes A, and C, Elementary Surveillance, and ACAS II, then the additional functionality introduced for Enhanced Surveillance may be demonstrated by ground testing, using ramp test equipment where appropriate, that verifies:

- correct system operation;
- that the aircraft derived data in the transmitted response, including the 24-bit aircraft address; and
- correct functioning of system fault detectors.

- 9.6 To minimise the certification effort for transponder follow-on installations, the applicant may claim from the responsible authority, credit for applicable certification and flight test data obtained from equivalent aircraft installations.

- 9.7 Dual transponder and Dual sensors side installation

Particular attention should be given to the interface between dual (or more than 2 transponders) and dual or multiple sensors. In this context, 'sensors' refers to FMS, IRS, AHRS, ADS, GPS, or Data Concentrator (or other) systems used to provide data to the transponder.

### Transponder Selection:

Appropriate means should be provided for the flight crew to select the active transponder at any given time. At all times, the active transponder should be selected such that it operates as either the captain's side or the co-pilot's side transponder. This is an important consideration when more than 2 transponders are available to the crew.

### Sensor Selection:

In an installation where crew sensor selection capability for the active transponder is provided, the crew should be aware, at all times, which sensors (captain's or co-pilots side) are providing information to the active transponder. The selected active transponder should use the crew selected sensor relevant to the aircraft flight profile.

Note 1: In a 'standard' installation, where crew sensor selection for the active transponder is not provided, the captain's side transponder should utilise the captain's side sensors and the co-pilot's side transponder should utilise the co-pilot's side sensors.

Note 2: It is important to note that data parameters from different sensors, of the same type, should not be mixed. For example, Mode-C or Mode-S altitude reporting information from ADC source #1 should not be mixed with reporting of TAS, Baro Vertical Rate, Mach from ADC source #2. In this case partially blocking of data output from either ADC source #1 or #2 will cause uncorrelated results. This could result in problems with ATC ground processing of the data.

- 9.8 Where only single sensors are available (i.e. single FMS) it is permissible to connect the single sensor to both transponders. It should be noted that this may result in reduced operational availability of the transponder function should the single sensor fail.
- 9.9 Guidance on the classification (minor or major change) are stated in GM 21.A.91. Table 3, Annex 1 of this AMC offers additional guidance for the classification of Elementary and Enhanced Surveillance modifications.
- 9.10 An aircraft is considered to be 'EHS capable' if the full list of 8 Downlink Aircraft Parameters, as detailed in Table 1, [Annex 1](#), can be transmitted to the ATC ground system.

Note: Table 1 lists 9 parameters, however Indicated Airspeed and Mach No. may be considered as a single DAP and either parameter may be supplied. If an aircraft can provide both, it should do so.

## **10 FLIGHT MANUAL**

- 10.1 The Aircraft Flight Manual (AFM) or the Pilot's Operating Handbook (POH), whichever is applicable, should provide at least the following information.
- A statement of compliance that the transponder system(s) comply with the criteria of ICAO Doc 7030/4 Regional Supplementary Procedures for operations where Enhanced Surveillance is required.
- 10.2 The Limitations Section should identify those parameters that, at the time of certification, the transponder are unable to transmit due to the installation configuration, as permitted by the Coordinated Exemptions Policy.
- Note: [Annex 2](#) provides a template for an AFM Supplement.
- 10.3 In the absence of, or as an alternative to, information in the AFM, appropriate information may be given in the Operations Manual.

## 11 MINIMUM EQUIPMENT LIST

The MEL will need to be revised to indicate the mandatory carriage of a serviceable system to meet applicable operational requirements for flight in designated airspace. Despatch with partial unserviceability of the system, or non-availability of some required aircraft derived data, may be permitted in accordance with the Coordinated Exemptions Policy (see Section 7).

## 12 GROUND TESTING

12.1 All the BDS registers containing data as defined in Table 1, [Annex 1](#), should be tested to ensure correct data is received and transmitted by the Mode S transponder.

12.2 The rate parameters are particularly difficult to measure statically. To ensure that the rate parameters are correctly received and transmitted by the transponder it is acceptable to test that the correct BDS register is transmitted (by the transponder) and that the parameter value is valid and set to zero.

Where a parameter is not available, and therefore not provided to the transponder, it is acceptable to test that the correct BDS register is transmitted and that the parameter is declared invalid in the reply to the appropriate interrogation. This will prove that the BDS register is received by the Mode S ground test set and declared invalid.

12.3 Other parameters listed in Table 1 [Annex 1](#), which are derived from an Inertial Reference System, may also be difficult to measure statically, i.e. Ground Speed. A similar method as described in paragraph 12.2 may be used.

12.4 A test should be performed to ensure that the transponder:

- i. does not respond to an 'All Call' interrogation (Mode A/C/S all-call and Mode S only all-call) when on ground, and
- ii. does respond when interrogated with its Mode S aircraft address when on ground, and
- iii. does provide DF-11 Acquisition Squitter transmissions in the air (on ground acquisition squitter is replaced by extended squitter DF-17, when enabled).

These tests are required to ensure that the transponder reacts correctly to the on ground condition.

Note: These tests are not required if they were conducted as part of the Mode S Elementary Surveillance ground testing.

12.5 The Mode S transponder system(s) should be tested to ensure it has no effect on other aircraft systems. Similarly, testing should ensure that the aircraft systems have no effect on the Mode S transponder system(s).

## 13 FLIGHT TESTING

No specific flight testing is required assuming a full ground test of all the parameters listed in Table 1, [Annex 1](#), is performed. Installation of Mode S antenna's not previously approved, may require a flight test to ensure adequate performance of the antenna's in the new position. The Agency should be contacted to define the level of flight testing required for adequate performance.

## 14 MAINTENANCE

14.1 Maintenance testing of altitude reporting transponders should be suitably screened to minimise the risk of nuisance traffic or collision resolution advisories in operating aircraft. When performing transponder testing which involves the use of the altitude changes, it

is advisable to ensure the transponder is in ‘standby’ or ‘off’ whilst the air data system is set to the required altitude. The transponder should only be operated during the testing phase to minimise the risk of interference with other aircraft. Following completion of the testing, the transponder should be returned to ‘standby’ or ‘off’. The air data system may then be returned to atmospheric pressure. Note: Before performing any transponder testing involving altitude changes the local Air Traffic Controller should be contacted and a ‘safe test altitude(s)’ agreed.

- 14.2 Maintenance tests should include a periodic verification check of aircraft derived data including the ICAO 24 bit aircraft address using suitable ramp test equipment. The check of the aircraft address should be made also in the event of a change of state of registration of the aircraft.
- 14.3 Where possible, maintenance tests should check the correct functioning of system fault detectors.
- 14.4 Maintenance tests for encoding altitude sensors with Gillham’s code output should be based on the transition points defined in EUROCAE ED-26, Table 13. (Included as [Annex 3](#) to this guidance material).

## 15 AVAILABILITY OF DOCUMENTS

JAA documents are available from the JAA publisher Information Handling Services (IHS). Information on prices, where and how to order is available on the JAA website and at [www.avdataworks.com](http://www.avdataworks.com). JAA documents transposed to publications of the European Aviation Safety Agency (EASA) are available on the EASA web site [www.easa.europa.eu](http://www.easa.europa.eu)

EUROCAE documents may be purchased from EUROCAE, 17 rue Hamelin, 75783 Paris Cedex 16, France, (Fax: 33 1 45 05 72 30). Web site: [www.eurocae.org](http://www.eurocae.org)

FAA documents may be obtained from Department of Transportation, Subsequent Distribution Office SVC-121.23, Ardmore East Business Centre, 3341 Q 75<sup>th</sup> Avenue, Landover, MD 20785, USA. Web site [www.faa.gov](http://www.faa.gov)

RTCA documents may be obtained from RTCA Inc, 1828 L Street, NW., Suite 805, Washington, DC 20036, USA., (Tel: 1 202 833 9339; Fax 1 202 833 9434), Web site [www.rtca.org](http://www.rtca.org)

ICAO documents may be purchased from Document Sales Unit, International Civil Aviation Organisation, 999 University Street, Montreal, Quebec, Canada H3C 5H7, (Fax: 1 514 954 6769, e-mail: [sales\\_unit@icao.org](mailto:sales_unit@icao.org) or through national agencies.

ARINC documents may be purchased from ARINC Incorporated; Document Section, 2551 Riva Road, Annapolis, MD 21401-7465, USA, web site [www.ARINC.com](http://www.ARINC.com)

## 16 List of Abbreviations

ACAS	Airborne Collision Avoidance System
ADS	Air Data System
ADS-B	Automatic Dependent Surveillance – Broadcast
ADS-C	Automatic Dependent Surveillance – Contract
AFM	Aircraft Flight Manual
AHRS	Attitude, Heading and Reference System
ATC	Air Traffic Control
ATN	Aeronautical Telecommunication Network
BDS	Comm B Data Selector
CAPs	Controller Accessed Parameters

CNS-ATM	Communication, Navigation & Surveillance – Air Traffic Management
CS	Certification Specification
DAP	Downlinked Aircraft Parameter
EASA	European Aviation Safety Agency
ED	Eurocae Document
EHS	Enhanced Surveillance
ELS	Elementary Surveillance
ETSO	European Technical Standard Order
ESARR	Eurocontrol Safety and Regulatory Requirements
FAR	Federal Airworthiness Requirements
FMS	Flight Management System
GAT	General Air Traffic
GPS	Global Positioning System
ICAO	International Civil Aviation Organisation
IFR	Instrument Flight Rules
IRS	Inertial Reference System
JAA	Joint Aviation Authorities
JAR	Joint Airworthiness Requirements
JTSO	JAA Technical Standard Order
MSSS	Mode S Specific Services
MEL	Minimum Equipment List
MCP	Management Control Panel
NPA	Notice of Proposed Amendment
POH	Pilot's Operating Handbook
FCU	Flight Control Panel
SAPS	System Accessed Parameters
SSR	Secondary Surveillance Radar
TAS	True Airspeed
TGL	Temporary Guidance Material
TMA	Terminal Manoeuvring Area
TSO	Technical Standard Order
WOW	Weight on Wheels

[Amdt 20/1]

## Annex 1 to AMC 20-13

ED Decision 2006/012/R

**Table 1: Minimum Required Characteristics of Aircraft Derived Data for Enhanced Surveillance**

Item	Parameter	Range	Minimum Resolution	Accuracy Limits	Remarks
5	Magnetic Heading	-180, +180 degrees	90/512	As installed sensor	BDS Register 6,0
6	Indicated Airspeed (Note 9)	As installed sensor	1 kt	As installed sensor	BDS Register 6,0
7	Mach No. (Note 9)	As installed sensor	2.048/512	As installed sensor	BDS Register 6,0
8	Vertical Rate	-4994, +4984m/minute (-16384, +16352 ft/minute)	8192/256	As installed sensor	BDS Register 6,0
9	Roll Angle	-90, +90 degrees	45/256	As installed sensor	BDS Register 5,0
10	Track Angle Rate (Note 8)	-16, +16 degrees/second	8/256	As installed sensor	BDS Register 5,0
11	True Track Angle	-180, +180 degrees	90/512	As installed sensor	BDS Register 5,0
12	Ground Speed	As installed sensor	2 kt	As installed sensor	BDS Register 5,0
13	Selected Altitude	As installed sensor	5m (16ft)	See notes 5 & 6	BDS Register 4,0

Notes:

- See JAA TGL 13 for details of parameters 1 through 4.
- The minimum parameter characteristics shown above are applicable to the data source and need to be maintained through any intermediate data processing systems until delivered to the transponder.
- The required characteristics of the transponder BDS registers are defined in Amd 77 to ICAO 10, Vol III, Part 1, Chapter 5, Appendix 1, 'Tables for Section 2'.
- Where reference is made to "As installed sensor", this should be interpreted to mean either the primary system used to fly the aircraft, or an approved system of equivalent performance and capability.
- The value of Selected Altitude, transmitted by the transponder, will need to correspond within +/-8m (+/- 25ft) to the value displayed to the flight crew or the associated output to the flight control/guidance system.
- The Selected Altitude data to be provided by BDS 4,0 is the "MCP/FCU SELECTED ALTITUDE" (bits 2-13), together with bit 1 (STATUS), and bits 48 to 51, set as described in the register definition. In addition, where readily available, Barometric Pressure Setting in bits 28 to 40 of BDS 4,0 should be provided as defined in Annex 10, Table 2-64 BDS 4,0. The transponder subtracts 800 mb from the Barometric Pressure Setting prior to loading into the register.

- 7 The transponder capability report, as defined in ICAO Annex 10, Vol IV, 3.1.2.6.10.2 and Vol III, Part 1, Appendix to Chapter 5, 2.5.4, will need to reflect the enhanced surveillance capability, as implemented and supported in the aircraft. The affected BDS to be appropriately filled are: - BDS 1,0; BDS 1,7; BDS 1,8 to 1,C; and BDS 1,D to 1,F.
- 8 If the Track Angle Rate parameter, as defined in the ARINC 429 data bus specification, Label 335, cannot be readily provided because the aircraft configuration is based on the GAMA 429 specification then 'True Airspeed' (TAS) should be substituted. If the aircraft is supplying TAS then ARINC Label 335 should not be transmitted.
- 9 Indicated Airspeed and Mach No. are considered as a single DAP. If an aircraft can provide both, it should do so.

**Table 2: Failure Condition Categories of Aircraft Derived Data for Enhanced Surveillance**

1. The Failure Condition categories listed here assume that aircraft derived data are used only as air traffic controller accessed parameters (CAP) and are subject to a correspondence check by means of radio communication with the pilot, or verification by the end user by other equivalent means. It is assumed also, that loss of any parameter is readily detectable by the air traffic controller and ATC system (if applicable). Aircraft derived data used as system accessed parameters (SAPs) for air traffic safety nets involving automated processing may require higher levels of integrity yet to be established. In anticipation of increasing reliance by the air traffic services on automatic processing of data for safety nets, the aircraft system should be designed such as to provide, so far as is practicable, data of high accuracy, high availability and high integrity.
2. Use of aircraft derived data for other purposes such as Automatic Dependent Surveillance - Broadcast, is expected to require data meeting more demanding availability and integrity criteria. Designers of Mode S systems are strongly recommended to take account of such expectations.
3. The Failure Condition categories listed here take account of advice from EUROCONTROL based on safety analyses to support Enhanced Surveillance. (See reference documents 4.3 (b) and (c)).

Parameter	Loss of Parameter	Undetected Erroneous Parameter
Magnetic Heading	Minor	Minor
Indicated Airspeed	Minor	Minor
Mach No.	Minor	Minor
Vertical Rate	Minor	Minor
Roll Angle	Minor	Minor
Track Angle Rate (or True Airspeed)	Minor	Minor
True Track Angle	Minor	Minor
Groundspeed	Minor	Minor
Selected Altitude (including Barometric Pressure Setting)	Minor	Minor

**Table 3 Examples of Modification Classification for Mode S Elementary & Enhanced Surveillance Aircraft Installations**

Mass of Aircraft	Is Cruising TAS > 250 kts?	Elementary & Enhanced Surveillance?	Pressurised Yes/No	Example No.	Proposed Classification (Major /Minor Change)	Reason/Justification for Classification
Less than 5700 Kgs	No	Elementary Surveillance only required	No	1	Minor	Assuming a simple replacement of existing transponder and no antenna change.
				2	Major	STC required to install ModeS transponder on aircraft where no transponder was previously fitted. Consideration should be given to antenna location and flight test may be required to ensure adequate antenna performance
				3	Major	If Mode S transponder is elementary and enhanced capable and 'enhanced' parameters are loaded into transponder (due to connection to an ADC – transponder will also strip off ARINC 429 labels required for enhanced surveillance) then a Flight Manual Supplement or Pilot's Operating Handbook Supplement should be raised to record which 'enhanced' parameters are downloaded – See NPA 20-12b.
			Yes	4	Major	If Mode S transponder is elementary and enhanced capable and 'enhanced' parameters are loaded into transponder (due to connection to an ADC – transponder will also strip off ARINC 429 labels required for enhanced surveillance) then a Flight Manual Supplement or Pilot's Operating Handbook Supplement should be raised to record which 'enhanced' parameters are downloaded – See NPA 20-12b.
				5	Minor	Assuming a simple replacement of existing Mode A/C transponder and no antenna location change the modification may be classed as minor.
Yes	Elementary & Enhanced Surveillance Required (antenna diversity also required)	Either pressurised or un-pressurised	6	Major	Major change because of Flight Manual Supplement and potential technical complexity	
More than 5700 kgs	No	Elementary & Enhanced Surveillance Required (antenna diversity also required)	Either pressurised or un-pressurised	7	Major	Major change because of Flight Manual Supplement and potential technical complexity
	Yes			8	Major	Major change because of Flight Manual Supplement and potential technical complexity

[Amdt 20/1]



## Annex 2 to AMC 20-13 Template for Aircraft Flight Manual (AFM) Supplement

ED Decision 2006/012/R

(Aircraft Type) Flight Manual [or POH as appropriate] Reference (XXXX)

**(Company Name)**

**FLIGHT MANUAL SUPPLEMENT (1) ISSUE (1)**

Registration Mark: \_\_\_\_\_ Serial Number: \_\_\_\_\_

SSR MODE S ENHANCED SURVEILLANCE

Modification Number (XXXX)

**ADDITIONAL LIMITATIONS AND INFORMATION**

The limitations and information contained herein either supplement or, in the case of conflict, override those in the flight manual.

**LIMITATIONS**

- 1 The installed Mode S system satisfies the data requirements of ICAO Doc 7030/4, Regional Supplementary Procedures for SSR Mode S Enhanced Surveillance in designated European airspace. The capability to transmit data parameters is shown in column 2: [mark as applicable]:

Parameter	Available/Not Available
Magnetic Heading	
Indicated Airspeed	
Mach No	
Vertical Rate	
Roll Angle	
Track Angle Rate / True Airspeed *	
True Track Angle	
Groundspeed	
Selected Altitude	
Barometric Pressure Setting	

To be inserted in the flight manual and record sheet amended accordingly.

Page 1 of (X)

Authority Approval:

Date:

*[\*delete as applicable]*

[Amdt 20/1]

## Annex 3 to AMC 20-13 Extract from EUROCAE Document ED-26: Table 13: Altitude Encoding Transition Points

ED Decision 2006/012/R

Nominal Transition Altitude (feet)	Transition Pulse	Enabled Information Pulses										
		D <sub>2</sub>	D <sub>4</sub>	A <sub>1</sub>	A <sub>2</sub>	A <sub>4</sub>	B <sub>1</sub>	B <sub>2</sub>	B <sub>4</sub>	C <sub>1</sub>	C <sub>2</sub>	C <sub>4</sub>
-950	C <sub>1</sub>										1	
										1	1	
-850	C <sub>2</sub>									1	1	
										1		
-750	B <sub>4</sub>									1		
									1	1		
-450	C <sub>4</sub>										1	
									1		1	1
-250	B <sub>2</sub>											1
									1	1		1
750	B <sub>1</sub>											1
									1	1		1
2750	A <sub>4</sub>											1
									1	1		1
6750	A <sub>2</sub>											1
									1	1		1
14750	A <sub>1</sub>											1
												1
30750	D <sub>4</sub>											1
												1
62750	D <sub>2</sub>											1
												1
		1	1									1

[Amdt 20/1]

## AMC 20-20

### AMC 20-20 Continuing Structural Integrity Programme

*ED Decision 2007/019/R*

#### 1. PURPOSE

- a) This Acceptable Means of Compliance (AMC) provides guidance to type-certificate holders, STC holders, repair approval holders, maintenance organisations, operators and competent authorities in developing a continuing structural integrity programme to ensure safe operation of ageing aircraft throughout their operational life, including provision to preclude Widespread Fatigue Damage.
- b) This AMC is primarily aimed at large aeroplanes that are operated in Commercial Air Transport or are maintained under Part-M. However, this material is also applicable to other aircraft types.
- c) The means of compliance described in this document provides guidance to supplement the engineering and operational judgement that must form the basis of any compliance findings relative to continuing structural integrity programmes.
- d) Like all acceptable means of compliance material, this AMC is not in itself mandatory, and does not constitute a requirement. It describes an acceptable means, but not the only means, for showing compliance with the requirements. While these guidelines are not mandatory, they are derived from extensive industry experience in determining compliance with the relevant requirements.

#### 2. RELATED REGULATIONS AND DOCUMENTS

- a) Implementing Rules and Certification Specifications:
  - Part 21.A.61 Instructions for continued airworthiness.
  - Part 21.A.120 Instructions for continued airworthiness.
  - Part 21.A
  - Part 21.A.433 Repair design
  - Part M.A.302 Maintenance programme
  - CS 25.571 Damage-tolerance and fatigue evaluation of structure
  - CS 25.903 Engines
  - CS 25.1529 Instructions for continued airworthiness
- b) FAA Advisory Circulars
  - AC 91-60 The Continued Airworthiness of Older Airplanes, June 13, 1983, FAA.
  - AC 91-56A Continuing Structural Integrity for Large Transport Category Airplanes April 29 1998 FAA (and later draft 91-56B)
  - AC 20-128A Design Considerations for Minimising Hazards Caused by Uncontained Turbine Engine and Auxiliary Power Unit Rotor Failure, March 25, 1997, FAA.
  - AC 120 – 73 Damage Tolerance Assessment of Repairs to Pressurised Fuselages, FAA. December 14, 2000

AC 25.1529-1 Instructions for continued airworthiness of structural repairs on Transport Airplanes, August 1, 1991 FAA.

c) Related Documents

“Recommendations for Regulatory Action to Prevent Widespread Fatigue Damage in the Commercial Aeroplane Fleet,” Revision A, dated June 29, 1999 [A report of the Airworthiness Assurance Working Group for the Aviation Rulemaking Advisory Committee Transport Aircraft and Engine Issues.]

AAWG Final Report on Continued Airworthiness of Structural Repairs, Dec 1996.

ATA report 51-93-01 structural maintenance programme guidelines for continuing airworthiness May 1993.

AAWG Report on Structures Task Group Guidelines, Rev 1 June 1996

AAWG Report: Recommendations concerning ARAC taskings FR Doc.04-10816 Re: Aging Airplane safety final rule. 14 CFR 121.370a and 129.16

### **3. BACKGROUND**

Service experience has shown there is a need to have continuing updated knowledge on the structural integrity of aircraft, especially as they become older. The structural integrity of aircraft is of concern because such factors as fatigue cracking and corrosion are time-dependent, and our knowledge about them can best be assessed based on real-time operational experience and the use of the most modern tools of analysis and testing.

In April 1988, a high-cycle transport aeroplane en-route from Hilo to Honolulu, Hawaii, suffered major structural damage to its pressurised fuselage during flight. This accident was attributed in part to the age of the aeroplane involved. The economic benefit of operating certain older technology aeroplanes has resulted in the operation of many such aeroplanes beyond their previously expected retirement age. Because of the problems revealed by the accident in Hawaii and the continued operation of older aircraft, both the competent authorities and industry generally agreed that increased attention needed to be focused on the ageing fleet and on maintaining its continued operational safety.

In June 1988, the FAA sponsored a conference on ageing aircraft. As a result of that conference, an ageing aircraft task force was established in August 1988 as a sub-group of the FAA's Research, Engineering, and Development Advisory Committee, representing the interests of the aircraft operators, aircraft manufacturers, regulatory authorities, and other aviation representatives. The task force, then known as the Airworthiness Assurance Task Force (AATF), set forth five major elements of a programme for keeping the ageing fleet safe. For each aeroplane model in the ageing transport fleet these elements consisted of the following:

- a) Select service bulletins describing modifications and inspections necessary to maintain structural integrity;
- b) Develop inspection and prevention programmes to address corrosion;
- c) Develop generic structural maintenance programme guidelines for ageing aeroplanes;
- d) Review and update the Supplemental Structural Inspection Documents (SSID) which describe inspection programmes to detect fatigue cracking; and
- e) Assess damage-tolerance of structural repairs.

Subsequent to these 5 major elements being identified, it was recognised that an additional factor in the Aloha accident was widespread fatigue cracking. Regulatory and Industry experts

agreed that, as the transport aircraft fleet continues to age, eventually Widespread Fatigue Damage (WFD) is inevitable. Therefore the FAA determined, and the EASA concurred, that an additional major element of WFD' must be added to the Ageing Aircraft programme. Structures Task Groups sponsored by the Task Force were assigned the task of developing these elements into usable programmes. The Task Force was later re-established as the AAWG of the ARAC. Although there was JAA membership and European Operators and Industry representatives participated in the AAWG, recommendations for action focussed on FAA operational rules which are not applicable in Europe. It was therefore decided to establish the EAAWG on this subject to implement Ageing Aircraft activities into the Agency's regulatory system, not only for the initial "AATF eleven" aeroplanes, but also other old aircraft and more recently certificated ones. This AMC is a major part of the European adoption and adaptation of the AAWG recommendations which it follows as closely as practicable.

It is acknowledged that the various competent authorities, type certificate holders and operators have continually worked to maintain the structural integrity of older aircraft on an international basis. This has been achieved through an exchange of in-service information, subsequent changes to inspection programmes and by the development and installation of modifications on particular aircraft. However, it is evident that with the increased use, longer operational lives and experience from in-service aircraft, there is a need for a programme to ensure a high level of structural integrity for all aircraft, and in particular those in the transport fleet. Accordingly, the inspection and evaluation programmes outlined in this AMC are intended to provide:

- a continuing structural integrity assessment by each type-certificate holder, and
- the incorporation of the results of each assessment into the maintenance programme of each operator.

#### 4. DEFINITIONS AND ACRONYMS

- a) For the purposes of this AMC, the following definitions apply:
- **Damage-tolerance (DT)** is the attribute of the structure that permits it to retain its required residual strength without detrimental structural deformation for a period of use after the structure has sustained a given level of fatigue, corrosion, and accidental or discrete source damage.
  - **Design Approval Holder (DAH)** is the holder of any design approval, including type certificate, supplemental type certificate or repair approval.
  - **Design Service Goal (DSG)** is the period of time (in flight cycles/hours) established at design and/or certification during which the principal structure will be reasonably free from significant cracking including widespread fatigue damage.
  - **Fatigue Critical Structure (FCS)** is structure that is susceptible to fatigue cracking that could lead to a catastrophic failure of an aircraft. For the purposes of this AMC, FCS refers to the same class of structure that would need to be assessed for compliance with § 25.571(a) at Amendment 25-45, or later. The term FCS may refer to fatigue critical baseline structure, fatigue critical modified structure, or both.
  - **Limit of validity (LOV)** is the period of time, expressed in appropriate units (e.g. flight cycles) for which it has been shown that the established inspections and replacement times will be sufficient to allow safe operation and in particular to preclude development of widespread fatigue damage.

- **Multiple Element Damage (MED)** is a source of widespread fatigue damage characterised by the simultaneous presence of fatigue cracks in similar adjacent structural elements.
- **Multiple Site Damage (MSD)** is a source of widespread fatigue damage characterised by the simultaneous presence of fatigue cracks in the same structural element (i.e., fatigue cracks that may coalesce with or without other damage leading to a loss of required residual strength).
- **Primary Structure** is structure that carries flight, ground, crash or pressurisation loads.
- **Repair Evaluation Guidelines (REG)** provide a process to establish damage-tolerance inspections for repairs that affect Fatigue Critical Structure.
- **Repair Assessment Programme (RAP)** is a programme to incorporate damage tolerance-based inspections for repairs to the fuselage pressure boundary structure (fuselage skin, door skin, and bulkhead webs) into the operator's maintenance and/or inspection programme.
- **Widespread Fatigue Damage (WFD)** in a structure is characterised by the simultaneous presence of cracks at multiple structural details that are of sufficient size and density whereby the structure will no longer meet its damage-tolerance requirement (i.e., to maintain its required residual strength after partial structural failure).

b) The following list defines the acronyms that are used throughout this AMC:

AAWG	Airworthiness Assurance Working Group
AC	Advisory Circular
AD	Airworthiness Directive
ALS	Airworthiness Limitations Section
AMC	Acceptable Means of Compliance
ARAC	Aviation Rulemaking Advisory Committee
BZI	Baseline Zonal Inspection
CPCP	Corrosion Prevention and Control Programme
CS	Certification Specification
DAH	Design Approval Holder
DSD	Discrete Source Damage
DSG	Design Service Goal
EAAWG	European Ageing Aircraft Working Group
EASA	European Aviation Safety Agency
ESG	Extended Service Goal
FAA	Federal Aviation Administration
FAR	Federal Aviation Regulation
FCBS	Fatigue Critical Baseline Structure
FCS	Fatigue Critical Structure
ICA	Instructions for Continued Airworthiness
ISP	Inspection Start Point
JAA	Joint Aviation Authorities
JAR	Joint Aviation Regulation
LDC	Large Damage Capability

LOV	Limit of Validity
MED	Multiple Element Damage
MRB	Maintenance Review Board
MSD	Multiple Site Damage
MSG	Maintenance Steering Group
NAA	National Airworthiness Authority
NDI	Non-Destructive Inspection
NTSB	National Transportation Safety Board
PSE	Principal Structural Element
RAP	Repairs Assessment Programme
REG	Repair Evaluation Guidelines
SB	Service Bulletin
SMP	Structural Modification Point
SRM	Structural Repair Manual
SSID	Supplemental Structural Inspection Document
SSIP	Supplemental Structural Inspection Programme
STG	Structural Task Group
TCH	Type-Certificate Holder
WFD	Widespread Fatigue Damage

## 5. WAY OF WORKING

### a) General

On the initiative of the TCH and the Agency, a STG should be formed for each aircraft model for which it is decided to put in place an ageing aircraft programme. The STG shall consist of the TCH, selected operator members and Agency representative(s). The objective of the STG is to complete all tasks covered in this AMC in relation to their respective model types, including the following:

- Develop model specific programmes
- Define programme implementation
- Conduct recurrent programme reviews as necessary.

It is recognised that it might not always be possible to form or to maintain an STG, due to a potential lack of resources with the operators or TCH. In this case the above objective would remain with the Agency and operators or TCH as applicable.

An acceptable way of working for STGs is described in “Report on Structures Task Group Guidelines” that was established by the AAWG with the additional clarifications provided in the following sub-paragraphs.

### b) Meeting scheduling

It is the responsibility of the TCH to schedule STG meetings. However if it is found by the Agency that the meeting scheduling is inadequate to meet the STG working objectives, the Agency might initiate themselves additional STG meetings.

### c) Reporting

The STG would make recommendations for actions via the TCH to the Agency. Additionally, the STG should give periodic reports (for information only) to AAWG/EASA as appropriate with the objective of maintaining a consistent approach.

d) Recommendations and decision making

The decision making process described in the AAWG Report on Structures Task Group Guidelines paragraph 7 leads to recommendations for mandatory action from the TCH to the Agency. In addition it should be noted that the Agency is entitled to mandate safety measures related to ageing aircraft structures, in addition to those recommended by the STG, if they find it necessary.

e) Responsibilities

The TCH is responsible for developing the ageing aircraft structures programme for each aircraft type, detailing the actions necessary to maintain airworthiness. Other DAH should develop programmes or actions appropriate to the modification/repair for which they hold approval, unless addressed by the TCH. All DAHs will be responsible for monitoring the effectiveness of their specific programme, and to amend the programme as necessary.

The Operator is responsible for incorporating approved DAH actions necessary to maintain airworthiness into its aircraft specific maintenance programmes, in accordance with Part-M.

The competent authority of the state of registry is responsible for ensuring the implementation of the ageing aircraft programme by their operators.

The Agency will approve ageing aircraft structures programmes and may issue ADs to support implementation, where necessary. The Agency, in conjunction with the DAH, will monitor the overall effectiveness of ageing aircraft structures programmes.

## 6. SUPPLEMENTAL STRUCTURAL INSPECTION PROGRAMME (SSIP)

In the absence of a damage-tolerance based structural maintenance inspection programme (e.g. MRB report, ALS), the TCH, in conjunction with operators, is expected to initiate the development of a SSIP for each aircraft model. Such a programme must be implemented before analysis, tests, and/or service experience indicates that a significant increase in inspection and/or modification is necessary to maintain structural integrity of the aircraft. This should ensure that an acceptable programme is available to the operators when needed. The programme should include procedures for obtaining service information, and assessment of service information, available test data, and new analysis and test data. A SSID should be developed, as outlined in Appendix 1 of this AMC, from this body of data. The role of the operator is principally to comment on the practicality of the inspections and any other procedures defined by the TCH and to implement them effectively.

The SSID, along with the criteria used and the basis for the criteria should be submitted to the Agency for review and approval. The SSIP should be adequately defined in the SSID. The SSID should include inspection threshold, repeat interval, inspection methods and procedures. The applicable modification status, associated life limitation and types of operations for which the SSID is valid should also be identified and stated. In addition, the inspection access, the type of damage being considered, likely damage sites and details of the resulting fatigue cracking scenario should be included as necessary to support the prescribed inspections.

The Agency's review of the SSID will include both engineering and maintenance aspects of the proposal. Because the SSID is applicable to all operators and is intended to address potential safety concerns on older aircraft, the Agency expects these essential elements to be included in maintenance programmes developed in compliance with Part-M. In addition, the Agency will issue ADs to implement any service bulletins or other service information publications found to be essential for safety during the initial SSID assessment process should the SSID not be



available in time to effectively control the safety concern. Service bulletins or other service information publications revised or issued as a result of in-service findings resulting from implementation of the SSID should be added to the SSID or will be implemented by separate AD action, as appropriate.

In the event an acceptable SSID cannot be obtained on a timely basis, the Agency may impose service life, operational, or inspection limitations to assure structural integrity.

As a result of a periodic review, the TCH should revise the SSID whenever additional information shows a need. The original SSID will normally be based on predictions or assumptions (from analyses, tests, and/or service experience) of failure modes, time to initial damage, frequency of damage, typically detectable damage, and the damage growth period. Consequently, a change in these factors sufficient to justify a revision would have to be substantiated by test data or additional service information. Any revision to SSID criteria and the basis for these revisions should be submitted to the Agency for review and approval of both engineering and maintenance aspects.

## **7. SERVICE BULLETIN REVIEW and MANDATORY MODIFICATION PROGRAMME**

Service Bulletins issued early in the life of an aircraft fleet may utilise inspections (in some cases non-mandatory inspections) alone to maintain structural integrity. Inspections may be adequate in this early stage, when cracking is possible, but not highly likely. However, as aircraft age the probability of fatigue cracking becomes more likely. In this later stage it is not prudent to rely only on inspections alone because there are more opportunities for cracks to be missed and cracks may no longer occur in isolation. In this later stage in the life of a fleet it is prudent to reduce the reliance strictly on inspections, with its inherent human factors limitations, and incorporate modifications to the structure to eliminate the source of the cracking. In some cases reliance on an inspection programme, in lieu of modification, may be acceptable through the increased use of mandatory versus non-mandatory inspections.

The TCH, in conjunction with operators, is expected to initiate a review of all structurally related inspection and modification SBs and determine which require further actions to ensure continued airworthiness, including mandatory modification action or enforcement of special repetitive inspections

Any aircraft primary structural components that would require frequent repeat inspection, or where the inspection is difficult to perform, taking into account the potential airworthiness concern, should be reviewed to preclude the human factors issues associated with repetitive inspections

The SB review is an iterative process (see Appendix 5) consisting of the following items:

- a) The TCH should review all issued structural inspection - and modification SBs to select candidate bulletins, using the following 4 criteria:
  - i) There is a high probability that structural cracking exists
  - ii) Potential structural airworthiness concern.
  - iii) Damage is difficult to detect during routine maintenance
  - iv) There is Adjacent Structural damage or the potential for it.

This may be done by the TCH alone or in conjunction with the operators at a preliminary STG meeting.

- b) The TCH and operator members will be requested to submit information on individual fleet experience relating to candidate SBs. This information will be collected and

evaluated by the TCH. The summarised results will then be reviewed in detail at a STG meeting (see c. below).

- c) The final selection of SBs for recommendation of the appropriate corrective action to assure structural continued airworthiness taking into account the in-service experience, will be made during an STG meeting by the voting members of the STG, either by consensus or majority vote, depending on the preference of the individual STGs.
- d) An assessment will be made by the TCH as to whether or not any subsequent revisions to SBs affect the previous decision made. Any subsequent revisions to SBs previously chosen by the STG for mandatory inspection or incorporation of modification action that would affect the previous STG recommended action should be submitted to the STG for review.
- e) The TCH should review all new structural SBs periodically to select further candidate bulletins. The TCH should schedule a meeting of the STG to address the candidates. Operator members and the competent authority will be advised of the candidate selection and provided the opportunity to submit additional candidates.

## 8. CORROSION PREVENTION AND CONTROL PROGRAMME

A corrosion prevention and control programme (CPCP) is a systematic approach to prevent and to control corrosion in the aircraft's Primary Structure. The objective of a CPCP is to limit the deterioration due to corrosion to a level necessary to maintain airworthiness and where necessary to restore the corrosion protection schemes for the structure. A CPCP consists of a basic corrosion inspection task, task areas, defined corrosion levels, and compliance times (implementation thresholds and repeat intervals). The CPCP also includes procedures to notify the competent authority and TCH of the findings and data associated with Level 2 and Level 3 corrosion and the actions taken to reduce future findings to Level 1 or better. See Appendix 4 for definitions and further details.

As part of the ICA, the TCH should provide an inspection programme that includes the frequency and extent of inspections necessary to provide the continued airworthiness of the aircraft. Furthermore, the ICA should include the information needed to apply protective treatments to the structure after inspection. In order for the inspections to be effectively accomplished, the TCH should provide corrosion removal and cleaning procedures and reference allowable limits. The TCH should include all of these corrosion-related activities in a manual referred to as the Baseline Programme. This Baseline Programme manual is intended to form a basis for operators to derive a systematic and comprehensive CPCP for inclusion in the operator's maintenance programme. The TCH is responsible for monitoring the effectiveness of the Baseline Programme and, if necessary, to recommend changes based on operators reports of findings. In line with Part-M requirements, when the TCH publishes revisions to their Baseline Programme, these should be reviewed and the operator's programme adjusted as necessary in order to maintain corrosion to Level 1 or better.

An operator may adopt the Baseline Programme provided by the TCH or it may choose to develop its own CPCP, or may be required to if none is available from the TCH. In developing its own CPCP an operator may join with other operators and develop a Baseline Programme similar to a TCH developed Baseline Programme for use by all operators in the group.

Before an operator may include a CPCP in its maintenance or inspection programme, the competent authority should review and approve that CPCP. The operator should show that the CPCP is comprehensive in that it addresses all corrosion likely to affect Primary Structure, and is systematic in that it provides:

- a) Step-by-step procedures that are applied on a regular basis to each identified task area or zone, and
- b) These procedures are adjusted when they result in evidence that corrosion is not being controlled to an established acceptable level (Level 1 or better).

Note: For an aeroplane with an ALS, in addition to providing a suitable baseline programme in the ICA and to ensure compliance with CS 25.571 it is appropriate for the TCH to place an entry in the ALS stating that all corrosion should be maintained to Level 1 or better. (This practice is also described in ATA MSG-3)

## 9. REPAIR EVALUATION GUIDELINES AND REPAIR ASSESSMENT PROGRAMMES

Early fatigue or fail-safe requirements (pre-Amdt 45) did not necessarily provide for timely inspection of critical structure so that damaged or failed components could be dependably identified and repaired or replaced before a hazardous condition developed. Furthermore, it is known that application of later fatigue and damage tolerance requirements to repairs was not always fully implemented according to the relevant certification bases.

Repair Evaluation Guidelines (REG) are intended to assure the continued structural integrity of all relevant repaired and adjacent structure, based on damage-tolerance principles, consistent with the safety level provided by the SSID or ALS as applied to the baseline structure. To achieve this, the REG should be developed by the TCH and implemented by the Operator to ensure that an evaluation is performed of all repairs to structure that is susceptible to fatigue cracking and could contribute to a catastrophic failure.

Even the best maintained aircraft will accumulate structural repairs when being operated. The AAWG conducted two separate surveys of repairs placed on aircraft to collect data. The evaluation of these surveys revealed that 90% of all repairs found were on the fuselage, hence these are a priority and RAPs have already been developed for the fuselage pressure shell of many large transport aeroplanes not originally certificated to damage-tolerance requirements. 40% of the repairs were classified as adequate and 60% of the repairs required consideration for possible additional supplemental inspection during service. Nonetheless, following further studies by AAWG working groups it has been agreed that repairs to all structure susceptible to fatigue and whose failure could contribute to catastrophic failure will be considered. (Ref. AAWG Report: Recommendations concerning ARAC taskings FR Doc.04-10816 Re: Aging Airplane safety final rule. 14 CFR 121.370a and 129.16.)

As aircraft operate into high cycles and high times the ageing repaired structure needs the same considerations as the original structure in respect of damage-tolerance. Existing repairs may not have been assessed for damage-tolerance and appropriate inspections or other actions implemented. Repairs are to be assessed, replaced if necessary or repeat inspections determined and carried out as supplemental inspections or within the baseline zonal inspection programme. A damage-tolerance based inspection programme for repairs will be required to detect damage which may develop in a repaired area, before that damage degrades the load carrying capability of the structure below the levels required by the applicable airworthiness standards.

The REG should provide data to address repairs to all structure that is susceptible to fatigue cracking and could contribute to a catastrophic failure. The REG may refer to the RAP, other existing approved data such as SRM and SBs or provide specific means for obtaining data for individual repairs.

Documentation such as the Structural Repair Manual and service bulletins needs to be reviewed for compliance with damage-tolerance principles and be updated and promulgated consistent with the intent of the REGs.

Where repair evaluation guidelines, repair assessment programmes or similar documents have been published by the TCH they should be incorporated into the aircraft's maintenance programme according to Part-M requirements.

This fatigue and damage-tolerance evaluation of repairs will establish an appropriate inspection programme or a replacement schedule if the necessary inspection programme is too demanding or not possible. Details of the means by which the REGs and the maintenance programme may be developed are incorporated in Appendix 3.

## 10. LIMIT OF VALIDITY OF THE MAINTENANCE PROGRAMME AND EVALUATION FOR WIDESPREAD FATIGUE DAMAGE

### a) Initial WFD Evaluation and LOV

All fatigue and damage tolerance evaluations are finite in scope and also therefore in their long term ability to ensure continued airworthiness. The maintenance requirements that evolve from these evaluations have a finite period of validity defined by the extent of testing, analysis and service experience that make up the evaluation and the degree of associated uncertainties. Limit of validity (LOV) is the period of time, expressed in appropriate units (e.g. flight cycles) for which it has been shown that the established inspections and replacement times will be sufficient to allow safe operation and in particular to preclude development of widespread fatigue damage. The LOV should be based on fatigue test evidence.

The likelihood of the occurrence of fatigue damage in an aircraft's structure increases with aircraft usage. The design process generally establishes a design service goal (DSG) in terms of flight cycles/hours for the airframe. It is generally expected that any cracking that occurs on an aircraft operated up to the DSG will occur in isolation (i.e., local cracking), originating from a single source, such as a random manufacturing flaw (e.g., a mis-drilled fastener hole) or a localised design detail. It is considered unlikely that cracks from manufacturing flaws or localised design issues will interact strongly as they grow. The SSIP described in paragraph 6 and Appendix 1 of this AMC are intended to find all forms of fatigue damage before they become critical. Nonetheless, it has become apparent that as aircraft have approached and exceeded their DSG only some SSIPs have correctly addressed Widespread Fatigue Damage (WFD) as described below.

With extended usage, uniformly loaded structure may develop cracks in adjacent fastener holes, or in adjacent similar structural details. The development of cracks at multiple locations (both MSD and MED) may also result in strong interactions that can affect subsequent crack growth, in which case the predictions for local cracking would no longer apply. An example of this situation may occur at any skin joint where load transfer occurs. Simultaneous cracking at many fasteners along a common rivet line may reduce the residual strength of the joint below required levels before the cracks are detectable under the maintenance programme established at time of certification. Furthermore, these cracks, while they may or may not interact, can have an adverse effect on the large damage capability (LDC) of the airframe before the cracks become detectable.

The TCH's role is to perform a WFD evaluation and, in conjunction with operators, is expected to initiate development of a maintenance programme with the intent of precluding operation with WFD. Appendix 2 provides guidelines for development of a programme to preclude the occurrence of WFD. Such a programme must be

implemented before analysis, tests, and/or service experience indicates that widespread fatigue damage may develop in the fleet. The operator's role is to provide service experience, to help ensure the practicality of the programme and to ensure it is implemented effectively.

The results of the WFD evaluation should be presented for review and approval to the Agency for the aircraft model being considered. Since the objective of this evaluation is to preclude WFD from the fleet, it is expected that the results will include recommendations for necessary inspections or modification and/or replacement of structure, as appropriate to support the LOV. It is expected that the TCH will work closely with operators in the development of these programmes to assure that the expertise and resources are available when implemented.

The Agency's review of the WFD evaluation results will include both engineering and maintenance aspects of the proposal. The Agency expects any actions necessary to preclude WFD (including the LOV) to be incorporated in maintenance programmes developed in compliance with Part-M. Any service bulletins or other service information publications revised or issued as a result of in-service MSD/MED findings resulting from implementation of these programmes may require separate AD action.

In the event an acceptable WFD evaluation cannot be completed on a timely basis, the Agency may impose service life, operational, or inspection limitations to assure structural integrity of the subject type design.

b) Revision of WFD evaluation and LOV

New service experience findings, improvements in the prediction methodology, better load spectrum data, a change in any of the factors upon which the WFD evaluation is based or economic considerations, may dictate a revision to the evaluation. Accordingly, associated new recommendations for service action should be developed including a revised LOV, if appropriate, and submitted to the Agency for review and approval of both engineering and maintenance aspects.

In order to operate an individual aircraft up to the revised LOV, a WFD evaluation should also be performed for all applicable modified or repaired structure to determine if any new structure or any structure affected by the change is susceptible to WFD. This evaluation should be conducted by the DAH for the changed structure in conjunction with the operator prior to the aircraft reaching its existing LOV. The results together with any necessary actions required to preclude WFD from occurring before the aircraft reaches the revised LOV should be presented for review and approval by the Agency.

This process may be repeated such that, subject to Agency approval of the evaluations, a revised LOV may be established and incorporated in the operator's maintenance programme, together with any necessary actions to preclude WFD from occurring before the aircraft reaches the revised LOV.

The LOV and associated actions should be incorporated in the ALS. For an aircraft without an ALS, it may be appropriate for the DAH to create an ALS and to enter the LOV in the ALS, together with a clear identification of inspections and modifications required to allow safe operation up to that limit.

In any case, should instructions provided by the DAH in their ICA (e.g. maintenance manual revision) clearly indicate that the maintenance programme is not valid beyond a certain limit, this limit and associated instructions must be adhered to in the operator's maintenance programme as approved by the competent authority under Part-M

requirements, unless an EASA approved alternative programme is incorporated and approved.

**11. SUPPLEMENTAL TYPE-CERTIFICATES AND MODIFICATIONS**

Any modification or supplemental type-certificates (STC) affecting an aircraft’s structure could have an effect on one or all aspects of ageing aircraft assessment as listed above. Such structural changes will need the same consideration as the basic aircraft and the operator should seek support from the STC holder (who has primary responsibility for the design/certification of the STC), or an approved Design Organisation, where, for example an STC holder no longer exists. Appendix 3 provides further details.

STC holders are expected to review existing designs that may have implications for continued airworthiness in the context of ageing aircraft programmes and collaborate with operators and TCHs, where appropriate.

**12. IMPLEMENTATION**

In compliance with Part-M, operators must amend their current structural maintenance programmes to comply with and to account for new and/or modified maintenance instructions promulgated by the DAH.

From the industry/Agency discussions leading to the definition of the programmes detailed in paragraphs 6 to 10, above, appropriate implementation times have emerged. These programme implementation times are expressed as a fraction of the aircraft model’s DSG.

Programme	Affected Structure*	Implementation
CPCP	All Primary Structure	½ DSG
SSID	PSEs as defined in CS25.571	½ DSG
SB-Review	SBs that address a potentially unsafe structural condition	¾ DSG
REGs and RAPs	Repairs to fatigue critical structure (FCS).	¾ DSG
WFD	Primary structure susceptible to WFD	1 DSG

\* Note: The certification philosophy for safe-life items under CS 25.571 necessitates no further investigation under ageing aircraft programmes that would provide damage tolerance based inspections. However, this does not exclude safe-life items such as landing gear from the CPCP and SB Review or from re-assessment of their safe-life if the aircraft usage or structural loading is known to have changed.

In the absence of other information prior to the implementation of these programmes the limit of validity of the existing maintenance programmes should be considered as the DSG.

Programme implementation times in flight hours, flight or landing cycles, or calendar period, as appropriate, should be established by the TC/STC Holder based on the above table.

A period of up to one year may be allowed to incorporate the necessary actions into the operator’s maintenance programme once they become available from the DAH. Grace periods for accomplishment of actions beyond threshold should address the level of risk and for large fleets the practicalities of scheduling maintenance activities. Typically, for maintenance actions beyond threshold, full implementation of these maintenance actions across the whole fleet should be accomplished within 4 years of the operator’s programme being approved by the competent authority.

Unless data is available on the dates of incorporation of repairs and modifications [STCs] they will need to be assumed as having the same age as the airframe.

[Amdt 20/2]

## Appendix 1 to AMC 20-20 Guidelines for the development of a Supplementary Structural Inspection Programme

*ED Decision 2007/019/R*

### 1. GENERAL

#### 1.1 Purpose

This Appendix 1 gives interpretations, guidelines and acceptable means of compliance for the SSIP actions.

#### 1.2 Background

Service experience has demonstrated that there is a need to have continuing updated knowledge concerning the structural integrity of aircraft, especially as they become older. Early fatigue requirements, such as “fail safe” regulations did not provide for timely inspection of an aircraft’s critical structure to ensure that damaged or failed components could be dependably identified and then repaired or replaced before hazardous conditions developed.

In 1978 the damage-tolerance concept was adopted for transport category aeroplanes in the USA as Amendment 25-45 to FAR 25.571. This amended rule required damage-tolerance analyses as part of the type design of transport category aeroplanes for which application for type-certification was received after the effective date of the amendment. In 1980 the requirement for damage-tolerance analyses was also included in JAR 25.571 Change 7.

One prerequisite for the successful application of the damage tolerance approach for managing fatigue is that crack growth and residual strength can be anticipated with sufficient precision to allow inspections to be established that will detect cracking before it reaches a size that will degrade the strength below a specified level. When damage is discovered, airworthiness is ensured by repair or revised maintenance action. Evidence to date suggests that when all critical structure is included, fatigue and damage-tolerance based inspections and procedures (including modification and replacement when necessary) provide the best approach to address aircraft fatigue.

Pre FAR Part 25 Amendment 25-45 (JAR-25 Change 7) aeroplanes were built to varying standards that embodied fatigue and fail-safe requirements. These aeroplanes, as certified, had no specific mandated requirements to perform inspections for fatigue. Following the amendment of FAR 25 to embody damage-tolerance requirements, the FAA published Advisory Circular 91-56A. That AC was applicable to pre-Amendment 25-45 aeroplanes with a maximum gross weight greater than 75.000 pounds. According to the AC the TCH, in conjunction with operators, was expected to initiate development of a SSIP for each aeroplane model.

AC 91-56A provided guidance material for the development of such programmes based on damage-tolerance principles. Many TCH’s of large aeroplanes developed SSIPs for their pre-Amendment 25-45 aeroplanes. The documents containing the SSIP are designated Supplemental Structural Inspection Documents (SSID) or Supplemental Inspection Documents (SID)

The competent authorities have in the past issued a series of ADs requiring compliance with these SSIPs. Generally these ADs require the operators to incorporate the SSIPs into their maintenance programmes. Under Part-M requirements it is expected that an operator will automatically incorporate the SSID into their maintenance programme.

For post Amendment 25-45 aeroplanes, it was required that inspections or other procedures should be developed based on the damage-tolerance evaluations required by FAR 25.571, and included in the maintenance data. In Amendment 25-54 to FAR 25 and change 7 to JAR-25 it was required to include these inspections and procedures in the Airworthiness Limitations Section of the Instructions for Continued Airworthiness required by 25.1529. At the same amendment, 25.1529 was changed to require applicants for type-certificates to prepare Instructions for Continued Airworthiness in accordance with Appendix H of FAR/JAR-25. Appendix H requires that the Instructions for Continued Airworthiness must contain a section titled Airworthiness Limitations that is segregated and clearly distinguishable from the rest of the document. This section shall contain the information concerning inspections and other procedures as required by FAR/JAR/CS 25.571.

The content of the Airworthiness Limitations Section of the Instructions for Continued Airworthiness is designated by some TCH's as Airworthiness Limitations Instructions (ALI). Other TCH's have decided to designate the same items as Airworthiness Limitations Items (ALI).

Compliance with FAR/JAR 25.571 at Amendment 25-45 and Change 7 respectively, or later amendments, results in requirements to periodically inspect aeroplanes for potential fatigue damage in areas where it is most likely to occur.

## **2. SUPPLEMENTAL STRUCTURAL INSPECTION PROGRAMME (SSIP)**

Increased utilisation, longer operational lives, and the high safety demands imposed on the current fleet of transport aeroplanes indicate the need for a programme to ensure a high level of structural integrity for all aeroplanes in the transport fleet.

This AMC is intended to provide guidance to TCHs and other DAHs to develop or review existing inspection programmes for effectiveness. SSIPs are based on a thorough technical review of the damage-tolerance characteristics of the aircraft structure using the latest techniques and changes in operational usage. They lead to revised or new inspection requirements primarily for structural cracking and replacement or modification of structure where inspection is not practical.

Large transport aeroplanes that were certificated according to FAR 25.571 Amendment 25-45/54 or JAR 25 Change 7 are damage-tolerant. The fatigue requirements are part of the MRB Report, as required by ATA MSG-3. However, for pre ATA MSG-3 rev 2 aeroplanes there are no requirements for regular MRB Report review and for post ATA MSG-3 rev 2 aeroplanes there is only a requirement for regular MRB Report review in order to assess if the CPCP is effective. Concerning ageing aircraft activities, it is important to regularly review the part of the MRB Report containing the structural inspections resulting from the fatigue and damage-tolerance analysis for effectiveness.

### **2.1 Pre-Amendment 25-45 aeroplanes**

The TCH is expected to initiate development of a SSIP for each aeroplane model. Such a programme must be implemented before analysis, test and/or service experience indicate that a significant increase in inspection and or modification is necessary to maintain structural integrity of the aeroplane. This should ensure that an acceptable programme is available to the operators when needed. The programme should include procedures for obtaining service information, and assessment of service information, available test data, and new analysis and test data.



A SSID should be developed in accordance with Paragraph 3 of this Appendix 1. The recommended SSIP, along with the criteria used and the basis for the criteria, should be submitted by the TCH to the Agency for approval. The SSIP should be adequately defined in the SSID and presented in a manner that is effective. The SSID should include the type of damage being considered, and likely sites; inspection access, threshold, interval method and procedures; applicable modification status and/or life limitation; and types of operation for which the SSID is valid.

The review of the SSID by the Agency will include both engineering and maintenance aspects of the proposal. In the event an acceptable SSID cannot be obtained on a timely basis the competent authority may impose service life, operational, or inspection limitations to assure structural integrity

The TCH should check the SSID periodically against current service experience. This should include an evaluation of current methods and findings. Any unexpected defect occurring should be assessed as part of the continuing assessment of structural integrity to determine a need for revision to the document.

## 2.2 Post-Amendment 25-45 aeroplanes

Aeroplanes certificated to FAR 25.571 Amendment 25-45, JAR 25.571 Change 7 and CS-25 or later amendments are damage-tolerant. The airworthiness limitations including the inspections and procedures established in accordance with FAR/JAR/CS 25.571 shall be included in the Instructions for Continuing Airworthiness, ref. FAR/JAR/CS 25.1529. Further guidance for the actual contents is incorporated in FAR/JAR/CS-25 Appendix H.

To maintain the structural integrity of these aeroplanes it is necessary to follow up the effectiveness of these inspections and procedures. The DAH should therefore check this information periodically against current service experience. Any unexpected defect occurring should be assessed as part of the continuing assessment of structural integrity to determine a need for revision to this information. The revised data should be developed in accordance with the same procedures as at type- certification giving consideration to any additional test or service data available and changes to aeroplanes operating patterns.

## 3. GUIDELINES FOR DEVELOPMENT OF THE SUPPLEMENTAL STRUCTURAL INSPECTION DOCUMENT

This paragraph is based directly on Appendix 1 to FAA AC 91-56A which applies to transport category aeroplanes that were certificated prior to Amendment 25-45 of FAR 25 or equivalent requirement.

### 3.1 General

Amendment 25-45 to § 25.571 introduced wording which emphasises damage-tolerant design. However, the structure to be evaluated, the type of damage considered (fatigue, corrosion, service, and production damage), and the inspection and/or modification criteria should, to the extent practicable, be in accordance with the damage-tolerance principles of the current § 25.571 standards. An acceptable means of compliance can be found in AC 25.571-1C (“Damage-Tolerance and Fatigue Evaluation of Structure,” dated April 29, 1998) or the latest revision.

It is essential to identify the structural parts and components that contribute significantly to carrying flight, ground, pressure, or control loads, and whose failure could affect the structural integrity necessary for the continued safe operation of the aeroplane. The

damage-tolerance or safe-life characteristics of these parts and components must be established or confirmed.

Analyses made in respect to the continuing assessment of structural integrity should be based on supporting evidence, including test and service data. This supporting evidence should include consideration of the operating loading spectra, structural loading distributions, and material behaviour. An appropriate allowance should be made for the scatter in life to crack initiation and rate of crack propagation in establishing the inspection threshold, inspection frequency, and, where appropriate, retirement life. Alternatively, an inspection threshold may be based solely on a statistical assessment of fleet experience, if it can be shown that equal confidence can be placed in such an approach.

An effective method of evaluating the structural condition of older aeroplanes is selective inspection with intensive use of non-destructive techniques, and the inspection of individual aeroplanes, involving partial or complete dismantling (“teardown”) of available structure.

The effect of repairs and modifications approved by the TCH should be considered. In addition, it may be necessary to consider the effect of repairs and operator-approved or other DAH modifications on individual aircraft. The operator has the responsibility for ensuring notification and consideration of any such aspects in conjunction with the DAH.

### 3.2 Damage-tolerant structures

The damage-tolerance assessment of the aircraft structure should be based on the best information available. The assessment should include a review of analysis, test data, operational experience, and any special inspections related to the type design.

A determination should then be made of the site or sites within each structural part or component considered likely to crack, and the time or number of flights at which this might occur.

The growth characteristics of damage and interactive effects on adjacent parts in promoting more rapid or extensive damage should be determined. This determination should be based on study of those sites that may be subject to the possibility of crack initiation due to fatigue, corrosion, stress corrosion, disbonding, accidental damage, or manufacturing defects in those areas shown to be vulnerable by service experience or design judgement. The damage tolerance certification specification of CS 25.571 requires not only fatigue damage to be addressed but also accidental and environmental damage. Some types of accidental damage (e.g. scribe marks) can not be easily addressed by the MSG process and require specific inspections based on fatigue and damage tolerance analysis and tests. Furthermore, some applicants may choose to address other types of accidental damage and environmental damage in the SSID or ALS by modelling the damage as a crack and performing a fatigue and damage tolerance analysis. The resulting inspection programme may be tailored to look for the initial type of damage or the resulting fatigue cracking scenario, or both.

The minimum size of damage that is practical to detect and the proposed method of inspection should be determined. This determination should take into account the number of flights required for the crack to grow from detectable to the allowable limit, such that the structure has a residual strength corresponding to the conditions stated under CS 25.571.

Note: In determining the proposed method of inspection, consideration should be given to visual inspection, non-destructive testing, and analysis of data from built-in load and defect monitoring devices.

The continuing assessment of structural integrity may involve more extensive damage than might have been considered in the original fail-safe evaluation of the aircraft, such as:

- (a) A number of small adjacent cracks, each of which may be less than the typically detectable length, developing suddenly into a long crack;
- (b) Failures or partial failures in other locations following an initial failure due to redistribution of loading causing a more rapid spread of fatigue; and
- (c) Concurrent failure or partial failure of multiple load path elements (e.g., lugs, planks, or crack arrest features) working at similar stress levels.

### 3.3 Information to be included in the assessment

The continuing assessment of structural integrity for the particular aircraft type should be based on the principles outlined in paragraph 3.2 of this Appendix 1. The following information should be included in the assessment and kept by the TCH in a form available to the Agency:

- (a) The current operational statistics of the fleet in terms of hours or flights;
- (b) The typical operational mission or missions assumed in the assessment;
- (c) The structural loading conditions from the chosen missions; and
- (d) Supporting test evidence and relevant service experience.

In addition to the information specified in paragraph 3.3. above, the following should be included for each critical part or component:

- (a) The basis used for evaluating the damage-tolerance characteristics of the part or component;
- (b) The site or sites within the part or component where damage could affect the structural integrity of the aircraft;
- (c) The recommended inspection methods for the area;
- (d) For damage-tolerant structures, the maximum damage size at which the residual strength capability can be demonstrated and the critical design loading case for the latter; and
- (e) For damage-tolerant structures, at each damage site the inspection threshold and the damage growth interval between detectable and critical, including any likely interaction effect from the damage sites.

Note: Where re-evaluation of fail-safety or damage-tolerance of certain parts or components indicates that these qualities cannot be achieved, or can only be demonstrated using an inspection procedure whose practicability or reliability may be in doubt, replacement or modification action may need to be defined.

### 3.4 Inspection programme

The purpose of a continuing airworthiness assessment in its most basic terms is to adjust the current maintenance inspection programme, as required, to assure continued safety of the aircraft type.

In accordance with Paragraphs 1 and 2 of this Appendix 1, an allowable limit of the size of damage should be determined for each site such that the structure has a residual strength for the load conditions specified in CS 25.571. The size of damage that is practical to detect by the proposed method of inspection should be determined, along with the number of flights required for the crack to grow from detectable to the allowable limit.

The recommended inspection programme should be determined from the data described in paragraph 3.3 above, giving due consideration to the following:

- (a) Fleet experience, including all of the scheduled maintenance checks;
- (b) Confidence in the proposed inspection technique; and
- (c) The joint probability of reaching the load levels described above and the final size of damage in those instances where probabilistic methods can be used with acceptable confidence.

Inspection thresholds for supplemental inspections should be established. These inspections would be supplemental to the normal inspections, including the detailed internal inspections.

- (a) For structure with reported cracking, the threshold for inspection should be determined by analysis of the service data and available test data for each individual case.
- (b) For structure with no reported cracking, it may be acceptable, provided sufficient fleet experience is available, to determine the inspection threshold on the basis of analysis of existing fleet data alone. This threshold should be set such as to include the inspection of a sufficient number of high-time aircraft to develop added confidence in the integrity of the structure (see Paragraph 1 of this Appendix 1).

### 3.5 The supplemental structural inspection document

The SSID should contain the recommendations for the inspection procedures and replacement or modification of parts or components necessary for the continued safe operation of the aircraft up to the LOV. The document should be prefaced by the following information:

- (a) Identification of the variants of the basic aircraft type to which the document relates;
- (b) Reference to documents giving any existing inspections or modifications of parts or components;
- (c) The types of operations for which the inspection programme are considered valid;
- (d) A list of service bulletins (or other service information publication) revised as a result of the structural reassessment undertaken to develop the SSID, including a statement that the operator must account for these service bulletins.
- (e) The type of damage which is being considered (i.e., fatigue, corrosion and/or accidental damage).
- (f) Guidance to the operator on which inspection findings should be reported to the type-certificate holder.

The document should contain at least the following information for each critical part or component:

- (a) A description of the part or component and any relevant adjacent structure, including means of access to the part.
- (b) Relevant service experience.
- (c) Likely site(s) of damage.
- (d) Inspection method and procedure, and alternatives.
- (e) Minimum size of damage considered detectable by the method(s) of inspection.
- (f) Service bulletins (or other service information publication) revised or issued as a result of in-service findings resulting from implementation of the SSID (added as revision to the initial SID).
- (g) Initial inspection threshold.
- (h) Repeat inspection interval.
- (i) Reference to any optional modification or replacement of part or component as terminating action to inspection.
- (j) Reference to the mandatory modification or replacement of the part or component at given life, if fail-safety by inspection is impractical; and
- (k) Information related to any variations found necessary to “safe lives” already declared.

The SSID should be compared from time to time against current service experience. Any unexpected defect occurring should be assessed as part of the continuing assessment of structural integrity to determine the need for revision of the SSID. Future structural service bulletins should state their effect on the SSID.

[Amdt 20/2]

## Appendix 2 to AMC 20-20 Guidelines for the development of a programme to preclude the occurrence of widespread fatigue damage

*ED Decision 2007/019/R*

### 1. INTRODUCTION

The terminology and methodology in this appendix is based upon material developed by the AAWG.

### 2. DEFINITIONS

Extended Service Goal (ESG) is an adjustment to the design service goal established by service experience, analysis, and/or test during which the principal structure will be reasonably free from significant cracking including widespread fatigue damage.

Inspection Start Point (ISP) is the point in time when special inspections of the fleet are initiated due to a specific probability of having a MSD/MED condition.

Large Damage Capability (LDC) is the ability of the structure to sustain damage visually detectable under an operator's normal maintenance that is caused by accidental damage, fatigue damage, and environmental degradation, and still maintain limit load capability with MSD to the extent expected at SMP.

Monitoring period is the period of time when special inspections of the fleet are initiated due to an increased risk of MSD/MED (ISP) and ending when the SMP is reached.

Scatter Factor is a life reduction factor used in the interpretation of fatigue analysis and fatigue test results.

Structural Modification Point (SMP) is a point reduced from the WFD average behaviour (i.e., lower bound), so that operation up to that point provides equivalent protection to that of a two-lifetime fatigue test. No aircraft should be operated beyond the SMP without modification or part replacement.

Test-to-Structure Factor is a series of factors used to adjust test results to full-scale structure. These factors could include, but are not limited to, differences in:

- stress spectrum,
- boundary conditions,
- specimen configuration,
- material differences,
- geometric considerations, and
- environmental effects.

Teardown inspections can be destructive and can be performed on fatigue tested structural components or those that have been removed from service. Alternatively they involve local teardown (non-destructive) disassembly and subsequent refurbishment of specific areas of high-time aircraft in service. The liberated sections of structure are then inspected using visual and non-destructive inspection technology, to characterise the extent of damage within the structure with regard to corrosion, fatigue, and accidental damage.

WFD (average behaviour) is the point in time when 50% of the fleet is expected to reach WFD for a particular detail.

### 3. GENERAL

The likelihood of the occurrence of fatigue damage in an aircraft's structure increases with aircraft usage. The design process generally establishes a design service goal (DSG) in terms of flight cycles/hours for the airframe. It is expected that any cracking that occurs on an aircraft operated up to the DSG will occur in isolation (i.e., local cracking), originating from a single source, such as a random manufacturing flaw (e.g., a mis-drilled fastener hole) or a localised design detail. It is considered unlikely that cracks from manufacturing flaws or localised design issues will interact strongly as they grow.

With extended usage, uniformly loaded structure may develop cracks in adjacent fastener holes, or in adjacent similar structural details. These cracks may or may not interact, and they can have an adverse effect on the LDC of the structure before the cracks become detectable. The development of cracks at multiple locations (both MSD and MED) may also result in strong interactions that can affect subsequent crack growth; in which case, the predictions for local cracking would no longer apply. An example of this situation may occur at any skin joint where load transfer occurs. Simultaneous cracking at many fasteners along a common rivet line may reduce the residual strength of the joint below required levels before the cracks are detectable under the routine maintenance programme established at the time of certification.

Because of the small probability of occurrence of MSD/MED in aircraft operation up to its DSG, maintenance programmes developed for initial certification have generally considered only local fatigue cracking. Therefore, as the aircraft reaches its DSG, it is necessary to take appropriate action in the ageing fleets to preclude WFD so that continued safe operation of the aircraft is not jeopardised. The DAH and/or the operator(s) should conduct structural evaluations to determine where and when MSD/MED may occur. Based on these evaluations the DAH and in some cases the operators would provide additional maintenance instructions for the structure, as appropriate. The maintenance instructions include, but are not limited to inspections, structural modifications, and limits of validity of the new maintenance instructions. In most cases, a combination of inspections and/or modifications/replacements is deemed necessary to achieve the required safety level. Other cases will require modification or replacement if inspections are not viable.

There is a distinct possibility that there could be a simultaneous occurrence of MSD and MED in a given structural area. This situation is possible on some details that were equally stressed. If this is possible, then this scenario should be considered in developing appropriate service actions for structural areas.

Before MSD/MED can be addressed, it is expected that the operators will incorporate an augmented structural maintenance programme that includes the Mandatory Modifications Programme, the CPCP, the SSIP and the Repair Assessment Programme.

There are alternative methods for accomplishing a WFD assessment other than that given in this AMC. For example, FAA AC 25-571-1C Paragraph 6.C or latest revision contains guidance material for the evaluation of structure using risk analysis techniques.

### 4. STRUCTURAL EVALUATION FOR WFD

#### 4.1 General.

The evaluation has three objectives:

- (a) Identify Primary Structure susceptible to MSD/MED, see paragraph 4.2.
- (b) Predict when it is likely to occur; see paragraph 4.3 and

- (c) Establish additional maintenance actions, as necessary, to ensure continued safe operation of the aircraft; see paragraph 4.4.

#### 4.2 Structure susceptible to MSD/MED.

Susceptible structure is defined as that which has the potential to develop MSD/MED. Such structure typically has the characteristics of multiple similar details operating at similar stresses where structural capability could be affected by interaction of multiple cracking at a number of similar details. The following list provides examples of known types of structure susceptible to MSD/MED. (The list is not exhaustive):

STRUCTURAL AREA	SEE FIGURE
Longitudinal Skin Joints, Frames, and Tear Straps (MSD/MED)	A2-1
Circumferential Joints and Stringers (MSD/MED)	A2-2
Lap joints with Milled, Chem-milled or Bonded Radius (MSD)	A2-3
Fuselage Frames (MED)	A2-4
Stringer to Frame Attachments (MED)	A2-5
Shear Clip End Fasteners on Shear Tied Fuselage Frames (MSD/MED)	A2-6
Aft Pressure Dome Outer Ring and Dome Web Splices (MSD/MED)	A2-7
Skin Splice at Aft Pressure Bulkhead (MSD)	A2-8
Abrupt Changes in Web or Skin Thickness — Pressurised or Un-pressurised Structure (MSD/MED)	A2-9
Window Surround Structure (MSD, MED)	A2-10
Over Wing Fuselage Attachments (MED)	A2-11
Latches and Hinges of Non-plug Doors (MSD/MED)	A2-12
Skin at Runout of Large Doubler (MSD)—Fuselage, Wing or Empennage	A2-13
Wing or Empennage Chordwise Splices (MSD/MED)	A2-14
Rib to Skin Attachments (MSD/MED)	A2-15
Typical Wing and Empennage Construction (MSD/MED)	A2-16

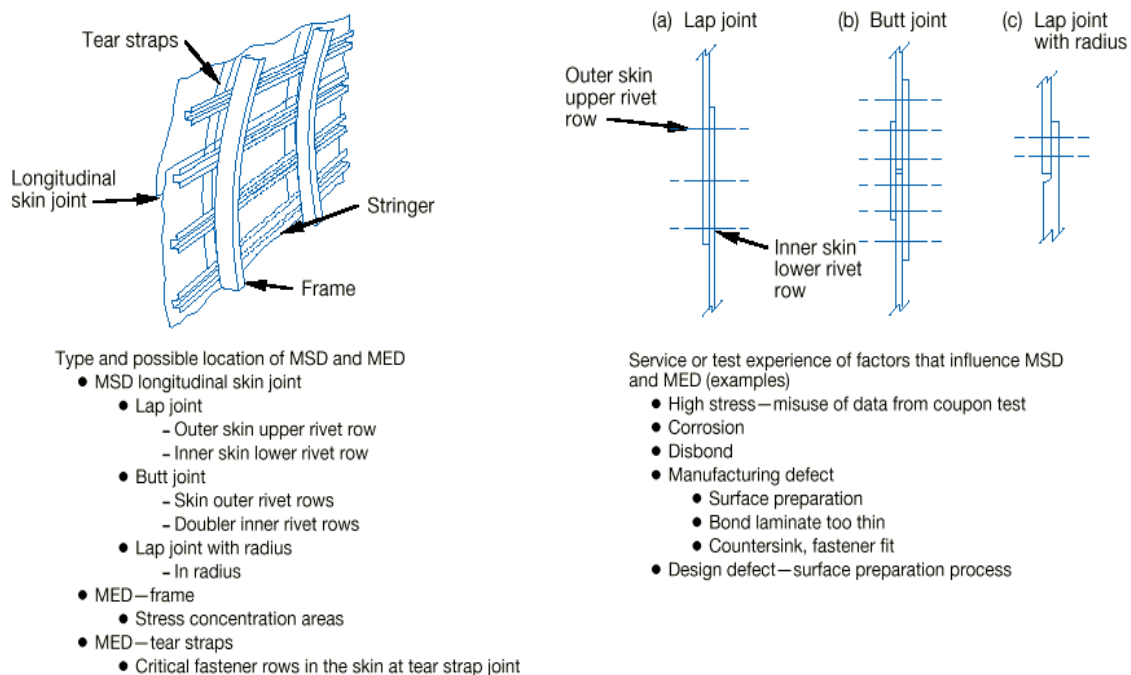
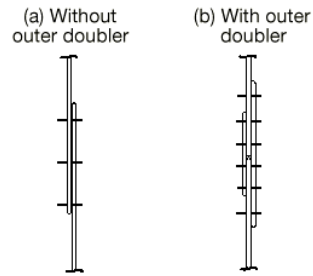
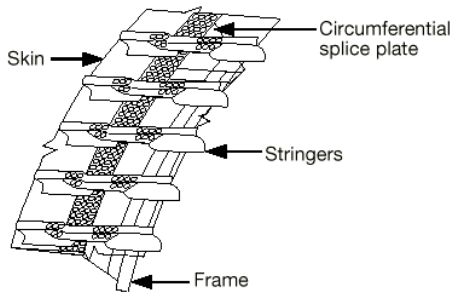

Figure A2-1 Longitudinal Skin Joints, Frames, and Tear Straps (MSD/MED)





**Type and possible location of MSD/MED**

- MSD—circumferential joint
  - Without outer doubler
    - Splice plate—between and/or at the inner two rivet rows
    - Skin—forward and aft rivet row of splice plate
    - Skin—at first fastener of stringer coupling
  - With outer doubler
    - Skin—outer rivet rows
    - Splice plate/outer doubler—inner rivet rows
- MED—stringer/stringer couplings
  - Stringer—at first fastener of stringer coupling
  - Stringer coupling—in splice plate area

**Service or test experience of factors that influence MSD and/or MED (examples)**

- High secondary bending
- High stress level in splice plate and joining stringers (misuse of data from coupon test)
- Poor design (wrong material)
- Underdesign (over-estimation of interference fit fasteners)

**Figure A2-2 Circumferential Joints and Stringers (MSD/MED)**

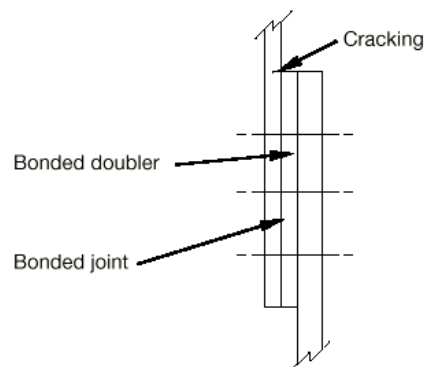
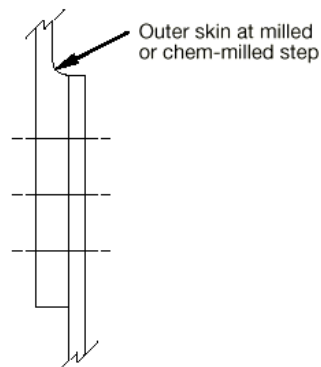

**Type and possible location of MSD and MED**

- MSD—abrupt cross section change
- Milled radius
- Chem-milled radius
- Bonded doubler runout

**Service or test experience of factors that influence MSD and MED (examples)**

- High bending stresses due to eccentricity

**Figure A2-3 Lap joints with Milled, Chem-milled or Bonded Radius (MSD)**

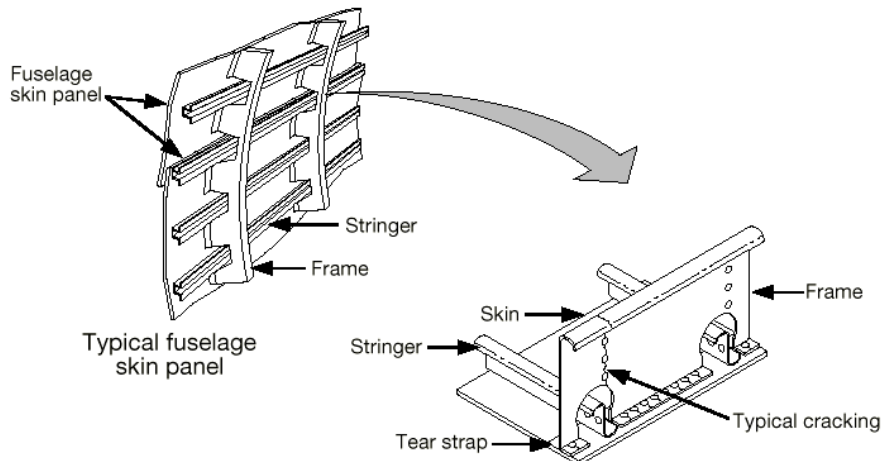

**Type and possible location of MSD/MED**

- MED—the cracking of frames at stringer cutouts at successive longitudinal locations in the fuselage. The primary concern is for those areas where noncircular frames exist in the fuselage structure. Fractures in those areas would result in panel instability.

**Service or test experience of factors that influence MSD and/or MED (examples)**

- High bending—noncircular frames
- Local stress concentrations
  - Cutouts
  - Shear attachments

**Figure A2-4 Fuselage Frames (MED)**

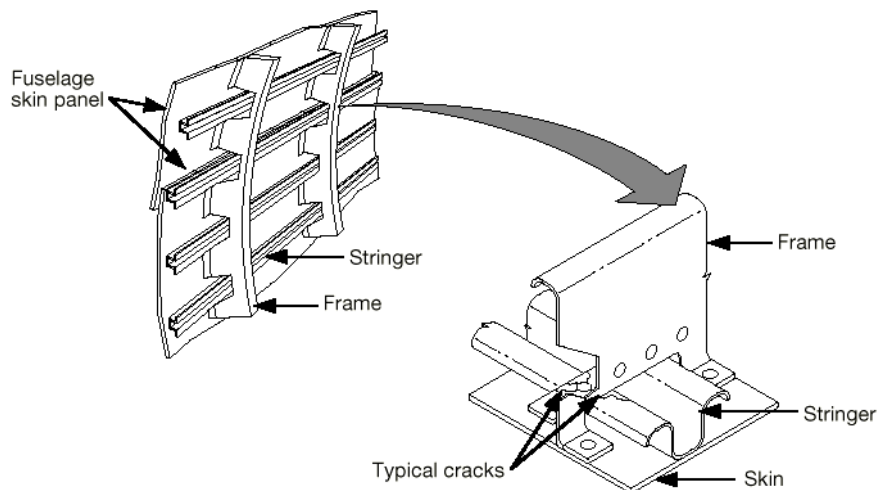

**Type and possible location of MED**

- MED—any combination of fracture of frames, clips, or stringers, including the attachments, resulting in the loss of the shear tie between the frame and stringer. This condition may occur at either circumferential or longitudinal locations at fuselage frame/stringer intersection.

**Service or test experience of factors that influence MSD and/or MED (examples)**

- Poor load path connection

**Figure A2-5 Stringer to Frame Attachments (MED)**

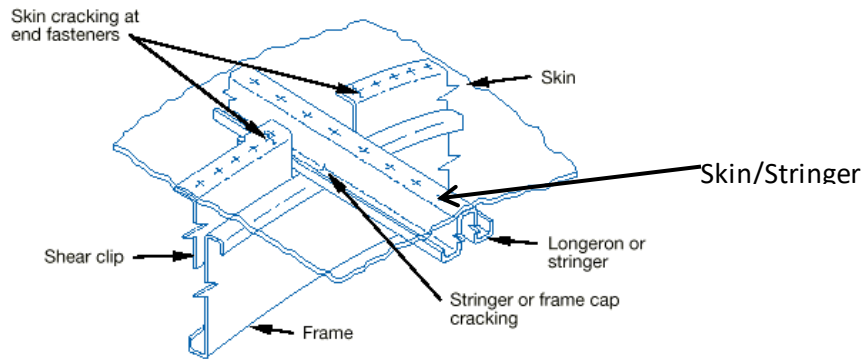

Type and possible location of MSD and MED

- MSD—skin at end fastener of shear clip
- MED—cracking in stringer or longeron at frame attachment
- MED—cracking in frame at stringer or longeron attachment

Service or test experience of factors that influence MSD and MED (examples)

- Preload
- Localized bending due to pressure
- Discontinuous load path

Figure A2-6 Shear Clip End Fasteners on Shear Tied Fuselage Frame (MSD/MED)

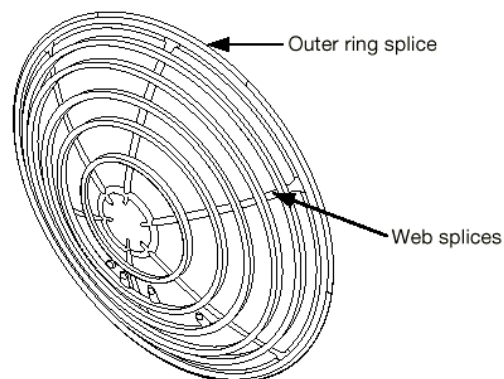

Type and possible location of MSD/MED

- MSD/MED—outer ring splice
  - Attachment profiles—at fastener rows and/or in radius area
- MED—web splices
  - Bulkhead skin and/or splice plates—at critical fastener rows

Typical outer ring splices

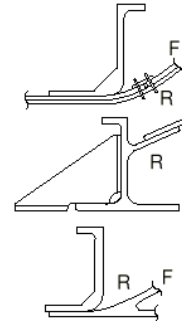

Legend:  
F fastener  
R radius

Service or test experience of factors that influence MSD and/or MED (examples)

- Corrosion
- High stresses—combined tension and compression
- High induced bending in radius
- Inadequate finish in radius—surface roughness

Figure A2-7 Aft Pressure Dome Outer Ring and Dome Web Splices (MSD/MED)

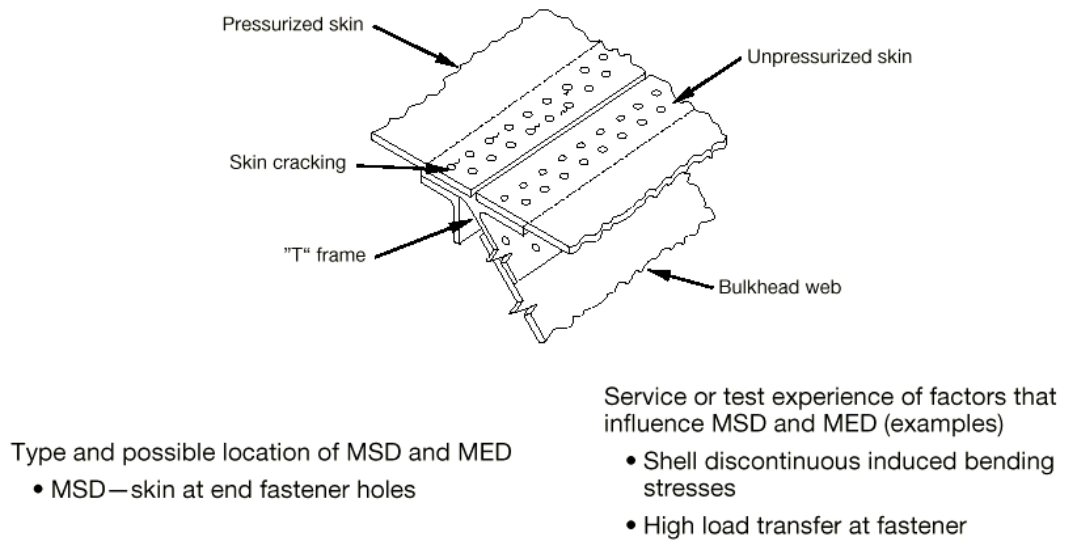

Figure A2-8 Skin Splice at Aft Pressure Bulkhead (MSD)

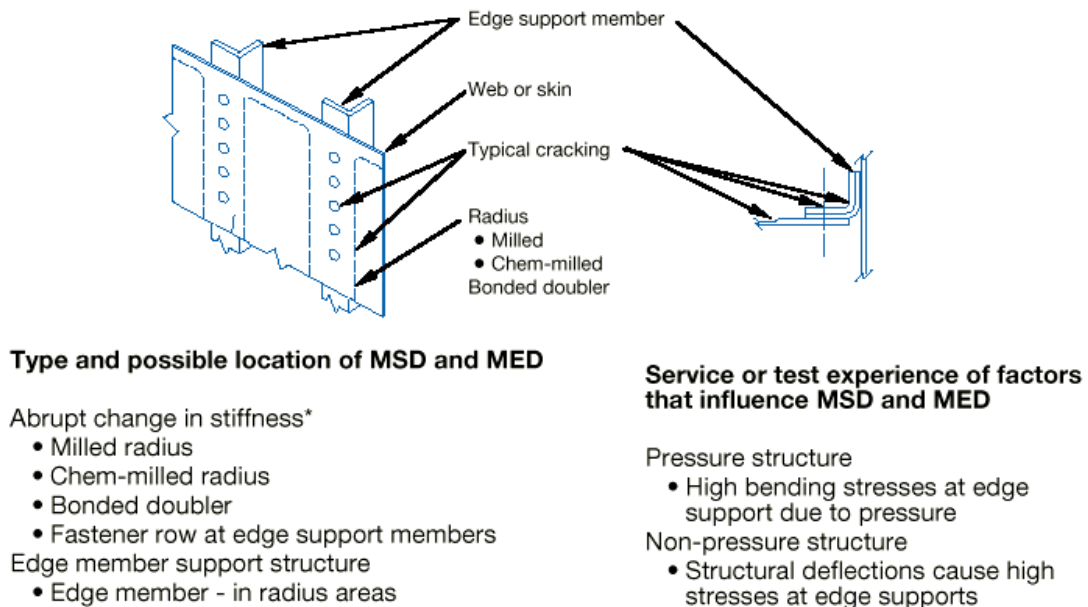
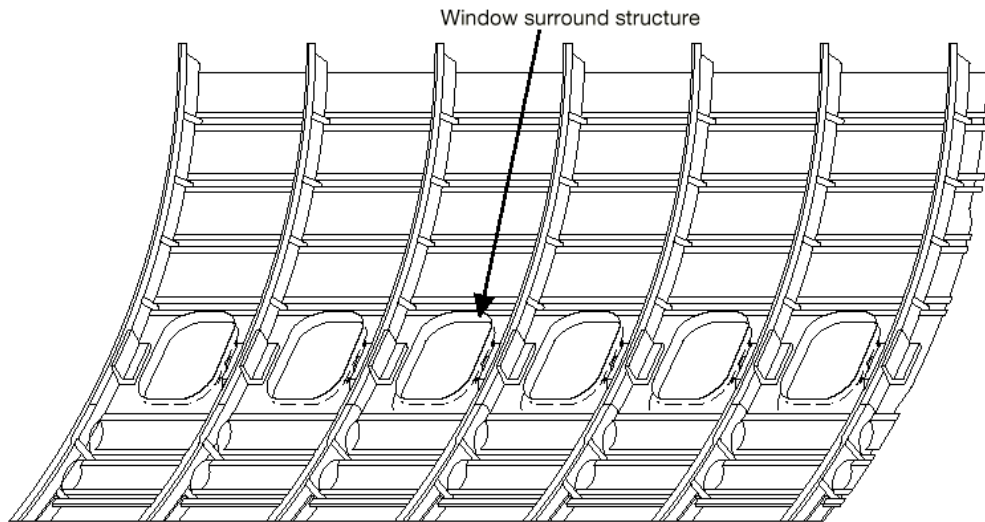

Figure A2-9 Abrupt Changes in Web or Skin Thickness — Pressurised or Unpressurised Structure (MSD/MED)



Type and possible location of MSD/MED

- MSD—skin at attachment to window surround structure
- MED—repeated details in reinforcement of window cutouts or in window corners

Service or test experience of factors that influence MSD and/or MED (examples)

- High load transfer

**Figure A2-10 Window Surround Structure (MSD, MED)**

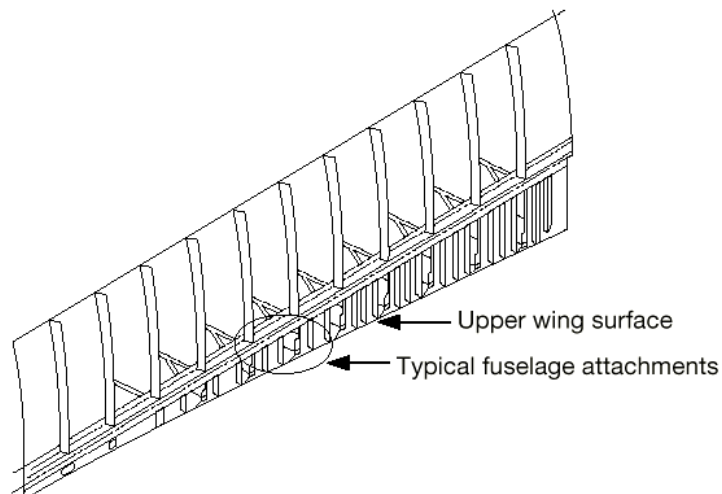

Type and possible location of MSD/MED

- MED—repeated details in overwing fuselage attachments

Service or test experience of factors that influence MSD and/or MED (examples)

- Manufacturing defect—prestress
- Induced deflections

**Figure A2-11 Over Wing Fuselage Attachments (MED)**

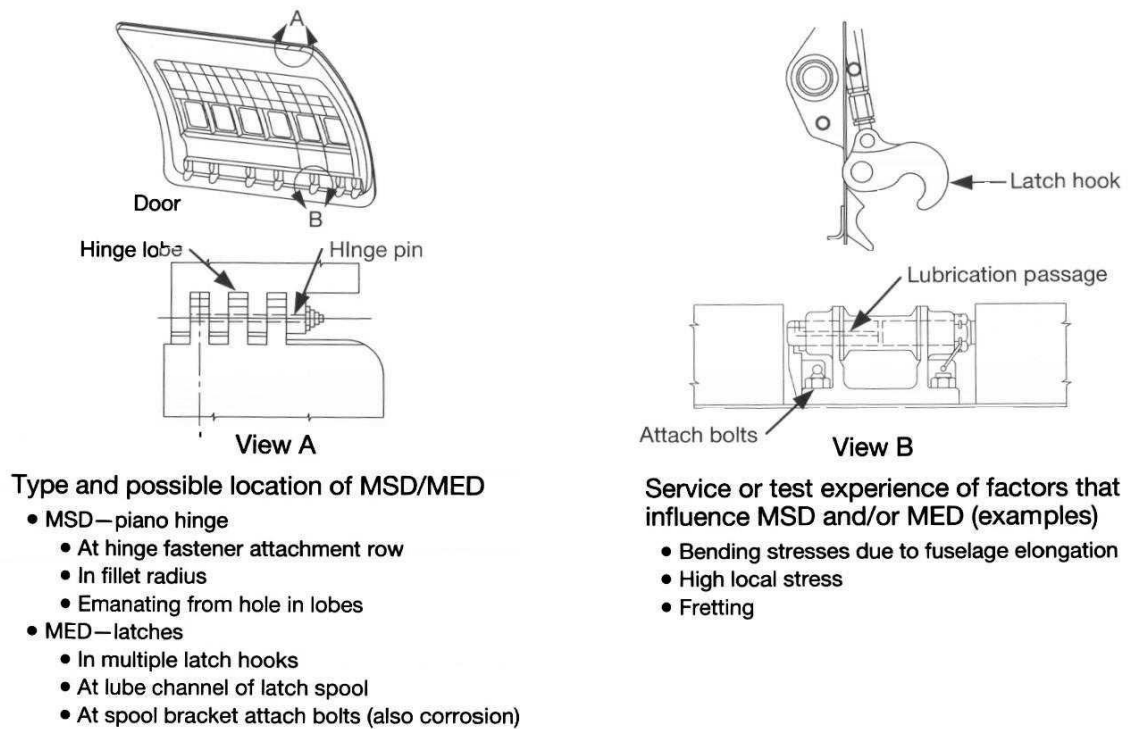
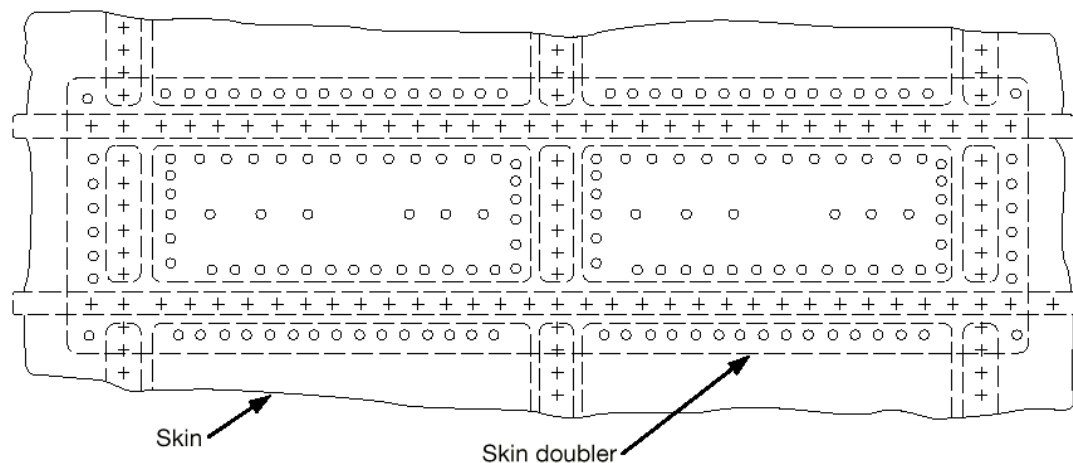

Figure A2-12 Latches and Hinges of Non-plug Doors (MSD/MED)



**Type and possible location of MSD/MED**

- MSD—cracks initiated at multiple critical fastener holes in skin at runout of doubler

**Service or test experience of factors that influence MSD and/or MED (examples)**

- High load transfer—high local stress

Figure A2-13 Skin at Runout of Large Doubler (MSD) — Fuselage, Wing or Empennage

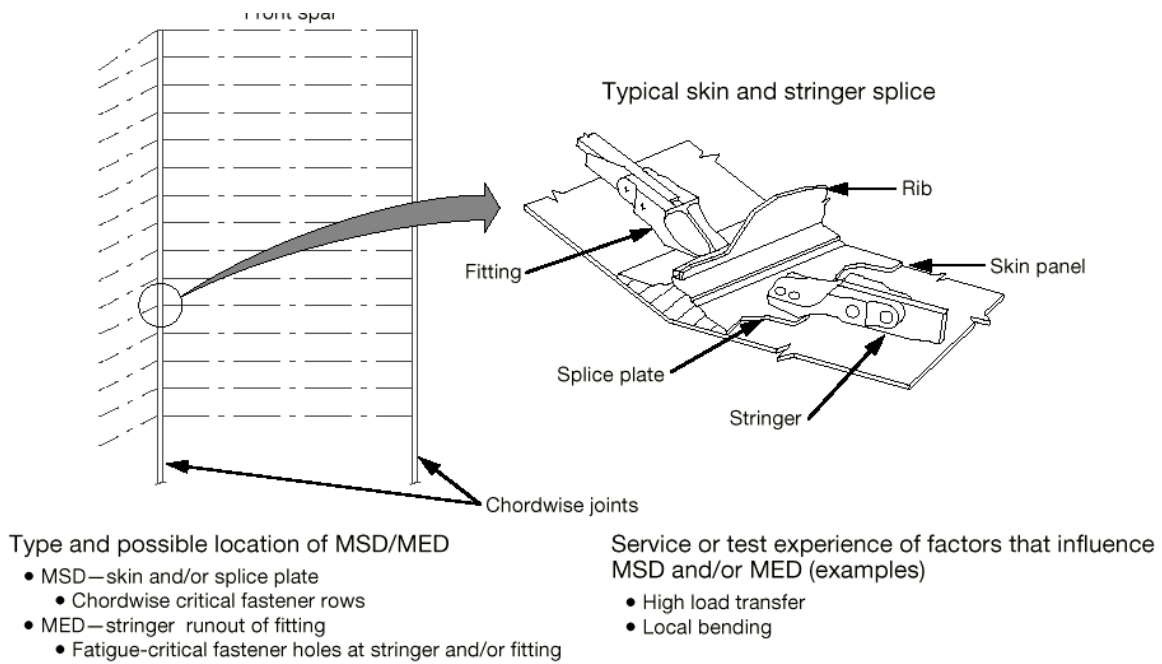

Figure A2-14 Wing or Empennage Chordwise Splices (MSD/MED)

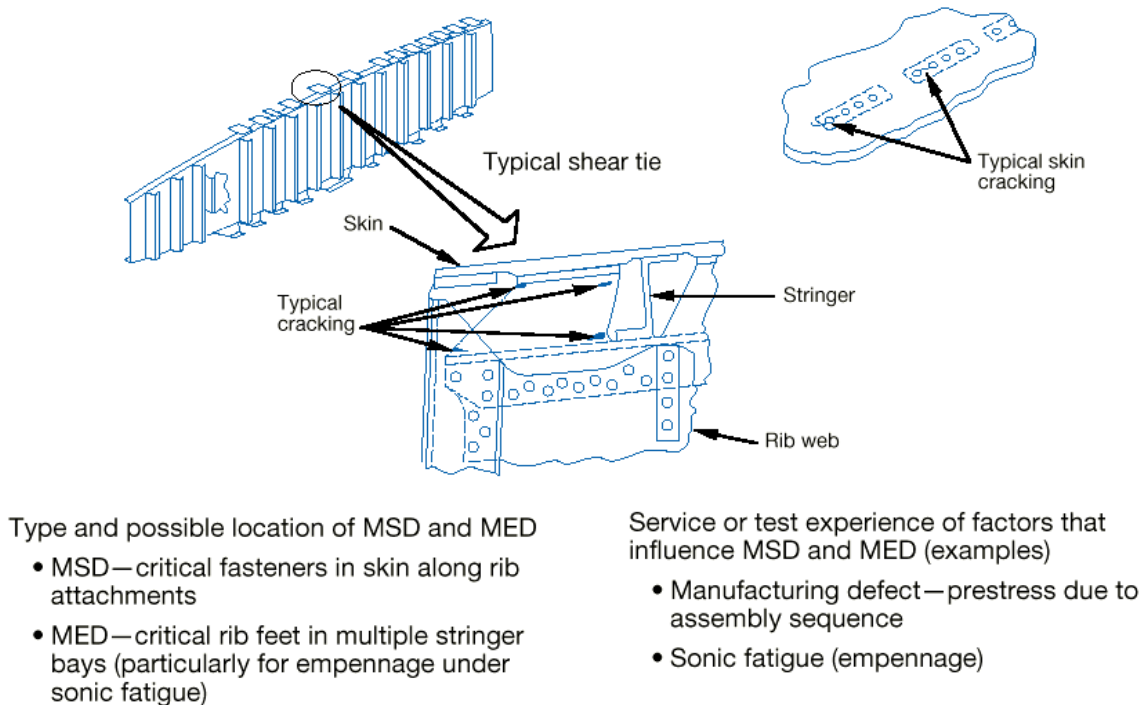

Figure A2-15 Rib to Skin Attachments (MSD/MED)

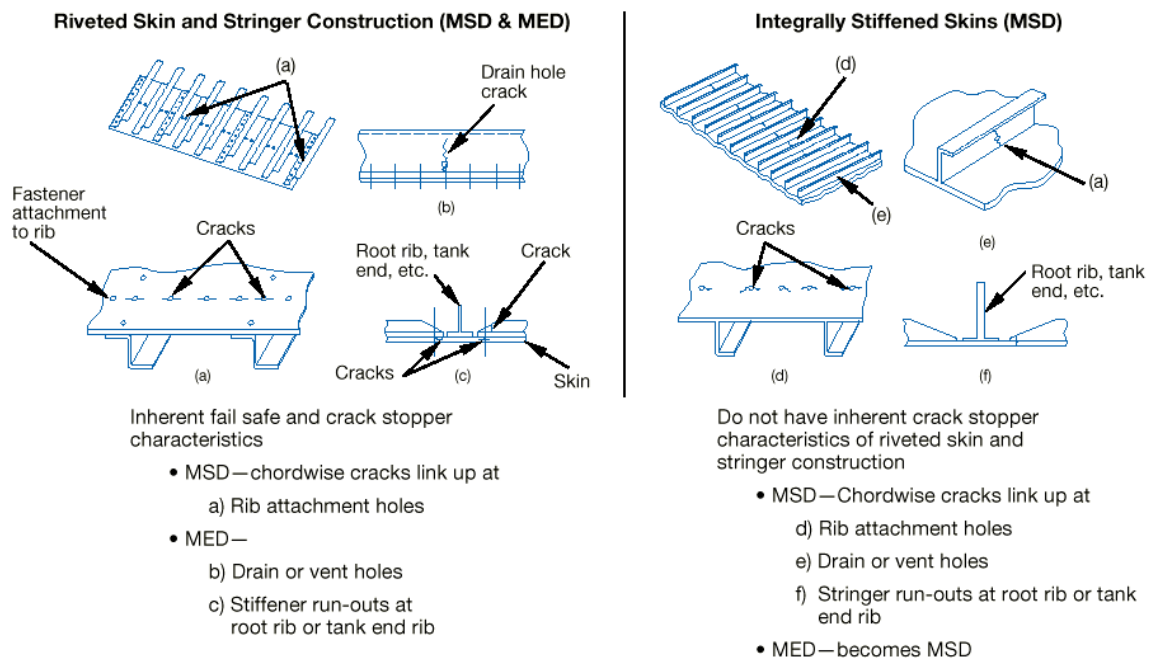

Figure A2-16 Typical Wing and Empennage Construction (MSD/MED)

### 4.3 WFD Evaluation

By the time the highest-time aircraft of a particular model reaches its DSG, the evaluation for each area susceptible to the development of WFD should be completed. A typical evaluation process is shown in Figure A2-17, below. This evaluation will establish the necessary elements to determine a maintenance programme to preclude WFD in that particular model's aircraft fleet. These elements are developed for each susceptible area and include:

#### 4.3.1 Identification of structure potentially susceptible to WFD

The TCH should identify each part of the aircraft's structure that is potentially susceptible to WFD for further evaluation. A justification should be given that supports selection or rejection of each area of the aircraft structure. DAHs for modified or repaired structure should evaluate their structure and its affect on existing structure.

Typical examples of structure susceptible to WFD are included in paragraph 4.2 of this appendix.

#### 4.3.2 Determination of WFD average behaviour in the fleet:

The time in terms of flight cycles/hours defining the WFD average behaviour in the fleet should be established. The data to be assessed in determining the WFD average behaviour includes:

- a review of the service history of the susceptible areas to identify any occurrences of fatigue cracking,
- evaluation of the operational statistics of the fleet in terms of flight hours and landings,
- significant production variants (material, design, assembly method, and any other change that might affect the fatigue performance of the detail),



- fatigue test evidence including relevant full-scale and component fatigue and damage tolerance test data (see sub-paragraph 4.3.10 for more details),
- teardown inspections, and
- any fractographic analysis available.

The evaluation of the test results for the reliable prediction of the time to when WFD might occur in each susceptible area should include appropriate test-to-structure factors. If full-scale fatigue test evidence is used, Figure A2-18, below, relates how that data might be utilised in determining WFD Average Behaviour. Evaluation may be analytically determined, supported by test and, where available, service evidence.

#### 4.3.3 Initial Crack/Damage Scenario

This is an estimate of the size and extent of multiple cracking expected at MSD/MED initiation. This prediction requires empirical data or an assumption of the crack/damage locations and sequence plus a fatigue evaluation to determine the time to MSD/MED initiation. Alternatively, analysis can be based on either:

- the distribution of equivalent initial flaws, as determined from the analytical assessment of flaws found during fatigue test and/or teardown inspections regressed to zero cycles; or
- a distribution of fatigue damage determined from relevant fatigue testing and/or service experience.

#### 4.3.4 Final Cracking Scenario

This is an estimate of the size and extent of multiple cracking that could cause residual strength to fall to certification levels. Techniques exist for 3-D elastic-plastic analysis of such problems; however, there are several alternative test and analysis approaches available that provide an equivalent level of safety. One such approach is to define the final cracking scenario as a sub-critical condition (e.g., first crack at link-up at limit load). Use of a sub-critical scenario reduces the complexity of the analysis and, in many cases, will not greatly reduce the total crack growth time.

#### 4.3.5 Crack Growth Calculation

Progression of the crack distributions from the initial cracking scenario to the final cracking scenario should be developed. These curves can be developed:

- analytically, typically based on linear elastic fracture mechanics, or
- empirically, from test or service fractographic data.

#### 4.3.6 Potential for Discrete Source Damage (DSD)

A structure susceptible to MSD/MED may also be affected by DSD due to an uncontained failure of high-energy rotating machinery (i.e., turbine engines). The approach described in this guidance material should ensure the MSD sizes and densities, that normally would be expected to exist at the structural modification point, would not significantly change the risk of catastrophic failure due to DSD.

#### 4.3.7 Analysis Methodology:

The evaluation methods used to determine the WFD average behaviour and associated parameters will vary. The report “Recommendations for Regulatory Action to Prevent Widespread Fatigue Damage in the Commercial Aeroplane Fleet”, Revision A, dated June 29, 1999 (a report of the AAWG for the ARAC’s Transport Aircraft and Engine Issues Group), discusses two Round Robin exercises developed by the TCHs to provide insight into their respective methodologies. One outcome of the exercises was an identification of key assumptions or methods that had the greatest impact on the predicted WFD behaviour. These assumptions were:

- the flaw sizes assumed at initiation of crack growth phase of analysis;
- material properties used (static, fatigue, fracture mechanics);
- ligament failure criteria;
- crack growth equations used;
- statistics used to evaluate the fatigue behaviour of the structure (e.g., time to crack initiation);
- methods of determining the structure modification point (SMP);
- detectable flaw size assumed;
- initial distribution of flaws; and
- factors used to determine bound behaviour as opposed to mean behaviour.
- The following parameters are developed from paragraphs 4.3.2 through 4.3.7 above, and are necessary to establish a MSD/MED maintenance programme for the area under investigation.

#### 4.3.8 Inspection Start Point (ISP):

This is the point at which inspection starts if a monitoring period is used. It is determined through a statistical analysis of crack initiation based on fatigue testing, teardown, or service experience of similar structural details. It is assumed that the ISP is equivalent to a lower bound value with a specific probability in the statistical distribution of cracking events. Alternatively, the ISP may be established by applying appropriate factors to the average behaviour.

#### 4.3.9 Considerations:

Due to the redundant nature of semi-monocoque structure, MED can be difficult to manage in a fleet environment. This stems from the fact that most aircraft structures are built-up in nature, and that makes the visual inspection of the various layers difficult. Also, visual inspections for MED typically rely on internal inspections, which may not be practical at the frequency necessary to preclude MED due to the time required to gain access to the structure. However, these issues are dependent on the specific design involved and the amount of damage being considered. In order to implement a viable inspection programme for MED, the following conditions must be met:

- a) Static stability must be maintained at all times.
- b) Large damage capability should be maintained.

- c) There is no concurrent MED with MSD in a given structural area.

#### 4.3.10 Structural Modification Point (SMP)

The applicant should demonstrate that the proposed SMP established during the evaluation has the same confidence level as current regulations require for new certification. In lieu of other acceptable methods, the SMP can be established as a point reduced from the WFD Average Behaviour, based on the viability of inspections in the monitoring period. The SMP can be determined by dividing the WFD Average Behaviour by a factor of 2 if there are viable inspections, or by a factor of 3 if inspections are not viable.

Whichever approach is used to establish the SMP, a study should be made to demonstrate that the approach ensures that the structure with the expected extent of MSD/MED at the SMP maintains a LDC.

An aircraft should not be operated past the SMP unless the structure is modified or replaced, or unless additional approved data is provided that would extend the SMP. However, if during the structural evaluation for WFD, a TCH/DAH finds that the flight cycles and/or flight hours SMP for a particular structural detail have been exceeded by one or more aircraft in the fleet, the TCH/DAH should expeditiously evaluate selected high time aircraft in the fleet to determine their structural condition. From this evaluation, the TCH/DAH should notify the competent authorities and propose appropriate service actions.

The initial SMP may be adjusted based on the following:

- (a) In some cases, the SMP may be extended without changing the required reliability of the structure, i.e. projection to that of a two life time full-scale fatigue test. These cases may generally be described under the umbrella of additional fatigue test evidence and include either or a combination of any or all of the following:

Additional fatigue and/or residual strength tests on a full-scale aircraft structure or a full-scale component followed by detailed inspections and analyses.

Testing of new or used structure on a smaller scale than full component tests (i.e., sub-component and/or panel tests).

Teardown inspections (destructive) that could be done on structural components that have been removed from service.

Local teardown by selected, limited (non-destructive) disassembly and refurbishment of specific areas of high-time aircraft.

In-service data from a statistically significant number of aircraft close to the original SMP showing no cracking compared with the predictions, taking into account future variability in service usage and loading compared to the surveyed aircraft. This data may be used to support increasing the original SMP by an amount that is agreed by the competent authority.

- (b) If cracks are found in the structural detail for which the evaluation was done during either the monitoring period or the modification programme, the SMP should be re-evaluated to ensure that the SMP does in fact provide the required confidence level. If it is shown that the required confidence level is not being met, the SMP should be adjusted and the adjustment reflected

in appropriate service bulletins to address the condition of the fleet. Additional regulatory action may be required.

#### 4.3.11 Inspection Interval and Method:

An interval should be chosen to provide a sufficient number of inspections between the ISP and the SMP so that there is a high confidence that no MSD/MED condition will reach the final cracking scenario without detection. The interval is highly dependent on the detectable crack size and the probability of detection associated with the specific inspection method. If the crack cannot be detected, the SMP must be re-evaluated to ensure there is a high confidence level that no aircraft will develop MSD/MED before modification.

#### 4.4 Evaluation of Maintenance Actions

For all areas that have been identified as susceptible to MSD/MED, the current maintenance programme should be evaluated to determine if adequate structural maintenance and inspection programmes exist to safeguard the structure against unanticipated cracking or other structural degradation. The evaluation of the current maintenance programme typically begins with the determination of the SMP for each area.

Each area should then be reviewed to determine the current maintenance actions and compare them to the maintenance needs established in this evaluation. Issues to be considered include the following:

- (a) Determine the inspection requirements (method, inspection start point, and repeat interval) of the inspection for each susceptible area (including that structure that is expected to arrest cracks) that is necessary to maintain the required level of safety.
- (b) Review the elements of the existing maintenance programmes already in place
- (c) Revise and highlight elements of the maintenance programme necessary to maintain safety.

For susceptible areas approaching the SMP, where the SMP will not be increased or for areas that cannot be reliably inspected, a programme should be developed and documented that provides for replacement or modification of the susceptible structural area.

##### 4.4.1 Period of WFD Evaluation Validity:

At whatever point the WFD evaluation is made, it should support the limit of validity (LOV) of the maintenance programme. Consistent with the use of test evidence to support individual SMPs, as described above in paragraph 4.3.10, the LOV of the maintenance programme should be based on fatigue test evidence. The initial WFD evaluation of the complete airframe will typically cover a significant forward estimation of the projected aircraft usage beyond its DSG, also known as the “proposed ESG.” An evaluation through at least an additional twenty-five percent of the DSG would provide a realistic forecast, with reasonable planning time for necessary maintenance action. However, it may be appropriate to adjust the evaluation validity period depending on issues such as:

- (a) The projected useful life of the aircraft at the time of the initial evaluation;

- (b) Current non-destructive inspection (NDI) technology; and
- (c) Airline advance planning requirements for introduction of new maintenance and modification programmes, to provide sufficient forward projection to identify all likely maintenance/modification actions essentially as one package.

Upon completion of the evaluation and publication of the revised maintenance requirements, the “proposed ESG” becomes the Limit of Validity (LOV)

Note: This assumes that all other aspects of the maintenance programme that are required to support the LOV (such as SSID, CPCP, etc.) are in place and have been evaluated to ensure they too remain valid up to the LOV.

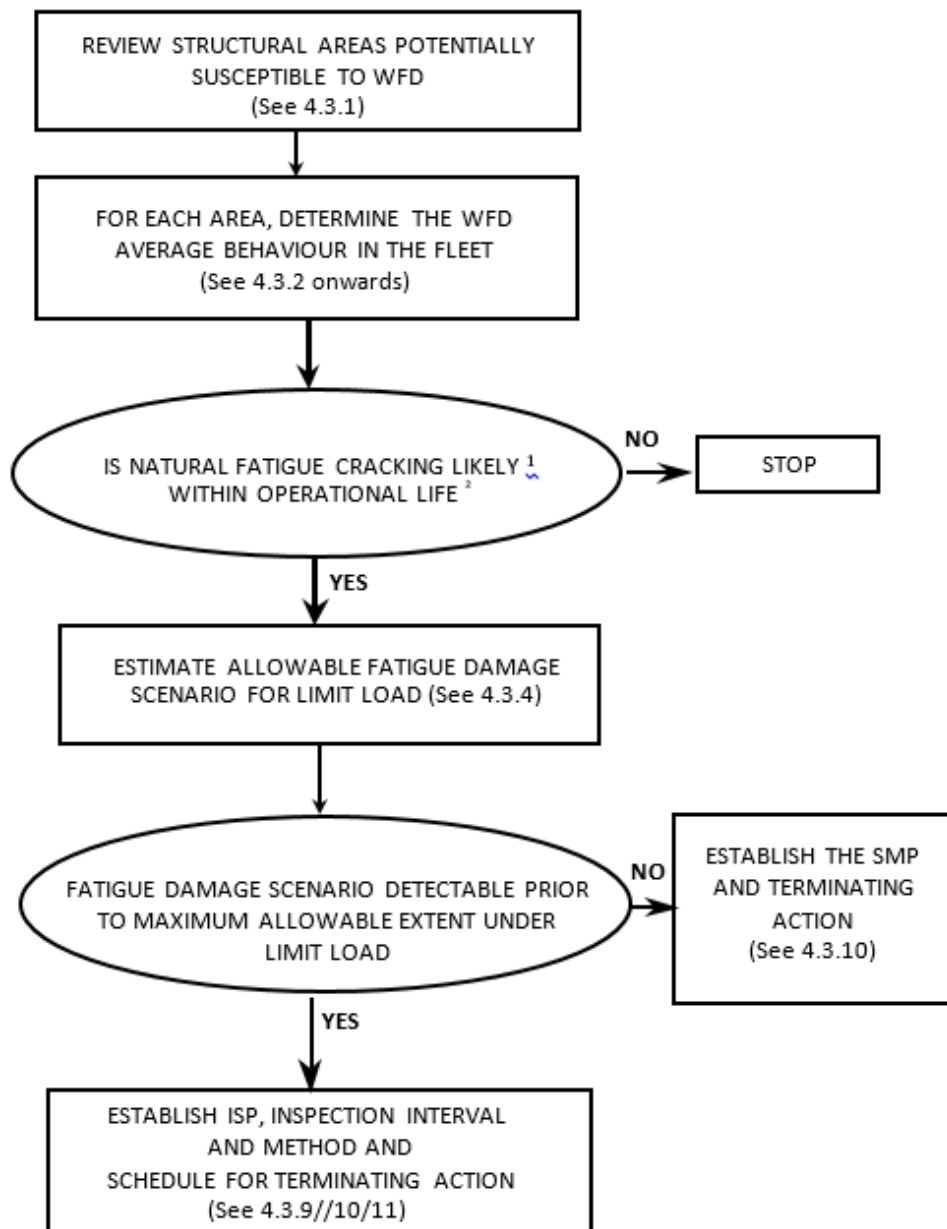

NOTES:

1. Fatigue cracking is defined as likely if the factored fatigue life is less than the projected ESG of the aircraft at time of WFD evaluation.
2. The operational life is the projected ESG of the aircraft at time of WFD Evaluation. (See 4.4.1).

Figure A2-17: Aircraft Evaluation Process

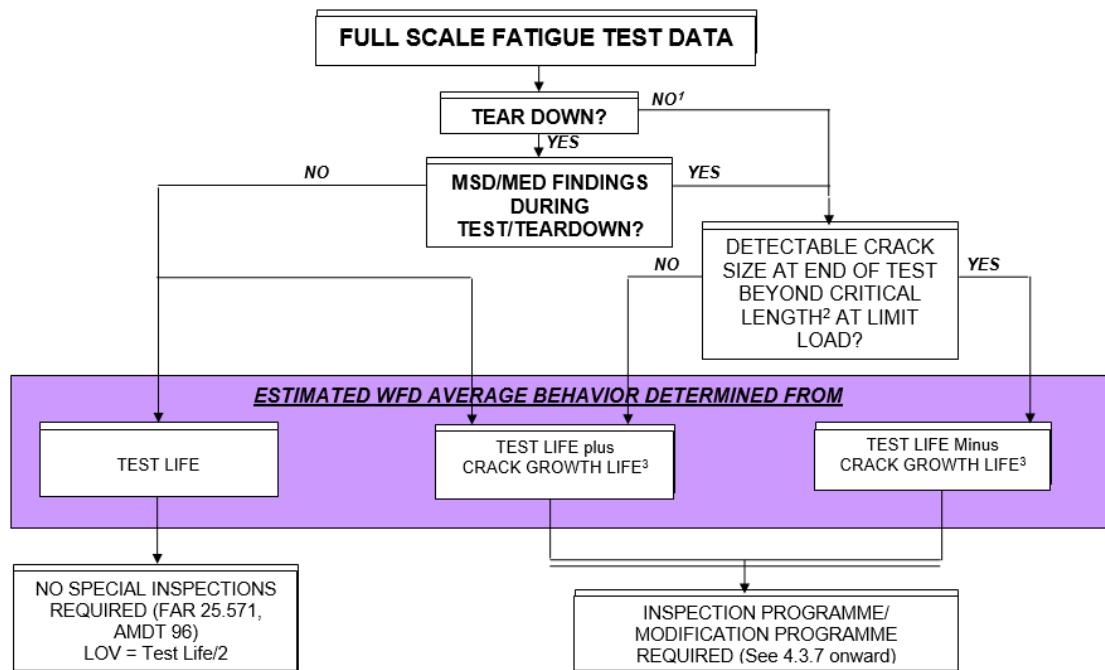

1 **ASSUMED STATE AT END OF TEST:** Best estimate of non-detected damage from inspection method used at end of test or during teardown.  
 2 **CRITICAL CRACK LENGTH:** First link-up of adjacent cracks at limit load (locally) or an adequate level of large damage capability.  
 3 **CRACK GROWTH LIFE:** Difference between assumed or actual state at end of test and critical crack length.

Figure A2-18 Use of Fatigue Test and Teardown Information to Determine WFD Average Behaviour

## 5. Documentation

Any person developing a programme should develop a document containing recommendations for inspection procedures and replacement or modification of parts or components necessary to preclude WFD, and establish the new limit of validity of the operator’s maintenance programme. That person also must revise the SSID or ALS as necessary, and/or prepare service bulletins that contain the recommendations for inspection procedures and replacement or modification of parts or components necessary to preclude WFD. Since WFD is a safety concern for all operators of older aircraft, the Agency will make mandatory the identified inspection or modification programmes. In addition, the Agency may consider separate AD action to address any service bulletins or other service information publications revised or issued as a result of in-service MSD/MED findings resulting from implementation of these programmes.

The following items should be contained in the front of the approved document:

- Identification of the variants of the basic aircraft type to which the document relates;
- Summary of the operational statistics of the fleet in terms of hours and flights;
- Description of the typical mission, or missions;
- The types of operations for which the inspection programme is considered valid;
- Reference to documents giving any existing inspections, or modification of parts or components; and
- The LOV of the maintenance programme in terms of flight cycles or flight hours or both as appropriate to accommodate variations in usage.

The approved document should contain at least the following information for each critical part or component:

- (a) Description of the Primary Structure susceptible to WFD;
- (b) Details of the monitoring period (inspection start point, repeat inspection interval, SMP, inspection method and procedure (including crack size, location and direction) and alternatives) when applicable;
- (c) Any optional modification or replacement of the structural element as terminating action to inspection;
- (d) Any mandatory modification or replacement of the structural element;
- (e) Service bulletins (or other service information publications) revised or issued as a result of in-service findings resulting from the WFD evaluations (added as a revision to the initial WFD document); and
- (f) Guidance to the operator on which inspection findings should be reported to the TCH/DAH, and appropriate reporting forms and methods of submittal.

## 6. REPORTING REQUIREMENTS

Operators, TCHs and STC Holders are required to report in accordance with various regulations, for example Part 21.3, Part 145.60. The regulations to which this AMC relates do not require any reporting requirements in addition to the current ones. Due to the potential threat to structural integrity, the results of inspections must be accurately documented and reported in a timely manner to preclude the occurrence of WFD. The current system of operator and TCH communication has been useful in identifying and resolving a number of issues that can be classified as WFD concerns. MSD/MED has been discovered via fatigue testing and in-service experience. TCHs have been consistent in disseminating related data to operators to solidify additional service experience. However, a more thorough means of surveillance and reporting is essential to preclude WFD.

When damage is found while conducting an approved MSD/MED inspection programme, or at the SMP where replacement or modification of the structure is occurring, the TCHs, STC Holders and the operators need to ensure that greater emphasis is placed on accurately reporting the following items:

- (a) A description (with a sketch) of the damage, including crack length, orientation, location, flight cycles/hours, and condition of structure;
- (b) Results of follow-up inspections by operators that identify similar problems on other aircraft in the fleet;
- (c) Findings where inspections accomplished during the repair or replacement/modification identify additional similar damage sites; and
- (d) Adjacent repairs.

Operators must report all cases of MSD/MED to the TCH, STC Holder or the competent authority as appropriate, irrespective of how frequently such cases occur. Cracked areas from in-service aircraft (damaged structure) may be needed for detailed examination. Operators are encouraged to provide fractographic specimens whenever possible. Aeroplanes undergoing heavy maintenance checks are perhaps the most useful sources for such specimens.

Operators should remain diligent in the reporting of potential MSD/MED concerns not identified by the TCH/DAH. Indications of a developing MSD/MED problem may include:

- (a) Damage at multiple locations in similar adjacent details;
- (b) Repetitive part replacement; or



- (c) Adjacent repairs.

Documentation will be provided by the TCH and STC Holder as appropriate to specify the required reporting format and time frame. The data will be reviewed by the TCH or STC Holder, operator(s), and the Agency to evaluate the nature and magnitude of the problem and to determine the appropriate corrective action.

## **7. STRUCTURAL MODIFICATIONS AND REPAIRS**

All major modifications (STCs) and repairs that create, modify, or affect structure that are susceptible to MSD/MED (as identified by the TCH) must be evaluated to demonstrate the same confidence level as the original manufactured structure. The operator is responsible together with the DAH for ensuring the accomplishment of this evaluation for each modified aircraft. The operator may first need to conduct an assessment on each of its aircraft to determine what modifications or repairs exist and would be susceptible to MSD/MED. The following are some examples of types of modifications and repairs that present such concerns:

- (a) Passenger-to-freighter conversions (including addition of main deck cargo doors);
- (b) Gross weight increases (increased operating weights, increased zero fuel weights, increased landing weights and increased maximum takeoff weights);
- (c) Installation of fuselage cutouts (passenger entry doors, emergency exit doors or crew escape hatches, fuselage access doors and cabin window relocations);
- (d) Complete re-engine and/or pylon modifications;
- (e) Engine hush-kits and nacelle modifications;
- (f) Wing modifications, such as the installation of winglets or changes in flight control settings (flap droop), and changes to wing trailing edge structure;
- (g) Modified, repaired, or replaced skin splice;
- (h) Any modification or repair that affects several frame bays; and
- (i) Multiple adjacent repairs.

Other potential areas that must be considered include:

- (a) A modification that covers structure requiring periodic inspection by the operator's maintenance programme (Modifications must be reviewed to account for the differences with TCH baseline maintenance programme requirements.);
- (b) A modification that results in operational mission change that significantly changes manufacturer's load/stress spectrum (for example, a passenger-to-freighter conversion); and
- (c) A modification that changes areas of the fuselage from being externally inspectable using visual means to being uninspectable (for example, a large external fuselage doubler that resulted in hidden details, rendering them visually uninspectable).

## **8. RESPONSIBILITY**

While the primary responsibility is with the DAH to perform the analyses and supporting tests, it is expected that the evaluation will be conducted in a cooperative effort between the operators and TCHs/DAHs, with participation by the Agency.

[Amdt 20/2]

## Appendix 3 to AMC 20-20 Guidelines for establishing instructions for continued airworthiness of structural repairs and modifications

ED Decision 2007/019/R

### 1. INTRODUCTION

With an SSID, CPCP and LOV in place an individual aircraft may still not meet the intended level of airworthiness for ageing aircraft structures. Repairs and modifications to aircraft structure also require investigation. For large transport aeroplanes, all repairs and modifications that affect FCS should be assessed using some form of damage-tolerance based evaluation. A regulatory requirement for damage-tolerance was not applied to aeroplane designs type certificated before 1978, and even after this time, implementation of DTE on repairs and modifications was not consistent. Therefore the damage-tolerance characteristics of repairs and modifications may vary widely and are largely unknown. In view of these concerns it is necessary to perform an assessment of repairs and modifications on existing aircraft to establish their damage-tolerance characteristics.

### 2. DEFINITIONS

For the purposes of this Appendix, the following definitions apply:

- **Damage Tolerance Data** are damage tolerance evaluation (DTE) documentation and the damage tolerance inspections (DTIs).
- **Damage Tolerance Evaluation (DTE)** is a process that leads to a determination of maintenance actions necessary to detect or preclude fatigue cracking that could contribute to a catastrophic failure. As applied to repairs and modifications, a DTE includes the evaluation of the repair or modification and the fatigue critical structure affected by the repair or modification. The process utilises the damage tolerance procedures as described in CS-25 AMC 25.571.
- **Damage Tolerance Inspections (DTIs)** are the inspections developed as a result of a DTE. A DTI includes the areas to be inspected, the inspection method, the inspection procedures, including acceptance and rejection criteria, the threshold, and any repetitive intervals associated with those inspections. The DTIs may specify a time limit when a repair or modification needs to be replaced or modified. If the DTE concludes that DT-based supplemental structural inspections are not necessary, the DTI documentation should include a statement that the normal zonal inspection programme is sufficient.
- **Fatigue Critical Baseline Structure (FCBS)** is the baseline structure of the aircraft that is classified as fatigue critical structure.

### 3. ESTABLISHMENT OF A DAMAGE-TOLERANT BASED INSPECTION PROGRAMME FOR REPAIRS AFFECTING FCS

Repairs are a concern on older aircraft because of the possibility that they may develop, cause, or obscure metal fatigue, corrosion, or other damage during service. This damage might occur within the repair itself or in the adjacent structure and might ultimately lead to structural failure.

In general, repairs present a more challenging problem to solve than the original structure because they are unique and tailored in design to correct particular damage to the original structure. Whereas the performance of the original structure may be predicted from tests and from experience on other aircraft in service, the behaviour of a repair and its effect on the

fatigue characteristics of the original structure are generally known to a lesser extent than for the basic un-repaired structure.

Repairs may be of concern as time in service increases for the following reasons:

As aircraft age, both the number and age of existing repairs increase. Along with this increase is the possibility of unforeseen repair interaction, failure, or other damage occurring in the repaired area. The continued operational safety of these aircraft depends primarily on a satisfactory maintenance programme (inspections conducted at the right time, in the right place, using the most appropriate technique or in some cases replacement of the repair). To develop this programme, a damage-tolerance evaluation of repairs to aircraft structure is essential. The longer an aircraft is in service, the more important this evaluation and a subsequent inspection programme becomes.

The practice of repair justification has evolved gradually over the last 20 plus years. Some repairs described in the aircraft manufacturers' SRMs were not designed to fatigue and damage-tolerance principles. (Ref. AAWG Report: Recommendations concerning ARAC taskings FR Doc.04-10816 Re: Aging Aircraft Safety Final Rule. 14 CFR 121.370a and 129.16.) Repairs accomplished in accordance with the information contained in the early versions of the SRMs may require additional inspections if evaluated using the fatigue and damage-tolerance methodology.

Damage-tolerance is a structural design and inspection methodology used to maintain safety considering the possibility of metal fatigue or other structural damage (i.e., safety is maintained by adequate structural inspection until the damage is repaired). One prerequisite for the successful application of the damage tolerance approach for managing fatigue is that crack growth and residual strength can be anticipated with sufficient precision to allow inspections to be established that will detect cracking before it reaches a size that will degrade the strength below a specified level. A damage-tolerance evaluation entails the prediction of sites where fatigue cracks are most likely to initiate in the aircraft structure, the prediction of the crack path and rates of growth under repeated aircraft structural loading, the prediction of the size of the damage at which strength limits are exceeded, and an analysis of the potential opportunities for inspection of the damage as it progresses. This information is used to establish an inspection programme for the structure that will be able to detect cracking that may develop before it precipitates a major structural failure.

The evidence to date is that when all critical structure is included, damage-tolerant based inspections and procedures, including modification and replacement, provide the best assurance of continued structural integrity that is currently available. In order to apply this concept to existing transport aeroplanes, the competent authorities issued a series of ADs requiring compliance with the first supplemental inspection programmes resulting from application of this concept to existing aeroplanes. Generally, these ADs require that operators incorporate SSIDs into their maintenance programmes for the affected aeroplanes. These documents were derived from damage-tolerance assessments of the originally certificated type designs for these aeroplanes. For this reason, the majority of ADs written for the SSIP did not attempt to address issues relating to the damage-tolerance of repairs that had been made to the aeroplanes. The objective of this programme is to provide the same level of assurance for areas of the structure that have been repaired as that achieved by the SSIP for the baseline structure as originally certificated.

The fatigue and damage-tolerance evaluation of a repair would be used in an assessment programme to establish an appropriate inspection programme, or a replacement schedule if the necessary inspection programme is too demanding or not possible. The objective of the

repair assessment is to assure the continued structural integrity of the repaired and adjacent structure based on damage-tolerance principles. Any identified supplemental inspections are intended to detect damage which may develop in a repaired area, before that damage degrades the load carrying capability of the structure below the levels required by the applicable airworthiness standards.

The following guidance is intended to help TCHs and operators establish and implement a damage-tolerant based maintenance programme for repairs affecting FCBS. Additional guidance for repairs to modified structure is provided in paragraph 4.

### 3.1 Overview of the TCH tasks for repairs that may affect FCBS

- (a) Identify the affected aircraft model, models, aircraft serial numbers, and DSG stated as a number of flight cycles, flight hours, or both.
- (b) Identify the certification level.
- (c) Submit the list of FCBS to EASA for approval, and make it available to operators and STC holders.
- (d) Review and update published repair data as necessary.
- (e) Submit any new or updated published repair data to EASA for approval, and make it available to operators.
- (f) Develop Repair Evaluation Guidelines (REGs) and submit them to EASA for approval, and make the approved REGs available to operators.

### 3.2 Certification Level

In order to understand what data is required, the TCH should identify the amendment level of the original aircraft certification relative to CS 25.571. The amendment level is useful in identifying what DT Data may be available and what standard should be used for developing new DT Data. The two relevant aircraft groups are:

Group A - Aircraft certified to CAR 4b or § 25.571, prior to Amendment 25-45 or equivalent. These aircraft were not evaluated for damage tolerance as part of the original type certification. Unless previously accomplished, existing and future repairs to FCBS will need DT Data developed.

Group B - Aircraft certified to § 25.571, Amendment 25-45 or later. These aircraft were evaluated for damage tolerance as part of the original type certification. As noted in the introduction, some of these repairs may not have repair data that includes appropriate DTI and the TCH and operators may need to identify and perform a DTE of these repairs and develop DTI.

### 3.3 Identifying Fatigue Critical Baseline Structure (FCBS)

TC Holders should identify and make available to operators a list of baseline structure that is susceptible to fatigue cracking that could contribute to a catastrophic failure. The term "baseline" refers to the structure that is designed under the original type certificate or amended type certificate for that aircraft model (that is, the as delivered aircraft model configuration). Guidance for identifying this structure can be found in CS-25 AMC 25.571. This structure is referred to in this AMC as "fatigue critical baseline structure." The purpose of requiring identification and listing of fatigue critical structure (FCS) is to provide operators with a tool that will help in the evaluating existing and future repairs or modifications. In this context, fatigue critical structure is any structure that is susceptible to fatigue that could contribute to a catastrophic failure, and should be

subject to a damage-tolerance evaluation (DTE). The DTE would determine if DTIs need to be established for the repaired or modified structure. For the purpose of this AMC, structure that is modified after aircraft delivery from the TCH is not considered to be “baseline” structure.

CS 25.571(a) states “An evaluation of the strength, detail design, and fabrication must show that catastrophic failure due to fatigue...will be avoided throughout the operational life of the aircraft. This evaluation must be conducted...for each part of the structure which could contribute to a catastrophic failure (such as wing, empennage, control surfaces, fuselage, engine mounts, and their related primary attachments)....” When identifying FCBS, it is not sufficient to consider only that structure identified in the supplemental structural inspection document (SSID) or airworthiness limitation section (ALS). Some SSIDs or ALSs might only include supplemental inspections of the most highly stressed elements of the FCBS. A SSID and ALS often refer to this structure as a Principal Structural Element (PSE). If repaired, other areas of structure not identified as a PSE in the SSID or ALS may require supplemental inspections. The term PSE has, at times, been applied narrowly by industry. The narrow application of the term PSE could incorrectly limit the scope of the structure that would be considered relative to fatigue if repairs or modifications exist or are subsequently made. The relationship between PSE and FCS could vary significantly depending on the TCH’s working definition of PSE. In addition, there may be structure whose failure would be catastrophic, but due to low operational loads on the part, the part will not experience fatigue cracking. However, if the subject part is repaired or modified, the stresses in the part may be increased to a level where it is now susceptible to fatigue cracking. These types of parts should be considered as fatigue critical structure.

TC Holders should develop the list of FCBS and include the locations of FCS and a diagram showing the extent of FCS. TC Holders should make the list available to STC Holders and to operators.

#### 3.4. Certification Standard Applied When Performing a DTE

For Group A aircraft, the TC Holder should use the requirements of § 25.571, at Amendment 25-45, as a minimum standard. For Group B aircraft, the TC Holder should use the requirements that correspond to the original certification basis as a minimum standard. For each repair requiring a DTE, the DAH should apply not less than the minimum standard when developing new or revised DT Data. The certification standard applied by the TC Holder in performing a DTE for repairs should be included with the relevant approved documentation to the operator.

#### 3.5. Performing a DTE on a Repair That Affects FCBS

When performing a DTE on a repair that affects FCBS, the DTE would apply to the affected FCBS and repair. This may consist of an individual analysis or the application of a DT-based process such as RAGs that would be used by an operator. The result of the DTE should lead to developing DTI that address any adverse effects the repair may have on the FCBS. If the DTE results determine that DTIs are not required to ensure the continued airworthiness of the affected FCBS, the TC Holder should note that in the DTE documentation.

The term “adverse effects” refers to a degradation in the fatigue life or inspectability of the affected FCBS. Degradation in fatigue life (earlier occurrence of critical fatigue cracking) may result from an increase in internal loading, while degradation of inspectability may result from physical changes made to the structure. The DTE should be

performed within a time frame that ensures the continued airworthiness of affected FCBS.

### 3.6. Review of Published Repair Data

Published repair data are generally applicable instructions for accomplishing repairs, such as those contained in SRMs and SBs. TCHs should review their existing repair data and identify each repair that affects FCBS. For each such repair, unless previously accomplished, the TCH must perform a DTE and develop any necessary DTI for the affected FCBS and repair data. For some repairs, the results of the DTE will conclude that no new DTI will be required for the affected FCBS or repair. For these cases, the TCH should provide a means that informs the operator a DTE was performed for the subject repair. This may be accomplished, for example, by providing a statement in a document, such as an SRM, stating that all repairs contained in this manual have had a DTE performed. This should preclude operators from questioning those repairs that do not have DTIs. TCHs should provide a list of its published repair data to operators and a statement that a DTE has been performed on this data. The following examples of published repair data developed by the TCH should be reviewed and included in this list:

- (a) SRMs,
- (b) SBs,
- (c) Documents containing AD mandated repairs, and
- (d) Other documents available to operators (for example, aircraft maintenance manuals and component maintenance manuals) containing approved repair data.

### 3.7. Developing DT Data for Existing Published Repair Data

#### 3.7.1. SRMs

The TCH should review the repair data contained in each SRM and identify repairs that affect FCBS. For these repairs, the TCH will need to determine if the SRM needs revising to provide adequate DTI. In determining the extent to which an SRM may need to be revised for compliance, consider the following:

- (a) Whether the existing SRM contains an adequate description of DTIs for the specific model.
- (b) Whether normal maintenance procedures (for example, the inspection threshold and/or existing normal maintenance inspections) are adequate to ensure the continued airworthiness (inspectability) equal to the unrepaired surrounding structure.
- (c) Whether SRM Chapter 51 standard repairs have a DT evaluation.
- (d) Whether all SRM specific repairs affecting FCBS have had a DTE performed.
- (e) Whether there is any guidance on proximity of repairs.
- (f) Whether superseded repairs are addressed and how a DTE is performed for future superseded repairs and how any DTI will be made available.

#### 3.7.2. SBs

The TCH should review the repair data contained in its SBs and identify those repairs that affect FCBS. For those repairs, the TCH should then determine if a new DTE will need to be performed. This review may be done in conjunction with the review of SBs for modifications that affect FCBS.

### 3.7.3. ADs

The TCH should review ADs that provide maintenance instructions to repair FCBS and determine if the instructions include any necessary DT Data. While the maintenance instructions supporting ADs are typically contained in SBs, other means of documentation may be used.

### 3.7.4. Other Forms of Data Transmittal

In addition to SRMs, SBs, and documentation for ADs, the TCH should review any other documents (for example, aircraft maintenance manuals and component maintenance manuals) that contain repair data. Individual repair data not contained in the above documents will be identified and DT Data obtained through the Repair Evaluation Guidelines process.

### 3.8. Developing DT Data for Future Published Repair Data

Following the completion of the review and revision of existing published data any subsequent repair data proposed for publication should also be subject to DTE and DTI provided.

### 3.9. Approval of DT Data Developed For Published Repair Data

For existing published repair data that requires new DT Data for repairs affecting FCBS, the TCH should submit the revised documentation to EASA for approval unless otherwise agreed. The DT Data for future published repair data may be approved according to existing processes.

### 3.10. Documentation of DT Data Developed for Published Repair Data

TCH should include the means used to document any new DTI developed for published repair data. For example, in lieu of revising individual SBs, the TCH may choose to establish a collector document that would contain new DTI developed and approved for specific repairs contained in various SBs.

### 3.11. Existing Repairs

TCHs should develop processes that will enable operators to identify and obtain DTI for existing repairs on their aircraft that affect FCBS. Collectively, these processes are referred to as the REGs and are addressed below.

### 3.12. Future Repairs

Repairs to FCBS conducted after the operator has incorporated the REGs into his maintenance programme must have a DTE performed. This includes blendouts, trim-outs, etc. that are beyond published TCH limits. For new repairs, the TCH may, in conjunction with an operator, use the three stage approval process provided in [Annex 1](#) of this Appendix. This process involves incremental approval of certain engineering data to allow an operator to return its aircraft to service before all the DT Data are developed and approved. The TCH should document this process for the operator's reference in their maintenance programme if it intends to apply it.

### 3.13. Repair Evaluation Guidelines

The REG provides instructions to the operator on how to survey aircraft, how to obtain DTI, and an implementation schedule that provides timelines for these actions. An effective REG may require that certain DT Data be developed by the TCH and made available to operators. Updated SRMs and SBs, together with the existing, expanded, or

new RAG documents, form the core of the information that will need to be made available to the operator to support this process. In developing the REG the TCH will need to determine what DT Data are currently available for repairs and what new DT Data will need to be developed to support operator compliance. The REG should include:

- (a) A process for conducting surveys of affected aircraft that will enable identification and documentation of all existing repairs that affect fatigue critical baseline structure;
- (b) A process for obtaining DTI for repairs affecting FCBS that are identified during an aircraft survey; and
- (c) An implementation schedule that provides timelines for:
  - (1) Conducting aircraft surveys,
  - (2) Obtaining DTI, and
  - (3) Incorporating DTI into the operator's maintenance programme.

#### 3.13.1. Implementation Schedule

The TCH should propose a schedule for Approval by EASA based on the guidance given in paragraph 12 of the main body of this AMC that takes into account the distribution of the fleet relative to  $\frac{3}{4}$  DSG, the extent of the work involved and the airworthiness risk. The Agency notes that many fleets are currently approaching or beyond DSG and these should be given priority in the implementation schedule.

#### 3.13.2. Developing a Process for Conducting Surveys of Affected Aircraft

The TCH should develop a process for use by operators to conduct aircraft surveys. These aircraft surveys are conducted by operators to identify and document repairs and repairs to modifications that may be installed on their aircraft. The survey is intended to help the operators determine which repairs may need a DTE in order to establish the need for DTI. Identification of repairs that need DTI should encompass only existing repairs that reinforce (for example, restore strength) the FCBS. This typically excludes maintenance actions such as blend-outs, plug rivets, trim-outs, etc. unless there are known specific risks associated with these actions in specific locations. The process the TCH develops to conduct surveys should include:

- (a) A survey schedule.
- (b) Areas and access provisions for the survey.
- (c) A procedure for repair data collection that includes:
  - (1) Repair Dimensions,
  - (2) Repair Material,
  - (3) Repair Fastener Type,
  - (4) Repair Location,
  - (5) Repair Proximity to other repairs,
  - (6) Repairs covered by Published Repair Data, and
  - (7) Repairs requiring DTI.
- (d) A means to determine whether or not a repair affects FCBS.



### 3.13.3. Developing a Process to Obtain DT Data for Repairs.

- (a) The TCH must develop a process that operators can use to obtain DTIs that address the adverse effects repairs may have on FCBS. In developing this process, TCHs will need to identify all applicable DTIs they have developed that are available to operators. This may include updated SRMs and SBs, existing RAGs, expanded or new RAGs, and other sources of DTIs developed by the TCH. For certain repairs, the process may instruct the operators to obtain direct support from the TCH. In this case, the TCH evaluates the operator's request and makes available DTI for a specific repair or group of repairs, as needed. These may include operator or third-party developed/approved repairs, and repairs that deviate from approved published repair data.
- (b) The process should state that existing repairs that already have DTIs developed and in place in the maintenance programme require no further action. For existing repairs identified during an individual aircraft survey that need DTIs established, the process may direct the operators to obtain the required DTIs from the following sources:
  - (1) TCH published service information such as DT-based SRMs, SBs, or other documents containing applicable DT Data for repairs.
  - (2) Existing approved RAG documents (developed for compliance with § 121.107).
  - (3) Expanded or newly developed RAG documents. In order to expedite the process for an operator to obtain DTI necessary to address the adverse affects repairs may have on FCBS, the TCH may determine that the existing RAG document should be expanded to address other FCBS of the aircraft pressure boundary. In addition, for aircraft that do not currently have a RAG, the TCH may determine that in order to fully support operators in obtaining DTI, a new RAG document may need to be developed. General guidance for developing this material can be found in [Annex 2](#) below, which is similar to AC 120-73, Damage Tolerance Assessment of Repairs to Pressurised Fuselages. The RAGs or any other streamlined process developed to enable operators to obtain DTI without having to go directly to the TCH.
  - (4) Procedures developed to enable operators to establish DTIs without having to contact the TCH for direct support. These procedures may be similar in concept to the RAG documents.
  - (5) Direct support from the TCH for certain repairs. The operator directly solicits DTIs from a TCH for certain individual repairs as those repairs are identified during the survey.

### 3.14 Repairs to Removable Structural Components

Fatigue critical structure may include structure on removable structural parts or assemblies that can be exchanged from one aircraft to another, such as door assemblies and flight control surfaces. In principle, the DT Data development and implementation process also applies to repairs to FCS on removable components. During their life history, however, these parts may not have had their flight times recorded on an individual component level because of removal and reinstallation on different aircraft multiple

times. These actions may make it impossible to determine the component's age or total flight hours or total flight cycles. In these situations, guidance for developing and implementing DT Data for existing and new repairs is provided in [Annex 3](#) of this Appendix.

### 3.15 Training

The complexity of the repair assessment and evaluation may require adequate training for proper implementation. In that case, it is necessary that each TCH considers providing training for all operators of the aircraft considered by this AMC

## 4. MODIFICATIONS AND REPAIRS TO MODIFICATIONS

### 4.1. TCH and STC Holder Tasks – Modifications and Repairs to Modifications

The following is an overview of the TCH and STC Holder tasks necessary for modifications that affect FCBS. This overview also includes TCH and STC Holder tasks necessary for repairs that may affect any FCS of the subject modifications. These tasks are applicable to those modifications that have been developed by the TCH or STC Holder.

- (a) Establish a list of modifications that may affect FCBS. From that list establish a list of modifications that may contain FCS.
- (b) In consultation with operators, determine which aircraft have the modification(s) installed.
- (c) STC Holders should obtain a list of FCBS from the TCH for the aircraft models identified above.
- (d) STC Holders should identify:
  - Modifications that affect FCBS, or
  - Modifications that contain FCS.
- (e) Determine if DT Data exist for the identified modifications.
- (f) Develop additional DT Data, if necessary.
- (g) Establish an implementation schedule for modifications.
- (h) Review existing DT Data for repairs made to modifications that affect FCBS.
- (i) Develop additional DT Data for repairs made to modifications that affect FCBS.
- (j) Establish an implementation schedule for repairs made to modifications.
- (k) Prepare documentation, submit it to EASA for approval, and make it available to operators.

### 4.2. Specific Modifications to be Considered

The TCH should consider modifications and any STCs it owns for modifications that fall into any of the categories listed in [Annex 5](#) of this Appendix. STC Holders should do the same for their STC modifications. For modifications that are not developed by a TCH or STC Holder the operator should consider whether the modification falls into any of the categories listed in [Annex 5](#) of this Appendix.

### 4.3. Modifications that need DT data

Using the guidance provided in AMC 25.571 and the detailed knowledge of the modification and its affect on the FCBS, the TCH and STC Holder, and in certain cases the

operator, should consider the following situations in determining what DT data need to be developed

#### 4.3.1. Modifications that affect FCBS

Any modification identified in Annex 5 that is installed on FCBS should be evaluated regardless of the size or complexity of the modification. In addition, any modification which indirectly affects FCBS (for example, modifications which change the fatigue loads environment, or affect the inspectability of the structure, etc.) must also have a DT evaluation performed to assess its impact.

#### 4.3.2. Modifications that contain new FCS

For any modification identified in [Annex 5](#) of this appendix that affects FCBS, the TCH or STC Holder should identify any FCS of the modification. Any modification that contains new FCS should be evaluated regardless of the size or complexity of the modification. Examples of this type of modification may be a modification that adds new structural splices, or increases the operational loads causing existing structure to become fatigue critical. If a modification does not affect FCBS, then it can be assumed that this modification does not contain FCS.

#### 4.4. Reviewing Existing DT Data for Modifications that Affect FCBS

Based on the CS 25.571 certification amendment level and other existing rules, the modification's approval documentation may already provide appropriate DT data.

The TCH or STC Holder should identify modifications that have existing approved DT data. Acceptable DT data contain a statement of DTE accomplishment and are approved. Confirmation that approved DT data exists should be provided to the operators.

Modifications that have been developed by a TCH may affect FCBS. These include ATCs and in some cases STCs. These changes to type design also require review for appropriate DT data.

#### 4.5. Developing Additional DT Data for Modifications that Affect FCBS

The DT data may be published as follows:

- (a) STC modifications – The additional DT data for existing modifications may be published in the form of an amended STC, a supplemental compliance document, or an individual approval.
- (b) TC Holder modifications – The additional DT data for existing modifications may be published in the form of an amended TC, TCH service information, etc.
- (c) Modifications not developed by a TCH or STC Holder – For modifications identified in [Annex 5](#) of this appendix that affect FCBS and were not developed by a TCH or STC Holder, the operator is responsible for obtaining DT data for those modifications. For those existing individual modifications that do not have DT data or other procedures implemented, establish the DT data according to an implementation plan approved by the Competent Authority.

NOTE: The TCH and STC Holder should submit data that describes and supports the means used to determine if a modification affects FCBS, and the means used for establishing FCS of a modification.

#### 4.6. DT Data Implementation Schedule then the TCH or STC Holder is no longer in business or a TC or STC is surrendered

For those modifications where the TCH or STC Holder is no longer in business or the TC or STC is surrendered, this paragraph provides guidance for an operator to produce a DT data implementation schedule for that modification. The operator's DT Data Implementation Schedule should contain the following information:

- (a) A description of the modification;
- (b) The affected aircraft and the affected FCS
- (c) The DSG of the affected aircraft;
- (d) A list of the modification FCS (if it exists);
- (e) The 25.571 certification level for determining the DT data;
- (f) A plan for obtaining the DT data for the modification; and
- (g) A DT Data Implementation Schedule for incorporating the DT data once they are received.

#### **5. DEVELOPMENT OF TCH AND STC HOLDER DOCUMENTATION AND EASA APPROVAL**

TCH, STC Holders, operators and the airworthiness authorities should work together to develop model-specific documentation with oversight provided by those authorities and assistance from the ARAC AAWG. It is anticipated that TCHs will utilise structural task groups (STG) to support their development of model-specific documents. EASA will approve the TCH or STC Holder submissions of the REGs and any other associated documentation required by the operator to provide appropriate DTI to all repairs and modifications to FCS whether submitted as separate documents or in a consolidated document.

#### **6. OPERATOR TASKS – REPAIRS, MODIFICATIONS AND REPAIRS TO MODIFICATIONS.**

- (a) Review the applicable Documents supplied by TCH and STC Holders.
- (b) Identify modifications that exist in the operators' fleet that affect FCBS.
- (c) Obtain or develop additional DT data for modifications not addressed by the TCH or STC Holder's documents.

NOTE: If the TCH or STC Holder no longer exists or is unwilling to comply with this request it becomes the responsibility of the operator to develop or obtain approved DT data. The data should be provided by a Design Organisation with an appropriate DOA.

- (d) Incorporate the necessary actions into the Maintenance programme for Approval by the Competent Authority.

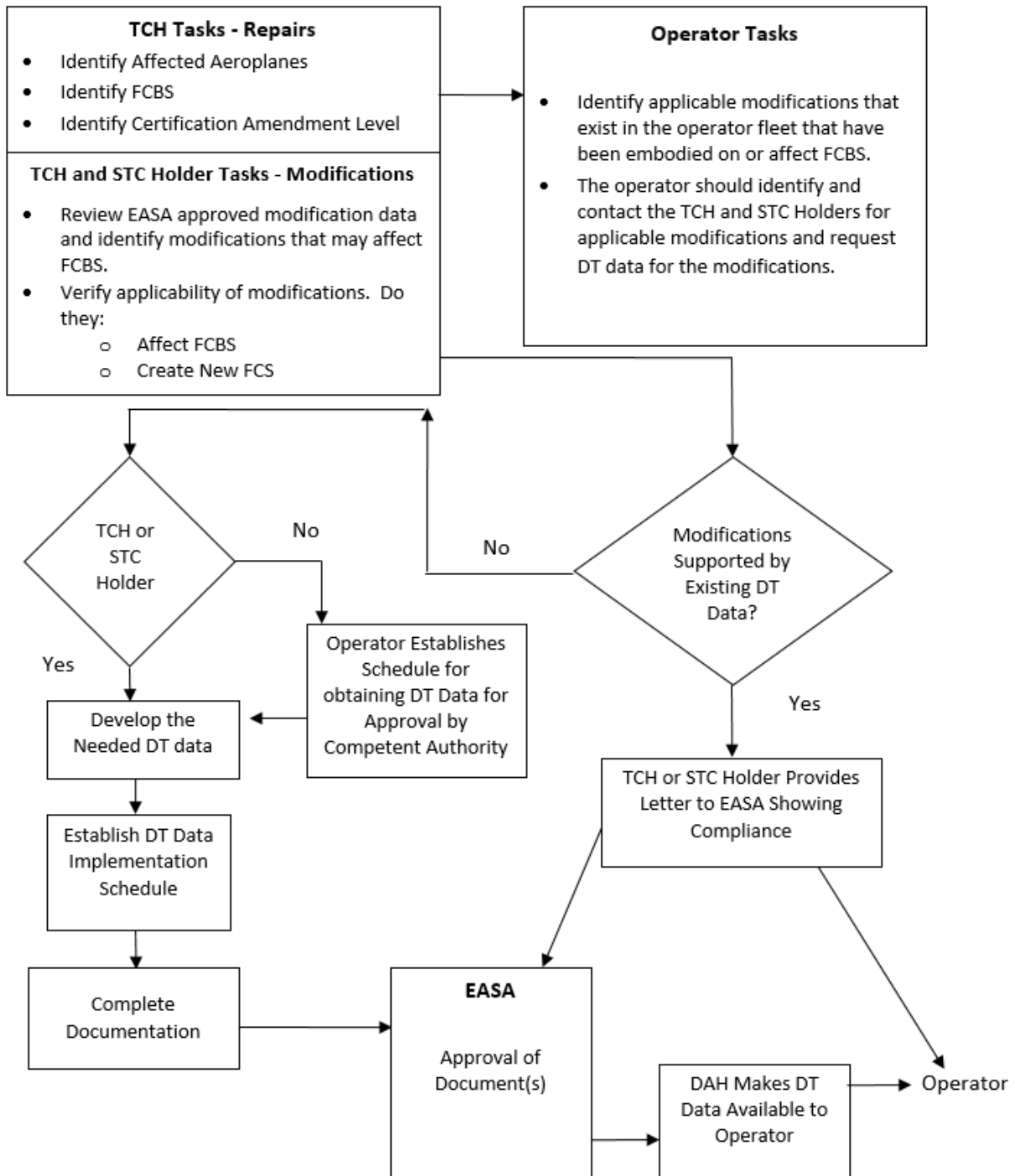

Figure A3-1 – Developing a Means of Compliance for Modifications

## 6.1. Contents of the Maintenance Programme

- (a) The operator should include the following in their Maintenance Programme:
  - (1) A process to ensure that all new repairs and modifications that affect FCBS will have DT data and DTI or other procedures implemented.
  - (2) A process to ensure that all existing repairs and modifications to FCBS are evaluated for damage tolerance and have DTI or other procedures implemented. This process includes:
    - (i) A review of operator processes to determine if DT data for repairs and modifications affecting FCBS have been developed and incorporated into the operator's maintenance programme for the operational life of the aircraft. If an operator is able to demonstrate that these processes ensure that DT data are developed for all repairs and modifications affecting FCBS, then no further action is required for existing repairs and modifications.
    - (ii) A process to identify or survey existing repairs (using the survey parameters from [Annex 3](#) of this Appendix) and modifications that affect FCBS and determine DTI for those repairs and modifications. This should include an implementation schedule that provides timing for incorporation of the DT data into the operator's maintenance programme, within the timeframe given in the applicable TCH or STC Holder's approved documentation.
- (b) Figure A3-2, below, outlines one possible means an operator can use to develop an implementation plan for aircraft in its fleet.

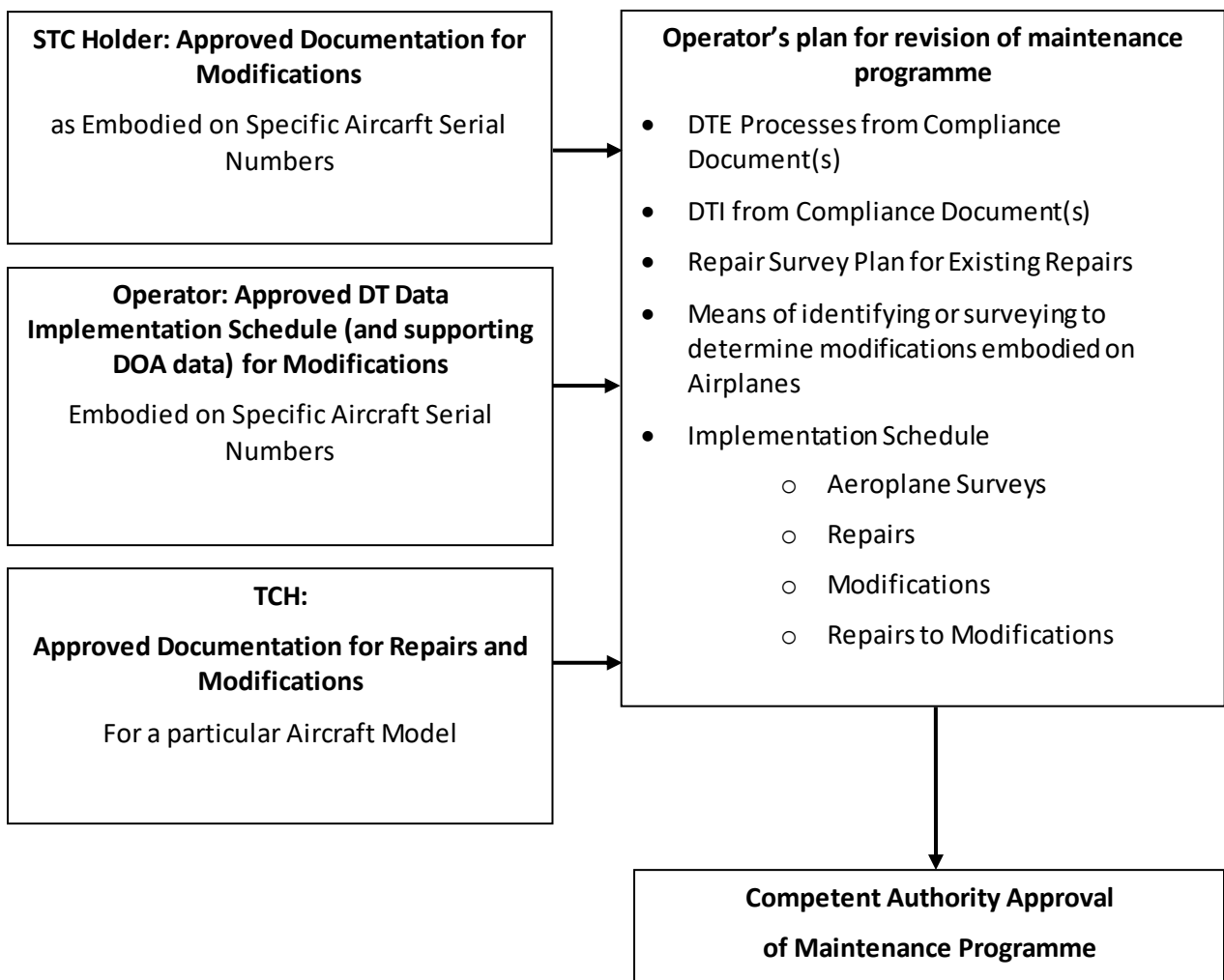

Figure A3-2 - Operator's Maintenance Programme Approval Process

#### 6.1.1. Implementation Plan for Repairs

Repair Survey Plan. The maintenance programme should include a repair survey schedule to identify repairs that may need DT data developed. The TCH's REG may be used as a basis for this plan. (See Paragraph 3 above and [Annex 2](#) for further information)

#### 6.1.2. Implementation Plan for Modifications:

- (a) The plan should include a process for producing a list of modifications that affect FCBS on an operator's aircraft. The list may be developed by obtaining data through a review of aircraft records and by a survey of the aircraft. If the means for identifying the subject modifications is by a records review, the operator will need to show its competent authority that the aircraft records are a reliable means for identifying modifications that affect the FCBS. Per the guidance in paragraph (3), below, the operator may identify modifications developed by TCH and STC Holders by performing a records review. A records review, however, may not be adequate to identify modifications not developed by a TCH or STC Holder. An aircraft survey may need to be conducted to identify such modifications. For each modification that affects FCBS, the process should document the means of compliance for incorporating DT data associated with that modification, whether through a TCH or STC Holder Compliance Document, an operator's DT data implementation schedule, or existing DT-based ICA.
- (b) The plan should:
  - (1) Include the process for when and how to obtain DT data for those modifications included in a DT data implementation schedule,
  - (2) Include a means of ensuring that the aircraft will not be operated past the time limit established for obtaining DT data,
  - (3) Include DT data associated with an modification that is provided in a Compliance Document, and
  - (4) Identify how DT data will be incorporated into the operator's maintenance programme.
- (c) To support identification of modifications that TCH and STC Holders need to address the operators should, concurrent with the TC and STC Holders' tasks, identify the TCH or STC Holder-developed modifications that exist in its fleet of aircraft. This may be done by reviewing the operator's aircraft configuration records, if record keeping is complete. During the review the TCH and STC Holder of each specific modification should be identified. The operator should then establish which modifications have been installed on or are likely to affect FCBS and prepare a list of modifications by aircraft. Modifications not developed by a TCH or STC Holder that affect FCBS should be identified at the time the operator conducts its aircraft survey for repairs.
  - (1) Compile a listing of all TCH and STC Holder developed modifications that are currently installed on its active fleet;



- (2) Delete from the listing those modifications that do not affect FCBS. Documents from the TCH may be used to identify the FCBS.
  - (3) The remaining modifications that affect FCBS on this list require a DTE and DT data, unless previously accomplished.
  - (4) The operator must review each modification to determine whether:
    - (i) The DT data already exist; or
    - (ii) The DT data need to be developed.
  - (5) Notify both the STC Holder and the Competent Authority and EASA when STCs owned by the STC Holder are identified on the operator's fleet and that DT data are required.

NOTE: The operator should begin developing this modifications list as soon as the TCHs make their FCBS listing available.
- (d) The operator should consider the list of modifications contained in [Annex 5](#) of this AMC in determining which modifications may affect FCBS on a model-specific basis.
  - (e) The operator should submit a letter that provides a list of modifications it has on its active fleet to the Competent Authority and a status on the TCH or STC Holders' support for developing required DT data.
  - (f) The operator should also contact the TCH or STC Holder for the applicable modification to determine if DT data are available for that modification. If the data do not exist, and the TCH or STC Holder intends to support the development of DT data, and this modification is likely to exist on other operators' fleets, the group of affected operators may wish to collectively meet with the TCH or STC Holder. If the TCH or STC Holder no longer exists, or is unwilling to support the modification, or if an modification affecting FCBS has not been approved under a TC or STC, it is the responsibility of the operator(s) to develop the data, either internally, or by using an third party with the appropriate design approval.
  - (g) Some individual modifications may not be easily identified through a review of aircraft maintenance records. In these situations, the means of compliance is a plan to survey the aircraft for modifications in the similar manner as repairs and repairs to modifications as given in paragraph 3 of this Appendix. The DT data for those modifications identified in the survey should be developed and implemented into an operator's maintenance programme. It is anticipated that most aircraft will need to be surveyed in order to ensure all modifications are identified. This survey can be conducted at the same time the survey for repairs is performed.

#### 6.1.3. DT Data Implementation Process

- (a) Use the regular maintenance or inspection programme for repairs where the inspection requirements utilise the chosen inspection

method and interval. Repairs or modifications added between the predetermined maintenance visits, including Category B and C repairs (see [Annex 2](#) of this Appendix) installed at remote locations, should have a threshold greater than the predetermined maintenance visit. Repairs may also be individually tracked to account for their unique inspection method and interval requirements. This ensures the airworthiness of the structure until the next predetermined maintenance visit, when the repair or modification will be evaluated as part of the repair maintenance programme.

- (b) Where inspection requirements are not fulfilled by the chosen inspection method and interval, Category B or C repairs will need additional attention. These repairs will either require upgrading to allow utilising the chosen inspection method and interval, or individual tracking to account for the repair's unique inspection method and interval requirements.

- 6.2 Maintenance programme changes When a maintenance or inspection programme interval is revised, the operator should evaluate the impact of the change on the repair assessment programme. If the revised maintenance or inspection programme intervals are greater than those in the BZI, the previous classification of Category A repairs may become invalid. The operator may need to obtain approval of an alternative inspection method, upgrade the repair to allow utilisation of the chosen inspection method and interval, or re-categorise some repairs and establish unique supplemental inspection methods and intervals for specific repairs. Operators using the "second technique" of conducting repetitive repair assessments at predetermined maintenance visits would evaluate whether the change to the predetermined maintenance visit continues to fulfil the repair inspection requirements in accordance with the guidance provided in [Annex 2](#) of this AMC.

## 7. THE COMPETENT AUTHORITY

The competent authority is responsible for approving the means for incorporating the Agency Approved DT data for repairs and modifications into the operator's maintenance programme.

[Amdt 20/2]

## Annex 1 to Appendix 3 to AMC 20-20: Approval Process for New Repairs

*ED Decision 2007/019/R*

In the past, FAA AC 25.1529-1, Instructions for Continued Airworthiness of Structural Repairs on Transport Aircraft, August 1, 1991, described a two-stage approach for approving repairs to principal structural elements. The two-stage approach consisted of:

- Evaluating type design strength requirements per CS 25.305 before return to service.
- Performing a damage tolerance evaluation and developing DT Data to demonstrate compliance with CS 25.571 within 12 months of return to service.

The FAA guidance material in AC 25.1529-1 is now embodied in this AMC, and is modified to describe a three-stage approach now commonly used in the aviation industry. The three-stage approach is in lieu of the two-stage approach discussed above.

The DT Data include inspection requirements, such as inspection threshold, inspection method, and inspection repetitive interval, or may specify a time limit when a repair or modification needs to be replaced or modified. The required data may be submitted all at once, prior to the aircraft return to service, or it may be submitted in stages. The following three-stage approval process is available, which involves incremental approval of engineering data to allow an aircraft to return to service before all the engineering data previously described are submitted. The three stages are described as follows:

- (a) The first stage is approval of the static strength data and the schedule for submittal of the DT Data. This approval is required prior to returning an aircraft to service.
- (b) The second stage is approval of the DT Data. This should be submitted no later than 12 months after the aircraft was returned to service. At this stage the DT Data need only contain the threshold when inspections are required to begin as long as a process is in place to develop the required inspection method and repetitive intervals before the threshold is reached. In this case, the submittal and approval of the remaining DT Data may be deferred to the third stage.
- (c) The third stage is approval of the inspection method and the repetitive intervals. This final element of the repair certification data in compliance with CS 25.571 must be submitted and approved prior to the inspection threshold being reached.

[Amdt 20/2]

## Annex 2 to Appendix 3 to AMC 20-20: Assessment of Existing Repairs

*ED Decision 2007/019/R*

A DTI assessment process consists of an aircraft repair survey, identification and disposition of repairs requiring immediate action and development of damage tolerance based inspections, as described below:

### 1. AIRCRAFT REPAIR SURVEY

A survey will be used to identify existing repairs and repair configurations on FCBS and provide a means to categorise those repairs. The survey would apply to all affected aircraft in an operator's fleet, as defined in the maintenance programme, using the process contained in the REG or similar document. The procedure to identify repairs that require DTE should be developed and documented using CS 25.571 and AMC 25.571 (dependent on aircraft certification level), together with additional guidance specific to repairs, such as:

- (a) Size of the repair,
- (b) Repair configuration,
  - (1) SRM standards
  - (2) Other
- (c) Proximity to other repairs, and
- (d) Potential affect on FCBS
  - (1) Inspectability (access and method)
  - (2) Load distribution.

See Paragraph 4 of this Annex for more details.

### 2. IDENTIFICATION AND DISPOSITION OF REPAIRS REQUIRING IMMEDIATE ACTION

Certain repairs may not meet minimum requirements because of cracking, corrosion, dents, or inadequate design. The operator should use the guidance provided in the Compliance Document to identify these repairs and, once identified, take appropriate corrective action. In some cases, modifications may need to be made before further flight. The operator should consider establishing a fleet campaign if similar repairs may have been installed on other aircraft.

### 3. DAMAGE TOLERANCE INSPECTION DEVELOPMENT

This includes the development of the appropriate maintenance plan for the repair under consideration. During this step determine the inspection method, threshold, and repetitive interval. Determine this information from existing guidance information as documented in the RAG (see Paragraph 4), or from the results of an individual damage tolerance evaluation performed using the guidance in AMC 25.571. Then determine the feasibility of an inspection programme to maintain continued airworthiness. If the inspection programme is practical, incorporate the DTI into the individual aircraft maintenance programme. If the inspection is either impractical or impossible, incorporate a replacement time for the repair into the individual aircraft maintenance programme. The three-stage approach discussed in [Annex 1](#) of this AMC may be used, if appropriate.

#### 4. Repair Assessment guidelines

##### 4.1. Criteria to assist in developing the repair assessment guidelines

The following criteria are those developed for the fuselage pressure boundary, similar to those found in FAA AC 120-73 and previous JAA and EASA documentation. DAHs may find it appropriate to develop similar practices for other types of aircraft and areas of the structure.

The purpose is to develop repair assessment guidelines requiring specific maintenance programmes, if necessary, to maintain the damage-tolerance integrity of the repaired airframe. The following criteria have been developed to assist in the development of that guidance material:

- (a) Specific repair size limits for which no assessment is necessary may be selected for each model of aircraft and structural location. This will enable the burden on the operator to be minimised while ensuring that the aircraft's baseline inspection programme remains valid.
- (b) Repairs that are not in accordance with SRM must be reviewed and may require further action.
- (c) Repairs must be reviewed where the repair has been installed in accordance with SRM data that have been superseded or rendered inactive by new damage-tolerant designs.
- (d) Repairs in close proximity to other repairs or modifications require review to determine their impact on the continued airworthiness of the aircraft.
- (e) Repairs that exhibit structural distress should be replaced before further flight.

##### 4.2. Repair assessment methodology.

The next step is to develop a repair assessment methodology that is effective in evaluating the continued airworthiness of existing repairs for the fuselage pressure boundary. Older aircraft models may have many structural repairs, so the efficiency of the assessment procedure is an important consideration. In the past, evaluation of repairs for damage-tolerance would require direct assistance from the DAH. Considering that each repair design is different, that each aircraft model is different, that each area of the aircraft is subjected to a different loading environment, and that the number of engineers qualified to perform a damage-tolerance assessment is small, the size of an assessment task conducted in that way would be unmanageable. Therefore, a new approach has been developed as an alternative.

Since repair assessment results will depend on the model specific structure and loading environment, the DAHs should create an assessment methodology for the types of repairs expected to be found on each affected aircraft model. Since the records on most of these repairs are not readily available, locating the repairs will necessitate surveying the structure of each aircraft. A survey form is created by DAH that may be used to record key repair design features needed to accomplish a repair assessment. Airline personnel not trained as damage-tolerance specialists can use this form to document the configuration of each observed repair.

Some DAH have developed simplified methods using the information from the survey form as input data, to determine the damage-tolerance characteristics of the surveyed repairs. Although the repair assessments should be performed by well trained personnel familiar with the model specific repair assessment guidelines, these methods enable

appropriate staff, not trained as a damage-tolerance specialist, to perform the repair assessment without the assistance of the TCH. This methodology should be generated by the aircraft TCH. Model specific repair assessment guidelines will be prepared by the TCHs.

From the information on the survey form, it is also possible to classify repairs into one of three categories:

- Category A: A permanent repair for which the baseline zonal inspection (BZI), (typical maintenance inspection intervals assumed to be performed by most operators), is adequate to ensure continued airworthiness.
- Category B: A permanent repair that requires supplemental inspections to ensure continued airworthiness.
- Category C: A temporary repair that will need to be reworked or replaced prior to an established time limit. Supplemental inspections may be necessary to ensure continued airworthiness prior to this limit.

When the LOV of the maintenance programme is extended the initial Categorisation of Repairs may need review by the TCH and operator to ensure these remain valid up until the new LOV.

#### 4.3. Repair assessment process

There are two principal techniques that can be used to accomplish the repair assessment. The first technique involves a three-stage procedure. This technique could be well suited for operators of small fleets. The second technique involves the incorporation of the repair assessment guidelines as part of an operator's routine maintenance programme. This approach could be well suited for operators of large fleets and would evaluate repairs at predetermined planned maintenance visits as part of the maintenance programme. DAHs and operators may develop other techniques, which would be acceptable as long as they fulfil the objectives of this proposed rule, and are approved by the Agency.

The first technique generally involves the execution of the following three stages. (See Figure.A3(2)-1):

##### **Stage 1 Data Collection**

This stage specifies what structure should be assessed for repairs and collects data for further analysis. If a repair is on a structure in an area of concern, the analysis continues, otherwise the repair does not require classification per this programme.

Repair assessment guidelines for each model will provide a list of structure for which repair assessments are required. Some DAHs have reduced this list by determining the inspection requirements for critical details. If the requirements are equal to normal maintenance checks (e.g., BZI checks), those details were excluded from this list.

Repair details are collected for further analysis in Stage 2. Repairs that do not meet the minimum design requirements or are significantly degraded are immediately identified, and corrective actions must be taken before further flight.

##### **Stage 2 Repair Categorisation**

The repair categorisation is accomplished by using the data gathered in Stage 1 to answer simple questions regarding structural characteristics.

If the maintenance programme is at least as rigorous as the BZI identified in the TCH's model specific repair assessment guidelines, well designed repairs in good condition meeting size and proximity requirements are Category A. Simple condition and design criteria questions are provided in Stage 2 to define the lower bounds of Category B and Category C repairs. The process continues for Category B and C repairs.

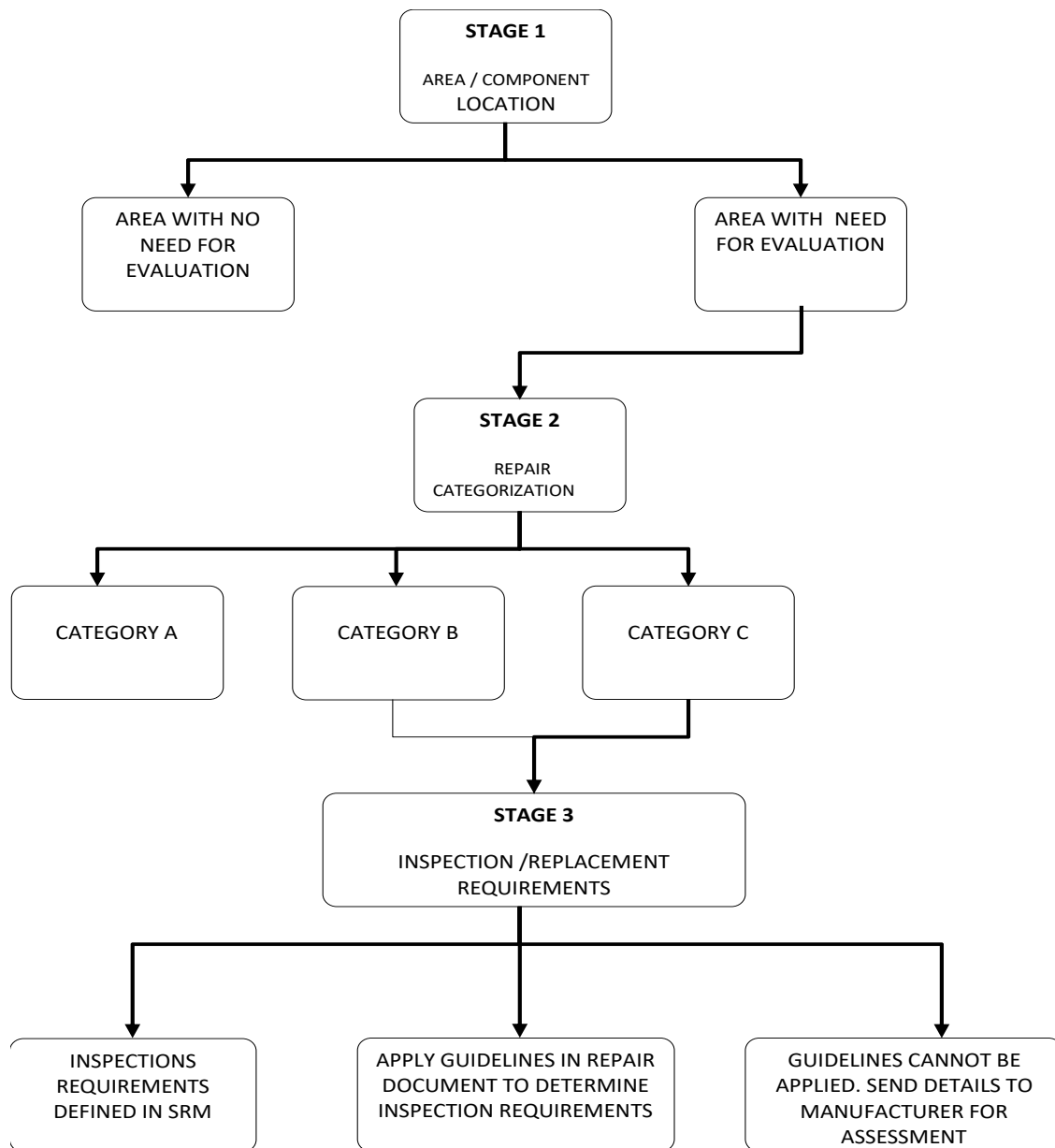

Figure A3(2)-1. Repair Assessment Stages

### **Stage 3 Determination of Structural Maintenance Requirements**

The specific supplemental inspection and/or replacement requirements for Category B and C repairs are determined in this stage. Inspection requirements for the repair are determined by calculation or by using predetermined values provided by the DAH, or other values obtained using an Agency approved method.

In evaluating the first supplemental inspection, Stage 3 will define the inspection threshold in flight cycles measured from the time of repair installation. If the time of installation of the repair is unknown and the aircraft has exceeded the assessment implementation times or has exceeded the time for first inspection, the first inspection should occur by the next "C-check" interval, or equivalent cycle limit after the repair data is gathered (Stage 1).

An operator may choose to accomplish all three stages at once, or just Stage 1. In the latter case, the operator would be required to adhere to the schedule specified in the Agency approved model specific repair assessment guidelines for completion of Stages 2 and 3. Incorporating the maintenance requirements for Category B and C repairs into an operator's individual aircraft maintenance or inspection programme completes the repair assessment process for the first technique.

The second technique would involve setting up a repair maintenance programme to evaluate all applicable structure as detailed in paragraph 2.6 at each predetermined maintenance visit to confirm that they are permanent. This technique would require the operator to choose an inspection method and interval in accordance with the Agency approved repair assessment guidelines. The repairs whose inspection requirements are fulfilled by the chosen inspection method and interval would be inspected in accordance with the approved maintenance programme. Any repair that is not permanent, or whose inspection requirements are not fulfilled by the chosen inspection method and interval, would either be:

- (a) Upgraded to allow utilisation of the chosen inspection method and interval, or
- (b) Individually tracked to account for the repair's unique inspection method and interval requirements.

This process is then repeated at the chosen inspection interval.

Repairs added between the predetermined maintenance visits, including interim repairs installed at remote locations, would be required either to have a threshold greater than the length of the predetermined maintenance visit or to be tracked individually to account for the repair's unique inspection method and interval requirements. This would ensure the airworthiness of the structure until the next predetermined maintenance visit, at which time the repair would be evaluated as part of the repair maintenance programme.

#### **5. Maintenance programme changes**

When a maintenance or inspection programme interval is revised, the operator should evaluate the impact of the change on the repair assessment programme. If the revised maintenance or inspection programme intervals are greater than those in the BZI, the previous classification of Category A repairs may become invalid. The operator may need to obtain approval of an alternative inspection method, upgrade the repair to allow utilisation of the chosen inspection method and interval, or re-categorise some repairs and establish unique supplemental inspection methods and intervals for specific repairs. Operators using the "second technique" of conducting repetitive repair assessments at predetermined maintenance visits would



evaluate whether the change to the predetermined maintenance visit continues to fulfil the repair inspection requirements.

## **6. SRM update**

The general section of each SRM will contain brief descriptions of damage-tolerance considerations, categories of repairs, description of baseline zonal inspections, and the repair assessment logic diagram. In updating each SRM, existing location specific repairs should be labelled with appropriate repair category identification (A, B, or C), and specific inspection requirements for B and C repairs should also be provided as applicable. SRM descriptions of generic repairs will also contain repair category considerations regarding size, zone, and proximity. Detailed information for determination of inspection requirements will have to be provided for each model. Repairs which were installed in accordance with a previous revision of the SRM, but which have now been superseded by a new damage-tolerant design, will require review. Such repairs may be reclassified to Category B or C, requiring additional inspections and/or rework.

## **7. Structure modified by a STC**

The current repair assessment guidelines provided by the TCH do not generally apply to structure modified by a STC. Nonetheless it is expected that all structure modified by STC should be evaluated by the operator in conjunction with the STC holder. The STC holder should develop, submit, and gain Agency approval of guidelines to evaluate repairs to such structure or conduct specific damage-tolerance assessments of known repairs and provide appropriate instructions to the operator.

It is expected that the STC holder will assist the operators by preparing the required documents. If the STC holder is out of business, or is otherwise unable to provide assistance, the operator would have to acquire the Agency approved guidelines independently. To keep the aircraft in service, it is always possible for operators, individually or as a group, to hire the necessary expertise to develop and gain approval of repair assessment guidelines and the associated DSG. Ultimately, the operator remains responsible for the continued safe operation of the aircraft.

[Amdt 20/2]

## Annex 3 to Appendix 3 to AMC 20-20: Repairs and Modifications to Removable Structural Components

*ED Decision 2007/019/R*

### 1. DETERMINING THE AGE OF A REMOVABLE STRUCTURAL COMPONENT

Determining an actual component age or assigning a conservative age provides flexibility and reduces operator burden when implementing DT data for repairs and modifications to structural components. In some cases, the actual component age may be determined from records. If the actual age cannot be determined this way, the component age may be conservatively assigned using one of the following fleet leader concepts, depending upon the origin of the component:

- (a) If component times are not available, but records indicate that no part changes have occurred, aircraft flight cycles or flight hours can be used.
- (b) If no records are available, and the parts could have been switched from one or more older aircraft under the same maintenance programme, it should be assumed that the time on any component is equal to the oldest aircraft in the programme. If this is unknown, the time should be assumed equal to the same model aircraft that is the oldest or has the most flight cycles or flight hours in the world fleet.
- (c) A manufacturing date marked on a component may also be used to help establish the component's age in flight cycles or flight hours. This can be done by using the above reasoning and comparing it to aircraft in the affected fleet with the same or older manufacturing date.

If none of these options can be used to determine or assign a component age or total number of flight cycles or flight hours, a conservative implementation schedule can be established by using the guidelines applied in paragraph 3. of this appendix, for the initial inspection, if required by the DT data.

### 2. TRACKING

An effective, formal, control or tracking system should be established for removable structural components that are identified as FCBS or that contain FCS. This will help ensure compliance with maintenance programme requirements specific to repairs and modifications installed on an affected removable structural component. Paragraph 4 of this appendix, provides options that could be used to alleviate some of the burdens associated with tracking all repairs to affected removable structural components.

### 3. DEVELOPING AND IMPLEMENTING DT DATA

#### (a) Repairs

Accomplish the initial repair assessment of the affected structural component at the same time as the aircraft level repair survey for the aircraft on which the component is installed. Develop the DT data per the process given in Step 3 of Appendix 6 and incorporate the DTI into the maintenance programme.

#### (b) Modifications

Accomplish the initial modification assessment of the affected structural component at the same time as the aircraft level modification assessment for the aircraft on which the component is installed. Develop the DT data and incorporate the DTI into the maintenance programme.

If the actual age of the repairs or modifications installation, or the total number of flight cycles or flight hours is known, use that information to establish when the initial inspection of the component should be performed. Repeat the inspection at the intervals provided by the TCH or STC Holder for the repair or modification installed on the component.

If the actual age of the repairs or modifications installation, or the total number of flight cycles or flight hours is unknown, but the component age or total number of flight cycles or flight hours is known, or can be assigned conservatively, use the component age, or total number of flight cycles or flight hours to establish when the initial inspection of the component should be performed. Repeat the inspection at the intervals provided by the TCH or STC Holder for the repairs and modifications against the component.

As an option, accomplish the initial inspection on the affected component at the next C-check (or equivalent interval) following the repair assessment. Repeat the inspection at the intervals provided by the TCH or STC Holder for the repairs and modifications against the component.

#### **4. EXISTING REPAIRS AND MODIFICATIONS – COMPONENTS RETRIEVED FROM STORAGE.**

- (a) If the time on the component (in flight cycles or flight hours) is known, or can be conservatively assigned, perform the following:
- (1) Survey the component,
  - (2) Disposition the repairs and modifications,
  - (3) Implement any DTI in accordance with the approved schedule,
  - (4) Accomplish the initial inspection using the actual age of the repairs or modifications, or total number of flight cycles or flight hours, if known. If the age of the repairs or modifications is not known, use the component age. Repeat the inspection at the intervals given for the repairs or modifications against the component.
- (b) If the time on the component (in flight cycles or flight hours) is unknown and cannot be conservatively assigned, perform the initial repair or modification assessment of the affected component prior to installation, perform the following actions:
- (1) Develop the DT data per the process given in paragraph 3 or 4 of [Appendix 3](#) of this AMC as applicable.
  - (2) Incorporate any DTI into the maintenance programme.
  - (3) Accomplish the first inspection on the affected component at the next C-check (or equivalent interval) following the repair or modification assessment.
  - (4) Repeat the inspection at the intervals given for the repair or modification against the component.

#### **5. IMPLEMENTATION OPTIONS TO HELP REDUCE TRACKING BURDEN**

The following implementation techniques could be used to alleviate some of the burdens associated with tracking repairs to affected removable structural components. These techniques, if used, would need to be included in the Maintenance Programme and may require additional EASA approval and TCH or STC Holder input for DTI.

(a) Upgrading Existing Repairs

As an option, existing repairs may be removed and replaced to zero time the DTI requirements of the repair and establish an initial tracking point for the repair. Normally, this would be done at or before the survey for maximum benefit. The initial and repetitive inspections for the upgraded repair would then be accomplished at the intervals given for the repair against the component.

A repair could also be upgraded to one whose inspection requirements and methods are already fulfilled by an operator's maintenance or inspection programme. That repair would then be repetitively inspected at each routine inspection interval applicable to the repair. Specific tracking would not be required because that area of the aircraft would already be normally inspected on each aircraft in the fleet as part of the existing approved maintenance programme. If the operator's programme intervals were changed, the affect on requirements for specific tracking would have to be re-evaluated.

(b) Special Initial and/or Routine Inspections

As an option, existing repairs may have special initial inspections accomplished during the component survey. This initial inspection establishes an initial tracking point for the repair. Following this initial inspection, the DTI requirements (e.g., repetitive inspections) of the repair would be implemented.

In addition, special routine inspections could be defined for typical repairs that could be applied at a normal interval. In this case, an operator could check the affected components on each aircraft for this type of a repair at the defined interval. If the repair were found, the special inspection would be applied to ensure its airworthiness until the next scheduled check. This alleviates the need to specifically track affected components for every repair, especially typical ones.

The development of inspection processes, methods, applicability and intervals will probably require the assistance of the TCH or STC Holder for the FCS in question.

[Amdt 20/2]

## Annex 4 to Appendix 3 to AMC 20-20: Service Bulletin Review Process

*ED Decision 2007/019/R*

### Guidelines for Following the Service Bulletin (SB) Flow Chart

NOTE: While it is believed that this guidance is fairly comprehensive, it may not address every possible situation. It is therefore incumbent on the user to use good judgment and rationale when making any determination.

Screening SBs to determine which ones require DT data is primarily a TCH responsibility.

The result of this screening is a list of SBs which require special directed inspections to ensure continued airworthiness. The SBs included on the list will be grouped into Type I and Type II SBs. Type I SBs have existing DT data and Type II SBs require developing DT data. The list is not comprehensive and will not include all of the SBs associated with an aircraft. Specifically, the list will not include those SBs where a BZI programme developed for the Repair Assessment Programme has been determined to be sufficient to meet the damage tolerance requirements for the FCBS that is affected by the SB. A note should be prominently placed somewhere in the Compliance Document stating that SBs not included in the list satisfy the DT data requirement.

**“ALL SBs HAVE BEEN EVALUATED FOR DAMAGE TOLERANCE INSPECTION REQUIREMENTS; SERVICE BULLETINS NOT INCLUDED IN THIS LIST HAVE BEEN DETERMINED TO SATISFY THE DAMAGE-TOLERANCE REQUIREMENT BY INSPECTIONS COVERED IN THE BZI. THE BZI IS DOCUMENTED IN SECTION X.XXX.XX.X OF THE MAINTENANCE PLANNING DOCUMENT.”**

**Query 1** Does the SB address a structural repair or a modification to FCS?

Historically, any SB, service letter or other document that lists ATA chapters 51 through 57 could provide repair or modification instructions that may require DT data. In addition, certain repairs or modifications accomplished under other ATA chapters may affect FCS. The first step in the screening process is to identify all such service instructions and develop a list of candidates for review (Q2).

**Query 2** Does the service instruction specify either a repair or modification that creates or affects FCS?

If it does, then the service instruction requires further review (Q3). If it does not, then the service instruction does not require further review.

**Query 3** Is the service instruction mandated?

Service bulletins and other service instructions that are mandated by an AD have requirements to ensure inspection findings (e.g., detected cracks or other structural damage/degradation) are addressed in an approved manner. If the TCH can demonstrate that it applies a process for developing inspection programmes for mandated SBs using DT data and/or service-based inspection results, and for continuously reviewing the SBs for their adequacy to detect cracks in a timely manner, the mandated SBs should then be considered as compliant with the intent of this process. Otherwise, the TCH will need to demonstrate the inspection programme in the mandated SB has been developed using DT data and/or appropriate service-based inspection results. The outcomes of Query 3 branch to two unrelated boxes (Q4 – if mandated by an AD) or (Q7 – if not mandated by an AD).

**Query 4** Does the SB or service instruction contain terminating action?

Query 3 established that the inspection programme for the baseline configuration is acceptable.

**Query 5** Does the terminating action have DT data?

If the terminating action has a documented continuing airworthiness inspection programme based on damage tolerance principals, then no further review is required. The SB should be documented in the list. If the terminating action does not have DT data, or the status of the inspection programme cannot be verified, then further review is necessary (Q6).

**Query 6** Does the SB address a safe-life part?

If it does no further action is required. Otherwise, damage-tolerance based inspections will need to be developed and provided to the operators. The SB should be included in the list along with where to find the required continued airworthiness inspection programme.

**Query 7** In Query 3 a structural SB that was mandated by AD was identified.

Query 7 asks if a one-time inspection is required to satisfy the intent of the requirement. If it does, it is deemed that this is being done to verify that a condition does not exist and, on finding that condition, correct that condition to baseline configuration. As such, normal SSID programmes would then be expected to cover any required continued airworthiness inspections. If a repair is necessary, it is further assumed that this was done by reference to the SRM or other suitable means. No further action is required if this is the case and, if a repair was necessary, other means exist to determine the required DT data. If no inspections or multiple inspections are required, additional evaluation is required (Q8).

**Query 8** Is this a major structural design change (e.g., modification)?

This is a TCH decision that is part of the original certification process and is not a major/minor repair decision. If it is not a major design change then proceed to Q10, if not, proceed to Q9.

**Query 9** Does the change require non-destructive inspections to verify the integrity of the structure or are normal routine maintenance inspections (as delineated in the BZ1) sufficient?

This is a subjective question and may require re-evaluating the change and determining where specific fatigue cracking might be expected. If normal maintenance inspections are adequate, no further action is required. Otherwise, proceed to Q10.

**Query 10** Does the SB contain DT data for both the baseline and modified aircraft configurations?

If so, the SB is satisfactory. Otherwise, damage tolerance-based inspections will need to be developed and provided to the operators. The SB should be documented in the list along with where to find the required continued airworthiness inspection programme.

### **Service Bulletin Screening Procedure**

1. The TCH will perform the screening and the Structures Task Group will validate the results.
2. A list of all SBs requiring action will be included in the TCH Compliance Document. Those not requiring action will not be in the list.
3. Service Bulletins included on the list will fall into one of two general types:

- 
- **Type I** – SBs which have existing DT data.
  - **Type II** – Service Bulletins that require developing DT data.
4. TCH actions:
- **Type I** – No action required.
  - **Type II** – Develop DT data and make it available to operators.
5. Operator actions (apply to both SB Types):
- Review SB incorporation on a tail number basis.
  - For incorporated SBs that rely on BZI (i.e., no special inspections required based on DTE performed), reconcile any maintenance planning document structural inspection escalations.
  - For incorporated SBs that require DTI, verify that DTI has been included in the operations specification and include it if it is missing.

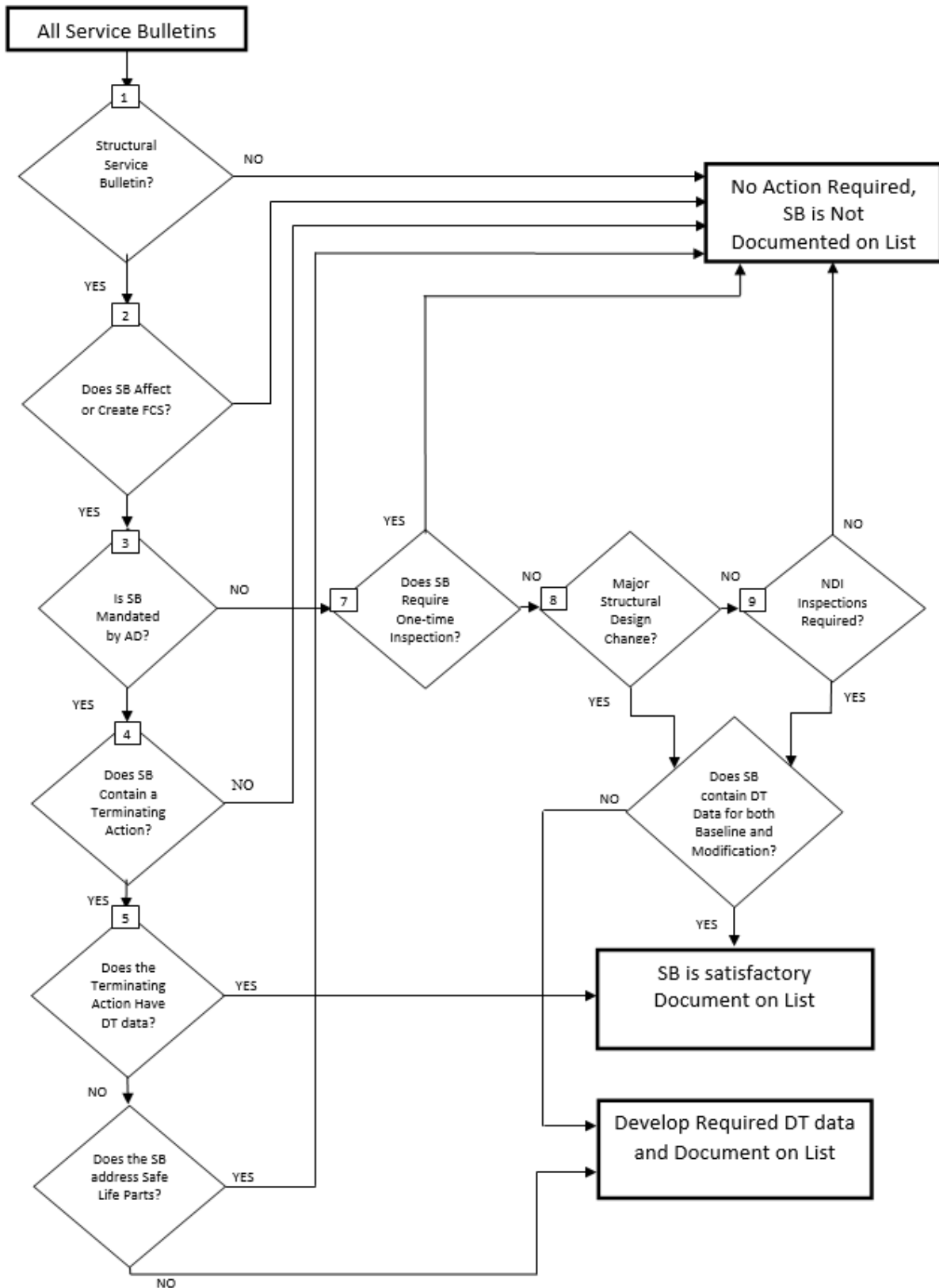

Figure A3(4)-1. Service Bulletin (SB) Flow Chart

[Amdt 20/2]



## Annex 5 to Appendix 3 to AMC 20-20: List of Significant STCs that may Adversely Affect Fatigue Critical Structure

ED Decision 2017/019/R

1. Passenger-to-freighter conversions (including addition of main deck cargo doors).
2. Gross weight increases (increased operating weights, increased zero fuel weights, increased landing weights, and increased maximum takeoff weights).
3. Installation of fuselage cutouts (passenger entry doors, emergency exit doors or crew escape hatches, fuselage access doors, and cabin window relocations).
4. Complete re-engine or pylon modifications.
5. Engine hush-kits.
6. Wing modifications such as installing winglets or changes in flight control settings (flap droop), and modification of wing trailing edge structure.
7. Modified skin splices.
8. Antenna Installations.
9. Any modification that affects several stringer or frame bays.
10. An modification that covers structure requiring periodic inspection by the operator's maintenance programme.
11. An modification that results in operational mission change that significantly changes the manufacturer's load or stress spectrum (e.g., passenger-to-freighter conversion).
12. An modification that changes areas of the fuselage that prevents external visual inspection (e.g., installation of a large external fuselage doubler that results in hiding details beneath it).
13. In general, attachment of interior monuments to FCS. Interior monuments include large items of mass such as galleys, closets, and lavatories.

[Amdt 20/2]

## Appendix 4 to AMC 20-20 Guidelines for the development of a corrosion control programme

ED Decision 2007/019/R

### 1. GENERAL

Before an operator may include a CPCP in its maintenance or inspection programme, the Agency should review and approve that CPCP. The Agency review is intended to ensure that the CPCP is comprehensive and systematic. The operator should show that the CPCP is comprehensive in that it addresses all corrosion likely to affect Primary Structure and is systematic in that it provides:

- (a) Step-by-step procedures that are applied on a regular basis to each identified task area or zone, and
- (b) These procedures are adjusted when they result in evidence that corrosion is not being controlled to an established acceptable level (Level 1 or better).

#### 1.1 Purpose

This appendix gives guidance to operators and DAHs who are developing and implementing a Corrosion Prevention and Control Programme (CPCP) for aeroplanes maintained in accordance with a maintenance programme developed in compliance with Part M M.A.302.

CPCPs have been developed by the DAH with the assistance of aircraft operators and competent authorities. They relied heavily on service experience to establish CPCP implementation thresholds and repeat intervals. Since that time a logical evaluation process has been developed to ensure environmental damage is considered in the evaluation of aircraft structure. This process is identified in ATA MSG-3 Scheduled Maintenance Development document, which introduced the CPCP concept in revision 2, circa 1993. The Agency will accept a CPCP based on this document and the information in this advisory circular. The Agency will also accept any other process that follows the guidelines in this AMC.

### 2. DEFINITIONS

- **Allowable Limit.** The allowable limit is the amount of material (usually expressed in material thickness) that may be removed or blended out without affecting the ultimate design strength capability of the structural member. Allowable limits may be established by the TCH/DAH. The Agency may, also, establish allowable limits. The DAH normally publishes allowable limits in the SRM or in SBs.
- **Baseline Programme.** A baseline programme is a CPCP developed for a specific model aeroplane. The TCH typically, develops the baseline programme. (See TCH Developed Baseline Programme, below) However, it may be developed by a group of operators who intend to use it in developing their individual CPCP (See Operator Developed Programme, below). It contains the corrosion inspection tasks, an implementation threshold, and a repeat interval for task accomplishment in each area or zone. Development of a systematic and comprehensive CPCP for inclusion in the operator's maintenance programme.
- **Basic Task(s).** The basic task is a specific and fundamental set of work elements that should be performed repetitively in all task areas or zones to successfully control corrosion. The contents of the basic task may vary depending upon the specific

requirements in an aeroplane area or zone. The basic task is developed to protect the Primary Structure of the aeroplane.

- **Corrosion Prevention and Control Programme (CPCP).** A Corrosion Prevention and Control Programme (CPCP) is a comprehensive and systematic approach to controlling corrosion such that the load carrying capability of an aircraft structure is not degraded below a level necessary to maintain airworthiness. It contains the basic corrosion inspection task, a definition of corrosion levels, an implementation threshold and a repeat interval for task accomplishment in each area or zone, and specific procedures if corrosion damage exceeds Level 1 in any area or zone. A CPCP consists of a basic corrosion inspection task, task areas, defined corrosion levels, and compliance times (implementation thresholds and repeat intervals). The CPCP also includes procedures to notify the competent authority of the findings and data associated with Level 2 and Level 3 corrosion and the actions taken to reduce future findings to Level 1.
- **Implementation Threshold (IT).** The implementation threshold is the aircraft age associated with the first time the basic corrosion inspection task should be accomplished in an area or zone.
- **Level 1 Corrosion.** Level 1 corrosion is:
  - (1) **Corrosion, occurring between successive corrosion inspection tasks that is local and can be reworked or blended out within the allowable limit; or**
  - (2) **Corrosion damage that is local and exceeds the allowable limit, but can be attributed to an event not typical of operator's usage of other aircraft in the same fleet (e.g. mercury spill); or**
  - (3) **Operator experience has demonstrated only light corrosion between each successive corrosion inspection task inspection; and, the latest corrosion inspection task results in rework or blend out that exceeds the allowable limit.**
- **Level 2 Corrosion.** Level 2 corrosion is that corrosion occurring between any two successive corrosion inspections task that requires a single rework or blend out which exceeds the allowable limit.

OR,

Corrosion occurring between successive inspections that is widespread and requires a single blend-out approaching allowable rework limits. i.e. it is not light corrosion as provided for in Level 1, definition (3).

A finding of Level 2 corrosion requires repair, reinforcement, or complete or partial replacement of the applicable structure.

**Note:** A statement of fact in previously mandated CPCPs states: corrosion findings that were discovered during the corrosion inspection task accomplished at the implementation threshold, and which require repair, reinforcement, or complete or partial replacement of the applicable structure, should not be used as an indicator of the effectiveness of the operators CPCP. The argument is that an operator's corrosion programme effectiveness can only be determined after a repeat inspection has been performed in a given inspection task area. This argument is valid for aircraft with mandated corrosion prevention and control programmes introduced after the aircraft has been in service for a number of years without a CPCP. This argument, however, may not be valid for aircraft that have been maintained using a design approval holders CPCP. Consequently, corrosion

findings exceeding level 1 found on the corrosion inspection task implementation threshold may have been set too high by the design approval holder and action should be taken to readjust the implementation threshold.

- **Level 3 Corrosion.** Level 3 corrosion is that corrosion occurring during the first or subsequent accomplishments of a corrosion inspection task that the operator determines to be an urgent airworthiness concern.

**Note:** If level 3 corrosion is determined at the implementation threshold or any repeat inspection then it should be reported. Any corrosion that is more than the maximum acceptable to the design approval holder or the Agency must be reported in accordance with current regulations. This determination should be conducted jointly with the DAH.

- **Light Corrosion.** Light corrosion is corrosion damage so slight that removal and blend-out over multiple repeat intervals (RI) may be accomplished before material loss exceeds the allowable limit.
- **Local Corrosion.** Generally, local corrosion is corrosion of a skin or web (wing, fuselage, empennage or strut) that does not exceed one frame, stringer, or stiffener bay. Local corrosion is typically limited to a single frame, chord, stringer or stiffener, or corrosion of more than one frame, chord, stringer or stiffener where no corrosion exists on two adjacent members on each side of the corroded member.
- **Operator Developed Programme.** In order to operate an aeroplane in compliance with the maintenance programme of Part-Man operator should include in its maintenance or inspection programme an approved CPCP. An operator may adopt the baseline programme provided by the DAH or it may choose to develop its own CPCP, or may be required to if none is available from the DAH. In developing its own CPCP an operator may join with other operators and develop a baseline programme similar to a TCH developed baseline programme for use by all operators in the group. The advantages of an operator developed baseline programme are that it provides a common basis for all operators in the group to develop their CPCP and it provides a broader experience base for development of the corrosion inspection tasks and identification of the task areas.
- **Repeat Interval (RI).** The repeat interval is the calendar time between the accomplishment of successive corrosion inspection tasks for a task area or zone.
- **Task Area.** The task area is a region of aircraft structure to which one or more corrosion inspection tasks are assigned. The task area may also be referred to as a zone.
- **TCH Developed Baseline Programme.** As part of the ICA, the TCH should provide an inspection programme that includes the frequency and extent of inspections necessary to provide the continued airworthiness of the aircraft. Furthermore, the ICA should include the information needed to apply protective treatments to the structure after inspection. In order for the inspections to be effectively accomplished, the TCH should include, in the ICA, corrosion removal and cleaning procedures and reference allowable limits. The TCH should include all of these corrosion-related activities in a manual, referred to as the Baseline Programme. The Baseline Programme manual is intended to facilitate operator.
- **Urgent Airworthiness Concern.** An urgent airworthiness concern is damage that could jeopardise continued safe operation of any aircraft. An urgent airworthiness concern typically requires correction before the next flight and expeditious action to inspect the other aircraft in the operator's fleet.

- **Widespread Corrosion.** Widespread corrosion is corrosion of two or more adjacent skin or web bays (a web bay is defined by frame, stringer or stiffener spacing). Or, widespread corrosion is corrosion of two or more adjacent frames, chords, stringers, or stiffeners. Or, widespread corrosion is corrosion of a frame, chord, stringer, or stiffener and an adjacent skin or web bay.
- **Zone.** (See task area)

### 3. DEVELOPMENT OF A BASELINE PROGRAMME

#### 3.1. Baseline Programme.

The objective of a baseline programme is to establish requirements for control of corrosion of aircraft structure to Level 1 or better for the operational life of the aircraft. The baseline programme should include the basic task, implementation thresholds, and repeat intervals. The baseline programme should also include procedures to notify the competent authority of the findings and data associated with Level 2 and Level 3 corrosion and the actions taken to reduce future findings to Level 1.

##### 3.1.1. Baseline Programme considerations.

To establish an effective baseline programme consideration of the following is necessary:

- (a) The flight and maintenance history of the aircraft model and perhaps similar models;
- (b) The corrosion properties of the materials used in the aircraft structure;
- (c) The protective treatments used;
- (d) The general practices applied during construction and maintenance; and
- (e) Local and widespread corrosion (See Figure A4-1).

When determining the detail of the corrosion inspection tasks, the implementation threshold, and the repeat interval, a realistic operational environment should be considered. Technical representatives of both the TCH and the operators should participate in evaluating the service history and operational environment for the aircraft model. For new aircraft models and for aircraft models that have been in operation for only a short time, technical representatives of operators of similar aircraft models should be invited to participate.

**EXAMPLES OF LOCAL AND WIDESPREAD CORROSION IN FUSELAGE FRAMES**

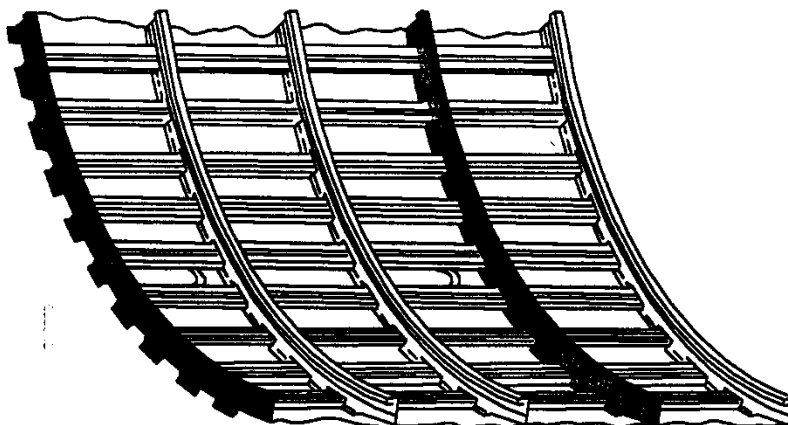

**LOCAL CORROSION**

(Corrosion occurring in non-adjacent frames)

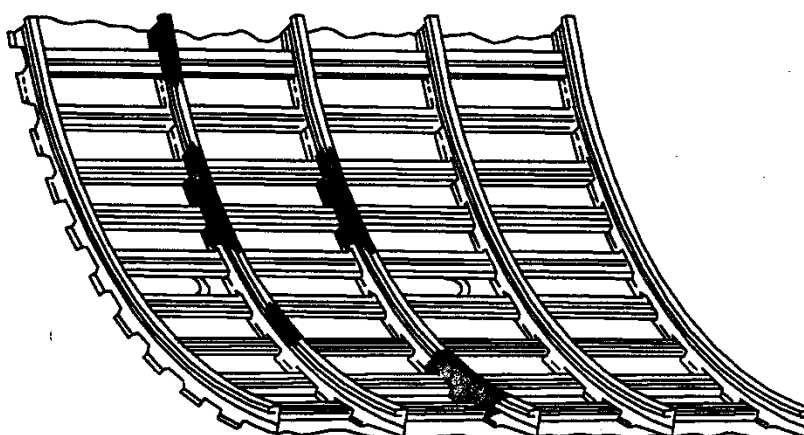

**WIDESPREAD CORROSION**

(Corrosion occurring in adjacent frames)

Figure A4-1

**3.1.2. TCH developed Baseline Programme**

During the design development process, the TCH should provide a baseline programme as a part of the instructions for continued airworthiness. The TCH initially evaluates service history of corrosion available for aircraft of similar design used in the same operational environment. Where no similar design with service experience exists those structural features concerned should be assessed using the environmental damage approach of ATA MSG-3. The TCH develops a preliminary baseline programme based on this evaluation. The TCH then convenes a working group consisting of operator technical representatives and representatives of the participating competent authorities. The working group reviews the preliminary baseline programme to assure that the tasks, implementation thresholds, and

repeat intervals are practical and assure the continued airworthiness of the aircraft. Once the working group review is complete, the TCH incorporates the baseline programme into the instructions for continued airworthiness. (See Figure A4-2)

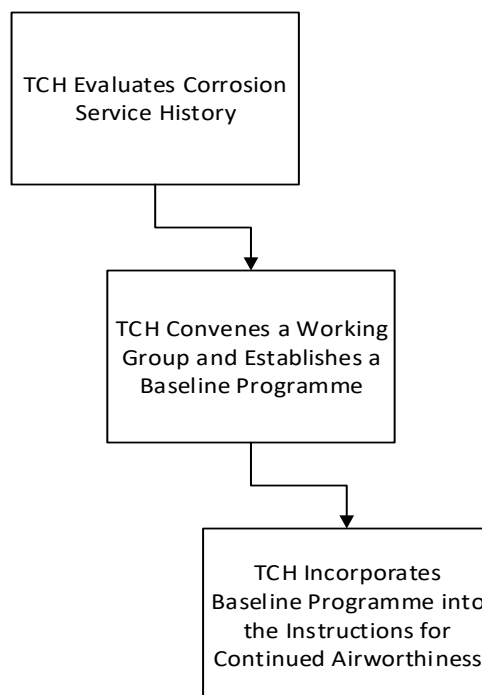

**Figure A4-2: Type-Certificate Holder Developed Baseline Programme**

### **3.1.3 Operator Developed Programme.**

There may be instances where the TCH does not provide a baseline programme. In such instances, an operator may develop its CPCP without using a baseline programme, as long as the operator developed CPCP is consistent with the requirements.. It would be beneficial for an operator developing its own CPCP to consult other operators of the same or similar aircraft models in order to broaden the service experience available for use in preparing its programme. When a TCH prepared baseline programme is unavailable, a group of operators may prepare a baseline programme from which each operator in the group will develop its CPCP.

(a) **Operator Developed Baseline Programme**

An operator-developed baseline programme should pay particular attention to corrosion prone areas of the aircraft such as:

- (i) Exhaust trail areas,
- (ii) Battery compartments and battery vent openings,
- (iii) Areas surrounding lavatories, buffets, and galleys,
- (iv) Bilges,
- (v) Fuselage internal lower structure,

- (vi) Wheel wells and landing gear,
- (vii) External skin areas,
- (viii) Water entrapment areas,
- (ix) Engine frontal areas and cooling air vents,
- (x) Electronic or avionics compartments, and
- (xi) Flight control cavities open during takeoff and landing.

**Note:** Corrosion Prevention and Control Programmes for large transports were developed based on a triad amongst the Airworthiness Authorities, design approval holders, and the operators for the particular model aeroplane. If operator(s) were to develop a CPCP they may want to follow the example of the large transports.

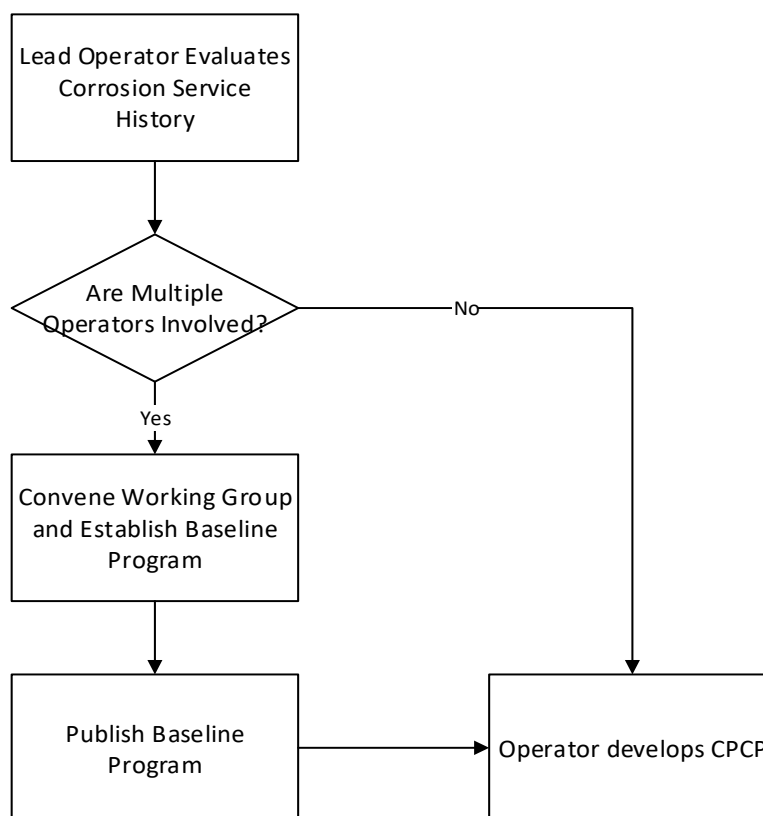

(b) Individual Operator Developed CPCP.

An operator may develop its CPCP without reference to a baseline programme; so long as the CPCP is consistent with the requirements of the applicable operating rules. Any operator who develops its own CPCP without a baseline programme, should review all available corrosion related service data on the individual aircraft model and on like design details in similar



aircraft models when the operator's data and the Service Difficulty Report data shows no entries.

#### **3.1.4. Continuous Analysis and Surveillance.**

The operator's continuous analysis and surveillance system should contain procedures to review corrosion inspection task findings and establish corrosion levels. These procedures should provide criteria for determining if findings that exceed allowable limits are an isolated incident not typical of the operator's fleet. The operator's programme should also provide for notifying the competent authority whenever a determination of Level 2 or Level 3 corrosion is made. Due to the potential urgent airworthiness concern associated with a Level 3 finding, the operator's procedures should provide for notification as soon as possible but not later than 3 calendar days after the Level 3 determination has been made.

### **3.2. Baseline Programme Manual.**

The baseline programme manual should include instructions to implement the baseline CPCP. It may be in a printed form or other form acceptable to the competent authority. It should, also, be in a form that is easy to revise. The date of the last revision should be entered on each page. The baseline programme manual should clearly be identified as a baseline CPCP programme. The aircraft make, model and the person who prepared the manual should also be identified.

#### **3.2.1. Purpose and Background.**

This section of the manual should state the purpose of the baseline programme which is, to establish minimum requirements for preventing and controlling corrosion that may jeopardise continuing airworthiness of the aircraft model fleet. The section should further state that an operator should include an effective CPCP in its maintenance or inspection programme.

#### **3.2.2. Introduction.**

The introduction should include a general statement that corrosion becomes more widespread as aircraft age and that it is more likely to occur in conjunction with other damage such as fatigue cracking. The introduction should also indicate that it is not the intent of a CPCP to establish rigid requirements to eliminate all corrosion in the fleet, but to control corrosion at or below levels that do not jeopardise continued airworthiness. However, due to the unpredictability of corrosion it must be removed and the structure repaired and corrosion prevention treatment reapplied.

#### **3.2.3. Programme Application.**

For a programme to be fully effective, it is essential that a corrosion inspection task be applied to all areas where corrosion may affect Primary Structure. This section should recommend that priority for implementing the CPCP be given to older aeroplanes and to areas requiring significant changes to previous maintenance procedures in order to meet corrosion prevention and control requirements. This section should allow an operator to continue its current corrosion control procedures in a given task area or zone where there is documentation to show that corrosion is being consistently controlled to level 1.

#### 3.2.4. Baseline Programme.

This section should fully describe the baseline programme. It should include the basic task, corrosion inspection task areas, implementation thresholds, and repeat intervals.

#### 3.2.5. Reporting System.

Procedures to report findings of Level 2 and 3 corrosion to the competent authority should be clearly established in this section. All Level 2 and Level 3 findings should be reported in accordance with the applicable AD, operator's service difficulty reporting procedures or reporting required by other competent authorities. Additional procedures for alerting the competent authority of level 3 findings should be established that expedite such reporting. This report to the competent authority shall be made after the determination of the corrosion level.

#### 3.2.6. Periodic Review.

This section should establish a period for the TCH (or lead operator) and participating operators to meet with the competent authority and review the reported Level 2 and 3 findings. The purpose of this review is to assess the baseline programme and make adjustments if necessary.

#### 3.2.7. Corrosion Related Airworthiness Directives.

This section should include a list of all ADs that contain requirements related to known corrosion related problems. This section should state that these ADs are in addition to and take precedence over the operator's CPCP.

#### 3.2.8. Development of the Baseline Programme.

This section should identify the actions taken in preparing the baseline programme. It should include a description of the participants, the documents (e.g., SBs, service letters, ADs, service difficulty reports, accident and incident reports) reviewed, and the methodology for selecting and categorising the corrosion prone areas to be included in the baseline programme. Selection criteria for corrosion prone areas should be based on areas having similar corrosion exposure characteristics and inspection access requirements. Some corrosion prone areas that should be considered are the main wing box, the fuselage crown, the bilge, areas under lavatories and galleys, etc. This section should state that the implementation threshold was selected to represent the typical aircraft age beyond which an effective corrosion inspection task should be implemented for a given task area.

#### 3.2.9. Procedures for Recording Corrosion Inspection Findings.

The Agency has not imposed a requirement for additional record keeping for an operator's CPCP. However, the operator should maintain adequate records to substantiate any proposed programme adjustments. For example, an operator should maintain records to enable the operator to determine the amount of damage that has occurred during the repeat interval for each corrosion inspection task. Such data should be maintained for multiple repeat intervals in order to determine whether the damage remains constant or is increasing or decreasing. Such records are necessary

when an operator is seeking approval for Interval extension or task reduction.

#### 3.2.10. Glossary.

This section should define all terms specifically used in the baseline manual.

#### 3.2.11. Application of the Basic Task.

This section should describe in detail the basic task. It should provide procedures describing how to accomplish the following actions:

- (a) Removal of all systems equipment and interior furnishings to allow access to the area.
- (b) Cleaning of the area as required.
- (c) Visual inspection of all task areas and zones listed in the baseline programme.
- (d) Removal of all corrosion, damage evaluation, and repair of structure as necessary.
- (e) Unblocking holes and gaps that may hinder drainage.
- (f) Application of corrosion protective compounds.
- (g) Reinstallation of dry insulation blankets, if applicable.

#### 3.2.12. Determination of Corrosion Levels Based on Findings.

This section should describe how the corrosion level definitions are used in evaluating the corrosion findings and assigning a corrosion level. This section should also instruct the operator to consult the DAH or the competent authority for advice in determining corrosion levels.

#### 3.2.13. Typical Actions Following Determination of Corrosion Levels.

This section should establish criteria for evaluating whether or not the Level 2 or 3 corrosion is occurring on other aircraft in the operator's fleet. Criteria to be considered include: cause of the corrosion problem, past maintenance history, operating environment, production build standard, years in service, and inspectability of the corroded area. These and any other identified criteria should be used in identifying those aircraft that should be included in a fleet campaign. The results of the fleet campaign should be used to determine necessary adjustments in the operator's CPCP. The following instructions should also be included in this section:

- (a) If corrosion exceeding the allowable limit is found during accomplishment of the corrosion inspection task implementation threshold for a task area, it may be necessary to adjust the CPCP. (see NOTE under level 2 corrosion definition)
- (b) A single isolated occurrence of corrosion between successive inspections that exceeds Level 1 does not necessarily warrant a change in the operators CPCP. If the operator experiences multiple occurrences of Level 2 or Level 3 corrosion for a specific task area, then the operator should implement a change to the CPCP.

- (c) The operator should not defer maintenance actions for Level 2 and Level 3 corrosion. These maintenance actions should be accomplished in accordance with the operator's maintenance manual.
- (d) The operator may implement changes such as the following to improve the programme effectiveness:
  - (i) Reduction of the repeat interval,
  - (ii) Multiple applications of corrosion treatments, or
  - (iii) Additional drainage provisions.
  - (iv) Incorporation of design approval holders service information, such as service bulletins and service letters.

#### 3.2.14. Programme Implementation.

This section should state that each task is to be implemented on each aircraft when the aircraft reaches the age represented by the implementation threshold for the task. It should, also, describe procedures to be used for establishing a schedule for implementation where the aircraft age exceeds the implementation threshold for individual tasks. It should state that once a task is implemented in an area, subsequent tasks are to be accomplished at the repeat interval in that task area.

## 4. DEVELOPMENT OF OPERATORS PROGRAMME

### 4.1. Baseline Programme available

If a baseline programme is available, the operator should use that baseline programme as a basis for developing its CPCP. In addition to adopting the basic task, task areas, implementation thresholds and repeat intervals of the baseline programme, the operator should make provisions for:

- (a) **Aeroplanes that have exceeded the implementation threshold for certain tasks,**
- (b) **Aeroplanes being removed from storage,**
- (c) **Unanticipated scheduling adjustments,**
- (d) **Corrosion findings made during non CPCP inspections,**
- (e) **Adding newly acquired aircraft, and**
- (f) **Modifications, configuration changes, and operating environment,**

#### 4.1.1. Provisions for aircraft that have exceeded the implementation threshold

The operator's CPCP must establish a schedule for accomplishing all corrosion inspection tasks in task areas where the aircraft age has exceeded the implementation threshold (see main text of AMC paragraph 12). Repeat paragraph 12 text on implementation.

#### 4.1.2. Aeroplanes being removed from storage

Corrosion inspection task intervals are established based on elapsed calendar time. Elapsed calendar time includes time out of service. The operators CPCP should provide procedures for establishing a schedule for accomplishment of corrosion inspection tasks that have accrued during the storage period.

The schedule should result in accomplishment of all accrued corrosion inspection tasks before the aircraft is placed in service.

#### **4.1.3. Unanticipated scheduling adjustments**

The operators CPCP should include provisions for adjustment of the repeat interval for unanticipated schedule changes. Such provisions should not exceed 10% of the repeat interval. The CPCP should include provisions for notifying the competent authority when an unanticipated scheduling adjustment is made.

#### **4.1.4. Corrosion findings made during non-CPCP inspections**

Corrosion findings that exceed allowable limits may be found during any scheduled or unscheduled maintenance or inspection activities. These findings may be indicative of an ineffective CPCP. The operator should make provision in its CPCP to evaluate these findings and adjust its CPCP accordingly.

#### **4.1.5. Adding newly acquired aircraft**

Before adding any aircraft to the fleet, the operator should establish a schedule for accomplishing all corrosion inspection tasks in all task areas that are due. This schedule should be established as follows:

- (a) For aircraft that have previously operated under an approved maintenance programme, the initial corrosion inspection task for the new operator must be accomplished in accordance with the previous operator's schedule or in accordance with the new operator's schedule, whichever would result in the earliest accomplishment of the corrosion inspection task.
- (b) For aircraft that have not previously been operated under an approved maintenance programme, each initial corrosion task inspection must be accomplished either before the aircraft is added to the operator's fleet, or in accordance with schedule approved by the competent authority. After each corrosion inspection task has been performed once, the subsequent corrosion task inspections should be accomplished in accordance with the new operator's schedule.

#### **4.1.6. Modifications, configuration changes and operating environment**

The operator must ensure that their CPCP takes account of any modifications, configurations changes and the operating environment applicable to them, that were not addressed in the Baseline Programme Manual.

### **4.2. Baseline Programme not available.**

If there is no baseline programme available for the operator to use in developing its CPCP, the operator should develop its CPCP using the provisions listed in Paragraph 3 of this appendix for a baseline programme as well as the provisions listed in sub-paragraphs 4.1.1 through 4.1.6 of this paragraph.

[Amdt 20/2]

## Appendix 5 to AMC 20-20 Guidelines for the development of a SB review and mandatory modification programme

*ED Decision 2007/019/R*

### 1. GENERAL

This appendix provides interpretation, guideline and Agency accepted means of compliance for the review of Structural Service Bulletins including a procedure for selection, assessment and related recommended corrective action for ageing aircraft structures.

### 2. SB SELECTION PROCESS

The SB selection, review, assessment and recommendation process within the Structural Task group (STG) is summarised in Figure A5-1. For the first SB review within STG meeting, all inspection SB should be selected. Afterwards, the TCH should update periodically a list of SB which were already selected for a review with all decisions made, and add to this list all new and revised SB. Moreover, some specific modification SB not linked to an inspection SB may also be selected for review.

Operators information input should address the points as detailed in Figure A5-2. This information should be collected and analysed by the TCH for the STG meeting.

If for a given selected SB there is not sufficient in-service data available before the STG meeting that would enable a recommendation to be made, its review may be deferred until enough data are available. The TCH should then check periodically until these data become available.

The operators and the Agency should be advised by the TCH of the SB selection list and provided the opportunity to submit additional SB. For this purpose, the TCH should give the operators enough information in advance (e.g. 2 months), for them to be able to properly consider the proposed selection and to gather data.

When an SB is selected, it is recommended to select also, in the same package, inspection SB that interact with it and all related modification SB. The main criteria for selecting SBs are defined in the following sub-paragraphs.

#### 2.1 High probability that structural cracking exists

Related to the number and type of finding in service and from fatigue testing.

A “no finding” result should be associated to the number of performed inspections.

The type of finding should include an analysis of its criticality.

#### 2.2 Potential structural airworthiness concern

Structural airworthiness of the aircraft is dependent on repeat inspections to verify structural condition and therefore on inspection reliability.

A short repeat inspection interval (e.g. short time to grow from detectable crack to a critical length divided by a factor) will lead to increased work load for inspectors and possible increased risk of missing damage.

Special attention should be paid to any single inspection tasks involving multiple repeat actions needed to verify the structural condition that may increase the risk of missing damage (e.g. lap splice inspections).

#### 2.3 Damage is difficult to detect during regular maintenance

The areas to inspect are difficult to access;

NDI methods are unsuitable;

Human factors associated with the inspection technique are so adverse that crack detection may not be sufficiently dependable to assure safety.

2.4 There is adjacent structural damage or the potential for it

Particular attention should be paid to areas susceptible to Widespread Fatigue Damage (WFD) and also to potential interaction between corrosion and fatigue cracking e.g. between fastener damage (due to stress corrosion or other factors) and fatigue cracking.

It is recommended to consider the potential interaction of modifications or repairs usually implemented in the concerned areas to check whether the inspections are still reliable or not (operators input)

### **3. STG MEETING, SB REVIEW AND RECOMMENDATIONS**

It is recommended to review at the same time all the SBs that can interact, the so-called SB package in the selection process. The meeting should start with an STG agreement on the selected SB list and on those deferred. At the meeting the TCH should present its analysis of each SB utilising the collection of operator input data. The STG should then collectively review the ratings (Figure A5-2) against each criteria to come to a consensus recommendation. Such a STG recommendation for a selected SB shall consider the following options:

- (a) To mandate a structural modification at a given threshold
- (b) To mandate selected inspection SB
- (c) To revise modification or repair actions
- (d) To revise other SB in the same area concerned by damages
- (e) To review inspection method and related inspection intervals
- (f) To review ALI/MRB or other maintenance instructions
- (g) To defer the review to the next STG and request operators reports on findings for a specific SB or request an inspection sampling on the oldest aircraft

STG recommendations for mandatory action are the responsibility of the TCH to forward to the Agency for appropriate action. Other STG recommendations are information provided to the STG members. It is their own responsibility to carry them out within the appropriate framework.

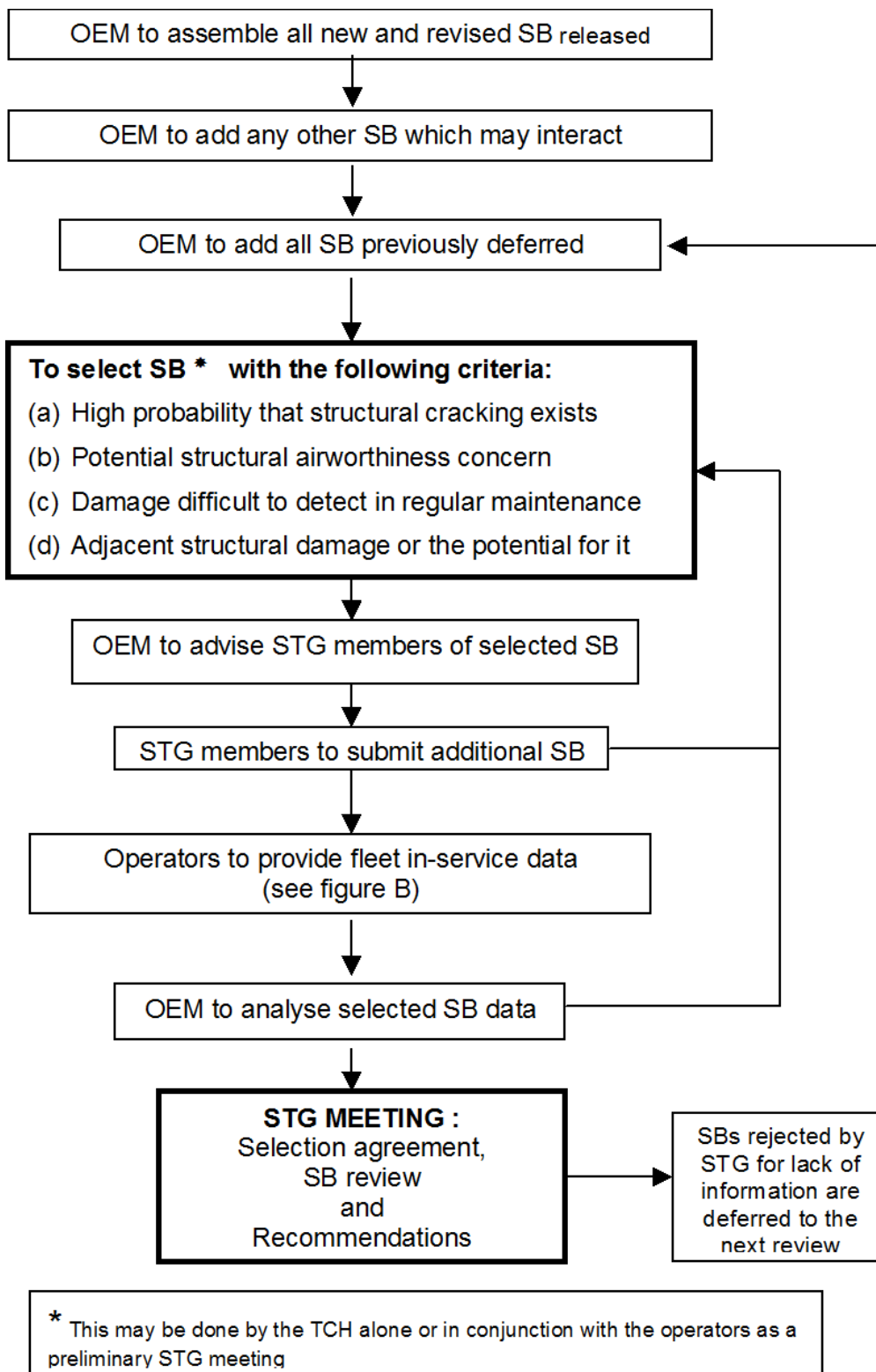

Figure A5-1: SB Selection Process and SB Review



**FIGURE A5-2: OPERATORS FLEET EXPERIENCE**

## IN-SERVICE DATA / SECTION 1

NAME OF THE OPERATOR _____
AIRCRAFT MODEL/SERIES _____
SERVICE BULLETIN (SB) NUMBER _____
TITLE _____
RELATED INSPECTION/MODIFICATION SB : 1/ _____ 2/ _____ 3/ _____
SB MANDATED? <input type="checkbox"/> YES <input type="checkbox"/> NO IF NOT, SB IMPLEMENTED IN MAINTENANCE PROGRAMME? <input type="checkbox"/> YES <input type="checkbox"/> NO
NUMBER OF AIRCRAFT TO WHICH SB APPLIES (INCLUDING ALL A/C IN THE SB EFFECTIVITY) _____
NUMBER OF AIRCRAFT EXCEEDING SB INSPECTION THRESHOLD (IF APPLICABLE) _____
NUMBER OF AIRCRAFT INSPECTED PER SB (IF APPLICABLE) ? _____
SPECIFY TYPE OF INSPECTION USED _____
NUMBER OF AIRCRAFT WITH REPORTED FINDINGS _____

## TYPE OF FINDINGS

NUMBER OF FINDINGS DUE TO OTHER INSPECTIONS THAN THE ONE PRESCRIBED IN SB (IF APPLICABLE) _____
SPECIFY TYPE OF INSPECTION USED _____
NUMBER OF AIRCRAFT EXCEEDING SB TERMINATING MODIFICATION THRESHOLD (IF APPLICABLE) _____
NUMBER OF AIRCRAFT IN WHICH TERMINATING MODIFICATION HAS BEEN ACCOMPLISHED (IF APPLICABLE) _____
NEED THIS SB (OR RELATED SB) BE IMPROVED? <input type="checkbox"/> YES <input type="checkbox"/> NO
COMMENTS: _____

IN-SERVICE DATA / SECTION 2

	(A)	(B)	(C)	(D)	(E)
CRITERIA	INSPECT-ABILITY ACCESS	FREQUENCY REPETITIVE INSPECTION	FREQUENCY OF DEFECTS	SEVERITY RATING	ADJACENT STRUCTURE DAMAGE
RATING					

(A) INSPECTABILITY/ACCESS RATING

OK ♦ Inspection carried out with little or no difficulty.

Acceptable ♦ Inspection carried out with some difficulty.

Difficulty ♦ Inspection carried out with significant difficulty.

Note: Rating should consider difficulty of access as well as inspection technique and size of inspection area.

(B) FREQUENCY OF REPETITIVE INSPECTIONS RATING

OK ♦ Greater than 6 years.

Acceptable ♦ Between 2 and 6 years.

Difficulty ♦ Less than 2 years.

(C) FREQUENCY OF DEFECTS NOTED RATING = % OF THOSE AEROPLANES BEYOND THRESHOLD ON WHICH DEFECTS HAVE BEEN FOUND

OK ♦ No defect noted.

Acceptable ♦ Defects noted but not of a significant amount (less than 10%).

Difficulty ♦ Substantial defects noted (greater than 10%).

(D) FINDING SEVERITY RATING

OK ♦ Airworthiness not affected.

Acceptable ♦ Damage not of immediate concern, but could progress or cause secondary damage.

Difficulty ♦ Airworthiness affected. Damage requires immediate repair.

(E) ADJACENT STRUCTURE DAMAGE RATING (MULTIPLE SITE DAMAGE, MULTIPLE ELEMENT DAMAGE, CORROSION, ETC.)

OK ♦ Low rate of adjacent structural damage.

Acceptable ♦ Medium rate of adjacent structural damage.

Difficulty ♦ High rate of adjacent structural damage/Multiple service actions in area.

[Amdt 20/2]

## AMC 20-21

### AMC 20-21 Programme to enhance aeroplane Electrical Wiring Interconnection System (EWIS) maintenance

ED Decision 2008/007/R

#### 1 PURPOSE

This AMC provides acceptable means of compliance for developing enhanced EWIS maintenance for operators, holders of type certificates (TC), holders of supplemental type certificates (STC) and maintenance organisations. The information in this AMC is derived from the maintenance, inspection, and alteration best practices identified through extensive research. This AMC provides an acceptable means of compliance with the appropriate certification, maintenance and operating rules. This AMC promotes a housekeeping philosophy of “protect, clean as you go” when performing maintenance, repair, or alterations on or around aircraft EWIS.

#### 2 OBJECTIVE

The objective of this AMC is to enhance the maintenance of aircraft EWIS through adoption by the aviation industry of the following:

- a. Enhanced Zonal Analysis Procedure (EZAP). This AMC presents an “enhanced zonal analysis procedure” and logic that will benefit all aircraft regardless of whether they currently have a structured Zonal Inspection Programme (ZIP), (see [Appendix A](#). Enhanced Zonal Analysis Logic Diagram and Steps and [Appendix B](#). EZAP Worksheets). Application of this procedure will ensure that appropriate attention is given to wiring installations. Using EZAP it will be possible to select stand-alone inspections (either general or detailed) and tasks to minimise the presence of combustible material. The procedure and logic in this AMC complement existing zonal analysis procedures and will also allow the identification of new wiring tasks for those aircraft that do not have a structured ZIP.
- b. Guidance for General Visual Inspection (GVI). This AMC provides clarification of the definition for a GVI as well as guidance on what is expected from such an inspection, whether performed as a stand-alone GVI or as part of a zonal inspection. It is assumed this new inspection standard will be the standard applied by operators, or their maintenance provider, when the new tasks are incorporated in to their maintenance programme.
- c. Protection and Caution. This AMC identifies protection and caution to be added to maintenance instructions, thereby enhancing procedures that will lead to minimisation of contamination and accidental damage while working on the aircraft.

The enhanced aircraft wiring maintenance information described in this AMC is intended to improve maintenance and inspection programmes for all aircraft systems. This information, when used appropriately, will improve the likelihood that wiring system degradation, including age-related problems, will be identified and corrected. Therefore, the goal of enhanced wiring maintenance information is to ensure that maintenance actions, such as inspection, repair, overhaul, replacement of parts, and preservation, do not cause a loss of wiring system function, do not cause an increase in the potential for smoke and fire in the aircraft, and do not inhibit the safe operation of the aircraft.

In order to fully realise the objectives of this AMC, operators, TC holders, STC holders and maintenance providers, will need to rethink their current approach to maintaining and modifying aircraft wiring and systems. This may require more than simply updating maintenance manuals and work cards and enhancing training. Maintenance personnel need to be aware that aircraft EWIS should be maintained with the same level of intensity as any other system in the aircraft. They also need to recognise that visual inspection of wiring has inherent limitations. Small defects such as breached or cracked insulations, especially in small gauge wire may not always be apparent. Therefore effective wiring maintenance combines visual inspection techniques with improved wiring maintenance practices and training.

Good wiring maintenance practices should contain a "protect, clean as you go" housekeeping philosophy. In other words, care should be taken to protect wire bundles and connectors during work, and to ensure that all shavings, debris and contamination are cleaned up after work is completed. This philosophy is a proactive approach to wiring system health. Wiring needs to be given special attention when maintenance is being performed on it, or around it. This is especially true when performing structural repairs, work under STCs or field approvals, or other modifications.

To fully achieve the objectives of this AMC it is imperative that all personnel performing maintenance on or around EWIS receive appropriate training (see [AMC 20-22](#): Aeroplane EWIS training programme).

### **3 APPLICABILITY**

- a. The guidance provided in this document is directed to operators, TC applicants and holders, STC applicants and maintenance organisations:
- b. The guidance provided in this AMC can be applied to all aeroplane maintenance or inspection programmes. The EZAP in [Appendix A](#) of this AMC is specifically directed towards enhancing the maintenance programmes for aircraft whose current programme does not include tasks derived from a process that specifically considers wiring in all zones as the potential source of ignition of a fire.
- c. This AMC, when followed in its entirety, outlines an acceptable means of compliance to the requirement for the development of enhanced scheduled maintenance tasks for the EWIS for the aircraft mentioned in 3a. above.
- d. Similarly, it also provides an acceptable means of compliance for CS 25.1739 and 25.1529 Appendix H25.5 for new designs.

### **4 RELATED DOCUMENTS**

- Regulation (EC) No 216/2008<sup>1</sup>
- Regulation (EC) No 1702/2003<sup>2</sup>

<sup>1</sup> Regulation (EC) No 216/2008 of the European Parliament and of the Council of 20 February 2008 on common rules in the field of civil aviation and establishing a European Aviation Safety Agency, and repealing Council Directive 91/670/EEC, Regulation (EC) No 1592/2002 and Directive 2004/36/EC (OJ L 79, 19.3.2008, p.1).

<sup>2</sup> Commission Regulation (EC) No 1702/2003 of 24 September 2003 laying down implementing rules for the airworthiness and environmental certification of aircraft and related products, parts and appliances, as well as for the certification of design and production organisations (OJ L 243, 27.9.2003, p. 6). Regulation as last amended by Regulation (EC) No 287/2008 (OJ L 87, 29.3.2008, p.3).

- Regulation (EC) No 2042/2003<sup>1</sup>
- EASA Certification Specification CS-25 Large Aeroplanes<sup>2</sup>
- EU-OPS Commercial Air Transportation (Aeroplanes)<sup>3</sup>

## 5 RELATED READING MATERIAL

- a. EASA AMC 20
  - [AMC 20-22](#) Aeroplane EWIS training
  - [AMC 20-23](#) Development of electrical standard wiring practices documentation
- b. FAA Advisory Circulars (AC).
  - AC 25-16 Electrical Fault and Fire Protection and Prevention
  - AC 25.981-1B Fuel Tank Ignition Source Prevention Guidelines
  - AC 43-12A Preventive Maintenance
  - AC 43.13-1B Acceptable Methods, Techniques and Practices for Repairs and Alterations to Aircraft
  - AC 43-204 Visual Inspection For Aircraft
  - AC 43-206 Avionics Cleaning and Corrosion Prevention/Control
  - AC 65-15A Airframe and Powerplant Mechanics Airframe Handbook, Chapter 11, Aircraft Electrical Systems
  - AC 120-YYY Training modules for wiring maintenance
- c. Reports
  - Transport Aircraft Intrusive Inspection Project, (An Analysis of the Wire Installations of Six Decommissioned Aircraft), Final Report, The Intrusive Inspection Working Group, December 29, 2000.  
[http://www.mitreaasd.org/atsrac/intrusive\\_inspection.html](http://www.mitreaasd.org/atsrac/intrusive_inspection.html)
  - FAA Aging Transport Non-Structural Systems Plan, July 1998.
  - National Transportation Safety Board, Safety Recommendation, September 19, 2000, A-00-105 through -108.  
[http://www.nts.gov/recs/letters/2000/A00\\_105\\_108.pdf](http://www.nts.gov/recs/letters/2000/A00_105_108.pdf)
  - Wire System Safety Interagency Working Group, National Science and Technology Council, Review of Federal Programmes for Wire System Safety 46 (2000).
  - Aging Transport Systems Rulemaking Advisory Committee, Task 1 and 2, Aging Systems, Final Report.

<sup>1</sup> Commission Regulation (EC) No 2042/2003 of 20 November 2003 on the continuing airworthiness of aircraft and aeronautical products, parts and appliances, and on the approval of organisations and personnel involved in these tasks (OJ L 315, 28.11.2003, p. 1). Regulation as last amended by Regulation (EC) No 376/2007 of (OJ L 94, 4.4.2007, p. 18).

<sup>2</sup> Executive Director Decision No 2003/2/RM of 14 October 2003 on certification specifications, including airworthiness codes and acceptable means of compliance, for large aeroplanes («CS-25»). Decision as last amended by Executive Director Decision No 2008/006/R of 29 August 2008 (CS-25 Amendment 5).

<sup>3</sup> Council Regulation (EEC) No 3922/91 of 16 December 1991 on the harmonisation of technical requirements and administrative procedures in the field of civil aviation (OJ L 373, 31.12.1991, p. 4). Regulation as last amended by Regulation (EC) No 8/2008 of 11 December 2007 (OJ L 10, 12.1.2008, p. 1).

[http://www.mitreaasd.org/atsrac/final\\_reports/Task\\_1&2\\_Final%20August\\_2000.pdf](http://www.mitreaasd.org/atsrac/final_reports/Task_1&2_Final%20August_2000.pdf)

- Aging Transport Systems Rulemaking Advisory Committee, Task 3, Final Report.  
[http://www.mitreaasd.org/atsrac/final\\_reports/Task\\_3\\_Final.pdf](http://www.mitreaasd.org/atsrac/final_reports/Task_3_Final.pdf)
  - Aging Transport Systems Rulemaking Advisory Committee, Task 4, Final Report, Standard Wiring Practices.  
[http://www.mitreaasd.org/atsrac/final\\_reports/Task\\_4\\_Final\\_Report\\_Sept\\_2000.pdf](http://www.mitreaasd.org/atsrac/final_reports/Task_4_Final_Report_Sept_2000.pdf)
  - Aging Transport Systems Rulemaking Advisory Committee, Task 5, Final Report, Aircraft Wiring Systems Training Curriculum and Lesson Plans.  
[http://www.mitreaasd.org/atsrac/final\\_reports/Task\\_5\\_Final\\_March\\_2001%20.pdf](http://www.mitreaasd.org/atsrac/final_reports/Task_5_Final_March_2001%20.pdf)
  - ATA Specification 117 (Wiring Maintenance Practices/Guidelines).
- d. Other Documents
- Operator/Manufacturer Scheduled Maintenance Development, ATA Maintenance Steering Group (MSG-3). May be obtained from the Air Transport Association of America; Suite 1100, 1301 Pennsylvania Ave, NW, Washington, DC 20004-1707.

## 6 DEFINITIONS

**Arc tracking:** A phenomenon in which a conductive carbon path is formed across an insulating surface. This carbon path provides a short circuit path through which current can flow. Normally a result of electrical arcing. Also referred to as "Carbon Arc Tracking," "Wet Arc Tracking," or "Dry Arc Tracking."

**Combustible:** For the purposes of this AMC the term combustible refers to the ability of any solid, liquid or gaseous material to cause a fire to be sustained after removal of the ignition source. The term is used in place of inflammable/flammable. It should not be interpreted as identifying material that will burn when subjected to a continuous source of heat as occurs when a fire develops.

**Contamination:** For the purposes of this AMC, wiring contamination refers to either of the following:

- The presence of a foreign material that is likely to cause degradation of wiring;
- The presence of a foreign material that is capable of sustaining combustion after removal of ignition source.

**Detailed Inspection (DET):** An intensive examination of a specific item, installation or assembly to detect damage, failure or irregularity. Available lighting is normally supplemented with a direct source of good lighting at an intensity deemed appropriate. Inspection aids such as mirrors, magnifying lenses or other means may be necessary. Surface cleaning and elaborate access procedures may be required.

**Electrical Wiring Interconnection System (EWIS):** See CS 25.1701.

**Functional Failure:** Failure of an item to perform its intended function within specified limits.

**General Visual Inspection (GVI):** A visual examination of an interior or exterior area, installation or assembly to detect obvious damage, failure or irregularity. This level of inspection is made from within touching distance unless otherwise specified. A mirror may be necessary to enhance visual access to all exposed surfaces in the inspection area. This level of inspection is

made under normally available lighting conditions such as daylight, hangar lighting, flashlight or droplight and may require removal or opening of access panels or doors. Stands, ladders or platforms may be required to gain proximity to the area being checked.

Lightning/High Intensity Radiated Field (L/HIRF) protection: The protection of aeroplane electrical systems and structure from induced voltages or currents by means of shielded wires, raceways, bonding jumpers, connectors, composite fairings with conductive mesh, static dischargers, and the inherent conductivity of the structure; may include aircraft specific devices, e.g., RF Gaskets.

Maintenance: As defined in Regulation (EC) No 2042/2003 Article 2(h) “maintenance means inspection, overhaul, repair, preservation, and the replacement of parts, but excludes preventive maintenance.” For the purposes of this advisory material, it also includes preventive maintenance.

Maintenance Significant Item (MSI): Items identified by the manufacturer whose failure could result in one or more of the following:

- could affect safety (on ground or in flight);
- is undetectable during operations;
- could have significant operational impact;
- could have significant economic impact.

Needling: The puncturing of a wire’s insulation to make contact with the core to test the continuity and presence of voltage in the wire segment.

Stand-alone GVI: A GVI which is not performed as part of a zonal inspection. Even in cases where the interval coincides with the zonal inspection, the stand-alone GVI shall remain an independent step within the work card.

Structural Significant Item (SSI): Any detail, element or assembly that contributes significantly to carrying flight, ground, pressure or control loads and whose failure could affect the structural integrity necessary for the safety of the aircraft.

Swarf: A term used to describe the metal particles, generated from drilling and machining operations. Such particles may accumulate on and between wires within a wire bundle.

Zonal Inspection: A collective term comprising selected GVI and visual checks that are applied to each zone, defined by access and area, to check system and powerplant installations and structure for security and general condition.

## **7 BACKGROUND**

Over the years there have been a number of in-flight smoke and fire events where contamination sustained and caused the fire to spread. Regulators and Accident Investigators have conducted aircraft inspections and found wiring contaminated with items such as dust, dirt, metal shavings, lavatory waste water, coffee, soft drinks, and napkins. In some cases dust has been found completely covering wire bundles and the surrounding area.

Research has also demonstrated that wiring can be harmed by collateral damage when maintenance is being performed on other aircraft systems. For example a person performing an inspection of an electrical power centre or avionics compartment may inadvertently cause damage to wiring in an adjacent area.

In recent years regulator and industry groups have come to the realisation that current maintenance practices may not be adequate to address aging non-structural systems. While age

is not the sole cause of wire degradation, the probability that inadequate maintenance, contamination, improper repair or mechanical damage has caused degradation to a particular EWIS increases over time. Studies by industry and regulator working groups have found that although EWIS management is an important safety issue, there has been a tendency to be complacent about EWIS. These working groups have concluded that there is a need to better manage EWIS so that they continue to function safely.

## **8 WIRE DEGRADATION**

Normal maintenance actions, even using acceptable methods, techniques and practices, can over time be a contributing factor to wire degradation. Zones that are subject to a high level of maintenance activity display more deterioration of the wiring insulation than those areas not subject to frequent maintenance. Degradation of wiring is further accelerated when inappropriate maintenance practices are used. Examples include the practice of needling wires to test the continuity or voltage, and using a metal wire or rod as a guide to feed new wires into an existing bundle. These practices could cause a breach in the wiring insulation that can contribute to arcing.

Over time, insulation can crack or breach, thereby exposing the conductor. This breakdown, coupled with maintenance actions, can exacerbate EWIS malfunction. Wiring that is undisturbed will have less degradation than wiring that is disturbed during maintenance.

For additional information on the principle causes of wire degradation see [Appendix E](#).

## **9 INSPECTION OF EWIS**

Typical analytical methods used for the development of maintenance programmes have not provided a focus on wiring. As a result most operators have not adequately addressed deterioration of EWIS in their programmes. EASA has reviewed the current inspection philosophies with the objectives of identifying improvements that could lead to a more consistent application of the inspection requirements, whether they are zonal, stand-alone GVI, or DET inspections.

EASA believes that it would be beneficial to provide guidance on the type of deterioration that a person performing a GVI, DET, or zonal inspection would be expected to discover. Though it may be realistically assumed that all operators provide such guidance to their inspectors, it is evident that significant variations exist and, in certain areas of the world, a significant enhancement of the inspection could be obtained if internationally agreed guidance material could be produced. The guidance provided by this AMC assumes each operator will adopt recent improvements made to the definitions of GVI and DET inspections. This information should be incorporated in operators' training material and in the introductory section of maintenance planning documentation.

This section is divided into three parts. The first part addresses the levels of inspection applicable to EWIS, the second part provides guidance for performing zonal inspections, and the third part provides lists of installations and areas of concern.

### **a. Levels of inspection applicable to EWIS**

#### **(1) Detailed Inspection (DET)**

An intensive examination of a specific item, installation or assembly to detect damage, failure or irregularity. Available lighting is normally supplemented with a direct source of good lighting at an intensity deemed appropriate. Inspection aids such as mirrors, magnifying lenses or other means may be necessary. Surface cleaning and elaborate access procedures may be required.



A DET can be more than just a visual inspection since it may include tactile assessment in which a component or assembly is checked for tightness/security. This is of particular significance when identifying applicable and effective tasks to ensure the continued integrity of installations such as bonding jumpers, terminal connectors, etc.

Though the term Detailed Visual Inspection remains valid for DET using only eyesight, it should be recognised that this may represent only part of the inspection called for in the source documents used to establish an operator's Maintenance Programme. For this reason it is recommended that the acronym "DVI" not be used since it excludes tactile examination from this level of inspection.

(2) General Visual Inspection (GVI).

A visual examination of an interior or exterior area, installation or assembly to detect obvious damage, failure or irregularity. This level of inspection is made from within touching distance unless otherwise specified. A mirror may be necessary to enhance visual access to all exposed surfaces in the inspection area. This level of inspection is made under normally available lighting conditions such as daylight, hangar lighting, flashlight or droplight and may require removal or opening of access panels or doors. Stands, ladders or platforms may be required to gain proximity to the area being checked.

Recent changes to this definition have added proximity guidance (within touching distance) and the allowance to use a mirror to enhance visual access to exposed surfaces when performing a GVI. These changes should result in more consistent application of GVI and support the expectations of what types of EWIS discrepancies should be detected by a GVI.

Though flashlights and mirrors may be required to provide an adequate view of all exposed surfaces, there is no requirement for equipment removal or displacement unless this is specifically called for in the access instructions. Paint and/or sealant removal is not necessary and should be avoided unless the observed condition is suspect. Should unsatisfactory conditions be suspected, items may need to be removed or displaced in order to permit proper assessment.

It is expected that the area to be inspected is clean enough to minimise the possibility that accumulated dirt or grease might hide unsatisfactory conditions that would otherwise be obvious. Any cleaning that is considered necessary should be performed in accordance with accepted procedures in order to minimise the possibility of the cleaning process itself introducing anomalies.

In general, the person performing a GVI is expected to identify degradation due to wear, vibration, moisture, contamination, excessive heat, aging, etc., and make an assessment as to what actions are appropriate to address the noted discrepancy. In making this assessment, any potential effect on adjacent system installations should be considered, particularly if these include wiring. Observations of discrepancies, such as chafing, broken clamps, sagging, interference, contamination, etc., need to be addressed.

(3) Zonal Inspection

A collective term comprising selected GVI and visual checks that are applied to each zone, defined by access and area, to check system and powerplant installations and structure for security and general condition.

A zonal inspection is essentially a GVI of an area or zone to detect obvious unsatisfactory conditions and discrepancies. Unlike a stand-alone GVI, it is not directed to any specified component or assembly.

b. Guidance for zonal inspections

The following EWIS degradation items are typical of what should be detectable and subsequently addressed as a result of a zonal inspection (as well as a result of a stand-alone GVI). It is also recommended that these items be included in maintenance and training documentation. This list is not intended to be exhaustive and may be expanded as considered appropriate.

(1) Wire/Wire Harnesses

- Wire bundle/wire bundle or wire bundle/structure contact/chafing
- Wire bundle sagging or improperly secured
- Wires damaged (obvious damage due to mechanical impact, overheating, localised chafing, etc.)
- Lacing tape and/or ties missing/incorrectly installed
- Wiring protection sheath/conduit deformity or incorrectly installed
- End of sheath rubbing on end attachment device
- Grommet missing or damaged
- Dust and lint accumulation
- Surface contamination by metal shavings/swarf
- Contamination by liquids
- Deterioration of previous repairs (e.g., splices)
- Deterioration of production splices
- Inappropriate repairs (e.g., incorrect splice)
- Inappropriate attachments to or separation from fluid lines

(2) Connectors

- External corrosion on receptacles
- Backshell tail broken
- Rubber pad or packing on backshell missing
- No backshell wire securing device
- Foolproofing chain broken
- Missing or broken safety wire
- Discoloration/evidence of overheating on terminal lugs/blocks
- Torque stripe misalignment

- 
- (3) Switches
    - Rear protection cap damaged
  - (4) Ground points
    - Corrosion
  - (5) Bonding braid/bonding jumper
    - Braid broken or disconnected
    - Multiple strands corroded
    - Multiple strands broken
  - (6) Wiring clamps or brackets
    - Corroded
    - Broken/missing
    - Bent or twisted
    - Faulty attachment (bad attachment or fastener missing)
    - Unstuck/detached
    - Protection/cushion damaged
  - (7) Supports (rails or tubes/conduit)
    - Broken
    - Deformed
    - Fastener missing
    - Missing edge protection on rims of feed through holes
    - Racetrack cushion damaged
    - Obstructed drainage holes (in conduits)
  - (8) Circuit breakers, contactors or relays
    - Signs of overheating
    - Signs of arcing
- c. Wiring installations and areas of concern

Research has shown that the following installations and areas need to be addressed in existing maintenance material.

(1) Wiring installations

Clamping points – Wire chafing is aggravated by damaged clamps, clamp cushion migration, or improper clamp installations. Aircraft manufacturers specify clamp type and part number for EWIS throughout the aircraft. When replacing clamps use those specified by the aircraft manufacturer. Tie wraps provide a rapid method of clamping especially during line maintenance operations. Improperly installed tie wraps can have a detrimental effect on wire insulation. When new wiring is installed as part of a STC or any other modification the drawings will provide wiring routing, clamp type and size, and proper location. Examples of significant wiring

modifications are the installation of new avionics systems, new galley installations and new instrumentation. Wire routing, type of clamp and clamping location should conform to the approved drawings. Adding new wire to existing wire bundles may overload the clamps causing wire bundle to sag and wires to chafe. Raceway clamp foam cushions may deteriorate with age, fall apart, and consequently would not provide proper clamping.

Connectors – Worn environmental seals, loose connectors, missing seal plugs, missing dummy contacts, or lack of strain relief on connector grommets can compromise connector integrity and allow contamination to enter the connector, leading to corrosion or grommet degradation. Connector pin corrosion can cause overheating, arcing and pin-to-pin shorting. Drip loops should be maintained when connectors are below the level of the harness and tight bends at connectors should be avoided or corrected.

Terminations – Terminations, such as terminal lugs and terminal blocks, are susceptible to mechanical damage, corrosion, heat damage and contamination from chemicals, dust and dirt. High current-carrying feeder cable terminal lugs can over time lose their original torque value due to vibration. One sign of this is heat discoloration at the terminal end. Proper build-up and nut torque is especially critical on high current carrying feeder cable lugs. Corrosion on terminal lugs and blocks can cause high resistance and overheating. Dust, dirt and other debris are combustible and therefore could sustain a fire if ignited from an overheated or arcing terminal lug. Terminal blocks and terminal strips located in equipment power centres (EPC), avionics compartments and throughout the aircraft need to be kept clean and free of any combustibles.

Backshells – Wires may break at backshells, due to excessive flexing, lack of strain relief, or improper build-up. Loss of backshell bonding may also occur due to these and other factors.

Sleeving and Conduits – Damage to sleeving and conduits, if not corrected, may lead to wire damage. Therefore, damage such as cuts, dents and creases on conduits may require further investigation for condition of wiring within.

Grounding Points – Grounding points should be checked for security (i.e., finger tightness), condition of the termination, cleanliness, and corrosion. Any grounding points that are corroded or have lost their protective coating should be repaired.

Splices – Both sealed and non-sealed splices are susceptible to vibration, mechanical damage, corrosion, heat damage, chemical contamination, and environmental deterioration. Power feeder cables normally carry high current levels and are very susceptible to installation error and splice degradation. All splices should conform to the TC or STC holder's published recommendations. In the absence of published recommendations, environmental splices are recommended to be used.

(2) Areas of concern

Wire Raceways and Bundles – Adding wires to existing wire raceways may cause undue wear and chafing of the wire installation and inability to maintain the wire in the raceway. Adding wire to existing bundles may cause wire to sag against the structure, which can cause chafing.

Wings – The wing leading and trailing edges are areas that experience difficult environments for wiring installations. The wing leading and trailing edge wiring is exposed on some aircraft models whenever the flaps or slats are extended. Other potential damage sources include slat torque shafts and bleed air ducts.

Engine, Pylon, and Nacelle Area – These areas experience high vibration, heat, frequent maintenance, and are susceptible to chemical contamination.

Accessory compartment and equipment bays – These areas typically contain items such as electrical components, pneumatic components and ducting, hydraulic components and plumbing, and may be susceptible to vibration, heat, and liquid contamination.

Auxiliary Power Unit (APU) – Like the engine/nacelle area, the APU is susceptible to high vibration, heat, frequent maintenance, and chemical contamination.

Landing Gear and Wheel Wells – This area is exposed to severe external environmental conditions in addition to vibration and chemical contamination.

Electrical Panels and Line Replaceable Units (LRU) – Panel wiring is particularly prone to broken wires and damaged insulation when these high density areas are disturbed during troubleshooting activities, major modifications, and refurbishments. Wire damage may be minimised by tying wiring to wooden dowels to reduce wire disturbance during modification. There may be some configurations where connector support brackets would be more desirable and cause less disturbance of the wiring than removal of individual connectors from the supports.

Batteries – Wires in the vicinity of all aircraft batteries are susceptible to corrosion and discoloration. These wires should be inspected for corrosion and discoloration. Discoloured wires should be inspected for serviceability.

Power Feeders – High current wiring and associated connections have the potential to generate intense heat. Power feeder cables, terminals, and splices may be subject to degradation or loosening due to vibration. If any signs of overheating are seen, splices or termination should be replaced. Depending on design, service experience may highlight a need to periodically check for proper torque of power feeder cable terminal ends, especially in high vibration areas. This applies to galley and engine/APU generator power feeders.

Under Galleys, Lavatories, and Cockpit – Areas under the galleys, lavatories, and cockpit, are particularly susceptible to contamination from coffee, food, water, soft drinks, lavatory fluids, dust, lint, etc. This contamination can be minimised by adherence to proper floor panel sealing procedures in these areas.

Fluid Drain plumbing – Leaks from fluid drain plumbing may lead to liquid contamination of wiring. In addition to routine visual inspections, service experience may highlight a need for periodic leak checks or cleaning.

Fuselage Drain provisions – Some installations include features designed to catch leakage that is plumbed to an appropriate exit. Blockage of the drain path can result in liquid contamination of wiring. In addition to routine visual inspections, service experience may highlight that these installations and associated plumbing should be periodically checked to ensure the drain path is free of obstructions.

Cargo Bay/Underfloor – Damage to wiring in the cargo bay underfloor can occur due to maintenance activities in the area.

Wiring subject to movement – Wiring that is subject to movement or bending during normal operation or maintenance access should be inspected at locations such as doors, actuators, landing gear mechanisms, and electrical access panels.

Access Panels – Wiring near access panels may receive accidental damage as a result of repetitive maintenance access and thus may warrant special attention.

Under Doors – Areas under cargo, passenger and service entry doors are susceptible to fluid ingress from rain, snow and liquid spills. Fluid drain provisions and floor panel sealing should be periodically inspected and repaired as necessary.

Under Cockpit Sliding Windows – Areas under cockpit sliding windows are susceptible to water ingress from rain and snow. Fluid drain provisions should be periodically inspected and repaired as necessary.

Areas where wiring is difficult to access – Areas where wiring is difficult to access (e.g., flight deck instrument panels, cockpit pedestal area) may accumulate excessive dust and other contaminants as a result of infrequent cleaning. In these areas it may be necessary to remove components and disassemble other systems to facilitate access to the area.

## 10 ENHANCED ZONAL ANALYSIS PROCEDURE (EZAP)

The EZAP identified in [Appendix A](#) of this AMC is designed to permit appropriate attention to be given to electrical wiring installations. This is achieved by providing a means to identify applicable and effective tasks to minimise accumulation of combustible materials and address wiring installation discrepancies that may not otherwise be reliably detected by inspections contained in existing maintenance programmes.

For aircraft models operating on maintenance programmes that already include a dedicated ZIP, the logic described in this AMC will result in enhancements to those programmes, and the zonal inspection requirements may not differ greatly from the existing ZIP.

In analysis conducted under the EZAP, items such as plumbing, ducting, systems installations, etc., should be evaluated for possible contribution to wiring failures. In cases where a GVI is required to assess degradation of these items, a zonal GVI within a ZIP may be considered appropriate.

For those operators that do not have a dedicated ZIP, application of the logic is likely to result in identification of a large number of wiring-related tasks that will need to be consolidated within the existing Systems/Powerplant Programme.

In either case, any new tasks identified by the logic may be compared with existing tasks and credit given for equivalent tasks already contained in the maintenance programme. For operators with ZIP that already contain zonal GVI, the number of new tasks that must be added to the programme may be significantly fewer than for an operator without a dedicated ZIP. Therefore, operators without a ZIP may find it beneficial to develop a ZIP in accordance with an industry-accepted methodology in conjunction with application of the EZAP.

The logic and procedures identified in this AMC apply to TC, STC and other modifications. It is expected that the TC and STC holders would use the logic and procedures to identify any need for additional instructions for continued airworthiness. However, the operator may be required to ensure the logic is used to identify such instructions for modifications or STC where they are no longer supported by the design organisation or STC holder.

## **11 MAINTENANCE PRACTICES: PROTECTION AND CAUTION RECOMMENDATIONS**

EASA has identified some specific maintenance and servicing tasks for which more robust practices are recommended to be adopted by operators, and/or maintenance providers. These recommendations apply to all tasks, including those performed on an unscheduled basis without an accompanying routine job instruction card. Performance of these maintenance practices will help prevent contamination of EWIS that result from contact with harmful solids (such as metal shavings) or fluids during maintenance, modifications, and repairs of aeroplane structures, and components. In addition, the training of maintenance and servicing personnel should address the potential consequences of their actions on the wiring in the work vicinity.

a. Item 1: Installation, repair, or modification to wiring.

Wiring and its associated components (protective coverings, connectors, clamping provisions, conduits, etc.) often comprise the most delicate and maintenance-sensitive portions of an installation or system. Extreme care should be exercised and proper procedures used during installation, repair, or modification of wiring to ensure safe and reliable performance of the function supplied by the wiring.

Proper wire selection, routing/separation, clamping configurations, use of splices, repair or replacement of protective coverings, pinning/de-pinning of connections, etc., should be performed in accordance with the applicable sections of the Aircraft Maintenance Manual (AMM), Wiring Practices Manual (WPM), or other documents authorised for maintenance use. In addition, special care should be taken to minimise disturbance of existing adjacent wiring during all maintenance activities. When wiring is displaced during a maintenance activity, special attention should be given to returning it to its normal configuration in accordance with the applicable maintenance instructions.

b. Item 2: Structural repairs, STC, modifications.

Structural repair, STC or modification activity inherently introduces tooling and residual debris that is harmful to aircraft wiring. Structural repairs or modifications often require displacement (or removal) of wiring to provide access to the work area. Even minor displacement of wiring, especially while clamped, can damage wire insulation, which can result in degraded performance, arcing, or circuit failure.

Extreme care should be exercised to protect wiring from mechanical damage by tools or other equipment used during structural repairs, STC or modifications. Drilling blindly into the aircraft structure should be avoided. Damage to wire installation could cause wire arcing, fire and smoke. Wiring located adjacent to drilling or riveting operations should be carefully displaced or covered to reduce the possibility of mechanical damage.

Debris such as drill shavings, liberated fastener pieces, broken drill bits, etc., should not be allowed to contaminate or penetrate wiring or electrical components. This can cause severe damage to insulation and potential arcing by providing a conductive path to ground or between two or more wires of different loads. Once contaminated, removal of this type of debris from wire bundles is extremely difficult. Therefore, precautions should be taken to prevent contamination of any kind from entering the wire bundle.

Before initiating structural repair, STC or modification activity, the work area should be carefully surveyed to identify all wiring and electrical components that may be subject to contamination. All wiring and electrical components in the debris field should be covered or removed to prevent contamination or damage. Consideration should be given to using drills equipped with vacuum aspiration to further minimise risk of metallic debris

contaminating wire bundles. Clean electrical components and wiring after completion of work per applicable maintenance instructions.

c. Item 3: Aircraft De-Icing or Anti-Icing.

In order to prevent damage to exposed electrical components and wiring in areas such as wing leading and trailing edges, wheelwells, and landing gear, care should be exercised when spraying de/anti-icing fluids. Direct pressure spray onto electrical components and wiring can lead to contamination or degradation and thus should be avoided.

d. Item 4: Inclement weather.

EWIS in areas below doorways, floors, access panels, and servicing bays are prone to corrosion or contamination due to their exposure to the elements. Snow, slush, or excessive moisture should be removed from these areas before closing doors or panels. Remove deposits of snow/slush from any items (e.g. cargo containers) before loading in the aircraft. During inclement weather, keep doors/panels closed as much as possible to prevent ingress of snow, slush, or excessive moisture that could increase potential for EWIS degradation.

e. Item 5: Component removal/installation (relating to attached wiring).

Excessive handling and movement during removal and installation of components may be harmful to aircraft wiring. Use appropriate connector pliers (e.g. soft jawed) to loosen coupling rings that are too tight to be loosened by hand. Alternately, pull on the plug body and unscrew the coupling ring until the connector is separated. Do not use excessive force, and do not pull on attached wires. When reconnecting, special care should be taken to ensure the connector body is fully seated, the jam nut is fully secured, and no tension is on the wires.

When equipment is disconnected, use protective caps on all connectors (plug or receptacle) to prevent contamination or damage of the contacts. Sleeves or plastic bags may be used if protective caps are not available. Use of sleeves or plastic bags should be temporary because of the risk of condensation. It is recommended to use a humidity absorber with sleeves or plastic bags.

f. Item 6: Pressure Washing.

In order to prevent damage to exposed electrical components and wiring in areas such as wing leading and trailing edges, wheelwells, and landing gear, care should be exercised when spraying water or cleaning fluids. Direct high-pressure spraying onto electrical components and wiring can lead to contamination or degradation and should be avoided. When practical, wiring and connectors should be protected before pressure washing. Water rinse should be used to remove cleaning solution residue after washing. Breakdown of wire insulation may occur with long term exposure of wiring to cleaning solutions. Although these recommendations are good practice and technique, the aeroplane maintenance manual or STC holder's instructions should be consulted for additional detailed instructions regarding pressure washing.

g. Item 7: Cleaning of EWIS (in situ).

Extreme care should be exercised and proper procedures used during cleaning to ensure safe and reliable performance of the function supplied by the wiring.

Care should be taken to avoid displacement or disturbance of wiring during cleaning of non-aggressive contamination. However, in the event of contamination by aggressive contaminants (e.g. livestock waste, salt water, battery electrolyte, etc.) such



displacement may be necessary. In these cases wiring should be released from its installation so as to avoid undue stress being induced in wiring or connectors. Similarly, if liquid contamination enters the bundle, then ties should be removed before separating the wires. Although these recommendations for cleaning of EWIS are considered good practice and technique, the aeroplane maintenance manual or STC holder's instructions should be consulted for additional detailed instructions.

Clean only the area and items that have contamination. Before cleaning, make sure that the cleaning materials and methods will not cause more contamination. If a cloth is used, make sure that it is clean, dry, and lint-free. A connector should be completely dry before mating. Any fluids remaining on a connector can have a deteriorating affect on the connector or the system or both.

- h. Item 8: Servicing, modifying, or repairing waste/water systems.

EWIS in areas adjacent to waste/water systems are prone to contamination from those systems. Care should be exercised to prevent any fluids from reaching electrical components and wiring while servicing, modifying, or repairing waste/water systems. Cover exposed electrical components and wiring during waste/water system modification or repair. Operator practice may call for a weak acid solution to be periodically flushed through lavatory systems to enhance reliability and efficiency of operation. In view of the effect of acid contamination on systems and structure, the system should be confirmed to be free of leaks before using such solutions.

- i. Item 9: Servicing, modifying, or repairing oil systems.

Electrical wiring interconnections in areas adjacent to oil systems are prone to contamination from those systems. To minimise the attraction and adhesion of foreign material, care should be exercised to avoid any fluids from reaching electrical components and wiring while servicing, modifying, or repairing oil systems. Oil and debris in combination with damaged wiring can present a fire hazard.

- j. Item 10: Servicing, modifying, or repairing hydraulic systems.

EWIS in areas adjacent to hydraulic systems are prone to contamination from those systems. To minimise the attraction and adhesion of foreign material, care should be exercised to avoid any fluids from reaching electrical components and wiring while servicing, modifying, or repairing hydraulic systems.

- k. Item 11: Gaining access (entering zones).

When entering or working on the aircraft, care should be exercised to prevent damage to adjacent or hidden electrical components and wiring, including wiring that may be hidden from view (e.g., covered by insulation blankets). Use protective boards or platforms for adequate support and protection. Avoid using wire bundles as handholds, steps and supports. Work lights should not be hung or supported by wiring. If wiring must be displaced (or removed) for work area access, it should be adequately released from its clamping (or other restraining provisions) to allow movement without damage and returned after work is completed.

- l. Item 12: Application of Corrosion Preventions Compounds (CPC).

When applying CPC in aeroplane zones containing wire and associated components (i.e. clamps, connectors and ties), care should be taken to prevent CPC from coming in contact with the wire and components. Dust and lint is more likely to collect on wire that has CPC

on it. Application of CPC should be done in accordance with the aircraft manufacturer's recommendations.

## **12 CHANGES**

The programme to enhance EWIS maintenance also applies to EWIS installed, modified, or affected by changes or STC. Changes that could affect EWIS include, but are not limited to, those that install new equipment in close proximity to wiring, introduce a heat source in the zone, or introduce potential sources of combustible material or harmful contamination into the zone.

The owner/operator is responsible for determining if the EWIS has been changed (or affected by a change) and ensuring that their maintenance programme is enhanced as appropriate.

[Amdt 20/4]

## Appendix A to AMC 20-21 Enhanced Zonal Analysis Logic Diagram and Steps

ED Decision 2008/007/R

Figure 1. Enhanced Zonal Analysis Procedure

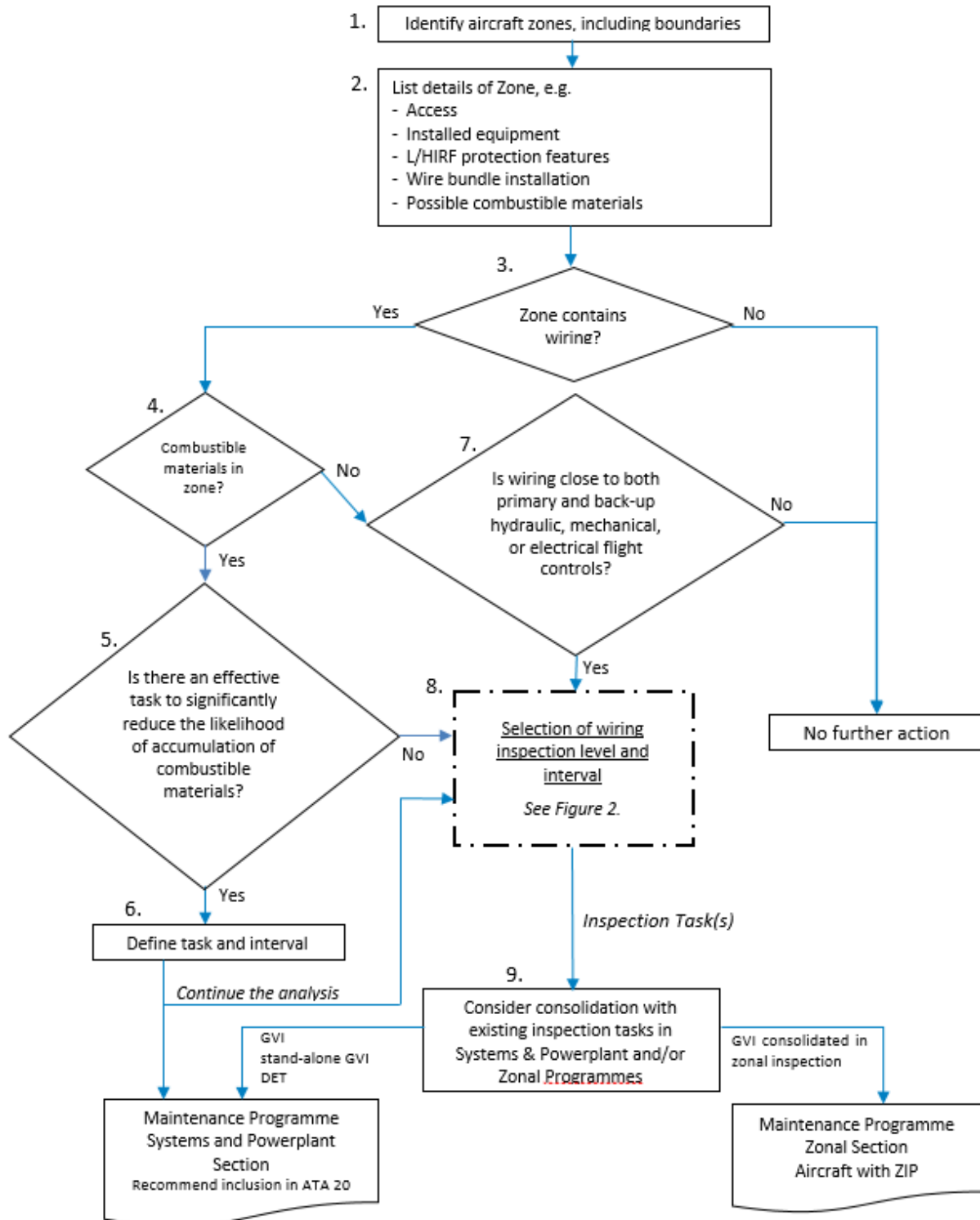
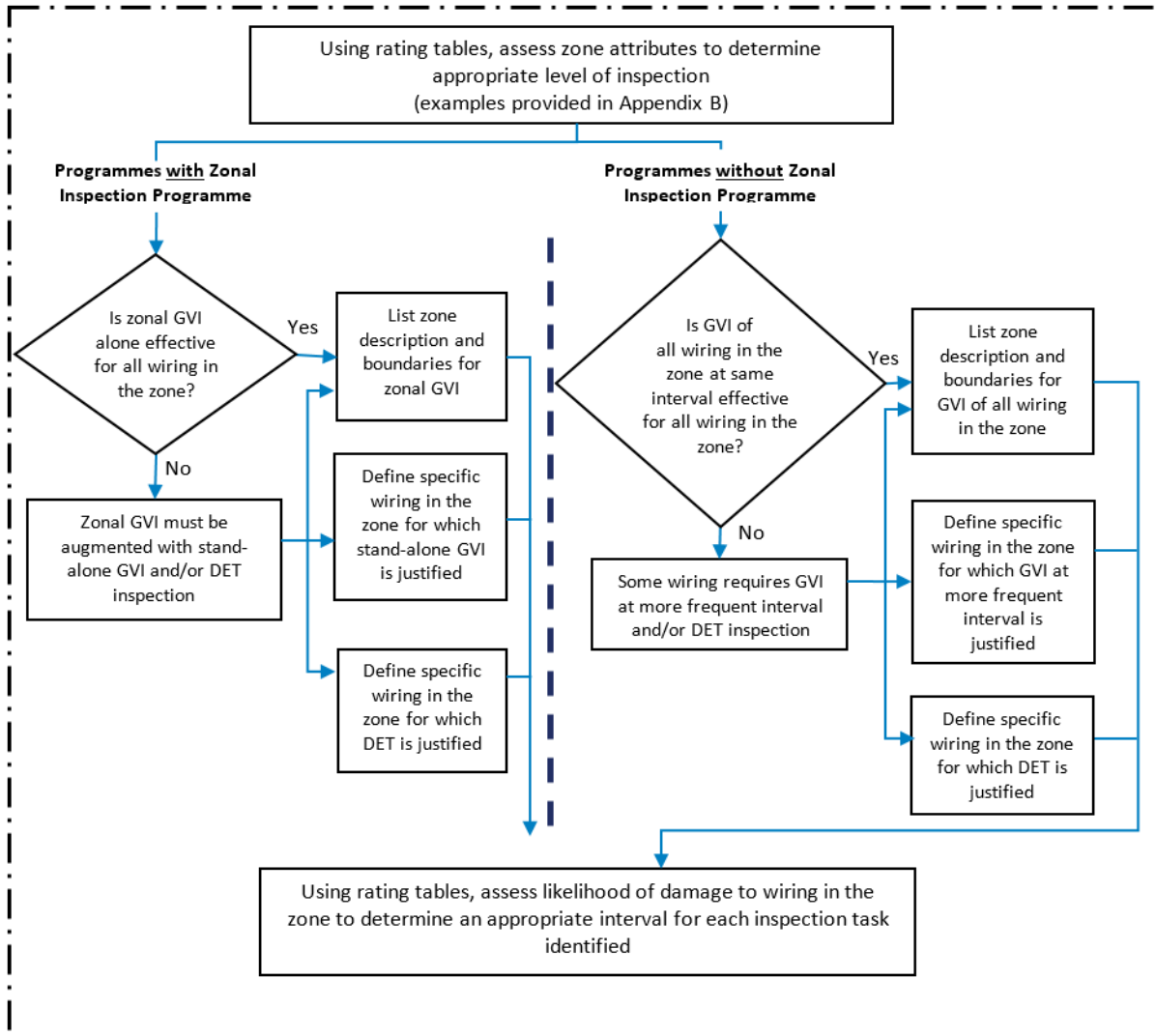

Figure 2. Step 8 - Wiring Inspection Level and Interval Selection



## **Explanation for Steps in Enhanced Zonal Analyses Procedure Logic Diagram**

The following paragraphs provide further explanation of each step in the Enhanced Zonal Analyses Procedure logic, (Figures 1 and 2). It is recommended that, where possible, the analysts utilise the availability of actual aircraft to ensure they fully understand the zones being analysed. This will aid in determination of density, size, environmental issues, and accidental damage issues.

### **Step 1** “Identify aircraft zones, including boundaries”

The system consists of Major Zones, Major Sub Zones and Zones.

The zones, wherever possible, shall be defined by actual physical boundaries such as wing spars, major bulkheads, cabin floor, control surface boundaries, skin, etc. and include access provisions for each zone.

If the type design holder or operator has not yet established aircraft zones, it is recommended that it does so. Whenever possible, zones should be defined using a consistent method such as ATA iSpec 2200 (formerly ATA Spec 100), varied only to accommodate particular design constructional differences.

### **Step 2** “List of details of zone”

An evaluation will be carried out to identify system installations, significant components, L/HIRF protection features, typical power levels in any installed wiring bundles, combustible materials (present or possible accumulation), etc.

With respect to power levels the analyst should be aware whether the bundle consists primarily of main generator feeder cables, low voltage instrumentation wiring or standard bus wiring. This information will later be used in determining the potential effects of deterioration.

The reference to combustible materials highlights the need to assess whether the zone might contain material/vapour that could cause a fire to be sustained in the event of an ignition source arising in adjacent wiring. Examples include the possible presence of fuel vapours, dust/lint accumulation and contaminated insulation blankets. See also under Step 4 for further information.

For aircraft types whose design directives may not have excluded the possibility of inadequate segregation between systems, the analyst should identify locations where both primary and back-up flight controls are routed within 2 inches/50 mm of a wiring harness. This information is required to answer the question in Step 7.

### **Step 3** “Zone contains wiring?”

This question serves as a means to eliminate from the EZAP those zones that do not contain any wiring.

### **Step 4** “Combustible materials in zone?”

This question requires an evaluation of whether the zone might contain combustible material that could cause a fire to be sustained in the event of an ignition source arising in adjacent wiring. Examples include the possible presence of fuel vapours, dust/lint accumulation, and contaminated insulation blankets.

With respect to commonly used liquids (e.g., oils, hydraulic fluids, corrosion prevention compounds) the analyst should refer to the product specification in order to assess the potential for combustibility. The product may be readily combustible only in vapour/mist

form and thus an assessment is required to determine if conditions might exist in the zone for the product to be in this state.

Although liquid contamination of wiring by most synthetic oil and hydraulic fluids (e.g. skydrol) may not be considered combustible, it is a cause for concern if it occurs in a zone where it causes significant adherence of dust and lint.

The analyst should assess what sources of combustible products may contaminate the zone following any single failure considered likely from in-service experience. Unshrouded pipes having connections within the zone should be considered as potential contamination sources. Inherent ventilation in the zone should be taken into account when determining the potential for subsequent combustion. This influences the response to the question of how near to the harness the source should be for there to be a concern.

Avionics and instruments located in the flight compartment and equipment bays tend to attract dust, etc. In view of the heat generated by these components and the relatively tightly packed installations, the analyst should consider these zones as having potential for combustible material. Thus, the enhanced logic should always be used for these zones.

Note: Although moisture (whether clean water or otherwise) is not combustible, its presence on wiring is a cause for concern because it may increase the probability of arcing from small breaches in the insulation, which could cause a localised fire in the wire bundle. The risk of a sustained fire caused by moisture induced arcing is mitigated in Step 5 by identification of a task to reduce the likelihood of accumulation of combustible material on or adjacent to the wiring.

Step 5 “Is there an effective task to significantly reduce the likelihood of accumulation of combustible materials?”

Most operator maintenance programmes have not included tasks directed towards removal or prevention of significant accumulations of combustible materials on or adjacent to wiring.

This question requires an evaluation of whether the accumulation on or adjacent to wiring can be significantly reduced. Task effectiveness criteria should include consideration of the potential for damaging the wiring.

Though restoration tasks (e.g., cleaning) are the most likely applicable tasks, the possibility to identify other tasks is not eliminated. A detailed inspection of a hydraulic pipe might be assessed as appropriate if high-pressure mist from pinhole corrosion could impinge a wire bundle and the inherent zone ventilation is low.

Step 6 “Define task and interval”

This step will define an applicable task and an effective interval. It should be included as a dedicated task in the Systems and Powerplant section. Within Maintenance Review Board (MRB) Reports, this may be introduced under ATA 20 with no Failure Effect Category quoted.

It is not the intent that restoration tasks should be so aggressive as to damage the wiring, but should be applied to a level that significantly reduces the likelihood of combustion.

Step 7 “Is wiring close to primary and back-up hydraulic, mechanical, or electrical flight controls?”

Where wiring is close (i.e. within 5 cm (2 inches)) to both primary and back-up hydraulic, mechanical, or electrical flight controls, this question is asked to ensure that Step 8 logic is applied even in the absence of combustible materials in the zone.

For zones where combustible materials are present (as determined in Step 4), proximity is addressed in the inspection level definition portion of Step 8 and this question need not be asked.

It addresses the concern that segregation between primary and back-up flight controls may not have been consistently achieved. Even in the absence of combustible material, a localised wire arcing could impact continued safe flight and landing if hydraulic pipes, mechanical cables, or wiring for fly-by-wire controls are routed in close proximity (i.e. within 5 cm (2 inches)) to a wiring harness. In consideration of the redundancy in flight control systems, the question needs to be answered 'Yes' only if both the primary and back-up system might be affected by wire arcing. Note that in zones where a fire might be sustained by combustible material the enhanced logic will automatically be followed.

On all aircraft type designs, irrespective of TC date, modifications may not have taken into account the TC holder's design and installation criteria. It is thus recommended that STC holders assess their design changes with this question included in the logic unless they can demonstrate that they followed equivalent installation criteria. Similarly, air carriers and air operators will have to assess modifications that have been accomplished on their aircraft.

#### Step 8 "Selection of Wiring Inspection Level and Interval"

##### a. Inspection Level.

At this point in the analysis, it is already confirmed that wiring is installed in a zone where the presence of combustible materials is possible and/or the wiring is in close proximity to primary and back-up hydraulic or mechanical flight controls. Therefore, some level of inspection of the wiring in the zone is required, and this step details how the proper level of inspection and interval can be selected.

One method of selecting the proper inspection level and interval is through the use of ratings tables which rate attributes of the zone and how the wiring is affected by, or can affect those attributes. The precise format of this will be determined by the analyst, but example rating tables appear in [Appendix B](#) and may be referred to for clarity.

The inspection level characteristics that may be included in the rating system are:

- Zone size (volume);
- Density of installed equipment within the zone;
- Potential effects of fire on adjacent wiring and systems.

Zone size will be assessed relative to the size of the aircraft, typically identified as small, medium or large. The smaller the zone and the less congested it is, the more likely it is that wiring degradation will be identified by GVI.

Density of installed equipment, including wiring, within the zone will be assessed relative to the size of the zone. The density of the zone is typically identified as low, medium or high.

Potential effects of fire on adjacent wiring and systems requires the analyst to assess the potential effect of a localised fire on adjacent wiring and systems by

considering the potential for loss of multiple functions to the extent that continued safe operation may not be possible.

Consideration of potential effect must also include whether wiring is in close proximity (i.e. within 5 cm (2 inches)) to both primary and back-up flight controls. A GVI alone may not be adequate if a fire caused by failure of the wiring poses a risk to aircraft controllability.

At minimum, all wiring in the zone will require a GVI at a common interval. For operators with a ZIP, this may be defined as a zonal GVI. For operators without ZIP, it shall be defined as a GVI of all wiring in the zone.

The question is asked, "Is a GVI (or zonal GVI) of all wiring in the zone at the same interval effective for all wiring in the zone?" This is to consider if there are specific items/areas in the zone that are more vulnerable to damage or contamination and thus may warrant a closer or more frequent inspection.

This determination could result in the selection of a more frequent GVI, a stand-alone GVI (for operators with a ZIP), or even a DET inspection. The intention is to select a DET of wiring only when justified by consideration of all three characteristics of the zone (size, density, and potential effect of fire). The analyst should be cautious to avoid unnecessary selection of DET where GVI is adequate. Over-use of DET dilutes the effectiveness of the inspection.

Note: The level of inspection required may be influenced by tasks identified in Steps 5 and 6. For example, if a cleaning task was selected in Step 5 and 6 that will minimise the accumulation of combustible materials in the zone, this may justify selection of a GVI in lieu of a DET for the wiring in the zone.

b. Inspection Interval.

The selection of an effective interval can also be accomplished using a rating system. The characteristics for wiring to be rated should include the following:

- Possibility of Accidental Damage;
- Environmental factors.

The rating tables should be designed to define increasing inspection frequency with increasing risk of accidental damage and increasing severity of the local environment within the zone. Examples are provided in [Appendix E](#).

The selection of inspection tasks possible in this step is specific to whether the maintenance programme includes a dedicated ZIP or not.

For ZIP programmes, the possible inspection tasks are:

- Zonal GVI;
- Stand-alone GVI;
- DET.

For non-ZIP programmes, the possible inspection tasks are:

- GVI;
- DET.



Note: At this point the analyst will have determined the required inspection level and interval for wiring in the zone. Task consolidation in Step 9 allows consideration as to whether an inspection selected as a result of this analysis can be considered accomplished as part of the existing maintenance programme.

### Step 9 “Task Consolidation”

This step in the procedure examines the potential for consolidation between the tasks derived from the EZAP and inspections that already exist in the Maintenance Programme. Consolidation requires that the inspections in the existing maintenance programme are performed in accordance with the inspection definitions provided in this AMC.

For programmes that include a ZIP:

Some GVI identified by application of the EZAP may be adequately covered by existing zonal GVI in the zone and no change or addition to the existing zonal GVI is required. This should reduce the number of new GVI that must be introduced into a programme that already includes a ZIP.

The consolidation of GVI tasks has to take into account the access requirements and the interval of each task. The Working Group may conclude that a stand-alone GVI of the wiring may be justified if the zonal GVI of the other systems within the same zone does not need to have such a frequent inspection.

Stand-alone GVI and DET identified by application of EZAP cannot be consolidated into the ZIP and must be introduced and retained as dedicated tasks in the scheduled maintenance programme under ATA 20. These tasks, along with tasks identified to reduce the accumulation of combustible materials, shall be uniquely identified to ensure they are not consolidated in the zonal programme nor deleted during future programme development. Within MSG-3 based MRB Reports, these may be introduced under ATA 20 with no Failure Effect Category quoted.

For programmes without a ZIP:

Although non-ZIP programmes may already include some dedicated inspections of wiring that may be reviewed for equivalency to new tasks identified by application of the EZAP, it is expected that a significant number of new wiring inspections will be identified for introduction as dedicated tasks in the System and Powerplant programme. All new tasks identified by application of EZAP shall be uniquely identified to ensure they are not deleted during future programme development.

The following guide can be used to determine proper consolidation between EZAP derived inspections and existing inspections that have not been specifically identified as stand-alone tasks, of the same item or area:

- a. Where the EZAP inspection interval and existing inspection interval are equal, but the inspection levels are different, the more intense inspection will take precedent (i.e. a 1C DET takes precedent over a 1C GVI).
- b. Where the EZAP inspection interval and existing inspection interval are different, but the inspection levels are equal, the more frequent inspection will take precedent (i.e. a 1C GVI takes precedent over a 2C GVI).
- c. Where the EZAP inspection interval and level are different from the existing inspection interval and level, these tasks may be consolidated only when the more frequent inspection is also the more intense (i.e. a 1C DET takes precedent over a

2C GVI). When the more frequent inspection is less intense, the tasks should not be consolidated.

For all programmes, these tasks shall be uniquely identified in the programme for future development consideration.

For EZAP-derived STC tasks, it may not be possible for the STC holder to determine whether a ZIP exists on specific aircraft that will utilise the STC. Therefore, where a ZIP exists, consolidation of EZAP-derived STC tasks into a specific operator's ZIP will be the responsibility of the operator and subject to approval by the competent authority.

In cases where the STC holder determines a requirement for a GVI that should not be consolidated into a ZIP, this stand-alone GVI should be specifically identified as such in the EZAP derived ICAW for the STC.

[Amdt 20/4]

## Appendix B to AMC 20-21 Examples of Typical EZAP Worksheets

*ED Decision 2008/007/R*

The following worksheets are provided as an example to assist implementation of the EZAP logic explained in this AMC. These may be adjusted by the analyst to suit specific applications.

1. Details of Zone.
2. Assessment of Zone Attributes.
- 3A. Inspection Level Determination based on Rating Tables (for use where a dedicated ZIP exists).
- 3B. Inspection Level Determination based on Rating Tables (for use where no dedicated ZIP exists).
4. Interval Determination based on Rating Tables.
5. Task Summary.

In particular, the interval ranges quoted in the rating table on Sheet 4 are solely to explain a typical arrangement of values. For a particular application, these must be compatible with the interval framework used in the existing maintenance or inspection programme. They may be expressed in terms of usage parameter (e.g. flight hours or calendar time) or in terms of letter check (as in the example).

Enhanced Zonal Analysis - Details of Zone		Sheet 1 of 5
ZONE NO:	ZONE DESCRIPTION:	
1. Zone Details (Boundaries, Access):		
<p style="text-align: center;"><b>2. EQUIPMENT INSTALLED</b></p> <ul style="list-style-type: none"> <li><input type="checkbox"/> Hydraulic Plumbing</li> <li><input type="checkbox"/> Hydraulic Components (valves, actuators, pumps)</li> <li><input type="checkbox"/> Pneumatic Plumbing</li> <li><input type="checkbox"/> Pneumatic Components (valves, actuators)</li> <li><input type="checkbox"/> Electrical Wiring - Power Feeder (high voltage, high amperage)</li> <li><input type="checkbox"/> Electrical Wiring - Motor Driven Devices</li> <li><input type="checkbox"/> Electrical Wiring - Instrumentation, and Monitoring</li> <li><input type="checkbox"/> Electrical Wiring - Data Bus</li> <li><input type="checkbox"/> Electrical Components</li> <li><input type="checkbox"/> Primary Flight Control Mechanisms</li> <li><input type="checkbox"/> Secondary Flight Control Mechanisms</li> <li><input type="checkbox"/> Engine Control Mechanisms</li> <li><input type="checkbox"/> Fuel Components</li> <li><input type="checkbox"/> Insulation</li> <li><input type="checkbox"/> Oxygen</li> <li><input type="checkbox"/> Potable Water</li> <li><input type="checkbox"/> Waste Water</li> </ul>	<p style="text-align: center;"><b>COMMENTS</b></p> <div style="border: 1px solid black; padding: 10px; margin: 10px 0;"> <p><i>This sheet is used to comply with Steps 1 and 2 of the Enhanced Zonal Analysis Procedure:</i></p> <ol style="list-style-type: none"> <li><i>1. Describe the zone (location, access, boundaries)</i></li> <li><i>2. List the content of the zone; installed equipment, wiring, plumbing, components, etc.</i></li> </ol> <p><i>In the comments section on this sheet, it would be appropriate to note significant wire related items such as "Wire bundle routed within 2" of high-temp anti-ice ducting". The intent is to provide the analyst with a clear understanding of what's in the zone and how it could potentially affect wiring.</i></p> </div>	
Sample EZAP Worksheet	Date:	Page 1 of 5

Enhanced Zonal Analysis - Assessment of Zone Attributes		Sheet 2 of 5																		
ZONE NO:	ZONE DESCRIPTION:																			
<div style="border: 1px solid black; padding: 5px; margin-bottom: 10px;">Steps 1 and 2 completed on Sheet 1.</div> <div style="display: flex; justify-content: space-between;"> <div style="width: 45%;"> <div style="margin-bottom: 10px;"> <table border="1" style="width: 100%; border-collapse: collapse;"> <tr> <td style="padding: 5px;">3. Zone contains wiring?</td> <td style="width: 50px; text-align: center;">N</td> </tr> <tr> <td></td> <td style="text-align: center;">Y</td> </tr> </table> </div> <div style="margin-bottom: 10px;"> <table border="1" style="width: 100%; border-collapse: collapse;"> <tr> <td style="padding: 5px;">4. Combustible materials in zone?</td> <td style="width: 50px; text-align: center;">N</td> </tr> <tr> <td></td> <td style="text-align: center;">Y</td> </tr> </table> </div> <div style="margin-bottom: 10px;"> <table border="1" style="width: 100%; border-collapse: collapse;"> <tr> <td style="padding: 5px;">5. Is there an effective task to significantly reduce the likelihood of accumulation of combustible materials?</td> <td style="width: 50px; text-align: center;">N</td> </tr> <tr> <td></td> <td style="text-align: center;">Y</td> </tr> </table> </div> <div style="margin-bottom: 10px;"> <table border="1" style="width: 100%; border-collapse: collapse;"> <tr> <td style="padding: 5px;">6. Define task and interval. List on Sheet 5, Task Summary.</td> </tr> </table> </div> </div> <div style="width: 45%;"> <div style="margin-bottom: 10px;"> <table border="1" style="width: 100%; border-collapse: collapse;"> <tr> <td style="padding: 5px;">7. Is wiring close to both primary and back-up hydraulic, mechanical, or electrical flight controls?</td> <td style="width: 50px; text-align: center;">N</td> </tr> <tr> <td></td> <td style="text-align: center;">Y</td> </tr> </table> </div> <div style="margin-bottom: 10px;"> <table border="1" style="width: 100%; border-collapse: collapse;"> <tr> <td style="padding: 5px;">8. Wiring inspection task determination. See Sheet 3.</td> </tr> </table> </div> <div style="border: 1px solid black; padding: 5px; text-align: center;">             No further action.         </div> </div> </div> <div style="width: 50%; padding: 10px;"> <p><b>Answers and Explanation to Questions</b> (Note: Steps 1 &amp; 2 completed on Sheet 1.)</p> <p>3. <i>This sheet is used to answer Questions 3 thru 7 of the Enhanced Zonal Analysis Procedure.</i></p> <p>4. <i>If the answer to Questions 3 and 7 is 'NO', then no further action is required in this analysis which is designed to address only wiring systems.</i></p> <p>5. <i>If the answer to Question 5 is 'YES', and a task is identified that can significantly reduce the likelihood of accumulation of combustible materials, the task and interval must be defined in Step 6. If the task identified is a cleaning task to remove dust/lint accumulation from wiring, the interval for the task must be frequent enough to keep the wiring relatively clean based on the expected rate of accumulation of dust/lint on the wiring in the zone.</i></p> <p>6. <i>In all cases, after Step 5 and/or Step 6, the analysis is continued to Step 8.</i></p> <p>7.</p> </div>			3. Zone contains wiring?	N		Y	4. Combustible materials in zone?	N		Y	5. Is there an effective task to significantly reduce the likelihood of accumulation of combustible materials?	N		Y	6. Define task and interval. List on Sheet 5, Task Summary.	7. Is wiring close to both primary and back-up hydraulic, mechanical, or electrical flight controls?	N		Y	8. Wiring inspection task determination. See Sheet 3.
3. Zone contains wiring?	N																			
	Y																			
4. Combustible materials in zone?	N																			
	Y																			
5. Is there an effective task to significantly reduce the likelihood of accumulation of combustible materials?	N																			
	Y																			
6. Define task and interval. List on Sheet 5, Task Summary.																				
7. Is wiring close to both primary and back-up hydraulic, mechanical, or electrical flight controls?	N																			
	Y																			
8. Wiring inspection task determination. See Sheet 3.																				

Enhanced Zonal Analysis - Inspection Level Determination based on Zone Size, Density, Potential Impact of Fire		Sheet 3A of 5																											
For Programs with dedicated Zonal Inspection Program (ZIP)																													
ZONE NO:	ZONE DESCRIPTION																												
<table border="1" style="width: 100%; border-collapse: collapse;"> <thead> <tr style="background-color: #e0f2f1;"> <th colspan="4">Zone Size/Density Assessment</th> </tr> <tr> <th colspan="2"></th> <th colspan="3">Zone Size</th> </tr> <tr> <th colspan="2"></th> <th>Small</th> <th>Medium</th> <th>Large</th> </tr> </thead> <tbody> <tr> <th rowspan="3" style="writing-mode: vertical-rl; transform: rotate(180deg);">Density</th> <th>Low</th> <td style="text-align: center;">1</td> <td style="text-align: center;">2</td> <td style="text-align: center;">3</td> </tr> <tr> <th>Medium</th> <td style="text-align: center;">2</td> <td style="text-align: center;">2</td> <td style="text-align: center;">3</td> </tr> <tr> <th>High</th> <td style="text-align: center;">2</td> <td style="text-align: center;">3</td> <td style="text-align: center;">3</td> </tr> </tbody> </table> <p style="text-align: center;"><i>Circle appropriate result and insert below.</i></p> <p>RESULT: <span style="border: 1px solid black; display: inline-block; width: 100px; height: 20px;"></span></p>			Zone Size/Density Assessment						Zone Size					Small	Medium	Large	Density	Low	1	2	3	Medium	2	2	3	High	2	3	3
Zone Size/Density Assessment																													
		Zone Size																											
		Small	Medium	Large																									
Density	Low	1	2	3																									
	Medium	2	2	3																									
	High	2	3	3																									
<table border="1" style="width: 100%; border-collapse: collapse;"> <thead> <tr style="background-color: #e0f2f1;"> <th colspan="4">Inspection Level Determination Based on Potential Effect of Fire in Zone</th> </tr> <tr> <th colspan="2">Size/Density Factor</th> <th>1</th> <th>2</th> <th>3</th> </tr> </thead> <tbody> <tr> <th rowspan="3" style="writing-mode: vertical-rl; transform: rotate(180deg);">Potential Effects of Fire in Zone</th> <th>Low</th> <td style="text-align: center;">Zonal GVI</td> <td style="text-align: center;">Zonal GVI</td> <td style="text-align: center;">Zonal GVI</td> </tr> <tr> <th>Medium</th> <td style="text-align: center;">Zonal GVI</td> <td style="text-align: center;">Zonal GVI + Stand-alone GVI of some wiring</td> <td style="text-align: center;">Zonal GVI + Stand-alone GVI of some wiring</td> </tr> <tr> <th>High</th> <td style="text-align: center;">Zonal GVI + Stand-alone GVI of some wiring</td> <td style="text-align: center;">Zonal GVI + Stand-alone GVI and/or DET of some wiring</td> <td style="text-align: center;">Zonal GVI + Stand-alone GVI and/or DET of some wiring</td> </tr> </tbody> </table> <p style="text-align: center;"><i>Circle appropriate result and answer questions in Boxes below.</i></p>			Inspection Level Determination Based on Potential Effect of Fire in Zone				Size/Density Factor		1	2	3	Potential Effects of Fire in Zone	Low	Zonal GVI	Zonal GVI	Zonal GVI	Medium	Zonal GVI	Zonal GVI + Stand-alone GVI of some wiring	Zonal GVI + Stand-alone GVI of some wiring	High	Zonal GVI + Stand-alone GVI of some wiring	Zonal GVI + Stand-alone GVI and/or DET of some wiring	Zonal GVI + Stand-alone GVI and/or DET of some wiring					
Inspection Level Determination Based on Potential Effect of Fire in Zone																													
Size/Density Factor		1	2	3																									
Potential Effects of Fire in Zone	Low	Zonal GVI	Zonal GVI	Zonal GVI																									
	Medium	Zonal GVI	Zonal GVI + Stand-alone GVI of some wiring	Zonal GVI + Stand-alone GVI of some wiring																									
	High	Zonal GVI + Stand-alone GVI of some wiring	Zonal GVI + Stand-alone GVI and/or DET of some wiring	Zonal GVI + Stand-alone GVI and/or DET of some wiring																									
<p><b>1. Is a Zonal GVI alone effective for the entire Zone?</b></p> <p>Yes → <b>2. List zone description and boundaries for Zonal GVI.</b></p> <p>No → <b>Zonal GVI must be augmented with Stand-alone GVI, and/or DET Inspection.</b></p> <p>→ <b>3. Define specific items/areas in the zone for which Stand-alone GVI is justified</b></p> <p>→ <b>4. Define specific item/areas in the zone for which DET is justified</b></p> <p><small>If answer to Box 1 is "Yes" . answer Box 2 only. If answer to Box 1 is "No", answer Boxes 2, 3, &amp; 4.</small></p>		<p><b>Answers &amp; Explanation:</b></p> <ol style="list-style-type: none"> <li>The tables on this Sheet are used to select the appropriate level of inspection for the wiring in the zone based on an assessment of zone size, density, and potential effects of fire in the zone.</li> <li>This worksheet is designed for operators whose existing maintenance program already includes a dedicated Zonal Inspection Program. It is assumed that an existing ZIP already includes a Zonal GVI of all zones that contain wiring, and that the wiring is included in the Zonal GVI.</li> <li>The minimum outcome of this analysis will always be a Zonal GVI of any zone where the presence of combustible materials is possible and/or wiring is located in close proximity to both primary and backup hydraulic or mechanical flight controls.</li> <li>The Inspection Level Determination Table allows the Analyst to determine if a Zonal GVI alone is adequate for all wiring in the zone, or if the Zonal GVI must be augmented with a Stand-alone GVI and/or a DET inspection of some portion of the wiring.</li> </ol> <p>If a Zonal GVI is adequate for all wiring in the zone, the analyst must identify the inspection area as the zone itself (Box 2). Interval selection will be made on Sheet 4.</p> <p>If a Zonal GVI is not adequate for all wiring in the zone, in addition to identifying the Zonal GVI (Box 2), the analyst must also any identify the specific items/areas in the zone where a Stand-alone GVI (Box 3) and/or a DET inspection (Box 4) is justified.</p> <p><i>Note: While it is useful to know the existing Zonal GVI interval while conducting this analysis, it is not assumed that the Zonal GVI interval selected during this analysis with respect to wiring will be the same as the existing interval. During task consolidation after completion of the analysis, the most frequent Zonal GVI interval for the zone will take precedent.</i></p>																											
<small>Sample EZAP Worksheet</small>		<small>Date:</small>																											

**Enhanced Zonal Analysis - Inspection Level Determination based on Zone Size, Density, Potential Impact of Fire** Sheet 3B of 5

For Programs without dedicated Zonal Inspection Program (ZIP)

ZONE NO: \_\_\_\_\_ ZONE DESCRIPTION: \_\_\_\_\_

Zone Size/Density Assessment				
		Zone Size		
		Small	Medium	Large
Density	Low	1	2	3
	Medium	2	2	3
	High	2	3	3

*Circle appropriate result and insert below.*

RESULT:

Inspection Level Determination Based on Potential Effect of Fire in Zone				
Size/Density Factor		1	2	3
Potential Effects of Fire in Zone	Low	GVI of all wiring in zone at same interval	GVI of all wiring in zone at same interval	GVI of all wiring in zone at same interval
	Medium	GVI of all wiring in zone at same interval	GVI of all wiring in zone at same interval + GVI of some wiring at more frequent interval	GVI of all wiring in zone at same interval + GVI of some wiring at more frequent interval
	High	GVI of all wiring in zone at same interval + GVI of some wiring at more frequent interval	GVI of all wiring in zone at same interval + GVI of some wiring at more frequent interval and/or DET of some wiring	GVI of all wiring in zone at same interval + GVI of some wiring at more frequent interval and/or DET of some wiring

*Circle appropriate result and answer questions in Boxes below.*

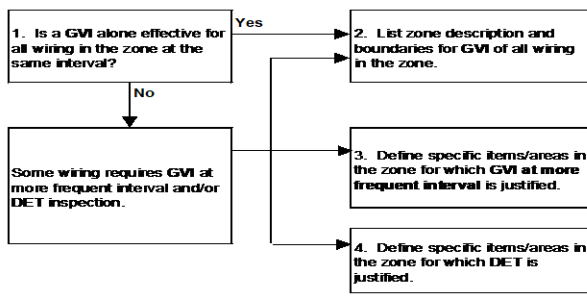

If answer to Box 1 is "Yes", answer Box 2 only. If answer to Box 1 is "No", answer Boxes 2, 3, & 4.

**Answers & Explanation:**

1. The tables on this sheet are used to select an Inspection Level based on zone size, density, and potential effect of fire in the zone. These factors are used to determine if a GVI of all wiring in the zone at the same interval is adequate, or if some wiring requires a more frequent GVI, or even a DET inspection.
2. This worksheet is designed for operators whose existing maintenance program does not include a dedicated Zonal Inspection Program. The minimum outcome of this analysis will always be a GVI of all wiring in any zone where the presence of combustible materials is possible and/or wiring is located in close proximity to both primary and backup hydraulic or mechanical flight controls.
3. If a GVI of all wiring in the zone at the same interval is adequate, the analyst must identify the inspection requirement as "GVI of all wiring in the zone" (Box 2) and proceed to Sheet 4 to determine the GVI interval.
4. If a GVI of all wiring in the zone at the same interval is not adequate, then the analyst must identify the specific items/areas in the zone where a more frequent GVI (Box 3) and/or a DET inspection (Box 4) is justified.

**Enhanced Zonal Analysis - Interval Determination Based on Hostility of Environment and Likelihood of Accidental Damage** Sheet 4 of 5

ZONE NO:  ZONE DESCRIPTION:

Interval selection is specific to each task identified on Sheet 3A or 3B. For GVI of entire zone, consider overall zone environment and likelihood of damage. For Stand-alone GVI or DET, consider environment and likelihood of damage only in respect to the specific item/area defined for inspection.

Item/Area Defined for Inspection:

Inspection Level:

Hostility of Environment	
1 - Passive, 2 - Moderate, 3 - Severe	
Temperature	
Vibration	
Chemicals (toilet fluids, etc.)	
Humidity	
Contamination	
Other -	
<b>Highest Result</b>	

Likelihood of Accidental Damage	
1 - Low, 2 - Medium, 3 - High	
Ground Handling Equipment	
F. O. D.	
Weather Effects (hail, etc.)	
Frequency of Maintenance Activities	
Fluid Spillage	
Passenger Traffic	
Other -	
<b>Highest Result</b>	

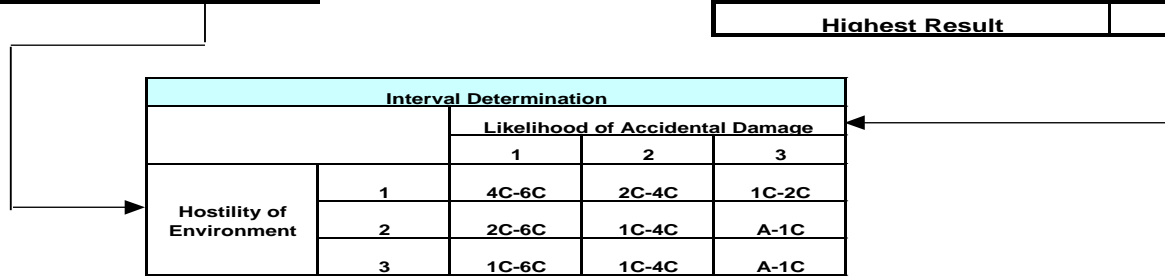

Interval Determination				
		Likelihood of Accidental Damage		
		1	2	3
Hostility of Environment	1	4C-6C	2C-4C	1C-2C
	2	2C-6C	1C-4C	A-1C
	3	1C-6C	1C-4C	A-1C

RESULT	<input type="text"/>
--------	----------------------

Upon completion, enter all task and interval selections onto Sheet 5, Task Summary.



Enhanced Zonal Analysis - Task Summary			Sheet 5 of 5
<b>ZONE NO:</b>	<b>ZONE DESCRIPTION:</b>		
Zone Description:			
TASK SUMMARY			
Task Number	Access	Interval	Task Description
			<div style="border: 1px solid black; padding: 10px; width: fit-content; margin: auto;"> <p><i>This Sheet is used to list all tasks and intervals selected as a result of EZAP analysis.</i></p> </div>
Sample EZAP Worksheet		Date:	Sheet 5 of 5

[Amdt AMC/4]

## Appendix C to AMC 20-21 Determination if a major change to an aircraft should be specifically subjected to an EZAP

ED Decision 2008/007/R

The EZAP provides a means for TC and STC holders to develop improvements to EWIS maintenance programs. These improvements will be in the form of new inspections and other tasks designed to prevent significant accumulation of combustible materials on or adjacent to EWIS components that would be added to the Instructions for Continued Airworthiness or Service Bulletins (SB) for the aircraft and STC.

While TC holders are required to conduct the EZAP for all zones in an aircraft, it may be determined that EZAP for an SB or STC is not necessary where the modification does not appreciably affect the zones where it is installed. The “Determination if SB modification or STC requires EZAP” procedure was developed to identify modifications that sufficiently affect zone attributes to warrant re-application of EZAP to the entire zone.

This logic assumes that the aircraft TC holder has accomplished the EZAP on each zone of the aircraft without consideration of the SB modification or STC installation. The objective of this analysis is to assess whether the modification itself has affected wiring or certain zone attributes that could change the outcome of the EZAP performed by the aircraft TC holder.

The determination if the SB or STC requires EZAP, and re-application of the EZAP to SB or STC affected zones, is the responsibility of the respective holder of the SB or STC. It is expected that the TC and STC holders will collaborate with each other and operators as necessary to obtain information required to conduct the analysis. The TC or STC holder should communicate the results of the procedure, including the cases when no new tasks are identified. The method of communication may be via SB, Service Letter, ICAW Revision, or other means acceptable to EASA.

In situations where a previously installed STC is no longer supported by a viable STC holder (e.g. STC holder defunct), the responsibility for determining if the STC requires EZAP, and re-application of EZAP to any affected zones, is assigned to the individual operators who utilise the STC on their aircraft. In cases where the operator does not have experience in application of analytical logic processes, it will be necessary for the operator to gain competence in, or seek external assistance in conducting the analysis.

A record of the outcome of operator accomplished analysis for STC (even if no tasks are identified) should be permanently retained by the operator. A copy of the record should be included in the aircraft records normally transferred upon change of aircraft operator.

The attached logic chart provides a means to assess whether an SB modification or STC has sufficiently affected wiring or certain other zone attributes as to require reapplication of the EZAP to the entire zone with consideration of the modification present. The section following the chart provides detailed explanations of each step in the “Determination if SB modification or STC requires EZAP” with appropriate examples.

It is recommended that, where possible, the analyst should utilise the availability of actual aircraft to ensure they fully understand the zones being analysed. Specifically, it must be determined how installation of the modification could affect zone attributes such as density, environment, proximity of wiring to primary and back-up flight controls, presence of combustible materials, and potential for accidental damage to wiring.

Appendix C. Figure 1. Determination if SB modification or STC requires EZAP

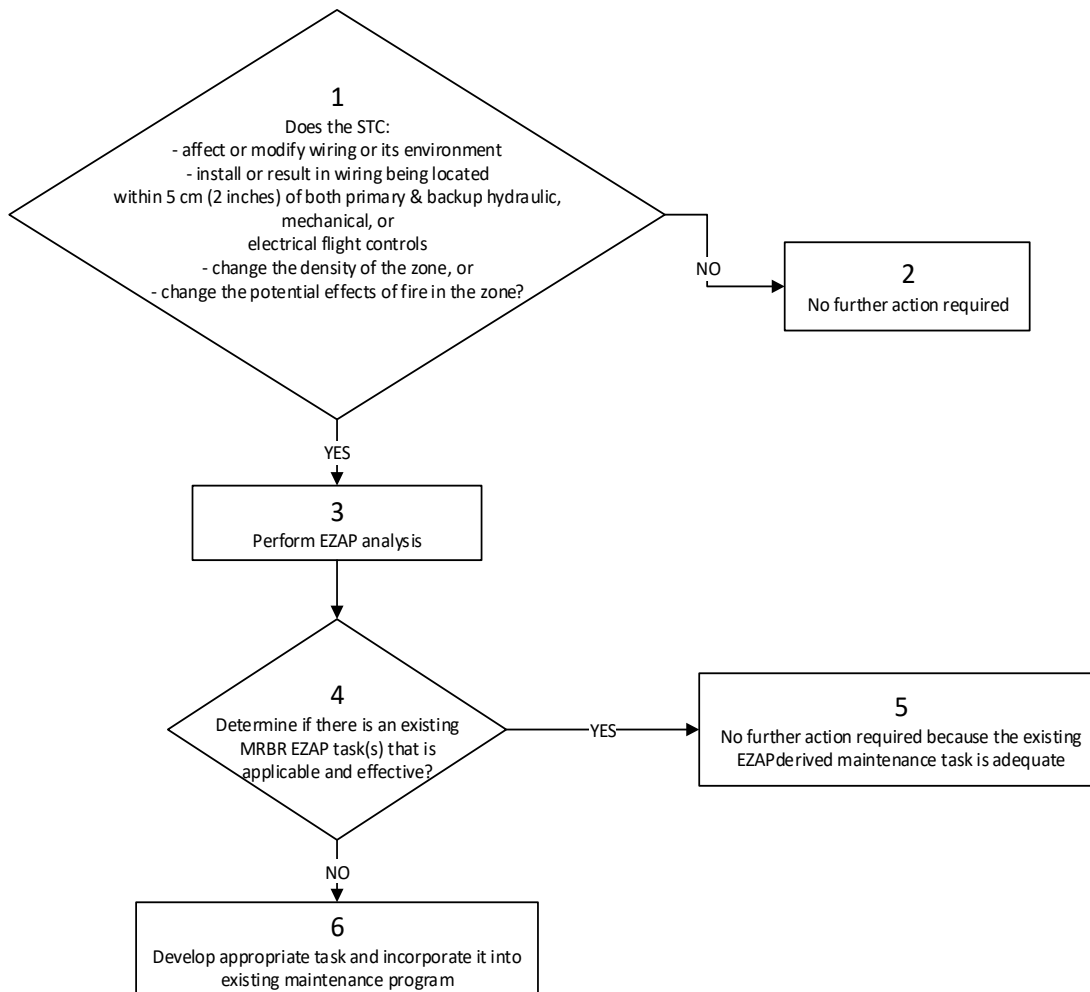

### Explanation of Steps

**Step 1:** Does the SB or STC affect or modify wiring or it's environment?

The question asks whether the STC affects or modifies wiring. Modifications to wiring or other EWIS components include, but are not limited to removal, addition, relocation, etc.

Does the SB or STC install or result in wiring being located within 5 cm (2 inches) of primary and back-up hydraulic, mechanical or electric flight controls, change the density of the zone or change the potential effects of fire in the zone?

Does the SB or STC affect zone density? If the STC includes the addition or deletion of numerous components in a small area, the density of the zone could be changed even if wire bundles are untouched. A significant change in the zone density should warrant re-analysis of the zone.

Potential effects of fire on adjacent wiring and systems require the analyst to assess the potential effect of a localised fire on adjacent wiring and systems by considering the potential for loss of multiple functions to the extent that a hazard could be introduced.

Consideration of potential effect must also include whether wiring is in close proximity (i.e. within 5 cm (2 inches)) to both primary and back-up flight controls.

Additionally, this question requires an evaluation of whether the zone might contain combustible material that could cause a fire to be sustained in the event of an ignition source arising in adjacent wiring. Examples include the possible presence of fuel vapours, dust/lint accumulation, and contaminated insulation blankets.

With respect to commonly used liquids (e.g. oils, hydraulic fluids, and corrosion prevention compounds), the analyst should refer to the product specification in order to assess the potential for combustibility. The product may be readily combustible only in vapour/mist form and thus an assessment is required to determine if conditions might exist in the zone for the product to be in this state.

Although liquid contamination of wiring by most synthetic oil and hydraulic fluids (e.g. skydrol) may not be considered combustible, it is a cause for concern if it occurs in a zone where contamination causes significant adherence of dust and lint.

If the answer to this question is 'No', then no further action is required (Step 2), since the density of the zone or the potential effects of fire in the zone has not changed.

Step 2: No further action is required.

Step 3: Perform an EZAP analysis.

If the answer to question 1 is 'Yes', then the only way to determine if existing EWIS maintenance tasks are sufficient is to perform the EZAP for the SB or STC and compare the results with the existing EWIS maintenance tasks (see Step 4).

Step 4: Is there an existing MRBR EZAP task(s) that is applicable and effective?

Once the SB or STC EZAP has been accomplished, a comparison of the derived maintenance tasks can be made with the existing EWIS maintenance tasks. If the existing tasks are adequate, then no further action regarding EWIS maintenance actions for the STC is necessary.

Step 5: No further action is required since the existing EZAP-derived maintenance task is adequate.

Step 6: Develop an appropriate task and incorporate it into the existing maintenance programme.

These tasks should be incorporated into the operator's existing maintenance programme.

[Amdt 20/4]

## Appendix D to AMC 20-21

*ED Decision 2008/007/R*

(RESERVED)

## Appendix E to AMC 20-21 Causes of Wire Degradation

ED Decision 2008/007/R

The following items are considered principal causes of wiring degradation and should be used to help focus maintenance programmes:

Vibration - High vibration areas tend to accelerate degradation over time, resulting in “chattering” contacts and intermittent symptoms. High vibration of tie-wraps or string-ties can cause damage to insulation. In addition, high vibration will exacerbate any existing problem with wire insulation cracking.

Moisture - High moisture areas generally accelerate corrosion of terminals, pins, sockets, and conductors. It should be noted that wiring installed in clean, dry areas with moderate temperatures appears to hold up well.

Maintenance - Scheduled and unscheduled maintenance activities, if done improperly, may contribute to long-term problems and wiring degradation. Certain repairs may have limited durability and should be evaluated to ascertain if rework is necessary. Repairs that conform to manufacturers recommended maintenance practices are generally considered permanent and should not require rework. Furthermore, care should be taken to prevent undue collateral damage to EWIS while performing maintenance on other systems.

Metal shavings and debris have been discovered on wire bundles after maintenance, repairs, modifications, or STC have been performed. Care should be taken to protect wire bundles and connectors during modification work. The work areas should be cleaned while the work progresses to ensure that all shavings and debris are removed; the work area should be thoroughly cleaned after the work is complete; and the work area should be inspected after the final cleaning.

Repairs should be performed using the most effective methods available. Since wire splices are more susceptible to degradation, arcing, and overheating, the recommended method of repairing a wire is with an environmental splice.

Indirect Damage - Events such as pneumatic duct ruptures or duct clamp leakage can cause damage that, while not initially evident, can cause wiring problems at a later stage. When events such as these occur, surrounding EWIS should be carefully inspected to ensure that there is no damage or no potential for damage is evident. The indirect damage caused by these types of events may be broken clamps or ties, broken wire insulation, or even broken conductor strands. In some cases the pressure of the duct rupture may cause wire separation from the connector or terminal strip.

Contamination - Wire contamination refers to either of the following situations:

- a. The presence of a foreign material that is likely to cause degradation of wiring.
- b. The presence of a foreign material that is capable of sustaining combustion after removal of ignition source.

The contaminant may be in solid or liquid form. Solid contaminants such as metal shavings, swarf, debris, livestock waste, lint and dust can accumulate on wiring and may degrade or penetrate wiring or electrical components.

Chemicals in fluids such as hydraulic fluid, battery electrolytes, fuel, corrosion inhibiting compounds, waste system chemicals, cleaning agents, de-icing fluids, paint, soft drinks and coffee can contribute to degradation of wiring.

Hydraulic fluids, de-icing fluids and battery electrolyte require special consideration. These fluids, although essential for aircraft operation, can damage connector grommets, wire bundle clamps, wire ties and wire lacing, causing chafing and arcing. Wiring exposed to these fluids should be given special

attention during inspection. Contaminated wire insulation that has visible cracking or breaches to the core conductor can eventually arc and cause a fire. Wiring exposed to, or in close proximity to, any of these chemicals may need to be inspected more frequently for damage or degradation.

When cleaning areas or zones of the aircraft that contain both wiring and chemical contaminants, special cleaning procedures and precautions may be needed. Such procedures may include wrapping wire and connectors with a protective covering prior to cleaning. This would be especially true if pressure-washing equipment is utilised. In all cases the aircraft manufacturer recommended procedures should be followed.

Waste system spills also require special attention. Service history has shown that these spills can have detrimental effects on aircraft EWIS and have resulted in smoke and fire events. When this type of contamination is found all affected components in the EWIS should be thoroughly cleaned, inspected and repaired or replaced if necessary. The source of the spill or leakage should be located and corrected.

Heat - Exposure to high heat can accelerate degradation of wiring by causing insulation dryness and cracking. Direct contact with a high heat source can quickly damage insulation. Burned, charred or even melted insulation are the most likely indicators of this type of damage. Low levels of heat can also degrade wiring over a longer period of time. This type of degradation is sometimes seen on engines, in galley wiring such as coffee makers and ovens, and behind fluorescent lights, especially the ballasts.

[Amdt 20/4]

## AMC 20-22

### AMC 20-22 Aeroplane Electrical Wiring Interconnection System Training Programme

*ED Decision 2008/007/R*

#### 1 PURPOSE

This AMC provides acceptable means of compliance for developing an enhanced Electrical Wiring Interconnection System (EWIS) training programme. The information in this AMC is derived from the best practices training developed through extensive research. This AMC is an effort by the Agency to officially endorse these best practices and to dispense this information industry-wide so that the benefits of this information can be effectively realised. Following this AMC will result in a training programme that will improve the awareness and skill level of the aviation personnel in EWIS production, modification, maintenance, inspection, alterations and repair. This AMC promotes a philosophy of training for all personnel who come into contact with aeroplane EWIS as part of their job and tailors the training for each workgroup to their particular needs.

#### 2 OBJECTIVE

This AMC has been published in order to provide the approved organisations with acceptable means of compliance to comply with their training obligations as required in paragraphs 21.A.145 and 21.A.245 of Part-21, 145.A.30 and 145.A.35 of Part-145 and M.A.706 of Part-M with respect to EWIS.

To fully realise the objectives of this AMC, operators, holders of type certificates (TC), holders of supplemental type certificates (STC), maintenance organisations and persons performing modifications or repairs, will need to rethink their current approach to maintaining and modifying aeroplane wiring and systems. This may require more than simply updating maintenance manuals and work cards and enhancing training. Maintenance personnel need to be aware that aeroplane EWIS should be maintained with the same level of intensity as any other system in the aeroplane. They also need to recognise that visual inspection of wiring has inherent limitations. Small defects such as breached or cracked insulation, especially in small gage wire may not always be apparent. Therefore, effective wiring maintenance combines visual inspection techniques with improved wiring maintenance practices and training.

The objective of this EWIS training programme is to give operators, holders of TC, holders of STC, maintenance organisations and persons performing field approval modifications or repairs a model for the development of their own EWIS training programme. This will ensure that proper procedures, methods techniques, and practices are used when performing maintenance, preventive maintenance, inspection, alteration, and cleaning of EWIS.

The training syllabus and curriculum for those personnel directly involved in the maintenance and inspection of EWIS, identified as Target Group 1 and 2, are in [Appendix A](#) and [C](#) to this AMC.

This AMC also provides guidance on the development of EWIS training programmes for personnel who are not directly involved in the maintenance and inspection of EWIS. Although there is no direct regulatory requirement for EWIS training of these personnel, operators may choose to provide EWIS training. The training syllabus and curriculum for these personnel, identified as Target Groups 3 through 8, are in [Appendix B](#) and [C](#) to this AMC.



It is believed that training personnel in these groups would greatly enhance awareness of the importance of EWIS safety in the overall safe operation of aeroplanes. Although these groups are not directly involved in the maintenance of EWIS, they have the potential to have an adverse impact on EWIS. This can occur through inadvertent contact with EWIS during aeroplane cleaning or when individuals perform unrelated maintenance that could impact the integrity of EWIS. Mechanics leaving drill shavings on wire bundles is one example of how this could occur. Some people prepare paperwork that guides mechanics, training this target group in EWIS should help to ensure that proper attention is paid to EWIS issues.

This programme was developed for eight different target groups and may be used for the minimum requirements for initial and recurrent training (see training matrix). Depending on the duties, some may fall into more than one target group and, therefore, must fulfil all objectives of the associated target groups. The target groups are:

- a. Qualified staff performing EWIS maintenance.  
These staff members are personnel who perform wiring systems maintenance and their training is based on their job description and the work being done by them (e.g. avionics skilled workers or technicians cat B2).
- b. Qualified staff performing maintenance inspections on wiring systems.  
These staff members are personnel who perform EWIS inspections (but not maintenance), and their training is based on their job description and the work being done by them (e.g. inspectors/technicians cat B2).
- c. Qualified staff performing electrical/avionic engineering on in-service aeroplane.  
These staff members are personnel who are authorised to design EWIS installations, modifications and repairs (e.g. electric/avionic engineers).
- d. Qualified staff performing general maintenance/inspections not involving wire maintenance (LRU change is not considered wire maintenance).  
These staff members are personnel who perform maintenance on aeroplane that may require removal/reconnection of electrical connective devices (e.g. inspectors/technicians cat A or B1).
- e. Qualified staff performing other engineering or planning work on in-service aeroplane.  
These staff members are personnel who are authorised to design mechanical/structure systems installations, modifications and repairs, or personnel who are authorised to plan maintenance tasks.
- f. Other service staff with duties in proximity to EWIS.  
These staff members are personnel whose duties would bring them into contact/view of aeroplane wiring systems. This would include, but not be limited to: Aeroplane cleaners, cargo loaders, fuelers, lavatory servicing personnel, de-icing personnel, push back personnel.
- g. Flight Deck Crew.  
(E.g. Pilots, Flight Engineers)
- h. Cabin Crew.

### 3 APPLICABILITY

This AMC describes acceptable means, but not the only means, of compliance with the appropriate certification, maintenance and operating regulations.

The information in this AMC is based on lessons learned by Aging Transport Systems Rulemaking Advisory Committee (ATSRAC) Harmonised Working Groups, regulatory authorities, manufacturers, airlines and repair stations. This AMC can be applied to any aeroplane training programme.

### 4 RELATED DOCUMENTS

- Regulation (EC) No 216/2008<sup>1</sup>
- Regulation (EC) No 1702/2003<sup>2</sup>
- Regulation (EC) No 2042/2003<sup>3</sup>
- EASA Certification Specification CS-25 Large Aeroplanes<sup>4</sup>
- EU-OPS Commercial Air Transportation (Aeroplanes)<sup>5</sup>

### 5 RELATED READING MATERIAL

- a. EASA AMC-20
  - [AMC 20-21](#) Programme to Enhance Aeroplane Electrical Wiring Interconnection System Maintenance
  - [AMC 20-23](#) Development of Electrical Standard Wiring Practices Documentation
- b. FAA 14 CFR Parts
  - Part 21, Certification Procedures for Products and Parts
  - Part 25, Airworthiness Standards, Transport Category Aeroplanes
  - Part 43, Maintenance, Preventive Maintenance, Rebuilding, and Alteration
  - Part 91, General Operating and Flight Rules
  - Part 119, Certification: Air Carriers and Commercial Operators
  - Part 121, Operating Requirements: Domestic, Flag, and Supplemental Operations

---

<sup>1</sup> Regulation (EC) No 216/2008 of the European Parliament and of the Council of 20 February 2008 on common rules in the field of civil aviation and establishing a European Aviation Safety Agency, and repealing Council Directive 91/670/EEC, Regulation (EC) No 1592/2002 and Directive 2004/36/EC (OJ L 79, 19.3.2008, p. 1).

<sup>2</sup> Commission Regulation (EC) No 1702/2003 of 24 September 2003 laying down implementing rules for the airworthiness and environmental certification of aircraft and related products, parts and appliances, as well as for the certification of design and production organisations (OJ L 243, 27.9.2003, p. 6). Regulation as last amended by Regulation (EC) No 287/2008 (OJ L 87, 29.3.2008, p. 3).

<sup>3</sup> Commission Regulation (EC) No 2042/2003 of 20 November 2003 on the continuing airworthiness of aircraft and aeronautical products, parts and appliances, and on the approval of organisations and personnel involved in these tasks (OJ L 315, 28.11.2003, p. 1). Regulation as last amended by Regulation (EC) No 376/2007 of (OJ L 94, 4.4.2007, p. 18).

<sup>4</sup> Executive Director Decision No 2003/2/RM of 14 October 2003 on certification specifications, including airworthiness codes and acceptable means of compliance, for large aeroplanes («CS-25»). Decision as last amended by Executive Director Decision No 2008/006/R of 29 August 2008 (CS-25 Amendment 5).

<sup>5</sup> Council Regulation (EEC) No 3922/91 of 16 December 1991 on the harmonisation of technical requirements and administrative procedures in the field of civil aviation (OJ L 373, 31.12.1991, p. 4). Regulation as last amended by Regulation (EC) No 8/2008 of 11 December 2007 (OJ L 10, 12.1.2008, p. 1).

- Part 125, Certification and Operations: Aeroplanes Having a Seating Capacity of 20 or More Passengers or a Maximum Payload Capacity of 6,000 pounds or More
  - Part 129, Operations: Foreign Air Carriers and Foreign Operators of U.S.-Registered Aircraft Engaged in Common Carriage
  - Part 135, Operating Requirements: Commuter and On-demand Operations
  - Part 145, Repair Stations
- c. FAA Advisory Circulars (AC)
- AC 20-13, Protection of Aircraft Electrical/Electronic Systems against the Indirect Effects of Lightning
  - AC 20-53A, Protection of Aeroplane Fuel Systems against Fuel Vapour Ignition due to Lightning AC 25-16, Electrical Fault and Fire Protection and Prevention
  - AC 25.981-1B, Fuel Tank Ignition Source Prevention Guidelines
  - AC 25.17YY Development of Standard Wiring Practices Documentation
  - AC 43-3, Non-destructive Testing in Aircraft
  - AC 43-4A, Corrosion Control for Aircraft
  - AC 43-7, Ultrasonic Testing for Aircraft
  - AC 43-12A, Preventive Maintenance
  - AC 43.13-1A, Acceptable Methods, Techniques and Practices - Aircraft Inspection and Repair
  - AC 43.13-1B, Acceptable Methods, Techniques and Practices for Repairs and Alterations to Aircraft
  - AC 43-204, Visual Inspection for Aircraft
  - AC 43-206, Avionics Cleaning and Corrosion Prevention/Control
  - AC 65-15A, Airframe and Powerplant Mechanics Airframe Handbook, Chapter 11. Aircraft Electrical Systems
  - AC 120-XX, Programme to enhance aircraft Electrical Wiring Interconnection System maintenance
  - AC 120-YY Aircraft Electrical Wiring Interconnection System training programme
- d. Reports
- Transport Aircraft Intrusive Inspection Project, (An Analysis of the Wire Installations of Six Decommissioned Aircraft), Final Report, The Intrusive Inspection Working Group, December 29, 2000.  
[http://www.mitreaasd.org/atrac/intrusive\\_inspection.html](http://www.mitreaasd.org/atrac/intrusive_inspection.html)
  - FAA Aging Transport Non-Structural Systems Plan, July 1998.
  - National Transportation Safety Board, Safety Recommendation, September 19, 2000, A-00-105 through -108.  
[http://www.nts.gov/recs/letters/2000/A00\\_105\\_108.pdf](http://www.nts.gov/recs/letters/2000/A00_105_108.pdf)

- Wire System Safety Interagency Working Group, National Science and Technology Council, Review of Federal Programmes for Wire System Safety 46 (2000).
  - Aging Transport Systems Rulemaking Advisory Committee, Task 1 and 2, Aging Systems, Final Report.  
[http://www.mitrecaasd.org/atrac/final\\_reports/Task\\_1&2\\_Final%20August\\_2000.pdf](http://www.mitrecaasd.org/atrac/final_reports/Task_1&2_Final%20August_2000.pdf)
  - Aging Transport Systems Rulemaking Advisory Committee, Task 3, Final Report.  
[http://www.mitrecaasd.org/atrac/final\\_reports/Task\\_3\\_Final.pdf](http://www.mitrecaasd.org/atrac/final_reports/Task_3_Final.pdf)
  - Aging Transport Systems Rulemaking Advisory Committee, Task 4, Final Report, Standard Wiring Practices.  
[http://www.mitrecaasd.org/atrac/final\\_reports/Task\\_4\\_Final\\_Report\\_Sept\\_2000.pdf](http://www.mitrecaasd.org/atrac/final_reports/Task_4_Final_Report_Sept_2000.pdf)
  - Aging Transport Systems Rulemaking Advisory Committee, Task 5, Final Report, Aircraft Wiring Systems Training Curriculum and Lesson Plans.  
[http://www.mitrecaasd.org/atrac/final\\_reports/Task\\_5\\_Final\\_March\\_2001%20.pdf](http://www.mitrecaasd.org/atrac/final_reports/Task_5_Final_March_2001%20.pdf)
  - ATA Specification 117 (Wiring Maintenance Practices/Guidelines).
  - Aging Transport Systems Rulemaking Advisory Committee, Task 6, Task 7 and Task 9 Working Group Final Reports  
[http://www.mitrecaasd.org/atrac/final\\_reports.html](http://www.mitrecaasd.org/atrac/final_reports.html)
- e. Other Documents
- ATA Operator/Manufacturer Scheduled Maintenance Development as revised, ATA Maintenance Steering Group (MSG-3), may be obtained from the Air Transport Association of America; Suite 1100: 1301 Pennsylvania Ave, NW, Washington, DC 20004-1707.
- FAA Handbook Bulletin 91-15 "Origin and propagation of inaccessible aircraft fire under in-flight airflow conditions".

## 6 DEFINITIONS

**Arc tracking:** A phenomenon in which a conductive carbon path is formed across an insulating surface. This carbon path provides a short circuit path through which current can flow. Normally, a result of electrical arcing. Also referred to as "Carbon Arc Tracking", "Wet Arc Tracking", or "Dry Arc Tracking".

**Combustible:** For the purposes of this AMC, the term combustible refers to the ability of any solid, liquid or gaseous material to cause a fire to be sustained after removal of the ignition source. The term is used in place of inflammable/flammable. It should not be interpreted as identifying material that will burn when subjected to a continuous source of heat as occurs when a fire develops.

**Contamination:** For the purposes of this AMC, wiring contamination refers to either of the following:

- The presence of a foreign material that is likely to cause degradation of wiring.
- The presence of a foreign material that is capable of sustaining combustion after removal of ignition source.

Detailed Inspection (DET): An intensive examination of a specific item, installation, or assembly to detect damage, failure or irregularity. Available lighting is normally supplemented with a direct source of good lighting at an intensity deemed appropriate. Inspection aids such as mirrors, magnifying lenses or other means may be necessary. Surface cleaning and elaborate access procedures may be required.

Electrical Wiring Interconnection System (EWIS): See CS 25.1701.

Functional Failure: Failure of an item to perform its intended function within specified limits.

General Visual Inspection (GVI): A visual examination of an interior or exterior area, installation, or assembly to detect obvious damage, failure or irregularity. This level of inspection is made from within touching distance unless otherwise specified. A mirror may be necessary to enhance visual access to all exposed surfaces in the inspection area. This level of inspection is made under normally available lighting conditions such as daylight, hangar lighting, flashlight or droplight and may require removal or opening of access panels or doors. Stands, ladders or platforms may be required to gain proximity to the area being checked.

Lightning/High Intensity Radiated Field (L/HIRF) protection: The protection of aeroplane electrical systems and structure from induced voltages or currents by means of shielded wires, raceways, bonding jumpers, connectors, composite fairings with conductive mesh, static dischargers, and the inherent conductivity of the structure; may include aeroplane specific devices, e.g., RF Gaskets.

Maintenance: As defined in Regulation (EC) 2042/2003 Article 2(h) “maintenance means inspection, overhaul, repair, preservation, and the replacement of parts, but excludes preventive maintenance.” For the purposes of this advisory material, it also includes preventive maintenance.

Maintenance Significant Item (MSI): Items identified by the manufacturer whose failure:

- could affect safety (on ground or in flight).
- is undetectable during operations.
- could have significant operational impact.
- could have significant economic impact.

Needling: The puncturing of a wire’s insulation to make contact with the core to test the continuity and presence of voltage in the wire segment.

Stand-alone General Visual Inspection (GVI): A GVI which is not performed as part of a zonal inspection. Even in cases where the interval coincides with the zonal inspection, the stand-alone GVI shall remain an independent step within the work card.

Structural Significant Item (SSI): Any detail, element or assembly that contributes significantly to carrying flight, ground, pressure, or control loads and whose failure could affect the structural integrity necessary for the safety of the aeroplane.

Swarf: A term used to describe the metal particles, generated from drilling and machining operations. Such particles may accumulate on and between wires within a wire bundle.

Zonal Inspection: A collective term comprising selected GVI and visual checks that are applied to each zone, defined by access and area, to check system and powerplant installations and structure for security and general condition.

## **7 BACKGROUND**

Over the years there have been a number of in-flight smoke and fire events where contamination sustained and caused the fire to spread. Regulators and Accident Investigators have conducted aircraft inspections and found wiring contaminated with items such as dust, dirt, metal shavings, lavatory waste water, coffee, soft drinks, and napkins. In some cases, dust has been found completely covering wire bundles and the surrounding area.

Research has also demonstrated that wiring can be harmed by collateral damage when maintenance is being performed on other aircraft systems. For example, a person performing an inspection of an electrical power centre or avionics compartment may inadvertently cause damage to wiring in an adjacent area.

Aviation Accident Investigators have specifically cited the need for improved training of personnel to ensure adequate recognition and repair of potentially unsafe wiring conditions.

This AMC addresses only the training programme. It does not attempt to deal with the condition of the fleet's wiring, or develop performance tests for wiring.

This AMC captures, in EASA guidance form, the aeroplane EWIS training programme developed by ATSRAC. This includes a training syllabus, curriculum, training target groups and a matrix outlining training for each training group.

## **8 ESSENTIAL ELEMENTS FOR A TRAINING PROGRAMME**

### **a. Initial Training.**

Initial training should be conducted for each designated work group. The initial training for each designated work group is outlined in EWIS Minimum Initial Training Programme - [Appendix A](#) and [B](#). Curriculum and Lesson Plans for each dedicated module are included in [Appendix C](#).

The most important criteria are to meet the objectives of the Lesson Plans – [Appendix C](#) (using classroom discussion, computer-based training or hands-on practical training).

Assessment or achieving the objectives should be at the discretion of the training organisation (such as written test, oral test or demonstration of skills).

Supporting documentation such as AMC is an integral part of training and should be used to support development of the Curriculum and Lesson Plans.

### **b. Refresher Training.**

Refresher training should be conducted in a period not exceeding two years. It could consist of a review of previously covered material plus any new material or revisions to publications. Refresher training will follow the EWIS Minimum Initial Training Programme - [Appendix A](#) or [B](#) for that particular target group.

[Amdt 20/4]

## Appendix A to AMC 20-22 – EWIS Minimum Initial Training Programme for Group 1 and 2

ED Decision 2008/007/R

Target Group 1: Qualified staff performing EWIS maintenance.

Target Group 2: Qualified staff performing maintenance inspections on EWIS.

TARGET GROUP	1	2
<b>A – GENERAL ELECTRICAL WIRING INTERCONNECTION SYSTEM PRACTICES</b> Know or demonstrate safe handling of aeroplane electrical systems, line replaceable units (LRU), tooling, troubleshooting procedures, and electrical measurement.		
1. Safety practices	X	X
2. Electrostatic discharge sensitive (ESDS) device handling and protection	X	X
3. Tools, special tools, and equipment	X	
4. Verifying calibration/certification of instruments, tools, and equipment	X	
5. Required wiring checks using the troubleshooting procedures and charts	X	
6. Measurement and troubleshooting using meters	X	
7. LRU replacement general practices	X	X
<b>B – WIRING PRACTICES DOCUMENTATION</b> Know or demonstrate the construction and navigation of the applicable aeroplane wiring system overhaul or practices manual.		
8. Standard wiring practices manual structure/overview	X	X
9. Chapter cross-reference index	X	X
10. Important data and tables	X	X
11. Wiring diagram manuals	X	X
12. Other documentation as applicable	X	X
<b>C – INSPECTION</b> Know the different types of inspections, human factors in inspections, zonal areas and typical damages.		
13. General visual inspection (GVI), detailed inspection (DET), special detailed inspection (SDI), and zonal inspection, and their criteria and standards	X	X
14. Human factors in inspection		X
15. Zonal areas of inspection		X
16. Wiring system damage	X	X
<b>D – HOUSEKEEPING</b> Know the contamination sources, materials, cleaning and protection procedures.		
17. Aeroplane external contamination sources	X	X
18. Aeroplane internal contamination sources	X	X
19. Other contamination sources	X	X
20. Contamination protection planning	X	
21. Protection during aeroplane maintenance and repair	X	
22. Cleaning processes	X	
<b>E – WIRE</b> Know or demonstrate the correct identification of different wire types, their inspection criteria and damage tolerance, repair and preventative maintenance procedures.		
23. Wire identification, type and construction	X	X
24. Insulation qualities and damage limits	X	X

25.	Inspection criteria and standards for wire and wire bundles		X
26.	Wire bundle installation practices	X	X
27.	Typical damage and areas found (aeroplane specific)	X	X
28.	Maintenance and repair procedures	X	X
29.	Sleeving	X	X
30.	Unused wires - termination and storage	X	X
31.	Electrical bonding and grounds	X	X
<b>F – CONNECTIVE DEVICES</b> <b>Know or demonstrate the procedures to identify, inspect, and find the correct repair for typical types of connective devices found on the applicable aeroplane.</b>			
32.	General connector types and identification	X	X
33.	Cautions and protections	X	X
34.	Visual inspection procedures	X	X
35.	Typical damage found	X	X
36.	Repair procedures	X	X
<b>G – CONNECTIVE DEVICE REPAIR</b> <b>Demonstrate the procedures for replacement of all parts of typical types of connectors found on the applicable aeroplane.</b>			
37.	Circular connectors	X	
38.	Rectangular connectors	X	
39.	Terminal blocks - modular	X	
40.	Terminal blocks - non-modular	X	
41.	Grounding modules	X	
42.	Pressure seals	X	

[Amdt 20/4]



## Appendix B to AMC 20-22 – EWIS Minimum Initial Training Programme for Group 3 through 8

ED Decision 2008/007/R

- Target Group 3: Qualified staff performing electrical/avionic engineering on in-service aeroplane.
- Target Group 4: Qualified staff performing general maintenance/inspections not involving wire maintenance (LRU change is not considered wire maintenance)
- Target Group 5: Qualified staff performing other engineering or planning work on in-service aeroplane
- Target Group 6: Other service staff with duties in proximity to electrical wiring interconnection systems
- Target Group 7: Flight Deck Crew
- Target Group 8: Cabin Crew

TARGET GROUPS	3	4	5	6	7	8
<b>A – GENERAL ELECTRICAL WIRING INTERCONNECTION SYSTEM PRACTICES</b> Know or demonstrate the safe handling of aeroplane electrical systems, line replaceable units (LRU), tooling, troubleshooting procedures, and electrical measurement.						
1. Safety practices		X		X	X	X
2. Electrostatic discharge sensitive (ESDS) device handling and protection		X				
7. LRU replacement general practices		X				
<b>B – WIRING PRACTICES DOCUMENTATION</b> Know or demonstrate the construction and navigation of the applicable aeroplane wiring system overhaul or practices manual.						
8. Standard wiring practices manual structure/overview	X					
9. Chapter cross-reference index	X					
10. Important data and tables	X					
11. Wiring diagram manuals	X					
12. Other documentation as applicable	X					
<b>C – INSPECTION</b> Know the different types of inspections, human factors in inspections, zonal areas and typical damages.						
13. General visual inspection (GVI), detailed inspection (DET), special detailed inspection (SDI), and zonal inspection, and their criteria and standards		X	X			
14. Human factors in inspection			X			
15. Zonal areas of inspection			X			
16. Wiring system damage		X	X	Low level	Low level	Low level
<b>D – HOUSEKEEPING</b> Know the contamination sources, materials, cleaning and protection procedures.						

17.	Aeroplane external contamination sources		X		X	X	X
18.	Aeroplane internal contamination sources		X		X	X	X
19.	Other contamination sources		X		X	X	X
20.	Contamination protection planning	X	X	X			
21.	Protection during aeroplane maintenance and repair	X	X	X			
22.	Cleaning processes	X	X	X	X		
<b>E – WIRE</b> <b>Know or demonstrate the correct identification of different wire types, their inspection criteria and damage tolerance, repair and preventative maintenance procedures.</b>							
23.	Wire identification, type and construction	X					
24.	Insulation qualities and damage limits	X					
25.	Inspection criteria and standards of wire and wire bundles	X					
26.	Wire bundle installation practices	X					
27.	Typical damage and areas found (aeroplane specific)	X	X	X	Low level	Low level	Low level
28.	Maintenance and repair procedures	X					
29.	Sleeving	X					
30.	Unused wires - termination and storage	X					
31.	Electrical bonding and grounds	X	X Bond	X			
<b>F – CONNECTIVE DEVICES</b> <b>Know or demonstrate the procedures to identify, inspect, and find the correct repair for typical types of connective devices found on the applicable aeroplane.</b>							
32.	General connector types and identification	X					
33.	Cautions and protections	X					
34.	Visual inspection procedures	X					
35.	Typical damage found	X					
36.	Repair procedures	X					

[Amdt 20/4]

## Appendix C to AMC 20-22 – Curriculum and Lessons Plan

*ED Decision 2008/007/R*

### Electrical Wiring Interconnection System Curriculum

#### 1 OVERVIEW

This training is targeted at each person who performs aeroplane maintenance, inspections, alterations or repairs on EWIS and/or structure. After training, the person is able to properly evaluate the EWIS and effectively use the manufacturers Chapter 20 Wiring System overhaul manual for that aeroplane. The training programme must include: wiring system condition, applicable repair schemes, wiring modifications and ancillary repairs to wiring systems and components. All of the training components are integrated to maintain wiring system quality and airworthiness of the aeroplane.

#### 2 OBJECTIVES

Depending on the modules taught, the person shows competency in the following skills:

- a. Know or demonstrate the safe handling of aeroplane electrical systems, Line Replaceable Units (LRU), tooling, troubleshooting procedures, and electrical measurement.
- b. Know or demonstrate the construction and navigation of the applicable aeroplane wiring system overhaul or wiring practices manual.
- c. Know the different types of inspections, human factors in inspections, zonal areas and typical damages.
- d. Know the contamination sources, materials, cleaning and protection procedures.
- e. Know or demonstrate the correct identification of different wire types, their inspection criteria, and damage tolerance, repair and preventative maintenance procedures.
- f. Know or demonstrate the procedures to identify, inspect and find the correct repair for typical types of connective devices found on the applicable aeroplane.
- g. Demonstrate the procedures for replacement of all parts of typical types of connective devices found on the applicable aeroplane.

#### 3 SCOPE

The course is to be used by training providers for all maintenance persons at any stage in their careers. The person can be trained to the appropriate level using the applicable modules, depending on the person's experience, work assignment and operator's policy.

#### MODULE A – GENERAL ELECTRICAL WIRING INTERCONNECTION SYSTEM PRACTICES:

- (1) Safety practices
- (2) ESDS device handling and protection
- (3) Tools, special tools and equipment
- (4) Verify calibration/certification of instruments, tools, and equipment
- (5) Required wiring checks using the Troubleshooting Procedures and charts
- (6) Measurement and troubleshooting using meters
- (7) LRU replacement general practices

#### MODULE B – WIRING PRACTICES DOCUMENTATION:

- (1) Chapter 20 structure/overview
- (2) Chapter 20 cross-reference index
- (3) Chapter 20 important data and tables
- (4) Wiring Diagram Manual
- (5) Other documentation (as applicable)

**MODULE C – INSPECTION:**

- (1) Special inspections
- (2) Criteria and standards
- (3) Human factors in inspection
- (4) Zonal areas of inspection
- (5) Wiring system damage

**MODULE D – HOUSEKEEPING:**

- (1) Aeroplane external contamination sources
- (2) Aeroplane internal contamination sources
- (3) Other contamination sources
- (4) Contamination protection planning
- (5) Protection during aeroplane maintenance and repair
- (6) Cleaning processes

**MODULE E – WIRE:**

- (1) Identification, type and construction
- (2) Insulation qualities
- (3) Inspection criteria and standards of wire and wire bundles
- (4) Wire bundle installation practices
- (5) Typical damage and areas found (aeroplane specific)
- (6) Maintenance and repair procedures
- (7) Sleeving
- (8) Unused wires - termination and storage
- (9) Electrical bonding and grounds

**MODULE F – CONNECTIVE DEVICES:**

- (1) General types and identification
- (2) Cautions and protections
- (3) Visual inspection procedures
- (4) Typical damage found
- (5) Repair procedures

**MODULE G – CONNECTIVE DEVICE REPAIR:**

- (1) Circular connectors
- (2) Rectangular connectors
- (3) Terminal blocks - modular
- (4) Terminal blocks - non-modular
- (5) Grounding modules
- (6) Pressure seals

**MODULE A: GENERAL ELECTRICAL WIRING INTERCONNECTION SYSTEM PRACTICE**

**1 OVERVIEW**

Through Module A, the instructor lays the groundwork of safe, effective maintenance and repair of the aeroplane EWIS and LRU removal and replacement, including BITE test, without damage to the aeroplane or injury to the student.

The instructor may vary the depth and scope of the topics to be covered, depending on the type of aeroplane to be maintained and skills of the persons.

**2 OBJECTIVES**

After this module is complete, the student is able to demonstrate the following skills:

- a. Know the safety procedures of normal and non-normal maintenance procedures so that the person can protect himself/herself and the aeroplane.
- b. Recognise ESDS equipment and demonstrate standard anti-static procedures so that no damage occurs to that equipment.
- c. Demonstrate the correct use of hand tools including specialised and automated tools and equipment.
- d. Verify the calibration of electrical measuring instruments, tools and equipment so that correct maintenance procedures may be carried out.
- e. Demonstrate the process and procedures to successfully use the troubleshooting procedures and charts of current aeroplane faults and know re-occurring problems causing “No Fault Found” on removed LRU.
- f. Demonstrate the correct use of electrical meters for measuring voltage, current, resistance, continuity, insulation and short to ground.
- g. Know the removal and replacement techniques so that no damage will occur to the LRU or aeroplane connector.

**3 STRATEGIES**

Normal classroom lecture can be used for the majority of the training. The following strategies can be used to expedite learning and are recommended to the instructor:

ESDS handling and protection	Multimedia/training aids
Calibration/certification of instruments, tools, and equipment	Company policy
Wiring checks using the Troubleshooting Procedures and charts	Aeroplane manuals
Measurement and troubleshooting using meters	Meters and circuits
LRU removal and replacement	Aeroplane manuals

**MODULE A – GENERAL ELECTRICAL WIRING INTERCONNECTION SYSTEM PRACTICES:**

- 1 Safety Practices
  - a. Current is lethal - First aid
  - b. Applying power to the aeroplane
  - c. Isolating the circuit
  - d. Aeroplane warnings
  - e. Human factors
- 2 ESDS Device Handling and Protection
  - a. Sources of electrostatic discharge
  - b. Soft and hard failures
  - c. ESDS safety procedures
  - d. ESDS handling/packing procedures
- 3 Tools, Special Tools and Equipment
  - a. General hand tools
  - b. Specialised tools
  - c. Automated tools and equipment
- 4 Verify Calibration/Certification of Instruments, Tools and Equipment
  - a. Tools requiring certification
  - b. Determining certification requirements
  - c. Typical problems
- 5 Required Wiring Checks Using the Troubleshooting Procedures and charts
  - a. Troubleshooting procedures manual (all chapters)
  - b. Aeroplane Maintenance Manual/Illustrated Parts Catalogue
  - c. Wiring schematics/troubleshooting graphics
  - d. Wiring diagrams
  - e. The process of troubleshooting
  - f. Testing of LRU connectors
  - g. Troubleshooting exercises
  - h. Company “No Fault Found” policy and data
- 6 Measurement and Troubleshooting Using Meters
  - a. Voltage, current and resistance
  - b. Continuity
  - c. Insulation
  - d. Short to ground

- e. Loop impedance
- 7 LRU Replacement - General Practices
- a. Different retention devices
  - b. Certification considerations (e.g. CAT 2/CAT3 Landing)
  - c. LRU re-racking procedures
  - d. “No Fault Found” data (aeroplane specific)
  - e. Built-in test equipment (BITE)

## **MODULE B: WIRING PRACTICES DOCUMENTATION**

### **1 OVERVIEW**

Through Module B, the instructor lays the groundwork for safe, effective maintenance and repair of aeroplane EWIS. The intent of this module is to teach the person how to locate desired information in the Chapter 20 Wiring System overhaul manual, Wiring Diagram Manual and other applicable documentation. The instructor may vary the depth and scope of the topics to be covered, depending on the type of aeroplane to be maintained and skills of the persons.

### **2 OBJECTIVES**

After this module is complete, the person is able to demonstrate the following skills:

- a. Know the applicable Sub-Chapters and Section to follow during normal and non-normal electrical maintenance procedures.
- b. Demonstrate the use of the Cross-Reference Index, Chapter Table of Contents, and Subject Tables of Contents so as to find specific material within each Sub-Chapter and Section.
- c. Demonstrate the use of the associated tables for replacement of wire, connective devices and contacts, and associated components, including approved replacements.
- d. Demonstrate the use of the Wiring Diagram Manual.
- e. Demonstrate the use of other documentation (as applicable).

### **3 STRATEGIES**

Normal classroom lecture can be used for the majority of the training. The Chapter 20 Wiring Practices Manual, Wiring Diagram Manual, and other applicable documentation should be made available to the class so that hands-on exploration of the material can be achieved.

## **MODULE B – WIRING PRACTICES DOCUMENTATION:**

- 1 Chapter 20 Structure/Overview
  - a. Table of contents
  - b. Sub-chapter titles
  - c. Section structure
  - d. General procedures

- 2 Chapter 20 Cross-Reference Index
  - a. Cross-reference index – Alphanumeric
  - b. Cross-reference index – Standard Part number
  - c. Cross-reference index – Suppliers
  - e. Equivalence tables – Std Part Numbers EN-ASN-NSA
- 3 Chapter 20 Important Data and Tables
  - a. Contact crimp tools, insertion/extraction tools
  - b. Wire Insulation removal tools
  - c. Electrical cable binding
  - d. Wire type codes and part numbers identification
  - e. Connective devices types and contacts
  - f. Terminal blocks and terminations
  - g. Terminal blocks modules, grounding modules and contacts
  - h. Cleaning procedures
  - i. Repair procedures
- 4 Wiring Diagram Manual (WDM)
  - a. Front matter
  - b. Diagrams
  - c. Charts
  - d. Lists
- 5 Other documentation (as applicable)

## **MODULE C: INSPECTION**

### **1 OVERVIEW**

Through Module C, the instructor lays the groundwork for safe, effective maintenance and repair of aeroplane wiring systems, by teaching the skills of inspection so as to identify wiring system damage. The instructor may vary the depth and scope of the topics to be covered, depending on the type of aeroplane to be maintained and skills of the persons.

### **2 OBJECTIVES**

After this module is complete, the person is able to demonstrate the following skills:

- a. Know the different types of inspections: General Visual Inspection (GVI), Detailed Inspection (DET), Zonal Inspection and Enhanced Zonal Analysis Procedure (EZAP).
- b. Know the criteria and standards of inspection so that the person knows which tools are used to ensure inspection procedures and standards are achieved, which leads to all defects being found.
- c. Know the effects of fatigue and complacency during inspection and how to combat these effects (Human Factors).



- d. Know the specific zonal inspection requirements related to system affiliation and environmental conditions.
- e. Recognise typical wiring system damage, such as hot gas, fluid contamination, external mechanically induced damage, chafing, corrosion, signs of overheating of wire, wire bundles, connective and control device assemblies.

### **3 STRATEGIES**

Normal classroom lecture can be used for the majority of the training. ATA 117 video and colour photos of actual wiring system damage could be used to show typical problems found on the aeroplane. Examples of discrepancies should be made available to the student. [AMC 20-21](#), Programme to Enhance Aeroplane EWIS Maintenance is recommended as a source of typical aeroplane wiring installations and areas of concern.

## **MODULE C – INSPECTION**

1. Special Inspections
  - a. General Visual Inspection (GVI)
  - b. Detailed Inspection (DET)
  - c. Zonal Inspection
  - d. Enhanced Zonal Analysis Procedure (EZAP)
2. Criteria and Standards
  - a. Tools
  - b. Criteria/standards
  - c. Procedures of inspection
3. Human Factors in Inspection
  - a. Fatigue
  - b. Complacency
4. Zonal Areas of Inspection
  - a. Zonal areas of inspection
  - b. Zonal inspection procedures and standards
5. Wiring System Damage
  - a. Swarf/FOD/metal shavings
  - b. External mechanically induced damage
  - c. Hot gas
  - d. Fluid contamination
  - e. Vibration/chafing
  - f. Corrosion
  - g. Signs of overheating

---

**MODULE D: HOUSEKEEPING****1 OVERVIEW**

Through Module D, the instructor lays the groundwork for safe, effective maintenance and repair of aeroplane EWIS, by teaching housekeeping strategies, so as to keep the EWIS free of contamination. The Instructor may vary the depth and scope of the topics to be covered, depending on the type of aeroplane to be maintained and skills of the persons.

**2 OBJECTIVES**

After this module is complete, the person is able to demonstrate the following skills:

- a. Recognise external contamination and other damage due to external environmental conditions.
- b. Know the aeroplane internal contamination sources so that inspection processes can be effectively carried out and contamination damage easily recognised.
- c. Recognise other possible contamination sources.
- d. Know the planning procedures to be followed, on EWIS areas in different parts of the aeroplane.
- e. Know the protection procedures and processes to protect the EWIS during maintenance and repair.
- f. Know the process of cleaning wiring systems during maintenance and repair.

**3 STRATEGIES**

Normal classroom lecture can be used for the majority of the training. ATA 117 video and colour photos of actual EWIS contamination could be used to show typical problems found on the aeroplane. Relevant Aeroplane Maintenance Manual and/or Chapter 20 Wiring Practices procedures should be used. The ATSRAC Task Group 1, Non-Intrusive Inspection Final Report could be used to identify typical housekeeping issues. [AMC 20-21](#), Programme to Enhance Aeroplane EWIS Maintenance is recommended as a source of typical aeroplane wiring installations and areas of concern.

**MODULE D – HOUSEKEEPING****1 Aeroplane External Contamination Sources**

- a. De-ice fluids
- b. Water and rain
- c. Snow and ice
- d. Miscellaneous (e.g. cargo/beverage spillage)
- e. Air erosion

**2 Aeroplane Internal Contamination Sources**

- a. Hydraulic oils
- b. Engine and APU oils
- c. Fuel
- d. Greases

- e. Galleys and toilets
  - f. Lint/Dust
  - g. Bleed air and hot areas
  - h. Hazardous materials
- 3 Other Contamination Sources
- a. Paint
  - b. Corrosion inhibitor
  - c. Drill shavings/Swarf
  - d. Foreign objects (screws, washers, rivets, tools, etc.)
  - e. Animal waste
- 4 Contamination Protection Planning
- a. Have a plan/types of plan/area mapping
  - b. Protection and Caution Recommendations
  - c. Procedures
  - d. Keep cleaning
- 5 Protection during Aeroplane Maintenance and Repair
- a. Recommended general maintenance protection procedures
  - b. Recommended airframe repair protection procedures
  - c. Recommended powerplant repair protection procedures
- 6 Cleaning Processes
- a. Fluid contamination
    - (1) Snow and ice
    - (2) De-ice fluid
    - (3) Cargo spillage
    - (4) Water and rain
    - (5) Galleys
    - (6) Toilets water waste
    - (7) Oils and greases
    - (8) Pressure washing
  - b. Solid contamination
    - (1) Drill shavings/Swarf
    - (2) Foreign objects (screws, washers, rivets, tools, etc.)
  - c. Environmental contamination
    - (1) Lint and dust
    - (2) Paint

- (3) Corrosion inhibitor
- (4) Animal waste

## **MODULE E: WIRE**

### **1 OVERVIEW**

Through Module E, the instructor lays the groundwork for safe, effective maintenance, alteration and repair of aeroplane EWIS by teaching wire selection and inspection strategies. The Instructor may vary the depth and scope of the topics to be covered, depending on the type of aeroplane to be maintained and skills of the persons.

### **2 OBJECTIVES**

After this module is complete, the person is able to demonstrate the following skills:

- a. Demonstrate the procedure used to identify specific wire types using the aeroplane manuals.
- b. Know from approved data different insulation types and their relative qualities.
- c. Know the inspection criteria for wire and wire bundles.
- d. Know the standard installation practices for wire and wire bundles (aeroplane specific).
- e. Know typical damage that can be found (aeroplane specific).
- f. Demonstrate the repair procedures for typical damage found on the student's type of aeroplane.
- g. Demonstrate the procedures to fitting differing types of sleeving (aeroplane specific).
- h. Know the procedures for termination and storage of unused wires.
- i. Know the correct installation practices for electrical bonds and grounds (aeroplane specific).

### **3 STRATEGIES**

Normal classroom lecture can be used for the majority of the training with hands-on practice for Section 6. Chapter 20 Wiring Practices, Wiring Diagram Manual and WDM Lists should be made available to the class to ensure hands-on use of the manual so that wire identification, inspection, installation and repair procedures can be fully explored. Examples of wire discrepancies should be made available to the student. The ATSRAC Task Group 1, Intrusive Inspection Final Report could be used to identify typical wire issues. [AMC 20-21](#), Programme to Enhance Aeroplane EWIS Maintenance is recommended as a source of typical aeroplane wiring installations and areas of concern.

## **MODULE E – WIRE**

### **1 Identification, Type and Construction**

- a. Wire type codes – alphanumeric
- b. Wire type codes – specification and standard part number
- c. Wire type codes – specified wire and alternate
- d. Manufacturer identification

- 
- 2 Insulation Qualities
    - a. Types of insulation
    - b. Typical insulation damage and limitations
    - c. Carbon arcing
  - 3 Inspection Criteria and Standards of Wire and Wire Bundles
    - a. Inspection of individual wiring
    - b. Inspection of wire bundles
  - 4 Wire Bundle Installation Practices
    - a. Routing
    - b. Segregation rules
    - c. Clearance
    - d. Clamp inspection
    - e. Clamp removal and fitting
    - f. Conduit types and fitting
    - g. Raceways
    - h. Heat shields and drip shields
  - 5 Typical Damage and Areas Found (aeroplane specific)
    - a. Vibration
    - b. Heat
    - c. Corrosion
    - d. Contamination
    - e. Personnel traffic passage
  - 6 Maintenance and Repair Procedures
    - a. Wire damage assessment and classification
    - b. Approved repairs - improper repairs
    - c. Shielded wire repair
    - d. Repair techniques
    - e. Terminals and splices
    - f. Preventative maintenance procedures
  - 7 Sleeving
    - a. Identification sleeves
    - b. Shrink sleeves
    - c. Screen braid grounding crimp sleeves
    - d. Screen braid grounding solder sleeves

- 8 Unused Wires - Termination and Storage
  - a. Termination – end caps
  - b. Storage and attachment
- 9 Electrical Bonding and Grounds
  - a. Inspection standards
  - b. Primary Bonding (HIRF protection)
  - c. Secondary Bonding (System grounding)
  - d. Lightning strikes

## **MODULE F: CONNECTIVE DEVICES**

### **1 OVERVIEW**

Through Module F, the instructor lays the groundwork for safe, effective maintenance, alteration and repair of aeroplane EWIS by teaching the identification, inspection and repair of connective devices found on the aeroplane. The instructor may vary the depth and scope of the topics to be covered, depending on the type of aeroplane to be maintained and skills of the persons.

### **2 OBJECTIVES**

After this module is complete, the person is able to demonstrate the following skills:

- a. Know the general types and positive identification of connective devices (aeroplane specific).
- b. Know the various safety procedures, cautions and warnings prior to inspection.
- c. Know the relevant visual inspection procedures for each type of connector so that any internal or external damage can be found.
- d. Recognise typical external and internal damage to the connector.
- e. Demonstrate where to find the relevant repair schemes from Chapter 20 for connector repair.

### **3 STRATEGIES**

Normal classroom lecture can be used for the majority of the training. The Chapter 20 Wiring Practices manual should be made available to the class so that hands-on use of the manual can be ensured. Connector identification, inspection and repair procedures should be fully explored. Colour photographs of typical external damage and internal damage could be used to show problems on the aeroplane. The ATSRAC Task Group 1, Non-Intrusive Inspection and Intrusive Inspection Final Report, Chapter 7, could be used to identify typical connector issues. [AMC 20-21](#), Programme to Enhance Aeroplane EWIS Maintenance is recommended as a source of typical aeroplane wiring installations and areas of concern.

## **MODULE F – CONNECTIVE DEVICES**

- 1 General Types and Identification
  - a. Part number identification

- 
- b. Reference tables
  - c. Specific connective devices chapters
  - 2 Cautions and Protections
    - a. Safety precautions
    - b. Maintenance precautions
  - 3 Visual Inspection Procedures
    - a. Installed inspection criteria
    - b. Removed inspection criteria
  - 4 Typical Damage Found
    - a. Exterior damage
    - b. Internal damage
  - 5 Repair Procedures
    - a. Finding the correct section
    - b. Finding the correct part
    - c. Finding the correct tooling
    - d. Confirming the correct repair

## **MODULE G: CONNECTIVE DEVICES REPAIR**

### **1 OVERVIEW**

Through Module G, the instructor lays the groundwork for safe, effective maintenance, alteration and repair of aeroplane EWIS. This module is primarily a hands-on class, emphasising the repair and replacement of connective devices found on the aeroplane. This list can be used to cover typical connectors for aeroplanes and can be adjusted to suit training requirements. The instructor may vary the depth and scope of the topics to be covered, depending on the type of aeroplane to be maintained and skills of the persons.

### **2 OBJECTIVE**

After this module is complete, the person will have the following skills:

- a. Demonstrate the replacement of components for circular connectors.
- b. Demonstrate the replacement of components for rectangular connectors.
- c. Demonstrate the replacement of components for terminal blocks - modular.
- d. Demonstrate the replacement of components for terminal blocks - non-modular.
- e. Demonstrate the replacement of components for grounding modules.
- f. Demonstrate the replacement of pressure seals.

### **3 STRATEGIES**

This class is primarily a hands-on class to give the student motor skills in the repair of connective devices from their aeroplane. The Chapter 20 Wiring Practices Manual and the appropriate connective devices should be made available to the class so that repair procedures can be fully

explored. Photographs of typical internal conditions and external damage could be made available. It is recommended that MODULE F: CONNECTORS should precede this module. [AMC 20-21](#), Programme to Enhance Aeroplane EWIS Maintenance is recommended as a source of typical aeroplane wiring installations and areas of concern.

## **MODULE G – CONNECTIVE DEVICES REPAIR**

- 1 Circular Connectors
  - a. Disassembly
  - b. Back-shell maintenance
  - c. Contact extraction and insertion
  - d. Contact crimping
  - e. Assembly and strain relief
- 2 Rectangular Connectors
  - a. Disassembly
  - b. Back-shell maintenance
  - c. Contact extraction and insertion
  - d. Contact Crimping
  - e. Assembly and strain relief
- 3 Terminal Blocks - Modular
  - a. Disassembly
  - b. Contact extraction and insertion
  - c. Contact Crimping
  - d. Assembly and strain relief
- 4 Terminal Block – Non-modular
  - a. Disassembly
  - b. Terminal Lug Crimping
  - c. Terminal Lug Stacking
  - d. Assembly, torque and strain relief
- 5 Grounding Modules
  - a. Disassembly
  - b. Contact extraction and insertion
  - c. Contact Crimping
  - d. Assembly and strain relief



- 
- 6 Pressure Seals
- a. Disassembly
  - b. Maintenance
  - c. Assembly and strain relief

[Amdt 20/4]

## AMC 20-23

### AMC 20-23 Development of Electrical Standard Wiring Practices documentation

*ED Decision 2008/007/R*

#### 1 PURPOSE

This AMC provides acceptable means of compliance for developing an electrical standard wiring practices document for operators, holders of and applicants for type certificates (TC), applicants for supplemental type certificates (STC) and maintenance organisations. The information in this AMC is based on recommendations submitted to the FAA from the Aging Transport Systems Rulemaking Advisory Committee (ATSRAC). JAA and latterly EASA are participating members of ATSRAC. The information in this AMC is derived from the maintenance, inspection, and alteration best practices identified through extensive research by ATSRAC working groups and Federal government working groups. This AMC provides a means, but not the only means of creating a document that meets the expectations of CS 25.1529 and Appendix H.

#### 2 OBJECTIVE

The objective of this AMC is to promote a common format for documents containing standard practices for electrical wiring, and to provide a summary of the minimum content expected to be contained within that document. Although the title of the document or manual is left to the discretion of the organisation, such a document will be referred to in this AMC as the Electrical Standard Wiring Practices Manual (ESWPM).

Titles in other organisations for such document may be Standard Wiring Practices Manual (SWPM) or Electrical Standard Practices Manual (ESPM).

#### 3 APPLICABILITY

The guidance provided in this AMC is applicable to all operators, holders of and applicants for TC, applicants for STC and maintenance organisations.

#### 4 RELATED DOCUMENTS

- Regulation (EC) No. 216/2008<sup>1</sup>
- Regulation No. 1702/2003<sup>2</sup>
- Regulation No. 2042/2003<sup>3</sup>

<sup>1</sup> Regulation (EC) No 216/2008 of the European Parliament and of the Council of 20 February 2008 on common rules in the field of civil aviation and establishing a European Aviation Safety Agency, and repealing Council Directive 91/670/EEC, Regulation (EC) No 1592/2002 and Directive 2004/36/EC (OJ L 79, 19.3.2008, p.1).

<sup>2</sup> Commission Regulation (EC) No 1702/2003 of 24 September 2003 laying down implementing rules for the airworthiness and environmental certification of aircraft and related products, parts and appliances, as well as for the certification of design and production organisations (OJ L 243, 27.9.2003, p. 6). Regulation as last amended by Regulation (EC) No 287/2008 (OJ L 87, 29.3.2008, p.3).

<sup>3</sup> Commission Regulation (EC) No 2042/2003 of 20 November 2003 on the continuing airworthiness of aircraft and aeronautical products, parts and appliances, and on the approval of organisations and personnel involved in these tasks (OJ L 315, 28.11.2003, p. 1). Regulation as last amended by Regulation (EC) No 376/2007 of (OJ L 94, 4.4.2007, p. 18).

- EASA Certification Specification CS-25 Large Aeroplanes<sup>1</sup>
- EU-OPS Commercial Air Transportation (Aeroplanes)<sup>2</sup>

## **5 RELATED READING MATERIAL**

- a. EASA AMC-20
  - [AMC 20-21](#), Programme to Enhance Aircraft Electrical Wiring Interconnection System Maintenance
  - [AMC 20-22](#), Aircraft Electrical Wiring Interconnection System Training Programme
- b. FAA 14 CFR Parts
  - Part 21, Certification Procedures for Products and Parts
  - Part 25, Airworthiness Standards, Transport Category Airplanes
  - Part 43, Maintenance, Preventive Maintenance, Rebuilding, and Alteration
  - Part 91, General Operating and Flight Rules
  - Part 119, Certification: Air Carriers and Commercial Operators
  - Part 121, Operating Requirements: Domestic, Flag, and Supplemental Operations
  - Part 125, Certification and Operations: Airplanes Having a Seating Capacity of 20 or More Passengers or a Maximum Payload Capacity of 6,000 pounds or More
  - Part 129, Operations: Foreign Air Carriers and Foreign Operators of U.S.-Registered Aircraft Engaged in Common Carriage
  - Part 135, Operating Requirements: Commuter and On-demand Operations and Rules Governing Persons on Board such Aircraft
  - Part 145, Repair Stations
- c. FAA Advisory Circulars (AC)
  - AC 25-16, Electrical Fault and Fire Protection and Prevention
  - AC 25.981-1B, Fuel Tank Ignition Source Prevention Guidelines
  - AC 43-12A, Preventive Maintenance
  - AC 43.13-1B, Acceptable Methods, Techniques and Practices for Repairs and Alterations to Aircraft
  - AC 43-204, Visual Inspection for Aircraft
  - AC 43-206, Avionics Cleaning and Corrosion Prevention/Control
  - AC 65-15A, Airframe and Powerplant Mechanics Airframe Handbook, Chapter 11. Aircraft Electrical Systems

<sup>1</sup> Executive Director Decision No 2003/2/RM of 14 October 2003 on certification specifications, including airworthiness codes and acceptable means of compliance, for large aeroplanes («CS-25»). Decision as last amended by Executive Director Decision No 2008/006/R of 29 August 2008 (CS-25 Amendment 5).

<sup>2</sup> Council Regulation (EEC) No 3922/91 of 16 December 1991 on the harmonisation of technical requirements and administrative procedures in the field of civil aviation (OJ L 373, 31.12.1991, p. 4). Regulation as last amended by Regulation (EC) No 8/2008 of 11 December 2007 (OJ L 10, 12.1.2008, p. 1).

- AC 25.17XX Certification of EWIS on Transport Category Airplanes
- d. Reports
  - Aging Transport Systems Rulemaking Advisory Committee, Task 1 and 2, Aging Systems, Final Report  
[http://www.mitrecaasd.org/atrac/final\\_reports/Task\\_1&2\\_Final%20August\\_2000.pdf](http://www.mitrecaasd.org/atrac/final_reports/Task_1&2_Final%20August_2000.pdf)
  - Aging Transport Systems Rulemaking Advisory Committee, Task 3, Final Report  
[http://www.mitrecaasd.org/atrac/final\\_reports/Task\\_3\\_Final.pdf](http://www.mitrecaasd.org/atrac/final_reports/Task_3_Final.pdf)
  - Aging Transport Systems Rulemaking Advisory Committee, Task 4, Final Report, Standard Wiring Practices  
[http://www.mitrecaasd.org/atrac/final\\_reports/Task\\_4\\_Final\\_Report\\_Sept\\_2000.pdf](http://www.mitrecaasd.org/atrac/final_reports/Task_4_Final_Report_Sept_2000.pdf)
  - Transport Aircraft Intrusive Inspection Project, (An Analysis of the Wire Installations of Six Decommissioned Aircraft), Final Report, The Intrusive Inspection Working Group, December 29, 2000  
[http://www.mitrecaasd.org/atrac/intrusive\\_inspection.html](http://www.mitrecaasd.org/atrac/intrusive_inspection.html)
  - Aging Transport Systems Rulemaking Advisory Committee Task 7, Final Report, Electrical Standard Wire Practices Manual (ESWPM)  
[http://www.mitrecaasd.org/atrac/final\\_reports/Task\\_7\\_Final\\_Report-10-31-2002.pdf](http://www.mitrecaasd.org/atrac/final_reports/Task_7_Final_Report-10-31-2002.pdf)
- e. Other Documents
  - ATA Specification 117 (Wiring Maintenance Practices/Guidelines)
  - FAA Policy Statement Number ANM-01-04: System Wiring Policy for Certification of Part 25 Airplanes, June 25, 2001

## 6 DEFINITIONS

Consumable materials: Materials consumed during the maintenance or repair of EWIS which are not an eventual component of the EWIS.

Drip loop: The practice of looping a wire or wire bundle to provide a point lower than the adjacent connector for moisture to collect.

Electrical Wiring Interconnection System (EWIS): See CS 25.1701.

Legacy document: An organisation's ESWPM existing prior to the adoption of the requirements of H25.5(a)(2) of Appendix H to CS-25.

Master Breakdown Index (MBI): An index developed to supplement a legacy document. An MBI provides a means of finding information without the need for reformatting the legacy SWPM. An example of an MBI is presented at the end of paragraph 9 of this AMC.

Separation: Defined as either spatial distance, or physical barrier, between wiring from adjacent structure, systems or wiring; or the practice of installing wiring supporting redundant or multi-channel systems.

Standard practices: Industry-wide methods for repair and maintenance of electrical wire, cable bundles and coaxial cables. Procedures and practices for the inspection, installation and removal of electrical systems components including, but not limited to: wire splices, bundle attachment methods, connectors and electrical terminal connections, bonding/grounding, etc.

## **7 STANDARDISED ESWPM FORMAT**

A representative example of the standard format and sequence of major topics included within an ESWPM is contained within [Appendix A](#) of this AMC.

## **8 MINIMUM ESWPM CONTENT**

A definition and description of ESWPM minimum content is necessary to ensure that operators and repair stations have at their disposal the information necessary to properly maintain their airplanes. Although the original airframe manufacturer's electrical installation design philosophy concerning components, installation procedures, segregation rules, etc. need not be included within the ESWPM, sufficient minimum information should be provided to enable the end-user to maintain the aircraft in a condition that conforms to the electrical installation design philosophy of the original manufacturer.

The content of any ESWPM should include, at a minimum, the following:

a. Front Matter

Provide information regarding the content and use of the ESWPM. Describe changes to the document in a record of revisions. Ensure the document contains a table of contents or index to allow the user to readily retrieve necessary information.

b. Safety Practices

Provide general instruction, cautions and warnings which describe safe practices implemented prior to the start of any or all of the specific standard electrical practices contained within the core of the ESWPM. Safety cautions, warnings or notes specific to the procedure shall be placed within the body of the procedure.

c. Cleaning Requirements and Methods

"Protect, clean as you go" philosophy.

Non-destructive methods for cleaning dust, dirt, foreign object debris (FOD), lavatory fluid, and other contaminants produced by an aircraft environment from wiring systems.

Wire replacement guidelines when an accumulation of contaminants, either on the surface and/or imbedded in the wire bundle, cannot be safely removed.

d. Wire and Cable Identification

(1) Specify requirements for wire and cable identification and marking to provide safety of operation, safety to maintenance personnel, and ease of maintenance.

(2) Specify methods of direct wire marking. Also, identify specific requirements and cautions associated with certain types of wire marking.

e. Wire and Cable Damage Limits

Specify limits to positively identify the thresholds where damaged wire/cable replacement may be necessary and where repairs can be safely accomplished. Establish limits for each applicable wire/cable type, if necessary.

(1) Include damage limits for terminals, studs, connectors, and other wiring system components, as necessary.

f. Installation Clamping and Routing Requirements

(1) Specify the requirements for the installation of wiring systems with respect to physical attachment to the aircraft structure. These requirements must be

compatible with the different environments applicable to aircraft and aircraft systems.

- (2) Specify applicable methods of clamping, support, termination, and routing to facilitate installation, repair, and maintenance of wires, wire bundles, and cabling.
- (3) Specify minimum bend radii for different types of wire and cable.
- (4) Specify minimum clearance between wiring and other aircraft systems and aircraft structure.
- (5) Include the requirements for the installation of wiring conduit with respect to physical attachment, routing, bend radii, drain holes, and conduit end coverings.
- (6) Emphasise special wiring protective features, such as spatial separation, segregation, heat shielding, and moisture protection that are required to be maintained throughout the life of the aircraft.
- (7) Ensure necessary information for the maintenance of bonding, grounding and lightning, high-intensity radio frequency (L/HIRF) provisions is included.
- (8) Include information on the use and maintenance of wire protective devices, conduits, shields, sleeving etc. (this bullet is deleted in the FAA AC).

g. Repair and Replacement Procedures

Describe methods to safely repair and/or replace wiring and wiring system components.

- (1) Include types and maximum numbers of splice repairs for wiring and any limitations on the use of splices. When splicing wire, environmental splices are highly recommended over non-environmental splices. Guidance should be provided on how long a temporary splice may be left in the wire.
- (2) Specify procedures for the repair, replacement, and maintenance of connectors, terminals, modular terminal blocks, and other wiring components.

h. Inspection Methods

In wiring inspection methods, include a general visual inspection (GVI), or a detailed inspection (DET), as determined by the Enhanced Zonal Analysis Procedure (EZAP). Typical damage includes heat damage, chafing, cracked insulation, arcing, insulation delaminating, corrosion, broken wire or terminal, loose terminals, incorrect bend radii, contamination, and deteriorated repairs.

- (1) Identify detailed inspections and, where applicable, established and emerging new technologies non-destructive test methods to complement the visual inspection process.

Whenever possible, ensure that inspection methods can detect wiring problems without compromising the integrity of the installation.

i. Customised data

Provide a location and procedures that allow users to include customised or unique data such as that relating to STC, operator-unique maintenance procedures, etc.

A comprehensive listing of the typical content included within an ESWPM, including the minimum required content described above, is contained within [Appendix A](#) of this AMC.

## 9 ALTERNATIVE PROCEDURE FOR LEGACY DOCUMENTS

The definition of a new layout and chapter format may require each organisation with an existing ESWPM to reformat and to republish using the standardised format. Whether the organisation produces a stand-alone manual or provides the electrical standard practices as Chapter 20 of a wiring diagram manual, the resultant reorganisation would cause a significant economical impact for both the authoring organisation and their end-users.

To address this concern, a conversion tool, identified in the last paragraph of this chapter, was devised which takes the following variables into account:

- Effects on manufacturers’ current technical document editorial policy as it exists in current legacy documents.
- Costs resulting from an immediate major manual overhaul.
- Inconvenience to end-users who are accustomed to the format they are currently using.

When using a traditional paper format ESWPM, the most efficient method of retrieving standard procedures and maintenance information has traditionally been to search in:

- the table of contents (TOC) and/or
- the indexes (i.e., alphanumerical index and/or numerical index, as available).

The ease and speed with which information may be found with these methods relies heavily on the quality of the TOC and/or the indexes. For aircraft maintenance technicians needing to locate and extract the pertinent and applicable data necessary to perform a satisfactory design modification or maintenance action, finding relevant data may be time-consuming.

When using an electronic format, a search engine can often be used. This allows the user to bypass the TOC or indexes in finding the needed procedure or data. By searching with such alternative methods, a user can find information without needing to know the rules, such as ATA references, governing assignment of the subject matter to its place in the TOC.

The use of a conversion tool, identified as a Master Breakdown Index (MBI) is one method of achieving a common format until existing legacy documents can be physically altered or digitised to an electronic format. The intent of the MBI is to supplement the TOC and existing indexes by providing to users a method of searching existing documents using topical information rather than by part number, alphabetic subject, or Chapter-Section-Subject reference. The arrangement of the MBI duplicates the standardised format described in Paragraph 7 of this AMC, but does not require complete rearrangement of legacy documents to achieve a common format. The MBI acts as a conversion key used to effectively convert an existing document arrangement into the proposed arrangement. In essence the MBI duplicates in paper form for legacy documents the electronic search engine for HTML-based documents.

This is an example of an MBI which could be used to mitigate the need for legacy documents to be reformatted to achieve the standardised format described above:

GROUP	MAJOR TOPIC	APPEARS IN THIS DOCUMENT AS SUBJECT
GENERAL DATA	SAFETY PRACTICES	20-10-10
	AIRPLANE ENVIRONMENTAL AREAS	20-20-12
	CONSUMABLE MATERIALS	20-00-11
	WIRING MATERIALS	20-10-13
	COMMON TOOLS	20-00-13

ELECTRICAL WIRING INTERCONNECT SYSTEM (EWIS) MAINTENANCE	EWIS PROTECTION DURING MAINTENANCE	20-10-20
	EWIS CLEANING	20-10-20
	EWIS INSPECTION	20-10-20
	EWIS TESTING	20-10-13
	EWIS DISASSEMBLY	20-10-19
	EWIS REPAIR AND REPLACEMENT	20-20-00
WIRING INSTALLATION	WIRE SEPARATION / SEGREGATION	20-10-11 20-10-12
	ELECTRICAL BONDS AND GROUNDS	20-30-60
	WIRE HARNESS INSTALLATION	20-10-17 20-10-18 Installation of Sleeves on Wiring
WIRING ASSEMBLY	WIRE AND CABLE TYPES	20-00-15
	WIRE MARKING	20-60-01
	WIRE HARNESS ASSEMBLY	20-50-01
	WIRE INSULATION AND CABLE JACKET REMOVAL	20-90-12
	TERMINATION TYPE (SPECIFICS OF TERMINATIONS)	20-61-44
ELECTRICAL DEVICES	DEVICE TYPE (SPECIFICS OF ELECTRICAL DEVICE)	20-80-09 Assembly of Leach Relay Sockets
SPECIFIC SYSTEM WIRING	UNIQUE WIRING ASSEMBLIES/INSTALLATIONS	20-73-00 Fuel Quantity Indicating System
AIRLINE CUSTOMISED DATA	AIRLINE SPECIFIED	20-91-00

[Amdt 20/4]



## Appendix A: Groups, Major Topics, Standardised Sequence and Description of Minimum Content

ED Decision 2008/007/R

GROUP	MAJOR TOPIC	DESCRIPTION
GENERAL DATA	SAFETY PRACTICES	Safety regulations and general safety precautions to prevent injury to personnel and damage to the airplane
	AIRPLANE ENVIRONMENTAL AREAS	Definition of types of areas upon which wiring configuration and wiring component selection is constrained
	CONSUMABLE MATERIALS	Wiring maintenance processing materials (solvents, aqueous cleaners, lubricants, etc.)
	WIRING MATERIALS	Materials that become an integral part of the wiring configuration excluding wire and cable, e.g., sleeves, shield material, tie material, sealants, etc.
	COMMON TOOLS	Description and operation of common tools
EWIS MAINTENANCE	EWIS PROTECTION DURING MAINTENANCE	Procedures to protect EWIS during airplane maintenance and modification
	EWIS CLEANING	In support of inspection as well as prevention of degradation and preparation for repair; recommended cleaning materials and procedures based on type of contamination
	EWIS INSPECTION	Criteria for correct installation, correct wiring assembly configuration; damage conditions and limits for wiring components (wire and cable, termination types, electrical devices); factors that warrant disassembly for inspection; determination of cause of damage
	EWIS TESTING	Wiring integrity testing
	EWIS DISASSEMBLY	Data and procedures in support of inspection, cleaning when applicable; also supports new wiring installation
	EWIS REPAIR AND REPLACEMENT	Repair of wiring installation, wiring assembly configuration, wiring components (wire and cable, wiring terminations, electrical devices); wire and cable replacement; wiring functional identification
WIRING INSTALLATION	WIRE SEPARATION/ SEGREGATION	Explanation of separation/segregation categories, separation/segregation identification, and necessary conditions for maintaining separation/segregation
	ELECTRICAL BONDS AND GROUNDS	Bond surface preparation, ground hardware configurations, bond integrity testing
	WIRE HARNESS INSTALLATION	Routing, supports; wiring protection, factors affecting wiring assembly configuration; connection to equipment, new wiring, removal from service
WIRING ASSEMBLY	WIRE AND CABLE TYPES	The principal material component of airplane wiring; includes type identification and basic description; alternative wire types (replacements, substitutions)
	WIRE MARKING	Marking; applicable conditions
	WIRE HARNESS ASSEMBLY	Wiring assembly configuration: Assembly materials, layout, overall protection; factors affecting wiring installation

GROUP	MAJOR TOPIC	DESCRIPTION
	WIRE INSULATION AND CABLE JACKET REMOVAL	Wire and cable: Insulation removal, jacket removal; associated damage limits, tool description and operation
	<<TERMINATION TYPE>> e.g., SOURIAU 8950 SERIES CONNECTORS	Wiring terminations and accessories (connectors, terminal lugs, splices, backshells, etc.) grouped by termination type from simple to complex: <ul style="list-style-type: none"> <li>a. Common data or procedures by group (if any), e.g., tool description and operation, definition of internal damage and limits, internal cleaning, accessories</li> <li>b. By individual type - part numbers and description, definition of internal damage and limits (if not specified by common data), disassembly, assembly, installation</li> </ul>
ELECTRICAL DEVICES	<<DEVICE TYPE>> e.g., KLIXON 7274 SERIES CIRCUIT BREAKER	Electrical devices (circuit breakers, relays, switches, filters, lamps, etc.) grouped by device type: <ul style="list-style-type: none"> <li>a. Common data or procedures by group (if any), e.g., tool description and operation, definition of internal damage and limits, internal cleaning, accessories</li> <li>b. By individual type - part numbers and description, definition of internal damage and limits (if not specified by common data), disassembly, assembly, installation</li> </ul>
SPECIFIC SYSTEM WIRING	SPECIFIC WIRING ASSEMBLY	For wiring that has a necessarily specific configuration (e.g. Primary Flight Control, Fuel Quantity Indicator System, etc.): <ul style="list-style-type: none"> <li>– Applicable conditions for repair and replacement</li> <li>– Disassembly, assembly, installation, assembly integrity testing</li> </ul>
AIRLINE CUSTOMISED DATA	AIRLINE SPECIFIED	Reserved for airline use

[Amdt 20/4]

## AMC 20-24

### AMC 20-24 Certification Considerations for the Enhanced ATS in Non-Radar Areas using ADS-B Surveillance (ADS-B-NRA) Application via 1090 MHz Extended Squitter.

*ED Decision 2008/004/R*

#### 1 PREAMBLE

- 1.1 The scope of this Acceptable Means of Compliance (AMC) is the airworthiness and operational approval of the “Enhanced Air Traffic Services in Non-Radar Areas using ADS-B Surveillance” (ADS-B-NRA) application.
- 1.2 Operational benefits of the ADS-B-NRA application include the enhancement of the Air Traffic Control Service in current non-radar airspace. ADS-B-NRA would provide controllers with improved situational awareness of aircraft positions, and in consequence appropriate separation minima could be applied depending on the environment and the approval of the competent authority. Current non-radar airspace is controlled using procedural methods which demand large separations. ADS-B-NRA separation minima would be smaller than that used in current non-radar airspace. Alerting Services in non-radar airspace will be enhanced by more accurate information on the latest position of aircraft.  
  
Hence, it is expected that in areas where radar coverage is not feasible or not economically justified this application will provide benefits to capacity, efficiency and safety in a way similar to what would be achieved by use of SSR radar.
- 1.3 The European CASCADE programme is the mechanism for co-ordination of the European implementation of ADS-B (ADS-B-NRA and other ADS-B based ground and airborne surveillance applications). One of the programme’s aims is to ensure harmonisation and efficiency of implementation.
- 1.4 CASCADE uses the globally interoperable 1090 MHz Extended Squitter (ES) data link technology, compliant with ICAO SARPS in Annex 10 and in line with the recommendations of the Conference ICAO ANC-11.
- 1.5 In parallel, the FAA Airservices Australia and Nav Canada plan to deploy ADS-B using the same data link technology. It is assumed that aircraft will be interoperable with all implementation programmes using the EUROCAE/RTCA ADS-B-NRA standard (ED126, DO-303).
- 1.6 The meaning of abbreviations may be found in [Appendix 1](#).

#### 2 PURPOSE

- 2.1 This AMC is for operators seeking to operate in airspace classifications A to E where ADS-B-NRA services have been implemented by the Air Navigation Service Provider. It provides the basis for approval of aircraft systems and identifies operational considerations.

It may also assist other stakeholders by alerting them to aircraft requirements, operator procedures and related assumptions. These other stakeholders could include airspace planners, air traffic service providers, ATS system manufacturers, surveillance data

processing system manufacturers, communication service providers, aircraft and avionics equipment manufacturers and ATS regulatory authorities.

- 2.2 Acceptable Means of Compliance (AMC) illustrate a means, but not the only means, by which a requirement contained in an EASA airworthiness code or an implementing rule of the Basic Regulation, can be met.

An applicant correctly implementing this AMC in its entirety is assured of acceptance of compliance with the airworthiness considerations prior to use of the automatic dependent surveillance broadcast equipment. The operational considerations in this AMC are consistent with the operational considerations in the position paper 039 revision 8, that is endorsed by the JAA Operations Sectorial Team (OST). An Operator that, in conjunction with the airworthiness considerations, has correctly implemented this AMC should be ensured of acceptance of compliance with the operations rules applicable in JAA Member States.

### **3 SCOPE**

- 3.1 This AMC is applicable to the various ATS services contained in the ADS-B-NRA application, including separation services. This AMC fulfils the ADS-B-NRA Safety, Performance Requirements and Interoperability Requirements as established in EUROCAE ED-126<sup>1</sup>, using the methodology described in EUROCAE document ED-78A<sup>2</sup>.

AMC requirements are driven by the ED-126 requirements for a 5NM separation service (applicable to both en-route and TMA airspace).

Note: the actual choice of ADS-B-NRA ATC service provision, including of the applicable separation minima, is at the discretion of the implementing Air Traffic Service Provider, and should be based on local safety cases.

- 3.2 The AMC addresses the 1090 MHz Extended Squitter (ES) data link technology as the ADS-B transmit technology.<sup>3</sup>

### **4 REFERENCE DOCUMENTS**

#### **4.1 Related Regulatory Requirements**

- CS/FAR 25.1301, 25.1307, 25.1309, 25.1322, 25.1431, 25.1581, or equivalent requirements of CS 23, 27 and 29, if applicable.
- EU-OPS 1.230, 1.420, 1.845, 1.865, 1040, 1.1045 and 1.1060, as amended, or, if applicable, equivalent requirements of JAR-OPS 3.
- National operating regulations.

#### **4.2 Related EASA/JAA TGL/NPA/AMC (and FAA TSO) Material**

- ETSO-2C112b: Minimum Operational Performance Specification for SSR Mode S Transponders (adopts ED-73B)
- ETSO-129A (TSO-129/TSO-129A): Airborne Supplemental Navigation Equipment Using the Global Positioning System (GPS)

<sup>1</sup> ED-126: "Safety, Performance and Interoperability Requirements Document for ADS-B-NRA" Application

<sup>2</sup> ED-78A: Guidelines for approval of the provision and use of Air Traffic Services supported by Data communications

<sup>3</sup> Other, requirements compliant, ADS-B transmit systems (e.g. VDL Mode 4) are expected to be covered through separate regulatory material, as appropriate.

- ETSO-145/ETSO-146 (TSO-145/TSO-146; TSO-145A/TSO-146A): Airborne Navigation Sensors Using the Global Positioning System (GPS) Augmented by the Wide Area Augmentation System (WAAS)
  - AMC 20-13 Certification of Mode S Transponder Systems for Enhanced Surveillance
  - JAA Temporary Guidance leaflet (TGL) 13, Revision 1: Certification of Mode S Transponder Systems for Elementary Surveillance
- 4.3 Related FAA Advisory Circular Material
- FAA AC20-138A: Airworthiness Approval of Global Navigation Satellite System (GNSS) Equipment
- 4.4 Related EUROCAE/RTCA Standards
- ED-126 (DO-303): Safety, Performance and Interoperability Requirements Document for ADS-B-NRA Application (December 2006)
  - ED78A (DO-264): Guidelines for Approval of the Provision and Use of Air Traffic Services Supported by data communications;
  - ED-102 (DO-260): MOPS for 1090MHz for ADS-B
  - DO-260A: MOPS for 1090MHz for ADS-B
  - ED-73B (DO-181C): Minimum Operational Performance Specification for Secondary Surveillance Radar Mode S Transponders
  - ED-26: MPS for airborne altitude measurements and coding systems
- 4.5 Related ICAO Standards and Manuals
- PANS-ATM, Doc 4444, Amendment 4: Procedures for Air Navigation Services – Air Traffic Management
  - Annex 10 (Volume III & IV): Aeronautical Telecommunications

## 5 ASSUMPTIONS

Applicants should note that this AMC is based on the following assumptions.

### 5.1 Air Traffic Service Provider (ATSP)

ATSP implements the ADS-B-NRA application compliant with relevant requirements of the safety, performance and interoperability requirements of EUROCAE standard ED-126. Deviations from, or supplements to the established standards are assessed by the ATSP. Deviations that potentially impact the airborne domain should be assessed in coordination with relevant stakeholders as per ED78A.

Section 8 of this document, “Airworthiness Considerations”, lists permissible deviations from the target requirements related to the use of existing aircraft installations in support of initial implementations<sup>1</sup>. These deviations are currently considered operationally acceptable under the assumption that ground mitigation means as discussed in the following subsections, are implemented, at the discretion of the ATSP.

#### 5.1.1 Consistency of position quality indicators with associated position information at time of transmission

<sup>1</sup> Refer to sections 8.3.3, 8.3.5 and 8.8.2.

In cases where position quality indicators are not consistent with actual position quality (e.g., due to uncompensated latency in position transmissions), the implementing ATSP might:

- treat the higher quality indicator encodings as an advised lower one (e.g. NUC=7 may be treated as NUC=5) or,
- consider, for separation purpose, a quality indicator more stringent than the one stated in ED-126 (e.g. NUC =5 rather than NUC=4).

#### 5.1.2 Encoding of NUC Quality Indicator (DO-260 compliant transponders)

In order to mitigate the encoding of the NUC quality indicator based on accuracy quality information (HFOM) in the case of the unavailability of the GPS RAIM function (i.e. unavailability of HPL information), the implementing ATSP may, for instance, rely on the analysis of the frequency and duration of the unavailability of the RAIM function (as part of the local safety assessment).

#### 5.1.3 Transmission of generic emergency indicator only

In order to mitigate the transmission of only the generic emergency indicator (and not also the discrete codes selected by the flight crew), It is assumed that appropriate operational procedures have been established by the implementing ATSP and that pilots and controllers have been trained in their use.

#### 5.1.4 Communications Service Provider (CSP)

In case of CSPs providing (part of) the ground surveillance data communication services (operation of ADS-B ground stations and/or surveillance data networks), the CSP is committed to provide communication services to ATSPs with the expected Quality of Service as defined in a specific Service Level Agreement.

The Service Level Agreement is bilaterally agreed between the CSP and an ATSP. The terms of reference of the Service Level Agreement are consistent with the performance requirements of the ED-126 document.

### 5.2 Aeronautical Information Service

Each State publishes in its AIP/NOTAM, or equivalent notification, information related to the surveillance provisions, schedule, relevant procedures and confirmation of compliance with ED-126.

## 6 SYSTEM DESCRIPTION

The basic concept of ADS-B involves the broadcasting of surveillance information from aircraft via a data link.

To support the ADS-B-NRA application, the overall ADS-B avionics system (in the following referred to as “ADS-B System”) would need to provide the following functions:

- Adequate surveillance data provision capability;
- ADS-B message processing (encoding and generation);
- ADS-B message transmission (1090 MHz ES airborne surveillance data-link);

Whereas the latter two functions are incorporated in the 1090 MHz ES ADS-B transmit system, the surveillance data provision is realised through various on-board surveillance data sources (e.g. horizontal position source, barometric altimetry, ATC transponder control panel).

The horizontal position accuracy and integrity requirements of the ADS-B-NRA application are associated with quality indicators which form part of the air-to-ground ADS-B message exchange. The interconnecting avionics architecture is part of the ADS-B System.

## 7 FUNCTIONAL CRITERIA

Note: ICAO and EUROCAE/RTCA interoperability references, including aspects of range and resolution of the various data items listed hereafter, for both ED-102/DO-260 and DO-260A equipment-based ADS-B transmit systems, are presented in [Appendix 4](#).

7.1 In line with ED-126 (section 4), the ADS-B System needs to meet the following surveillance data transmission requirements, as a minimum:

- A unique ICAO 24 bit aircraft address (contained within each ADS-B message transmission);
- Horizontal Position (latitude and longitude);
- Horizontal Position Quality Indicator(s) (position integrity for both ED-102/DO-260 and DO-260A based ADS-B transmit systems, as well as accuracy for DO-260A based ADS-B transmit systems);
- Barometric Altitude;
- Aircraft Identification;
- Special Position Identification (SPI);
- Emergency Status and Emergency Indicator;
- Version Number (in aircraft operational status message, if avionics are DO-260A compliant).

7.2 In line with ED-126 (section 4), it is recommended that the ADS-B System meets the following optional surveillance data transmission requirement:

- Ground Velocity.

## 8 AIRWORTHINESS CONSIDERATIONS

### 8.1 Airworthiness Certification Objectives

For the purposes of the ADS-B-NRA application, the ADS-B System installed in the aircraft needs to be designed to deliver data that satisfy the airborne domain requirements in line with ED-126 Section 3.4, ([Appendix 3](#) provides a summary for information purposes).

### 8.2 ADS-B System

8.2.1 The (overall) ADS-B System integrity level with respect to the processing of horizontal position data and horizontal position quality indicators, covering the processing (and data exchange) chain from horizontal position data source(s) to ADS-B transmit data string encoding) needs to be 10-5/fh (refer also to Table 1 in [Appendix 3](#)).

*Note 1: this integrity level is required to adequately protect against the corruption of horizontal position data and horizontal position quality indicators when applying separation.*

*Note 2: These performance figures have been set for the “ADS-B out” function, to be used in ADS-B NRA operations as laid down by the Operational Safety Assessment in Annex C of ED 126.*

*Note 3: Compliance with these performance figures do not constitute per se a demonstration that the safety objectives of ADS-B NRA operations allocated to avionics are achieved.*

*Note 4: Also refer to § 3.1.*

- 8.2.2 The (overall) ADS-B System continuity level needs to be  $2 \cdot 10^{-4}/\text{fh}$  (refer also to Table 1 in [Appendix 3](#)).

*Note 1: These performance figures have been set for the “ADS-B out” function, to be used in ADS-B NRA operations as laid down by the Operational Safety Assessment in Annex C of ED 126;*

*Note 2: Compliance with these performance figures do not constitute per se a demonstration that the safety objectives of ADS-B NRA operations allocated to avionics are achieved;*

*Note 3: Also refer to § 3.1.*

- 8.2.3 The latency of the horizontal position data, including any uncompensated latency, introduced by the (overall) ADS-B System does not exceed 1.5 second in 95% and 3 seconds in 99.9% of all ADS-B message transmission cases (refer also to Table 1 in [Appendix 3](#)).

### 8.3 ADS-B Transmit System

- 8.3.1 Compliance with the air-ground interoperability requirements, as specified in ED-126 and presented in Section 7.1 and [Appendix 4](#), needs to be demonstrated.

- 8.3.2. For 1090 MHz Extended Squitter ADS-B transmit systems, this should be demonstrated by the relevant tests documented in:

- ED-73B/ETSO-2C112b (or DO-181C);
- ED-102, as a minimum, or an equivalent standard which is acceptable to the Agency (e.g. DO-260 or DO-260A).

- 8.3.3 ADS-B transmit systems need to transmit horizontal position quality indicators consistent with the associated position information at the time of transmission.

For the expression of the position accuracy quality, the related indicator should therefore reflect:

- The quality (in terms of both integrity and accuracy) of the position measurement itself; and
- Any (uncompensated) latency incurring prior to transmission.

Note: guidance on the quality indicators is provided in [Appendix 4](#).

The applicant needs to demonstrate the correctness of consistent quality indicator encodings in line with (minimum) position source quality and any (uncompensated) maximum latency as expressed in 8.2.3.

#### Permissible deviation for initial implementations:

For initial implementations, some aircraft installations may not take into account any (uncompensated) latency in the encoding of the position accuracy quality indicator as applicable at the time of transmission. Hence, such installations might transmit horizontal position quality indicators that are consistent with the



associated position information only for lower quality indicator encodings<sup>1</sup> (e.g. NUC=5 or NAC=5) but not higher ones (e.g. NUC=7 or NAC=7). Such deviation from the above target requirement need to be listed in the Aircraft Flight Manual (refer to Section 9.3).

- 8.3.4 The value of the horizontal position quality indicators need to be based on the integrity information for the encoding of the ED-102/DO-260 related NUC and the DO-260A related NIC quality indicator, as related to the horizontal position sources.

In addition, the encoding of the DO-260A NAC quality indicator needs to be based on the accuracy information of the horizontal position sources.

- 8.3.5 In case of ED-102/DO-260 based ADS-B transmit systems, the NUC Quality Indicator value need to be encoded based on the integrity containment radius<sup>2</sup> only.

Permissible deviation for initial implementations:

For initial implementations, some GNSS position source based aircraft installations may encode the NUC Quality Indicator on accuracy quality information (HFOM) under rare satellite constellation circumstances leading to the temporary unavailability of the integrity monitoring (RAIM) function (i.e. unavailability of integrity containment radius calculation). Such deviation from the above target requirement need to be listed in the Aircraft Flight Manual (refer to Section 9.3).

- 8.3.6 If the ADS-B transmit system does not have a means to determine an appropriate integrity containment radius and a valid position is reported, then the Quality Indicator (i.e. NUC or NIC) need to be encoded to indicate that the integrity containment radius is unknown (i.e. NUC/NIC should be set to 'zero').
- 8.3.7 Transmitter antenna installation needs to comply with guidance for installation of ATC transponders to ensure satisfactory functioning. (Also refer to ED-73B)
- 8.3.8 If more than one ADS-B transmit system is installed, simultaneous operation of both transmit systems needs to be prevented.

#### 8.4 Horizontal Position Data Sources

- 8.4.1 The requirements on horizontal position data sources are based on the ED-126 safety and performance assessments.
- 8.4.2 Components of horizontal position data sources external to the aircraft ADS-B system (such as the GNSS space segment) fall outside these airworthiness considerations. Such external components are assumed to operate in accordance with their specified nominal performance<sup>3</sup>.

Nevertheless, failures of the external data source components are required to be detected through on-board monitoring (as expressed in section 8.4.3).

<sup>1</sup> This is a consequence of the definition of the quality indicator encoding describing an interval of values between a lower and an upper bound (refer also to Appendix 4.2). For instance, a NUC=5 encoding expresses an upper bound of position accuracy quality indication of 0.3NM whilst a NUC=7 encoding expresses an upper bound of 0.05NM. Therefore, in case of e.g. the actual GNSS position source performance, a NUC=5 encoding provides sufficient margin to also correctly express the effects of on-board uncompensated latency whilst this is not the case for a NUC=7 encoding any more.

<sup>2</sup> I.e. GNSS conformant HPL/HIL information.

<sup>3</sup> For GNSS based systems, this includes satellite constellation aspects.

8.4.3 Any eligible horizontal position data source needs to meet the following minimum requirements (refer also to Table 2 in [Appendix 3](#)):

- Correct encoding of quality indicator information in line with the actual performance of the selected horizontal position data source(s), i.e. in relation to position integrity containment bound (ED-102/DO-260 and DO-260A ADS-B transmit systems) and position accuracy (DO-260A ADS-B transmit systems);
- Position source failure probability:  $10^{-4}$  per hour<sup>1</sup>;
- Position integrity alert failure probability, commensurate with the performance characteristics of GNSS integrity monitoring<sup>2</sup>:  $10^{-3}$  (per position source failure event);
- Position integrity time to alert: 10 seconds.

8.4.4 If available and valid, integrity containment radius information should be provided to the ADS-B transmit system from the position data source, or equivalent, on the same interface as and together with each positional data.

8.4.5 If the integrity containment radius is not provided by the horizontal position data source, the ADS-B transmit system may use other means to establish an appropriate integrity containment radius<sup>3</sup>, provided a requirements compliant integrity alert mechanism is available.

8.4.6 Use of GNSS Systems as Primary Position Data Source

8.4.6.1 GNSS is considered as primary horizontal position data source for the provision of an acceptable accuracy and integrity performance in support of the ATC separation services contained within the ADS-B-NRA application.

The ED-126 safety and performance assessments are based on the specified performance and characteristics of GNSS systems, including receiver autonomous integrity monitoring. Therefore, for GNSS systems as specified in section 8.4.6.2, a safety and performance demonstration is not required.

8.4.6.2 If GNSS is used as a positional source, the GNSS system should be either compatible with:

- ETSO C-129A, TSO C-129 or TSO C-129A; or
- ETSO C-145/C-146 or TSO C-145A/C-146A,

capable of delivering position data with a periodic interval of at least  $1.2 \text{ s}^4$ .

8.4.6.3 For GNSS systems compatible with (E)TSO C-129 (any revision), it is highly desired that the system incorporates Fault Detection and Exclusion

<sup>1</sup> For GNSS based position sources, the failure occurs outside the aircraft system and is therefore expressed as per ATSU-hour. Proof of compliance of alternative solely aircraft based sources should take this into account and might have to express the requirement as  $10^5$  per flight hour (i.e. for the en-route environment).

<sup>2</sup> As realised through receiver autonomous integrity monitoring (RAIM), including its characteristics of increasingly less likely to fail for position errors beyond the horizontal protection limit. Within ED-126, the position source failure is modelled as a bias error that equals the integrity containment radius.

<sup>3</sup> E.g. HPL/HIL based upon known RAIM protection threshold.

<sup>4</sup> ETSO C-145/C146 provides additional capabilities compared with ETSO C129A such as: processing of GPS without Selective Availability, processing of SBAS signals when available and Fault Detection Exclusion as a basic function. Therefore ETSO C145/146 usually provides higher quality integrity values than ETSO C-129A equipment.

capability as defined in AC 20-138A, Appendix 1, “GPS as a Primary Means of Navigation for Oceanic/Remote Operations”.

#### 8.4.7 Use of Alternative Compliant Position Data Sources

As the ED-126 safety and performance assessments are based on the performance and characteristics of GNSS systems, for alternative position sources a dedicated safety and performance assessment is required to demonstrate compliance with the ED-126 requirements.

#### 8.4.8 Use of Temporary Back-up Position Data Sources

Back-up position data sources not complying with the requirements referred to in section 8.4.3 may prove very useful in enhancing the continuity of ADS-B surveillance provision during temporary outages of the primary (or equivalent alternative) position data sources.

Any such back-up position data source needs to report its accuracy and integrity performance to the ADS-B transmit system, in a format compliant with ED-102/DO-260 or DO-260A, as appropriate.

### 8.5 Barometric Altitude Data Sources

8.5.1 Pressure altitude provided to the ADS-B transmit system needs to be in accordance with existing requirements for ATC transponders.

8.5.2 The digitizer code selected needs to correspond to within plus or minus 38.1 m (125 ft), on a 95% probability basis, with the pressure-altitude information (referenced to the standard pressure setting of 1013.25 hectopascals), used on board the aircraft to adhere to the assigned flight profile. (ICAO Annex 10, Vol IV, 3.1.1.7.12.2.4. See also EUROCAE ED-26).

The performance of the encoders and of the sensors needs to be independent from the pressure setting selected.

8.5.3 The transponder should indicate correctly the altitude resolution (quantisation) used, i.e. 25ft (from an appropriate source, default resolution) or 100ft (Gillham’s coded source, permissible alternative resolution).

The conversion of Gillham’s coded data to another format before inputting to the transponder is not permitted unless failure detection<sup>1</sup> can be provided and the resolution (quantisation) is set in the transmitted data to indicate 100ft.

8.5.4 In case more stringent barometric altimetry requirements are applicable in line with e.g. airspace requirements (e.g. RVSM) or other function requirements (e.g. ACAS II), then these requirements and their related regulation take precedence.

### 8.6 Aircraft Identification

8.6.1 Identification needs to be provided to the ADS-B transmit system so that the information is identical to the filed ICAO flight plan. This information may be provided from:

- A flight management system; or
- A pilot control panel; or

<sup>1</sup> For instance, this need can be satisfied by means of dual independent altitude corrected sensors together with an altitude data comparator (which may be incorporated and enabled in the ADS-B transmit system).

- For aircraft, which always operate with the same flight identification (e.g. using registration as the flight identification) it may be programmed into equipment at installation.
- 8.6.2 In case no ICAO flight plan is filed, the Aircraft Registration needs to be provided to the ADS-B transmit system.
- 8.7 Special Position Identification (SPI)
- For ATC transponder-based ADS-B transmit systems, the SPI capability needs to be provided. The SPI capability should be integrated into the transponder functionality and should be controlled from the transponder control panel.
- 8.8 Emergency Status/Emergency Indicator
- 8.8.1 When an emergency status (i.e. discrete emergency code) has been selected by the flight crew, the emergency indicator needs to be set by the ADS-B transmit system.
- 8.8.2 For ATC transponder-based ADS-B transmit systems, the discrete emergency code declaration capability should be integrated into the transponder functionality and should be controlled from the transponder control panel.
- Permissible deviation for initial implementations:
- For initial implementations, instead of the required transmission of the discrete emergency codes 7500, 7600 and 7700 when selected by the flight crew, the transmission of only the generic emergency indicator can satisfy this requirement. Such deviation from the above target requirement needs to be listed in the Aircraft Flight Manual (refer to Section 9.3).
- 8.9 Airworthiness Considerations regarding Optional Provisions
- 8.9.1 Ground Velocity (OPTIONAL)
- Ground velocity, e.g. from an approved GNSS receiver, in the form of East/West and North/South Velocity (including a velocity quality indicator) is recommended to be provided.
- 8.9.2 Special Position Identification (SPI) (OPTIONAL)
- For non-ATC transponder-based ADS-B transmit systems (i.e. installations based on dedicated ADS-B transmitters), a discrete input or a control panel should be provided to trigger the SPI indication.
- 8.9.3 Emergency Status/Emergency Indicator (OPTIONAL)
- For non-ATC transponder-based ADS-B transmit systems (i.e. installations based on dedicated ADS-B transmitters), a discrete input or a control panel should be provided to indicate the emergency status (discrete emergency code).
- 8.9.4 Flight Deck Control Capabilities (OPTIONAL)
- 8.9.4.1 Means should be provided to the flight crew to modify the Aircraft Identification information when airborne.
- 8.9.4.2 Means should be provided to the flight crew to disable the ADS-B function on instruction from ATC without disabling the operation of the ATC transponder function.

*Note: It is recommended to implement an independent ADS-B disabling function. For future ADS B application such flight deck capability may become mandatory. It should be recalled that disabling the operation of the transponder will disable also the ACAS function.*

8.9.4.3 Means should be provided to the flight crew to disable the transmission of the barometric altitude.

## 9 COMPLIANCE WITH THIS AMC

### 9.1 Airworthiness

9.1.1 When showing compliance with this AMC, the following points should be noted:

- a) The applicant will need to submit, to the Agency, a certification plan and a compliance statement that shows how the criteria of this AMC have been satisfied, together with evidence resulting from the activities described in the following paragraphs.
- b) Compliance with the airworthiness requirements (e.g. CS-25) for intended function and safety may be demonstrated by equipment qualification, safety analysis of the interface between the ADS-B equipment and data sources, structural analyses of new antenna installations, equipment cooling verification, evidence of a human to machine interface, suitable for ADS-B-NRA.
- c) The safety analysis of the interface between the ADS-B transmit system and its data sources should show no unwanted interaction under normal or fault conditions.
- d) The functionality for ADS-B-NRA application may be demonstrated by testing that verifies nominal system operation, the aircraft derived surveillance data contained in the ADS-B messages, and the functioning of system monitoring tools/fault detectors (if any).

9.1.2 The functionality for ADS-B-NRA application may be further demonstrated by ground testing, using ramp test equipment where appropriate, that verifies nominal system operation, the aircraft derived surveillance data contained in the ADS-B messages, and the functioning of system monitoring tools/fault detectors (if any).

*Note: this limited testing assumes that the air-ground surveillance systems have been shown to satisfactorily perform their intended functions in the flight environment in accordance with applicable requirements.*

To minimise the certification effort for follow-on installations, the applicant may claim credit, from the Agency, for applicable certification and test data obtained from equivalent aircraft installations.

### 9.2 Performance

Where compliance with a performance requirement cannot readily be demonstrated by a test, then the performance may be verified by an alternative method such as analysis, including statistical analysis of measurements under operational conditions.

### 9.3 Aircraft Flight Manual

9.3.1 The Aircraft Flight Manual (AFM) or the Pilot's Operating Handbook (POH), whichever is applicable, needs to provide at least a statement of compliance that the ADS-B System complies with this AMC20-24 and if deviations are applicable. Deviations,<sup>1</sup> including those stated in this document, as appropriate may be included or referred to.

#### 9.4 Existing installations

9.4.1 The applicant will need to submit, to the Agency, a compliance statement, which shows how the criteria of this AMC have been satisfied for existing installations.

Compliance may be supported by design review and inspection of the installed system to confirm the availability of required features, functionality and acceptable human-machine interface.

9.4.2 Where this design review finds items of non-compliance, the applicant may offer mitigation that demonstrates an equivalent level of safety and performance. Items presented by the applicant which impact safety, performance and interoperability requirements allocation will need to be coordinated in accordance with ED-78A.

## 10 OPERATIONAL CONSIDERATIONS

### 10.1 General

10.1.1 The installation should be certified according to airworthiness considerations in section 8 prior to operational approval.

10.1.2 The assumptions in section 5, concerning Air Traffic and Communications Services Providers, and Aeronautical Information Services, should have been satisfied.

10.1.3 A unique ICAO 24 bit aircraft address should be assigned by the responsible authority to each airframe.

### 10.2 Operational Safety Aspects

10.2.1 In all cases, flight crews should comply with the surveillance provisions, schedules and relevant procedures contained in the Aeronautical Information Publications (AIP) published by the appropriate authorities.

10.2.2 Direct controller-pilot VHF voice communications should be available at all times.

10.2.3 If flight crew receive equipment indications showing that position being broadcast by the ADS-B system is in error (e.g. GPS anomaly), they should inform the ATSP, as appropriate, using any published contingency procedures.

10.2.4 When there is not an independent Flight Deck Control selection between the ADS-B function (ADS-B on/off) and the ATC transponder function, the crew must be fully aware that disabling the ADS B function will also lead to disable the ACAS function.

### 10.3 Operations Manual and Training

#### 10.3.1 Operations Manual

10.3.1.1 The Operations Manual should include a system description, operational and contingency procedures and training elements for use of the ADS-B-NRA application.

---

<sup>1</sup> Refer to sections 8.3.3, 8.3.5 and 8.8.2.

10.3.1.2 The Operations Manual, preferably section B, should contain the operational aspects described in this guidance material.

10.3.1.3 Operators operating under the provisions of ICAO Annex 6 Part II “International General Aviation – Aeroplanes” are not required to have an operations manual.

However, in order to use ADS-B applications, the operator should develop similar training and operational procedures to the ones described in this guidance material. This material may need to be approved by the State of Registry of the operator in accordance with national practice and sight of this approval may be required by the ADS-B navigation service provider.

### 10.3.2 Flight Crew Training

10.3.2.1 Aircraft operators should ensure that flight crew are thoroughly familiar with all relevant aspects of ADS-B applications.

10.3.2.2 Flight crew training should address the:

- a) General understanding of ADS-B-NRA operating procedures;
- b) Specific ADS-B associated phraseology;
- c) General understanding of the ADS-B technique and technology;
- d) Characteristics and limitations of the flight deck human-machine interface, including an overview of ADS-B environment and system descriptions;
- e) Need to use the ICAO defined format for entry of the Aircraft Identification or Aircraft Registration marking as applicable to the flight;

*Note 1: ICAO Document 8168-OPS/611 Volume I (Procedures for Air Navigation Services) requires that flight crew of aircraft equipped with Mode “S” having an aircraft identification feature should set the aircraft identification into the transponder. This setting is required to correspond to the aircraft identification that has been specified at Item 7 of the ICAO flight plan and consists of no more than seven characters. If the aircraft identification consists of less than seven characters, no zeros, dashes or spaces should be added. If no flight plan has been filed, the setting needs to be the same as the aircraft’s registration, again, up to a maximum of seven characters.*

*Note 2: The shortened format commonly used by airlines (a format used by International Airlines Transport Association (IATA)) is not compatible with ICAO provisions for the flight planning and ATC services used by ATC ground systems.*

- f) Operational procedures regarding the transmission of solely the generic emergency flag in cases when the flight crew actually selected a discrete emergency code (if implemented, refer to section 8.8) and SPI;
- g) Indication of ADS-B transmit capability within the ICAO flight plan but only when the aircraft is certified according to this AMC;

- h) Handling of data source errors (e.g. discrepancies between navigation data sources) (refer to 10.2.3);
- i) Incident reporting procedures;
- j) Crew Resources Management and associated human factors issues.

#### 10.4 Incident reporting

Significant incidents associated with ATC surveillance information transmitted by the ADS-B data link that affects or could affect the safe operation of the aircraft will need to be reported in accordance with EU-OPS 1.420 (or national regulations, as applicable).

#### 10.5 Minimum Equipment List

The MEL will need to be revised to indicate the possibility of despatch of aircraft with the ADS-B system unserviceable or partially unserviceable.

### 11 MAINTENANCE

11.1 Maintenance tests should include a periodic verification check of aircraft derived data including the ICAO 24 bit aircraft address using suitable ramp test equipment. The check of the 24 bit aircraft address should be made also in the event of a change of state of registration of the aircraft.

11.2 Maintenance tests should check the correct functioning of system fault detectors (if any).

11.3 Maintenance tests at ADS-B transmit system level for encoding altitude sensors with Gillham's code output should be based on the transition points defined in EUROCAE ED-26, Table 13.

11.4 Periodicity for the check of the ADS-B transmitter should be established.

### 12 AVAILABILITY OF DOCUMENTS

EASA documents are available from <http://www.easa.europa.eu>.

JAA documents are available from the JAA publisher Information Handling Services (IHS). Information on prices, where and how to order is available on both the JAA web site [www.jaa.nl](http://www.jaa.nl) and the IHS web site [www.avdataworks.com](http://www.avdataworks.com).

ICAO documents may be purchased from Document Sales Unit, International Civil Aviation Organisation, 999 University Street, Montreal, Quebec, Canada H3C 5H7, (Fax: 1 514 954 6769, e-mail: [sales\\_unit@icao.org](mailto:sales_unit@icao.org)) or through national agencies.

EUROCAE documents may be purchased from EUROCAE, 102 rue Etienne Dolet, 92240 MALAKOFF, France, (Fax: 33 1 46556265). Web site: [www.eurocae.org](http://www.eurocae.org).

RTCA documents may be purchased from RTCA, Incorporated, 1828 L Street, Northwest, Suite 820, Washington, D.C. 20036-4001 U.S.A. Web site: [www.rtca.org](http://www.rtca.org).

EUROCONTROL documents may be requested from EUROCONTROL, Documentation Centre, GS4, Rue de la Fusee, 96, B-1130 Brussels, Belgium; (Fax: 32 2 729 9109 or web site [www.eurocontrol.int](http://www.eurocontrol.int)).

FAA documents may be obtained from Department of Transportation, Subsequent Distribution Office SVC-121.23, Ardmore East Business Centre, 3341 Q 75<sup>th</sup> Avenue, Landover, MD 20785, USA.

Australia CASA documents are available from <http://www.casa.gov.au/>.

[Amdt 20/3]



## Appendix 1 to AMC 20-24

*ED Decision 2008/004/R*

### Appendix 1.1: Common Terms

Reference should be made to EUROCAE document ED-126 for the definitions of terms.

### Appendix 1.2: Abbreviations

ADS-B	Automatic Dependent Surveillance- Broadcast
ADS-B-NRA	Enhanced ATS in Non-Radar Areas using ADS-B Surveillance
AFM	Aircraft Flight Manual
ANC	Air Navigation Commission (ICAO)
ATSP	Air Traffic Service Provider
ATC	Air Traffic Control
ATS	Air Traffic Services
ATSU	Air Traffic Service Unit
ATM	Air Traffic Management
CASCADE	Co-operative ATS through Surveillance and Communication Applications Deployed in ECAC
EUROCONTROL	European Organisation for the Safety of Air Navigation
FAA	Federal Aviation Administration
GNSS	Global Navigation Satellite System
HPL	Horizontal Protection Limit
HIL	Horizontal Integrity Limit
ICAO	International Civil Aviation Organisation
INTEROP	Interoperability Requirements
MEL	Minimum Equipment List
NIC	Navigation Integrity Category
NACp	Navigation Accuracy Category
NUC	Navigation Uncertainty Category
POH	Pilots Operating Handbook
RFG	Requirement Focus Group
SIL	Surveillance Integrity Level
SPI	Special Position Identifier
SPR	Safety and Performance Requirements
SSR	Secondary Surveillance Radar
OSED	Operational Services and Environment Definition
Rc	Horizontal Position Integrity Containment Radius
TMA	Terminal Manoeuvring Area

[Amdt 20/3]

## Appendix 2 to AMC 20-24

ED Decision 2008/004/R

### Appendix 2.1: Summary of core ADS-B-NRA Operational Assumptions

- The ADS-B-NRA application assumes implementation of the procedures contained in the PANS-ATM ADS-B amendment. Fallback procedures from the radar environment apply to ADS-B-NRA when necessary. For example, ATC could apply alternate procedural separation (e.g., a vertical standard) during degraded modes.
- En route traffic density is assumed to be the same as in the current environment in which single radar coverage would enable the provision of a 5NM separation service for en route regions. This corresponds to low or medium density.
- Direct Controller-Pilot Communication (VHF) is assumed to be available at all times.
- It is assumed that the ADS-B coverage is known to the Controller in the controlled airspace.

### Appendix 2.2: Summary of core ADS-B-NRA Ground Domain Assumptions

- Controller operating procedures are assumed to be unaffected by the selection of an ADS-B data link, i.e., the ADS-B data link is assumed to be transparent to the controller.
- Air Traffic Controllers are assumed to follow existing procedures for coordination and transfer of aircraft. This applies to coordinating appropriate information with downstream units and complying with local agreements established between ATC units regarding separation standards to be established prior to entry into a bordering ATC unit.
- Appropriate ATS authorities are assumed to provide controllers with adequate contingency procedures in the event of ADS-B failures or degradation.
- It is assumed that there is a monitoring capability in the ADS-B Receive Subsystem that monitors the health and operation of the equipment and sends alerts and status messages to the Air Traffic Processing Subsystem.

[Amdt 20/3]

## Appendix 3 to AMC 20-24

ED Decision 2008/004/R

### Summary of ADS-B-NRA Airborne Safety and Performance Requirements

Parameter	Requirement
Horizontal Position and Horizontal Position Quality Indicator(s)	$10^{-5}/\text{fh}$
ADS-B System Continuity	$2 \cdot 10^{-4}/\text{fh}$
Horizontal Position Latency <sup>1</sup>	1.5 sec/95%

**Table 1: Overall Minimum Airborne ADS-B System<sup>2</sup> Requirements**

Parameter	Requirement
Horizontal Position Source	
– Accuracy (95%)	– 5 NM Sep: 926 m
– Integrity	
– Containment Radius (Rc)	– 5 NM Sep: Rc=2 NM
– Source Failure Probability	$10^{-4}/\text{h}^3$
– Alert Failure Probability	$10^{-3}$ (per position source failure event)
– Time to Alert	– 5 NM Sep: 10 sec

**Table 2: Minimum Horizontal Position Source Requirements**

Note: for DO-260 based ADS-B transmit systems, the related encoding of the horizontal position quality indicator through the Navigation Uncertainty Category (NUC) effectively leads to a containment radius requirement of 1NM for a 5 NM separation service.

Note: accuracy and integrity containment radius requirements are expressed here as guidance to related horizontal position source regulation (refer to section 8.4).

Note: the containment bound requirements reflect the outcomes of both the collision risk assessment (CAP) and time-to-alert assessment.

Note: the accuracy and integrity containment radius requirements have to be met by the horizontal position source, taking into account the effects of on-board latency (if not compensated for).

An uncompensated latency of 1.5 seconds translates into a dilution in the order of 450 metres (assuming an aircraft speed of 600 knots in en-route airspace). This value of 450 metres has to be added to the actual performance of the horizontal position source(s), the sum of which has to be within the required bounds.

The GNSS equipment specified in 8.4.6 meets the overall accuracy and integrity requirements, including the effects of an uncompensated latency of maximum 1.5 second accumulated up to the time of transmission.

<sup>1</sup> Uncompensated delay measured from to the time of validity of position measurement until ADS-B transmission (i.e. at RF level).

<sup>2</sup> As defined in section 6.

<sup>3</sup> For GNSS based functions, expressed as an assumption of GNSS performance.

Parameter	Requirement
Barometric Altitude	<ul style="list-style-type: none"> <li>– Accuracy: as per the installed sensors (refer to section 8.5.2)</li> <li>– Maximum Latency: 1 sec (as for SSR)</li> </ul>
Aircraft Identification, SPI, Emergency Status	As for SSR [AMC20-13].

**Table 3: Other Minimum ADS-B Surveillance Data Requirements**

Parameter	Loss	Corruption	Note
Barometric Altitude	Minor	Minor	As for SSR [AMC20-13].
Aircraft Identification	Minor	Minor	As for SSR.[AMC20-13]

**Table 4: Failure Condition Categories**

[Amdt 20/3]

## Appendix 4 to AMC 20-24

ED Decision 2008/004/R

### Appendix 4.1: Summary of ADS-B-NRA Air-to-ground Interoperability Requirements

The minimum set of parameters that should be provided to support the ADS-B-NRA application are summarised in the following table extracted from ED-126:<sup>1</sup>

Parameter	BDS register	Version 0		Version 1
		ICAO Annex 10 Amendment 79, VOL III, App to chap 5	DO-260/ED102	DO-260A
Aircraft identification	0.8	§2.3.4	§2.2.3.2.5	§2.2.3.2.5
SPI <sup>2</sup>	0.5	§2.3.2.6	§2.2.3.2.3.2	§2.2.3.2.3.2
Emergency indicator	0.5	§2.3.2.6	§2.2.3.2.3.2	§2.2.3.2.3.2
Barometric altitude	0.5	§2.3.2.4	§2.2.3.2.3.4	§2.2.3.2.3.4
Quality indicator (NUC/NIC)	0.5	§2.3.1	§2.2.3.2.3.1	§2.2.3.2.3.1
Airborne Position	Latitude	0.5	§2.3.2.3	§2.2.3.2.3.7
	Longitude	0.5	§2.3.2.3	§2.2.3.2.3.8
Emergency status <sup>3 4</sup>	6.1	Table 2-97	§2.2.3.2.7.9	§2.2.3.2.7.8
Quality indicator (NACp)	6.5	No definition	No definition	§2.2.3.2.7.2.7
Quality indicator (SIL)	6.5	No definition	No definition	§2.2.3.2.3.1.1
Version Indicator <sup>5</sup>	6.5	No definition	No definition	§A.1.4.10.5

Table 5: Mandatory ADS-B-NRA Parameters

The minimum set of parameters that should be provided to support the ADS-B-NRA application are summarised in the following table extracted from ED-126:

Parameter	BDS register	Version 0		Version 1
		ICAO Annex 10 Amendment 79, VOL III, App to chap 5	DO-260/ED102	DO-260A
Airborne Ground Velocity	0.9	§2.3.5	§2.2.3.2.6	§2.2.3.2.6

Table 6: Optional ADS-B-NRA Parameters

### Appendix 4.2: Guidance on Encoding of Positional Quality Indicators

In order to be able to check the compliance of the actually transmitted ADS-B data with the required quality on the recipient side, ADS-B message transmissions contain “Quality Indicators”. These are expressed for ED-102/DO-260 and DO-260A compliant ADS-B transmit systems as follows:

- ED-102/DO-260: Navigation Uncertainty Category (NUC), a combined expression of (accuracy and) integrity requirements through a single parameter;

<sup>1</sup> The notion of version “0” and “1” differentiates between DO-260/ED-102 and DO-260A transponders.

<sup>2</sup> If provided by flight deck controls.

<sup>3</sup> If provided by flight deck controls.

<sup>4</sup> For special conditions under which the non-transmission of selected discrete emergency codes is allowed, refer to Section 8.8.2.

<sup>5</sup> Only for DO-260A based ADS-B transmit systems.

- DO-260A: Navigation Accuracy Category (NACp) to express the position accuracy (as a 95 percentile), Navigation Integrity Category (NIC) to express the integrity containment radius and Surveillance Integrity Level (SIL) to specify the probability of the true position lying outside that containment radius without alerting.

Minimum acceptable NUC and NIC/NACp values in support of 5 NM ADS-B-NRA separation services, based on the requirements summarised in Table 2 of Appendix 4, are as follows in line with the “NIC/NACp to NUC” conversion table below.

NUC values (encoding based on HPL, with the accuracy requirements met by GNSS systems by design and in line with the related NACp values in below conversion table):

- 5 NM separation: NUC = 4;

The corresponding NIC/NACp values are as follows.

- 5 NM separation: NIC = 4, NACp = 5,

The SIL value is established to  $SIL \geq 2$  in line with the combination of the position source failure and position integrity alert failure requirements, as summarised in Table 2 of Appendix 4.

*Note 1: In case the SIL value is not output by the position data sources, it is recommended that the ADS-B transmit system provides for the static setting of SIL as part of the installation procedure and as demonstrated for the applicable position data source configuration.*

*Note 2: ED-126 provides, based on its reference collision risk analysis only, arguments for an equally appropriate encoding of a  $SIL=2$  as a matter of expressing the system integrity as well. As for the presentation of the values presented in this document, it is at the discretion of the ATSP to decide upon the appropriate threshold values required in support of the separation services in its airspace.*

NUC (max Rc NM)		NIC (max Rc NM)		NACp (95% bound)	
9	(0.003)	11	(0.004)	11	(3 m)
8	(0.01)	10	(0.013)	10	(10 m)
-		9	(0.04)	9	(30 m)
7	(0.1)	8	(0.1)	8	(0.05 NM)
6	(0.2)	7	(0.2)	7	(0.1 NM)
5	(0.5)	6	(0.6)	6	(0.3 NM)
4	(1.0)	5	(1.0)	5	(0.5 NM)
3	(2.0)	4	(2.0)	4	(1 NM)
-		3	(4.0)	3	(2 NM)
-		2	(8.0)	2	(4 NM)
2	(10)	1	(20)	1	(10 NM)
1	(20)	1	(20)	1	(10 NM)
0	(no integrity)	0	(> 20)	0	(unknown)

**Table 7: NUC conversion to NIC and NACp**

[Amdt 20/3]

## AMC 20-26

### AMC 20-26 Airworthiness Approval and Operational Criteria for RNP Authorisation Required (RNP AR) Operations

*ED Decision 2009/019/R*

This AMC provides a means of compliance for applicants for an airworthiness approval to conduct Required Navigation Performance Authorisation Required (RNP AR) Operations and the applicable criteria to obtain an operational approval. It relates to the implementation of area navigation within the context of the Single European Sky<sup>1</sup>, in particular in relation to the verification of conformity of the airborne constituents, per Article 5 of EC Regulation 552/2004. Additional guidance material can be found in the ICAO Performance Based Navigation Manual, Document 9613, Volume II, Chapter 6, as contained in ICAO State Letter AN 11/45-07/22.

#### 1 PREAMBLE

In order to ensure an increased availability, enhanced safety and reduced operating minima over and above that provided from traditional non-precision and conventional Area Navigation (RNAV) approaches, the concept of area navigation within the European Region, RNP should be implemented on instrument approach procedures

This AMC provides a means of compliance for the airworthiness approval of area navigation systems and their use for RNP AR operations that range from nominal (i.e. where general aircraft qualification is matched to standard AR procedure design) to those more demanding in operational and performance requirements. The assurance of consistency with and conformance to the target level of safety (TLS) objectives for RNP AR operations results from the specific compliance criteria of this AMC and the associated standard RNP AR procedure design.

This AMC is generally consistent with the Single European Sky legislation and with material in the ICAO Performance-Based Navigation Manual, as well as in EUROCONTROL publications dealing with related operational and functional requirements for area navigation. The material contained in this AMC reflects the fundamental change associated with RNP in the roles, responsibilities and requirements for the regulator, manufacturer, operator and procedure designer.

This AMC is based on barometric-vertical navigation (BARO-VNAV) and RNAV multi-sensor navigation systems, as well as the system concepts, guidance and standards defined in the RTCA DO-236()/EUROCAE ED-75() MASPS. RNP AR builds on the RNP concept that requires the ability of the aircraft navigation system to monitor its achieved navigation performance, and to identify to the pilot whether the operational requirement is or is not being met during an operation.

This AMC addresses general certification considerations, including functional requirements, accuracy, integrity, continuity of function and system limitations.

This AMC introduces some provisions for aircraft qualification to RNP AR Departure protected with customised procedure design criteria. These provisions will be completed in a next issue of the AMC, once ICAO has published public procedure design criteria for departures.

<sup>1</sup> Regulation (EC) No 549/2004 of the European Parliament and of the Council of 10 March 2004 laying down the framework for the creation of the single European sky (the framework Regulation).

This AMC is based on the criteria developed in FAA AC 90-101, with inclusion of more stringent criteria (see [Appendix 6](#)), including notably a focus on aircraft performance in Non-Normal conditions.

Compliance with this AMC provides, but by itself does not constitute, a basis for an operational approval to conduct RNP operations. The special procedure design criteria contained in the RNP AR procedure design manual may necessitate additional operational evaluation depending upon the operator needs or operating conditions.

Aircraft operators should apply to their competent authority for such an approval. Since this AMC has been harmonised with other RNP implementation and operations approval criteria outside of Europe i.e. USA/FAA, it is expected to facilitate interoperability and ease the effort in obtaining operational approval by airline operators.

### 1.1 PURPOSE

This AMC establishes an acceptable means of compliance for an applicant to obtain airworthiness approval of an RNP system and the operational criteria for use in designated European airspace blocks where RNP AR operations have been implemented by the competent aviation authority. An applicant may elect to use an alternative means of compliance. However, those alternative means of compliance must meet safety objectives that are acceptable to the Agency. Compliance with this AMC is not mandatory hence the use of the terms *shall* and *must* apply only to an applicant who elects to comply with this AMC in order to obtain airworthiness approval.

### 1.2 BACKGROUND

The application of RNP AR to terminal area and approach operations provides an opportunity to utilise modern aircraft capability and performance to improve safety, efficiency and capacity. Safety is improved when RNP AR procedures replace visual procedures or non-precision approaches, and efficiency is improved through more repeatable and optimum flight paths. Capacity can be improved by de-conflicting traffic during instrument conditions.

RNP AR includes unique capabilities that require aircraft and aircrew authorisation similar to Category (CAT) II/III ILS operations. All RNP AR procedures have reduced lateral obstacle evaluation areas and vertical obstacle clearance surfaces predicated on the aircraft and aircrew performance requirements of this AMC. In general, RNP AR procedures are expected to be developed to not only address specific operational needs or requirements but also to enable benefits to the broadest segment of the RNP AR aircraft population possible. As a result, there are some aspects of RNP AR approach procedure design that will be used only as necessary.

A critical component of RNP is the ability of the aircraft navigation system to monitor its achieved navigation performance, and to identify to the pilot whether the operational requirement is or is not being met during an operation.

The criteria (both procedure design and certification) may take account of the fact that aircraft with different flight guidance capabilities will be used to fly the procedures. However, the procedure design criteria do reflect specific levels of aircraft performance and capability for the barometric VNAV aspects of the operation. The operator authorisation may be extended where the operational requirements can be met by aircraft but require more stringent performance criteria.



## 2 SCOPE

This material provides airworthiness approval criteria related to RNAV systems with lateral navigation (LNAV) and BRAO-VNAV capabilities, intended to be used under Instrument Flight Rules, including Instrument Meteorological Conditions, in designated European airspace blocks where RNP Authorisation Required (AR) operations have been implemented per a decision of the competent aviation authorities. It addresses general certification requirements, including functional requirements, accuracy, integrity, continuity of function, and system limitations.

The material contained in this AMC is unique and represents the fundamental change associated with RNP in the roles, responsibilities and requirements for the regulator, manufacturer, air operator and procedure designer. The assurance of consistency with and conformance to the target level of safety (TLS) objectives for RNP AR operations results from the specific compliance criteria of this AMC, a flight operational safety assessment and the associated standard RNP AR procedure design.

The material and criteria contained herein also provide a means for development and approval of an RNP AR capability consistent with the RNP AR procedures implemented using the ICAO PBN RNP AR Procedure Design Manual. However, it should be recognised that in order to perform RNP AR operations there are three key aspects of this AMC that must be considered. The first is that where an operator/manufacturer satisfies all criteria contained herein, they should be considered operationally ready to conduct RNP AR operations using procedure design and alternatives defined by the ICAO PBN RNP AR Procedure Design Manual. The second is that there are three elements of the procedure design criteria that will only be used on the occasions where there is a specific operational need or benefit. As a result, operators can be authorised for all or any subset of these types of procedures:

- Reduced lateral obstacle evaluation area on the missed approach or departure (also referred to as a procedure requiring RNP less than 1.0) or
- When conducting a RNP AR approach using a line of minima less than RNP 0.3 and/or a missed approach or departure that requires RNP less than 1.0. and
- Ability to fly a published ARC (also referred to as a RF leg)

These aspects of instrument procedures are reflected in the guidance and criteria of the ICAO PBN RNP AR procedure design manual. Therefore, an operator/manufacturer with aircraft lacking some or all of these capabilities should recognise that this will result in operational limitations, i.e. the more complex or demanding operations using these procedure criteria may not be performed. The third aspect is that there will be specific situations where even full compliance to the AMC may be insufficient to conduct procedures that are tailored to aircraft specific performance

This AMC recognises that published criteria for demonstrated aircraft performance may be insufficient to enable RNP AR operations where the performance required is less than 0.3 NM. Consequently, this AMC provides the criteria necessary to support airworthiness approval to these lower values and criteria including guidance for the assessment of:

- Training and Crew Qualification (see [Appendix 2](#))
- RNP Operational Considerations (see [Appendix 3](#))
- Flight Technical Error (see [Appendix 4](#))
- Flight Operation Safety Assessment (see [Appendix 5](#))

This AMC also contains criteria reflecting the Agency's opinion that parts of the ICAO PBN Navigation Specification for RNP AR APCH are not appropriate for the RNP AR operations that the Agency will authorise. As a result, select criteria in the AMC are different and are clearly noted as such.

Section 3.2 of this AMC refers to documents which contribute to the understanding of the RNP concept and which may support an application for approval. However, it is important that an applicant evaluates his aircraft system against the criteria of this AMC.

Compliance with this AMC provides, but by itself does not constitute, a basis for, an operational approval to conduct RNP operations. Aircraft operators should apply to their national authority for such an approval. While an objective of this AMC is interoperability and to ease operator operational approvals, some operators and manufacturers will need to consider the noted differences in requirements from the ICAO PBN Manual and FAA AC 90-101 to determine what additional aircraft or system changes are necessary, or what operational limitations must be implemented.

A glossary of terms and acronyms used in this AMC is given in [Appendix 1](#).

### 3 REFERENCE DOCUMENTS

#### 3.1 Related Requirements

CS 25.1301, 25.1302, 25.1307, 25.1309, 25.1316, 25.1321, 25.1322, 25.1329, 25.1431, 25.1581.

CS 23.1301, 23.1309, 23.1311, 23.1321, 23.1322, 23.1329, 23.1335, 23.1431, 23.1581.

EU-OPS<sup>1</sup> 1.243, 1.420, 1.845, 1.865, 1.873

National operational regulations

#### 3.2 Related Material

##### 3.2.1 ICAO

Doc 8168-OPS/611 Aircraft Operations (PANS OPS)

Doc 9613 Performance Based Navigation Manual

Doc 9881 Guidelines for Electronic Terrain, Obstacle and Aerodrome Mapping Information

Doc 9905 Required Navigation Performance Authorization Required (RNP AR) Procedure Design Manual

##### 3.2.2 EASA

AMC 20-5 Airworthiness Approval and Operational Criteria for the use of the Navstar Global Positioning System (GPS)

AMC 25-11 Electronic Display Systems

AMC 20-27 AMC 20-27 Airworthiness Approval and Operational Criteria for RNP APPROACH (RNP APCH) Operations Including APV BARO-VNAV Operations

EASA Opinion Nr. 01/2005 The Acceptance of Navigation Database Suppliers

<sup>1</sup> REGULATION (EC) No 1899/2006 OF THE EUROPEAN PARLIAMENT AND OF THE COUNCIL of 12 December 2006 amending Council Regulation (EEC) No 3922/91 on the harmonisation of technical requirements and administrative procedures in the field of civil aviation.

### 3.2.3 EUROCONTROL

NAV.ET1.ST16-001( ) Navigation Strategy for ECAC

Document 003-93( ) Area Navigation Equipment: Operational Requirements and Functional Requirements

### 3.2.4 FAA

AC 25-11( ) Electronic Display Systems

AC 20-129 Airworthiness Approval of Vertical Navigation (VNAV) Systems for Use in the U.S. National Airspace System (NAS) and Alaska

AC 20-130( ) Airworthiness Approval of Navigation or Flight Management Systems Integrating Multiple Navigation Sensors

AC 20-138( ) Airworthiness Approval of NAVSTAR Global Positioning System (GPS) for use as a VFR and IFR Supplemental Navigation System

AC 25-4 Inertial Navigation Systems (INS)

AC 25-15 Approval of Flight Management Systems in Transport Category Airplanes

AC 90-97 Use of Barometric Vertical Navigation (VNAV) for Instrument Approach Operations using Decision Altitude

Order 8260.52 United States Standard for Required Navigation Performance (RNP) Approach Procedures with Special Aircraft and Aircrew Authorization Required (SAAAR)

AC 90-101 Approval for Required Navigation Performance (RNP) Procedures with Special Aircraft and Aircrew Authorisation Required (SAAAR)

AC 120-29A Criteria for Approval of Category I and Category II Weather Minima for Approach

AC 20-153 Acceptance of Data Processes and Associated Navigation Databases

### 3.2.5 Technical Standard Orders

ETSO-C115( )/TSO-C115( ) Airborne Area Navigation Equipment Using Multi-sensor Inputs.

ETSO-C129( )/TSO-C129( ) Airborne Supplemental Navigation Equipment Using the Global Positioning System (GPS)

ETSO-C145( )/TSO-C145( ) Airborne Navigation Sensors Using the Global Positioning System (GPS) Augmented by the Wide Area Augmentation System (WAAS)

ETSO-C146( )/TSO-C146( ) Stand-Alone Airborne Navigation Equipment Using the Global Positioning System (GPS) Augmented by the Wide Area Augmentation System (WAAS)

ETSO-C151( )/TSO-C151( ) Terrain Awareness and Warning System (TAWS)

### 3.2.6 EUROCAE/RTCA and ARINC

ED-75( )/DO-236( )	Minimum Aviation System Performance Standards: Required Navigation Performance for Area Navigation
DO-283A	Minimum Operational Performance Standards for Required Navigation Performance for Area Navigation
ED-76 / DO-200A	Standards for Processing Aeronautical Data
ED-77 / DO-201A	Standards for Aeronautical Information
DO-229( )	Minimum Operational Performance Standards for Global Positioning System/Wide Area Augmentation System Airborne equipment
ARINC 424	Navigation System Data Base

## 4 ASSUMPTIONS

Applicants should note that this AMC is based on the following assumptions concerning the measures taken by the responsible airspace authorities and service providers to safeguard RNP AR operations in the European region:

### 4.1 Navaid Infrastructure Considerations

RNP AR approaches are only authorised based on GNSS as the primary Navaid infrastructure. The use of DME/DME as a reversionary capability (e.g. extraction when on an approach or continuation for departures) is only authorised for individual operators where the infrastructure supports the required performance. RNP AR operations should not be used in areas of known navigation signal (GNSS) interference.

Note 1: Most modern RNAV systems will prioritise inputs from GNSS and then DME/DME positioning. Although VOR/DME positioning is usually performed within a flight management computer when DME/DME positioning criteria do not exist, avionics and infrastructure variability pose serious challenges to standardisation.

Note 2: Procedure validation will entail use of an infrastructure navigation performance tool that is capable of analysing the flight procedure path and profile relative to the ground navigation aid infrastructure. This type of tool is likely to only approximate results for the actual procedure. However, due to the cost of flight checking, increased efficiency is anticipated in flight checking when augmented with an infrastructure navigation performance tool.

Note 3: With or without an infrastructure navigation performance tool, a flight check aircraft is expected to be used. Where State flight check aircraft systems do not reflect the types of aircraft or systems intending to conduct the RNP AR procedure, use of operator aircraft with systems that also provides real time calculations of their achieved performance along the procedure flight path and profile should also be used to evaluate a procedure. The selected aircraft are intended to provide confidence in the interoperability of differing systems and implementations.

Note 4: For procedures that allow aircraft to rely only on GNSS, (see paragraph 8.3), the acceptability of the risk of degraded navigation performance beyond the requirements for the operation for multiple aircraft due to satellite failure or RAIM holes, has been considered by the responsible airspace authority.

## **4.2 Communication & ATS Surveillance Considerations**

RNP AR operations described herein do not require any unique communication or ATS Surveillance considerations.

## **4.3 Obstacle Clearance and Route Spacing**

All RNP AR procedures:

- (1) are published by an Aeronautical Information Service Provider certified according to article 7 of Regulation 550/2004<sup>1</sup>; or
- (2) are consistent with the relevant parts of ICAO Doc 8168 PANS OPS and ICAO PBN RNP AR Procedure Design Manual;
- (3) take account of the functional and performance capabilities of RNP systems and their safety levels as detailed in this AMC;

Note: Particular attention should be given to the constraints implied by the Airworthiness Certification objectives of paragraph 6.

- (4) require that barometric vertical navigation capability be used;
- (5) support reasonableness checking by the flight crew by including, on the charts, fix data (e.g. range and bearing to navigational aids or waypoint to waypoint);
- (6) terrain and obstacle data in the vicinity of the approach is published in accordance with ICAO Annex 15 to the Convention on International Civil Aviation and Doc 9881, Guidelines for Electronic Terrain, Obstacle and Aerodrome Mapping Information;
- (7) if the contingency procedure allows a reversion in aircraft use of navigation infrastructure, e.g. GNSS to DME/DME, the obstacle clearance assessment is based on an RNP that allows either infrastructure;
- (8) barometric altitude compensation for low temperature effects is accounted for in the procedure design, and any necessary limitations are specified in the AIP;
- (9) the Safety Case assessment for RNP AR operations accounts for the regulatory determination and documentation of compliance to the AMCs detailed requirements for the navigation system, aircraft operational capability, crew procedures and continuing airworthiness, as meeting or exceeding their TLS objectives for the procedure and/or spacing;
- (10) are designated RNAV e.g. RNAV(RNP) and throughout the AIP and on aeronautical charts, will specify either the sensors allowed or the RNP value required;
- (11) may have attributes that depart from the standard applications of procedures described in the ICAO RNP AR Procedure Design Manual.

## **4.4 Additional Considerations**

- a) Guidance in this chapter does not supersede the applicable operational requirements for equipage.

---

<sup>1</sup> Regulation (EC) No 550/2004 of the European Parliament and of the Council of 10 March 2004 on the provision of air navigation services in the single European sky (the service provision Regulation).

- b) Current local pressure setting must be provided to support RNP AR approaches, where the aircraft's achieved vertical path is dependent on that setting. Failure to report a correct setting can lead to aircraft leaving the obstacle clearance area.

#### **4.5 Flight Evaluation**

- a) As RNP AR approaches do not have a specific underlying navigation facility, there is no requirement for flight inspection of navigation signals. However, due to the importance of publishing correct data, it is recommended that flight evaluation be used prior to publication for procedure validation and obstacle validation. Flight evaluation can be accomplished through ground evaluation (e.g. simulator assessment) and actual flight.
- b) Procedure validation includes confirmation of the basic flyability of the procedure in accordance with the procedure design. A thorough flyability assessment is not required prior to publication, since flyability is individually assessed by the operator as part of their database updating and maintenance process due to the unique nature of RNP AR approaches. The flight evaluation prior to publication should confirm track lengths, bank angles, descent gradients, runway alignment and compatibility with predictive terrain hazard warning functions (e.g. ETSO-C151( )/TSO-C151( ) compliant Terrain Awareness and Warning Systems). A Flight Inspection Truth System is typically not required. Due to variations in aircraft speeds, flight control system design, and navigation system design this flight evaluation does not confirm flyability for all of the various aircraft conducting RNP AR approaches.
- c) Obstacle validation through flight evaluation may be used to validate the obstacle data used to design the procedure. An obstacle flight evaluation may not be necessary if obstacle validation can be accomplished through ground inspection or validated survey techniques to the appropriate accuracy.

#### **4.6 Publication**

- a) The AIP clearly indicates the navigation application is RNP AR approach and specific authorisation is required.
- b) All procedures are based upon WGS 84 coordinates.
- c) The navigation data published in the relevant AIP for the procedures and supporting navigation aids must meet the requirements of Annex 15 and Annex 4 to the Convention on International Civil Aviation (as appropriate). The original data defining the procedure should be available to the operators in a manner suitable to enable the operator to verify their navigation data.
- d) The navigation accuracy for all RNP AR approach procedures is clearly published in the AIP.
- e) The navigation data for the procedure(s) to be loaded into the flight management system is from database supplier holds a Type 2 Letter of Acceptance (LoA) or equivalent and has been independently validated by the operator.
- f) Where reliance is placed on the use of radar to assist contingency procedures, its performance has been shown to be adequate for that purpose, and the requirement for a radar service is identified in the AIP.

#### **4.7 Controller Training**

Air traffic controllers, who will provide control services at airports where RNP approaches have been implemented, have completed the appropriate training

#### **4.8 Status Monitoring**

The Navaid infrastructure is monitored and, where appropriate, maintained by a service provider certified for navigation services according to article 7 of EC regulation 550/2004. For the use of non EU navigation service providers, timely warnings of outages (NOTAM) should be issued. Also status information should be provided to Air Traffic Services in accordance with ICAO Annex 11 to the Convention on International Civil Aviation for navigation facilities or services that may be used to support the operation.

#### **4.9 ATS System Monitoring**

When available, radar observations of each aircraft's proximity to track and altitude are typically noted by Air Traffic Service (ATS) facilities and aircraft track-keeping capabilities are analysed. If an observation/analysis indicates that a loss of separation or obstacle clearance has occurred, the reason for the apparent deviation from track or altitude should be determined and steps taken to prevent a recurrence.

### **5 SYSTEM DESCRIPTION**

#### **5.1 Lateral Navigation (LNAV)**

5.1.1 For lateral navigation, the RNAV equipment enables the aircraft to be navigated in accordance with appropriate routing instructions along a path defined by waypoints held in an on-board navigation database.

Note: LNAV is typically a flight guidance systems mode, where the RNAV equipment provides path steering commands to the flight guidance system, which then controls flight technical error through either manual pilot control with a path deviation display or through coupling to the flight director or autopilot.

5.1.2 For the purposes of this AMC, RNP AR operations are based upon the use of RNAV equipment that automatically determines aircraft position in the horizontal plane using inputs from the following types of positioning sensor (in no specific order of priority or combination) but whose primary basis for positioning is GNSS:

- (a) Global Navigation Satellite System (GNSS).
- (b) Inertial Navigation System (INS) or Inertial Reference System (IRS).
- (c) Distance Measuring Equipment giving measurements from two or more ground stations (DME/DME).

Additional information and requirements are in paragraphs 8.3 through 8.5.

#### **5.2 Vertical Navigation**

5.2.1 For Vertical Navigation, the system enables the aircraft to fly level and descend relative to a linear, point to point vertical profile path that is held in an on-board navigation database. The vertical profile will be based upon altitude constraints or vertical path angles where appropriate, associated with the LNAV path waypoints.

Note 1: VNAV is typically a flight guidance systems mode, where the RNAV equipment containing VNAV capability provides path steering commands to the flight guidance system, which then controls flight technical error through

either manual pilot control with a vertical deviation display or through coupling to the flight director or autopilot.

Note 2: The ARINC 424 specification data allows the definition of a vertical angle, however some system implementations preclude the specification of a vertical angle on a flight leg. In such a case it may be necessary to examine the leg types available that do and determine if the resulting lateral path is acceptable for the surrounding airspace.

Note 3: The specification of vertical angles on multiple path fixes in descent may lead to possible vertical path discontinuities (e.g. temperature effect). This type of procedure should be assessed to determine if the system response and performance can be accommodated in this situation and for other systems, or if the procedure must be changed. Climb paths are typically not included in a vertical profile e.g. departure or missed approach.

Note 4: Additionally, some system implementations may allow the manual specification of a vertical angle for a path or path segment. This capability may need to be evaluated to determine if it has the potential to alter or impact a VNAV procedure and the possible means of mitigating the potential condition e.g. design change or operational procedure.

Note 5: The system may provide the capability to determine performance optimised paths. A performance optimised path is defined by a series of straight line path segments that are designed to hold an aircraft at a specified speed while holding thrust to a constant value (e.g. typically near idle for descent) and guiding to the series of straight line paths. The elements required for the determination of the performance optimised path include gross weight, lift, drag and speed. This path capability and aircraft operation may be acceptable where the vertical path is specified with flexibility (e.g. altitude windows, AT/ABOVE). However, in the case where a linear point to point path, or flight path angle is specified, this type of systems capability with its associated vertical path errors may be unacceptable for the required operations.

Note 6: Systems may implement vertical profiles specified by AT/ABOVE constraints as a point to point path defined by AT constraints. This type of characteristic in system path definition may be acceptable.

Note 7: Systems that allow vertical paths to be defined by a combination of altitude constraints, and flight path angles, may be subject to vertical discontinuities, where a smooth or continuous vertical path is not possible. System responses to this condition may vary from possible level off manoeuvre to vertical speed captures of the flight path. The aircraft system performance must be assessed on a case by case basis for its acceptability for the required operation, and still may not be acceptable.

5.2.2 Temperature Compensation Systems: Systems that provide temperature-based corrections to the barometric VNAV guidance must comply with EUROCAE ED-75B, Appendix H.2. This applies to the final approach segment. Compliance to this standard should be documented to enable the operator to conduct RNP approaches when the actual temperature is below or above the published procedure design limit.



## 6 AIRWORTHINESS CERTIFICATION OBJECTIVES

The following performance certification criteria are defined for the airborne systems on the basis that the Assumptions of Section 4 are valid.

### 6.1 Accuracy

Aircraft performance is evaluated around the path defined by the published procedure and EUROCAE/ED-75B, Section 3.2. All vertical paths used in conjunction with the final approach segment will be defined by a Flight Path Angle (EUROCAE/ED-75B, Section 3.2.8.4.3) as a straight line emanating from a fix and altitude.

#### 6.1.1 Lateral

During operations on approaches notified exclusively for RNP equipped aircraft, the lateral track keeping accuracy and along-track positioning error of the on-board navigation system shall be equal to or better than the RNP for 95% of the flight time.

Note 1: The lateral track keeping accuracy is dependent on the navigation total system error (a combination of path definition error, position estimation error, display error and Flight Technical Error (FTE)).

- a) Refer to [Appendix 4](#) for the assessment of FTE for RNP AR operations authorised with RF legs, reduced lateral obstacle evaluation, e.g. less than 0.3 NM in final approach, less than 1.0 NM for missed approach.

Note 2: Provided that paragraph 8.3(b) has been shown to be valid in respect of typical GNSS performance, then, for RNAV systems that have been declared (e.g. in the Aircraft Flight Manual) to be compliant with the navigation accuracy criteria of FAA AC 20-130(), or FAA AC 20-138() or [AMC 20-5](#) or [AMC 20-27](#) and the accuracy requirements of this AMC including a statement of the operational RNP capability, the intent of this paragraph is considered as satisfied and no further accuracy demonstration is required. However, such a Flight Manual statement, by itself, does not constitute an airworthiness approval for RNP AR operations and compliance with all other criteria of this AMC will need to be shown.

Note 3: Some RNP system implementations may provide for multi-sensor mixing in the calculation of aircraft position. While this is not required, it provides for smoothing when positioning sources change and a means to optimise the calculation of aircraft position that is not possible for single source systems. Manufacturers should consider the effects of sensor failure or errors on lateral position during the conduct of RNP AR operations, and the potential departure, approach and missed approach RNP, in implementing system architecture, sensor switching, and redundancy.

#### 6.1.2 Vertical

During operations on instrument approach procedures notified exclusively for RNP aircraft and where the Vertical Error Budget (VEB) applies, the vertical system error includes altimetry error (assuming the temperature and lapse rates of the International Standard Atmosphere), the effect of along-track error, system computation error, data resolution error, and flight technical error. The 99.7% of system error in the vertical direction during the stabilised constant descent path must be less than the following (in feet):

$$\sqrt{((6076.115)(1.225)RNP \cdot \tan\theta)^2 + (60\tan\theta)^2 + 75^2 + ((-8.8 \cdot 10^{-8})(h + \Delta h)^2 + (6.5 \cdot 10^{-3})(h + \Delta h) + 50)^2}$$

Where  $\theta$  the vertical navigation (VNAV) path angle,  $h$  is the height of the local altimetry reporting station and  $\Delta h$  is the height of the aircraft above the reporting station.

The 99.7% altimetry system error for each aircraft (assuming the temperature and lapse rates of the ISA) shall be less or equal to than the following with the aircraft in the approach configuration:

$$ASE = -8.8 \cdot 10^{-8} \cdot H^2 + 6.5 \cdot 10^{-3} \cdot H + 50 \text{ (ft)}$$

Where  $H$  is the true altitude of the aircraft.

Note 1: Current guidance for VNAV such as AC20-129, and AC90-97 has less stringent performance requirements. A supplemental analysis, assessment and regulatory approval (i.e. airworthiness) will be necessary in meeting the requirements.

Note 2: For the vertical system error above, vertical angle error is not included and is not considered since data and database processes associated with DO-200A and DO-201A are required. In addition ATIS, automatic terminal information service temperature error is not included and is accounted for in the procedure design.

### 6.1.3 RNP System Performance

The required demonstration of RNP system performance, including lateral and vertical path steering performance (FTE), will vary according to the type of AR operation being considered e.g. low RNP for obstacle clearance or separation in an obstacle rich environment or high density air traffic environment. It will be for the competent Authority, responsible for the approval of the procedure, to assess the RNP level for the considered operation in accordance with the Flight Operations Safety Assessment (FOSA) see [Appendix 5](#).

In supporting the FOSA exercise, the applicant will be required to demonstrate the aircraft capability in terms of RNP system performance under a variety of operational conditions, rare normal conditions and non-normal conditions – see also [Appendix 4](#). For the non-normal conditions the applicant should conduct a safety impact assessment, which identifies from the existing aircraft System Safety Assessments (SSA), those Failure Conditions that have an impact on the RNP system performance. This safety assessment process should encompass the additional Failure Conditions introduced by any specific feature designed and implemented as mitigation for RNP AR operations (e.g. lateral deviation display) and also identify and document any additional flight crew procedures and training, necessary to support the overall safety of the operation.

Specific evaluations should be conducted to assess the path excursions upon failures and the resulting RNP levels. Results should be documented in the Aircraft Flight Manual (AFM), AFM Supplement or appropriate aircraft operational support document and made available to the operator, thereby alleviating the need for similar operational evaluations.

Acceptable criterion to be used for assessing RNP significant failures under limit performance conditions (see [Appendix 4](#) Para 4) is as follows:

- a) The lateral excursions observed as a result of Probable failures should be documented against an objective of containment within 1xRNP.

Note 1: The System Safety Assessment of the aircraft systems supporting RNP AR operations (RNAV systems, Flight Controls Systems, Flight Guidance Systems, etc.) should therefore be revisited to identify these Probable failures. Probable failures are failures with a probability greater than  $10^{-5}$  per operation.

Note 2: This demonstration can rely on crew action to intervene and place the aircraft back on the target track, or apply a contingency procedure when the guidance is lost.

- b) The lateral excursions observed as a result of One Engine Inoperative (OEI) should be documented against an objective of containment within 1xRNP.

Note 1: This demonstration can rely on crew action to intervene and place the aircraft back on the target track.

- c) The lateral excursions observed as a result of Remote failures should be documented against an objective of containment within 2xRNP.

Note 1: The demonstration should evaluate the contributions of:

- (i) Remote systems failures that may impact the RNP capability
- (ii) GNSS satellite outages

Note 2: Remote system failures should include latent failures (integrity) and detected failures (continuity). For the detected failures, the monitor limit of the alert, the time to alert, the crew reaction time, and the aircraft response should all be considered when ensuring that the aircraft does not exit the obstacle clearance volume. Remote failures are failures with a probability between  $10^{-5}$  and  $10^{-7}$  per operation.

- d) A demonstration should be made that the aircraft remains manoeuvrable and a safe extraction may be flown for all Extremely Remote failures.

Note 1: Extremely Remote failures are failures with a probability between  $10^{-7}$  and  $10^{-9}$ .

For conditions a, b and c above, the vertical excursion should not exceed 75 feet below the desired path.

## 6.2 Integrity

### 6.2.1 System

- a) RNP and Barometric VNAV aircraft (e.g. FMS RNAV/VNAV equipped). This AMC provides a detailed acceptable means of compliance for aircraft that use an RNP system based primarily on GNSS and a VNAV system based on barometric altimetry. Aircraft complying with this AMC provide the requisite airspace containment (i.e. satisfactory assurance that the aircraft will remain within the obstacle clearance volume) through a variety of monitoring and alerting (e.g. 'Unable RNP', GNSS alert limit, path deviation monitoring).
- b) Other systems or alternate means of compliance. For other systems or alternate means of compliance, the probability of the aircraft exiting the lateral and vertical extent of the obstacle clearance volume (defined in ICAO

PBN RNP AR Procedure Design Manual) must not exceed  $10^{-7}$  per operation, including the departure, approach and missed approach. The use of such alternatives may be satisfied by the flight operational safety assessment (see [Appendix 5](#)).

Note 1: The  $10^{-7}$  requirement applies to the total probability of excursion outside the obstacle clearance volume, including events caused by latent conditions (integrity) and by detected conditions (continuity) if the aircraft does not remain within the obstacle clearance volume after annunciation of the failure. The monitor limit of the alert, the latency of the alert, the crew reaction time, and the aircraft response should all be considered when ensuring that the aircraft does not exit the obstacle clearance volume. The requirement applies to a single approach, considering the exposure time of the operation and the Navaid geometry and navigation performance available for each published approach.

Note 2: This containment requirement derives from the operational requirement. This requirement is notably different than the containment requirement specified in RTCA/DO-236B (EUROCAE ED-75B). The requirement in RTCA/DO-236B (EUROCAE ED-75B) was developed to facilitate airspace design and does not directly equate to obstacle clearance.

#### 6.2.2 Display

The system design must be consistent with at least a major failure condition for the display of misleading lateral or vertical guidance on an RNP AR approach.

Note: The display of misleading lateral or vertical RNP guidance is considered a hazardous (severe-major) failure condition for RNP AR approaches with an RNP value less than RNP 0.3. Systems designed consistent with this effect should be documented as it may eliminate the need for some operational mitigations for the aircraft.

### 6.3 Continuity of Function

With respect to the airborne systems, it shall be shown that:

- a) The probability of loss of all navigation information is Remote.
- b) The probability of non-restorable loss of all navigation and communication functions is Extremely Improbable.

Note 1: In addition to the equipment required by EU-OPS 1, Sub-part L for IFR flight (or equivalent national requirements), at least one area navigation system is required. Where continued operation is required for a procedure with RNP on either the approach or missed approach, dual systems will be needed (see 7.2).

Note 2: Systems approved for RNP operations may have to comply with additional continuity requirements to ensure that the RNP capability is available for a specified RNP and operational environment e.g. dual equipage, independent systems for cross checking, etc.

Note 3: Probability terms are defined in CS AMC 25.1309, AC 23.1309-1( ) AC 27-1B or AC 29-2C.

## 7 FUNCTIONAL CRITERIA

### 7.1 Minimum Required Functions for RNP AR Operations

Table 1 lists and describes the system functions and features required where RNP AR operations are predicated on nominal RNP AR procedure design criteria e.g. FAA Notice 8260.52, ICAO RNP AR Procedure Design Manual.

Item	Function/Feature
	<b>Displays</b>
1	<p>Continuous Display of Deviation. The navigation system must provide the capability to continuously display to the pilot flying, on the primary flight instruments for navigation of the aircraft, the aircraft position relative to the defined lateral and vertical path (both lateral and vertical deviation) and manoeuvre anticipation. The display must allow the pilot to readily distinguish if the cross-track deviation exceeds the RNP (or a smaller value) or if the vertical deviation exceeds 75 feet (or a smaller value). Where the minimum flight crew is two pilots, means for the pilot not flying must be provided to verify the desired path and the aircraft position relative to the path.</p> <p>To achieve this, an appropriately scaled non-numeric deviation display (i.e. lateral deviation indicator and vertical deviation indicator) located in the pilot's primary field of view may be provided.</p> <p>Alternatively:</p> <p>For lateral data presentation only</p> <p>For RNP 0.3 and above,</p> <ul style="list-style-type: none"> <li>– a navigation map display, readily visible to the flight crew, with appropriate map scales, giving equivalent functionality to an appropriately scaled non-numeric lateral deviation display, except that scaling may be set manually by the flight crew or</li> <li>– a numeric display of the lateral deviation, readily visible to the flight crew, with a minimum resolution of 0.1 NM and direction relative to the track</li> </ul> <p>For RNP &lt;0.3</p> <ul style="list-style-type: none"> <li>– a numeric display of the lateral deviation, in the primary field of view, with a resolution of 0.01 NM and direction relative to the track</li> </ul> <p>Note 1: A fixed-scale CDI is acceptable as long as the CDI demonstrates appropriate scaling and sensitivity for the intended navigation accuracy and operation. With a scalable CDI, the scale should be derived from the selection of RNP, and shall not require the separate selection of a CDI scale. Where a CDI is relied upon, alerting and annunciation limits must also match the scaling values. If the equipment uses default navigation accuracy to describe the operational mode (e.g. en-route, terminal area and approach), then displaying the operational mode is an acceptable means from which the flight crew may derive the CDI scale sensitivity.</p>
2	Identification of the Active (To) Waypoint. The navigation system must provide a display identifying the active waypoint either in the pilot's primary field of view, or on a readily accessible and visible display to the flight crew.
3	Display of Distance and Bearing. The navigation system should provide a display of distance and bearing to the active (To) waypoint in the pilot's primary field of view. Where not viable, a readily accessible page on a control display unit, readily visible to the flight crew, may display the data.
4	Display of Groundspeed and Time. The navigation system should provide the display of groundspeed and either estimated time of arrival or time to the active (To) waypoint in the pilot's primary field of view. Where not viable, a readily accessible page on a control display unit, readily visible to the flight crew, may display the data.
5	Display of To/From the active fix. The navigation system must provide a To/From display in the pilot's primary field of view. Systems with electronic map display in the pilot's primary field of view having designation of the active waypoint fulfil this requirement.

Item	Function/Feature
6	Desired Track Display. The navigation system must have the capability to continuously display to the pilot flying the aircraft the RNAV desired track. This display must be on the primary flight instruments for navigation of the aircraft.
7	Display of Aircraft Track. The navigation system must provide a display of the actual aircraft track (or track angle error) either in the pilot's primary field of view, or on a readily accessible and visible display to the flight crew.
8	Slaved Course Selector. The navigation system must provide a course selector automatically slaved to the RNAV computed path. As an acceptable alternative is an integral navigation map display.
9	RNAV Path Display. Where the minimum flight crew is two pilots, the navigation system must provide a readily visible means for the pilot not flying to verify the aircraft's RNAV defined path and the aircraft's position relative to the defined path.
10	Display of Distance to Go. The navigation system must provide the ability to display distance to go to any waypoint selected by the flight crew.
11	Display of Distance Between Flight Plan Waypoints. The navigation system must provide the ability to display the distance between flight plan waypoints.
12	Display of Barometric Altitude. The aircraft must display barometric altitude from two independent altimetry sources, one in each pilots' primary field of view. The altimeter setting input must be used simultaneously by the aircraft altimetry system and by the RNAV system. Note 1: This display supports an operational cross-check (comparator monitor) of altitude sources. If the aircraft altitude sources are automatically compared, the output of the independent altimetry sources, including independent aircraft static air pressure systems, must be analysed to ensure that they can provide an alert in the pilot's primary field of view when deviations between the sources exceed $\pm 75$ feet. Such comparator monitor function should be documented as it may eliminate the need for an operational mitigation.  Note 2: A single input is necessary to prevent possible crew error. Separate altimeter setting for the RNAV system is prohibited.
13	Display of Active Sensors. The aircraft must display the current navigation sensor(s) in use that are readily accessible to the flight crew.
<b>Performance, Monitoring and Alerting</b>	
14	Navigation performance: The system should include a capability to monitor for its achieved lateral navigation performance (e.g. EPU, EPE, ACTUAL or equivalent), and to identify for the flight crew whether the operational requirement is or is not being met during an operation (e.g. 'UNABLE RNP', 'Nav Accur Downgrad', path deviation monitoring, GNSS alert limit). For vertical navigation, this may be achieved by system vertical monitoring and alerting or by a combination of indications such as barometric altitude display and vertical deviation display in combination with procedural crosschecks. Signals radiated by GNSS augmentation systems managed by certified navigation service providers may be taken into account.
15	For multi-sensor systems, automatic reversion to an alternate navigation sensor if the primary navigation sensor fails. Note: This does not preclude means for manual navigation source selection.
16	When DME is used in RNP AR operations, automatic tuning of DME navigation aids used for position updating together with the capability to inhibit individual navigation aids from the automatic selection process. Note: Further guidance may be found in EUROCAE ED-75B / RTCA DO-236B, Section 3.7.3.1.
17	Capability for the RNAV system to perform automatic selection (or de-selection) of navigation sources, a reasonableness check, an integrity check, and a manual override or deselect. Note 1: The reasonableness and integrity checks are intended to prevent navigation aids being used for navigation update in areas where the data can lead to radio position fixing errors due to

Item	Function/Feature
	<p>co-channel interference, multipath, stations in test, changes in station location and direct signal screening. In lieu of using radio navigation aid designated operational coverage (DOC), the navigation system should provide checks which preclude use of duplicate frequency nav aids within range, over-the-horizon nav aids, and use of nav aids with poor geometry.</p> <p>Note 2: Further guidance may be found in EUROCAE ED-75B/RTCA DO-236B, Section 3.7.3.1.</p>
18	<p>Failure Annunciation. The aircraft must provide a means to announce failures of any aircraft component of the RNAV system, including navigation sensors. The annunciation must be visible to the pilot and located in the primary field of view.</p>
19	<p>Navigation Database status: The system should provide the means to display the validity period of the navigation database to the flight crew.</p>
<b>Path Definition and Flight Planning</b>	
20	<p>Maintaining Track and Leg Transitions. The aircraft must have the capability to execute leg transitions and maintain tracks consistent with the following paths:</p> <ul style="list-style-type: none"> <li>i) A geodesic line between two fixes (TF)</li> <li>ii) A direct path to a fix (DF)</li> <li>iii) A specified track to a fix, defined by a course (CF)</li> </ul> <p>Note 1: Industry standards for these paths can be found in RTCA DO-236B and ARINC Specification 424, which refer to them as TF, DF, CF path terminators. EUROCAE ED-75A/RTCA DO-236B and EUROCAE ED-77/RTCA DO-201A describe the application of these paths in more detail.</p> <p>Note 2: Use of CF may be acceptable in missed approach only, subject to local approval.</p>
21	<p>Fly-By and Fly-Over Fixes. The aircraft must have the capability to execute fly-by and fly-over fixes. The fly-over turn does not provide for repeatable paths, and is not compatible with RNP flight tracks. The fly-by turn may be used for limited RNP AR path changes under TF-TF or DF-TF transitions subject to procedure design requirements.</p> <p>When fly-by turns are required for specific RNP AR operations, the navigation system must limit the path definition within the theoretical transition area defined in RTCA DO-236B under the wind conditions identified in the ICAO PBN RNP AR Procedure Design Manual Doc 9905.</p>
22	<p>Waypoint Resolution Error. The navigation database must provide sufficient data resolution to ensure the navigation system achieves the required accuracy. Waypoint resolution error must be less than or equal to 60 feet, including both the data storage resolution and the RNAV system computational resolution used internally for construction of flight plan waypoints. The navigation database must contain vertical angles (flight path angles) stored to a resolution of hundredths of a degree, with equivalent computational resolution.</p>
23	<p>Capability for a "Direct-To" Function. The navigation system must have a "Direct-To" function the flight crew can activate at any time. This function must be available to any fix. The navigation system must also be capable of generating a geodesic path to the designated "To" fix, without "S-turning" and without undue delay.</p>
24	<p>Capability to define a vertical path. The navigation system must be capable of defining a vertical path by a flight path angle to a fix. The system must also be capable of specifying a vertical path between altitude constraints at two fixes in the flight plan. Fix altitude constraints must be defined as one of the following:</p> <ul style="list-style-type: none"> <li>(i) An "AT or ABOVE" altitude constraint (for example, 2400A, may be appropriate for situations where bounding the vertical path is not required);</li> <li>(ii) An "AT or BELOW" altitude constraint (for example, 4800B, may be appropriate for situations where bounding the vertical path is not required);</li> <li>(iii) An "AT" altitude constraint (for example, 5200); or</li> <li>(iv) A "WINDOW" constraint (for example, 2400A3400B);</li> </ul>

Item	Function/Feature
	Note: For RNP AR procedures, any segment with a published vertical path will define that path based on an angle to the fix and altitude.
25	Altitudes and/or speeds associated with published terminal procedures must be extracted from the navigation database.
26	The system must be able to construct a path to provide guidance from current position to a vertically constrained fix.
27	Capability to Load Procedures from the Navigation Database. The navigation system must have the capability to load the entire procedure(s) to be flown into the RNAV system from the onboard navigation database. This includes the approach (including vertical angle), the missed approach and the approach transitions for the selected airport and runway.
28	Means to Retrieve and Display Navigation Data. The navigation system must provide the ability for the flight crew to verify the procedure to be flown through review of the data stored in the onboard navigation database. This includes the ability to review the data for individual waypoints and for navigation aids.
29	Magnetic Variation. For paths defined by a course (CF path terminator), the navigation system must use the magnetic variation value for the procedure in the navigation database.
30	Changes in Navigation accuracy. RNP changes to lower navigation accuracy must be complete by the fix defining the leg with the lower navigation accuracy, considering the alerting latency of the navigation system. Any operational procedures necessary to accomplish this must be identified.
31	Automatic Leg Sequencing. The navigation system must provide the capability to automatically sequence to the next leg and display the sequencing to the flight crew in a readily visible manner.
32	A display of the altitude restrictions associated with flight plan fixes must be available to the pilot. If there is a specified navigation database procedure with a flight path angle associated with any flight plan leg, the equipment must display the flight path angle for that leg.
	<b>Navigation Database</b>
33	<p>The aircraft navigation system must use an on-board navigation database containing current navigation data officially promulgated for civil aviation by a certified AIS provider, which can:</p> <ul style="list-style-type: none"> <li>a) be updated in accordance with the AIRAC cycle and</li> <li>b) from which terminal airspace procedures can be retrieved and loaded into the RNAV system.</li> </ul> <p>The resolution to which the data is stored must be sufficient to ensure that the assumption of no path definition error is satisfied.</p> <p>The database must be protected against flight crew modification of the stored data.</p> <p>Note: When a procedure is loaded from the database, the RNAV system is required to fly it as published. This does not preclude the flight crew from having the means to modify a procedure or route already loaded into the RNAV system. However, the procedure stored in the database must not be modified and must remain intact within the database for future use and reference.</p>

**Table 1: Required Functions**

## 7.2 Additional Required Functions Supporting RNP AR operations

Table 2 lists and describes the system functions and features required for more demanding operations e.g. where RNP AR operations are predicated on use of RF legs, RNP less than 0.3 or RNP less than 1.0 on missed approach.

Item	Operation/Function
	<b>Where RNP AR Operations use RF Legs:</b>
1	<ul style="list-style-type: none"> <li>(1) The navigation system must have the capability to execute leg transitions and maintain tracks consistent with an RF leg between two fixes.</li> <li>(2) The aircraft must have an electronic map display of the selected procedure.</li> </ul>



Item	Operation/Function
	<p>(3) The navigation system, the flight director system and autopilot must be capable of commanding a bank angle up to 25 degrees at or above 400 feet AGL and up to 8 degrees below 400 feet AGL. (These values are consistent with those published in the ICAO Doc 9905).</p> <p>(4) Upon initiating a go-around or missed approach (through activation of TOGA or other means), the flight guidance mode should remain in LNAV to enable continuous track guidance during an RF leg. Other means or mitigations may be acceptable depending on the aircraft, demonstrated path tracking performance, procedures and associated FOSA for go-around and missed approach procedures that require an RNP 0.3 or greater.</p> <p>(5) When evaluating flight technical error on RF legs, the effect of rolling into and out of the turn should be considered. The procedure is designed to provide 5 degrees of manoeuvrability margin, to enable the aircraft to get back on the desired track after a slight overshoot at the start of the turn.</p> <p>Note: It should be noted that a radius to fix (RF) leg is considered a procedure design tool that is available to solve a specific operational requirement or problem. As such it may be considered a highly desired option for select RNP AR operations. In some instances, the RF will be applied in the final or missed approach, requiring additional consideration in a FOSA. Systems lacking such capability should have sufficient means to ensure that operators are aware of this limitation and that it precludes the conduct of RNP AR procedures containing an RF leg.</p>
	<b>Where RNP AR Operations are less than RNP 0.3:</b>
2	<p>(1) No single-point-of-failure. No single-point-of-failure can cause the total loss of guidance compliant with the navigation accuracy associated with the approach. Typically, the aircraft must have at least the following equipment: dual GNSS sensors, dual flight management systems, dual air data systems, dual autopilots, and a single inertial reference unit (IRU). A single autopilot is acceptable provided dual independent flight directors are available and the approach permits use of the flight directors to either continue the approach or execute a missed approach.</p> <p>Note: If automatic switching is not available, it must be demonstrated that the time required to switch to an alternate system does not result in the aircraft exceeding the RNP value.</p> <p>(2) Hazardous Failure. The system design must be consistent with at least a hazardous failure condition (as per AMC 25-1309) for the loss or display of misleading of lateral or vertical guidance.</p> <p>(3) Go-around guidance. Upon initiating a go-around or missed approach (through activation of TOGA or other means), the flight guidance mode should remain in LNAV to enable continuous track guidance during an RF leg.</p> <p>(4) Loss of GNSS. After initiating a go-around or missed approach following loss of GNSS, the aircraft must automatically revert to another means of navigation that complies with the navigation accuracy for the time necessary to fly the go-around or the missed approach.</p>
	<b>Where Missed Approach are less than RNP 1.0</b>
3	<p>(1) Single-point-of-failure. No single-point-of-failure can cause the total loss of guidance compliant with the navigation accuracy associated with a missed approach procedure. Typically, the aircraft must have at least the following equipment: dual GNSS sensors, dual flight management systems, dual air data systems, dual autopilots, and a single inertial reference unit (IRU). A single autopilot is acceptable provided dual independent flight directors are available and the approach permits use of the flight directors to either continue the approach or execute a missed approach.</p> <p>Note: If automatic switching is not available, it must be demonstrated that the time required to switch to an alternate system does not result in the aircraft exceeding the RNP value.</p>

Item	Operation/Function
(2)	Major Failure. The system design assurance must be consistent with at least a major failure condition (as per AMC 25.1309) for the loss of lateral or vertical guidance.
(3)	Go-Around Guidance. Upon initiating a go-around or missed approach (through activation of TOGA or other means), the flight guidance mode should remain in LNAV to enable continuous track guidance during an RF leg. For go-around and missed approach procedures that require an RNP 0.3 or greater other means and/or mitigations may be acceptable depending on the aircraft, demonstrated path tracking performance, procedures and associated FOSA.
(4)	Loss of GNSS. After initiating a go-around or missed approach following loss of GNSS, the aircraft must automatically revert to another means of navigation that complies with the navigation accuracy for the time necessary to fly the go-around or the missed approach.

**Table 2: Procedure Specific Required Functions**

## 8 AIRWORTHINESS COMPLIANCE

### 8.1 General

The following compliance guidelines assume that the aircraft is equipped in accordance with EU-OPS 1 Sub-part L for IFR flight for aeroplanes involved in commercial air transportation, or equivalent national requirements for aircraft outside the scope of EU-OPS.

Due to the unique requirements for RNP AR operations and the need for crew procedures that are specific to each particular aircraft and navigation system, RNP AR operational support documentation is required from the manufacturer. The document(s) should describe the navigation capabilities of applicant's aircraft in the context of RNP AR operations, and provide all the assumptions, limitations and supporting information necessary for the safe conduct of RNP AR operations.

It is expected that operators will use the manufacturer recommendations when developing their procedures and application for approval. Installation of equipment is not sufficient by itself to obtain approval for use on RNP AR.

#### 8.1.1 New or Modified Installations

In demonstrating compliance with this AMC, the following specific points should be noted:

- a) The applicant will need to submit, to the Agency, a compliance statement which shows how the criteria of this AMC have been satisfied in establishing aircraft eligibility. The statement should be based on a certification plan, agreed by the Agency at an early stage of the implementation programme. The plan should identify the data to be submitted which should include, as appropriate, a system description together with evidence resulting from the activities defined in the following paragraphs.
- b) Aircraft Qualification
  - (1) Compliance with the airworthiness requirements for intended function and safety may be demonstrated by equipment qualification, system safety analysis, confirmation of appropriate software design assurance level (i.e. consistent with paragraph 6.2.2 and if applicable paragraph 7.2), performance analyses, and a combination of ground and flight tests. To support the approval application, design data will

need to be submitted showing that the objectives and criteria of Sections 6 and 7 of this AMC have been satisfied.

- (2) Use of the RNAV systems and the manner of presentation of lateral and vertical guidance information on the flight deck must be evaluated to show that the risk of flight crew error has been minimised. In particular, during the transition to the final approach, the display of ILS or other approved landing system information simultaneously with RNAV information to a flight crew member will need careful consideration.
- (3) Equipment failure scenarios involving conventional navigation sensors and the RNAV system(s) must be evaluated to demonstrate that adequate alternative means of navigation are available following failure of the RNAV system, and that reversionary switching arrangements do not lead to misleading or unsafe display configurations. The evaluation must consider also the probability of failures within the switching arrangements.
- (4) The coupling arrangements for the RNAV system to flight director/automatic pilot must be evaluated to show compatibility and that operating modes, including RNAV system failures modes and RNP alerts, are clearly and unambiguously indicated to the flight crew.
- (5) To comply with Section 7, Table 1, item 20. (in particular when intercepting a CF leg) must be shown to be possible without the need for manual intervention, i.e. without disengaging the RNAV mode, and then a manual course selection. This does not preclude means for manual intervention when needed.
- (6) MEL requirements and maintenance procedures should be consistent with the aircraft RNP systems availability and performance requirements.

#### 8.1.2 Existing Installations

The applicant will need to submit to the Agency, a compliance statement which shows how the criteria of this AMC have been satisfied for existing installations. Compliance may be established by inspection of the installed system to confirm the availability of required features and functionality. The performance and integrity criteria of Section 6 and 7 may be confirmed by reference to statements in the Aircraft Flight Manual or to other applicable approvals and supporting certification data. In the absence of such evidence, supplementary analyses and/or tests will be required. Paragraph 9 addresses Aircraft Flight Manual changes that might be necessary.

#### 8.2 Database Integrity

The navigation database should be shown to comply with EUROCAE ED-76/RTCA DO-200A, or equivalent approved procedures.

#### 8.3 Use of GPS

- a) The sensor must comply with the guidelines in AC 20-138(). For systems that comply with AC 20-138(), the following sensor accuracies can be used in the total system accuracy analysis without additional substantiation: GPS sensor accuracy is

better than 36 meters (95%), and augmented GPS (GBAS or SBAS) sensor accuracy is better than 2 meters (95%).

- b) In the event of a latent GPS satellite failure and marginal GPS satellite geometry (e.g. Horizontal Integrity Limit (HIL) equal to the horizontal alert limit), the probability that the aircraft remains within the obstacle clearance volume used to evaluate the procedure must be greater than 95% (both laterally and vertically).

Note: GNSS-based sensors output a HIL, also known as a Horizontal Protection Level (HPL) (see FAA AC 20-138A Appendix 1 and RTCA/DO-229C for an explanation of these terms). The HIL is a measure of the position estimation error assuming a latent failure is present. In lieu of a detailed analysis of the effects of latent failures on the total system error, an acceptable means of compliance for GNSS-based systems is to ensure the HIL remains less than twice the navigation accuracy, minus the 95% of FTE, during the RNP AR operation.

#### **8.4 Use of Inertial Reference System (IRS)**

An inertial reference system must satisfy the criteria of US 14 CFR part 121, Appendix G, or equivalent. While Appendix G defines the requirement for a 2 NM per hour drift rate (95%) for flights up to 10 hours, this rate may not apply to an RNAV system after loss of position updating. Systems that have demonstrated compliance with FAR Part 121, Appendix G can be assumed to have an initial drift rate of 8 NM/hour for the first 30 minutes (95%) without further substantiation. Aircraft manufacturers and applicants can demonstrate improved inertial performance in accordance with the methods described in Appendix 1 or 2 of FAA Order 8400.12A.

Note 1: Integrated GPS/INS position solutions reduce the rate of degradation after loss of position updating. For “tightly coupled” GPS/IRUs, RTCA/DO-229C, Appendix R, provides additional guidance.

Note 2: INS/IRS by itself is not considered suitable for the types of RNP applications described herein. However, it is recognised that many multi-sensor navigation systems utilise INS/IRS within their navigation calculations to provide continuity when the other higher accuracy sensor(s) are momentarily unavailable.

#### **8.5 Use of Distance Measuring Equipment (DME).**

Initiation of all RNP AR procedures is based on GNSS updating. Except where specifically designated on a procedure as Not Authorised, DME/DME updating can be used as a reversionary mode during the approach or missed approach when the system complies with the RNP. Aircraft manufacturer and applicants should identify any constraints on the DME infrastructure or the procedure for a given aircraft to comply with this requirement.

Note 1: In general, Distance Measurement Equipment (DME) (i.e. position updating from two or more ground stations, DME/DME) will not be sufficient to achieve RNP AR operations where the performance required is less than 0.3 NM. However, where DME is sufficient, it is expected that they meet ICAO Annex 10 to the Convention on International Civil Aviation and are listed in the AIP.

#### **8.6 Use of VHF Omni-directional Range station (VOR)**

For the initial RNP AR implementation, the RNAV system may not use VOR updating. The manufacturer should identify any constraints on the VOR infrastructure or the procedure for a given aircraft to comply with this requirement.

Note: This requirement does not imply an equipment capability must exist providing a direct means of inhibiting VOR updating. A procedural means for the flight crew to inhibit VOR updating or executing a missed approach if reverting to VOR updating may meet this requirement.

### **8.7 Intermixing of Equipment**

Installation of area navigation systems with different crew interfaces can be very confusing and can lead to problems when they have conflicting methods of operation and conflicting display formats. There can be problems even when intermixing different versions of the same equipment. For approach operations, intermixing of RNAV equipment will only be permitted when specific factors have been addressed satisfactorily. As a minimum, consideration must be given to the following potential incompatibilities particularly where the flight deck architecture includes cross coupling capabilities (e.g. GNSS-2 switched to drive the number 1 displays).

- a) Data entry: The two systems must have consistent methods of data entry, and similar pilot procedures for accomplishing common tasks. Any differences should be evaluated for pilot workload. If the wrong procedures are used, (for example, the data entry procedures for the offside system are used by mistake for the onside), there must be no misleading information and it must be easy to identify and recover from the mistake.
- b) CDI scaling: Sensitivity must be consistent or annunciated.
- c) Display symbology and mode annunciation: There must be no conflicting symbols or annunciation (e.g. a common symbol used for two different purposes), and differences should be specifically evaluated to evaluate the potential confusion they may cause.
- d) Mode logic: The modes internal to the equipment and their interface to the rest of the aircraft must be consistent.
- e) Equipment failure: The effect of failure of one unit must not result in misleading information.
- f) Displayed data: The display of primary navigation parameters must use consistent units and a consistent notation.
- g) Database differences: Due to the inherent data conflict, differences in the area navigation database will not be permitted.

## **9 AIRCRAFT FLIGHT MANUAL/pilot operating handbook**

For new or modified aircraft, the Aircraft Flight Manual (AFM) or the Pilot's Operating Handbook (POH), whichever is applicable, should provide at least the following information:

- a) A statement which identifies the equipment and aircraft build or modification standard certificated for RNP operation or having specific statement of RNP capability. This may include a very brief description of the RNAV/GNSS system, including the RNAV/GNSS airborne equipment software version, CDI/HSI equipment and installation and a statement that it is suitable for RNP operations.
- b) Appropriate amendments or supplements to cover RNP operations in the following sections:

- Limitations – including use of FD and AP; currency of navigation database; crew verification of navigation data; availability of RAIM or equivalent function; restrictions on use of GNSS for conventional Non Precision Approaches.
- Normal Procedures
- Abnormal Procedures – including actions in response to a Loss of Integrity (e.g. ‘RAIM Position Warning’, (or equivalent) message or a ‘RAIM not available’, (or equivalent) message or ‘UNABLE REQ NAV PERF’, ‘NAV ACCUR DOWNGRAD’, (or equivalent) or other RNP messages).

Note: This limited set assumes that a detailed description of the installed system and related operating instructions and procedures are available in other approved operational or training manuals.

## 10 OPERATIONAL CRITERIA

### 10.1 General

This section plus the considerations provided in [Appendix 3](#) are provided to assist an operator in developing the necessary processes and materials supporting their application for an operational approval to conduct RNP AR operations. This includes standard operating procedures, flight operations documentation and training package. The operational criteria assume that the corresponding installation/airworthiness approval has been granted by the Agency.

Operations of the RNAV system should be in accordance with the AFM or AFM supplement. The (Master) Minimum Equipment List (MMEL/MEL) should be amended to identify the minimum equipment necessary to satisfy operations using the RNAV system.

### 10.2 Flight Operations Documentation

The relevant parts and sections of the Operations Manual and check lists must be revised to take account of the operating procedures detailed below (Normal Procedures and Abnormal Procedures). The operator must make timely amendments to the Operations Manual to reflect relevant RNAV AR procedure and database checking strategies. Manuals and check lists need to be submitted for review by the responsible authority as part of the approval process.

The aircraft operator should propose an amendment to the Minimum Equipment List (MEL) appropriate to RNP AR operations.

### 10.3 Qualification and Training

Each pilot should receive appropriate training, briefings and guidance material in order to safely conduct RNP AR procedures. The material and training should cover the normal and abnormal procedures. Standard training and checking such as recurrent training and proficiency checks should include RNP procedures. Based on this, the operator should determine what constitutes a qualified crew.

The operator should ensure that effective methods are used to implement applicable RNP AR procedures to ensure that in line operations each pilot can perform assigned duties reliably and expeditiously for each procedure to be flown, both in normal circumstances, and for probable non-normal circumstances. Additional guidance is provided in [APPENDIX 2](#) and [3](#), as well as the RNP AR APCH navigation specification contained in the ICAO Performance Based Navigation Manual, Volume II.

## 10.4 Navigation Database Management

### 10.4.1 Initial Data Validation

The operator must validate every RNP AR procedure before flying the procedure in instrument meteorological conditions (IMC) to ensure compatibility with their aircraft and to ensure the resulting path matches the published procedure. As a minimum, the operator must:

- a) Compare the navigation data for the procedure(s) to be loaded into the flight management system with the published procedure.
- b) Validate the loaded navigation data for the procedure, either in a simulator or in the actual aircraft in visual meteorological conditions (VMC). The depicted procedure on the map display must be compared to the published procedure. The entire procedure must be flown to ensure the path is flyable, does not have any apparent lateral or vertical path disconnects, and is consistent with the published procedure.
- c) Once the procedure is validated, retain and maintain a copy of the validated navigation data for comparison to subsequent data updates.

### 10.4.2 Operator involved in the operation of aeroplanes for commercial air transportation

EU-OPS 1.873 for the management of navigation database applies.

### 10.4.3 Operator not involved in the operation of aeroplanes for commercial air transportation

The operators should not use a navigation database for RNP APCH operations unless the navigation database supplier holds a Type 2 Letter of Acceptance (LoA) or equivalent.

An EASA Type 2 LoA is issued by EASA in accordance with EASA OPINION Nr. 01/2005 on "The Acceptance of Navigation Database Suppliers" dated 14 Jan 05. The FAA issues a Type 2 LoA in accordance with AC 20-153, while Transport Canada (TCCA) issues an Acknowledgement Letter of an Aeronautical Data Process using the same basis. Both the FAA LoA and the TCCA Acknowledgement Letter are seen to be equivalent to the EASA LoA.

EUROCAE/RTCA document ED-76/DO-200A Standards for Processing Aeronautical Data contains guidance relating to the processes that the supplier may follow. The LoA demonstrates compliance with this standard.

#### 10.4.3.1 Non-approved Suppliers

If the operator's supplier does not hold a Type 2 LoA or equivalent, the operator should not use the electronic navigation data products unless the Authority has approved the operator's procedures for ensuring that the process applied and the delivered products have met equivalent standards of integrity.

#### 10.4.3.2 Quality Monitoring

The operator should continue to monitor both the process and the products in accordance with the quality system required by the applicable operational regulations.

#### 10.4.3.3 Data Distribution

The operator should implement procedures that ensure timely distribution and insertion of current and unaltered electronic navigation data to all aircraft that require it.

#### 10.4.4 Aircraft Modifications

If an aircraft system required for RNP AR operations is modified (e.g. software change), the operator is responsible for validation of RNP AR procedures with the navigation database and the modified system. This may be accomplished without any direct evaluation if the manufacturer verifies that the modification has no effect on the navigation database or path computation. If no such assurance from the manufacturer is available, the operator must conduct initial data validation with the modified system.

### 10.5 Reportable Events

A reportable event is one that adversely affects the safety of the operation and may be caused by actions/events external to the operation of the aircraft navigation system. The operator should have in place a system for investigating such an event to determine if it is due to an improperly coded procedure, or a navigation data base error. Responsibility for initiating corrective action rests with the operator.

For those operators for whom approval is granted under EU OPS-1, following events should be the subject of Occurrence Reports (see EU-OPS 1.420):

Technical defects and the exceeding of technical limitations, including:

- a) Significant navigation errors attributed to incorrect data or a database coding error.
- b) Unexpected deviations in lateral/vertical flight path not caused by pilot input or erroneous operation of equipment.
- c) Significant misleading information without a failure warning.
- d) Total loss or multiple navigation equipment failure.
- e) Loss of integrity (e.g. RAIM) function whereas integrity was predicted to be available during the pre-flight planning.

### 10.6 Fleet Approvals

Normally, operational approvals for RNAV AR Procedures will be fleet specific.

### 10.7 RNP Monitoring Programme

The operator should have an RNP monitoring programme to ensure continued compliance with the guidance of this AMC and to identify any negative trends in performance. At a minimum, this programme must address the following information. During the initial 90 day interim approval period, the operator must submit the following information every 30 days to the authority granting their authorisation. Thereafter, the operator must continue to collect and periodically review this data to identify potential safety concerns, and maintain summaries of this data.

- a) Total number of RNP AR procedures conducted
- b) Number of satisfactory approaches by aircraft/system (Satisfactory if completed as planned without any navigation or guidance system anomalies)



- 
- c) Reasons for unsatisfactory approaches, such as:
    - 1) UNABLE REQ NAV PERF, NAV ACCUR DOWNGRAD, or other RNP messages during approaches
    - 2) Excessive lateral or vertical deviation
    - 3) TAWS warning
    - 4) Autopilot system disconnect
    - 5) Nav data errors
    - 6) Pilot report of any anomaly
  - d) Crew comments

[Amdt 20/5]

## Appendix 1 to AMC 20-26 Glossary

ED Decision 2009/019/R

The following are definitions of key terms used throughout this AMC.

**Area Navigation (RNAV).** A method of navigation which permits aircraft operation on any desired flight path within the coverage of station-referenced navigation aids or within the limits of the capability of self-contained aids, or a combination of these.

Note: RNAV functional capability is typically viewed as navigation operations in the horizontal plane, which is known also as Lateral Navigation Mode. However, an RNAV system may include functional capabilities for operations in the vertical plane, known as Vertical Navigation Mode.

**Accuracy.** The degree of conformance between the estimated, measured, or desired position and/or the velocity of a platform at a given time, and its true position or velocity. Navigation performance accuracy is usually presented as a statistical measure of system error and is specified as predictable, repeatable and relative.

**Availability.** An indication of the ability of the system to provide usable service within the specified coverage area and is defined as the portion of time during which the system is to be used for navigation during which reliable navigation information is presented to the crew, automatic pilot, or other system managing the flight of the aircraft.

**Continuity of Function.** The capability of the total system (comprising all elements necessary to maintain aircraft position within the defined airspace) to perform its function without non-scheduled interruptions during the intended operation.

**Integrity.** The ability of a system to provide timely warnings to users when the system should not be used for navigation.

**Receiver Autonomous Integrity Monitoring (RAIM).** A technique whereby a GPS receiver/processor determines the integrity of the GPS navigation signals using only GPS signals or GPS signals augmented with altitude. This determination is achieved by a consistency check among redundant pseudo-range measurements. At least one satellite in addition to those required for navigation must be in view for the receiver to perform the RAIM function.

**Vertical Navigation.** A method of navigation which permits aircraft operation on a vertical flight profile using altimetry sources, external flight path references, or a combination of these.

The following acronyms are used in the document:

AFM	Aircraft Flight Manual
AGL	Above Ground Level
AIP	Aeronautical Information Publication
AIRAC	Aeronautical information regulation and control
AP	Autopilot
APCH	Approach
AR	Authorisation Required
ATC	Air Traffic Control
ATS	Air Traffic Service
BARO	Barometric
CAT	Category
CDI	Course Deviation Indicator
CF	Course to Fix

CRM	Collision risk model
CRM	Crew resource management
DA/H	Descent Altitude/Height
DF	Direct to Fix
DME	Distance Measuring Equipment
EC	European Commission
EFIS	Electronic flight instrument system
EGNOS	European Geostationary Navigation Overlay Service
ETA	Estimated Time of Arrival
EU	European Union
FAF	Final Approach Fix
FD	Flight Director
FOM	Flight Operations Manual
FMC	Flight Management Computer
FMS	Flight Management System
F/O	First Officer
FOSA	Flight Operations Safety Assessment
FTE	Flight Technical Error
GBAS	Ground-based augmentation system
GNSS	Global Navigation Satellite System
GPS	Global Positioning System
GPWS	Ground Proximity Warning System
HIL	Horizontal Integrity Limit
HSI	Horizontal situation indicator
IAF	Initial Approach Fix
IAP	Instrument approach procedure
ICAO	International Civil Aviation Organisation
IFR	Instrument Flight Rules
ILS	Instrument Landing System
IMC	Instrument meteorological conditions
INS	Inertial Navigation System
IRS	Inertial Reference System
IRU	Inertial Reference Unit
ISA	International standard atmosphere
KIAS	Knots indicated airspeed
LoA	Letter of Acceptance
LOE	Line Oriented Evaluation
LOFT	Line Oriented Flight Training
LNAV	Lateral Navigation
MASPS	Minimum Aviation System Performance Standards
MEL	Minimum Equipment List
MMEL	Master Minimum Equipment List
NAV	Navigation
NM	Nautical Mile
NOTAM	Notice to Airmen
OEI	One Engine Inoperative

---

OEM	Original Equipment Manufacture
PBN	Performance Based Navigation
PC	Proficiency Check
POH	Pilot Operating Handbook
PT	Proficiency Training
RAIM	Receiver Autonomous Integrity Monitoring
RF	Radius to Fix
RNAV	Area Navigation
RNP	Required Navigation Performance
RTA	Required Time of Arrival
SBAS	Satellite-based augmentation system
SSA	System Safety Assessments
STC	Supplemental Type Certificates
TAWS	Terrain Awareness Warning System
TC	Type Certificates
TERPS	Terminal Instrument Procedures
TF	Track to Fix
TLS	Target Level Of Safety
TOGA	Take off/Go around
VDI	Vertical Deviation Indicator
VEB	Vertical Error Budget
VMC	visual meteorological conditions
VNAV	Vertical Navigation
VOR	VHF Omni-directional Range
WGS	World Geodetic System

[Amdt 20/5]

## Appendix 2 to AMC 20-26 Training and Crew Qualification Issues

ED Decision 2009/019/R

### 1 INTRODUCTION

The operator must provide training for key personnel (e.g. flight crewmembers and dispatchers) in the use and application of RNP AR procedures. A thorough understanding of the operational procedures and best practices is critical to the safe operation of aircraft during RNP AR operations. This programme must provide sufficient detail on the aircraft's navigation and flight control systems to enable the pilots to identify failures affecting the aircraft's RNP capability and the appropriate abnormal/emergency procedures. Required training must include both knowledge and skill assessments of the crewmembers and dispatchers duties.

#### 1.1 Flight Crew Training

- a) Each operator is responsible for the training of flight crews for the specific RNP AR operations exercised by the operator. The operator must include training on the different types of RNP AR procedures and required equipment. Training must include discussion of RNP AR regulatory requirements. The operator must include these requirements and procedures in their flight operations and training manuals (as applicable). This material must cover all aspects of the operator's RNP AR operations including the applicable AR authorisation. An individual must have completed the appropriate ground and/or flight training segment before engaging in RNP AR operations.
- b) Flight training segments must include training and checking modules representative of the type of RNP AR operations the operator conducts during line flying activities. Many operators may train for RNP AR procedures under the established training standards and provisions for any advanced qualification programmes. They may conduct evaluations in Line Oriented Flight Training (LOFT) scenarios, selected event training scenarios or in a combination of both. The operator may conduct required flight-training modules in Flight Training Devices, Aircraft Simulators, and other enhanced training devices as long as these training mediums accurately replicate the operator's equipment and RNP AR operations.

#### 1.2 Flight Crew Qualification Training

- a) Operators must address initial RNP AR training and qualifications during initial, transition, upgrade, recurrent, differences, or stand-alone training and qualification programmes in a respective qualification category. The qualification standards assess each pilot's ability to properly understand and use RNP AR procedures. The operator must also develop recurrent qualification standards to ensure their flight crews maintain appropriate RNP AR knowledge and skills (RNP AR Recurrent Qualification).
- b) Operators may address RNP AR operation topics separately or integrate them with other curriculum elements. For example, an RNP AR flight crew qualification may key on a specific aircraft during transition, upgrade, or differences courses. General training may also address RNP AR qualification (e.g. during recurrent training or checking events such as recurrent proficiency check/proficiency training (PC/PT), line oriented evaluation (LOE) or special purpose operational training. A separate, independent RNP AR qualification programme may also address RNP AR training (e.g. by completion of a special RNP AR curriculum at an operator's training centre or at designated crew bases).

- c) Operators intending to receive credit for RNP training, when their proposed programme relies on previous training (e.g. Special RNP IAP's) must receive specific authorisation from their approving authority. In addition to the current RNP training programme, the operator will need to provide differences training between existing training programme and the RNP AR training requirements.

### **1.3 Flight Dispatcher Training**

Training for flight dispatchers must include: training on the different types of RNP AR procedures, the importance of specific navigation equipment and other equipment during RNP AR operations and discuss RNP AR regulatory requirements and procedures. Dispatcher procedure and training manuals must include these requirements (as applicable). This material must cover all aspects of the operator's RNP AR operations including the applicable authorisation. An individual must have completed the appropriate training course before engaging in RNP AR operations. Additionally, the dispatchers' training must address how to determine: RNP AR availability (considering aircraft equipment capabilities), MEL requirements, aircraft performance, and navigation signal availability (e.g. GPS RAIM/predictive RNP capability tool) for destination and alternate airports.

## **2 GROUND TRAINING SEGMENTS**

Ground training segments must address the following subjects as training modules in approved RNP AR academic training during the initial introduction of a crewmember to RNP AR systems and operations. For recurrent programmes, the curriculum need only review initial curriculum requirements and address new, revised, or emphasised items.

### **2.1 General Concepts of RNP AR Operation**

RNP AR academic training must cover RNP AR systems theory to the extent appropriate to ensure proper operational use. Flight crews must understand basic concepts of RNP AR systems operation, classifications, and limitations. The training must include general knowledge and operational application of RNP AR instrument approach procedures. This training module must address the following specific elements:

- a) Definitions of RNAV, RNAV (GPS), RNP, RNP AR, RAIM, and containment areas.
- b) The differences between RNAV and RNP.
- c) The types of RNP AR approach procedures and familiarity with the charting of these procedures.
- d) The programming and display of RNP and aircraft specific displays (e.g. Actual Navigation Performance).
- e) How to enable and disable the navigation updating modes related to RNP.
- f) RNP values appropriate for different phases of flight and RNP AR instrument procedures and how to select (if required).
- g) The use of GPS RAIM (or equivalent) forecasts and the effects of RAIM "holes" on RNP AR procedures (flight crew and dispatchers).
- h) When and how to terminate RNP navigation and transfer to traditional navigation due to loss of RNP and/or required equipment.
- i) How to determine if the FMC database is current and contains required navigational data.

- j) Explanation of the different components that contribute to the total system error and their characteristics (e.g. effect of temperature on BARO-VNAV, drift characteristics when using IRU with no radio updating, considerations in making suitable temperature corrections for altimeter systems).
- k) Temperature Compensation. Flight crews operating avionics systems with compensation for altimetry errors introduced by deviations from ISA may disregard the temperature limits on RNP AR procedures, if pilot training on use of the temperature compensation function is provided by the operator and the compensation function is utilised by the crew. However the training must also recognise the temperature compensation by the system is applicable to the VNAV guidance and is not a substitute for the flight crew compensating for the cold temperature effects on minimum altitudes or the decision altitude.
- l) The effect of wind on aircraft performance during RNP AR procedures and the need to positively remain within RNP containment area, including any operational wind limitation and aircraft configuration essential to safely complete an RNP AR procedure.
- m) The effect of groundspeed on compliance with RNP AR procedures and bank angle restrictions that may impact the ability to remain on the course centreline. For RNP procedures aircraft are expected to maintain the standard speeds associated with applicable category.
- n) Relationship between RNP and the appropriate approach minima line on an approved published RNP AR procedure and any operational limitations if the available RNP degrades or is not available prior to an approach (this should include flight crew procedures outside the FAF versus inside the FAF).
- o) Understanding alerts that may occur from the loading and use of improper RNP values for a desired segment of an RNP AR procedure.
- p) Understanding the performance requirement to couple the autopilot/flight director to the navigation system's lateral guidance on RNP AR procedures requiring an RNP of less than RNP 0.3.
- q) The events that trigger a missed approach when using the aircraft's RNP capability to complete an RNP AR procedure.
- r) Any bank angle restrictions or limitations on RNP AR procedures.
- s) Ensuring flight crews understand the performance issues associated with reversion to radio updating, know any limitations on the use of DME and VOR updating.

## 2.2 ATC Communication and Coordination for Use of RNP AR

Ground training must instruct the flight crews on proper flight plan classifications and any Air Traffic Control (ATC) procedures applicable to RNP AR operations. The flight crews must receive instruction on the need to advise ATC immediately when the performance of the aircraft's navigation system is no longer suitable to support continuation of an RNP AR procedure. Flight crews must also know what navigation sensors form the basis for their RNP AR compliance, and they must be able to assess the impact of failure of any avionics or a known loss of ground systems on the remainder of the flight plan.

### **2.3 RNP AR Equipment Components, Controls, Displays, and Alerts**

Academic training must include discussion of RNP terminology, symbology, operation, optional controls, and display features including any items unique to an operator's implementation or systems. The training must address applicable failure alerts and limitations. The flight crews and dispatchers should achieve a thorough understanding of the equipment used in RNP operations and any limitations on the use of the equipment during those operations.

### **2.4 AFM Information and Operating Procedures**

The AFM or other aircraft eligibility evidence must address normal and abnormal flight crew operating procedures, responses to failure alerts, and any limitations, including related information on RNP modes of operation. Training must also address contingency procedures for loss or degradation of RNP capability. The flight operations manuals approved for use by the flight crews (e.g. Flight Operations Manual (FOM) or Pilot Operating Handbook (POH)) should contain this information.

- a) Temporary Limitations on Minima. Where Operators are new to RNP operations and whose initial application is for RNP < 0.3, it is appropriate to establish a temporary limitation for minima consistent with RNP 0.3, until operational experience is gained. This period could be based upon time (i.e. 90 days) and/or number of conducted operations (e.g. 100 RNP approaches), as agreed upon by the regulator and operator.

### **2.5 MEL Operating Provisions**

Flight crews must have a thorough understanding of the MEL requirements supporting RNP AR operations.

## **3 FLIGHT TRAINING SEGMENTS**

In addition to the academic training, the flight crews must receive appropriate operational use training. Training programmes must cover the proper execution of RNP AR procedures in concert with the OEM's documentation. The operational training must include RNP AR procedures and limitations; standardisation of the set-up of the cockpit's electronic displays during an RNP AR procedure; recognition of the aural advisories, alerts and other annunciations that can impact compliance with an RNP AR procedure; and the timely and correct responses to loss of RNP AR capability in a variety of scenarios embracing the breadth of the RNP AR procedures the operator plans to complete. Such training may also use approved flight training devices or simulators. This training must address the following specific elements:

- a) Procedures for verifying that each pilot's altimeter has the current setting before beginning the final approach of an RNP AR procedure, including any operational limitations associated with the source(s) for the altimeter setting and the latency of checking and setting the altimeters for landing.
- b) Use of aircraft RADAR, TAWS, GPWS, or other avionics systems to support the flight crew's track monitoring and weather and obstacle avoidance.
- c) Concise and complete flight crew briefings for all RNP AR procedures and the important role Cockpit Resource Management (CRM) plays in successfully completing an RNP AR procedure.
- d) The importance of aircraft configuration to ensure the aircraft maintains any required speeds during RNP AR procedures.



- e) The potentially detrimental effect of reducing the flap setting, reducing the bank angle or increasing airspeeds may have on the ability to comply with an RNP AR procedure.
- f) Develop flight crew knowledge and skills necessary to properly conduct RNP AR operations (RNP AR Procedure Training).
- g) Ensure flight crews understand and are capable of programming and operating the FMC, autopilot, autothrottles, RADAR, GPS, INS, EFIS (including the moving map), and TAWS in support of RNP AR procedures.
- h) Handling of TOGA while in a turn.
- i) Monitoring of FTE and related go-around operation.
- j) Handling of loss of GPS during a procedure.
- k) Flight crew contingency procedures for a loss of RNP capability during a missed approach. Due to the lack of navigation guidance, the training should emphasise the flight crew contingency actions that achieve separation from terrain and obstacles. The operator should tailor these contingency procedures to their specific, approved AR procedures.
- l) As a minimum, each pilot must complete two RNP approach procedures that employ the unique AR characteristics of the operator's approved procedures (i.e., RF legs, RNP missed). One procedure must culminate in a transition to landing and one procedure must culminate in execution of an RNP missed approach procedure.

## **4 EVALUATION**

### **4.1 Initial Evaluation of RNP AR Knowledge and Procedures**

The operator must evaluate each individual flight crewmember on their knowledge of RNP AR procedures prior to employing RNP AR procedures. As a minimum, the review must include a thorough evaluation of pilot procedures and specific aircraft performance requirements for RNP AR operations. An acceptable means for this initial assessment includes one of the following:

- a) An evaluation by an examiner using an approved simulator or training device.
- b) An evaluation by an authorised instructor evaluator or check airman during line operations, training flights, PC/PT events, operating experience, route checks, and/or line checks.
- c) Line Oriented Flight Training (LOFT)/Line Oriented Evaluation (LOE). LOFT/LOE programmes using an approved simulator that incorporates RNP AR operations that employ the unique AR characteristics (i.e., RF legs, RNP missed) of the operator's approved procedures.

### **4.2 Specific elements that must be addressed in this evaluation module are:**

- a) Demonstrate the use of any RNP AR limits/minimums that may impact various RNP AR operations.
- b) Demonstrate the application of radio-updating procedures, such as enabling and disabling ground-based radio updating of the FMC (i.e., DME/DME and VOR/DME updating) and knowledge of when to use this feature. If the aircraft's avionics do not include the capability to disable radio updating, then the training must ensure the flight crew is able to accomplish the operational actions that mitigate the lack of this feature.

- c) Demonstrate the ability to monitor the actual lateral and vertical flight paths relative to programmed flight path and complete the appropriate flight crew procedures when exceeding a lateral or vertical FTE limit.
- d) Demonstrate the ability to read and adapt to a RAIM (or equivalent) forecast including forecasts predicting a lack of RAIM availability.
- e) Demonstrate the proper setup of the FMC, the weather RADAR, TAWS, and moving map for the various RNP AR operations and scenarios the operator plans to implement.
- f) Demonstrate the use of flight crew briefings and checklists for RNP AR operations with emphasis on CRM.
- g) Demonstrate knowledge of and ability to perform an RNP AR missed approach procedure in a variety of operational scenarios (i.e., loss of navigation or failure to acquire visual conditions).
- h) Demonstrate speed control during segments requiring speed restrictions to ensure compliance with an RNP AR procedure.
- i) Demonstrate competent use of RNP AR approach plates, briefing cards, and checklists.
- j) Demonstrate the ability to complete a stable RNP AR approach: bank angle, speed control, and remaining on the procedure's centreline.
- k) Know the operational limit for deviation below the desired flight path on an RNP AR approach and how to accurately monitor the aircraft's position relative to vertical flight path.

## **5 RECURRENT TRAINING OF RNP AR KNOWLEDGE AND PROCEDURES**

- 5.1 RNP AR Recurrent Training. The operator should incorporate recurrent RNP training that employs the unique AR characteristics of the operator's approved procedures as part of the overall programme.
- 5.2 A minimum of two RNP AR approaches must be flown by each pilot for each duty position (pilot flying and pilot monitoring), with one culminating in a landing and one culminating in a missed approach, and may be substituted for any required "precision-like" approach.

NOTE: Equivalent RNP approaches may be credited toward this requirement

[Amdt 20/5]

## Appendix 3 to AMC 20-26 RNP Operational Considerations

*ED Decision 2009/019/R*

### 1 GENERAL

This appendix provides an acceptable means to conduct of RNP operations where authorisation is required (AR). In addition, the operator must continue to ensure they comply with the general RNAV operating requirements; checking Notices to Airmen (NOTAMS), availability of Navigational Aids (NAVAID), airworthiness of aircraft systems, and aircrew qualification.

### 2 OPERATIONAL CONSIDERATIONS

- a) **Minimum Equipment List.** Operators minimum equipment list should be developed/revised to address the equipment requirements for RNP instrument approaches. Guidance for these equipment requirements is available from the aircraft manufacturer. The required equipment may depend on the intended navigation accuracy and whether or not the missed approach requires RNP less than 1.0. For example, GNSS and autopilot are typically required for small navigation accuracy. Dual equipment is typically required for approaches when using a line of minima less than RNP-0.3 and/or where the missed approach has an RNP less than 1.0. An operable Class A Terrain Awareness Warning System (TAWS) is required for all RNP AR approach procedures. It is recommended that the TAWS use altitude that is compensated for local pressure and temperature effects (e.g. corrected barometric and GNSS altitude), and include significant terrain and obstacle data. The flight crew must be cognisant of the required equipment.
- b) **Autopilot and Flight Director.** RNP procedures with RNP values less than RNP 0.3 or with RF legs require the use of autopilot or flight director driven by the RNAV system in all cases. Thus, the autopilot/flight director must operate with suitable accuracy to track the lateral and vertical paths required by a specific RNP AR approach procedure. When the dispatch of a flight is predicated on flying an RNP AR approach requiring the autopilot at the destination and/or alternate, the flight crew must determine that the autopilot is installed and operational.
- c) **Dispatch RNP Assessment.** The operator should have a predictive performance capability, which can determine whether or not the specified RNP will be available at the time and location of a desired RNP operation. This capability can be a ground service and need not be resident in the aircraft's avionics equipment. The operator should establish procedures requiring use of this capability as both a pre-flight dispatch tool and as a flight-following tool in the event of reported failures. The RNP assessment should consider the specific combination of the aircraft capability (sensors and integration), as well as their availability.
  - (1) **RNP assessment when GNSS updating.** This predictive capability must account for known and predicted outages of GNSS satellites or other impacts on the navigation system's sensors. The prediction programme should not use a mask angle below 5 degrees, as operational experience indicates that satellite signals at low elevations are not reliable. The prediction must use the actual GPS constellation with the (RAIM) (or equivalent) algorithm identical to that used in the actual equipment. For RNP AR approaches with high terrain, use a mask angle appropriate to the terrain.
  - (2) **Initially, RNP AR approach procedures require GNSS updating.**

- d) **NAVAID Exclusion.** The operator should establish procedures to exclude NAVAID facilities in accordance with NOTAMs (e.g. DMEs, VORs, localisers). Internal avionics reasonableness checks may not be adequate for RNP operations.
- e) **Navigation Database Currency.** During system initialisation, pilots of aircraft equipped with an RNP-certified system, must confirm that the navigation database is current. Navigation databases are expected to be current for the duration of the flight. If the AIRAC cycle will change during flight, operators and pilots must establish procedures to ensure the accuracy of navigation data, including suitability of navigation facilities used to define the routes and procedures for flight. Traditionally, this has been accomplished by verifying electronic data against paper products. One acceptable means is to compare aeronautical charts (new and old) to verify navigation fixes prior to dispatch. If an amended chart is published for the procedure, the database must not be used to conduct the operation.

### **3 FLIGHT CONSIDERATIONS**

- a) **Modification of Flight Plan.** Pilots should not be authorised to fly a published RNP procedure unless it is retrievable by the procedure name from the aircraft navigation database and conforms to the charted procedure. The lateral path must not be modified; with the exception of accepting a clearance to go direct to a fix in the approach procedure that is before the FAF and that does not immediately precede an RF leg. The only other acceptable modification to the loaded procedure is to change altitude and/or airspeed waypoint constraints on the initial, intermediate, or missed approach segments flight plan fixes (e.g. to apply cold temperature corrections or comply with an ATC clearance/instruction).
- b) **Required Equipment.** The flight crew should have either a required list of equipment for conducting RNP approaches or alternate methods to address in flight equipment failures that would prohibit RNP approaches (e.g. crew warning systems, quick reference handbook).
- c) **RNP Management.** The flight crew's operating procedures should ensure the navigation system uses the appropriate RNP values throughout the approach. If the navigation system does not extract and set the navigation accuracy from the on-board navigation database for each leg of the procedure, then the flight crew's operating procedures must ensure that the smallest navigation accuracy required to complete the approach or the missed approach is selected before initiating the approach (e.g. before the initial approach fix (IAF)). Different IAF's may have different navigation accuracy, which are annotated on the approach chart.
- d) **Loss of RNP** The flight crew must ensure that no loss of RNP annunciation is received prior to commencing the RNP AR approach. During the approach, if at any time a loss of RNP annunciation is received, the flight crew must abandon the RNP AR approach unless the pilot has in sight the visual references required to continue the approach.
- e) **Radio Updating.** Initiation of all RNP AR procedures is based on GNSS updating. Except where specifically designated on a procedure as Not Authorised, DME/DME updating can be used as a reversionary mode during the approach or missed approach when the system complies with the navigation accuracy. VOR updating is not authorised at this time. The flight crew must comply with the operator's procedures for inhibiting specific facilities.
- f) **Approach Procedure Confirmation.** The flight crew must confirm that the correct procedure has been selected. This process includes confirmation of the waypoint

sequence, reasonableness of track angles and distances, and any other parameters that can be altered by the flight crew, such as altitude or speed constraints. A procedure must not be used if validity of the navigation database is in doubt. A navigation system textual display or navigation map display must be used.

- g) Track Deviation Monitoring. The flight crew must use a lateral deviation indicator, flight director and/or autopilot in lateral navigation mode on RNP AR approach procedures. The flight crew of aircraft with a lateral deviation indicator must ensure that lateral deviation indicator scaling (full-scale deflection) is suitable for the navigation accuracy associated with the various segments of the RNP AR approach procedure. All flight crew are expected to maintain procedure centrelines, as depicted by onboard lateral deviation indicators and/or flight guidance during all RNP operations described in this manual unless authorised to deviate by ATC or under emergency conditions. For normal operations, cross-track error/deviation (the difference between the RNP system computed path and the aircraft position relative to the path) should be limited to the navigation accuracy (RNP) associated with the procedure segment.

Vertical deviation should be monitored above and below the glide-path; The vertical deviation must be within  $\pm 75$  feet of the glide-path during the final approach segment.

Flight crew must execute a Missed Approach if the lateral deviation exceeds  $1 \times \text{RNP}$  or the vertical deviation exceeds 75 feet, unless the pilot has in sight the visual references required to continue the approach.

- (1) Where a moving map, low-resolution vertical deviation indicator (VDI), or numeric display of deviations are to be used, flight crew training and procedures must ensure the effectiveness of these displays. Typically, this involves demonstration of the procedure with a number of trained crews and inclusion of this monitoring procedure in the recurrent RNP AR approach training programme.
  - (2) For installations that use a CDI for lateral path tracking, the aircraft flight manual (AFM) or aircraft qualification guidance should state which navigation accuracy and operations the aircraft supports and the operational effects on the CDI scale. The flight crew must know the CDI full-scale deflection value. The avionics may automatically set the CDI scale (dependent on phase of flight) or the flight crew may manually set the scale. If the flight crew manually selects the CDI scale, the operator must have procedures and training in place to assure the selected CDI scale is appropriate for the intended RNP operation. The deviation limit must be readily apparent given the scale (e.g. full-scale deflection).
- h) System Cross-check. For approaches with RNP value less than RNP 0.3, the flight crew should ensure the lateral and vertical guidance provided by the navigation system is consistent with other available data and displays provided by an independent means.
- Note: This cross-check may not be necessary if the lateral and vertical guidance systems have been developed and/or evaluated consistent with extremely remote failure conditions and if the normal system performance supports  $1 \times \text{RNP}$  containment.
- i) Procedures with RF Legs. An RNP procedure may require the ability to execute an RF leg to avoid terrain or obstacles. As not all aircraft have this capability, flight crews should be aware of whether or not they can conduct these procedures.
- (1) If initiating a go-around during or shortly after the RF leg, the flight crew must be aware of the importance of maintaining the published path as closely as possible.

Operational procedures are required for aircraft that do not stay in LNAV when a go-around is initiated to ensure the RNP AR APCH ground track is maintained.

- (2) Pilots must not exceed the maximum airspeeds shown in Table 1 throughout the RF leg segment. For example, a Category C A320 must slow to 160 KIAS at the FAF or may fly as fast as 185 KIAS if using Category D minima. A missed approach prior to DA may require the segment speed for that segment be maintained.

**Table 1: Maximum Airspeed by Segment and Category**

Segment	Indicated Airspeed (Knots)				
	Indicated Airspeed by Aircraft Category				
	Cat A	Cat B	Cat C	Cat D	Cat E
Initial & Intermediate (IAF to FAF)	150	180	240	250	250
Final (FAF to DA)	100	130	160	185	As Specified
Missed Approach (DA to MAHP)	110	150	240	265	As Specified
Airspeed Restriction*	As Specified				

\*Airspeed restrictions may be used to reduce turn radius regardless of aircraft category.

- j) **Temperature Compensation.** For aircraft with temperature compensation, flight crews may disregard the temperature limits on RNP procedures if the operator provides pilot training on the use of the temperature compensation function. Temperature compensation by the system is applicable to the VNAV guidance and is not a substitute for the flight crew compensating for the cold temperature effects on minimum altitudes or the decision altitude. Flight crews should be familiar with the effects of the temperature compensation on intercepting the compensated path described in EUROCAE ED-75B/RTCA DO-236B Appendix H.
- k) **Altimeter Setting.** Due to the performance based obstruction clearance inherent in RNP instrument procedures, the flight crew should verify the most current airport altimeter is set prior to the final approach fix (FAF). Operators should take precautions to switch altimeter settings at appropriate times or locations and request a current altimeter setting if the reported setting may not be recent, particularly at times when pressure is reported or is expected to be rapidly decreasing. Execution of an RNP instrument procedure requires the current altimeter setting for the airport of intended landing. Remote altimeter settings are not allowed.
- l) **Altimeter Cross-check.** The flight crew should complete an altimetry crosscheck ensuring both pilots' altimeters agree within  $\pm 100$  feet prior to the final approach fix (FAF) but no earlier than when the altimeters are set for the airport of intended landing. If the altimetry cross-check fails then the procedure must not be continued.  
  
Note: This operational cross-check is not necessary if the aircraft systems automatically compare the altitudes to within 75 feet.
- m) **Go-Around or Missed Approach.** Where possible, the missed approach will require RNP 1.0. The missed approach portion of these procedures is similar to a missed approach of an RNP APCH procedure. Where necessary, navigation accuracy less than RNP 1.0 will be used in the missed approach. To be approved to conduct these approaches, equipment and procedures must meet criteria in paragraph 7, Table 2 (Requirements for Approaches with Missed Approach less than RNP 1.0).

- (1) In many aircraft when executing a go-around or missed approach activating Take-off/Go-around (TOGA) may cause a change in lateral navigation. In many aircraft, activating TOGA disengages the autopilot and flight director from LNAV guidance, and the flight director reverts to track-hold derived from the inertial system. LNAV guidance to the autopilot and flight director should be re-engaged as quickly as possible.
  - (2) The flight crew procedures and training must address the impact on navigation capability and flight guidance if the pilot initiates a go-around while the aircraft is in a turn. When initiating an early go-around, the flight crew should follow the rest of the approach track and missed approach track unless issued a different clearance by ATC. The flight crew should also be aware that RF legs are designed based on the maximum true airspeed at normal altitudes, and initiating an early go-around will reduce the manoeuvrability margin and potentially even make holding the turn impractical at missed approach speeds.
  - (3) Upon loss of GNSS updates, the RNAV guidance may begin to “coast” on IRU, if installed, and drift, degrading the navigation position solution. Thus, when the RNP AR APCH missed approach operations rely on IRU “coasting” the inertial guidance can only provide acceptable navigation performance for a specified amount of time.
- n) Contingency Procedures
- (1) Failure while En Route. The aircraft RNP capability is dependent on operational aircraft equipment and GNSS satellites. The flight crew should be able to assess the impact of equipment failure on the anticipated RNP approach and take appropriate action.
  - (2) Failure on Approach. The operator’s contingency procedures should address at least the following conditions:
    - a) Failure of the RNP system components, including those affecting lateral and vertical deviation performance (e.g. failures of a GPS sensor, the flight director or automatic pilot)
    - b) Loss of navigation signal-in-space (loss or degradation of external signal)
- o) Engine-Out Procedures. Aircraft may demonstrate acceptable flight technical error with one engine inoperative to conduct RNP AR operations. Otherwise, flight crews are expected to take appropriate action in event of engine failure during an approach so that no specific aircraft qualification is required. The aircraft qualification should identify any performance limits in event of engine failure to support definition of appropriate flight crew procedures.

[Amdt 20/5]

## Appendix 4 to AMC 20-26 Acceptable Methods for Flight Technical Error Assessment for RNP

*ED Decision 2009/019/R*

This appendix outlines criteria for assessment of "Flight Technical Error" (FTE) related to RNP capability and other navigation applications (e.g. instrument approach capability, etc.). These criteria are available for use for FMS/EFIS based applications, RNP applications, or other navigation applications related to this AMC or as otherwise determined to be acceptable by the appropriate regulatory authority. It may be used in lieu of FTE assumptions referenced in other Advisory Circulars.

### 1 BACKGROUND

For RNP of 0.3 NM or greater, industry standard default values for FTE e.g. RTCA DO-208, AC20-130, etc are used and present a convenience to an operator or applicant in enabling a quick determination of what combinations of systems, capabilities, features and performance are allowable for the conduct of operations. However, the default value is the dominant error as RNP values are reduced below 0.3 NM. As a result, use of the standard defaults limit the extent that a system may be utilised, i.e. for RNP 0.15 an FTE of 0.125 NM is assumed when coupled to an autopilot. For RNP less than 0.15 NM, the standard FTE values are insufficient such that an aircraft may not be used even with a precision source such as GNSS, until there is a reduction in FTE.

FTE estimates or assumptions are typically added to navigation system error characteristics to permit specification of "protected airspace" for obstacle clearance or aircraft-to-aircraft separation (using various mathematical statistical methods such as "Root Sum Squared"). Protected airspace may pertain to procedure obstacle clearance surfaces, establishing route or airway widths, setting oceanic track separation values, definition of ICAO Obstacle Clearance Limits, or other similar applications.

Previous FTE assessments were based on very limited samples of normal performance of a population of aircraft that included "worst case aircraft types and least capable systems" and is not representative of modern, advanced aircraft. This penalises, or does not appropriately credit, modern systems which have resulted in improved FTE performance.

Further, some assessments of FTE usually consider only "normal performance", and do not appropriately assess path displacements for "rare normal performance" (e.g. strong winds), or "non-normal performance" (e.g. flight path performance related to failures - engine failure while on RF turn, extraction, etc).

### 2 OBJECTIVES

A major element of aircraft and navigation system performance assessment is the proper characterisation of FTE. This appendix provides uniform criteria for assessing FTE to be used in conjunction with AC120-29A, and other relevant regulatory and industry references.

This FTE method:

- a) Establishes FTE for modern aircraft in a way that provides improved pilot situation information over that provided in previous generation aircraft,
- b) Comprehensively considers the factors which affect FTE,
- c) Establishes a means to provide credit to an aircraft and navigation system design which includes features which provide for significantly reduced FTE,



- d) Permits improved partitioning of the application and use of FTE between airworthiness assessment, operational authorisation, and procedure development and implementation (e.g. for definition of RNP routes, use of PANS-OPS or TERPS applications etc.),
- e) Provides operational incentives, and consequential design incentives for good FTE performance,
- f) Allows proactive rather than reactive applications (e.g. eliminate the need for lengthy and costly in service data collection)
- g) Properly addresses "real" safety factors related to functional hazard assessments,
- h) Establishes consistent application with the desired navigation evolution to RNP, 4D, MASPS, etc.
- i) Permits the eventual introduction of new methods of risk assessment (i.e. performance based design) as alternatives to the traditional, conservative methods such as "Collision Risk Model (CRM)", and
- j) Facilitates the transition to GPS, GNSS, and other modern navigation techniques.

### **3 CRITERIA**

The criteria in the following sections provide a means for applicants to demonstrate improved FTE performance which may be used in lieu of previous standard FTE assumptions that may not be appropriate for certain modern aircraft and systems.

Items in section 4 address FTE demonstration criteria. Items in section 5 address acceptable methods for data collection and presentation of results.

### **4 FTE Demonstration Criteria**

#### **a) USE OF REALISTIC TASKS**

Tasks selected should address relevant flight phases applicable to the FTE measurements sought (e.g. takeoff, climb, cruise, descent, approach, landing, and missed approach.). Tasks should be realistic in providing appropriate lateral, vertical, and longitudinal elements, even though capability in only one or several dimensions is being assessed. Realistic and representative procedures should be used (e.g., number of waypoints, placement of waypoints, segment geometry, leg types, etc.).

#### **b) REPRESENTATIVE TEST METHODS AND TEST SUBJECTS**

##### **(1) TEST METHODS**

An acceptable combination of analysis, simulation, and flight verification should be used to establish alternative FTE performance. A plan acceptable to the appropriate regulatory authority should be provided by the applicant prior to testing.

##### **(2) TEST SUBJECTS**

Test crews should represent an appropriate mix of flight experience, currency, and qualification (Captain, F/O, etc.).

#### **c) PERFORMANCE ASSESSMENT**

Normal performance (straight and turning flight), Rare Normal Performance (e.g. strong winds and wind gradient effects), and Non-Normal Performance (e.g. engine failure, remote and extremely remote effects) should each be considered. Functional hazard assessments should be the basis for deciding how to assess non-normal performance.

Characterisation of performance should address "95%" and "limit performance" for a suitable sample size. Emphasis should be on practical and realistic flight scenarios rather than on rigorous statistical demonstrations that may not be representative of "in service" conditions.

Successful demonstration of procedures intended for terminal area applications (e.g. approach, missed approach) may generally be considered to also cover en-route applications.

Note: Probable failures are in accordance with AMC 25-1309, and  $10^{-5}$  per operation.

The demonstration of Flight Technical Error must be completed in a variety of operational conditions; rare-normal conditions and non-normal conditions. This should be documented in the appropriate aircraft operational support document. Realistic and representative procedures should be used (e.g. Number of waypoints, placement of waypoints, segment geometry, leg types, wind etc.). The non-normal assessment should consider the following:

- (1) Acceptable criteria to be used for assessing probable failures and engine failure during the aircraft qualification is to demonstrate that the aircraft trajectory is maintained within a 1xRNP corridor laterally and 75 feet vertically.
- (2) Acceptable criteria to be used for assessing remote failures during the aircraft qualification is to demonstrate that the aircraft trajectory is maintained within a 2xRNP corridor laterally and 75 feet vertically.
- (3) Extremely remote failure cases should be assessed to show that under these conditions the aircraft can be safely extracted from the procedure. Failure cases might include dual system resets, flight control surface runaway and complete loss of flight guidance function while in NAV.
- (4) The aircraft performance demonstration during the operational evaluations can be based on a mix of analysis and flight technical evaluation using expert judgment.

RNP AR procedures with navigation accuracy less than RNP 0.3 or with RF legs require the use of autopilot or flight director driven by the RNAV system in all cases. Thus, the autopilot/flight director must operate with suitable accuracy to track the lateral and vertical paths required by a specific RNP AR approach procedure.

d) **REFERENCE PATH SELECTION**

For FTE assessments a nominal path may be used (magenta line) that does not include consideration of specific navigation sensor/system anomalies (e.g. DME updating anomaly characteristics etc.). The applicant should, however, indicate how any FTE effects related to navigation system anomalies, if any, should be operationally addressed.

## **5 PARAMETERS TO BE MEASURED AND PRESENTATION OF RESULTS**

a) **FTE ASSESSMENT PARAMETER MEASUREMENT**

Parameters measured should include:

- (1) Pertinent lateral and vertical path displacements,
- (2) Longitudinal performance as applicable (speed errors, ETA/RTA errors, etc.),
- (3) Other parameters as necessary to assure realistic operational performance (bank angles, pitch attitudes, thrust changes, track/heading variation, G loading, etc.).

b) **FTE ASSESSMENT METHODS**

Unless otherwise agreed by the regulator, demonstrations should be based on appropriate simulations, and be verified by flight trials.

c) **FTE ASSESSMENT RESULT PRESENTATION**

Data may be presented in various AFM provisions related to demonstrated performance for levels of "RNP", instrument approach and landing capability, etc.

**6 EXAMPLES OF REGULATORY RESPONSIBILITY FOR ASSESSMENT OF FTE AND USE OF FTE EVALUATION RESULTS**

The Agency will:

- a) typically conduct assessments of FTE in conjunction with Type Certification/Supplemental Type Certification (TC/STC) projects, when a TC/STC applicant has made such a request. Special circumstances may exist where assessments acceptable to the Agency will be conducted by other organisations (FAA, etc.),
- b) participate in FTE assessments in conjunction with aircraft certification projects, and assure that appropriate flight standardisation provisions are identified,
- c) assure proper application of FTE as specified in AFMs for particular applications (e.g. RNP authorisations),
- d) address crew qualification requirements necessary to achieve the intended FTE performance.

**7 FTE ASSESSMENT PROCESS**

Applicants apply through normal channels to the Agency. The Agency will evaluate the application for applicable criteria and specific evaluation plans.

[Amdt 20/5]

## Appendix 5 to AMC 20-26 Flight Operation Safety Assessments

*ED Decision 2009/019/R*

### 1 SAFETY ASSESSMENT

The safety objective for RNP AR operations is to provide for safe flight operations. Traditionally, operational safety has been defined by a target level of safety and specified as a risk of collision of  $10^{-7}$  per approach. For RNP AR approaches a flight operational safety assessment (FOSA) methodology may be used. The FOSA is intended to provide a level of flight safety that is equivalent to the traditional TLS, but using methodology oriented to performance-based flight operations. Using the FOSA, the operational safety objective is met by considering more than the aircraft navigation system alone. The FOSA blends quantitative and qualitative analyses and assessments for navigation systems, aircraft systems, operational procedures, hazards, failure mitigations, normal, rare-normal and abnormal conditions, hazards, and the operational environment. The FOSA relies on the detailed criteria for aircraft qualification, operator approval and instrument procedure design to address the majority of general technical, procedure and process factors. Additionally, technical and operational expertise and experience are essential to the conduct and conclusion of the FOSA.

An overview of the hazards and mitigations is provided to assist States in applying these criteria. Safety of RNP AR approach operations rests with the operator and the air navigation service provider as described in this chapter.

A FOSA should be conducted for each RNP AR approach procedure where more stringent aspects of the nominal procedure design criteria are applied (e.g. RNP 0.1 missed approach, RF legs, and RNP missed approaches less than 1.0) or where the application of the default procedure design criteria is in an operating environment with special challenges or demands to ensure that for each specific set of operating conditions, aircraft, and environment that all failure conditions are assessed and where necessary mitigations implemented to meet the operational safety objective. The assessment should give proper attention to the inter-dependence of the elements of design, aircraft capability, crew procedures and operating environment.

The following hazard conditions are examples of some of the more significant hazards and mitigations addressed in the aircraft, operational and procedure criteria:

**Normal performance:** Lateral and vertical accuracy are addressed in the aircraft requirements, aircraft and systems operate normally in standard configurations and operating modes, and individual error components are monitored/truncated through system design or crew procedure.

**Rare-Normal and Abnormal Performance:** Lateral and vertical accuracy are evaluated for aircraft failures as part of the determination of aircraft qualification. Additionally, other rare-normal and abnormal failures and conditions for ATC operations, crew procedures, infrastructure and operating environment are also assessed. Where the failure or condition results are not acceptable for continued operation, mitigations are developed or limitations established for the aircraft, crew and/or operation.

### 2 AIRCRAFT FAILURES

- a) **System Failure:** Failure of a navigation system, flight guidance system, flight instrument system for the approach, or missed approach (e.g. loss of GNSS updating, receiver failure, autopilot disconnect, FMS failure etc.). Depending on the aircraft, this may be addressed through aircraft design or operational procedure to cross-check guidance (e.g. dual equipage for lateral errors, use of terrain awareness and warning system).

- b) Malfunction of air data system or altimetry: Crew procedure cross-check between two independent systems mitigates this risk.

### **3 AIRCRAFT PERFORMANCE**

- a) Inadequate performance to conduct the approach: the aircraft qualification and operational procedures ensure the performance is adequate on each approach, as part of flight planning and in order to begin or continue the approach. Consideration should be given to aircraft configuration during approach and any configuration changes associated with a go-around (e.g. engine failure, flap retraction, re-engagement of LNAV mode).
- b) Loss of engine: Loss of an engine while on an RNP AR approach is a rare occurrence due to high engine reliability and the short exposure time. Operators will take appropriate action to mitigate the effects of loss of engine, initiating a go-around and manually taking control of the aircraft if necessary.

### **4 NAVIGATION SERVICES**

- a) Use of a navigation aid outside of designated coverage or in test mode: Aircraft requirements and operational procedures have been developed to address this risk.
- b) Navigation database errors: Procedures are validated through flight validation specific to the operator and aircraft, and the operator is required to have a process defined to maintain validated data through updates to the navigation database.

### **5 ATC OPERATIONS**

- a) Procedure assigned to incapable aircraft: Operators are responsible for declining the clearance.
- b) ATC vectors aircraft onto approach such that performance cannot be achieved: ATC training and procedures must ensure obstacle clearance until aircraft is established on the procedure, and ATC should not intercept on or just prior to a curved segments of the procedure.

### **6 FLIGHT CREW OPERATIONS**

- a) Erroneous barometric altimeter setting: Crew entry and cross-check procedures mitigate this risk.
- b) Incorrect procedure selection or loading: crew procedure to verify loaded procedure matches published procedure, aircraft requirement for map display.
- c) Incorrect flight control mode selected: training on importance of flight control mode, independent procedure to monitor for excessive path deviation.
- d) Incorrect RNP entry: crew procedure to verify RNP loaded in system matches the published value.
- e) Go-Around/Missed Approach: Balked landing or rejected landing at or below DA (H).
- f) Poor meteorological conditions: Loss or significant reduction of visual reference that may result in or require a go-around.

### **7 INFRASTRUCTURE**

- a) GNSS satellite failure: This condition is evaluated during aircraft qualification to ensure obstacle clearance can be maintained, considering the low likelihood of this failure occurring.

- b) Loss of GNSS signals: Relevant independent equipage (e.g. IRU) is required for RNP AR approaches with RF legs and approaches where the accuracy for the missed approach is less than 1 NM. For other approaches, operational procedures are used to approximate the published track and climb above obstacles.
- c) Testing of ground Navaid in the vicinity of the approach: Aircraft and operational procedures are required to detect and mitigate this event.

## **8 OPERATING CONDITIONS**

- a) Tailwind conditions: Excessive speed on RF legs will result in inability to maintain track. This is addressed through aircraft requirements on the limits of command guidance, inclusion of 5 degrees of bank manoeuvrability margin, consideration of speed effect and crew procedure to maintain speeds below the maximum authorised.
- b) Wind conditions and effect on flight technical error: nominal flight technical error is evaluated under a variety of wind conditions, and crew procedures to monitor and limit deviations ensure safe operation.
- c) Extreme temperature effects of barometric altitude (e.g. extreme cold temperatures, known local atmospheric or weather phenomena, high winds, severe turbulence etc.): The effect of this error on the vertical path is mitigated through the procedure design and crew procedures, with an allowance for aircraft that compensate for this effect to conduct procedures regardless of the published temperature limit. The effect of this error on minimum segment altitudes and the decision altitude are addressed in an equivalent manner to all other approach operations.

[Amdt 20/5]

## Appendix 6 AMC 20-26/PBN Manual/AC90-101 Comparison

ED Decision 2009/019/R

This appendix contains a comparison of this AMC relative to the ICAO Performance Based Navigation Manual and the US AC90-101. In general, the AC is the same as the PBN Manual Navigation Specification for RNP AR APCH. The AMC contains some differences that are noted as follows.

The matrix does not highlight the unique requirements introduced by AC 90-101 and not contained within this AMC.

Regular = Same/Comparable

Italic = areas where AMC provides additional information, guidance or criteria

ALL CAP = areas where PBN Manual is more extensive

Bold = areas where AMC is more stringent than PBN Manual and/or AC90-101 criteria

Section	AMC 20-26	Para	PBN Vol II, Chap 6	Section	AC90-101	Comment
1	Preamble					NC
1.2	Purpose	6.1.2	Purpose	1	Purpose	NC
1.2	Background	--	--	--	--	NC
2	Scope	--	--	--	--	NC
3	Reference Documents	--	--	4	Related Documents	NC
3.1	Related Requirements	--	--	--	--	NC
3.2	Related Material	--	--	2	Related CFR Sections	NC
3.2.1	ICAO	--	--	--	--	NC
3.2.2	EASA	--	--	--	--	NC
3.2.3	Eurocontrol	--	--	--	--	NC
3.2.4	FAA	--	--			NC
3.2.5	ETSO	--	--			NC
3.2.6	EUROCAE /RTCA, ARINC	--	--	--	--	NC
4	Assumptions	6.2	ANSP Considerations	--	--	AMC expands assumptions for procedure design, infrastructure, publication, status monitoring, controller training, flight evaluation.
5	System Description	--	--	--	--	NC
5.1	LNAV			--	--	NC
5.1.1		--	--	--	--	AMC descriptive info
5.1.2	Position Determination and Sensors	6.3.3.2	Criteria for Specific Navigation Services	App 2, 3.a	Position Estimation	AMC has more explicit description, PBN implies more
5.2	VNAV	--	--	--	--	AMC provides descriptive info

Section	AMC 20-26	Para	PBN Vol II, Chap 6	Section	AC90-101	Comment
5.2.2	Temperature Compensation Systems	6.3.3.2	Criteria for Specific Navigation Services, Temperature Compensation Systems	App 2, 3.a(7)	Temperature Compensation Systems	Same
6	Airworthiness Certification Objectives	--	--	--	--	AMC ties criteria to assumptions
6.1	Accuracy	6.3.3.1	System Performance, Monitoring and Alerting, Path Definition	App 2, 2.a	Path Definition	Same
6.1.1	Lateral	6.3.3.1	System Performance, Monitoring and Alerting, Lateral Accuracy	App 2, 2.b	Lateral Accuracy	More notes of clarification and expanded considerations
6.1.2	Vertical	6.3.3.1	System Performance, Monitoring and Alerting, Airspace Containment	App 2, 2.c	Vertical Accuracy	More notes of clarification and expanded considerations
6.1.2	Vertical	6.3.3.2	Criteria for Specific Navigation Services, Altimetry System Error	App 2, 3.a(6)	99.7% ASE	Same
6.1.3	RNP System Performance	6.3.3.3	Functional Requirements, Demonstration of Path Steering Performance	App 2, 3.c	Path Steering Performance	AMC has More Stringent Requirements
6.2	Integrity	--	--	--	--	--
6.2.1, a)	System	6.3.3.1	System Performance, Monitoring and Alerting, Airspace Containment	App 2, 2.d(1)	RNP and BARO-VNAV	Same
6.2.1, b)	System	6.3.3.1	System Performance, Monitoring and Alerting, Airspace Containment	App 2, 2.d(2)	Other Systems or Alternate Means of Compliance	Same
6.2.2	Display	6.3.3.3	Functional Requirements, Design Assurance	App 2, 3.e	Design Assurance	Same
6.3	Continuity	--	--	--	--	AMC contains explicit requirements. AC



Section	AMC 20-26	Para	PBN Vol II, Chap 6	Section	AC90-101	Comment
						requirement is implied through airspace containment and predetermined through MEL requirements
7	Functional Criteria			--	--	NC
7.1, 1	Lateral/Vertical Deviation	6.3.3.3	Functional Requirements, Displays	App 2, 3.d(1)	Lateral/Vertical Deviation	Same
7.1, 1	For RNP < 0.3, Fixed CDI or Scaled to RNP	6.3.3.3	Functional Requirements, Displays	App 2, 3.d(1)(a)		Unique to AMC
7.1, 1	For RNP < 0.3, Fixed CDI or Scaled to RNP	6.3.3.3	Functional Requirements, Displays	App 2, 3.d(1)(b)		Unique to AMC
7.1, 1	Navigation Map display alternative	6.3.3.3	Functional Requirements, Displays	App 4, 3.g(1)	Moving map, VDI or numeric display of deviation	Same
7.1, 2	Identification of the Active (To) Waypoint.	6.3.3.3	Functional Requirements, Displays	App 2, 3.d(2)	Identification of the Active (To) Waypoint.	Same
7.1, 3	Display of Distance and Bearing.	6.3.3.3	Functional Requirements, Displays	App 2, 3.d(3)	Display of Distance and Bearing.	Same
7.1, 4	Display of Groundspeed or Time	6.3.3.3	Functional Requirements, Displays	App 2, 3.d(4)	Display of Groundspeed or Time	Same
7.1, 5	Display of To/From the active fix.	6.3.3.3	Functional Requirements, Displays	App 2, 3.d(5)	Display of To/From the active fix.	Same
7.1, 6	Desired Track Display	6.3.3.3	Functional Requirements, Displays	App 2, 3.d(6)	Desired Track Display	Same
7.1, 7	Display of Aircraft Track.	6.3.3.3	Functional Requirements, Displays	App 2, 3.d(7)	Display of Aircraft Track.	Same
7.1, 8	Slaved Course Selector	6.3.3.3	Functional Requirements, Displays	App 2, 3.d(9)	Slaved Course Selector	Same
7.1, 9	RNAV Path Display	6.3.3.3	Functional Requirements, Displays	App 2, 3.d(10)	RNAV Path Display	Same
7.1, 10	Display of Distance to Go.	6.3.3.3	Functional Requirements, Displays	App 2, 3.d(11)	Display of Distance to Go.	Same

Section	AMC 20-26	Para	PBN Vol II, Chap 6	Section	AC90-101	Comment
7.1, 11	Display of Distance Between Flight Plan Waypoints.	6.3.3.3	Functional Requirements, Displays	App 2, 3.d(12)	Display of Distance Between Flight Plan Waypoints.	Same
7.1, 12	Display of Barometric Altitude	6.3.3.3	Functional Requirements, Displays	App 2, 3.d(14)	Display of Barometric Altitude	Same
7.1, 13	Display of Active Sensors	6.3.3.3	Functional Requirements, Displays	App 2, 3.d(15)	Display of Active Sensors	Same
7.1, 14	Navigation Performance	6.3.3.1	System Performance, Monitoring and Alerting	App 2, 2.e	System Monitoring.	AMC provides additional guidance for vertical
7.1, 15	Multi-Sensor Systems	6.3.3.2	Criteria for Specific Navigation Services	App 2, 3.a(5)	Multi-Sensor Systems	Same
7.1, 16	Auto tuning of DME	--	--	--	--	More explicit guidance for reversion capability in AMC. PBN/AC implies through position estimation criteria for DME
7.1, 17	Auto selection/ de-selection of navigation sources	--	--	--	--	More explicit guidance in AMC. PBN/AC are implies through position estimation criteria
7.1, 18	Failure Annunciation	6.3.3.3	Functional Requirements, Displays	App 2, 3.d(8)	Failure Annunciation	Same
7.1, 19	Navigation Database Status	6.3.3.3	Functional Requirements, Displays	App 2, 3.f(3)	Display the Validity Period	Same
7.1, 20	Maintain Track and Leg Transitions	6.3.3.3	Functional Requirements, Path Definition and Flight Planning	App 2, 3.b(1)	Maintain Track and Leg Transitions	less stringent
7.1, 21	Fly-by and Fly-over Fixes	6.3.3.3	Functional Requirements, Path Definition & Flight Planning	App 2, 3.b(2)	Fly-by and Fly-over Fixes	Same
7.1, 22	Waypoint Resolution Error	6.3.3.3	Functional Requirements, Path Definition & Flight Planning	App 2, 3.b(3)	Waypoint Resolution Error	Same

Section	AMC 20-26	Para	PBN Vol II, Chap 6	Section	AC90-101	Comment
7.1, 23	Capability for a "Direct-To" Function	6.3.3.3	Functional Requirements, Path Definition & Flight Planning	App 2, 3.b(4)	Capability for a "Direct-To" Function	AMC contains additional guidance for VNAV, not in AC
7.1, 24	Capability to define a vertical path	6.3.3.3	Functional Requirements, Path Definition & Flight Planning	App 2, 3.b(5)	Capability to define a vertical path	Same
7.1, 25	Altitudes and/or Speeds	6.3.3.3	Functional Requirements, Path Definition & Flight Planning	App 2, 3.b(6)	Altitudes and/or Speeds	Same
7.1, 26	Construct a Path	6.3.3.3	Functional Requirements, Path Definition & Flight Planning	App 2, 3.b(7)	Construct a Path	Same
7.1, 27	Capacity to Load Procedures from the Navigation Database.	6.3.3.3	Functional Requirements, Path Definition & Flight Planning	App 2, 3.b(8)	Capacity to Load Procedures from the Navigation Database.	Same
7.1, 28	Means to Retrieve and Display Navigation Data.	6.3.3.3	Functional Requirements, Path Definition & Flight Planning	App 2, 3.b(9)	Means to Retrieve and Display Navigation Data.	Same
7.1, 29	Magnetic Variation	6.3.3.3	Functional Requirements, Path Definition & Flight Planning	App 2, 3.b(10)	Magnetic Variation	Same
7.1, 30	Changes in Navigation Accuracy	6.3.3.3	Functional Requirements, Path Definition & Flight Planning	App 2, 3.b(11)	Changes in RNP Value	Same
7.1, 31	Automatic Leg Sequencing.	6.3.3.3	Functional Requirements, Path Definition & Flight Planning	App 2, 3.b(12)	Automatic Leg Sequencing.	Same
7.1, 32	Display of Altitude Restrictions	6.3.3.3	Functional Requirements, Path Definition & Flight Planning	App 2, 3.b(13)	Display of Altitude Restrictions	Same
7.1, 33	Navigation Database	6.3.3.3	Functional Requirements	App 2, 3.f(1)	Navigation Database	Same
7.1, 33	Navigation Database	6.3.3.3	Functional Requirements	App 2, 3.f(2)	Database Protection	Same
7.2, 1	Where RNP AR operations use RF Legs	6.3.3.3	Functional Requirements, Requirements for RNP AR	App 2, 4	Requirements for RNP SAAAR Approaches with RF Legs	Conditional requirements tied to RF, RNP less than procedure defaults for

Section	AMC 20-26	Para	PBN Vol II, Chap 6	Section	AC90-101	Comment
			Approaches with RF Legs			approach and missed approach.
7.2, 2	Where RNP AR operations are less than RNP 0.3	6.3.3.3	Functional Requirements, Requirements for RNP AR Approaches to less than RNP 0.3	App 2, 5	Requirements for Using Lines of Minima less than RNP 0.3	AMC is more stringent by removing the alternative for when aircraft lacks continuous LNAV capability
7.2, 3	Where Missed Approach are less than RNP 1.0	6.3.3.3	Functional Requirements, Requirements for Approaches with Missed Approach less than RNP 1.0	App 2, 6	Requirements for Approaches with Missed Approach less than RNP 1.0	AMC is more stringent by removing the alternative for when aircraft lacks continuous LNAV capability
8	Airworthiness Compliance	--	--	--	--	NC
8.1	General	6.3.2	Approval Process	6.a	Overview	Comparable
8.1.1 (a)	New or Modified Installations – Compliance Statement	6.3.2	Approval Process	6.b(1)	Aircraft Qualification Documentation	Comparable
8.1.1 (b)(1)	Design data to support compliance	6.3.2	Approval Process	6.b(1)	Aircraft Qualification Documentation	Comparable
8.1.1 (b)(2)	Risk of flight crew error	6.3.4	Operating Procedures, Track Deviation Monitoring	App 4, 3.g	Track Deviation Monitoring	PBN Manual/AC provide more explicit guidance
8.1.1 (b)(3)	Equipment failures and reversion	6.3.4	Operating Procedures, Contingency Procedures	App 4, 3.p	Contingency Procedures	Comparable
8.1.1 (b)(4)	Coupling arrangements	6.3.4	Operating Procedures, Autopilot & Flight Director	App 4, 2.b	Autopilot & Flight Director	Comparable
8.1.1 (b)(5)	Intercepting CF	--	--	--	--	AMC is more explicit for this condition
8.1.1 (b)(6)	MEL & maintenance	6.3.2.2 .4	MEL Considerations	App 4, 2.a	MEL	Comparable
8.1.2	Existing Installations	--	--	--	--	AMC unique
8.2	Database Integrity	6.3.6	Navigation Database	6.b(2)	RNP SAAAR Operational Documentation	Same
8.3	Use of GPS	6.3.3.2	Criteria for Specific	App 2, 3.a(1)	GPS	Same

Section	AMC 20-26	Para	PBN Vol II, Chap 6	Section	AC90-101	Comment
			Navigation Services			
8.4	Use of IRS	6.3.3.2	Criteria for Specific Navigation Services	App 2, 3.a(2)	IRS	Same
8.5	Use of DME	6.3.3.2	Criteria for Specific Navigation Services	App 2, 3.a(3)	DME	Same
8.6	Use of VOR	6.3.3.2	Criteria for Specific Navigation Services	App 2, 3.a(4)	VOR	Same
8.7	Intermixing of Equipment	--	--	--	--	AMC contains additional guidance and criteria
9	Aircraft Flight Manual	6.3.5	Pilot/Dispatch/Operator Knowledge and Training	6.b(3)	FAA Acceptance	Comparable
10	Operational Criteria	--	--	--	--	NC
10.1	General					AMC general info
10.2	Flight Operations Documentation	6.3.2	Approval Process	6.b	FAA Acceptance	AC provides more guidance
10.3	Qualification and Training	6.3.5	Pilot/Dispatch/Operator Knowledge and Training	App 5	Training	AC is more extensive
10.4	Navigation Database Management	6.3.6	Navigation Database	App 3	Navigation Data Validation Programme	Comparable
10.5	Reportable Events	--	--	--	--	AMC is more extensive
10.6	Fleet Approvals	--	--	--	--	AMC unique
10.7	RNP Monitoring Programme	6.3.7	Oversight Of Operators	App 6	RNP Monitoring Programme	Comparable
Appendix 1	Glossary	--	--	3	Definitions	NC
Appendix 2	Training and Crew Qualification Issues	6.3.5	Pilot/Dispatch/Operator Knowledge and Training	App 5	Training	Comparable
Appendix 3	Operational Considerations	6.3.4	Operating Procedures	App 4	Operational Considerations	Comparable

Section	AMC 20-26	Para	PBN Vol II, Chap 6	Section	AC90-101	Comment
Appendix 4	Acceptable Methods for FTE Assessment for RNP	--	--	--	--	AMC unique
Appendix 5	FOSA	6.4	Safety Assessment	App 2, 2.d(2)		AMC guidance consistent with PBN manual. AC contains a mention to OSA only.

[Amdt 20/5]

## AMC 20-27

### AMC 20-27 Airworthiness Approval and Operational Criteria for RNP APPROACH (RNP APCH) Operations Including APV BARO-VNAV Operations

*ED Decision 2009/019/R*

#### 1. PURPOSE

This AMC provides an acceptable means that can be used to obtain airworthiness approval of an Area Navigation (RNAV) system based on a Global Navigation Satellite System (GNSS) stand-alone receiver or multi-sensor system including at least one GNSS sensor in order to conduct RNP Approach (RNP APCH) operations.

RNP APCH procedures are characterised by existing charted RNAV (GNSS) approach procedures designed with straight final approach segments.

This AMC also defines operational criteria necessary to conduct safely RNP APCH operations in designated European airspace.

This AMC addresses RNP APCH operation without vertical guidance (Non Precision Approach operation) and with vertical guidance based on barometric vertical navigation (APV BARO-VNAV operation). Final approaches utilising SBAS (Localiser Performance with Vertical guidance (LPV) operation) are addressed in separate AMC material.

APV BARO-VNAV systems are based on barometric altimetry for the determination of the aircraft position in the vertical axis. The final approach segment of VNAV instrument flight procedures are performed using vertical guidance to a vertical path computed by the on-board RNAV system. The vertical path is contained in the specification of the instrument procedure within the RNAV system navigation database. For other phases of flight, barometric VNAV provides vertical path information that can be defined by altitudes at fixes in the procedure. It should be noted that there is no vertical requirement in this AMC associated to the use of VNAV guidance outside of the final approach segment. Vertical navigation on the initial or intermediate segment can be conducted without VNAV guidance.

An applicant may elect to use an alternative means of compliance. However, those alternative means of compliance must meet safety objectives that are acceptable to the Agency or the competent authority. Compliance with this AMC is not mandatory. Use of the terms shall and must apply only to an applicant who elects to comply with this AMC in order to obtain airworthiness approval or to demonstrate compliance with the operational criteria.

#### 2. BACKGROUND

This document addresses and defines airworthiness and operational criteria related to RNAV systems approved for RNP APCH based on GNSS with or without vertical guidance based on BARO-VNAV. It relates to the implementation of area navigation within the context of the Single European Sky<sup>1</sup>, in particular in relation to the verification of conformity of the airborne constituents, per Article 5 of EC Regulation 552/2004<sup>2</sup>. It addresses general certification

<sup>1</sup> Regulation (EC) No 549/2004 of the European Parliament and of the Council of 10 March 2004 laying down the framework for the creation of the single European sky (the framework Regulation) (OJ L 096, 31/03/2004, p. 01).

<sup>2</sup> Regulation (EC) No 552/2004 of the European Parliament and of the Council of 10 March 2004 on the interoperability of the European Air Traffic Management network (OJ L 096, 31.3.2004, p. 26).

considerations of stand-alone and multi-sensor systems on-board aircraft, including their functional requirements, accuracy, integrity, continuity of function, and limitations, together with operational considerations.

This document is applicable to RNP APCH operations only. It does not address RNP AR APCH operations (see [AMC 20-26](#)).

This AMC identifies the airworthiness and operational requirements for RNP APCH operations including APV BARO-VNAV operation. Operational compliance with these requirements must be addressed through national operational regulations, and may require a specific operational approval in some cases.

Use of BARO-VNAV information for RNP APCH with LNAV minima only is possible using the CDFA (Continuous Descent Final Approach) concept. This use is possible provided the navigation system is able to compute a vertical continuous descent path on the Final Approach segment and operator complies with EU OPS 1.430 section. It should be noted that this AMC does not address such operational approval authorisation.

### **3. SCOPE**

This AMC includes airworthiness and operational criteria related to RNAV systems based on a GNSS stand-alone receiver, or multi-sensor systems including at least one GNSS sensor, intended to be used under Instrument Flight Rules, including Instrument Meteorological Conditions, in designated European airspace. It contains also airworthiness and operational criteria related to systems based upon the use of barometric altitude and RNAV information in the definition of vertical paths and vertical tracking to a path to conduct APV BARO-VNAV operation.

Section 4.2 of this AMC refers to documents which contribute to the understanding of the RNP APCH concept and which may support an application for approval. However, it is important that an operator evaluates his aircraft system and the proposed operational procedures against the criteria of this AMC.

Compliance with this AMC does not, by itself, constitute an operational authorisation to conduct RNP APCH operations. Aircraft operators should apply to their national authority. Since this AMC has been harmonised with other RNP implementation and operational criteria outside of Europe, i.e. USA/FAA, it is expected to facilitate interoperability and ease the effort in obtaining operational authorisation by operators.

This AMC does not cover RNP approaches where special authorisation is required (RNP AR APCH). RNP AR APCH is addressed in a separate AMC.

### **4. REFERENCE DOCUMENTS**

#### **4.1 Related Requirements**

- CS 25.1301, 25.1302, 25.1307, 25.1309, 25.1316, 25.1321, 25.1322, 25.1325, 25.1329, 25.1431, 25.1581.
- CS 23.1301, 23.1309, 23.1311, 23.1321, 23.1322, 23.1325, 23.1329, 23.1335, 23.1431, 23.1581.
- Equivalent requirements of CS/FAR 27 and 29 if applicable.



- EU-OPS<sup>1</sup> 1.035, 1.220, 225, 1.243, 1.290, 1.295, 1.297, 1.400, 1.420, 1.845, 1.865, 1.870, 1.873 and 1.975.
- JAR-OPS 3.243, 3.845, 3.865.
- National operational regulations.

## **4.2 Related Material**

### **4.2.1 ICAO**

ICAO Annex 10	International Standards and Recommended Practices-Aeronautical Telecommunications
ICAO Doc 7030/4	Regional Supplementary Procedures
ICAO Doc 9613	Performance Based Navigation Manual (PBN)
ICAO Doc 8168	PANS OPS (Procedures for Air Navigation Services-Aircraft Operations)

### **4.2.2 EASA**

AMC 25-11	Electronic Flight Deck Display
AMC 20-5	Airworthiness Approval and Operational Criteria for the use of the Navstar Global Positioning System (GPS)
ETSO-C115( )	Airborne Area Navigation Equipment using Multi-Sensor Inputs
ETSO-C129( )	Airborne Supplemental Navigation Equipment Using the Global Positioning System (GPS)
ETSO-C145( )	Airborne Navigation Sensors Using the Global Positioning System (GPS) Augmented by the Wide Area Augmentation System (WAAS)
ETSO-C146( )	Stand-Alone Airborne Navigation Equipment Using the Global Positioning System (GPS) Augmented by the Wide Area Augmentation System (WAAS)
ETSO-C106( )	Air Data Computer
EASA OPINION Nr. 01/2005	Conditions for Issuance of Letters of Acceptance for Navigation Database Suppliers by the Agency (i.e. an EASA Type 2 LoA). EASA OPINION Nr. 01/2005 on "The Acceptance of Navigation Database Suppliers" dated 14 Jan 05

### **4.2.3 FAA**

AC 25-4	Inertial Navigation Systems (INS)
AC 25-11( )	Electronic Display Systems
AC 20-129	Airworthiness Approval of Vertical Navigation (VNAV) Systems or use in the U.S. National Airspace System (NAS) and Alaska
AC 20-138( )	Airworthiness Approval of GNSS equipment

<sup>1</sup> Council Regulation (EEC) No 3922/91 on the harmonisation of technical requirements and administrative procedures in the field of civil aviation. Regulation as last amended by Regulation (EC) No 1899/2006 of the European Parliament and of the Council of 12 December 2006 (OJ L 377, 27.12.2006, p. 1).

---

AC 20-130A	Airworthiness approval of navigation or flight management systems integrating multiple navigation sensors
AC 23-1309-1C	Equipment, systems, and installation in Part-23 airplanes
AC 20-153	Acceptance of data processes and associated navigation data bases

#### 4.2.4 Technical Standard Orders

FAA TSO-C115( )	Airborne Area Navigation Equipment using Multi-Sensor Inputs
FAA TSO-C129( )	Airborne Supplemental Navigation Equipment Using the Global Positioning System (GPS)
FAA TSO-C145( )	Airborne Navigation Sensors Using the Global Positioning System (GPS) Augmented by the Wide Area Augmentation System (WAAS)
FAA TSO-C146( )	Stand-Alone Airborne Navigation Equipment Using the Global Positioning System (GPS) Augmented by the Wide Area Augmentation System (WAAS)
FAA TSO-C106( )	Air Data Computer

#### 4.2.5 EUROCAE/RTCA, SAE and ARINC

ED 26	MPS for airborne Altitude measurements and coding systems
ED 72A	Minimum Operational Performance Specification for Airborne GPS Receiving Equipment
ED-75( )/DO-236( )	Minimum Aviation System Performance Standards: Required Navigation Performance for Area Navigation
ED-76/DO-200A	Standards for Processing Aeronautical Data
ED-12( )/DO-178( )	Software considerations in airborne systems and equipment certification
ED-77/DO-201A	Standards for Aeronautical Information
DO 88	Altimetry
DO 187	Minimum operational performances standards for airborne area navigation equipments using multi-sensor inputs
DO 208	Minimum Operational Performance Standards for Airborne Supplemental Navigation Equipment Using Global Positioning System (GPS)
DO-229( )	Minimum Operational Performance Standards for Global Positioning System/Wide Area Augmentation System Airborne equipment
ARINC 424	Navigation System Data Base
ARINC 706	Mark 5 Air Data System

## 5. ASSUMPTIONS

Applicants should note that this AMC is based on the following assumptions:

### 5.1 Navaid infrastructure

GNSS is the primary navigation system to support RNP APCH procedures.

The acceptability of the risk of loss of RNP APCH capability for multiple aircraft due to satellite failure, loss of the on board monitoring, alerting function (e.g. RAIM holes) and radio frequency interference, will be considered by the responsible airspace authority.

### 5.2 Obstacle clearance

#### 5.2.1 RNP APCH without BARO-VNAV guidance

Detailed guidance on obstacle clearance is provided in PANS-OPS (Doc 8168, Volume II). Missed approach procedure may be supported by either RNAV or conventional (e.g. based on NDB, VOR, DME) segments.

Procedures design will take account of the absence of a VNAV capability on the aircraft.

#### 5.2.2 APV BARO-VNAV

BARO-VNAV is applied where vertical guidance and information is provided to the flight crew on instrument approach procedures containing a vertical path defined by a vertical path angle.

Detailed guidance on obstacle clearance is provided in PANS-OPS (Doc 8168, Volume II). Missed approach procedure may be supported by either RNAV or conventional (e.g. based on NDB, VOR, DME) segments.

### 5.3 Publication

The instrument approach chart will clearly identify the RNP APCH application as RNAV<sub>(GNSS)</sub>.

For non APV BARO-VNAV operation, the procedure design will rely on normal descent profiles and the chart will identify minimum altitude requirements for each segment, including an LNAV OCA(H).

For APV BARO-VNAV operation, charting will follow the standards of ICAO Annex 4 to the Convention on International Civil Aviation for the designation of an RNAV procedure where the vertical path is specified by a glide path angle. The charting designation will remain consistent with the current convention and will promulgate a LNAV/VNAV OCA(H).

If the missed approach segment is based on conventional means, the navaid facilities or airborne navigation means that are necessary to conduct the missed approach will be identified in the relevant publications (e.g. approach charts).

The navigation data published in the applicable AIP for the procedures and supporting navigation aids will meet the requirements of ICAO Annex 15 and Annex 4 to the Convention on International Civil Aviation. The chart will provide sufficient data to support navigation data base checking by the crew (including waypoint name, track, distance for each segment and vertical path angle).

All procedures will be based upon WGS 84 coordinates.

#### **5.4 Communication, ATS surveillance and ATC coordination**

RNP APCH does not include specific requirements for communication or ATS surveillance. Adequate obstacle clearance is achieved through aircraft performance, operating procedures and procedure design. Where reliance is placed on the use of radar to assist contingency procedures, its performance will be shown to be adequate for that purpose, and the requirement for a radar service will be identified in the AIP.

RT phraseology appropriate to RNP APCH operations will be promulgated.

It is expected that ATC will be familiar with aircraft VNAV capability, as well as issues associated with altimeter setting and temperature effect potentially affecting the integrity of the APV BARO-VNAV operation.

The particular hazards of a terminal and approach area and the impact of contingency procedures following multiple loss of RNP APCH capability will be assessed.

ATC may use radar vectoring techniques to place aircraft onto final approach axis when the RNAV system supports this function. Air Navigation Service Providers implementing such operation in their airspace should inform airspace users of this operational possibility in the relevant AIP.

#### **5.5 Service provider assumption for APV BARO-VNAV operation.**

It is expected that air navigation service provision will include data and information to enable correct and accurate altimeter setting on-board the aircraft, as well as local temperature. This data will be from measurement equipment at the airport where the approach is to take place (remote or regional pressure setting are not authorised).

The specific medium for transmission of this data and information to the aircraft may include voice communication, ATIS or other media. In support of this, it is also expected that MET service providers will assure the accuracy, currency and availability of meteorological data supporting APV BARO-VNAV operations. In order to minimise the potential for miss-setting of barometric reference, Air Traffic Controllers will confirm QNH with flight crews prior to commencement of the approach.

### **6. RNP APCH AIRWORTHINESS CRITERIA**

#### **6.1 General**

The following airworthiness criteria are applicable to the installation of RNAV system intended for IFR approach operation, certified according to CS-23, -25, -27 and -29

This AMC uses FAA Advisory Circulars AC 20-138/AC 20-138A (GPS stand-alone system) or AC 20-130A (Multi-sensors systems) as the basis for the airworthiness approval of an RNAV system based on GNSS. For APV BARO-VNAV operation, this AMC uses FAA Advisory Circular AC 20-129 as the airworthiness basis with additional requirements.

This AMC is to be used as Interpretative Material to show compliance with the applicable CS codes on each application, e.g. xx.1301 and xx.1309.

#### **6.2 Equipment qualification**

##### **6.2.1 General**

If the RNAV installation is based on GNSS stand-alone system, the equipment shall be approved in accordance with TSO-C129a/ETSO-C129a Class A1 or ETSO-C146()/TSO-C146() Class Gamma, operational class 1, 2 or 3.

If the RNAV installation is based on GNSS sensor equipment used in a multi-sensor system (e.g. FMS), the GNSS sensor shall be approved in accordance with TSO-C129( )/ ETSO-C129( ) Class B1, C1, B3, C3 or ETSO-C145( )/TSO-C145( ) class Beta, operational class 1, 2 or 3.

Multi-sensor systems using GNSS should be approved in accordance with AC20-130A or ETSO-C115b/TSO-C115b, as well as having been demonstrated for RNP capability.

Note 1: For GNSS receiver approved in accordance with ETSO-C129()/TSO-C129(), capability for satellite Fault detection and Exclusion (FDE) is recommended, to improve Continuity of function.

Note 2: GNSS receivers approved in accordance with ETSO-145/TSO-C145a or ETSO-C146/TSO-C146a (DO 229C) and used outside SBAS coverage area may trigger inappropriate Loss of Integrity (LOI) warning. DO229D paragraph 2.1.1.6 provides a correct satellite selection scheme requirement to address this issue. Although most of the ETSO-C145/TSO-C145a or ETSO-146/TSO-C146a approved receivers comply with this satellite selection scheme, a confirmatory statement from the equipment manufacturer is still necessary. It should be noted that such confirmatory statement is not necessary for equipment compliant with TSO-C145b or TSO-C146b.

#### 6.2.2 Altimeter sensor requirement for APV BARO-VNAV operation

In addition to requirements of paragraph 6.2.1 above, the RNAV equipment that automatically determines aircraft position in the vertical plane should use inputs from equipment that can include:

- a) ETSO-C106/TSO-C106, Air Data Computer; or
- b) Air data system, ARINC 706, Mark 5 Air Data System, ARINC 738 (Air Data and Inertial Reference System); or
- c) Barometric altimeter system compliant with DO-88 "Altimetry" and/or ED-26 "MPS for Airborne Altitude Measurements and Coding Systems"; or
- d) Type certified integrated systems providing an Air Data System capability comparable to item b).

### 6.3 Accuracy

#### 6.3.1 Horizontal

The Lateral and Longitudinal Total System Error (TSE) of the on-board navigation system must be equal to or better than:

- a)  $\pm 1$  NM for 95% of the flight time for the initial and intermediate approach segments and for the RNAV missed approach.

Note: There is no specific RNAV accuracy requirement for the missed approach if this segment is based on conventional means (VOR, DME, NDB) or on dead reckoning.

- b)  $\pm 0.3$  NM for 95% of the flight time for the final approach segment.

The Lateral Total System Error (TSE) is dependent on the Navigation System Error (NSE), Path Definition Error (PDE) and Flight Technical Error (FTE).

In order to satisfy the  $\pm 0.3$  NM TSE accuracy for the final approach segment, FTE (95%) should not exceed  $\pm 0.25$  NM whatever the operating mode (manual, flight director or Autopilot):

- a) A demonstrated FTE (95%) of  $\pm 0.25$  NM is assumed for manual mode if a standardised CDI is installed (compliant with the full-scale deflection sensitivity requirement of TSO-C129a paragraph (a).3.(viii) or RTCA/DO-229() paragraph 2.2.1.4.2.1) Otherwise, it should be demonstrated that an FTE of  $\pm 0.25$  NM can be maintained under all foreseeable conditions through a dedicated flight test evaluation.
- b) A demonstrated FTE (95%) of  $\pm 0.25$  NM is assumed when coupled to a flight director.
- c) A demonstrated FTE (95%) of  $\pm 0.125$  NM is assumed when coupled to an autopilot.

Outside of the Final Approach Segment, a demonstrated FTE of  $\pm 0.5$  NM may be assumed.

Positioning data from other types of navigation sensors may be integrated with the GNSS data provided it does not cause position errors to exceed the Total System Error (TSE) budget, otherwise a means must be provided to deselect the other navigation sensor types.

Note: The horizontal positioning error component of TSE is assumed to be equal to the 2D navigation accuracy of systems/sensors qualified to AC20-138, 20-138A, and 20-130A

An acceptable means of complying with these accuracy requirements is to have an RNAV system approved for RNAV approaches in accordance with 2D navigation accuracy criteria of FAA AC 20-138, AC 20-138A or AC 20-130A.

#### 6.3.2 Vertical accuracy for APV BARO-VNAV operation.

- a) Altimetry System Error (ASE)

Altimetry system performance is demonstrated separately from the APV BARO-VNAV certification through the static pressure system certification process. With such approval (e.g. CS 25.1325), each system must be designed and installed so that the error in indicated pressure altitude, at sea-level, with a standard atmosphere, excluding instrument calibration error, does not result in an error of more than  $\pm 9$  m ( $\pm 30$  ft) per 185 km/hr (100 knots) speed for the appropriate configuration in the speed range between 1.23 VSR0 with wing-flaps extended and 1.7 VSR1 with wing-flaps retracted. However, the error need not be less than  $\pm 9$  m ( $\pm 30$  ft).

Altimetry systems meeting such a requirement will satisfy the Altimetry System Error (ASE) requirements for APV BARO-VNAV operation. No further demonstration or compliance is necessary.

Note 1: Altimetry Error refers to the electrical output and includes all errors attributable to the aircraft altimetry installation including position effects resulting from normal aircraft flight attitudes. In high performance aircraft, it is expected that altimetry correction will be provided. Such correction should be done automatically. In lower

performance aircraft, upgrading of the altimetry system may be necessary.

Note 2: Positioning data from other sources may be integrated with the barometric altitude information provided it does not cause position errors exceeding the vertical accuracy requirement.

b) VNAV Equipment Error

The error of the airborne VNAV equipment (excluding altimetry, horizontal coupling and flight technical error) on a 99.7 per cent probability basis should be demonstrated to be less than:

	Descent Along Specified Vertical Profile (angle) (ft)
At or below 5000 ft (MSL)	100
5000 ft to 10000 ft (MSL)	150
10000 ft to 15000 ft (MSL)	220

Note 1: VNAV Equipment Error is the error associated to the vertical path computation. It includes path definition error (PDE) and approximation made by the VNAV equipment for the vertical path construction if any.

c) Horizontal Coupling Error

The Horizontal coupling error (vertical error component of along track positioning error) is a function of the horizontal NSE (see 6.3.1) and is directly reflected in the along track tolerance offset used in APV BARO-VNAV procedure design criteria.

This Horizontal Coupling error in this context is assumed to be 24 ft on a 99.7 per cent probability basis using a longitudinal positioning accuracy of 0.05 NM at 95% and a vertical path of 3°.

Note: For straight approaches, it is assumed that longitudinal accuracy does not include an FTE component. An arbitrary TSE (based on NSE) of 0.2NM is applied instead of 0.3NM.

d) Vertical Flight Technical Error (FTE)

The vertical FTE on a 99.7 per cent probability basis should be demonstrated to be less than

	Descent Along Specified Vertical Profile (angle)(ft)
At or below 5000 ft (MSL)	150
5000 ft to 10000 ft (MSL)	150
10000 ft to 15000 ft (MSL)	150

Note 1: FTE performance requirements are more stringent compared with AC 20-129 and the ICAO PBN manual where 200ft (at or below 5000 ft MSL) and 300 ft (from 5000 ft to 15000 ft MSL) are required.

Note 2: Use of a flight director or autopilot may be required to support such an FTE requirement.

e) Vertical Total System Error (TSE)

The Vertical Total System Error (using the Root Sum Square (RSS) of all errors components described above) on a 99.7 per cent probability basis is as follow:

	Altimeter System Error <sup>1</sup>	VNAV Equipment Error	Horizontal coupling Error	Flight Technical Error	Vertical Total System Error
At or below 5000 ft (MSL)	80 ft	100 ft	24 ft	150 ft	<b>199 ft</b>
5000 ft to 10000 ft MSL)	106 ft	150 ft	24 ft	150 ft	<b>238 ft</b>
10000 ft to 15000 ft MSL)	127 ft	220 ft	24 ft	150 ft	<b>296 ft</b>

Note 1: If an installation results in larger Fight Technical Errors, the Total Vertical Error for the system should be determined by combining the demonstrated errors using the root sum square (RSS) method. The result should be less than the values listed.

Note 2: The manual monitoring of the altimeters to comply with the DA/DH is independent of the BARO-VNAV system and provides additional mitigation.

An acceptable means of complying with the above accuracy requirements is to have the VNAV system approved for RNAV approaches in accordance with FAA AC 20-129 and to provide evidence that the FTE, or VTSE, or operation procedures to bound the FTE are within the required limits.

f) Vertical Path Error at FAP due to the vertical fly-by transition

Error due to the capture of the vertical path starting from the FAP altitude should be limited. This momentary deviation below the published minimum procedure altitude at the FAP is acceptable provided the deviation is limited to no more than 50 feet (assuming no VNAV equipment error).

Note: ED-75 B paragraphs 1.5.7.2 and 3.2.8.5 provides guidance regarding the VNAV path transitions and, in particular, the vertical fly-by transition

#### 6.4 Integrity

During operations on instrument approach procedures, the probability of displaying misleading navigational or positional information to the flight crew during the approach, including the final segment, shall be remote.

In the horizontal plane and during operations on the initial, intermediate segment and for the RNAV missed approach of an RNP APCH, the system, or the system and pilot in combination, shall provide an alert if the accuracy requirement is not met, or if the probability that the lateral TSE exceeds 2 NM is greater than  $10^{-5}$ . During operations on the final approach segment of an RNP APCH, the system, or the system and pilot in

<sup>1</sup> The ASE value has been computed using the following formula:

$$ASE (ft) = -8.8 \cdot 10^{-8} \times (h+\Delta h)^2 + 6.5 \cdot 10^{-3} \times (h+\Delta h) + 50$$

where h is the height of the local altimetry reporting station and Δh is the height of the aircraft above the reporting station.



combination, shall provide an alert if the accuracy requirement is not met, or if the probability that the lateral TSE exceeds 0.6 NM is greater than  $10^{-5}$ .

For APV BARO-VNAV operation, in the vertical plane the integrity is relying on system development assurance, crew procedures and use of airborne systems independent from the VNAV computer system (e.g. primary altimeter system). The integrity requirement is satisfied by applying appropriate quantitative numerical methods, qualitative operational and procedural considerations and mitigations. The airborne VNAV system must be designed in accordance with the major failure condition regarding the computation of an erroneous vertical guidance. Two independent altimetry systems (sources and displays) must be operational and crew must cross-check the displayed altitude during the approach and, in particular, when determining the Decision Altitude (DA). Operator procedures and crew training should highlight the importance of having the current altimeter setting for the selected instrument procedure and runway and the respect of temperature limitation if the VNAV system does not compensate automatically.

Note 1: An airborne safety objective of Remote recognises that not only is the navigation system design evaluated consistent with known industry and regulatory system safety assessment views, but is now augmented with a comprehensive assessment of system performance assurance, system features/functions, human interface, flight crew procedures, maintenance and training, that is unique for RNP. The result is that the safety assurance provided greatly exceeds that of conventional navigation systems.

Note 2: An airborne objective of Remote is applicable to an instrument approach in particular on the final segment, i.e. from the FAF down to the runway. It is possible to satisfy this objective when considering the RNP system's unique requirements for RNP monitoring and integrity alerting, situational awareness information, error checking via the human machine interface and cockpit displays of independent flight information. Furthermore, the pilot should respect all vertical constraints associated to the procedure (start of descent, step-down fix,...) in order to respect obstacle clearance.

Note 3: The probability to fail to detect a GPS-induced position error larger than 0.3 NM is less than  $10^{-7}/Fh$  if the receiver is compliant with ETSO-C129( )/TSO-C129( ), ETSO-C145/TSO-C145a or ETSO-C146/TSO-C146a. This  $10^{-7}/Fh$  criterion is the combined probability of the missed detection probability (less than or equal to  $10^{-3}/Fh$ ) and the probability of receiving an erroneous satellite signal (less than or equal to  $10^{-4}/Fh$ ).

Note 4: Traditionally, this requirement has not specifically addressed the airborne system operational software or airborne system databases (e.g. navigation database). However, it is expected that where the RNAV airborne software has been previously shown compliant with the criteria of ED-12B/DO-178B, Level C, as a minimum, it is acceptable for the operations associated with this AMC.

Note 5: Probability terms are defined in CS AMC 25.1309, AC 23.1309-1() AC 27-1B or AC 29-2C.

Note 6: For RNP APCH operation, the on-board monitoring and alerting function is provided through the use of ABAS (RAIM or an equivalent algorithm) in conjunction with crew monitoring of the FTE.

Note 7: For aircraft and systems approved for RNP AR operations, per [AMC 20-26](#), the crew alerting based upon RNP is an acceptable alternative.

## 6.5 Continuity of function

It shall be demonstrated that:

- (a) The probability of loss of all navigation information is Remote.
- (b) The probability of non-restorable loss of all navigation and communication functions is Extremely Improbable.

Loss of the RNP APCH functions with or without BARO-VNAV guidance is considered a minor failure condition if the operator can revert to a different navigation system and proceed to a suitable airport. For RNP APCH operations at least one RNAV system is required.

Note 1: From an operational point of view, the operator should develop contingency procedure for the loss of the RNP APCH capability during the approach.

Note 2: Probability terms are defined in CS AMC 25.1309, AC 23.1309-1() AC 27-1B or AC 29-2C.

## 7. FUNCTIONAL CRITERIA

### 7.1 Required Function for RNP APCH

Item	Functional Description
1	<p>Navigation data, including a to/from indication and a failure indicator, must be displayed on a lateral deviation display (CDI, (E)HSI) and/or a navigation map display. These must be used as primary flight instruments for the navigation of the aircraft, for manoeuvre anticipation and for failure/status/integrity indication. They must meet the following requirements:</p> <ul style="list-style-type: none"> <li>1) The displays must be visible to the pilot and located in the primary field of view (<math>\pm 15</math> degrees from pilot's normal line of sight) when looking forward along the flight path.</li> <li>2) The lateral deviation display scaling must agree with any alerting and annunciation limits, if implemented.</li> <li>3) The lateral deviation display must also have a full-scale deflection suitable for the current phase of flight and must be based on the required total system accuracy. For installations having a lateral deviation display, its full-scale deflection must be suitable for the phase of flight and based on the required track-keeping accuracy. Scaling is <math>\pm 1</math> NM for the initial and intermediate segments and <math>\pm 0.3</math> NM for the final segment.</li> <li>4) The display scaling may be set automatically by default logic or set to a value obtained from a navigation database. The full-scale deflection value must be known or made available for display to the flight crew.</li> </ul> <p>Enhanced navigation display (e.g. electronic map display or enhanced EHSI) to improve lateral situational awareness, navigation monitoring and approach (flight plan) verification could become mandatory if the RNAV installation does not support the display of information necessary for the accomplishment of these crew tasks.</p>
2	<p>Capability to continuously display, to the pilot flying, the RNAV computed desired path (DTK), and the aircraft position relative to the path (XTK), on the primary flight instruments for navigation of the aircraft.</p> <p>Note: Where the minimum flight crew is two pilots, it shall be possible for the pilot not flying to verify the desired path and the aircraft position relative to the path.</p>
3	<p>A navigation database, containing current navigation data officially promulgated for civil aviation;</p> <ul style="list-style-type: none"> <li>a) which can be updated in accordance with the AIRAC cycle and</li> <li>b) from which approach procedures can be retrieved in their entirety and loaded into the RNAV system.</li> </ul>

	<p>The resolution to which the data is stored must be sufficient to ensure that the assumption of no path definition error is satisfied.</p> <p>The databases shall be protected against flight crew modification of the stored data.</p> <p>Note: When a procedure is loaded from the database, the RNAV system is required to fly it as published. This does not preclude the flight crew from having the means to modify a procedure or route already loaded into the RNAV/GNSS system as permitted by paragraph 10. However, the procedure stored in the database must not be modified and must remain intact within the database for future use and reference.</p>
4	Means to display the validity period of the navigation database to the flight crew.
5	Means to retrieve and display data stored in the navigation database relating to individual waypoints and navigation aids, to enable the flight crew to verify the procedure to be flown.
6	Capacity to load from the database into the RNAV system the whole approach procedure to be flown.
7	Display of the identification of the active (To) waypoint, either in the pilot's primary field of view, or on a readily accessible page on the RNAV CDU, readily visible to the flight crew.
8	Display of distance and bearing to the active (To) waypoint in the pilot's primary field of view. Where impracticable, the data may be displayed on a readily accessible page on the RNAV CDU, readily visible to the flight crew.
9	Display of distance between flight plan waypoints. The navigation system must provide the ability to display the distance between flight plan waypoints.
10	Display of distance from present position to any selected waypoint. The navigation system must provide the ability to display the distance to any waypoint selected by the flight crew. Such selection should not impact the active flight plan.
11	Display of ground speed or time to the active (To) waypoint, either in the pilot's primary field of view, or on a readily accessible page on the RNAV CDU, readily visible to the flight crew.
12	Capability for the "Direct to" function.
13	Capability for automatic leg sequencing with display of sequencing to the flight crew.
14	Capability to execute database procedures including: <ul style="list-style-type: none"> <li>a) fly-over and</li> <li>b) fly-by turns.</li> </ul>
15	<p>Capability to execute leg transitions and maintain tracks consistent with the following ARINC 424 path terminators (automatic capability), or their equivalent:</p> <p>Initial Fix (IF), Track to Fix (TF), Direct to Fix (DF)</p> <p>Note: Path terminators are defined in ARINC Specification 424, and their application is described in more detail in documents PANS-OPS, EUROCAE ED-75()/RTCA DO-236(), ED-77/RTCA DO-201A, and EUROCONTROL Document NAV.ET1.ST10.</p>
16	Capability to automatically execute leg transitions consistent with ARINC 424 FA path terminators, or the RNAV system must permit the pilot to fly a course and turn at a designated altitude. If manual intervention is necessary to turn at the designated altitude, the associated crew workload shall be assessed
17	Indication of the RNAV system failure leading to the loss of navigation function in the pilot's primary field of view (e.g. by means of a navigation warning flag on the navigation display).
18	<p>Indication of the Loss Of Integrity (LOI) function (e.g. loss of RAIM) in the pilot's normal field of view (e.g. by means of an appropriately located annunciator).</p> <p>Note: Systems providing RNP alerts that reflect loss of GNSS integrity are considered acceptable.</p>
19	<p>Capability for the accomplishment of holding patterns and procedure turns. Activation of this function shall at least:</p> <ul style="list-style-type: none"> <li>a) Change automatic waypoint sequencing to manual.</li> </ul>

- b) Permit the pilot to readily designate a waypoint and select a desired course (by means of a numerical keypad entry, HSI course pointer, CDI omni-bearing selector, etc.) to or from the designated waypoint (TO/FROM mode operation is acceptable).
- c) Retain all subsequent waypoints in the active flight plan in the same sequence.
- d) Permit the pilot to readily return to automatic waypoint sequencing at any time prior to the designated fix ("TO" waypoint) and continue with the existing flight plan.

## 7.2 Additional required function for APV BARO-VNAV operation

In addition to the required function specified in paragraph 7.1, the system shall meet the following requirements:

Item	Functional Description																				
1	<p>APV BARO-VNAV deviation must be displayed on a vertical deviation display (HSI, EHSI, VDI). This display must be used as primary flight instruments for the approach. The display must be visible to the pilot and located in the primary field of view (<math>\pm 15</math> degrees from pilot's normal line of sight) when looking forward along the flight path.</p> <p>The deviation display shall have a suitable full-scale deflection based on the required vertical track error.</p> <p>The non-numeric display must allow the flight crew to readily distinguish if the vertical deviation exceeds <math>\pm 75</math> feet.</p> <p>If the non-numeric display does not permit the flight crew to readily distinguish excessive vertical deviations, the approach must be conducted with the flight director and/or the autopilot and a numeric display should allow the pilot to readily distinguish if the vertical deviation exceeds <math>\pm 75</math> feet</p>																				
2	<p>Capability to continuously display, to the pilot flying, the vertical deviation relative to the Final approach segment on the primary flight instruments for navigation of the aircraft.</p> <p>Note: Where the minimum flight crew is two pilots, a means for the pilot not flying to verify the desired path and the aircraft position relative to the path shall be provided.</p>																				
3	<p>The navigation system must be capable of defining a vertical path in accordance with the published vertical path.</p> <p>Note: The VNAV equipment error budget (see 6.3.2.b) includes the path approximation error.</p>																				
4	<p>User Interface (Displays and Control)</p> <p>The display readout and entry resolution for vertical navigation information shall be as follow:</p> <table border="1" style="width: 100%; border-collapse: collapse;"> <thead> <tr> <th style="background-color: #cccccc;">Parameter</th> <th style="background-color: #cccccc;">Display resolution</th> <th style="background-color: #cccccc;">Entry resolution</th> </tr> </thead> <tbody> <tr> <td rowspan="2">Altitude</td> <td>Above altitude transition level</td> <td>Flight Level</td> </tr> <tr> <td>Below altitude transition level</td> <td>1 foot</td> </tr> <tr> <td>Vertical Path Deviation</td> <td>10 feet</td> <td>Not applicable</td> </tr> <tr> <td>Flight Path Angle</td> <td>0.1 degree (*)</td> <td>0.1 degree</td> </tr> <tr> <td>Temperature</td> <td>1 degree</td> <td>1 degree</td> </tr> <tr> <td colspan="3">(*) A Display resolution of 0.01 degree is recommended</td> </tr> </tbody> </table>	Parameter	Display resolution	Entry resolution	Altitude	Above altitude transition level	Flight Level	Below altitude transition level	1 foot	Vertical Path Deviation	10 feet	Not applicable	Flight Path Angle	0.1 degree (*)	0.1 degree	Temperature	1 degree	1 degree	(*) A Display resolution of 0.01 degree is recommended		
Parameter	Display resolution	Entry resolution																			
Altitude	Above altitude transition level	Flight Level																			
	Below altitude transition level	1 foot																			
Vertical Path Deviation	10 feet	Not applicable																			
Flight Path Angle	0.1 degree (*)	0.1 degree																			
Temperature	1 degree	1 degree																			
(*) A Display resolution of 0.01 degree is recommended																					
5	<p>The navigation database must contain all the necessary data/information to fly the published APV BARO-VNAV approach. The navigation database must contain the waypoints and associated vertical information (e.g. VPA) for the procedure.</p> <p>Vertical Constraints associated with published procedures must be automatically extracted from the navigation database upon selecting the approach procedure.</p>																				
6	<p>Indication of loss of navigation (e.g. system failure) in the pilot's primary field of view by means of a navigation warning flag or equivalent indicator on the vertical navigation display.</p>																				
7	<p>The aircraft must display barometric altitude from two independent altimetry sources, one in each pilots' primary field of view. When single pilot operation is permitted, the two displays must be visible from the pilot position.</p>																				

### 7.3 Recommended Function for RNP APCH

Item	Functional Description
1	Capability, following ATC instructions, to immediately provide horizontal track deviation indications relative to the extended final approach segment, in order to facilitate the interception of this extended final approach segment from a radar vector.
2	Course selector of the deviation display automatically slaved to the RNAV computed path. Note: Systems with electronic map display in the pilot's primary field of view having a depiction of the active route are sufficient.

### 7.4 Recommended Function for APV BARO-VNAV operation

Item	Functional Description
1	Temperature compensation: Capability to automatically adjust the vertical flight path for temperature effects. The equipment should provide the capability for entry of altimeter source temperature to compute temperature compensation for the vertical flight path angle. The system should provide clear and distinct indication to the flight crew of this compensation/adjustment.
2	Capability to automatically intercept the vertical path at FAP using a vertical fly by technique. Note: Vertical Fly By performance is described in ED-75 B paragraphs 1.5.7.2 and 3.2.8.5

## 8. AIRWORTHINESS COMPLIANCE

### 8.1 General

This section details a means of airworthiness compliance for new or modified installations (Para 8.2) and for existing installations (Para 8.3). It also details specific points that should be considered during these approval processes (Para 8.4).

Relevant documentation demonstrating airworthiness compliance should be available to establish that the aircraft is equipped with an RNAV systems meeting RNP APCH requirements without or with vertical guidance (APV BARO-VNAV).

### 8.2 New or Modified Installations

In demonstrating compliance with this AMC, the following specific points should be noted:

The applicant will need to submit to the Agency a compliance statement which shows how the criteria of this AMC have been satisfied. The statement should be based on a plan, agreed by the Agency at an early stage of the implementation programme. The plan should identify the certification data to be submitted which should include, as appropriate, a system description together with evidence resulting from the activities defined in the following paragraphs.

Compliance with the airworthiness requirements for intended function and safety may be demonstrated by equipment qualification, system safety analysis, confirmation of appropriate software design assurance level (i.e. consistent with paragraph 6.4), performance analyses, and a combination of ground and flight tests. To support the approval application, design data will need to be submitted showing that the objectives and criteria of Sections 6 and 7 of this AMC have been satisfied.

Use of the RNAV systems and the manner of presentation of lateral and vertical (if provided) guidance information on the flight deck should be evaluated to show that the risk of flight crew error has been minimised.

#### 8.2.1 Specific Installation criteria

The following points need to be taken into consideration during the airworthiness approval process.

- a) Where other conventional navigation systems, apart from the RNAV system, provide display and/or guidance to a flight director/Autopilot, means should be provided for:
  - a navigation system source selector as the only means of selection;
  - clear annunciation of the selected navigation system on or near the navigation display;
  - display of guidance information appropriate to the selected navigation system; and
  - delivery of guidance information to a flight director/autopilot appropriate to the selected navigation system.
- b) Annunciation for flight director, autopilot and selected navigation system should be consistent, and compatible with the original design philosophy of the cockpit.
- c) Loss of navigation capability should be indicated to the flight crew.
- d) Equipment failure scenarios involving conventional navigation systems and the RNAV system(s) should be evaluated to demonstrate that:
  - adequate alternative means of navigation are available following failure of the RNAV system; and
  - reversionary switching arrangements, e.g. VOR/GPS#2 on HSI#1, do not lead to misleading or unsafe display configurations.

The evaluation should consider also the probability of failures within the switching arrangements.

- e) If barometric altitude input is used by the RNAV system (e.g. Baro aiding for RAIM function), loss of altitude information should be indicated by the RNAV system.
- f) The coupling arrangements between the RNAV system and the flight director/automatic pilot should be evaluated to show compatibility and to demonstrate that operating modes, including RNAV system failures modes, are clearly and unambiguously indicated to the flight crew.
- g) The use of the RNAV system and the manner of presentation of lateral and vertical (if provided) guidance information on the flight deck should be evaluated to show that the risk of flight crew error has been minimised. The crew should be aware, at any time, of the system used for navigation.
- h) The installation configuration features provided by the RNAV system which affect airworthiness approval or operational criteria, such as: external CDI selection; external CDI calibration; entering of GPS antenna height above ground; serial Input/Output port configuration; reference datum, should not be selectable by the pilot. Instructions on how to configure the RNAV system for the particular installation should be listed in the appropriate manual.

- i) Controls, displays, operating characteristics and pilot interface to RNAV system should be assessed in relation to flight crew workload, particularly in the approach environment. Essential design considerations include:
- Minimising reliance on flight crew memory for any system operating procedure or task. Developing a clear and unambiguous display of system modes/sub-modes and navigational data with emphasis on enhanced situational awareness requirements for any automatic mode changes, if provided.
  - Use of context sensitive helps capability and error messages (for example, invalid inputs or invalid data entry messages should provide a simple means to determine how to enter “valid” data).
  - Placing particular emphasis on the number of steps and minimising the time required to accomplish flight plan modifications to accommodate ATS clearances, holding procedures, runway and instrument approach changes, missed approaches and diversions to alternate destinations.
  - Minimising the number of nuisance alerts so the flight crew will recognise and react appropriately when required.

### **8.3 Existing Installations**

Aircraft that are approved for RNP AR APCH operations are considered compliant with this AMC.

An existing statement in the AFM that indicates the aircraft is approved:

- to perform RNP 0.3 GNSS approaches or,
- for instrument approaches including a specification of RNP GNSS capability that meets RNP 0.3

is considered acceptable for lateral performance.

If this is not the case, the applicant will need to submit to the Agency a compliance statement which shows how the criteria of this AMC have been satisfied for existing installations. Compliance may be established by inspection of the installed system to confirm the availability of required features and functionality. The performance and integrity criteria of Sections 6 and 7 may be confirmed by reference to statements in the Aircraft Flight Manual or to other applicable approvals and supporting certification data. In the absence of such evidence, supplementary analyses and/or tests may be required.

To avoid unnecessary regulatory activity, the determination of eligibility for existing systems should consider acceptance of manufacturer documentation. In this specific case, an AFM amendment is recommended to reflect the RNP APCH aircraft capability. The addition of this aircraft capability in the AFM without any technical modification applied to the aircraft could be considered as a Minor change by the Agency.

### **8.4 Specific Installation assessment**

#### **8.4.1 Lateral and vertical Fly-By transition mechanism**

The applicant should demonstrate that the turn indication during lateral fly-by transitions is accurate enough to keep the aircraft within the theoretical transition area as described in ED-75 B paragraph 3.2.5.4. Lateral Fly-by transition assessment

should be evaluated in manual and in autopilot mode. If the equipment provides positive course guidance through the turn (during the fly-by transition), then no specific flight test is required.

The applicant should demonstrate that the vertical indication during vertical fly-by transitions is accurate enough to keep the aircraft within the profile described in ED-75 B paragraph 3.2.8.5. Vertical Fly-by transition assessment should be evaluated in manual and in autopilot mode. It is recalled that momentary deviation below the published minimum procedure altitude at the FAP is acceptable provided the deviation is limited to no more than 50 feet assuming no VNAV equipment error.

#### 8.4.2 Enhanced navigation displays

It is recognised that enhanced navigation display (such as IFR approved electronic moving map or enhanced EHSI) improves crew lateral situational awareness and navigation monitoring. It is strongly recommended that the RNAV installation incorporates an IFR approved moving map display. This may be a stand-alone display or may be integrated within the aircraft electronic displays system or directly integrated within the GNSS stand-alone receiver. For certain cases an enhanced navigation display is required (see Para 7.1 Item 1).

The graphical map display should incorporate at least the active flight plan, map ranges consistent with the flight operation, available navigation aids, and airports. Design and installation of enhanced navigation display should be approved during the approval process; in particular the evaluation of the man-machine interface (colour, symbol, cluttering aspect, display location, display size, etc.).

Enhanced navigational display is considered an essential function for the crew to verify the approach procedure loaded from the navigational database. This display is also a key element for the navigation crew monitoring (e.g. flight plan progress).

#### 8.4.3 Intermixing of equipment

Simultaneous use of RNAV systems with different crew interfaces can be very confusing and can lead to problems when they have conflicting methods of operation and conflicting display formats. For approach operations, simultaneous use of RNAV equipment which is not identical or compatible is not permitted.

### 9. AIRCRAFT FLIGHT MANUAL/PILOT OPERATING HANDBOOK

For new or modified aircraft, the Aircraft Flight Manual (AFM) or the Pilot's Operating Handbook (POH), whichever is applicable, should provide at least the following information:

- a) A statement which identifies the equipment and aircraft build or modification standard certificated for RNP APCH operation with or without vertical guidance (APV BARO-VNAV). This may include a very brief description of the RNAV/GNSS system, including the RNAV/GNSS airborne equipment software version, CDI/HSI equipment and installation and a statement that it is suitable for RNAV operations. A brief introduction to the RNAV(GNSS) approach concept using ICAO RNP APCH terminology may also be included.
- b) Appropriate amendments or supplements to cover RNP APCH approach operations in the following sections:
  - Limitations – including use of VNAV, FD and AP; currency of navigation database; crew verification of navigation data; availability of RAIM or equivalent function; restrictions on use of GNSS for conventional Non Precision Approaches.



- Normal Procedures
- Abnormal Procedures – including actions in response to a Loss of Integrity (e.g. ‘RAIM Position Warning’, (or equivalent) message or a ‘RAIM not available’, (or equivalent) message).

Note: This limited set assumes that a detailed description of the installed system and related operating instructions and procedures are available in other approved operational or training manuals.

## 10. RNP APCH OPERATIONAL CRITERIA

This section describes acceptable operational criteria for approach operations, subject to the limitations given below. The operational criteria assume that the corresponding installation/airworthiness approval has been granted by the Agency.

Operational criteria apply to the use of the RNAV system for RNP APCH operations on any aircraft operated under IFR in accordance with EU legislation or the applicable operational regulations in the fields for which the EU legislation has not yet been established.

Operations of the RNAV systems should be in accordance with the AFM or AFM supplement. The operational procedures to be addressed by the operator are detailed in [Appendix 4](#). The (Master) Minimum Equipment List (MMEL/MEL) should be amended to identify the minimum equipment necessary to satisfy operations using the RNAV system.

The operator should determine the operational characteristics of the procedure to be flown. It is recommended that the process described in paragraph 10.3 and [Appendix 2](#) of this AMC should be followed to validate its operational use by the crew.

Depending on the aircraft capability and the approach procedure, RNP APCH procedures may be conducted with lateral (LNAV), lateral/vertical (LNAV/VNAV) or equivalent mode engaged, and coupling with either a flight director or autopilot.

Prior to the operation, the operator needs to be authorised by his/her competent authority for such operations.

### 10.1 Flight Operations Documentation

The relevant parts and sections of the Operations Manual (e.g., Aircraft Operations Manual, check lists, training of crew) should be revised to take account of the operating procedures detailed in this section and, in particular those in [Appendix 4](#). The operator should make timely amendments to the Operations Manual to reflect relevant RNP APCH procedure without or with vertical guidance (APV BARO-VNAV) and database checking strategies. Manuals and check lists need to be submitted for review by the responsible authority as part of the authorisation process.

The aircraft operator should propose an amendment to the Minimum Equipment List (MEL) appropriate to RNP APCH operations.

### 10.2 Flight Crew Training

Each pilot should receive appropriate training, briefings and guidance material in order to safely conduct RNP APCH operations without or with vertical guidance (APV BARO-VNAV). This material and training should cover both normal and abnormal procedures. Standard training and checking, such as recurrent aeroplane/STD training and proficiency checks, should include RNP APCH procedures. Based on this, the operator should determine what constitutes a qualified crew.

The operator should ensure that during line operations each pilot can perform assigned duties reliably and expeditiously for each procedure to be flown in:

- a) normal operations and
- b) abnormal operations

The operator should ensure that altimeter settings procedures and cold temperature limitations during APV BARO-VNAV operation are respected.

- a) Altimeter setting

Flight Crews should take precautions to switch altimeter settings at appropriate times or locations and request a current altimeter setting if the reported setting is not recent, particularly at times when pressure is reported or is expected to be rapidly decreasing. Remote (regional) altimeter settings are not allowed.

Note: The operational crosscheck between altimeter read-out and charted altitude values at FAF or other profile fixes does not protect against altimeter setting errors.

- b) Cold Temperature

When cold weather temperatures exist, the pilot should check the chart for the instrument approach procedure to determine the limiting temperature for the use of BARO-VNAV capability. If the airborne system contains a temperature compensation capability, manufacturer instructions should be followed for use of the BARO-VNAV function, and the operational use of the temperature compensation function must be authorised by the Air Navigation Service Provider.

A training programme should be structured to provide sufficient theoretical and practical training. An example of training syllabus is described in [Appendix 5](#).

### 10.3 Aerodrome competence and Operator verification

Before planning a flight to an aerodrome (destination or alternate) with the intent to use an RNAV procedure contained in the Navigation Database, the operator should determine the operational characteristics of the procedure in accordance with EU OPS 1.975 or the applicable operational regulations. Further details are provided in [Appendix 2](#).

Based on this assessment, the appropriate information should be given to the crew. If the aerodrome access requires a specific competence, the designated crew shall have a validated competence.

Note: This AMC addresses only RNP APCH procedures which are designed with straight segment (e.g. T or Y approach). It is therefore anticipated that in most cases no specific competence should be required to fly such approach procedure.

### 10.4 Navigation Database Management

10.4.1 Operator involved in the operation of aeroplanes for commercial air transportation

EU-OPS 1.873 for the management of navigation database applies.

10.4.2 Operator not involved in the operation of aeroplanes for commercial air transportation

The operators should not use a navigation database for RNP APCH operations unless the navigation database supplier holds a Type 2 Letter of Acceptance (LoA) or equivalent.

An EASA Type 2 LoA is issued by EASA in accordance with EASA OPINION Nr. 01/2005 on “The Acceptance of Navigation Database Suppliers” dated 14 Jan 05. The FAA issues a Type 2 LoA in accordance with AC 20-153, while Transport Canada (TCCA) issues an Acknowledgement Letter of an Aeronautical Data Process using the same basis. Both the FAA LoA and the TCCA Acknowledgement Letter are seen to be equivalent to the EASA LoA.

EUROCAE/RTCA document ED-76/DO-200A Standards for Processing Aeronautical Data contains guidance relating to the processes that the supplier may follow. The LoA demonstrates compliance with this standard.

#### 10.4.2.1 Non-approved Suppliers

If the operator’s supplier does not hold a Type 2 LoA or equivalent, the operator should not use the electronic navigation data products unless the Authority has approved the operator’s procedures for ensuring that the process applied and the delivered products have met equivalent standards of integrity. An acceptable methodology is described in [Appendix 3](#) of this AMC.

#### 10.4.2.3 Quality Monitoring

The operator should continue to monitor both the process and the products in accordance with the quality system required by the applicable operational regulations.

#### 10.4.2.4 Data Distribution

The operator should implement procedures that ensure timely distribution and insertion of current and unaltered electronic navigation data to all aircraft that require it.

### 10.5 Reportable Events

A reportable event is one that adversely affects the safety of the operation and may be caused by actions/events external to the operation of the aircraft navigation system. The operator should have in place a system for investigating such an event to determine if it is due to an improperly coded procedure, or a navigation data base error. Responsibility for initiating corrective action rests with the operator.

For those operators for whom approval is granted under EU OPS 1, the following events should be the subject of Occurrence Reports (see EU-OPS 1.420):

Technical defects and the exceeding of technical limitations, including:

- a) Significant navigation errors attributed to incorrect data or a data base coding error.
- b) Unexpected deviations in lateral/vertical flight path not caused by pilot input or erroneous operation of equipment.
- c) Significant misleading information without a failure warning.
- d) Total loss or multiple navigation equipment failure.

- e) Loss of integrity (e.g. RAIM) function whereas integrity was predicted to be available during the pre-flight planning.

## **11. AVAILABILITY OF DOCUMENTS**

JAA documents are available from the JAA publisher Information Handling Services (IHS). Information on prices, where and how to order is available on the JAA website and at [www.jaa.nl](http://www.jaa.nl).

EASA documents may be obtained from EASA (European Aviation Safety Agency), 101253, D-50452 Köln, Germany. Website: [www.easa.europa.eu](http://www.easa.europa.eu)

EUROCAE documents may be purchased from EUROCAE, 102 rue Etienne Dolet, 92240 MALAKOFF, France (Fax: 33 1 46 55 62 65). Website: <http://boutique.eurocae.net/catalog/>.

FAA documents may be obtained from Superintendent of Documents, Government Printing Office, Washington, DC 20402-9325, USA. Website: <http://www.gpoaccess.gov/>.

RTCA documents may be obtained from RTCA Inc, 1828 L Street, NW., Suite 805, Washington, DC 20036, USA (Tel: 1 202 833 9339; Fax 1 202 833 9434). Website: [www.rtca.org](http://www.rtca.org).

ICAO documents may be purchased from Document Sales Unit, International Civil Aviation Organisation, 999 University Street, Montreal, Quebec, Canada H3C 5H7, (Fax: 1 514 954 6769, e-mail: [sales\\_unit@icao.org](mailto:sales_unit@icao.org)) or through national agencies.

[Amdt 20/5]

## Appendix 1 to AMC 20-27 Glossary

ED Decision 2009/019/R

The following are definitions of key terms used throughout this AMC.

**Aircraft-Based Augmentation System (ABAS):** An augmentation system that augments and/or integrates the information obtained from the other GNSS elements with information available on board the aircraft.

**APV (Approach Procedure with Vertical guidance):** An instrument approach procedure which utilises lateral and vertical guidance but does not meet the requirements established for precision approach and landing operations.

**Area navigation (RNAV):** A method of navigation which permits aircraft operation on any desired flight path within the coverage of station-referenced navigation aids or within the limits of the capability of self-contained aids, or a combination of these.

**Accuracy:** The degree of conformance between the estimated, measured, or desired position and/or the velocity of a platform at a given time, and its true position or velocity. Navigation performance accuracy is usually presented as a statistical measure of system error and is specified as predictable, repeatable and relative.

**ASE (Altimetry System error):** Altimetry error refers to the electrical output and includes all errors attributable to the aircraft altimetry installation including position effects resulting from normal aircraft flight attitudes.

**Availability:** An indication of the ability of the system to provide usable service within the specified coverage area and is defined as the portion of time during which the system is to be used for navigation during which reliable navigation information is presented to the crew, automatic pilot, or other system managing the flight of the aircraft.

**BARO-VNAV (Barometric Vertical NAVigation)** is a navigation system that presents to the pilot a computed vertical guidance based on barometric altitude.

**Basic GNSS operation:** Operation that are based on GNSS Aircraft Based Augmentation System (ABAS). An ABAS system is typically a GNSS receiver with fault detection compliant to E/TSO C 129a, E/TSO-C145() or E/TSO-C146().

**Continuity of Function:** The capability of the total system (comprising all elements necessary to maintain aircraft position within the defined airspace) to perform its function without non-scheduled interruptions during the intended operation.

**DA(H):** Decision altitude (DA) or Decision height (DH). A specified altitude or height in the precision approach or approach with vertical guidance at which a missed approach must be initiated if the required visual reference to continue the approach has not been established.

**FAP:** Final Approach Point.

**Fault Detection and Exclusion (FDE):** FDE is a receiver processing scheme that autonomously provides integrity monitoring for the position solution, using redundant range measurements. The FDE consist of two distinct parts: fault detection and fault exclusion. The fault detection part detects the presence of an unacceptably large position error for a given mode of flight. Upon the detection, fault exclusion follows and excludes the source of the unacceptably large position error, thereby allowing navigation to return to normal performance without an interruption in service.

**GNSS stand-alone receiver:** A GNSS system incorporating the GNSS sensor, the navigation capability and the navigation data base.

**GNSS sensor:** A GNSS system incorporating only the GNSS receiving and positioning part. It doesn't incorporate the navigation capability and the navigation data base.

**HCE (Horizontal Coupling Error):** The vertical error component of an along track positioning error

**Integrity:** The ability of a system to provide timely warnings to users when the system should not be used for navigation.

**MDA(H):** Minimum descent altitude (MDA) or minimum descent height (MDH). A specified altitude or height in a non-precision approach or circling approach, below which, descent should not be made without the required visual reference.

**NSE (Navigation System Error):** The difference between true position and estimated position

**OCA/H:** In a precision approach procedure (or APV), the OCA/H is defined as the lowest altitude/height at which a missed approach must be initiated to ensure compliance with the appropriate obstacle clearance design criteria.

**On board Monitoring and Alerting function:** This function is the main element which determines if the navigation system complies with the necessary safety level associated to a RNP application; it relates to both lateral and longitudinal navigation performance. On-board performance monitoring and alerting allows the flight crew to detect that the RNAV system is not achieving the navigation performance required. On-board performance monitoring and alerting is concerned with the monitoring of all type of errors which may affect the aircraft ability to follow the desired flight path.

**TCH:** Threshold Crossing Height. The height of the Glide Path above the threshold.

**TSE (Total System Error):** The difference between true position and desired position. This error is equal to the root sum square (RSS) of the Flight Technical Error (FTE), Path Definition Error (PDE), and Navigation System Error (NSE).

**PDE (Path Definition Error):** The difference between the defined path and the desired path.

**Receiver Autonomous Integrity Monitoring (RAIM):** A technique whereby a GNSS receiver/processor determines the integrity of the GNSS navigation signals using only GPS signals or GPS signals augmented with altitude. This determination is achieved by a consistency check among redundant pseudorange measurements. At least one satellite in addition to those required for navigation should be in view for the receiver to perform the RAIM function.

**RNAV System:** A navigation system which permits aircraft operation on any desired flight path within the coverage of station-referenced navigation aids or within the limits of the capability of self-contained aids, or a combination of these. A RNAV system may be included as part of a Flight Management System (FMS).

**RNAV(GNSS) approach:** A GNSS RNAV approach promulgated by a State and designed in accordance with PANS-OPS Criteria Doc 8168, Volume II, Part III, Section 1, Chapter 2 and Section 3, Chapter 3 (Basic GNSS). Such approach should be flown by using an airborne RNAV system approved for RNP APCH operations.

**SBAS:** Satellite Based Augmentation System. SBAS augments core satellite constellation by providing ranging, integrity and correction information via geostationary satellites. This system comprises a network of ground reference stations that observe satellites signals, and master stations that process observed data and generate SBAS messages for uplink to the geostationary satellites, which broadcast the SBAS message to the users.

**RNP APCH:** RNP AProaCH. A RNP approach defined in the ICAO Performance Based Manual (PBN) manual. An approach equivalent to the RNAV (GNSS) one.

**TSO-C129()/ ETSO- C129a GPS Class A equipment:** Equipment incorporating both the GNSS sensor and navigation capability. This equipment incorporates RAIM as defined by TSO/ETSO-C129( ).

**TSO-C129( )/ ETSO-C129 a GPS Class B and C equipment:** GNSS sensor providing GNSS data (position, integrity,..) to an integrated navigation system (e.g. FMS).

**TSO-C146( ) Class GAMMA:** This functional class corresponds to equipment consisting of both the GNSS/SBAS position sensor and a navigation function, so that the equipment provides path deviations relative to a selected path. The equipment provides the navigation function required of a stand-alone navigation system. This equipment also provides integrity in the absence of SBAS signal through the use of FDE. In addition, this class of equipment requires a data base, display outputs and pilot controls.

**TSO-C145( ) class BETA:** Equipment consisting of a GNSS/SBAS sensor that determines position (with integrity) and provides position and integrity to an integrated navigation system (e.g. flight management system, multi-sensor navigation system). This equipment also provides integrity in the absence of the SBAS signal through the use of fault detection and exclusion (FDE).

**TSO-C146( ) or TSO-C145( ) Operational Class 1:** This operational class supports oceanic and domestic en-route, terminal and non precision approach, and departure operation.

**TSO- C146( ) or TSO-C145( ) Operational Class 2:** This operational class supports oceanic and domestic en-route, terminal and non precision approach, LNAV/VNAV and departure operation.

**TSO-C146( ) or TSO-C145( ) Operational Class 3:** This operational class supports oceanic and domestic en-route, terminal and non precision approach, LNAV/VNAV, LPV and departure operation.

**“T” approach:** T approach is defined in ICAO document 8168 and in RTCA/EUROCAE DO 201A/ED 77. “T” approach is composed of two initial approach segments perpendicular to the intermediate approach segment.

**Vertical Navigation:** A method of navigation which permits aircraft operation on a vertical flight profile using altimetry sources, external flight path references, or a combination of these.

**VPA (Vertical Path Angle):** Angle of the published final approach descent.

**VTF:** Vector To Final.

**VSR:** Reference Stall Speed.

**“Y” approach:** Y approach is defined in ICAO document 8168 and in RTCA/EUROCAE DO 201A/ED 77. “Y” approach is derived from the “T” approach but the initial segments are establishing at 70° to the intermediate segment rather than 90°.

[Amdt 20/5]

## Appendix 2 to AMC 20-27 Operational Characteristics of the Procedure and its Operational Use

ED Decision 2009/019/R

The operator should show evidence that consideration has been given to the evaluation of any new or modified RNP APCH procedures.

RNP APCH procedure should be designed using straight segments; the operator should check that the selected procedure fulfils this requirement.

Particular attention should be paid to procedures:

- in mountainous environments,
- within the proximity of well-known obstacles,
- that may require adequate knowledge for the aerodrome access or aerodrome competence qualification, as specified in EU-OPS 1.975 or the applicable operational requirements.

Competence may be required specifically for this RNAV procedure or the procedure may be published for an aerodrome already listed as requiring an aerodrome competence. This may be aircraft type related and subject to periodic revalidation.

- In the absence of radar coverage,
- When missed approach trajectory involve turns, especially at low altitudes,
- Subject to a declared exemption to the procedure design rules specified by the ICAO PANS OPS,
- Every other case considered necessary to be evaluated by the operator.

The operator may develop an internal process (e.g. filtering methods or tools covering the AIP review) to detect RNP APCH procedure(s) showing one or more of the above-listed characteristics.

The operational evaluation of a RNP APCH procedure showing evidence of the above-mentioned operational characteristics may include, at operator discretion, an approach conducted with the aircraft in VMC or the use of a full flight simulator (FFS) in order to evaluate if the procedure is correctly executed by the RNAV system and fly-able with the aircraft type.

[Amdt 20/5]



## Appendix 3 to AMC 20-27 Alternate Navigation Database Integrity Check

*ED Decision 2009/019/R*

If operator's navigation data base supplier has no Type 2 LOA, the operator should develop and describe a method to demonstrate an acceptable level of integrity of the navigation data base content used by the RNAV system on board the aircraft.

The operator should implement navigation data base integrity checks for all RNP APCH procedures they wish to operate, using manual verification procedures or appropriate software tools, at each AIRAC Cycle.

The objective of this integrity check is to identify any significant discrepancies between the published charts/procedures and the navigation database content.

Integrity checks may be conducted by a designated third party, under the operator responsibility.

### 1 Elements to be verified

At least the following elements of an RNP APCH should be verified:

- Coordinates/location verification of IAF, IF, FAF, MAPt, and other waypoints between IAF and MAPt (if any)
- Tracks between these waypoints
- Distance between these waypoints
- Vertical path angle (for APV BARO-VNAV operation)

### 2 Means to verify those elements

#### 2.1 The Operator verification process

The operator should, at the very least, verify the information listed in paragraph 1 of this Appendix, by comparison with the official published data.

As the data may evolve at each AIRAC Cycle, this verification should be done at every AIRAC cycle using comparison with source documents or a reference data base (gold standard).

The operator should describe the method used to verify the navigation data base integrity which can be based on a:

- a) manual method, with or without software support, whereby the airborne data base is compared with the original published data, or
- b) recurrent method with a reference database, whereby any changes identified between the latest data base and the reference data base are checked against the original published data. Once the latest data base has been verified, it becomes the reference data base for the next AIRAC cycle.

The recurrent method relies on the integrity of the initial data base, and requires that the check of every RNP APCH procedure has been properly conducted and validated at the very first time. It also relies on the assumption that every change in the data base is properly identified and checked. It is recommended that software tools are used to compare the contents of one (N) AIRAC cycle data base with the contents of the previous (N-1) AIRAC cycle data base.

Whatever the method, data to be checked must come from the final source to be loaded on the aircraft.

## 2.2 The means to enable this verification

In many cases, the RNAV system and an enhanced navigation display are necessary to access the data (on the aircraft or on a flight simulator).

An RNAV system comparable to the one installed on the aircraft (i.e. using the same algorithms) may also be used, as well as appropriate simulation software tools. The RNAV system manufacturer should be consulted on the adequacy of specific software for this purpose.

Data may also be acquired through a tool able of unpacking the data encoded on the files (e.g. decompactor) developed by the RNAV system manufacturer.

Whatever software tool is used, it should be validated for its intended use by the operator.

## 3 Feed back and reporting errors found

In case of errors found, the operator should take appropriate actions.

In particular, significant errors (i.e. those that would affect the flight path of the aircraft) should be reported to the database supplier and the competent authority and affected procedures should be prohibited by a company instruction or NOTAM.

Note: Integrity checks could be conducted for several operators by a same designated third party. In this case, it is strongly recommended that any problem recorded by this third party be reported to all its client operators.

[Amdt 20/5]

## Appendix 4 to AMC 20-27 Operational Procedures

ED Decision 2009/019/R

This Appendix should be used by the operator to amend the relevant parts and sections of the Operations Manual as described in 10.1 to support these types of operations.

### 1 Normal Procedures

#### 1.1 Pre-flight Planning

Operators and flight crew intending to conduct operations on RNP APCH procedures must file the appropriate flight plan suffixes. The on-board navigation data must be current and must include the appropriate procedures.

In addition to the normal pre-flight planning, the following additional checks must be carried out:

- a) The instrument approach chart should clearly identify the RNP APCH operation as RNAV<sub>(GNSS)</sub> or equivalent (e.g.: RNAV<sub>(GNSS)</sub> RWY 27,...). The operator should determine in accordance with the promulgated OCA(H) and the operational requirement (e.g. EU-OPS 1.430) the Minimum Descent Altitude/Height (MDA(H)) for LNAV approaches or the Decision Altitude/Height (DA(H)) for APV BARO-VNAV operation.
- b) Flight crew must ensure that RNP APCH procedures which may be used for the intended flight (including alternates aerodromes) are selectable from a valid navigation data base (current AIRAC cycle) and are not prohibited by a company instruction or NOTAM.

Flight crew could check approach procedures (including alternate aerodromes) as extracted by the system (e.g. CDU flight plan page) or presented graphically on the moving map, in order to confirm the correct loading and the reasonableness of the procedure content. The vertical path of the APV BARO-VNAV procedure could be checked as extracted from the navigation data base on the RNAV Man Machine Interface (e.g. MCDU).

If above verification is not satisfactory, the flight crew should not use the procedure, and not consider this approach(es) during the selection of aerodromes for the intended flight.

- c) Flight crew should ensure sufficient means are available to navigate and land at the destination or at an alternate aerodrome in the case of loss of RNP APCH airborne capability.

In particular, the pilot should check that:

- a non-RNP APCH procedure is available at the alternate, where a destination alternate is required
  - at least one non-RNP APCH procedure is available at the destination aerodrome, where a destination alternate is not required
- d) Operators and flight crews must take account of any NOTAMs or operator briefing material that could adversely affect the aircraft system operation, or the availability or suitability of the procedures at the airport of landing, or any alternate airport.

- e) If the missed approach procedures are based on conventional means (VOR, NDB), the appropriate airborne equipment required to fly this procedure must be installed in the aircraft and must be operational. The associated ground-based nav aids must also be operational.

If the missed approach procedure is based on RNAV (no conventional or dead reckoning missed approach available), the appropriate airborne equipment required to fly this procedure must be available and serviceable on board the aircraft.

- f) For those GNSS systems relying on RAIM, its availability 15 min before Estimated Time of Arrival (ETA) until 15 min after ETA should be verified during the pre-flight planning. In the event of a predicted continuous loss of fault detection of more than five (5) minutes, the flight planning should be revised (e.g. delaying the departure or planning a different approach procedure).

Note 1: For certain systems, prediction is not systematic but is only required in specific cases and shall be detailed in the relevant section of the AFM

Note 2: RAIM availability prediction services may be provided to users by the air navigation service provider (ANSP), an avionics manufacturer or other entities.

- g) Any MEL restriction should be observed

## 1.2 Prior to Commencing the Procedure

In addition to normal procedure prior to commencing the approach (before the IAF and in compatibility with crew workload), the flight crew must verify the correctness of the loaded procedure by comparison with the appropriate approach charts. This check must include:

- a) The waypoint sequence.
- b) Reasonableness of the tracks and distances of the approach legs, and the accuracy of the inbound course and mileage of the final approach segment.

Note: As a minimum, this check could be a simple inspection of a suitable map display.

- c) The vertical path angle.

For multi-sensor systems, the crew must verify during the approach that GNSS sensor is used for position computation.

For an RNAV system with ABAS requiring barometric corrected altitude, the current airport barometric altimeter setting, should be input at the appropriate time, consistent with the performance of the flight operation.

For those GNSS systems relying on RAIM and necessitating a check of its availability for RNP APCH, the flight crew should perform a new RAIM availability check if ETA is more than 15 minutes different from the ETA used during the pre-flight planning. This check is also performed automatically for ETSO/TSO-C129a Class A1 receiver, 2 NM before the FAF.

Note: Systems providing RNP alerts that reflect loss of GNSS integrity are considered acceptable and no flight crew RAIM availability check is required.

For APV BARO-VNAV operation, the crew must confirm the correct altimeter setting. The procedure must only be flown with:

- a) a current local altimeter setting source available; and
- b) the QNH/QFE, as appropriate, set on the aircraft's altimeters.

Procedures using a remote (regional) altimeter setting source cannot support APV BARO-VNAV approach.

For APV BARO-VNAV operation, pilots are responsible for any necessary cold temperature compensations to all published minimum altitudes/heights. This includes:

- a) the altitudes/heights for the initial and intermediate segment(s);
- b) the DA/H; and
- c) subsequent missed approach altitudes/heights.

APV BARO-VNAV procedures are not permitted when the aerodrome temperature is below the promulgated minimum aerodrome temperature for the procedure, unless the RNAV system is equipped with approved cold temperature compensation for the final approach.

ATC tactical interventions in the terminal area may include radar headings, 'direct to' clearances which by-pass the initial legs of an approach, interceptions of an initial or intermediate segments of an approach or the insertion of additional waypoints loaded from the data base. In complying with ATC instructions, the flight crew should be aware of the implications for the RNAV system.

- a) The manual entry of coordinates into the RNAV system by the flight crew for operation within the terminal area is not permitted.
- b) 'Direct to' clearances may be accepted to the Intermediate Fix (IF) provided that the resulting track change at the IF does not exceed 45°.

Note: Direct to clearance to FAF is not acceptable. Modifying the procedure to intercept the final approach course prior to the FAF is acceptable for radar vectored arrivals or at other times with ATC approval.

The lateral and vertical (for APV BARO-VNAV operation) definition of the flight path between the FAF and the Missed Approach Point (MAPt) must not be revised by the flight-crew under any circumstances.

### 1.3 During the Procedure

The final approach trajectory must be intercepted no later than the FAF in order for the aircraft to be correctly established on the final approach course before starting the descent (to ensure terrain and obstacle clearance).

The crew must check the RNAV approach mode annunciator (or equivalent) is properly indicating approach-mode integrity 2 NM before the FAF.

Note: This will not apply for certain RNAV system (e.g. aircraft already approved with demonstrated RNP capability). For such systems, other means are available including electronic map displays, flight guidance mode indications, etc., which clearly indicate to the crew that the approach mode is activated.

For APV BARO-VNAV operation, the crew should check that the two altimeters provide equivalent altitude (difference of 100 feet max) at or before FAF. This check must be made after the crew has set the correct altimeter setting.

The crew should also check the consistency between the VNAV guidance and the primary altimeters indications commensurate with pilot workload (e.g. after the aircraft is established on the vertical path).

During the descent, crew should check that the vertical speed is consistent with the VNAV angle to be flown.

The appropriate displays must be selected so that the following information can be monitored:

- a) The RNAV computed desired path (DTK), and
- b) Aircraft position relative to the lateral path (Cross-Track Deviation) for FTE monitoring
- c) Aircraft position relative to the vertical path (for APV BARO-VNAV operation)

The crew should respect all published altitude and speed constraints.

The procedure must be discontinued:

- a) If RNAV failure is annunciated (e.g. warning flag),
- b) If the NSE alarm is triggered (e.g. RAIM alert),
- c) In case of loss of the NSE alerting function (e.g. RAIM loss),
- d) If lateral or vertical (if provided) FTE is excessive,
- e) If VNAV trajectory is not consistent with aircraft altimetry system information or vertical speed information.

Note: Discontinuing the procedure may not be necessary for a multi-sensor RNAV system that includes demonstrated RNP capability without GNSS. Manufacturer documentation should be examined to determine the extent the system may be used in such configuration.

The missed approach must be flown in accordance with the published procedure. Use of the RNAV system during the missed approach is acceptable provided:

- a) The RNAV system is operational (e.g. no loss of function, no RAIM alert, no failure indication, etc.).
- b) The whole procedure (including the missed approach) is loaded from the navigation data base.

During the RNP APCH procedure, pilots must use a lateral deviation indicator, flight director and/or autopilot in lateral navigation mode.

Pilots of aircraft with a lateral deviation indicator (e.g. CDI) must ensure that lateral deviation indicator scaling (full-scale deflection) is suitable for the navigation accuracy associated with the various segments of the procedure (i.e.,  $\pm 1.0$  nm for the Initial and Intermediate segments,  $\pm 0.3$  nm for the Final Approach segment, and  $\pm 1.0$  nm for the Missed Approach segment).

All pilots are expected to maintain procedure centrelines, as depicted by on board lateral deviation indicators and/or flight guidance during all the approach procedure unless authorised to deviate by ATC or under emergency conditions.

For normal operations, cross-track error/deviation (the difference between the RNAV system computed path and the aircraft position relative to the path) should be limited to  $\pm \frac{1}{2}$  the navigation accuracy associated with the procedure (i.e., 0.5 nm for the Initial and Intermediate segments, 0.15 nm for the Final Approach segment, and 0.5 nm for the Missed Approach segment).

Brief deviations from this standard (e.g. overshoots or undershoots) during and immediately after turns, up to a maximum of 1 times the navigation accuracy (i.e., 1.0 nm for the Initial and Intermediate segments), are allowable.

In addition, during APV BARO-VNAV procedures pilots must use a vertical deviation indicator, flight director and/or autopilot in vertical navigation mode.

Deviations above and below the vertical path must not exceed  $\pm 75$  feet. Pilots must execute a Missed Approach if the vertical deviation exceeds the criteria above, unless the pilot has in sight the visual references required to continue the approach.

In the event of failure of one RNAV system during a procedure where two systems are necessary, the crew should abort the procedure if the failure occurs before FAF but could continue the approach if the failure occurs after FAF.

Use of GNSS altitude information by the crew is prohibited.

## **2 Abnormal Procedures**

Abnormal procedures to address Cautions and Warnings resulting from the following conditions should be developed:

- a) Failure of the RNAV system components, including those affecting Flight Technical Error (e.g. failures of the flight director or automatic pilot).
- b) RAIM (or equivalent) alert or loss of integrity function.

In the event of communications failure, the flight crew should continue with the procedure in accordance with published lost communication procedures.

The flight crew should notify ATC of any problem with the RNAV system that results in the loss of the approach capability.

[Amdt 20/5]

## Appendix 5 to AMC 20-27 Flight Crew Training Syllabus

*ED Decision 2009/019/R*

The flight crew training programme should be structured to provide sufficient theoretical and practical training, using a simulator, training device, or line training in an aircraft, in the concept of RNP APCH operations without or with vertical guidance (APV BARO-VNAV) and the use of the aircraft's RNAV system in such operations to ensure that pilots are not just task-oriented. The following syllabus should be considered as minimum amendment to the training programme to support RNP APCH including APV BARO-VNAV operations:

Note: Operators who are already using procedures to fly other types of approaches, may receive appropriate credit for common training and procedural elements.

### **1 General RNAV concepts including:**

1. Theory of RNAV including differences between types of RNAV operations
2. Limitations of RNAV
3. Limitations of BARO-VNAV
4. Charting and database issues including:
  - i. Waypoint naming concepts
  - ii. Vertical path angle
  - iii. Fly-by and fly-over waypoints
5. Use of RNAV equipment including:
  - i. Verification and sensor management
  - ii. Tactically modifying the flight plan
  - iii. Addressing discontinuities
  - iv. Entering associated data such as:
    - Wind
    - Altitude/speed constraints
    - Vertical profile/vertical speed
6. Use of lateral navigation mode(s) and associated lateral control techniques
7. Use of vertical navigation mode(s) and associated vertical control techniques
8. R/T phraseology for RNAV operations
9. The implication for RNAV operations of systems malfunctions which are not RNAV related (e.g. hydraulic or engine failure)

### **2 RNP APCH concepts including:**

1. Definition of RNP APCH operations and its direct relationship with RNAV (GNSS) procedures.
2. Regulatory requirements for RNP APCH operations
3. Required navigation equipment for RNP APCH operations:
  - i. GPS concepts and characteristics



- ii. RNP/ANP requirements
- iii. RAIM
- iv. BARO-VNAV
- v. MEL
4. Procedure characteristics
  - i. Chart depiction
  - ii. Aircraft display depiction
  - iii. Minima
5. Retrieving a RNP APCH (or a RNAV(GNSS)) approach procedure from the data base
6. Procedure change at destination airport, change arrival airport and alternate airport
7. Flying the procedure:
  - i. Use of autopilot, auto throttle and flight director
  - ii. Flight Guidance (FG) mode behaviour
  - iii. Lateral and vertical path management
  - iv. Adherence to speed and/or altitude constraints
  - v. Fly direct to a waypoint
  - vi. Determine lateral and vertical-track error/deviation
  - vii. Fly interception of an initial or intermediate segment of an approach following ATC notification
  - viii. Where the RNAV system supports interception of the extended final approach segment then flight crew should be trained in use of the function.
  - ix. The use of other aircraft equipment to support track monitoring, weather and obstacle avoidance
  - x. Contingency procedures in case of lateral mode failure (LNAV) and/or vertical mode failure (VNAV)
8. For APV BARO-VNAV operation, a clear understanding of specific crew requirements:
  - i. for comparisons of VNAV guidance with primary altimeter information
  - ii. for altitude crosschecks between primary altimeters (e.g. altimetry comparisons of 100 feet),
  - iii. for temperature limitations on instrument procedures
  - iv. for altimeter settings in term of currency, accuracy and integrity.
9. The effect of temperature deviation and its compensation
10. ATC procedures
11. Abnormal procedures
12. Contingency procedures

[Amdt 20/5]

## AMC 20-29

### AMC 20-29 Composite Aircraft Structure

*ED Decision 2010/003/R*

#### 1. PURPOSE

This AMC provides an acceptable means, but not the only means, for airworthiness certification of composite aircraft structures. Guidance information is also presented on the closely related design, manufacturing and maintenance aspects. This AMC primarily addresses carbon and glass fibre reinforced plastic structures, although many aspects of this document are also applicable to other forms of structure, e.g. metal bonded structure, wooden structure, etc.

Note: When applying this guidance to other forms of structure, additional design considerations may be necessary and other appropriate references should also be consulted.

#### 2. OBJECTIVE

AMC 20-29 standardises recognised good design practices common to composite aircraft structures in one document.

For rotorcraft, AMC 20-29 complements existing AMC to CS-27 and CS-29 (referring to FAA AC 27-1B MG8 and AC 29-2C MG8).

#### 3. APPLICABILITY

This AMC provides Acceptable Means of Compliance with the provisions of CS-23, CS-25, CS-27 and CS-29. Many of the concepts included in this AMC may also be applicable in part or in full to other CSs. However, when using this AMC as an Acceptable Means of Compliance for these other CSs, appropriate engineering judgement should be exercised and early agreement with the Agency sought.

This AMC applies to: applicants for a type-certificate, restricted type-certificate or supplemental type-certificate; certificate/approval holders; parts manufacturers; material suppliers; and maintenance and repair organisations.

Note: The technical content of this AMC is harmonised with FAA Advisory Circular AC 20-107B, dated 8 September 2009.

#### 4. RELATED REGULATIONS AND GUIDANCE

- a. Applicable paragraphs are listed in [Appendix 1](#).
- b. Relevant guidance considered complementary to this AMC is provided in [Appendix 1](#).

#### 5. GENERAL

- a. The procedures outlined in this AMC provide Acceptable Means of Compliance and Guidance Material for composite structures, particularly those that are essential in maintaining the overall flight safety of the aircraft ("critical structure" as defined in [Appendix 2](#)). This AMC is published to aid in the evaluation of certification programmes for composite applications and to reflect the current status of composite technology. It is expected that this AMC will be modified periodically to reflect the continued evolution of composite technology and the data collected from service experience and expanding applications.
- b. There are factors unique to the specific composite materials and processes used for a given application. For example, the environmental sensitivity, anisotropic properties, and

heterogeneous nature of composites can make the determination of structural failure loads, modes, and locations difficult. The reliability of such evaluation depends on repeatable structural details created by scaled manufacturing or repair processes. The extent of testing and/or analysis may differ for a structure depending upon the criticality to flight safety, expected service usage, the material and processes selected, the design margins, the failure criteria, the database and experience with similar structures, and on other factors affecting a particular structure. It is expected that these factors will be considered when interpreting this AMC for use on a specific application.

- c. Definitions of terms used in this AMC can be found in [Appendix 2](#).

## **6. MATERIAL AND FABRICATION DEVELOPMENT**

All composite materials and processes used in structures are qualified through enough fabrication trials and tests to demonstrate a reproducible and reliable design. One of the important features of composite construction is the degree of care needed in the procurement and processing of composite materials. The final mechanical behaviour of a given composite material may vary greatly depending on the processing methods employed to fabricate production parts. Special care needs to be taken in controlling both the materials being procured and how the material is processed once delivered to the fabrication facility. The CSs (namely paragraphs 2x.603 and 2x.605) specify the need to procure and process materials under approved material and process specifications that control the key parameters governing performance. These paragraphs outline a need to protect structures against the degradation possible in service. They also require that the design account for any changes in performance (e.g., environmental and variability effects) permitted by material and process specifications.

### **a. Material and Process Control**

- (1) Specifications covering material, material processing, and fabrication procedures are established to ensure a basis for fabricating reproducible and reliable structure. Material specifications are required to ensure consistent material can be procured, and batch acceptance testing or statistical process controls are used to ensure material properties do not drift over time. Specifications covering processing procedures should be developed to ensure that repeatable and reliable structure can be manufactured. The means of processing qualification and acceptance tests defined in each material specification should be representative of the expected applicable manufacturing process. The process parameters for fabricating test specimens should match the process parameters to be used in manufacturing actual production parts as closely as possible. Both test and production parts must conform to material and process specifications.
- (2) Once the fabrication processes have been established, changes should undergo additional qualification, including testing of differences, before being implemented, (refer to [Appendix 3](#)). It is important to establish processing tolerances, material handling and storage limits, and key characteristics, which can be measured and tracked to judge part quality.
- (3) Material requirements identified in procurement specifications should be based on the qualification test results for samples produced using the related process specifications. Qualification data must cover all properties important to the control of materials (composites and adhesives) and processes to be used for production of composite structure. Carefully selected physical, chemical, and mechanical qualification tests are used to demonstrate the formulation, stiffness, strength, durability, and reliability of materials and processes for aircraft applications. It is

recommended that airframe designers and manufacturers work closely with material suppliers to properly define material requirements.

- (4) To provide an adequate design database, environmental effects on critical properties of the material systems and associated processes should be established. In addition to testing in an ambient environment, variables should include extreme service temperature and moisture content conditions and effects of long-term durability. Qualification tests for environmental effects and long-term durability are particularly important when evaluating the materials, processes, and interface issues associated with structural bonding (refer to paragraph 6.c for related guidance).
- (5) Key characteristics and processing parameters should be specified and monitored for in-process quality control. The overall quality control plan required by the certifying agency should involve all relevant disciplines, i.e., engineering, manufacturing, and quality control. A reliable quality control system should be in place to address special engineering requirements that arise in individual parts or areas as a result of potential failure modes, damage tolerance and flaw growth requirements, loadings, inspectability, and local sensitivities to manufacture and assembly.
- (6) Tolerances permitted by the material and process specifications should be substantiated by analysis supported by test evidence, or tests at the coupon, element or sub-component level. For new production methods, repeatable processes should be demonstrated at sufficient structural scale in a way shown to be consistent with the material and process qualification tests and development of the associated specifications. This will require integration of the technical issues associated with product design and manufacturing details prior to a large investment in structural tests and analysis correlation. It will also ensure the relevance of quality control procedures defined to control materials and processes as related to the product structural details.
- (7) Note that the Agency does not certify materials and processes. However, materials and processes specifications are part of the type-design subject to type-certification. Appropriate certification credit may be given to products and organisations using the same materials and processes in similar applications subject to substantiation and applicability. In some cases, material and processing information may become part of accepted shared databases used throughout the industry. New users of shared qualification databases must control the associated materials and processes through proper use of the related specifications and demonstrate their understanding by performing equivalency sampling tests for key properties. Note that materials and processes used in European Technical Standard Order (ETSO) articles or authorisations must also be qualified and controlled.

**b. Design Considerations for Manufacturing Implementation**

- (1) Process specifications and manufacturing documentation are needed to control composite fabrication and assembly. The environment and cleanliness of facilities are controlled to a level validated by qualification and proof of structure testing. Raw and ancillary materials are controlled to specification requirements that are consistent with material and process qualifications. Parts fabricated should meet design drawing tolerances obtained from the production tolerances validated in qualification, design data development, and proof of structure tests. Some key

fabrication process considerations requiring such control include: (i) material handling and storage, (ii) laminate layup and bagging (or other alternate process steps for non-laminated material forms and advanced processes), (iii) mating part dimensional tolerance control, (iv) part cure (thermal management), (v) machining and assembly, (vi) cured part inspection and handling procedures, and (vii) technician training for specific material, processes, tooling and equipment.

- (2) Substantiating data is needed for design to justify all known defects, damage and anomalies allowed to remain in service without rework or repair. Adequate manufacturing records support the identification and substantiation of known defects, damage and anomalies.
- (3) Additional substantiating design data is needed from new suppliers of parts previously certificated. This may be supported by manufacturing trials and quality assessments to ensure equivalent production and repeatability. Some destructive inspection of critical structural details is needed for manufacturing flaws that are not end item inspectable and require process controls to ensure reliable fabrication.

**c. Structural Bonding**

Bonded structures include multiple interfaces (e.g., composite-to-composite, composite-to-metal, or metal-to-metal), where at least one of the interfaces requires additional surface preparation prior to bonding. The general nature of technical parameters that govern different types of bonded structures are similar. A qualified bonding process is documented after demonstrating repeatable and reliable processing steps such as surface preparation. It entails understanding the sensitivity of structural performance based upon expected variation permitted per the process. Characterisation outside the process limits is recommended to ensure process robustness. In the case of bonding composite interfaces, a qualified surface preparation of all previously cured substrates is needed to activate their surface for chemical adhesion. For all bonding interfaces, regardless if on metallic or previously cured composite substrates, a qualified surface preparation is needed to activate their surface for chemical adhesion. Many technical issues for bonding require cross-functional teams for successful applications. Applications require stringent process control and a thorough substantiation of structural integrity.

- (1) Many bond failures and problems in service have been traced to invalid qualifications or insufficient quality control of production processes. Physical and chemical tests may be used to control surface preparation, adhesive mixing, viscosity, and cure properties (e.g., density, degree of cure, glass transition temperature). Lap shear stiffness and strength are common mechanical tests for adhesive and bond process qualification. Shear tests do not provide a reliable measure of long-term durability and environmental degradation associated with poor bonding processes (i.e., lack of adhesion). Some type of peel test has proven more reliable for evaluating proper adhesion. Without chemical bonding, the so-called condition of a “weak bond” exists when the bonded joint is either loaded by peel forces or exposed to the environment over a long period of time, or both. Adhesion failures, which indicate the lack of chemical bonding between substrate and adhesive materials, are considered an unacceptable failure mode in all test types. Material or bond process problems that lead to adhesion failures are solved before proceeding with qualification tests.

- (2) Process specifications are needed to control adhesive bonding in manufacturing and repair. A “process control mentality”, which includes a combination of in-process inspections and tests, has proven to be the most reliable means of ensuring the quality of adhesive bonds. The environment and cleanliness of facilities used for bonding processes are controlled to a level validated by qualification and proof of structure testing. Adhesives and substrate materials are controlled to specification requirements that are consistent with material and bond process qualifications. The bonding processes used for production and repair meet tolerances validated in qualification, design data development, and proof of structure tests. Some key bond fabrication process considerations requiring such control include: (i) material handling and storage, (ii) bond surface preparation, (iii) mating part dimensional tolerance control, (iv) adhesive application and clamp-up pressure, (v) bond line thickness control, (vi) bonded part cure (thermal management), (vii) cured part inspection and handling procedures, and (viii) bond technician training for specific material, processes, tooling and equipment. Bond surface preparation and subsequent handling controls leading up to the bond assembly and cure must be closely controlled in time and exposure to environment and contamination.
- (3) CS 23.573(a) sets the certification specification for primary composite airframe structures, including considerations for damage tolerance, fatigue, and bonded joints. Although this is a small aeroplane rule, the same performance standards are normally expected for large aeroplanes and rotorcraft (via special conditions and CRIs).
- (a) For bonded joints, CS 23.573(a)(5) states:
- "For any bonded joint, the failure of which would result in catastrophic loss of the aeroplane, the limit load capacity must be substantiated by one of the following methods:*
- (i) The maximum disbonds of each bonded joint consistent with the capability to withstand the loads in paragraph (a)(3) of this section must be determined by analysis, tests, or both. Disbonds of each bonded joint greater than this must be prevented by design features; or*
  - (ii) Proof testing must be conducted on each production article that will apply the critical limit design load to each critical bonded joint; or*
  - (iii) Repeatable and reliable non-destructive inspection techniques must be established that ensure the strength of each joint."*
- (b) These options do not supersede the need for a qualified bonding process and rigorous quality controls for bonded structures. For example, fail safety implied by the first option is not intended to provide adequate safety for the systematic problem of a bad bonding process applied to a fleet of aircraft structures. Instead, it gives fail safety against bonding problems that may occasionally occur over local areas (e.g., insufficient local bond contact pressure or contamination). Performing static proof tests to limit load, which is the second option, may not detect weak bonds requiring environmental exposure and time to degrade bonded joint strength. This issue should be covered by adequately demonstrating that qualified bonding materials and processes have long-term environmental durability. Finally, the third option

is open for future advancement and validation of non-destructive inspection (NDI) technology to detect weak bonds, which degrade over time and lead to adhesion failures. Such technology has not been reliably demonstrated at a production scale to date.

- (4) Adhesion failures are an unacceptable failure mode for bonded structure that require immediate action by the responsible engineers to identify the specific cause and isolate all affected parts and assemblies for directed inspection and repair. Depending on the suspected severity of the bonding problem, an airworthiness directive may be required to restore the affected aircraft to an airworthy condition. Any design, manufacturing or repair details linked to the bonding problem should also be permanently corrected.

d. Environmental Considerations

Environmental design criteria should be developed that identify the critical environmental exposures, including humidity and temperature, to which the material in the application under evaluation may be exposed. Service data (e.g., moisture content as a function of time in service) can be used to ensure such criteria are realistic. In addition, the peak temperatures for composite structure installed in close proximity to aircraft systems that generate thermal energy need to be identified for worst-case normal operation and system failure cases. Environmental design criteria are not required where existing data demonstrate that no significant environmental effects, including the effects of temperature and moisture, exist for the material system and construction details, within the bounds of environmental exposure being considered.

- (1) Experimental evidence should be provided to demonstrate that the material design values or allowables are attained with a high degree of confidence in the appropriate critical environmental exposures to be expected in service. It should be realised that the worst case environment may not be the same for all structural details (e.g., hot wet conditions can be critical for some failure modes, while cold dry conditions may be worse for others). The effect of the service environment on static strength, fatigue and stiffness properties and design values should be determined for the material system through tests, e.g., accelerated environmental tests, or from applicable service data. The maximum moisture content considered is related to that possible during the service life, which may be a function of a given part thickness, moisture diffusion properties and realistic environmental exposures. The effects of environmental cycling (i.e., moisture and temperature) should be evaluated when the application involves fluctuations or unique design details not covered in the past. Existing test data may be used where it can be shown to be directly applicable to the material system, design details, and environmental cycling conditions characteristic of the application. All accelerated test methods should be representative of real-time environmental and load exposure. Any factors used for acceleration that chemically alter the material (e.g., high temperatures that cause post-cure) should be avoided to ensure behaviour representative of real environmental exposures.
- (2) Depending on the design configuration, local structural details, and selected processes, the effects of residual stresses that depend on environment should be addressed (e.g., differential thermal expansion of attached parts).

**e. Protection of Structure**

Weathering, abrasion, erosion, ultraviolet radiation, and chemical environment (glycol, hydraulic fluid, fuel, cleaning agents, etc.) may cause deterioration in a composite structure. Suitable protection against and/or consideration of degradation in material properties should be provided for conditions expected in service and demonstrated by test and/or appropriate validated experience. Where necessary, provide provisions for ventilation and drainage. Isolation layers are needed at the interfaces between some composite and metal materials to avoid corrosion (e.g., glass plies are used to isolate carbon composite layers from aluminium). In addition, qualification of the special fasteners and installation procedures used for parts made from composite materials need to address the galvanic corrosion issues, as well as the potential for damaging the composite (delamination and fibre breakage) in forming the fastener.

**f. Design Values**

Data used to derive design values must be obtained from stable and repeatable material that conforms to mature material and representative production process specifications. This will ensure that the permitted variability of the production materials is captured in the statistical analysis used to derive the design values. Design values derived too early in the material's development stage, before raw material and composite part production processes have matured, may not satisfy the intent of the associated rules. Laminated material system design values should be established on the laminate level by either test of the laminate or by test of the lamina in conjunction with a test validated analytical method. Similarly, design values for non-laminated material forms and advanced composite processes must be established at the scale that best represents the material as it appears in the part or by tests of material substructure in conjunction with a test validated analytical method.

**g. Structural Details**

For a specific structural configuration of an individual component (point design), design values may be established which include the effects of appropriate design features (holes, joints, etc.). Specific metrics that quantify the severity of composite structural damage states caused by foreign impact damage threats are needed to perform analysis (i.e., the equivalent of a metallic crack length). As a result, testing will often be needed to characterise residual strength, including the structural effects of critical damage location and combined loads. Different levels of impact damage are generally accommodated by limiting the design strain levels for ultimate and limit combined load design criteria. In this manner, rational analyses supported by tests can be established to characterise residual strength for point design details.

**7. PROOF OF STRUCTURE – STATIC**

The structural static strength substantiation of a composite design should consider all critical load cases and associated failure modes. It should also include effects of environment (including residual stresses induced during the fabrication process), material and process variability, non-detectable defects or any defects that are allowed by the quality control, manufacturing acceptance criteria, and service damage allowed in maintenance documents of the end product. The static strength of the composite design should be demonstrated through a programme of component ultimate load tests in the appropriate environment, unless experience with similar designs, material systems, and loadings is available to demonstrate the adequacy of the analysis supported by sub-component, element and coupon tests, or component tests to accepted



lower load levels. The necessary experience to validate an analysis should include previous component ultimate load tests with similar designs, material systems, and load cases.

- a. The effects of repeated loading and environmental exposure which may result in material property degradation should be addressed in the static strength evaluation. This can be shown by analysis supported by test evidence, by tests at the coupon, element or sub-component level, as appropriate, or alternatively by relevant existing data. Earlier discussions in this AMC address the effects of environment on material properties (paragraph 6.d) and protection of structure (paragraph 6.e). For critical loading conditions, three approaches exist to account for prior repeated loading and/or environmental exposure in the full-scale static test.
  - (1) In the first approach, the full-scale static test should be conducted on structure with prior repeated loading and conditioned to simulate the critical environmental exposure and then tested in that environment.
  - (2) The second approach relies upon coupon, element, and sub-component test data to determine the effect of repeated loading and environmental exposure on static strength. The degradation characterised by these tests should then be accounted for in the full-scale static strength demonstration test (e.g., overload factors), or in analysis of these results (e.g., showing a positive margin of safety with design values that include the degrading effects of environment and repeated load).
  - (3) In practice, aspects of the first two approaches may be combined to obtain the desired result (e.g., a full scale static test may be performed at critical operating temperature with a load factor to account for moisture absorbed over the aircraft structure's life). Alternate means to account for environment using validated tests and analyses (e.g., an equivalent temperature enhancement to account for the effect of moisture without chemically altering the material), may be proposed by the applicant.
- b. The strength of the composite structure should be reliably established, incrementally, through a programme of analysis and a series of tests conducted using specimens of varying levels of complexity. Often referred to in industry as the "building block" approach, these tests and analyses at the coupon, element, details, and sub-component levels can be used to address the issues of variability, environment, structural discontinuity (e.g., joints, cut-outs or other stress risers), damage, manufacturing defects, and design or process-specific details. Typically, testing progresses from simple specimens to more complex elements and details over time. This approach allows the data collected for sufficient analysis correlation and the necessary replicates to quantify variations occurring at the larger structural scales to be economically obtained. The lessons learned from initial tests also help avoid early failures in more complex full-scale tests, which are more costly to conduct and often occur later in a certification programme schedule.
  - (1) Figures 1 and 2 provide a conceptual schematic of tests typically included in the building block approach for a fixed wing and tail rotor blade structures, respectively. The large quantity of tests needed to provide a statistical basis comes from the lowest levels (coupons and elements) and the performance of structural details are validated in a lesser number of sub-component and component tests. Detail and subcomponent tests may be used to validate the ability of analysis methods to predict local strains and failure modes. Additional statistical considerations (e.g., repetitive point design testing and/or component overload

factors to cover material and process variability) will be needed when analysis validation is not achieved. The static strength substantiation programme should also consider all critical loading conditions for all Critical Structure. This includes an assessment of residual strength and stiffness requirements after a predetermined length of service, which takes into account damage and other degradation due to the service period.

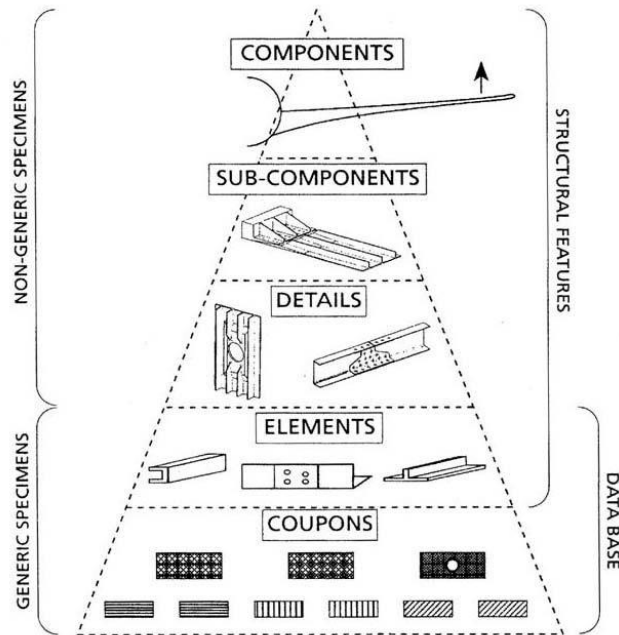

Figure 1 - Schematic diagram of building block tests for a fixed wing.

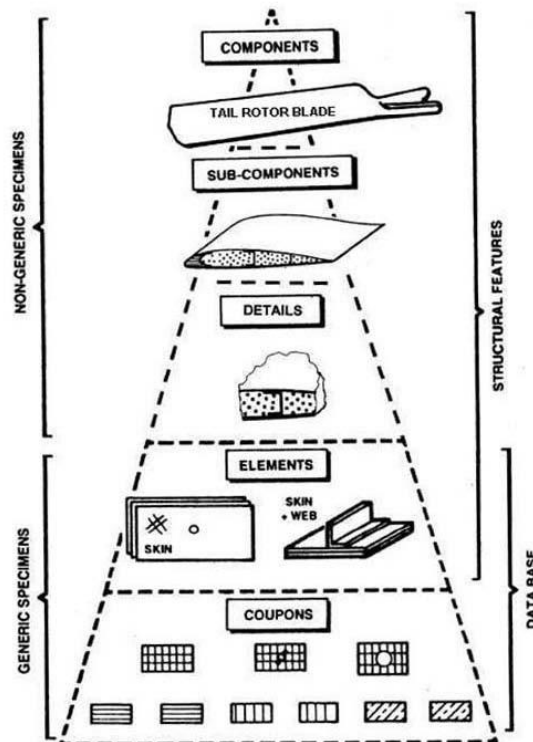

Figure 2 - Schematic diagram of building block tests for a tail rotor blade.

- (2) Successful static strength substantiation of composite structures has traditionally depended on proper consideration of stress concentrations (e.g., notch sensitivity of details and impact damage), competing failure modes and out-of-plane loads. A complete building block approach to composite structural substantiation addresses most critical structural issues in test articles with increasing levels of complexity so that many areas of reliable performance can be demonstrated prior to the component tests. The details and sub-component testing should establish failure criteria and account for impact damage in assembled composite structures. Component tests are needed to provide the final validation accounting for combined loads and complex load paths, which include some out-of-plane effects. When using the building block approach, the critical load cases and associated failure modes would be identified for component tests using the analytical methods, which are supported by test validation.
- c. The component static test may be performed in an ambient atmosphere if the effects of the environment are reliably predicted by building block tests and are accounted for in the static test or in the analysis of the results of the static test.
  - d. The static test articles should be fabricated and assembled in accordance with production specifications and processes so that the test articles are representative of production structure including defects consistent with the limits established by manufacturing acceptance criteria.
  - e. The material and processing variability of the composite structure should be considered in the static strength substantiation. This is primarily achieved by establishing sufficient process and quality controls to manufacture structure and reliably substantiate the required strength by test and analysis. The scatter in strength properties due to variability in materials and processes are characterised by proper allowables or design values, which are derived in compliance with CS 2x.613. When the detail, sub-component and component tests show that local strains are adequately predicted and positive margins of safety exist using a validated analysis everywhere on the structure, then proof of static strength is said to be substantiated using analysis supported by test evidence. Alternatively, in the absence of sufficient building block test data and analysis validation, overloads are needed in the component test to gain proof of static strength for the structure using an approach referred to as substantiated by tests. The overload factors applied in this case need to be substantiated either through tests or past experience and must account for the expected material and process variation.
  - f. It should be shown that impact damage that can be expected from manufacturing and service, but not more than the established threshold of detectability for the selected inspection procedure, will not reduce the structural strength below ultimate load capability. This can be shown by analysis supported by test evidence, or by a combination of tests at the coupon, element, sub-component and component levels. The realistic test assessment of impact damage requires proper consideration of the structural details and boundary conditions. When using a visual inspection procedure, the likely impact damage at the threshold of reliable detection has been called barely visible impact damage (BVID). Selection of impact sites for static strength substantiation should consider the criticality of the local structural detail, and the ability to inspect a location. The size and shape of impactors used for static strength substantiation should be consistent with likely impact damage scenarios that may go undetected for the life of an aircraft. Note that it is possible for some designs to have detectable impact damage and still meet static strength

loads and other requirements without repair (refer to allowable damage discussions in paragraph 10.c(1)).

- g. Major material and process changes on existing certified structure require additional static strength substantiation (e.g., refer to [Appendix 3](#)).

## **8. PROOF OF STRUCTURE – FATIGUE AND DAMAGE TOLERANCE**

The evaluation of composite structure should be based on the applicable certification specifications identified in the type-certification basis. Such evaluation must show that catastrophic failure due to fatigue, environmental effects, manufacturing defects, or accidental damage will be avoided throughout the operational life of the aircraft. The nature and extent of analysis or tests on complete structures and/or portions of the primary structure will depend upon applicable previous fatigue/damage tolerant designs, construction, tests, and service experience on similar structures. In the absence of experience with similar designs, Agency-approved structural development tests of components, sub-components, and elements should be performed (following the same principles discussed in paragraph 7.b and [Appendix 3](#)). The following considerations are unique to the use of composite material systems and provide guidance for the method of substantiation selected by the applicant. When establishing details for the damage tolerance and fatigue evaluation, attention should be given to a thorough damage threat assessment, geometry, inspectability, good design practice, and the types of damage/degradation of the structure under consideration.

- Composite damage tolerance and fatigue performance is strongly dependent on structural design details (e.g., skin laminate stacking sequence, stringer or frame spacing, stiffening element attachment details, damage arrestment features, and structural redundancy).
- Composite damage tolerance and fatigue evaluations require substantiation in component tests unless experience with similar designs, material systems, and loadings is available to demonstrate the adequacy of the analysis supported by coupons, elements, and sub-component tests.
- Final static strength, fatigue, and damage tolerance substantiation may be gained in testing a single component test article if sufficient building block test evidence exists to ensure that the selected sequence of repeated and static loading yield results representative of that possible in service or provide a conservative evaluation.
- Peak repeated loads are needed to practically demonstrate the fatigue and damage tolerance of composite aircraft structure in a limited number of component tests. As a result, metal structures present in the test article generally require additional consideration and testing. The information contained in AMC 25.571 provides fatigue and damage tolerance guidance for metallic structures.

### **a. Damage Tolerance Evaluation**

- (1) Damage tolerance evaluation starts with identification of structure whose failure would reduce the structural integrity of the aircraft. A damage threat assessment must be performed for the structure to determine possible locations, types, and sizes of damage considering fatigue, environmental effects, intrinsic flaws, and foreign object impact or other accidental damage (including discrete source) that may occur during manufacture, operation or maintenance.
  - (a) Currently, there are very few industry standards that outline the critical damage threats for particular composite structural applications with enough

detail to establish the necessary design criteria or test and analysis protocol for complete damage tolerance evaluation. In the absence of standards, it is the responsibility of individual applicants to perform the necessary development tasks to establish such data in support of product substantiation. Some factors to consider in development of a damage threat assessment for a particular composite structure include part function, location on the aircraft, past service data, accidental damage threats, environmental exposure, impact damage resistance, durability of assembled structural details (e.g., long-term durability of bolted and bonded joints), adjacent system interface (e.g., potential overheating or other threats associated with system failure), and anomalous service or maintenance handling events that can overload or damage the part. As related to the damage threat assessment and maintenance procedures for a given structure, the damage tolerance capability and ability to inspect for known damage threats should be developed.

- (b) Foreign object impact is a concern for most composite structures, requiring attention in the damage threat assessment. This is needed to identify impact damage severity and detectability for design and maintenance. It should include any available damage data collected from service plus an impact survey. An impact survey consists of impact tests performed with representative structure, which is subjected to boundary conditions characteristic of the real structure. Many different impact scenarios and locations should be considered in the survey, which has a goal of identifying the most critical impacts possible (i.e., those causing the most serious damage but are least detectable). When simulating accidental impact damage at representative energy levels, blunt or sharp impactors of different sizes and shapes should be selected to cause the most critical and least detectable damage, according to the load conditions (e.g., tension, compression or shear). Until sufficient service experience exists to make good engineering judgments on energy and impactor variables, impact surveys should consider a wide range of conceivable impacts, including runway or ground debris, hail, tool drops, and vehicle collisions. This consideration is important to the assumptions needed for use of probabilistic damage threat assessments in defining design criteria, inspection methods, and repeat inspection intervals for maintenance. Service data collected over time can better define impact surveys and design criteria for subsequent products, as well as establish more rational inspection intervals and maintenance practice. In review of such information, it should be realised that the most severe and critical impact damages, which are still possible, may not be part of the service database.
- (c) Once a damage threat assessment is completed, various damage types can be classified into five categories of damage as described below (refer to figure 3). These categories of damage are used for communication purposes in this AMC. Other categories of damage, which help outline a specific path to fatigue and damage tolerance substantiation, may be used by applicants in agreement with the regulatory authorities.

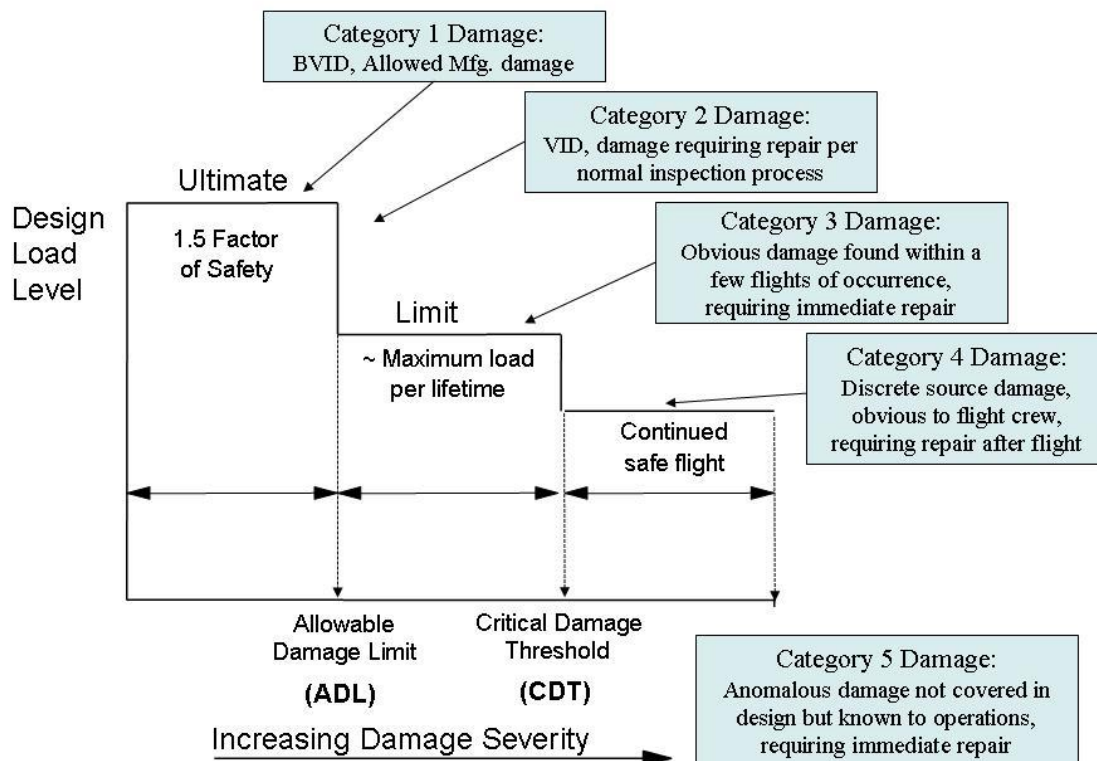

Figure 3 - Schematic diagram showing design load levels versus categories of damage severity.

Category 1: Allowable damage that may go undetected by scheduled or directed field inspection and allowable manufacturing defects. Structural substantiation for Category 1 damage includes demonstration of a reliable service life, while retaining ultimate load capability. By definition, such damage is subjected to the requirements and guidance associated with paragraph 7 of this AMC. Some examples of Category 1 damage include BVID and allowable defects caused in manufacturing or service (e.g., small delamination, porosity, small scratches, gouges, and minor environmental damage) that have substantiation data showing ultimate load is retained for the life of an aircraft structure.

Category 2: Damage that can be reliably detected by scheduled or directed field inspections performed at specified intervals. Structural substantiation for Category 2 damage includes demonstration of a reliable inspection method and interval while retaining loads above limit load capability. The residual strength for a given Category 2 damage may depend on the chosen inspection interval and method of inspection. Some examples of Category 2 damage include visible impact damage (VID), VID (ranging in size from small to large), deep gouges or scratches, manufacturing mistakes not evident in the factory, detectable delamination or debonding, and major local heat or environmental degradation that will sustain sufficient residual strength until found. This type of damage should not grow or, if slow or arrested growth

occurs, the level of residual strength retained for the inspection interval is sufficiently above limit load capability.

Category 3: Damage that can be reliably detected within a few flights of occurrence by operations or ramp maintenance personnel without special skills in composite inspection. Such damage must be in a location such that it is obvious by clearly visible evidence or cause other indications of potential damage that becomes obvious in a short time interval because of loss of the part form, fit or function. Both indications of significant damage warrant an expanded inspection to identify the full extent of damage to the part and surrounding structural areas. In practice, structural design features may be needed to provide sufficient large damage capability to ensure limit or near limit load is maintained with easily detectable, Category 3 damage. Structural substantiation for Category 3 damage includes demonstration of a reliable and quick detection, while retaining limit or near limit load capability. The primary difference between Category 2 and 3 damages are the demonstration of large damage capability at limit or near limit load for the latter after a regular interval of time, which is much shorter than the former. The residual strength demonstration for Category 3 damage may be dependent on the reliable short time detection interval. Some examples of Category 3 damage include large VID or other obvious damage that will be caught during walk-around inspection or during the normal course of operations (e.g., fuel leaks, system malfunctions or cabin noise).

Category 4: Discrete source damage from a known incident such as flight manoeuvres is limited. Structural substantiation for Category 4 damage includes a demonstration of residual strength for loads specified in the regulations. It should be noted that pressurised structure will generally have Category 4 residual strength requirements at a level higher than shown in figure 3. Some examples of Category 4 damage include rotor burst, bird strikes (as specified in the regulations), tyre bursts, and severe in-flight hail.

Category 5: Severe damage created by anomalous ground or flight events, which is not covered by design criteria or structural substantiation procedures. This damage is in the current guidance to ensure the engineers responsible for composite aircraft structure design and the Agency work with maintenance organisations in making operations personnel aware of possible damage from Category 5 events and the essential need for immediate reporting to responsible maintenance personnel. It is also the responsibility of structural engineers to design-in sufficient damage resistance such that Category 5 events are self-evident to the operations personnel involved. An interface is needed with engineering to properly define a suitable conditional inspection based on available information from the anomalous event. Such action will facilitate the damage characterisation needed prior to repair. Some examples of Category 5 damage include severe service vehicle collisions with aircraft, anomalous flight overload conditions, abnormally hard landings, maintenance jacking errors, and loss of aircraft parts in flight, including possible subsequent high-energy, wide-area (blunt) impact with adjacent structure. Some Category 5 damage scenarios will not have clearly visual indications of damage, particularly in composite structures. However, there should be knowledge of other evidence from the

related events that ensure safety is protected, starting with a complete report of possible damage by operations.

- (d) The five categories of damage will be used as examples in subsequent discussion in this paragraph and in paragraphs 9 and 10. Note that Category 2, 3, 4 and 5 damages all have associated repair scenarios.
- (2) Structure details, elements, and sub-components of Critical Structure should be tested under repeated loads to define the sensitivity of the structure to damage growth. This testing can form the basis for validating a no-growth approach to the damage tolerance requirements. The testing should assess the effect of the environment on the flaw and damage growth characteristics and the no-growth validation. The environment used should be appropriate to the expected service usage. Residual stresses will develop at the interfaces between composite and metal structural elements in a design due to differences in thermal expansion. This component of stress will depend on the service temperature during repeated load cycling and is considered in the damage tolerance evaluation. Inspection intervals should be established, considering both the likelihood of a particular damage and the residual strength capability associated with this damage. The intent of this is to assure that structure is not exposed to an excessive period of time with residual strength less than ultimate, providing a lower safety level than in the typical slow growth situation, as illustrated in Figure 4. Conservative assumptions for capability with large damage sizes that would be detected within a few flights may be needed when probabilistic data on the likelihood of given damage sizes does not exist. Once the damage is detected, the component is either repaired to restore ultimate load capability or replaced.

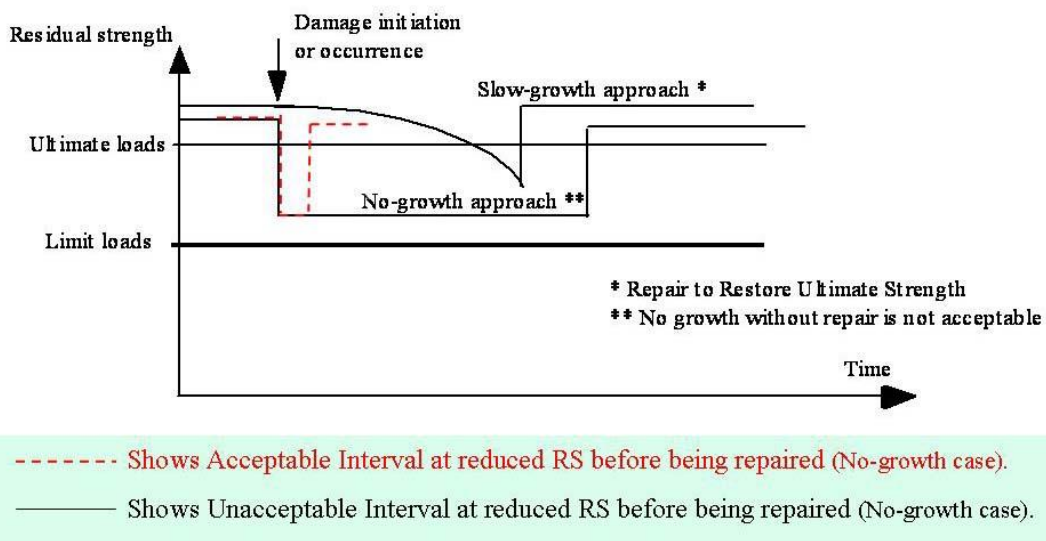

Figure 4 - Schematic diagram of residual strength illustrating that significant accidental damage with "no-growth" should not be left in the structure without repair for a long time.

- (a) The traditional slow growth approach may be appropriate for certain damage types found in composites if the growth rate can be shown to be slow, stable and predictable. Slow growth characterisation should yield conservative and reliable results. As part of the slow growth approach, an inspection programme should be developed consisting of the frequency,



extent, and methods of inspection for inclusion in the maintenance plan. Inspection intervals should be established such that the damage will have a very high probability of detection between the time it becomes initially detectable and the time at which the extent of the damage reduces the residual static strength to limit load (considered as ultimate), including the effects of environment. For any detected damage size that reduces the load capability below ultimate, the component is either repaired to restore ultimate load capability or replaced. Should functional impairment (such as unacceptable loss of stiffness) occur before the damage becomes otherwise critical, part repair or replacement will also be necessary.

- (b) Another approach involving growth may be appropriate for certain damage types and design features adopted for composites if the growth can be reliably shown to be predictable and arrested before it becomes critical. Figure 5 shows schematic diagrams for all three damage growth approaches applied to composite structure. The arrested growth method is applicable when the damage growth is mechanically arrested or terminated before becoming critical (residual static strength reduced to limit load), as illustrated in Figure 5. Arrested growth may occur due to design features such as a geometry change, reinforcement, thickness change, or a structural joint. This approach is appropriate for damage growth that is detectable and found to be reliably arrested, including all appropriate dynamic effects. Structural details, elements, and sub-components of Critical Structure, components or full-scale structures, should be tested under repeated loads for validating an Arrested Growth Approach. As was the case for a “no-growth” approach to damage tolerance, inspection intervals should be established, considering the residual strength capability associated with the arrested growth damage size (refer to the dashed lines added to Figure 5 to conceptually show inspection intervals consistent with the slow growth basis). Again, this is intended to ensure that the structure does not remain in a damaged condition with residual strength capability close to limit load for long periods of time before repair. For any damage size that reduces load capability below ultimate, the component is either repaired to restore ultimate load capability or replaced.
- (c) The repeated loading should be representative of anticipated service usage. The repeated load testing should include damage levels (including impact damage) typical of those that may occur during fabrication, assembly, and in-service, consistent with the inspection techniques employed. The damage tolerance test articles should be fabricated and assembled in accordance with production specifications and processes so that the test articles are representative of production structure.
- (3) The extent of initially detectable damage should be established and be consistent with the inspection techniques employed during manufacture and in service. This information will naturally establish the transition between Category 1 and 2 damage types (i.e., inspection methods used by trained inspectors in scheduled maintenance). For damage that is clearly detectable to an extent that it will likely be found before scheduled maintenance (i.e., allowing classification as Category 3 damage), detection over shorter intervals and by untrained personnel may be permitted. Flaw/damage growth data should be obtained by repeated load cycling of intrinsic flaws or mechanically introduced damage. The number of cycles applied

to validate both growth and no-growth concepts should be statistically significant, and may be determined by load and/or life considerations and a function of damage size. The growth or no growth evaluation should be performed by analysis supported by test evidence or by tests at the coupon, element, or sub-component level.

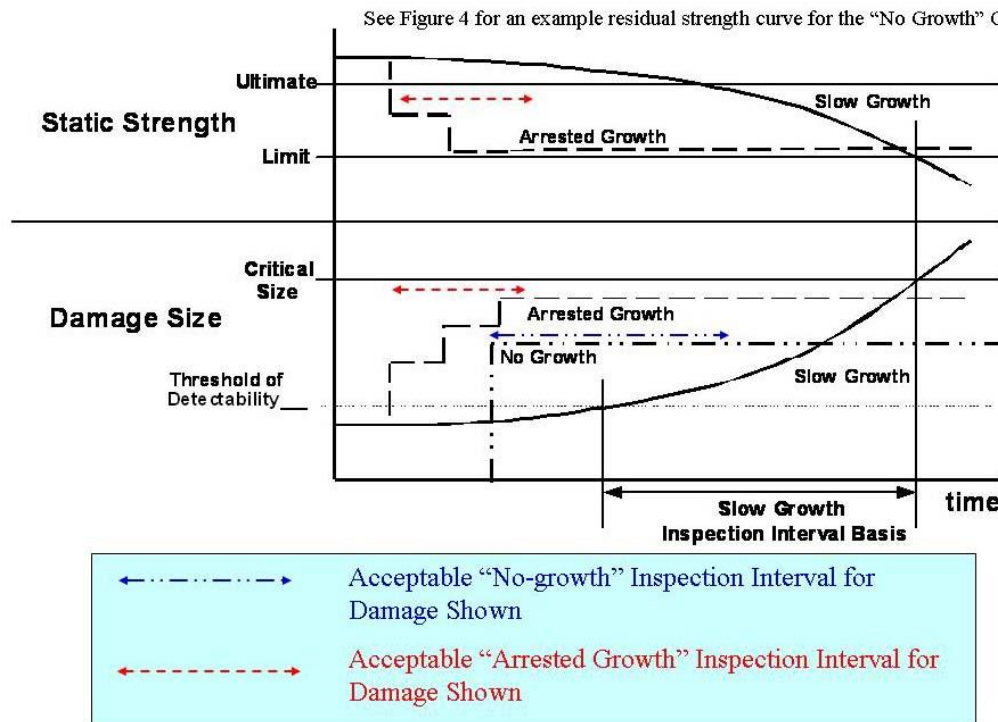

Figure 5 - Illustrations of residual strength and damage size relationships for three different approaches to composite structural damage tolerance substantiation

- (4) The extent of damage for residual strength assessments should be established, including considerations for the probability of detection using selected field inspection procedures. The first four categories of damage should be considered based on the damage threat assessment. In addition, Category 3 damage should be detected in a walk-around inspection or through the normal course of operations. Residual strength evaluation by component or sub-component testing or by analysis supported by test evidence should be performed considering that damage. The evaluation should demonstrate that the residual strength of the structure will reliably be equal to or greater than the strength required for the specified design loads (considered as ultimate), including environmental effects. The statistical significance of reliable sub-component and detail residual strength assessments may include conservative methods and engineering judgment. It should be shown that stiffness properties have not changed beyond acceptable levels.
  - (a) For the no-growth, slow growth, arrested growth approaches, residual strength testing should be performed after repeated load cycling. All probabilistic analyses applied for residual strength assessments should properly account for the complex nature of damage defined from a thorough damage threat assessment. Conservative damage metrics are permitted in

- such analyses assuming sufficient test data on repeated load and environmental exposure exists.
- (b) Composite designs should afford the same level of fail-safe, multiple load path structure assurance as conventional metals design. Such is also the expectation in justifying the use of static strength allowables with a statistical basis of 90 percent probability with 95 percent confidence.
  - (c) Some special residual strength considerations for bonded structure are given in paragraph 6.c.(3).
- (5) The repeated load spectrum developed for fatigue testing and analysis purposes should be representative of the anticipated service usage. Low amplitude load levels that can be shown not to contribute to damage growth may be omitted. Reducing maximum load levels is generally not accepted. Variability in repeated load behaviour should be covered by appropriate load enhancement or life scatter factors and these factors should take into account the number of specimens tested. The use of such factors to demonstrate reliability in component tests should be consistent with the fatigue and damage tolerance behaviour characterised for the materials, processes and other design details of the structure in building block tests.
- (6) An inspection programme should be developed consisting of frequency, extent, and methods of inspection for inclusion in the maintenance plan. Inspection intervals should be established such that the damage will be reliably detected between the time it initially becomes detectable and the time at which the extent of damage reaches the limits for required residual strength capability. The potential for missed inspections should be considered.
- (a) For the case of no-growth design concept, inspection intervals should be established as part of the maintenance programme. In selecting such intervals, the residual strength level associated with the assumed damages should be considered. This point was illustrated in Figures 4 and 5. Note that an acceptable inspection interval for the larger damages shown for the “no-growth” and “arrested growth” options in Figures 4 and 5 was conceptually shown as related to an acceptable slow growth basis in terms of the residual strength and time below ultimate load before damage was detected and repaired. Data on the probability of occurrence for different damage sizes also helps define an inspection interval.
  - (b) A thorough composite damage threat assessment and the separation of different damage sizes into categories, each with associated detection methods, supports programmes using a rigorous damage tolerance assessment to avoid conservative design criteria with very large damage assumptions. In such cases, Category 2 damage types will require the structural substantiation of well specified and reliable inspection methods applied by trained inspectors at scheduled maintenance intervals (by default, Category 1 damage is at the threshold of this evaluation). Those damages classified as Category 3 may take advantage of shorter service time intervals provided sufficient structural substantiation exists with demonstrated proof that there will be early detection by untrained ramp maintenance or operations personnel. By definition, Category 4 damage will require residual strength substantiation to levels that complete a flight with

limited manoeuvres based on the associated regulatory loads. Due to the nature of service events leading to Category 4 damage, suitable inspections will need to be defined to evaluate the full extent of damage, prior to subsequent aircraft repair and return to service. By definition, Category 5 damages do not have associated damage tolerance design criteria or related structural substantiation tasks. Category 5 damage will require suitable inspections based on engineering assessment of the anomalous service event, and appropriate structural repair and/or part replacement, prior to the aircraft re-entering service.

- (7) The structure should be able to withstand static loads (considered as ultimate loads) which are reasonably expected during a completion of the flight on which damage resulting from obvious discrete sources occur (i.e., uncontained engine failures, etc.). The extent of damage should be based on a rational assessment of service mission and potential damage relating to each discrete source. Structural substantiation will be needed for the most critical Category 4 damage as related to the associated load cases. Some Category 4 damage may have high margins but will likely still require suitable inspections since their detectability may not be consistent with the substantiations validated for Category 2 damage types.
- (8) The effects of temperature, humidity, and other environmental or time-related aging factors, which may result in material property degradation, should be addressed in the damage tolerance evaluation. Unless tested in the environment, appropriate environmental factors should be derived and applied in the evaluation.

**b. Fatigue Evaluation**

Fatigue substantiation should be accomplished by component fatigue tests or by analysis supported by test evidence, accounting for the effects of the appropriate environment. The test articles should be fabricated and assembled in accordance with production specifications and processes so that the test articles are representative of production structures. Sufficient component, sub-component, element or coupon tests should be performed to establish the fatigue scatter and the environmental effects. Component, sub-component, and/or element tests may be used to evaluate the fatigue response of structure with impact damage levels typical of those that may occur during fabrication, assembly, and in service, consistent with the inspection procedures employed. Other allowed manufacturing and service defects, which would exist for the life of the structure, should also be included in fatigue testing. It should be demonstrated during the fatigue tests that the stiffness properties have not changed beyond acceptable levels. Replacement lives should be established based on the test results. By definition, Category 1 damage is subjected to fatigue evaluation and expected to retain ultimate load capability for the life of the aircraft structure.

**c. Combined Damage Tolerance and Fatigue Evaluation**

Generally, it is appropriate for a given structure to establish both an inspection programme and demonstrate a service life to cover all detectable and non-detectable damage, respectively, which is anticipated for the intended aircraft usage. Extensions in service life should include evidence from component repeated load testing, fleet leader programmes (including NDI and destructive tear-down inspections), and appropriate statistical assessments of accidental damage and environmental service data considerations.

## **9. PROOF OF STRUCTURE – FLUTTER AND OTHER AEROELASTIC INSTABILITIES**

The aeroelastic evaluations including flutter, control reversal, divergence, and any undue loss of stability and control as a result of structural loading and resulting deformation, are required. Flutter and other aeroelastic instabilities must be avoided through design, quality control, maintenance, and systems interaction.

- a. The evaluation of composite structure needs to account for the effects of repeated loading, environmental exposure, and service damage scenarios (e.g., large Category 2, 3 or 4 damage) on critical properties such as stiffness, mass and damping. Some control surfaces exposed to large damage retain adequate residual strength margins, but the potential loss of stiffness or mass increase (e.g., sandwich panel disbond and/or water ingress) may adversely affect flutter and other aeroelastic characteristics. This is particularly important for control surfaces that are prone to accidental damage and environmental degradation. Other factors such as the weight or stiffness changes due to repair, manufacturing flaws, and multiple layers of paint need to be evaluated. There may also be issues associated with the proximity of high temperature heat sources near structural components (e.g., empennage structure in the path of jet engine exhaust streams or engine bleed air pneumatics system ducting). These effects may be determined by analysis supported by test evidence, or by tests at the coupon, element or sub-component level.

## **10. CONTINUED AIRWORTHINESS**

The maintenance and repair of composite aircraft structure should meet all general, design and fabrication, static strength, fatigue/damage tolerance, flutter, and other considerations covered by this AMC as appropriate for the particular type of structure and its application.

### **a. Design for Maintenance**

Composite aircraft structure should be designed for inspection and repair access in a field maintenance environment. The inspection and repair methods applied for structural details should recognise the special documentation and training needed for critical damage types that are difficult to detect, characterise and repair. The inspection intervals and life limits for any structural details and levels of damage that preclude repair must be clearly documented in the appropriate continued airworthiness documents.

### **b. Maintenance Practices**

Maintenance manuals, developed by the appropriate organisations, should include appropriate inspection, maintenance, and repair procedures for composite structures, including jacking, disassembly, handling, part drying methods, and repainting instructions (including restrictions for paint colours that increase structural temperatures). Special equipment, repair materials, ancillary materials, tooling, processing procedures, and other information needed for inspection or repair of a given part should be identified since standard field practices, which have been substantiated for different aircraft types and models, are not common.

#### **(1) Damage Detection**

- (a) Procedures used for damage detection must be shown to be reliable and capable of detecting degradation in structural integrity below ultimate load capability. These procedures must be documented in the appropriate sections of the instructions for continued airworthiness. This should be substantiated in static strength, environmental resistance, fatigue, and damage tolerance efforts as outlined in paragraphs 6, 7 and 8. Substantiated

detection procedures will be needed for all damage types identified by the threat assessment, including a wide range of foreign object impact threats, manufacturing defects, and degradation caused by overheating. Degradation in surface layers (e.g., paints and coatings) that provide structural protection against ultraviolet exposure must be detected. Any degradation to the lightning strike protection system that affects structural integrity, fuel tank safety, and electrical systems must also be detected.

- (b) Visual inspection is the predominant damage detection method used in the field and should be performed under prescribed lighting conditions. Visual inspection procedures should account for access, time relaxation in impact damage dent depth, and the colour, finish and cleanliness of part surfaces.
- (2) Inspection. Visual indications of damage, which are often used for composite damage detection, provide limited details on the hidden parts of damage that require further investigation. As a result, additional inspection procedures used for complete composite damage characterisation will generally be different from those used for initial damage detection and need to be well documented. Non-destructive inspection performed prior to repair and destructive processing steps performed during repair must be shown to locate and determine the full extent of the damage. In-process controls of repair quality and post-repair inspection methods must be shown to be reliable and capable of providing engineers with the data to determine degradation in structural integrity below ultimate load capability caused by the process itself. Certain processing defects cannot be reliably detected at completion of the repair (e.g., weak bonds). In such cases, the damage threat assessment, repair design features and limits should ensure sufficient damage tolerance.
- (3) Repair. All bolted and bonded repair design and processing procedures applied for a given structure shall be substantiated to meet the appropriate requirements. Of particular safety concern are the issues associated with bond material compatibilities, bond surface preparation (including drying, cleaning, and chemical activation), cure thermal management, composite machining, special composite fasteners, and installation techniques, and the associated in-process control procedures. The surface layers (e.g., paints and coatings) that provide structural protection against ultraviolet exposure, structural temperatures, and the lightning strike protection system must also be properly repaired.
- (4) Documentation and Reporting. Documentation on all repairs must be added to the maintenance records for the specific part number. This information supports future maintenance damage disposition and repair activities performed on the same part. It is recommended that service difficulties, damage, and degradation occurring to composite parts in service should be reported back to the design approval holder to aid in continuous updates of damage threat assessments to support future design detail and process improvements. Such information will also support future design criteria, analysis, and test database development.

**c. Substantiation of Repair**

- (1) When repair procedures are provided in Agency approved documents or the maintenance manual, it should be demonstrated by analysis and/or test that the method and techniques of repair will restore the structure to an airworthy condition. Repairable damage limits (RDL), which outline the details for damage to

structural components that may be repaired based on existing data, must be clearly defined and documented. Allowable damage limits (ADL), which do not require repair, must also be clearly defined and documented. Both RDL and ADL must be based on sufficient analysis and test data to meet the appropriate structural substantiation requirements and other considerations outlined in this AMC. Additional substantiation data will generally be needed for damage types and sizes not previously considered in design development. Some damage types may require special instructions for field repair and the associated quality control. Bonded repair is subjected to the same structural bonding considerations as the base design (refer to paragraph 6.c).

- (2) Operators and maintenance repair organisations (MRO) wishing to complete major repairs or alterations outside the scope of approved repair documentation should be aware of the extensive analysis, design, process, and test substantiation required to ensure the airworthiness of a certificated structure. Documented records and the certification approval of this substantiation should be retained in accordance with regulations to support any subsequent maintenance activities.

**d. Damage Detection, Inspection and Repair Competency**

- (1) All technicians, inspectors and engineers involved in damage disposition and repair should have the necessary skills to perform their supporting maintenance tasks on a specific composite structural part. The continuous demonstration of acquired skills goes beyond initial training (e.g., similar to a welder qualification). The repair design, inspection methods, and repair procedures used will require approved structural substantiation data for the particular composite part. Society of Automotive Engineers International (SAE) Aerospace Information Report (AIR) 5719 outlines training for an awareness of the safety issues for composite maintenance and repair. Additional training for specific skill building will be needed to execute particular engineering, inspection and repair tasks.
- (2) Pilots, ramp maintenance, and other operations personnel that service aircraft should be trained to immediately report anomalous ramp incidents and flight events that may potentially cause serious damage to composite aircraft structures. In particular, immediate reporting is needed for those service events that are outside the scope of the damage tolerance substantiation and standard maintenance practices for a given structure. The immediate detection of Category 4 and 5 damages are dependent on the proper reaction of personnel that operate and service the aircraft.

**11. ADDITIONAL CONSIDERATIONS**

**a. Crashworthiness**

- (1) The crashworthiness of the aircraft is dominated by the impact response characteristics of the fuselage. Regulations, in general, evolve based on either experience gained through incidents and accidents of existing aircraft or in anticipation of safety issues raised by new designs. In the case of crashworthiness, regulations have evolved as experience has been gained during actual aircraft operations. For example, emergency load factors and passenger seat loads have been established to reflect dynamic conditions observed from fleet experience and from controlled FAA and industry research. Fleet experience has not demonstrated a need to have an aircraft level crashworthiness standard. As a result, the regulations reflect the capabilities of traditional aluminium aircraft structure under

survivable crash conditions. This approach was satisfactory as aircraft have continued to be designed using traditional construction methods. With the advent of composite fuselage structure and/or the use of novel design, this historical approach may no longer be sufficient to substantiate the same level of protection for the passengers as provided by similar metallic designs.

- (2) Airframe design should assure that occupants have every reasonable chance of escaping serious injury under realistic and survivable crash impact conditions. A composite design should account for unique behaviour and structural characteristics, including major repairs or alterations, as compared with conventional metal airframe designs. Structural evaluation may be done by test or analysis supported by test evidence. Service experience may also support substantiation.
- (3) The crash dynamics of an aircraft and the associated energy absorption are difficult to model and fully define representative tests with respect to structural requirements. Each aircraft product type (i.e., large aeroplane, small aeroplane, and rotorcraft) has unique regulations governing the crashworthiness of particular aircraft structures. The regulations and guidance associated with each product type should be used accordingly. The regulations for large aeroplane and rotorcraft address some issues that go beyond those required of small aeroplanes.
- (4) Special conditions are anticipated for large aeroplanes with composite fuselage structure to address crashworthiness survivability. The impact response of a composite fuselage structure must be evaluated to ensure the survivability is not significantly different from that of a similar-sized aircraft fabricated from metallic materials. Impact loads and resultant structural deformation of the supporting airframe and floor structures must be evaluated. Four main criteria areas should be considered in making such an evaluation.
  - (a) Occupants must be protected during the impact event from release of items of mass (e.g., overhead bins).
  - (b) At least the minimum number of emergency egress paths must remain following a survivable crash.
  - (c) The acceleration and loads experienced by occupants during a survivable crash must not exceed critical thresholds.
  - (d) A survivable volume of occupant space must be retained following the impact event.
- (5) The criticality of each of these four criteria will depend on the particular crash conditions. For example, the loads and accelerations experienced by passengers may be higher at lower impact velocities where structural failures have not started to occur. As a result, validated analyses may be needed to practically cover all the crashworthiness criteria for a fuselage.
- (6) Existing large aeroplane requirements also require that fuel tank structural integrity be addressed during a survivable crash impact event as related to fire safety (also refer to paragraph 11.b). As related to crashworthiness, composite fuel tank structure must not fail or deform to the extent that fire becomes a greater hazard than with metal structure.
- (7) Physics and mechanics of the crashworthiness for composite structures involve several issues. The local strength, energy absorbing characteristics, and multiple



competing failure modes need to be addressed for composite structure subjected to a survivable crash. This is not simply achieved for airframe structures made from anisotropic, quasi-brittle, composite materials. As a result, the accelerations and load histories experienced by passengers and equipment on a composite aircraft may differ significantly from that seen on a similar metallic aircraft unless specific considerations are designed into the composite structure. In addition, care should be taken when altering composite structure to achieve specific mechanical behaviours. (For example, where the change in behaviour of a metallic structure with a change in material thickness may be easily predicted, an addition or deletion of plies to a composite laminate may also require data for the effects of laminate stacking sequence on the failure mode and energy absorption characteristics of a composite element).

- (8) Representative structure must be included to gain valid test and analysis results. Depending on aircraft loading (requiring investigation of various aircraft passenger and cargo configurations), structural dynamic considerations, and progressive failures, local strain rates and loading conditions may differ throughout the structure. Sensitivity of the structural behaviour to reasonable impact orientation should also be considered for large aeroplane and rotorcraft applications. This can be addressed by analysis supported by test evidence.
- (9) Considering a need for comparative assessments with metal structure and a range of crash conditions, analysis with sufficient structural test evidence is often needed for large aeroplane and rotorcraft applications. Analysis requires extensive investigation of model sensitivity to modelling parameters (e.g., mesh optimisation, representation of joints, element material input stress-strain data). Test also requires investigation of test equipment sensitivity appropriate to composites (e.g., filter frequencies with respect to expected pulse characteristics in the structure). Model validation may be achieved using a building block approach, culminating in an adequately complex test (e.g., a drop test with sufficient structural details to properly evaluate the crashworthiness criteria).

**b. Fire Protection, Flammability and Thermal Issues**

- (1) Fire and exposure to temperatures that exceed maximum operating conditions require special considerations for composite airframe structure. (Refer to note below). Requirements for flammability and fire protection of aircraft structure attempt to minimise the hazard to occupants in the event that flammable materials, fluids, or vapours ignite. *The regulations associated with each aircraft product type (i.e., transport, small airplane, rotorcraft) should be used accordingly.* Compliance may be shown by tests or analysis supported by test evidence. A composite design, including repair and alterations, should not decrease the existing level of safety relative to metallic structure. In addition, maintenance procedures should be available to evaluate the structural integrity of any composite aircraft structures exposed to fire and temperatures above the maximum operating conditions substantiated during design.

Note: Aircraft cabin interiors and baggage compartments have been areas of flammability concerns in protecting passenger safety. This revision of the AMC does not address composite materials used in aircraft interiors and baggage compartments. Please consult other Guidance Material for Acceptable Means of Compliance with flammability rules for interiors.

- (2) Fire protection and flammability has traditionally been considered for engine mount structure, firewalls, and other powerplant structures that include composite elements. Additional issues critical to passenger safety have come with the expanded use of composites in wing and fuselage structures for large aeroplanes. Existing regulations do not address the potential for the airframe structure itself to be flammable. Wing and fuselage applications should consider the effects of composite design and construction on the resulting passenger safety in the event of in-flight fires or emergency landing conditions, which combine with subsequent egress when a fuel-fed fire is possible.
- (3) The results of fire protection and flammability testing with structural composite parts indicate dependence upon overall design and process details, as well as the origin of the fire and its extent. For example, the overall effects of composite fuselage structures exposed to fire may be significantly different when the fire originates within the cabin, where it can be controlled by limiting the structure's contribution to spreading the fire, than when the fire occurs exterior to the fuselage after a crash landing, where fuel is likely to be the primary source for maintaining and spreading the fire. The threat in each case is different, and the approach to mitigation may also be different. In-flight fire safety addresses a fire originating within the aircraft due to some fault, whereas post-crash fire safety addresses a fuel fed pool fire external to the aircraft. Special conditions are anticipated for large aeroplanes with fuselage structure subjected to both in-flight and post-crash fire conditions. Large aeroplane wing structure will need to have special conditions for post-crash fire conditions.
- (4) For an in-flight fire in large aeroplanes, it is critical that the fire not propagate or generate hazardous quantities of toxic by-products. In-flight fires have been catastrophic when they can grow in inaccessible areas. Composite fuselage structure could play a role different from traditional metal structure if the issue is not addressed.
- (5) Metallic large aeroplane fuselage and wing structures have established a benchmark in fire protection that can be used to evaluate specific composite wing and fuselage structural details. Exterior fire protection issues associated with composite structure must include the effects of an exterior pool fire following a survivable crash landing. Fuselage structure should provide sufficient time for passenger egress, without fire penetration or the release of gasses and/or materials that are either toxic to escaping passengers or reduce visibility (smoke density) or could increase the fire severity. Furthermore, these considerations must be extended to wing and fuel tank structure, which must also be prevented from collapse and release of fuel (including consideration of the influence of fuel load upon the structural behaviour. For large aeroplanes, the standards of CS 25.856(b) provide the benchmark to establish the required level of safety.
- (6) The exposure of composite structures to high temperatures needs to extend beyond the direct flammability and fire protection issues to other thermal issues. Many composite materials have glass transition temperatures, which mark the onset of reductions in strength and stiffness that are somewhat lower than the temperatures that can have a similar effect on equivalent metallic structure. The glass transition temperature of most composite materials is further reduced by moisture absorption. The reduced strength or stiffness of composites from high temperature exposures must be understood per the requirements of particular

applications (e.g., engine or other system failures). After a system failure and/or known fire, it may be difficult to detect the full extent of irreversible heat damage to an exposed composite structure. As a result, composite structures exposed to high temperatures may require special inspections, tests, and analysis for proper disposition of heat damage. All appropriate damage threats and degradation mechanisms need to be identified and integrated into the damage tolerance and maintenance evaluation accordingly. Reliable inspections and test measurements of the extent of damage that exists in a part exposed to unknown levels of high temperatures should be documented. Particular attention should be given to defining the maximum damages that likely could remain undetected by the selected inspection procedures.

**c. Lightning Protection**

Lightning protection design features are needed for composite aircraft structures. Current Carbon fibre composites are approximately 1,000 times less electrically conductive than standard aluminium materials, and composite resins and adhesives are traditionally non-conductive. Glass and aramid fibre composites are non-conductive. A lightning strike to composite structures can result in structural failure or large area damage, and it can induce high lightning current and voltage on metal hydraulic tubes, fuel system tubes, and electrical wiring if proper conductive lightning protection is not provided. Aircraft lightning protection design guidance can be found in the FAA Technical Report “Aircraft Lightning Protection Handbook” (See [Appendix 1 2.a](#)). The lightning protection effectiveness for composite structures should be demonstrated by tests or analysis supported by tests. Such tests are typically performed on panels, coupons, subassemblies, or coupons representative of the aircraft structure, or tests on full aircraft. The lightning test waveforms and lightning attachment zones are defined in EUROCAE ED-84 and ED-91. Any structural damage observed in standard lightning tests should be limited to Category 1, 2 or 3, depending on the level of detection. This damage is characterised and integrated into damage tolerance analyses and tests as appropriate. Small simple aeroplanes certified under CS-23 for VFR use only may be certified based on engineering assessment, according to AC 23-15A. The effects of composite structural repairs and maintenance on the lightning protection system should be evaluated. Repairs should be designed to maintain lightning protection.

**(1) Lightning Protection for Structural Integrity**

- (a)** The composite structural design should incorporate the lightning protection when appropriate for the anticipated lightning attachment. The extent of lightning protection features depends on the lightning attachment zone designated for that area of the aircraft. Lightning protection features may include, but are not limited to, metal wires or mesh added to the outside surface of the composite structure where direct lightning attachment is expected.
- (b)** When lightning strikes an aircraft, very high currents flow through the airframe. Proper electrical bonding must be incorporated between structural parts. This is difficult to achieve for moveable parts (e.g., ailerons, rudders and elevators). The electrical bonding features must be sized to conduct the lightning currents or they can vaporise, sending the high currents through unintended paths such as control cables, control rods, or hydraulic tubes. Guidance for certification of lightning protection of aircraft structures can be found in EUROCAE ED-113.

- 
- (2) Lightning Protection for Fuel Systems
- (a) Special consideration must be given to the fuel system lightning protection for an aircraft with integral fuel tanks in a composite structure. Composite structure with integral fuel systems must incorporate specific lightning protection features on the external composite surfaces, on joints, on fasteners, and for structural supports for fuel system plumbing and components to eliminate structural penetration, arcing, sparks or other ignition sources. AC 20-53B provides certification guidance for aircraft fuel system lightning protection.
  - (b) Large aeroplane regulations for fuel system ignition prevention in CS 25.981 require lightning protection that is failure tolerant. As a result, redundant and robust lightning protection for composite structure joints and fasteners in fuel tank structure is needed to ensure proper protection in preventing ignition sources.
- (3) Lightning Protection for Electrical and Electronic Systems
- (a) Lightning strike protection of composite structures is needed to avoid inducing high lightning voltages and currents on the wiring for electrical and electronic systems whose upset or damage could affect safe aircraft operation. The consequences from a lightning strike of unprotected composite structures can be catastrophic for electrical and electronic systems that perform highly critical functions, such as fly-by-wire flight controls or engine controls.
  - (b) Electrical shields over system wiring and robust circuit design of electrical and electronic equipment both provide some protection against system upset or damage due to lightning. Since most composite materials provide poor shielding, at best, metal foil or mesh is typically added to the composite structure to provide additional shielding for wiring and equipment. Electrical bonding between composite structure parts and panels should be provided for the shielding to be effective. EUROCAE ED-81 and ED-107 provide certification guidance for aircraft electrical and electronic system lightning protection.

[Amdt 20/6]

## Appendix 1 to AMC 20-29 – Applicable CSs and Relevant Guidance

*ED Decision 2010/003/R*

- 1. Applicable CSs.** A list of applicable CS paragraphs is provided for subjects covered in this AMC (see notes). In most cases, these CS paragraphs apply regardless of the type of materials used in aircraft structures.

AMC Paragraphs	CS-23	CS-25	CS-27	CS-29
1. Purpose of this AMC	----- Not Applicable -----			
2. To Whom this AMC Applies	----- Not Applicable -----			
3. Cancellation	----- Not Applicable -----			
4. Related Regulations and Guidance	----- Not Applicable -----			
5. General	----- Not Applicable -----			
6. Material and Fabrication Development	603	603	603	603
	605	605	605	605
	609	609	609	609
	613	613	613	613
	619	619	619	619
7. Proof of Structure – Static	305	305	305	305
	307	307	307	307
8. Proof of Structure – Fatigue and Damage Tolerance	573	571	571	571
9. Proof of Structure – Flutter	629	629	629	629
10. Continued Airworthiness	1529	1529	1529	1529
	App. G	App. H	App. H	App. A
11. Additional Considerations				
a. Crashworthiness (including impact dynamics)	561	561	561	561
	562	562	562	562
	601	601	601	601
		631		631
	721	721		
	783	783	783	783
	785	785	785	785
	787	787	787	787
	789	789		
		801	801	801
				803
	807		807	
		809		809
		963	963	963
965		965	965	
967	967	967	967	
	981			

b.	Fire Protection, Flammability and Thermal Issues	609	609	609	609
		853	853	853	853
		855	855	855	855
		859	859	859	859
				861	861
		863	863	863	863
		865	865		
		867			
		903	903		903
		1121	1121	1121	1121
		1181	1181		1181
		1182	1182		
		1183	1183	1183	1183
			1185	1185	1185
				1187	1187
		1189	1189	1189	1189
		1191	1191	1191	1191
		1193	1193	1193	1193
				1194	1194
		1359			
		1365			
c.	Lightning Protection		581*		
	* see AMC 25.899 para.6	609	609	609	609
					610
		867			
			899*		
		954	954*	954	954
		1309	981		
				1309	1309
			1316		

Notes:

- (1) This list may not be all inclusive and there may be differences between certification agencies (e.g. FAA and the Agency).
- (2) Special conditions may be issued in accordance with Part-21 21.A.16B for novel and unusual design features (e.g., new composite materials systems).

## 2. Guidance

FAA issues guidance providing supportive information of showing compliance with regulatory requirements. Guidance may include the advisory circulars (AC) and policy statements (PS). In general, an AC presents information concerning acceptable means, but not the only means, of complying with regulations. The guidance listed below is deemed supportive to the purposes of this AMC. These FAA documents can be located via website: [http://www.faa.gov/regulations\\_policies/](http://www.faa.gov/regulations_policies/). In addition, EUROCAE have developed industry standards that are recognised by the Agency.

Note: Many of the FAA documents are harmonised with EASA. Applicants should confirm with the Agency if in doubt regarding the status and acceptance of any such documents by the Agency.

- a. FAA/EUROCAE guidance documents

- AC 20-53B “Protection of Airplane Fuel Systems Against Fuel Vapor Ignition Due to Lightning” [6/06]
  - AC 20-135 "Powerplant Installation and Propulsion System Component Fire Protection Test Methods, Standards, and Criteria" [2/90]
  - AC 21-26 "Quality Control for the Manufacture of Composite Structures" [6/89]
  - AC 21-31 "Quality Control for the Manufacture of Non-Metallic Compartment Interior Components" [11/91]
  - AC 23-15A “Small Airplane Certification Compliance Program” [12/03]
  - AC 23-20 "Acceptance Guidance on Material Procurement and Process Specifications for Polymer Matrix Composite Systems" [9/03]
  - AC 25.571-1C “Damage Tolerance and Fatigue Evaluation of Structure” [4/98]
  - AC 29 MG 8 “Substantiation of Composite Rotorcraft Structure” [4/06]
  - AC 35.37-1A "Guidance Material for Fatigue Limit Tests and Composite Blade Fatigue Substantiation" [9/01]
  - AC 145-6 "Repair Stations for Composite and Bonded Aircraft Structure" [11/96]
  - RTCA DO-160 / EUROCAE ED-14
  - EUROCAE ED-81 “Certification of Aircraft Electrical/Electronic Systems for the Indirect Effects of Lightning”
  - EUROCAE ED-84 “Aircraft Lightning Environment and Related Test Waveforms”
  - EUROCAE ED-91 “Aircraft Lightning Zoning”
  - EUROCAE ED-107 “Guide to Certification of Aircraft in a High Intensity Radiated Field (HIRF)”
  - EUROCAE ED-113 Aircraft Lightning Direct Effects Certification
  - EUROCAE ED-14E Environmental Conditions and Test Procedures for Airborne Equipment
  - FAA Technical Report “Aircraft Lightning Protection Handbook” (DOT/FAA/CT-89/22).
- b. FAA Policy Statements
- "Static Strength Substantiation of Composite Airplane Structure" [PS-ACE100-2001-006, December 2001]
  - "Final Policy for Flammability Testing per 14 CFR Part 23, Sections 23.853, 23.855 and 23.1359" [PS-ACE100-2001-002, January 2002]
  - “Material Qualification and Equivalency for Polymer Matrix Composite Material Systems" [PS-ACE100-2002-006, September 2003]
  - “Bonded Joints and Structures - Technical Issues and Certification Considerations” [PS-ACE100-2005-10038, September 2005]

[Amdt 20/6]

## Appendix 2 to AMC 20-29 – Definitions

ED Decision 2010/003/R

The following definitions are applicable to [AMC 20-29](#) and relevant CS paragraphs only.

**Allowables:** Material values that are determined from test data at the laminate or lamina level on a probability basis (e.g., A or B basis values, with 99% probability and 95% confidence, or 90% probability and 95% confidence, respectively). The amount of data required to derive these values is governed by the statistical significance (or basis) needed.

**Anisotropic:** Not isotropic; having mechanical and/or physical properties which vary with direction relative to natural reference axes inherent in the material.

**Arrested Growth Approach:** A method that requires demonstration that the structure, with defined flaws present, is able to withstand appropriate repeated loads with flaw growth which is either mechanically arrested or terminated before becoming critical (residual static strength reduced to limit load). This is to be associated with appropriate inspection intervals and damage detectability.

**Category of Damage:** One of five categories of damage based on residual strength capability, required load level, detectability, inspection interval, damage threat and whether (or not) the event creating damage is self-evident (see Section 8(a)(1)(c)).

**Component:** A major section of the airframe structure (e.g., wing, body, fin, horizontal stabiliser) which can be tested as a complete unit to qualify the structure.

**Coupon:** A small test specimen (e.g., usually a flat laminate) for evaluation of basic lamina or laminate properties or properties of generic structural features (e.g., bonded or mechanically fastened joints).

**Critical Structure:** A load bearing structure/element whose integrity is essential in maintaining the overall flight safety of the aircraft. This definition was adopted for this AMC because there are differences in the definitions of primary structure, secondary structure, and principle structural elements (PSE) when considering the different categories of aircraft. For example, PSE are critical structures for Large Aeroplanes.

**Damage:** A structural anomaly caused by manufacturing (processing, fabrication, assembly or handling) or service usage.

**Debond:** Same as Disbond.

**Degradation:** The alteration of material properties (e.g., strength, modulus, coefficient of expansion) which may result from deviations in manufacturing or from repeated loading and/or environmental exposure.

**Delamination:** The separation of the layers of material in a laminate. This may be local or may cover a large area of the laminate. It may occur at any time in the cure or subsequent life of the laminate and may arise from a wide variety of causes.

**Design Values:** Material, structural elements, and structural detail properties that have been determined from test data and chosen to assure a high degree of confidence in the integrity of the completed structure. These values are most often based on allowables adjusted to account for actual structural conditions, and used in analysis to compute margins-of-safety.

**Detail:** A non-generic structural element of a more complex structural member (e.g., specific design configured joints, splices, stringers, stringer runouts, or major access holes).

**Disbond:** An area within a bonded interface between two adherends in which an adhesion failure or separation has occurred. It may occur at any time during the life of the substructure and may arise



from a wide variety of causes. Also, colloquially, an area of separation between two laminae in the finished laminate (in this case the term “delamination” is normally preferred).

**Discrepancy:** A manufacturing anomaly allowed and detected by the planned inspection procedure. They can be created by processing, fabrication or assembly procedures.

**Element:** A generic part of a more complex structural member (e.g., skin, stringers, shear panels, sandwich panels, joints, or splices).

**Environment:** External, non-accidental conditions (excluding mechanical loading), separately or in combination, that can be expected in service and which may affect the structure (e.g., temperature, moisture, UV radiation, and fuel).

**Factor(s):**

- **Life (or Load) Enhancement Factor:** An additional load factor and/or test duration applied to structural repeated load tests, relative to the intended design load and life values, used to account for material variability. It is used to develop the required level of confidence in data.
- **Life Scatter Factor:** Same as Life/Load Enhancement Factor.
- **Overload Factor:** A load factor applied to a specific structure test which is used to address parameters (e.g., environment, a short test pyramid, etc.) not directly addressed in that test. This factor is usually developed from lower pyramid testing addressing such parameters.

**Heterogeneous:** Descriptive term for a material consisting of dissimilar constituents separately identifiable; a medium consisting of regions of unlike properties separated by internal boundaries.

**Intrinsic Flaw:** Defect inherent in the composite material or resulting from the production process.

**Manufacturing Defect:** An anomaly or flaw occurring during manufacturing that can cause varying levels of degradation in structural strength, stiffness and dimensional stability. Those manufacturing defects (or permissible manufacturing variability) allowed by the quality control, manufacturing acceptance criteria are expected to meet appropriate structural requirements for the life of the aircraft part. Other manufacturing defects that escape detection in manufacturing quality control should be included in a damage threat assessment and must meet damage tolerance requirements until detected and repaired.

**No-Growth Approach:** A method that requires demonstration that the structure, with defined flaws present, is able to withstand appropriate repeated loads without detrimental flaw growth for the life of the structure.

**Primary Structure:** The structure which carries flight, ground, or pressurisation loads, and whose failure would reduce the structural integrity of the aircraft.

**Point Design:** An element or detail of a specific design which is not considered generically applicable to other structure for the purpose of substantiation, e.g., lugs and major joints. Such a design element or detail can be qualified by test or by a combination of test and analysis.

**Slow Growth Approach:** A method that requires demonstration that the structure, with defined flaws present, is able to withstand appropriate repeated loads with slow, stable, and predictable flaw growth for the life of the structure, or beyond appropriate inspection intervals associated with appropriate damage detectability.

**Structural Bonding:** A structural joint created by the process of adhesive bonding, comprising of one or more previously-cured composite or metal parts (referred to as adherends).

---

**Sub-component:** A major three-dimensional structure which can provide completed structural representation of a section of the full structure (e.g., stub-box, section of a spar, wing panel, body panel with frames).

**Weak Bond:** A bond line with mechanical properties lower than expected, but without any possibility to detect that by normal NDI procedures. Such situation is mainly due to a poor chemical bonding.

[Amdt 20/6]

## Appendix 3 to AMC 20-29 – Change of Composite Material and/or Process

*ED Decision 2010/003/R*

1. It is necessary to re-certify composite structures, which during production, incorporate substitutions of, or changes to, the materials and/or processes from those originally substantiated at the time of initial certification. For example, the original material supplier may either change its product, or cease production. Manufacturers may also find it necessary to modify their production processes to improve efficiency or correct product deficiencies. In either case, care must be taken to ensure that modifications and/or changes are adequately investigated to ensure the continued adequacy of already certified composite structure. This appendix covers such material and/or process changes, but does not address other changes to design (e.g., geometry, loading). The definition of the materials and processes used is required in the specifications by Part 21.A.31. Changes to the material and process specifications are often major changes in type design and must be addressed as such under Part-21, subpart D or E as applicable.
2. The qualification and structural substantiation of new or modified materials and/or processes used to produce parts of a previously certified aircraft product requires:
  - a. The identification of the key material and/or process parameters governing performances;
  - b. The definition of the appropriate tests able to measure these parameters; and
  - c. The definition of pass/fail criteria for these tests.
3. 'Qualification' procedures developed by every manufacturer include specifications covering:
  - a. Physical and chemical properties,
  - b. Mechanical properties (coupon level), and
  - c. Reproducibility (by testing several batches).
4. Specifications and manufacturing quality procedures are designed to control specific materials and processes to achieve stable and repeatable structure for that combination of materials and processes. However, the interchangeability of alternate materials and processes for a structural application cannot be assumed if one only considers the properties outlined in those specifications (as it could be for materials that are much less process dependent, e.g., some metallic material forms). A structure fabricated using new or modified materials and/or processes, which meet the 'qualification' tests required for the original material and process specifications, does not necessarily produce components that meet all the original engineering requirements for the previously certified structure.
5. Until improvements in identifying the complex relations between key material parameters that govern composite processing occurs, there will be a need for extensive and diverse testing that directly interrogates material performance using a range of representative specimens of increasing complexity in building block tests. Furthermore, failure modes may vary from one material and/or process to another, and analytical models are sometimes insufficiently precise to reliably predict failure without sufficient empirical data. Therefore, a step-by-step test verification with more complex specimens may be required.
6. **Classification of Material or Process Change**

Material and/or process changes require appropriate classification in order to aid the determination of the extent of investigation necessary. Some minor changes may only require

material equivalency sampling tests to be completed at the base of the test pyramid, whilst more significant changes will require more extensive investigations, including possibly a new structural substantiation.

- a. Any of the following situations requires further investigation of possible changes to a given composite structure:
  - (1) Case A: A change in one or both of the basic constituents, resin, or fibre (including sizing or surface treatment alone) would yield an alternate material. Other changes that result in an alternate material include changes in fabric weave style, fibre areal weight and resin content.
  - (2) Case B: Same basic constituents, but any change of the resin impregnation method. Such changes include: (i) prepregging process (e.g., solvent bath to hot melt coating), (ii) tow size (3k, 6k, 12k) for tape material forms with the same fibre areal weight, (iii) prepregging machine at the same suppliers, (iv) supplier change for a same material (licensed supplier).
  - (3) Case C: Same material, but modification of the processing route (if the modification to the processing route governs eventual composite mechanical properties). Example process changes of significance include: (i) curing cycle, (ii) bond surface preparation, (iii) changes in the resin transfer moulding process used in fabricating parts from dry fibre forms, (iv) tooling, (v) lay-up method, (vi) environmental parameters of the material lay-up room, and (vii) major assembly procedures.
- b. For each of the above cases, a distinction should be made between those changes intended to be a replica of the former material/process combination (Case B and some of Case C) and those which are “truly new material” (Case A and some of Case C). So, two classes are proposed:
  - (1) “Identical materials/processes” in cases intended to create a replica structure.
  - (2) “Alternative materials/processes” in cases intended to create truly new structure.
- c. Within the “identical materials/processes” class, a sub-classification can be made between a change of the prepregging machine alone at the supplier and licensed production elsewhere. For the time being, a change to a new fibre produced under a licensed process and reputed to be a replica of the former one, will be dealt with as an “alternative material/process”.
- d. Some minor changes within the class representing identical materials/processes may not interact with structural performances (e.g., prepreg release papers, some bagging materials, etc.) and should not be submitted to the Agency as part of the change. However, the manufacturers (or the supplier) should develop a proper system for screening those changes, with adequate proficiency at all relevant decision levels. Other minor material changes that fall under Case B may warrant sampling tests to show equivalency only at lower levels of building block substantiation.
- e. Case C changes that may yield major changes in material and structural performance need to be evaluated at all appropriate levels of the building block tests to determine whether the manufacturing process change yields identical or alternate materials. Engineering judgment will be needed in determining the extent of testing based on the proposed manufacturing change.
- f. Case A (alternative material) should always be considered as an important change, which requires structural substantiation. It is not recommended to try a sub-classification

according to the basic constituents being changed, as material behaviour (e.g., sensitivity to stress concentrations) may be governed by interfacial properties, which may be affected by either a fibre or a resin change.

7. **Substantiation Method.** Only the technical aspects of substantiation are addressed below.
- a. **Compliance Philosophy.** Substantiation should be based on a comparability study between the structural performances of the material accepted for type certification, and the second material. Whatever the modification proposed for a certificated item, the revised margins of safety should remain adequate. Any reduction in the previously demonstrated margin should be investigated in detail.
- (1) **Alternative Material/Process:** New design values for all relevant properties should be determined for any alternate material/process combination. Analytical models initially used to certify structure, including failure prediction models, should be reviewed and, if necessary, substantiated by tests. The procurement specification should be modified (or a new specification suited to the selected material should be defined) to ensure key quality variations are adequately controlled and new acceptance criteria defined. For example, changing from first to second generation of carbon fibres may improve tensile strength properties by more than 20% and a new acceptability threshold will be needed in the specification of the alternate material to ensure the detection of quality variations.
  - (2) **Identical Material:** Data should be provided that demonstrates that the original design values (whatever the level of investigation, material or design) remain valid. Statistical methods need to be employed for data to ensure that key design properties come from the same populations as the original material/process combination. Calculation models including failure prediction should remain the same. The technical content of the procurement specification (Case B) should not need to be changed to properly control quality.
- b. **Testing.**
- (1) The extent of testing needed to substantiate a material change should address the inherent structural behaviour of the composite and will be a function of the airworthiness significance of the part and the material change definition. For example, the investigation level might be restricted to the generic specimens at the test pyramid base (refer to figures in paragraph 7) for an identical material, but non-generic test articles from higher up the pyramid should be included for an alternative material. Care needs to be taken to ensure that the test methods used yield data compatible with data used to determine properties of the original structure.
  - (2) The testing that may be required for a range of possible material and/or process changes should consider all levels of structural substantiation that may be affected. In some instances (e.g., a minor cure cycle change), possible consequences can be assessed by tests on generic specimens only. For other changes, like those involving tooling (e.g., from a full bag process to thermo-expansive cores), the assessment should include an evaluation of the component itself (sometimes called the “tool proof test”). In this case, an expanded NDI procedure should be required for the first items to be produced. This should be supplemented – if deemed necessary – by “cut up” specimens from a representative component, for physical or mechanical investigations.
- c. **Number of Batches.**

- (1) The purpose for testing a number of batches is the demonstration of an acceptable reproducibility of material characteristics. The number of batches required should take into account: material classification (identical or alternative), the investigation level (non-generic or generic specimen) the source of supply, and the property under investigation. Care should be taken to investigate the variation of both basic material and the manufacturing process.
  - (2) Existing references (e.g., The Composite Materials Handbook (CMH-17) Volumes 1 and 3, FAA Technical Report DOT/ FAA/AR-03/19), addressing composite qualification and equivalence and the building block approach, provide more detailed guidance regarding batch and test numbers and the appropriate statistical analysis up to laminate level. Changes at higher pyramid levels, or those associated with other material forms, e.g., braided VARTM (Vacuum-Assisted Resin Transfer Moulding) structure, may require use of other statistical procedures or engineering methods.
- d. **Pass/Fail Criteria.** Target pass/fail criteria should be established as part of the test programme. For strength considerations for instance, a statistical analysis of test data should demonstrate that new design values derived for the second material provide an adequate margin of safety. Therefore, provision should be made for a sufficient number of test specimens to allow for such analysis. At the non-generic level, when only one test article is used to assess a structural feature, the pass criteria should be a result acceptable with respect to design ultimate loads. In the cases where test results show lower margins of safety, certification documentation will need to be revised.
- e. **Other Considerations.** For characteristics other than static strength (all those listed in [AMC 20-29](#), paragraphs 8, 9, 10 and 11), the substantiation should also ensure an equivalent level of safety.

[Amdt 20/6]

## AMC 20-115B

### AMC 20-115B Recognition of Eurocae ED-12B / RTCA DO-178B

*ED Decision 2003/12/RM*

#### 1 PURPOSE

This acceptable means of compliance calls attention to the European Organisation for Civil Aviation Equipment (EUROCAE) document ED-12B, "Software Consideration in Airborne Systems and Equipment Certification", issued December 1992. It discusses how the document may be applied to certification programmes administered by the European Aviation Safety Agency.

#### 2 RELATED DOCUMENTS

2.1 EUROCAE document ED-12B is technically equivalent to RTCA Inc. document DO-178B. A reference to one document, at the same revision level, may be interpreted to mean either document.

2.2 This AMC is based on FAA AC 20-115B, dated 11 January 1993.

#### 3 RELATED CERTIFICATION SPECIFICATIONS (CSs)

Part 21, CS-22, CS-23, CS-25, CS-27, CS-29, CS-AWO, CS-E, CS-P, CS-APU, CS-TSO and CS-VLA. Existing references to ED-12/DO-178 and ED-12A/DO-178A in the above CSs will be amended, at the next opportunity, to take into account the principles spelt out in paragraph 6. below.

#### 4 BACKGROUND

4.1 EUROCAE document ED-12B was developed to establish software considerations for developers, installers and users when the aircraft equipment design is implemented using software-based techniques. Current and future avionics designs will make extensive use of this technology. The EUROCAE document provides guidelines for establishing software levels, software life cycle planning, development, verification, configuration management and quality assurance disciplines to be used in software-based systems.

4.2 The document specifies the information to be made available and/or delivered to the Agency. Guidance is provided also for dealing with software developed to earlier standards, tool qualification and alternative methods which may be used.

#### 5 USE OF EUROCAE ED-12B PROCEDURES

An applicant for EASA certification for any software-based equipment or system may use the considerations outlined in EUROCAE document ED-12B, as a means, but not the only means to secure approval. The Agency may publish acceptable means of compliance for specific CSs, stating the required relationship between the criticality of the software-based systems and the software levels as defined in EUROCAE document ED-12B. Such acceptable means of compliance will take precedence over the application of EUROCAE document ED-12B.

#### 6 USE OF PREVIOUS VERSIONS

ED-12/DO-178 and ED-12A/DO-178A will continue to be accepted for systems and equipment where these have been accepted as the basis for approval or certification.

#### 7 AVAILABILITY OF EUROCAE DOCUMENT ED-12B

Copies may be purchased from EUROCAE, 17 rue Hamelin, 75783 PARIS Cedex 16, France, (Fax: 33 1 4505 7230).

## AMC 20-128A

### AMC 20-128A Design Considerations for Minimizing Hazards Caused by Uncontained Turbine Engine and Auxiliary Power Unit Rotor Failure

*ED Decision 2003/12/RM*

**1 PURPOSE.**

This acceptable means of compliance (AMC) sets forth a method of compliance with the requirements of CS 23.901(f), 23.903(b)(1), 25.903(d)(1) and 25A903(d)(1) of the EASA Certification Specifications (CS) pertaining to design precautions taken to minimise the hazards to an aeroplane in the event of uncontained engine or auxiliary power unit (APU) rotor failures. The guidance provided within this AMC is harmonised with that of the Federal Aviation Administration (FAA) and is intended to provide a method of compliance that has been found acceptable. As with all AMC material, it is not mandatory and does not constitute a regulation.

**2 RESERVED**

**3 APPLICABILITY.**

This AMC applies to CS-23 and CS-25 aeroplanes.

**4 RELATED DOCUMENTS.**

Paragraphs 23.903, and 25.903 of the CS and other paragraphs relating to uncontained engine failures.

- a. Related Joint Aviation Requirements. Sections which prescribe requirements for the design, substantiation and certification relating to uncontained engine debris include:

§ 23.863, 25.863	Flammable fluid fire protection
§ 25.365	Pressurised compartment loads
§ 25.571	Damage-tolerance and fatigue evaluation of structure
§ 25.963	Fuel tanks: general
§ 25.1189	Shut-off means
§ 25.1461	Equipment containing high energy rotors
CS-APU	Auxiliary Power Units

NOTE: The provisions of § 25.1461 have occasionally been used in the approval of APU installations regardless of protection from high energy rotor disintegration. However, the more specific requirements of CS 25.903(d)(1) and associated guidance described within this AMC take precedence over the requirements of CS 25.1461.

- b. Other Documents

ISO 2685:1992	Aircraft – Environmental conditions and test procedures for airborne equipment – Resistance to fire in designated fire zones
AC 20-135	Powerplant Installation and Propulsion System Component Fire Protection Test Methods, Standards, and Criteria.



- c. Society of Automotive Engineers (SAE) Documents.

AIR1537	Report on Aircraft Engine Containment, October, 1977.
AIR4003	Uncontained Turbine Rotor Events Data Period 1976 through 1983.
AIR4770	Uncontained Turbine Rotor Events Data Period 1984 (Draft) through 1989.

These documents can be obtained from the Society of Automotive Engineers, Inc., 400 Commonwealth Drive, Warrendale, Pennsylvania, 15096.

## 5 BACKGROUND.

Although turbine engine and APU manufacturers are making efforts to reduce the probability of uncontained rotor failures, service experience shows that uncontained compressor and turbine rotor failures continue to occur. Turbine engine failures have resulted in high velocity fragment penetration of adjacent structures, fuel tanks, fuselage, system components and other engines on the aeroplane. While APU uncontained rotor failures do occur, and to date the impact damage to the aeroplane has been minimal, some rotor failures do produce fragments that should be considered. Since it is unlikely that uncontained rotor failures can be completely eliminated, CS-23 and CS-25 require that aeroplane design precautions be taken to minimise the hazard from such events.

- a. Uncontained gas turbine engine rotor failure statistics are presented in the Society of Automotive Engineers (SAE) reports covering time periods and number of uncontained events listed in the table shown below. The following statistics summarise 28 years of service experience for fixed wing aeroplanes and do not include data for rotorcraft and APUs:

Report No.	Period	No. of Events		
		Total	Category 3	Category 4
AIR1537	1962–75	275	44	5
AIR4003	1976–83	237	27	3
AIR4770 (Draft)	1984–89	164	22	7
TOTAL		676	93	15

The total of 676 uncontained events includes 93 events classified in Category 3 and 15 events classified in Category 4 damage to the aeroplane. Category 3 damage is defined as significant aeroplane damage with the aeroplane capable of continuing flight and making a safe landing. Category 4 damage is defined as severe aeroplane damage involving a crash landing, critical injuries, fatalities or hull loss.

During this 28 year period there were 1,089.6 million engine operating hours on commercial transports. The events were caused by a wide variety of influences classed as environmental (bird ingestion, corrosion/erosion, foreign object damage (FOD)), manufacturing and material defects, mechanical, and human factors (maintenance and overhaul, inspection error and operational procedures).

- b. Uncontained APU rotor failure statistics covering 1962 through 1993 indicate that there have been several uncontained failures in at least 250 million hours of operation on transport category aeroplanes. No Category 3 or 4 events were reported and all failures occurred during ground operation. These events were caused by a wide variety of influences such as corrosion, ingestion of de-icing fluid, manufacturing and material defects, mechanical, and human factors (maintenance and overhaul, inspection error and operational procedures).

- c. The statistics in the SAE studies indicate the existence of many different causes of failures not readily apparent or predictable by failure analysis methods. Because of the variety of causes of uncontained rotor failures, it is difficult to anticipate all possible causes of failure and to provide protection to all areas. However, design considerations outlined in this AMC provide guidelines for achieving the desired objective of minimising the hazard to an aeroplane from uncontained rotor failures. These guidelines, therefore, assume a rotor failure will occur and that analysis of the effects of this failure is necessary. These guidelines are based on service experience and tests but are not necessarily the only means available to the designer.

## 6 TERMINOLOGY.

- a. Rotor. Rotor means the rotating components of the engine and APU that analysis, test, and/or experience has shown can be released during uncontained failure. The engine or APU manufacturer should define those components that constitute the rotor for each engine and APU type design. Typically rotors have included, as a minimum, discs, hubs, drums, seals, impellers, blades and spacers.
- b. Blade. The airfoil sections (excluding platform and root) of the fan, compressor and turbine.
- c. Uncontained Failure. For the purpose of aeroplane evaluations in accordance with this AMC, uncontained failure of a turbine engine is any failure which results in the escape of rotor fragments from the engine or APU that could result in a hazard. Rotor failures which are of concern are those where released fragments have sufficient energy to create a hazard to the aeroplane.
- d. Critical Component. A critical component is any component whose failure would contribute to or cause a failure condition which would prevent the continued safe flight and landing of the aeroplane. These components should be considered on an individual basis and in relation to other components which could be damaged by the same fragment or by other fragments from the same uncontained event.
- e. Continued Safe Flight and Landing. Continued safe flight and landing means that the aeroplane is capable of continued controlled flight and landing, possibly using emergency procedures and without exceptional pilot skill or strength, with conditions of considerably increased flightcrew workload and degraded flight characteristics of the aeroplane.
- f. Fragment Spread Angle. The fragment spread angle is the angle measured, fore and aft from the centre of the plane of rotation of an individual rotor stage, initiating at the engine or APU shaft centreline (see Figure 1).

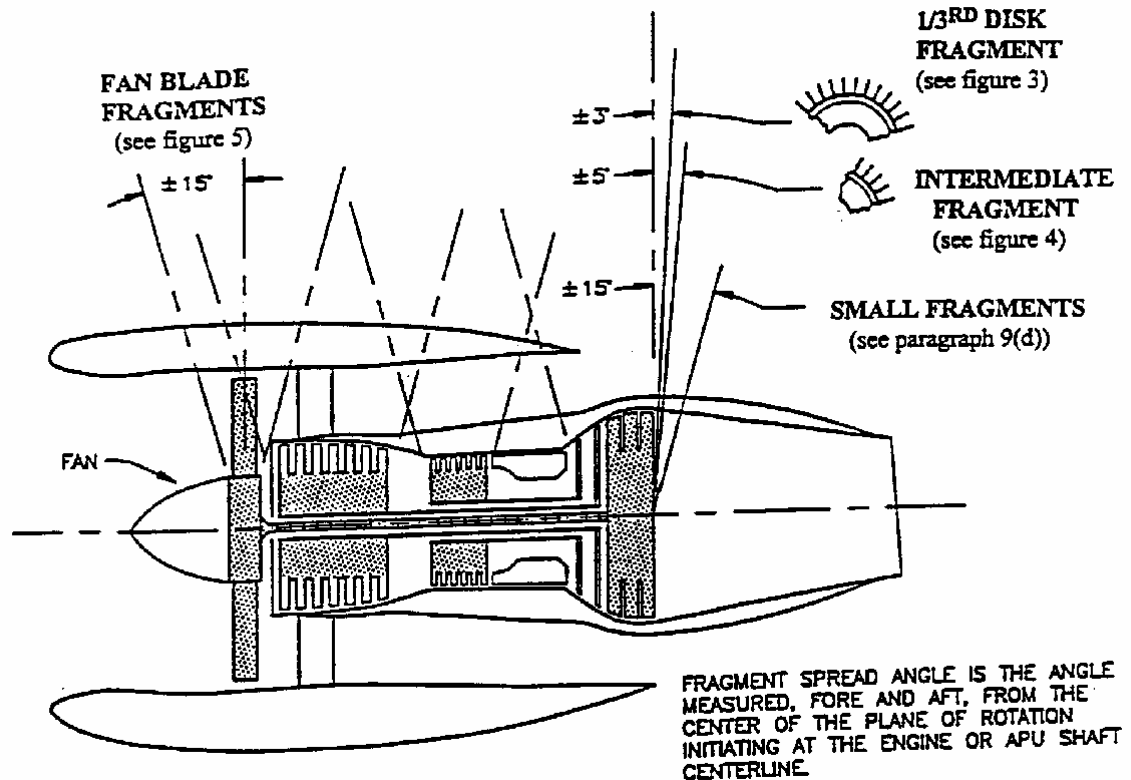

FIGURE 1 – ESTIMATED PATH OF FRAGMENTS

- g. Impact Area. The impact area is that area of the aeroplane likely to be impacted by uncontained fragments generated during a rotor failure (see Paragraph 9).
- h. Engine and APU Failure Model. A model describing the size, mass, spread angle, energy level and number of engine or APU rotor fragments to be considered when analysing the aeroplane design is presented in Paragraph 9.

## 7 DESIGN CONSIDERATIONS.

Practical design precautions should be used to minimise the damage that can be caused by uncontained engine and APU rotor fragments. The most effective methods for minimising the hazards from uncontained rotor fragments include location of critical components outside the fragment impact areas or separation, isolation, redundancy, and shielding of critical aeroplane components and/or systems. The following design considerations are recommended:

- a. Consider the location of the engine and APU rotors relative to critical components, systems or areas of the aeroplane such as:
  - (1) Any other engine(s) or an APU that provides an essential function;
  - (2) Pressurised sections of the fuselage and other primary structure of the fuselage, wings and empennage;
  - (3) Pilot compartment areas;
  - (4) Fuel system components, piping and tanks;
  - (5) Control systems, such as primary and secondary flight controls, electrical power cables, wiring, hydraulic systems, engine control systems, flammable fluid shut-off valves, and the associated actuation wiring or cables;

- (6) Any fire extinguisher system of a cargo compartment, an APU, or another engine including electrical wiring and fire extinguishing agent plumbing to these systems;
  - (7) Engine air inlet attachments and effects of engine case deformations caused by fan blade debris resulting in attachment failures;
  - (8) Instrumentation essential for continued safe flight and landing;
  - (9) Thrust reverser systems where inadvertent deployment could be catastrophic; and
  - (10) Oxygen systems for high altitude aeroplanes, where these are critical due to descent time.
- b. Location of Critical Systems and Components. Critical aeroplane flight and engine control cables, wiring, flammable fluid carrying components and lines (including vent lines), hydraulic fluid lines and components, and pneumatic ducts should be located to minimise hazards caused by uncontained rotors and fan blade debris. The following design practices should be considered:
- (1) Locate, if possible, critical components or systems outside the likely debris impact areas.
  - (2) Duplicate and separate critical components or systems, or provide suitable protection if located in debris impact areas.
  - (3) Protection of critical systems and components can be provided by using airframe structure or supplemental shielding.

These methods have been effective in mitigating the hazards from both single and multiple small fragments within the  $\pm 15^\circ$  impact area. Separation of multiplied critical systems and components by at least a distance equal to the 1/2 blade fragment dimension has been accepted for showing minimisation from a single high energy small fragment when at least one of the related multiplied critical components is shielded by significant structure such as aluminium lower wing skins, pylons, aluminium skin of the cabin pressure vessel, or equivalent structures.

Multiplied critical systems and components positioned behind less significant structures should be separated by at least a distance equal to the 1/2 blade fragment dimension, and at least one of the multiplied critical systems should be:

    - (i) Located such that equivalent protection is provided by other inherent structures such as pneumatic ducting, interiors, bulkheads, stringers, or
    - (ii) Protected by an additional shield such that the airframe structure and shield material provide equivalent shielding.
  - (4) Locate fluid shut-offs and actuation means so that flammable fluid can be isolated in the event of damage to the system.
  - (5) Minimise the flammable fluid spillage which could contact an ignition source.
  - (6) For airframe structural elements, provide redundant designs or crack stoppers to limit the subsequent tearing which could be caused by uncontained rotor fragments.
  - (7) Locate fuel tanks and other flammable fluid systems and route lines (including vent lines) behind aeroplane structure to reduce the hazards from spilled fuel or from

tank penetrations. Fuel tank explosion-suppression materials, protective shields or deflectors on the fluid lines, have been used to minimise the damage and hazards.

- c. External Shields and Deflectors. When shields, deflection devices or aeroplane structure are proposed to be used to protect critical systems or components, the adequacy of the protection, including mounting points to the airframe structure, should be shown by testing or validated analyses supported by test data, using the fragment energies supplied by the engine or APU manufacturer or those defined in Paragraph 9. For protection against engine small fragments, as defined in Paragraph 9, no quantitative validation as defined in Paragraph 10 is required if equivalency to the penetration resistant structures listed (e.g. pressure cabin skins, etc.) is shown.

## **8 ACCEPTED DESIGN PRECAUTIONS.**

Design practices currently in use by the aviation industry that have been shown to reduce the overall risk, by effectively eliminating certain specific risks and reducing the remaining specific risks to a minimum level, are described within this paragraph of the AMC. Aeroplane designs submitted for evaluation by the regulatory authorities will be evaluated against these proven design practices.

### a. Uncontrolled Fire.

- (1) Fire Extinguishing Systems. The engine/APU fire extinguishing systems currently in use rely on a fire zone with a fixed compartment air volume and a known air exchange rate to extinguish a fire. The effectiveness of this type of system along with firewall integrity may therefore be compromised for the torn/ruptured compartment of the failed engine/APU. Protection of the aeroplane following this type of failure relies on the function of the fire warning system and subsequent fire switch activation to isolate the engine/APU from airframe flammable fluid (fuel and hydraulic fluid) and external ignition sources (pneumatic and electrical). Fire extinguishing protection of such a compromised system may not be effective due to the extent of damage. Continued function of any other engine, APU or cargo compartment fire warning and extinguisher system, including electrical wiring and fire extinguishing agent plumbing, should be considered as described in Paragraph 7.
- (2) Flammable Fluid Shut-off Valve. As discussed above, shut-off of flammable fluid supply to the engine may be the only effective means to extinguish a fire following an uncontained failure, therefore the engine isolation/flammable fluid shut-off function should be assured following an uncontained rotor failure. Flammable fluid shut-off valves should be located outside the uncontained rotor impact area. Shut-off actuation controls that need to be routed through the impact area should be redundant and appropriately separated in relation to the one-third disc maximum dimension.
- (3) Fire Protection of Critical Functions. Flammable fluid shut-off and other critical controls should be located so that a fire (caused by an uncontained rotor event) will not prevent actuation of the shut-off function or loss of critical aeroplane functions. If shut-off or other critical controls are located where a fire is possible following an uncontained rotor failure (e.g. in compartments adjacent to fuel tanks) then these items should meet the applicable fire protection guidelines such as ISO 2685:1992 or AC 20-135.

- 
- (4) Fuel Tanks. If fuel tanks are located in impact areas, the following precautions should be implemented:
- (i) Protection from the effects of fuel leakage should be provided for any fuel tanks located above an engine or APU and within the one-third disc and intermediate fragment impact areas. Dry bays or shielding are acceptable means. The dry bay should be sized based on analysis of possible fragment trajectories through the fuel tank wall and the subsequent fuel leakage from the damaged fuel tank so that fuel will not migrate to an engine, APU or other ignition source during either –flight or ground operation. A minimum drip clearance distance of 10 inches (254 mm) from potential ignition sources of the engine nacelle, for static conditions, has been acceptable (see Figure 2).

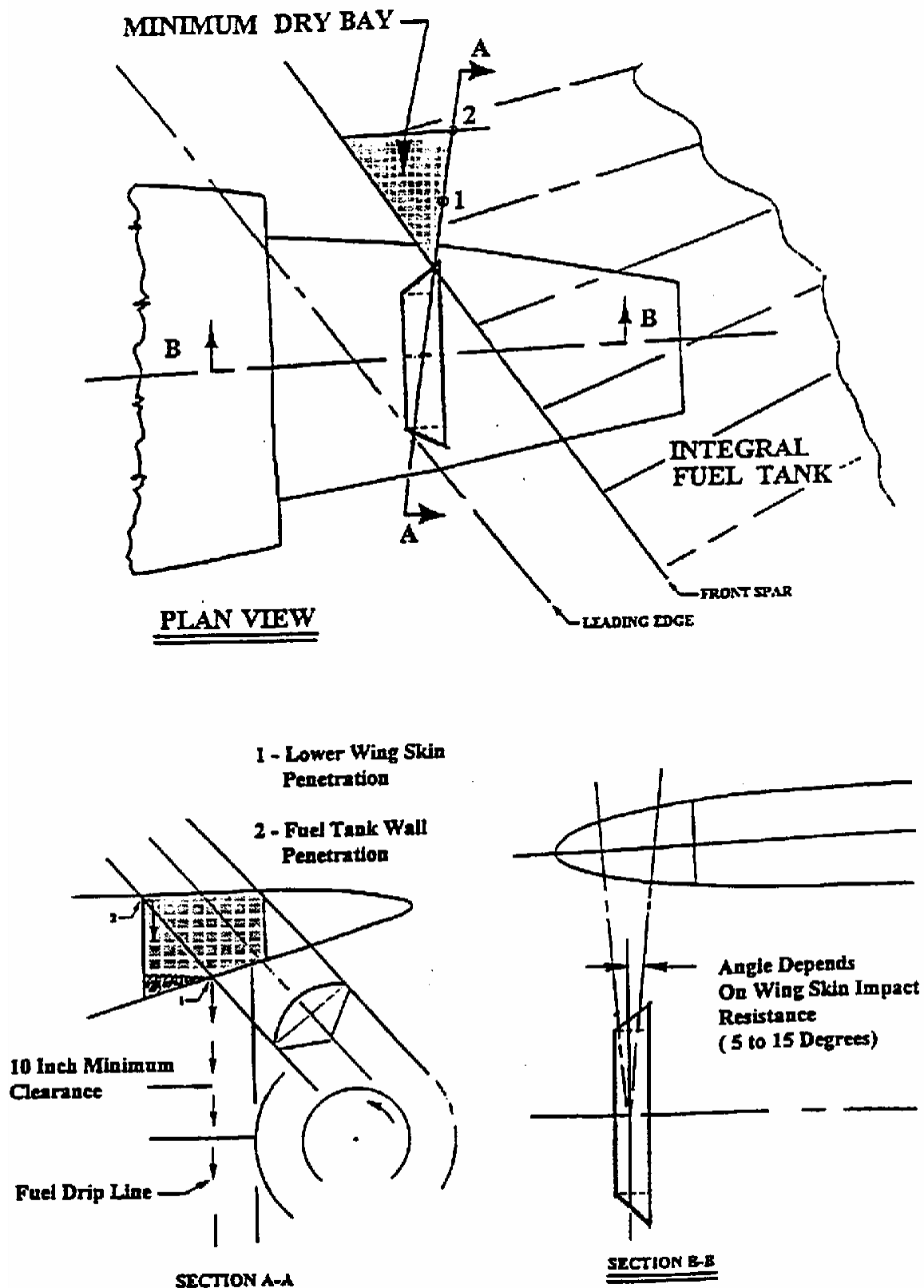

FIGURE 2 – DRY BAY SIZING DETERMINATION EXAMPLE

- (ii) Fuel tank penetration leak paths should be determined and evaluated for hazards during flight and ground phases of operation. If fuel spills into the airstream away from the aeroplane no additional protection is needed. Additional protection should be considered if fuel could spill, drain or migrate into areas housing ignition sources, such as engine or APU inlets or wheel wells. Damage to adjacent systems, wiring etc., should be evaluated regarding the potential that an uncontained fragment will create both an ignition source and fuel source. Wheel brakes may be considered as an ignition source during take-off and initial climb. Protection of the wheel wells may be provided by airflow discharging from gaps or openings, preventing entry of fuel, a ventilation rate precluding a combustible mixture or other provisions indicated in CS 23.863 and CS 25.863.
  - (iii) Areas of the aeroplane where flammable fluid migration is possible that are not drained and vented and have ignition sources or potential ignition sources should be provided with a means of fire detection and suppression and be explosion vented or equivalently protected.
- b. Loss of Thrust.
  - (1) Fuel Reserves. The fuel reserves should be isolatable such that damage from a disc fragment will not result in loss of fuel required to complete the flight or a safe diversion. The effects of fuel loss, and the resultant shift of centre of gravity or lateral imbalance on aeroplane controllability should also be considered.
  - (2) Engine Controls. Engine control cables and/or wiring for the remaining powerplants that pass through the impact area should be separated by a distance equal to the maximum dimension of a one- third disc fragment or the maximum extent possible.
  - (3) Other Engine Damage. Protection of any other engines from some fragments should be provided by locating critical components, such as engine accessories essential for proper engine operation (e.g., high pressure fuel lines, engine controls and wiring, etc.), in areas where inherent shielding is provided by the fuselage, engine or nacelle (including thrust reverser) structure (see Paragraph 7).
- c. Loss of Aeroplane Control
  - (1) Flight Controls. Elements of the flight control system should be adequately separated or protected so that the release of a single one-third disc fragment will not cause loss of control of the aeroplane in any axis. Where primary flight controls have duplicated (or multiplied) elements, these elements should be located to prevent all elements in any axis being lost as a result of the single one- third disc fragment. Credit for maintaining control of the aeroplane by the use of trim controls or other means may be obtained, providing evidence shows that these means will enable the pilot to retain control.
  - (2) Emergency Power. Loss of electrical power to critical functions following an uncontained rotor event should be minimised. The determination of electrical system criticality is dependent upon aeroplane operations. For example, aeroplanes approved for Extended Twin Engine Operations (ETOPS) that rely on alternate power sources such as hydraulic motor generators or APUs may be configured with the electrical wiring separated to the maximum extent possible within the one-third disc impact zone.



- (3) Hydraulic Supply. Any essential hydraulic system supply that is routed within an impact area should have means to isolate the hydraulic supply required to maintain control of the aeroplane. The single one-third disc should not result in loss of all essential hydraulic systems or loss of all flight controls in any axis of the aeroplane.
  - (4) Thrust reverser systems. The effect of an uncontained rotor failure on inadvertent in-flight deployment of each thrust reverser and possible loss of aeroplane control shall be considered. The impact area for components located on the failed engine may be different from the impact area defined in Paragraph 6. If uncontained failure could cause thrust reverser deployment, the engine manufacturer should be consulted to establish the failure model to be considered. One acceptable method of minimisation is to locate reverser restraints such that not all restraints can be made ineffective by the fragments of a single rotor.
- d. Passenger and Crew Incapacitation.
- (1) Pilot Compartment. The pilot compartment of large aeroplanes should not be located within the  $\pm 15^\circ$  spread angle of any engine rotor stage or APU rotor stage that has not been qualified as contained, unless adequate shielding, deflectors or equivalent protection is provided for the rotor stage in accordance with Paragraph 7c. Due to design constraints inherent in smaller CS-23 aeroplanes, it is not considered practical to locate the pilot compartment outside the  $\pm 15^\circ$  spread angle. Therefore for other aeroplanes (such as new CS-23 commuter category aeroplanes) the pilot compartment area should not be located within the  $\pm 5^\circ$  spread angle of any engine rotor stage or APU rotor stage unless adequate shielding, deflectors, or equivalent protection is provided for the rotor stage in accordance with Paragraph 7c of this AMC, except for the following:
    - (i) For derivative CS-23 category aeroplanes where the engine location has been previously established, the engine location in relation to the pilot compartment need not be changed.
    - (ii) For non-commuter CS-23 category aeroplanes, satisfactory service experience relative to rotor integrity and containment in similar engine installations may be considered in assessing the acceptability of installing engines in line with the pilot compartment.
    - (iii) For non-commuter new CS-23 category aeroplanes, where due to size and/or design considerations the  $\pm 5^\circ$  spread angle cannot be adhered to, the pilot compartment/engine location should be analysed and accepted in accordance with Paragraphs 9 and 10.
  - (2) Pressure Vessel. For aeroplanes that are certificated for operation above 41,000 feet, the engines should be located such that the pressure cabin cannot be affected by an uncontained one-third or intermediate disc fragment. Alternatively, it may be shown that rapid decompression due to the maximum hole size caused by fragments within the  $\pm 15^\circ$  zone and the associated cabin pressure decay rate will allow an emergency descent without incapacitation of the flightcrew or passengers. A pilot reaction time of 17 seconds for initiation of the emergency descent has been accepted. Where the pressure cabin could be affected by a one-third disc or intermediate fragments, design precautions should be taken to preclude incapacitation of crew and passengers. Examples of design precautions that have been previously accepted are:

- (i) Provisions for a second pressure or bleed down bulkhead outside the impact area of a one- third or intermediate disc fragment.
- (ii) The affected compartment in between the primary and secondary bulkhead was made inaccessible, by operating limitations, above the minimum altitude where incapacitation could occur due to the above hole size.
- (iii) Air supply ducts running through this compartment were provided with non-return valves to prevent pressure cabin leakage through damaged ducts.

NOTE: If a bleed down bulkhead is used it should be shown that the rate of pressure decay and minimum achieved cabin pressure would not incapacitate the crew, and the rate of pressure decay would not preclude a safe emergency descent.

- e. Structural Integrity. Installation of tear straps and shear ties within the uncontained fan blade and engine rotor debris zone to prevent catastrophic structural damage has been utilised to address this threat.

## 9. ENGINE AND APU FAILURE MODEL.

The safety analysis recommended in Paragraph 10 should be made using the following engine and APU failure model, unless for the particular engine/APU type concerned, relevant service experience, design data, test results or other evidence justify the use of a different model.

- a. Single One-Third Disc fragment. It should be assumed that the one-third disc fragment has the maximum dimension corresponding to one-third of the disc with one-third blade height and a fragment spread angle of  $\pm 3^\circ$ . Where energy considerations are relevant, the mass should be assumed to be one-third of the bladed disc mass and its energy, the translational energy (i.e., neglecting rotational energy) of the sector travelling at the speed of its c.g. location as defined in Figure 3.
- b. Intermediate Fragment. It should be assumed that the intermediate fragment has a maximum dimension corresponding to one-third of the bladed disc radius and a fragment spread angle of  $\pm 5^\circ$ . Where energy considerations are relevant, the mass should be assumed to be 1/30 of the bladed disc mass and its energy the transitional energy (i.e. neglecting rotational energy) of the piece travelling at rim speed (see Figure 4).

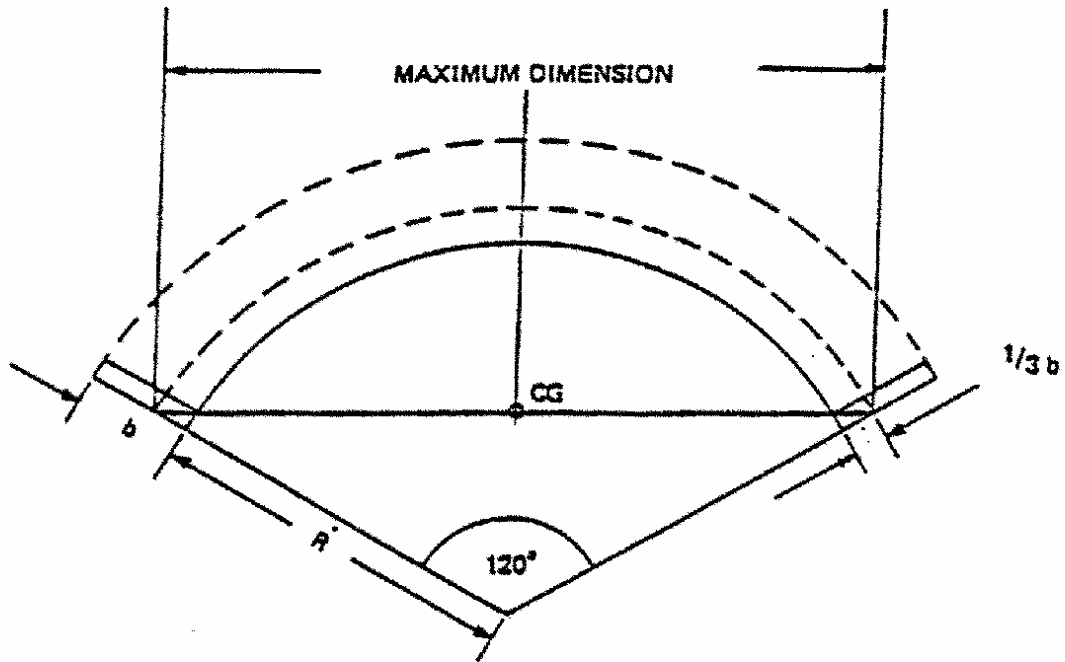

Where  $R$  = disc radius  
 $b$  = blade length

The CG is taken to lie on the maximum dimension as shown.

FIGURE 3 – SINGLE ONE-THIRD ROTOR FRAGMENT

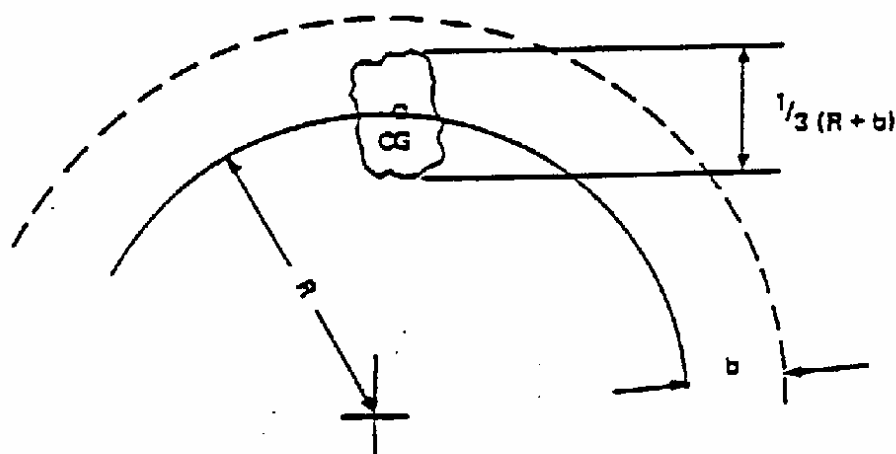

Where  $R$  = disc radius  
 $b$  = blade length

Maximum dimension =  $\frac{1}{3} (R + b)$

Mass assumed to be  $\frac{1}{30}$ th of bladed disc

CG is taken to lie on the disc rim

**FIGURE 4 – INTERMEDIATE FRAGMENT**

- c. Alternative Engine Failure Model. For the purpose of the analysis, as an alternative to the engine failure model of Paragraphs 9a and b, the use of a single one-third piece of disc having a fragment spread angle  $\pm 5^\circ$  would be acceptable, provided the objectives of Paragraph 10c are satisfied.
- d. Small Fragments. It should be assumed that small fragments (shrapnel) range in size up to a maximum dimension corresponding to the tip half of the blade airfoil (with exception of fan blades) and a fragment spread angle of  $\pm 15^\circ$ . Service history has shown that aluminium lower wing skins, pylons, and pressure cabin skin and equivalent structures typically resist penetration from all but one of the most energetic of these fragments. The effects of multiple small fragments should also be considered. Penetration of less significant structures such as fairings, empennage, control surfaces and unpressurised unpressurised skin has typically occurred at the rate of  $2\frac{1}{2}$  percent of the number of blades of the failed rotor stage. Refer to paragraph 7b and 7c for methods of minimisation of the hazards. Where the applicant wishes to show compliance by considering the energy required for penetration of structure (or shielding) the engine manufacturer should be consulted for guidance as to the size and energy of small fragments within the impact area.  
  
For APUs, where energy considerations are relevant, it should be assumed that the mass will correspond to the above fragment dimensions and that it has a translational energy level of one percent of the total rotational energy of the original rotor stage.
- e. Fan Blade Fragment. It should be assumed that the fan blade fragment has a maximum dimension corresponding to the blade tip with one-third the blade airfoil height and a fragment spread angle of  $\pm 15^\circ$ . Where energy considerations are relevant the mass

should be assumed to be corresponding to the one-third of the airfoil including any part span shroud and the transitional energy (neglecting rotational energy) of the fragment travelling at the speed of its c.g. location as defined in Figure 5. As an alternative, the engine manufacturer may be consulted for guidance as to the size and energy of the fragment.

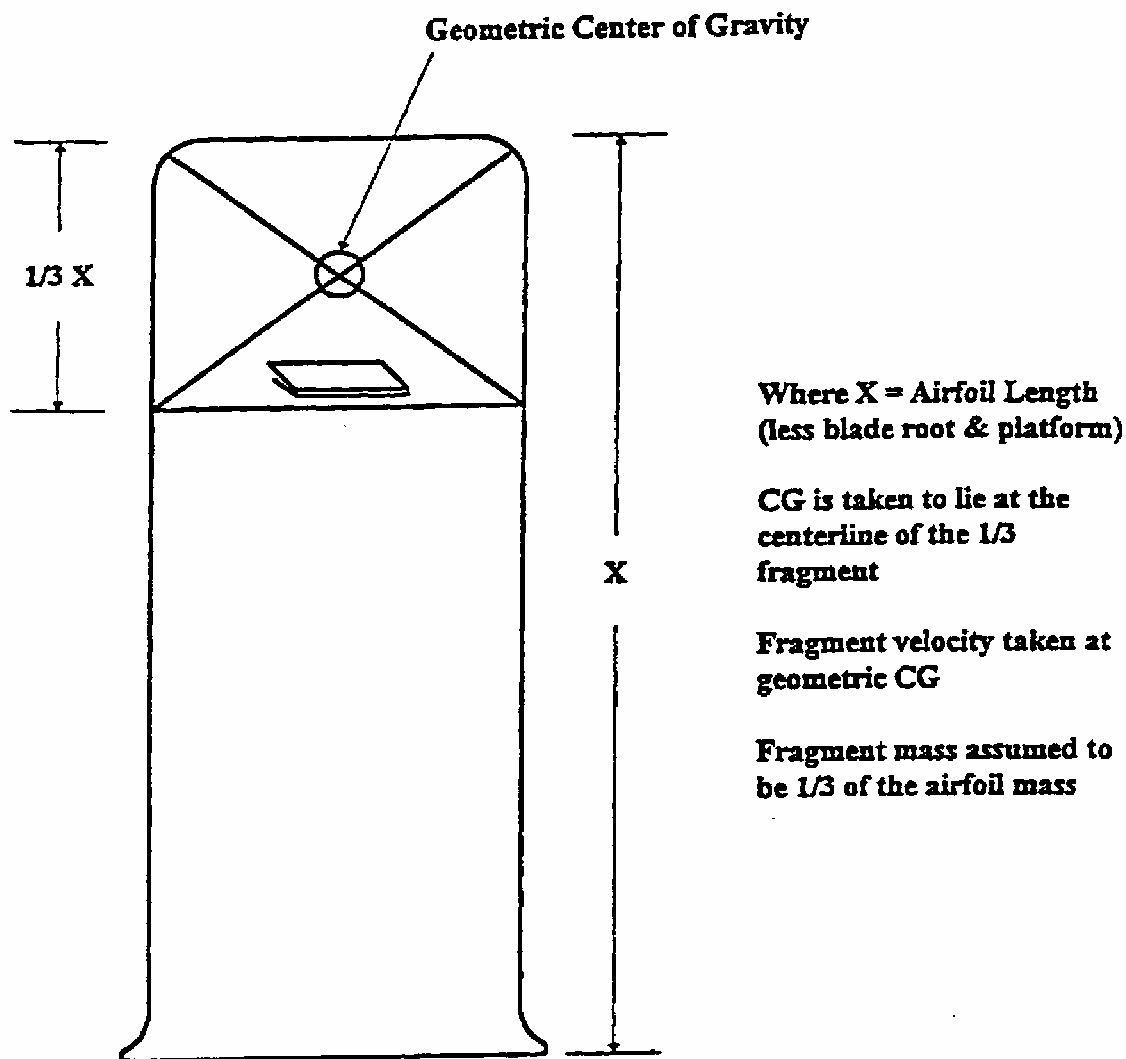

**FIGURE 5 – FAN BLADE FRAGMENT DEFINITION**

- f. Critical Engine Speed. Where energy considerations are relevant, the uncontained rotor event should be assumed to occur at the engine or APU shaft red line speed.
- g. APU Failure Model. For all APU's, the installer also needs to address any hazard to the aeroplane associated with APU debris (up to and including a complete rotor where applicable) exiting the tailpipe. Paragraphs 9g(1) or (2) below or applicable service history provided by the APU manufacturer may be used to define the size, mass, and energy of debris exiting that tailpipe. The APU rotor failure model applicable for a particular APU installation is dependent upon the provisions of CS-APU that were utilised for receiving approval:

- (1) For APU's where rotor integrity has been demonstrated in accordance with CS-APU, i.e. without specific containment testing, Paragraphs 9a, b, and d, or Paragraphs 9c and 9d apply.
- (2) For APU rotor stages qualified as contained in accordance with CS-APU, historical data shows that in-service uncontained failures have occurred. These failure modes have included bi-hub, overspeed, and fragments missing the containment ring which are not addressed by the CS-APU containment test. In order to address these hazards, the installer should use the APU small fragment definition of Paragraph 9d or substantiated in-service data supplied by the APU manufacturer.

## **10 SAFETY ANALYSIS.**

The numerical assessment requested in Paragraph 10c(3) is derived from methods previously prescribed in ACJNo. 2 to CS 25.903(d)(1). The hazard ratios provided are based upon evaluation of various configurations of large aeroplanes, made over a period of time, incorporating practical methods of minimising the hazard to the aeroplane from uncontained engine debris.

- a. Analysis. An analysis should be made using the engine/APU model defined in Paragraph 9 to determine the critical areas of the aeroplane likely to be damaged by rotor debris and to evaluate the consequences of an uncontained failure. This analysis should be conducted in relation to all normal phases of flight, or portions thereof.

NOTE: APPENDIX 1 provides additional guidance for completion of the numerical analysis requested by this paragraph.

- (1) A delay of at least 15 seconds should be assumed before start of the emergency engine shut down. The extent of the delay is dependent upon circumstances resulting from the uncontained failure including increased flightcrew workload stemming from multiplicity of warnings which require analysis by the flightcrew.
  - (2) Some degradation of the flight characteristics of the aeroplane or operation of a system is permissible, provided the aeroplane is capable of continued safe flight and landing. Account should be taken of the behaviour of the aeroplane under asymmetrical engine thrust or power conditions together with any possible damage to the flight control system, and of the predicted aeroplane recovery manoeuvre.
  - (3) When considering how or whether to mitigate any potential hazard identified by the model, credit may be given to flight phase, service experience, or other data, as noted in Paragraph 7.
- b. Drawings. Drawings should be provided to define the uncontained rotor impact threat relative to the areas of design consideration defined in Paragraphs 7a(1) through (10) showing the trajectory paths of engine and APU debris relative to critical areas. The analysis should include at least the following:

- (1) Damage to primary structure including the pressure cabin, engine/APU mountings and airframe surfaces.

NOTE: Any structural damage resulting from uncontained rotor debris should be considered catastrophic unless the residual strength and flutter criteria of ACJ 25.571(a) subparagraph 2.7.2 can be met without failure of any part of the structure essential for completion of the flight. In addition, the pressurised compartment loads of CS 25.365(e)(1) and (g) must be met.

- (2) Damage to any other engines (the consequences of subsequent uncontained debris from the other engine(s), need not be considered).
  - (3) Damage to services and equipment essential for safe flight and landing (including indicating and monitoring systems), particularly control systems for flight, engine power, engine fuel supply and shut-off means and fire indication and extinguishing systems.
  - (4) Pilot incapacitation, (see also paragraph 8 d(1)).
  - (5) Penetration of the fuel system, where this could result in the release of fuel into personnel compartments or an engine compartment or other regions of the aeroplane where this could lead to a fire or explosion.
  - (6) Damage to the fuel system, especially tanks, resulting in the release of a large quantity of fuel.
  - (7) Penetration and distortion of firewalls and cowling permitting a spread of fire.
  - (8) Damage to or inadvertent movement of aerodynamic surfaces (e.g.. flaps, slats, stabilisers, ailerons, spoilers, thrust reversers, elevators, rudders, strakes, winglets, etc.) and the resultant effect on safe flight and landing.
- c. Safety Analysis Objectives. It is considered that the objective of minimising hazards will have been met if:
- (1) The practical design considerations and precautions of Paragraphs 7 and 8 have been taken;
  - (2) The safety analysis has been completed using the engine/APU model defined in Paragraph 9;
  - (3) For CS-25 large aeroplanes and CS-23 commuter category aeroplanes, the following hazard ratio guidelines have been achieved:
    - (i) Single One-Third Disc Fragment. There is not more than a 1 in 20 chance of catastrophe resulting from the release of a single one-third disc fragment as defined in Paragraph 9a.
    - (ii) Intermediate Fragment. There is not more than a 1 in 40 chance of catastrophe resulting from the release of a piece of debris as defined in Paragraph 9b.
    - (iii) Multiple Disc Fragments. (Only applicable to any duplicated or multiplied system when all of the system channels contributing to its functions have some part which is within a distance equal to the diameter of the largest bladed rotor, measured from the engine centreline). There is not more than 1 in 10 chance of catastrophe resulting from the release in three random directions of three one-third fragments of a disc each having a uniform probability of ejection over the 360° (assuming an angular spread of  $\pm 3^\circ$  relative to the plane of the disc) causing coincidental damage to systems which are duplicated or multiplied.

NOTE: Where dissimilar systems can be used to carry out the same function (e.g. elevator control and pitch trim), they should be regarded as duplicated (or multiplied) systems for the purpose of this subparagraph provided control can be maintained.

The numerical assessments described above may be used to judge the relative values of minimisation. The degree of minimisation that is feasible may vary depending upon aeroplane size and configuration and this variation may prevent the specific hazard ratio from being achieved. These levels are design goals and should not be treated as absolute targets. It is possible that any one of these levels may not be practical to achieve.

- (4) For newly designed non-commuter CS-23 aeroplanes the chance of catastrophe is not more than twice that of Paragraph 10(c)(3)(i), (ii) and (iii) for each of these fragment types.
  - (5) A numerical risk assessment is not requested for the single fan blade fragment, small fragments, and APU and engine rotor stages which are qualified as contained.
- d. APU Analysis For APU's that are located where no hazardous consequences would result from an uncontained failure, a limited qualitative assessment showing the relative location of critical systems/components and APU impact areas is all that is needed. If critical systems/components are located within the impact area, more extensive analysis is needed. For APUs which have demonstrated rotor integrity only, the failure model outlined in Paragraph 9g(1) should be considered as a basis for this safety assessment. For APU rotor stages qualified as contained per CS-APU, the aeroplane safety analysis may be limited to an assessment of the effects of the failure model outlined in Paragraph 9g(2).
- e. Specific Risk The aeroplane risk levels specified in Paragraph 10c, resulting from the release of rotor fragments, are the mean values obtained by averaging those for all rotors on all engines of the aeroplane, assuming a typical flight. Individual rotors or engines need not meet these risk levels nor need these risk levels be met for each phase of flight if either:
- (1) No rotor stage shows a higher level of risk averaged throughout the flight greater than twice those stated in Paragraph 10c.

NOTE: The purpose of this Paragraph is to ensure that a fault which results in repeated failures of any particular rotor stage design, would have only a limited effect on aeroplane safety.



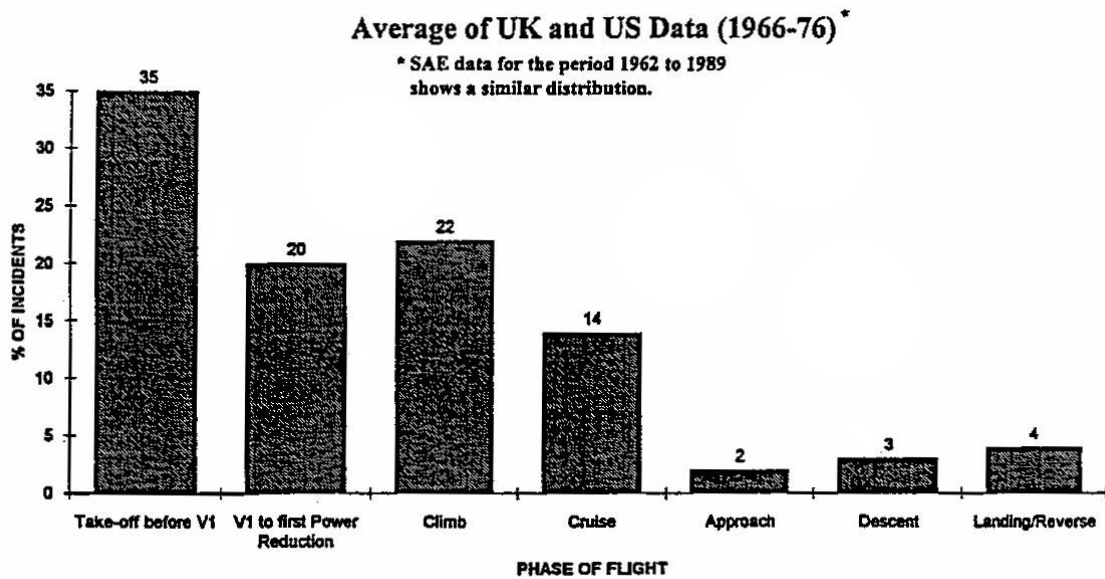

FIGURE 6 – ALL NON-CONTAINMENTS BY PHASE OF FLIGHT

- (2) Where failures would be catastrophic in particular portions of flight, allowance is made for this on the basis of conservative assumptions as to the proportion of failures likely to occur in these phases. A greater level of risk could be accepted if the exposure exists only during a particular phase of flight e.g., during take-off. The proportional risk of engine failure during the particular phases of flight is given in SAE Papers referenced in Paragraph 4d. See also data contained in the CAA paper "Engine Non-Containments – The CAA View", which includes Figure 6. This paper is published in NASA Report CP-2017, "An Assessment of Technology for Turbo-jet Engine Rotor Failures", dated August 1977.

## Appendix 1 to AMC 20-128A User's Manual

ED Decision 2003/12/RM

### RISK ANALYSIS METHODOLOGY for UNCONTAINED ENGINE/APU FAILURE

#### INDEX

- 1.0 GENERAL
- 2.0 SCOPE
- 3.0 FUNDAMENTAL COMPONENTS OF A SAFETY AND RISK ANALYSIS
- 4.0 ASSUMPTIONS
- 5.0 PLOTTING
- 6.0 METHODOLOGY – PROBABILITY ASSESSMENT
- 7.0 RESULTS ASSESSMENT

- FIGURE 1 EXAMPLE – HAZARD TREE
- FIGURE 2 EXAMPLE – SYSTEM LOADING MATRIX
- FIGURE 3 TRI-SECTOR ROTOR BURST
- FIGURE 4 TYPICAL LAYOUT OF SYSTEMS IN ROTOR PLANE
- FIGURE 5 TRAJECTORY RANGE PLOTTING
- FIGURE 6 TYPICAL TRAJECTORY PLOTTING
- FIGURE 7 DEFINITION – THREAT WINDOW
- FIGURE 8 SAMPLE ROTOR STAGE PLOTTING CHART

#### 1.0 GENERAL

- 1.1 The design of aeroplane and engine systems and the location of the engines relative to critical systems and structure have a significant impact on survivability of the aeroplane following an uncontained engine failure. CS 23.903(b)(1) and 25.903(d)(1) of the EASA Certification Specifications (CS) require that design precautions be taken to minimise the hazard to the aeroplane due to uncontained failures of engine or auxiliary power unit (APU). [AMC 20-128A](#) provides guidance for demonstrating compliance with these requirements.
- 1.2 As a part of this compliance demonstration, it is necessary to quantitatively assess the risk of a catastrophic failure in the event of an uncontained engine failure. This User's Manual describes an acceptable method for this purpose.
- 1.3 The objective of the risk analysis is to measure the remaining risk after prudent and practical design considerations have been taken. Since each aeroplane would have unique features which must be considered when applying the methods described in this manual, there should be some flexibility in the methods and procedures.
- 1.4 It is a preferred approach to use these methods throughout the development of an aeroplane design to identify problem areas at an early stage when appropriate design changes are least disruptive. It is also advisable to involve the European Aviation Safety Agency (EASA) in this process at an early stage when appropriate interpretation of the methodology and documentation requirements can be established.
- 1.5 It should be noted that although the risk analysis produces quantitative results, subjective assessments are inherent in the methods of the analysis regarding the criticality of specific types of aeroplane component failures. Assumptions for such assessments should be documented along with the numerical results.

- 1.6 Aeroplane manufacturers have each developed their own method of assessing the effects of rotor failure, as there are many ways to get to the same result. This User's Manual identifies all the elements that should be contained in an analysis, so that it can be interpreted by a person not familiar with such a process.
- 1.7 The intent of this manual therefore is to aid in establishing how an analysis is prepared, without precluding any technological advances or existing proprietary processes.
- 1.8 AMC 20-128A makes allowance for the broad configuration of the aeroplane as such damage to the structure due to rotor failure generally allows for little flexibility in design. System lay-out within a rotor burst zone, however, can be optimized.
- 1.9 Damage to structure, which may involve stress analysis, generally can be analyzed separately, and later coordinated with simultaneous system effects.
- 1.10 For an analysis of the effects on systems due to a rotor failure the aeroplane must be evaluated as a whole; and a risk analysis must specifically highlight all critical cases identified which have any potential to result in a catastrophe.
- 1.11 Such an analysis can then be used to establish that reasonable precautions have been taken to minimise the hazards, and that the remaining hazards are an acceptable risk.
- 1.12 A safety and a risk analysis are interdependent, as the risk analysis must be based on the safety analysis.

The safety analysis therefore is the starting point that identifies potential hazardous or catastrophic effects from a rotor failure and is the basic tool to minimise the hazard in accordance with the guidelines of [AMC 20-128A](#).

- 1.13 The risk analysis subsequently assesses and quantifies the residual risk to the aeroplane.

## 2.0 SCOPE

The following describes the scope of analyses required to assess the aeroplane risk levels against the criteria set forth in Paragraph 10 of [AMC 20-128A](#).

### 2.1 Safety

Analysis is required to identify the critical hazards that may be numerically analyzed (hazards remaining after all practical design precautions have been taken).

Functional criticality will vary by aeroplane and may vary by flight phase.

Thorough understanding of each aeroplane structure and system functions is required to establish the criticality relative to each fragment trajectory path of the theoretical failure.

Assistance from experts within each discipline is typically required to assure accuracy of the analysis in such areas as effects of fuel tank penetration on leakage paths and ignition hazards, thrust level control (for loss of thrust assessment), structural capabilities (for fuselage impact assessment), aeroplane controllability (for control cables impact assessment), and fuel asymmetry.

### 2.2 Risk

For each remaining critical hazard, the following assessments may be prepared using the engine/APU failure models as defined in Paragraph 9 of [AMC 20-128A](#):

- a. Flight mean risk for single 1/3 disc fragment.
- b. Flight mean risk for single intermediate fragment.

- c. Flight mean risk for alternate model (when used as an alternate to the 1/3 disc fragment and intermediate fragment).
- d. Multiple 1/3 disc fragments for duplicated or multiplied systems.
- e. Specific risk for single 1/3 disc fragment and single intermediate fragment.
- f. Specific risk for any single disc fragment that may result in catastrophic structural damage.

The risk level criteria for each failure model are defined in Paragraph 10 of [AMC 20-128A](#).

### 3.0 FUNDAMENTAL COMPONENTS OF A SAFETY AND RISK ANALYSIS

3.1 The logical steps for a complete analysis are:

- a. Establish at the design definition the functional hazards that can arise from the combined or concurrent failures of individual systems, including multiplied systems and critical structure.
- b. Establish a Functional Hazard Tree (see Figure 1), or a System Matrix (see Figure 2) that identifies all system interdependencies and failure combinations that must be avoided (if possible) when locating equipment in the rotor burst impact area.

In theory, if this is carried out to the maximum, no critical system hazards other than opposite engine or fuel line hits would exist.

- c. Establish the fragment trajectories and trajectory ranges both for translational and spread risk angles for each damage. Plot these on a chart or graph, and identify the trajectory ranges that could result in hazardous combinations (threats) as per the above system matrix or functional hazard analysis.
- d. Apply risk factors, such as phase of flight or other, to these threats, and calculate the risk for each threat for each rotor stage.
- e. Tabulate, summarize and average all cases.

3.2 In accordance with [AMC 20-128A](#) the risk to the aeroplane due to uncontained rotor failure is assessed to the effects, once such a failure has occurred.

The probability of occurrence of rotor failure, as analyzed with the probability methods of AMC 25.1309 (i.e. probability as a function of critical uncontained rotor failure rate and exposure time), does not apply.

3.3 The total risk level to the aeroplane, as identified by the risk analysis, is the mean value obtained by averaging the values of all rotor stages of all engines of the aeroplane, expressed as Flight Mean Risk.

### 4.0 ASSUMPTIONS

4.1 The following conservative assumptions, in addition to those in Paragraphs 10(a)(1), (2) and (3) of [AMC 20-128A](#), have been made in some previous analyses. However, each aeroplane design may have unique characteristics and therefore a unique basis for the safety assessment leading to the possibility of different assumptions. All assumptions should be substantiated within the analysis:

- a. The 1/3 disc fragment as modeled in Paragraph 9(a) of the [AMC 20-128A](#) travels along a trajectory path that is tangential to the sector centroid locus, in the direction of rotor rotation (Refer to Figure 3).

The sector fragment rotates about its centroid without tumbling and sweeps a path equal to twice the greatest radius that can be struck from the sector centroid that intersects its periphery.

The fragment is considered to possess infinite energy, and therefore to be capable of severing lines, wiring, cables and unprotected structure in its path, and to be undeflected from its original trajectory unless deflection shields are fitted. However, protective shielding or an engine being impacted may be assumed to have sufficient mass to stop even the most energetic fragment.

- b. The probability of release of debris within the maximum spread angle is uniformly distributed over all directions.
- c. The effects of severed electrical wiring are dependent on the configuration of the affected system. In general, severed wiring is assumed to not receive inadvertent positive voltage for any significant duration.
- d. Control cables that are struck by a fragment disconnect.
- e. Hydraulically actuated, cable driven control surfaces, which do not have designated “fail to” settings, tend to fail to null when control cables are severed. Subsequent surface float is progressive and predictable.
- f. Systems components are considered unserviceable if their envelope has been touched. In case of an engine being impacted, the nacelle structure may be regarded as engine envelope, unless damage is not likely to be hazardous.
- g. Uncontained events involving in-flight penetration of fuel tanks will not result in fuel tank explosion.
- h. Unpowered flight and off-airport landings, including ditching, may be assumed to be not catastrophic to the extent validated by accident statistics or other accepted factors.
- i. Damage to structure essential for completion of flight is catastrophic (Ref. [AMC 20-128A](#), Paragraph 10.b(1)).
- j. The flight begins when engine power is advanced for takeoff and ends after landing when turning off the runway.

## 5.0 PLOTTING

- 5.1 Cross-section and plan view layouts of the aeroplane systems in the ranges of the rotor burst impact areas should be prepared, either as drawings, or as computer models

These layouts should plot the precise location of the critical system components, including fuel and hydraulic lines, flight control cables, electric wiring harnesses and junction boxes, pneumatic and environmental system ducting, fire extinguishing; critical structure, etc.

- 5.2 For every rotor stage a plane is developed. Each of these planes contains a view of all the system components respective outer envelopes, which is then used to generate a cross-section. See Figure 4.
- 5.3 Models or drawings representing the various engine rotor stages and their fore and aft deviation are then generated.
- 5.4 The various trajectory paths generated for each engine rotor stage are then superimposed on the cross-section layouts of the station planes that are in the range of

that potential rotor burst in order to study the effects (see Figure 5). Thus separate plots are generated for each engine rotor stage or rotor group.

To reduce the amount of an analysis the engine rotor stages may also be considered as groups, as applicable for the engine type, using the largest rotor stage diameter of the group.

- 5.5 These trajectory paths may be generated as follows and as shown in Figure 6:
- a. Two tangent lines T1 are drawn between the locus of the centroid and the target envelope.
  - b. At the tangent line touch points, lines N1 and N2 normal to the tangent lines, are drawn with the length equal to the radius of the fragment swept path (as also shown in Figure 1).
  - c. Tangent lines T2 are drawn between the terminal point of the normal lines and the locus of the centroid. The angle between these two tangent lines is the translational risk angle.
- 5.6 The entry and exit angles are then calculated.
- 5.7 The initial angle of intersection and the final angle of intersection are recorded, and the trajectories in between are considered to be the range of trajectories in which this particular part would be impacted by a rotor sector, and destroyed (i.e. the impact area). The intersections thus recorded are then entered on charts in tabular form so that the simultaneous effects can be studied. Refer to Figure 8.
- Thus it will be seen that the total systems' effects can be determined and the worst cases identified.
- 5.9 If a potentially serious multiple system damage case is identified, then a more detailed analysis of the trajectory range will be carried out by breaking the failure case down into the specific fore-aft spread angle, using the individual rotor stage width instead of combined groups, if applicable.

## 6.0 METHODOLOGY – PROBABILITY ASSESSMENT

- 6.1 Those rotor burst cases that have some potential of causing a catastrophe are evaluated in the analysis in an attempt to quantify an actual probability of a catastrophe, which will, in all cases, depend on the following factors:
- a. The location of the engine that is the origin of the fragment, and its direction of rotation.
  - b. The location of critical systems and critical structure.
  - c. The rotor stage and the fragment model.
  - d. The translational trajectory of the rotor fragment,
  - e. The specific spread angle range of the fragment.
  - f. The specific phase of the flight at which the failure occurs.
  - g. The specific risk factor associated with any particular loss of function.

## 6.2 Engine Location

The analysis should address the effects on systems during one flight after a single rotor burst has occurred, with a probability of 1.0. As the cause may be any one of the engines, the risk from each engine is later averaged for the number of engines.

The analysis trajectory charts will then clearly show that certain system damage is unique to rotor fragments from a particular engine due to the direction of rotation, or, that for similar system damage the trajectory range varies considerably between engines.

A risk summary should table each engine case separately with the engine location included.

## 6.3 Rotor Element

The probability of rotor failure is assumed to be 1.0 for each of all rotor stages. For the analysis the individual risk(s) from each rotor stage of the engine should be assessed and tabled.

## 6.4 Translational Risk Angle

The number of degrees of included arc (out of 360) at which a fragment intersects the component/structure being analyzed. Refer to Figure 6 and Figure 7.

## 6.5 Trajectory Probability (P)

The probability of a liberated rotor fragment leaving the engine case is equal over 360°, thus the probability P of that fragment hitting a system component is the identified Translational Risk Angle  $\phi$  in degrees °, divided by 360, i.e.

$$P = \phi/360$$

or

$$\frac{\phi_1 - \phi_2}{360}$$

## 6.6 Spread Angle

If the failure model of the analysis assumes a (fore and aft) spread of  $\pm 5^\circ$ , then the spread angle is a total of  $10^\circ$ . If a critical component can only be hit at a limited position within that spread, then the exposure of that critical component can then be factored according to the longitudinal position within the spread angle, e.g.:

$$\frac{\psi_2 - \psi_1}{\text{spread angle}}$$

If a component can only be hit at the extreme forward range of  $+4^\circ$  to  $+5^\circ$ , then the factor is .1 (for one degree out of 10).

## 6.7 Threat Window

The definition of a typical threat window is shown in Figure 7.

## 6.8 Phase of Flight

Certain types of system damage may be catastrophic only during a specific portion of the flight profile, such as a strike on the opposite engine during take-off after V1 (i.e. a probability of 1.0), while with altitude a straight-ahead landing may be possible under certain favourable conditions (e.g. a probability of less than 1.0). The specific case can then be factored accordingly.

6.8.1 The most likely time for an uncontained rotor failure to occur is during take-off, when the engine is under highest stress. Using the industry accepted standards for the percentage of engine failures occurring within each flight phase, the following probabilities are assumed:

Take-off before V1	35%
V1 to first power reduction	20%
Climb	22%
Cruise	14%
Descent	3%
Approach	2%
Landing/Reverse	4%

6.8.2 The flight phase failure distribution above is used in the calculations of catastrophic risk for all cases where this risk varies with flight phase.

$$Dp = \frac{P \text{ flight phase } \%}{100}$$

6.9 Other Risk Factors

Risks such as fire, loss of pressurization, etc., are individually assessed for each case where applicable, using conservative engineering judgment. This may lead to a probability of catastrophe (i.e., risk factor) smaller than 1.0.

6.9.1 The above probabilities and factors are used in conjunction with the critical trajectory range defined to produce a probability of the specific event occurring from any random rotor burst.

This value is then factored by the "risk" factor assessed for the case, to derive a calculated probability of catastrophe for each specific case.

Typical conditional probability values for total loss of thrust causing catastrophic consequences are:

Phase	Dp	Risk
T.O.-V1 to first power reduction	0.20	1.0
Climb	0.22	0.4
Cruise	0.14	0.2
Descent	0.03	0.4
Approach	0.02	0.4

6.10 All individual case probabilities are then tabled and summarised.

6.11 The flight mean values are obtained by averaging those for all discs or rotor stages on all engines across a nominal flight profile.

The following process may be used to calculate the flight mean value for each Failure Model:

- a. Establish from the table in Figure 8 the threat windows where, due to combination of individual damages, a catastrophic risk exists.
- b. For each stage case calculate the risk for all Critical Hazards



- c. For each stage case apply all risk factors, and, if applicable, factor for Flight Phase-Failure distribution
- d. For each engine, average all stages over the total number of engine stages
- e. For each aeroplane, average all engines over the number of engines.

## 7.0 RESULTS ASSESSMENT

7.1 An applicant may show compliance with CS 23.903(b)(1) and CS 25.903(d)(1) using guidelines set forth in [AMC 20-128A](#). The criteria contained in the AMC may be used to show that:

- a. Practical design precautions have been taken to minimise the damage that can be caused by uncontained engine debris, and
- b. Acceptable risk levels, as specified in [AMC 20-128A](#), Paragraph 10, have been achieved for each critical Failure Model.

7.2 The summary of the applicable risk level criteria is shown in Table 1 below.

**Table 1 Summary of Acceptable Risk Level Criteria**

Requirement	Criteria
Average 1/3 Disc Fragment	1 in 20
Average Intermediate Fragment	1 in 40
Average Alternate Model	1 in 20 @ ± 5 degree Spread Angle
Multiple Disc Fragments	1 in 10
Any single fragment (except for structural damage)	2 x corresponding average criterion

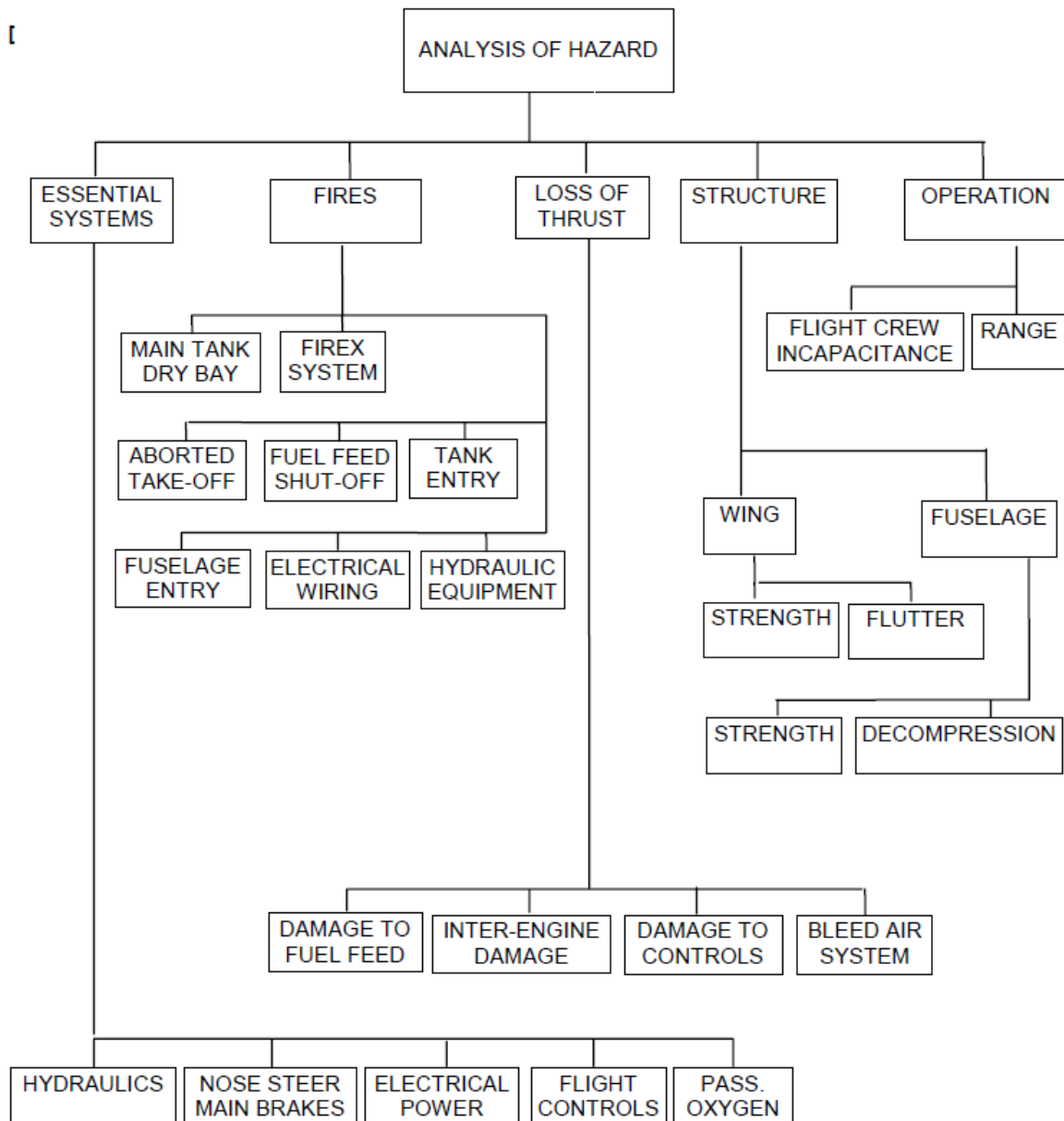

EXAMPLE – HAZARD TREE

FIGURE 1

LOC	COMPONENT	DAMAGE TO	SYSTEM LOADED	DETAIL
LEFT	AILERON	CABLES/SURFACE	HYDRAULIC POWER	#1 & #3
RIGHT	AILERON	CABLES/SURFACE	HYDRAULIC POWER	#2 & #3
LEFT	SPOILER - OUTBD MULTI-FUNCTION	CONTROL/SURFACE	HYDRAULIC POWER	#1
RIGHT	SPOILER - OUTBD MULTI-FUNCTION	CONTROL/SURFACE	HYDRAULIC POWER	#1
LEFT	FLAP-OUTBD	TRACK/SURFACE	ELECTRICAL POWER	AC BUS1 AC ESS
RIGHT	FLAP-OUTBD	TRACK/SURFACE	ELECTRICAL POWER	AC BUS1 AC ESS

LEFT	RUDDER	CABLE	HYDRAULIC POWER	#1,#2&#3
RIGHT	RUDDER	CABLE	HYDRAULIC POWER	#1,#2&#3
LEFT	ELEVATOR	CABLES Note 1	HYDRAULIC POWER	#1 & #3
RIGHT	ELEVATOR	CABLES Note 1	HYDRAULIC POWER	#2 & #3
CHAN1	PITCH TRIM	CONTROL/POWER Note 2	ELECTRICAL POWER	AC BUS1 DC BUS1
CHAN2	PITCH TRIM	CONTROL/POWER Note 2	ELECTRICAL POWER	AC ESS DC ESS

**FLIGHT CONTROLS – SYSTEM LOADING**

**Note 1:**

Same fragment path must not sever:

ON-SIDE cables + OFF-SIDE hydraulic system + HYDRAULIC PWR #3

e.g.: Left elevator cable and HYDRAULIC PWR #2 and #3 or,

Right elevator cable and HYDRAULIC PWR # 1 and # 3

**Note 2:**

Same fragment path must not sever:

- Both CHAN1 and CHAN2 circuits
- ON-SIDE control circuit + OFF-SIDE power circuit
- OFF-SIDE control circuit + ON-SIDE power circuit

**EXAMPLE – SYSTEM LOADING MATRIX**

**FIGURE 2**

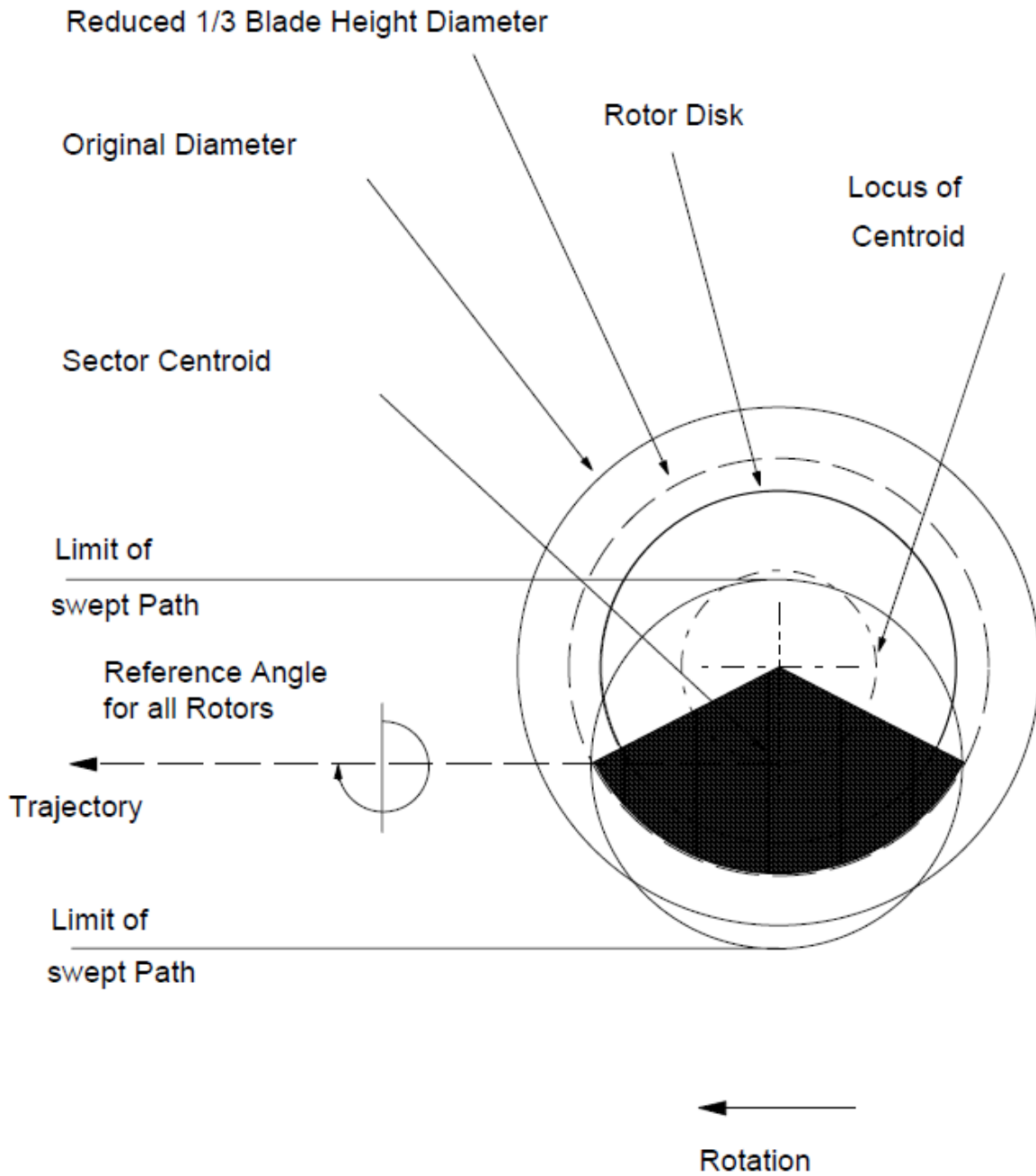

**TRI-SECTOR ROTOR BURST**

**FIGURE 3**

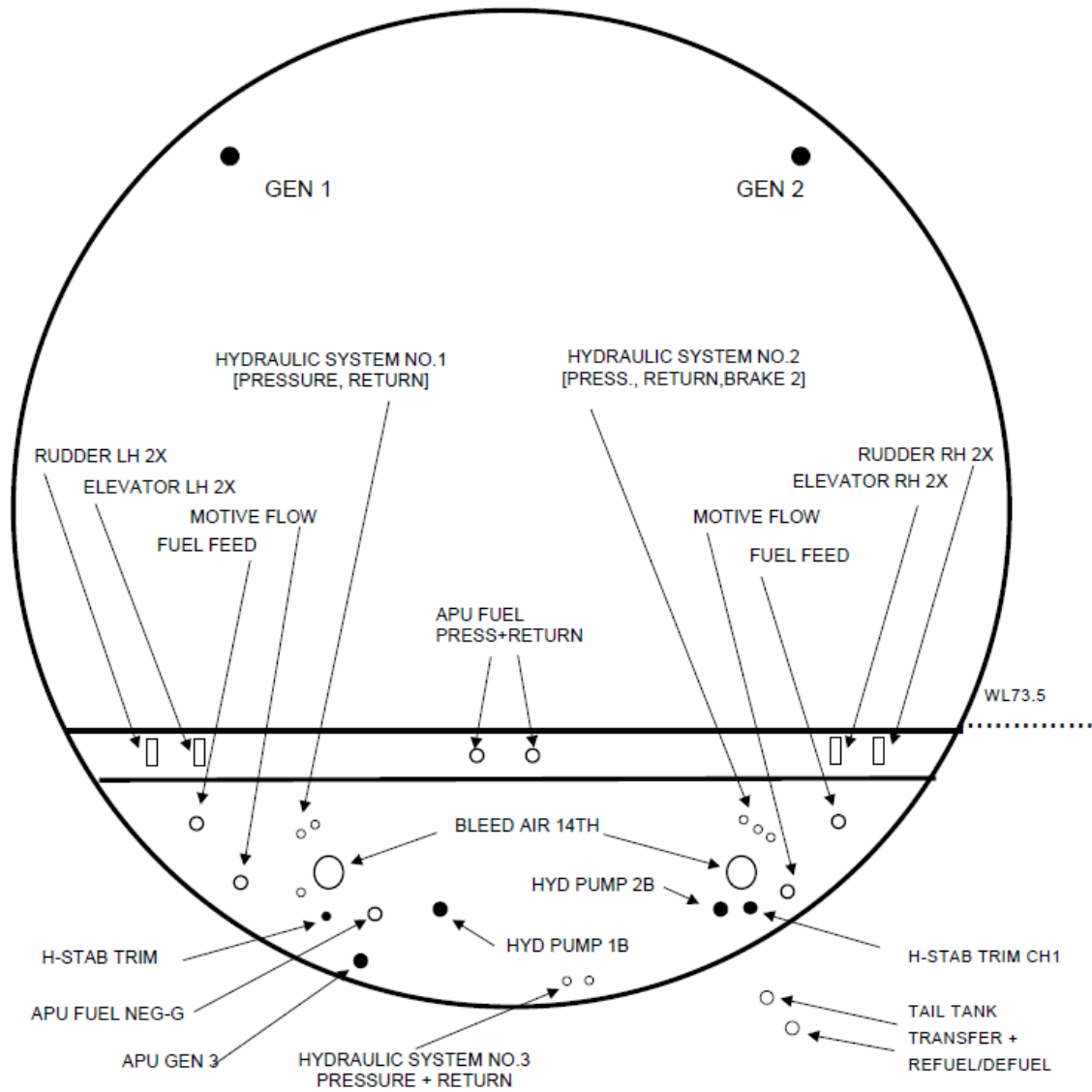

**TYPICAL LAYOUT OF SYSTEMS IN ROTOR PLANE**

**FIGURE 4**

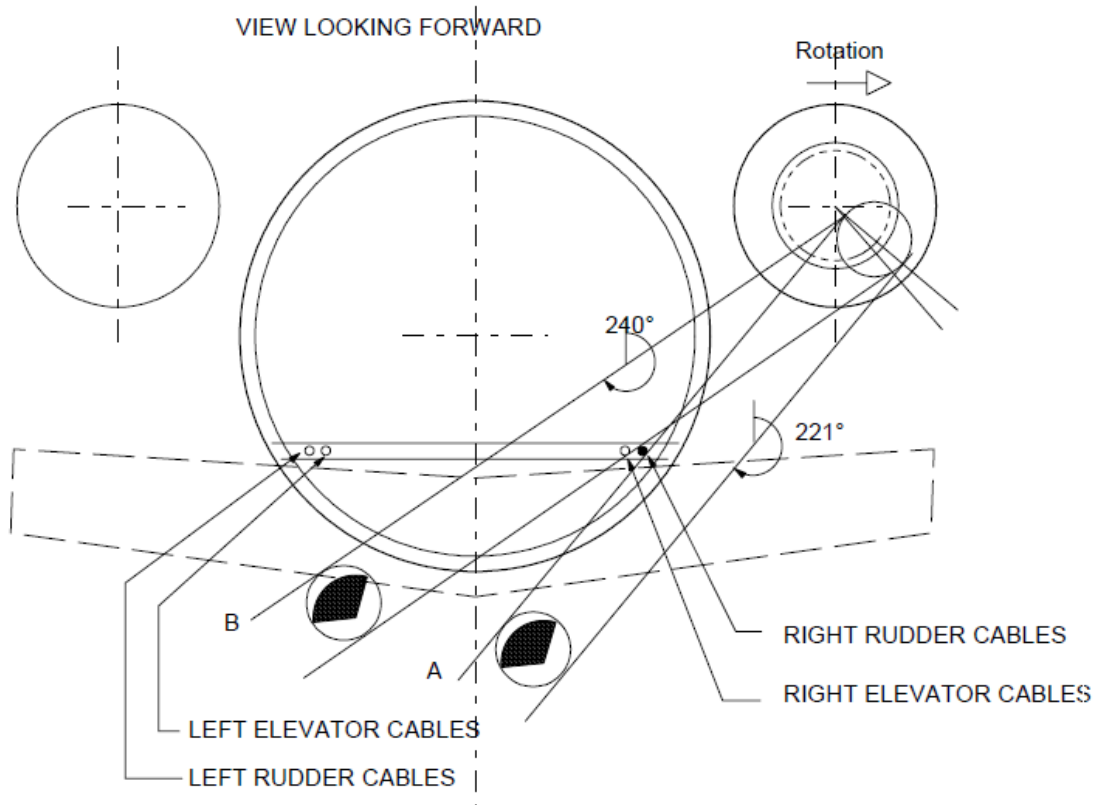

**EXAMPLE:**  
 The right rudder cables are cut by a 1/3 fan fragment from the right engine at all trajectory angles between 221° and 240°. Trajectory range A - B is therefore 19°

**TRAJECTORY RANGE PLOTTING**

**FIGURE 5**

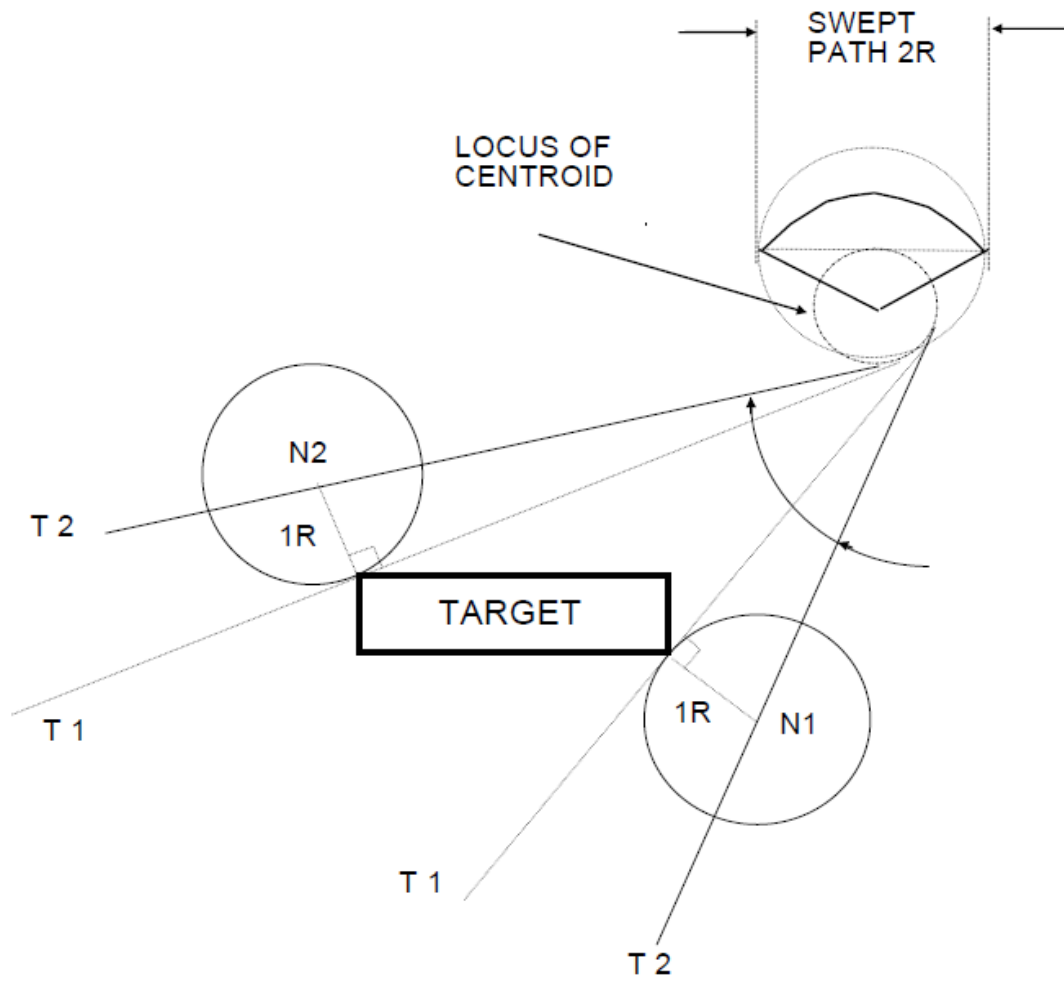

**TYPICAL TRAJECTORY PLOTTING**

**FIGURE 6**

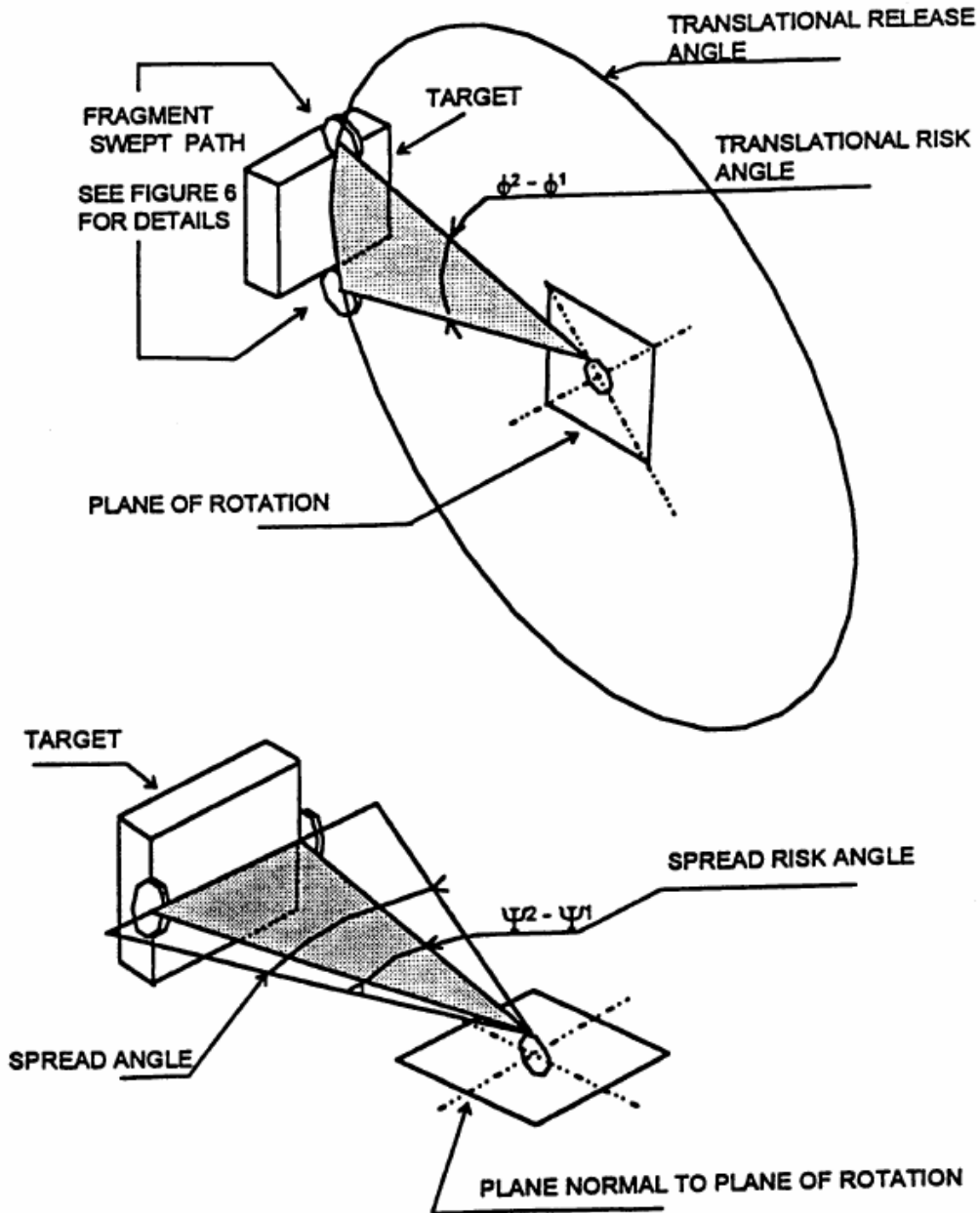

**DEFINITION - THREAT WINDOW**

**FIGURE 7**



**ENGINE ROTOR FAILURE – SYSTEM EFFECTS**

**H.P. TURBINE 1**

ENGINE: **RIGHT**  
 COMPONENT: **In.**  
 SIZE: **In.**

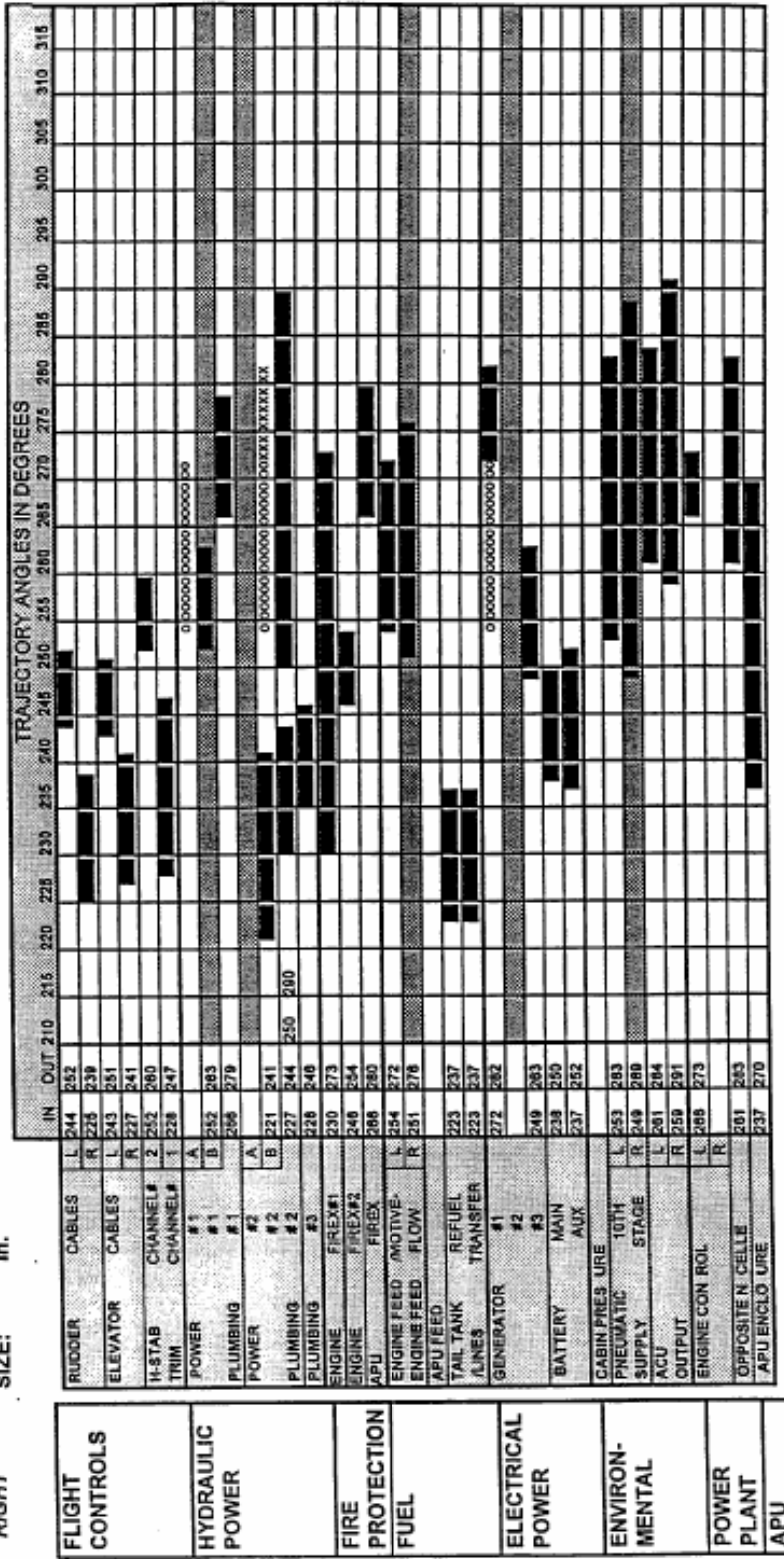

**FIGURE 8 - SAMPLE ROTOR STAGE PLOTTING CHART**