



**COMMENT RESPONSE DOCUMENT (CRD)
TO NOTICE OF PROPOSED AMENDMENT (NPA) 2009-02B**

**for an Agency Opinion on a Commission Regulation establishing the Implementing
Rules for air operations of Community operators**

and

**draft Decision of the Executive Director of the European Aviation Safety Agency on
Acceptable Means of Compliance and Guidance Material related to the Implementing
Rules for air operations of Community operators**

"Part-OPS"

CRD c.9 – Revised rule text with track changes to EU-OPS/JAR OPS 3

Scope

This document shows track changes to

- Subpart B, D to L of EU-OPS and JAR-OPS3;
- Related Section 2 material of JAR-OPS1 and JAR-OPS3.

This document contains the revised rule text for

- Annex I – Definitions;
- Part-CAT (A, H);
- Text moved to Part-OR;
- Text moved to Part-SPA.

The following table provides a general overview on how the Subparts of EU-OPS/JAR-OPS3 relate to the new Subparts.

Table 1: General comparison of Part-CAT with EU-OPS/JAR-OPS3

Part-CAT	EU-OPS	JAR-OPS3
CAT.GEN.AH	Subpart B (partly)	
CAT.OP.AH	Subpart D Subpart E (partly)	
CAT.POL.A	Subpart F-I	
CAT.POL.H		Subpart F-I
CAT.POL.MAB	Subpart J	
CAT.IDE.A	Subpart K-L	
CAT.IDE.H		Subpart K-L

Table of contents

- Document 1: Subpart B (EU-OPS and JAR-OPS 3)
- Document 2: Subpart D (EU-OPS and JAR-OPS 3)
- Document 3: Subpart E (EU-OPS and JAR-OPS 3)
- Document 4: Subparts F-I of EU-OPS
- Document 5: Subparts F-I of JAR-OPS 3
- Document 6: Subpart J (EU-OPS and JAR-OPS 3)
- Document 7: Subparts K-L of EU-OPS
- Document 8: Subparts K-L of JAR-OPS 3

Subpart B | Revised rule text

Scope

This document shows changes to

- Subpart B of EU-OPS and JAR-OPS3;
- Related Section 2 material of JAR-OPS1 and JAR-OPS3.

This document contains the revised rule text for

- CAT.GEN.AH.

*Subpart B | Revised rule text***Table of content**

Part-OR	5
OR.OPS IR.....	5
OR.OPS.GEN.105(f) Operator responsibilities	5
Part-CAT IR.....	6
Subpart A – General requirements.....	6
Section 1 – Aeroplanes and helicopters	6
CAT.GEN.AH.120 Common Language	6
CAT.GEN.AH.115 Personnel or crew members other than cabin crew in the passenger compartment.....	7
CAT.GEN.AH.145 Information on emergency and survival equipment carried.....	7
[CAT.GEN AMC/GM]	8
AMC1-CAT.GEN.AH.145 Information on emergency and survival equipment carried.....	8
ITEMS FOR COMMUNICATION TO RCC	8
[CAT.GEN IR]	8
CAT.GEN.AH.150 Ditching - aeroplanes	8
CAT.GEN.AH.155 Carriage of weapons of war and munitions of war	8
CAT.GEN.AH.160 Carriage of sporting weapons and ammunition.....	8
CAT.GEN.AH.161 Carriage of sporting weapons and ammunition - alleviations.....	9
CAT.GEN.AH.165 Method of carriage of persons.....	9
CAT.GEN.AH.100 Crew responsibilities.....	9
[CAT.GEN AMC/GM]	10
AMC1-CAT.GEN.AH.100(c) Crew responsibilities	10
ALCOHOL CONSUMPTION.....	10
[CAT.GEN IR]	11
CAT.GEN.AH.105 Responsibilities of the commander	11
CAT.GEN.AH.110 Authority of the commander	13
CAT.GEN.AH.125 Authority to taxi an aeroplane	13
CAT.GEN.AH.130 Rotor engagement - helicopters	13
CAT.GEN.AH.135 Admission to flight crew compartment	13
CAT.GEN.AH.140 Portable electronic devices	14
CAT.GEN.AH.170 Alcohol and drugs	14

Subpart B | Revised rule text

CAT.GEN.AH.175 Endangering safety	14
CAT.GEN.AH.180 Documents, manuals and information to be carried ..	16
CAT.GEN.AH.185 Information to be retained on the ground.....	17
CAT.GEN.AH.190 Power to inspect	17
CAT.GEN.AH.195 Preservation, production and use of flight recorder recordings - aeroplanes	18
[CAT.GEN AMC/GM]	34
AMC1-CAT.GEN.AH.180(a) Documents, manuals and information to be carried	34
LOSS OR THEFT OF DOCUMENTS	34
[CAT.GEN IR]	34
CAT.GEN.AH.200 Transport of dangerous goods	34
Part-CAT AMC-GM	36
Subpart A – General requirements.....	36
Section 1 – Aeroplanes and helicopters	36
AMC1-CAT.GEN.AH.100(b) Crew responsibilities	36
COPIES OF REPORTS	36
GM1-CAT.GEN.AH.100(c) Crew responsibilities	36
ELAPSED TIME BEFORE RETURNING TO FLYING DUTY	36
AMC1-CAT.GEN.AH.115 Personnel or crew members other than cabin crew in the passenger compartment.....	36
MEASURES TO PREVENT	36
AMC1-CAT.GEN.AH.130 Rotor engagement - helicopters.....	36
ROTOR ENGAGEMENT.....	36
AMC1-CAT.GEN.AH.135(a)(3) Admission to flight crew compartment ..	37
INSTRUCTIONS FOR SINGLE-PILOT VFR DAY OPERATIONS	37
GM1-CAT.GEN.AH.155 Carriage of weapons of war and munitions of war	37
WEAPONS OF WAR AND MUNITIONS OF WAR.....	37
GM1-CAT.GEN.AH.160 Carriage of sporting weapons and ammunition .	37
SPORTING WEAPONS	37
AMC1-CAT.GEN.AH.161 Carriage of sporting weapons and ammunition - alleviations.....	38
SPORTING WEAPONS	38
AMC1-CAT.GEN.AH.180 Documents, manuals and information to be carried.....	38
GENERAL	38

Subpart B | Revised rule text

AMC1-CAT.GEN.AH.180(a)(1) Documents, manuals and information to be carried	38
AIRCRAFT FLIGHT MANUAL OR EQUIVALENT DOCUMENT(S).....	38
GM1-CAT.GEN.AH.180(a)(5) Documents, manuals and information to be carried.....	38
THE AIR OPERATOR CERTIFICATE	38
AMC1-CAT.GEN.AH.180(a)(9) Documents, manuals and information to be carried	39
JOURNEY LOG OR EQUIVALENT	39
AMC1-CAT.GEN.AH.180(a)(13) Documents, manuals and information to be carried	39
PROCEDURES AND VISUAL SIGNALS FOR USE BY INTERCEPTING AND INTERCEPTED AIRCRAFT.....	39
GM1-CAT.GEN.AH.180(a)(14) Documents, manuals and information to be carried	39
SEARCH AND RESCUE INFORMATION	39
GM1-CAT.GEN.AH.180(a)(23) Documents, manuals and information to be carried	39
DOCUMENTS WHICH MAY BE PERTINENT TO THE FLIGHT	39
STATES CONCERNED WITH THE FLIGHT	39
AMC1-CAT.GEN.AH.195 Preservation, production and use of flight recorder recordings - aeroplanes	39
OPERATIONAL CHECKS.....	39
GM1-CAT.GEN.AH.195 Preservation of recordings, production and use of flight recorder recordings - aeroplanes	40
PROCEDURES FOR THE INSPECTIONS AND MAINTENANCE PRACTICES	40
REMOVAL OF RECORDERS.....	40
AMC1-CAT.GEN.AH.200(e) Transport of dangerous goods	40
DANGEROUS GOODS ACCIDENT AND INCIDENT REPORTING	40
GM1-CAT.GEN.AH.200 Transport of dangerous goods.....	44
GENERAL	44

Subpart B | Revised rule text

Part-OR

OR.OPS | IR

~~SUBPART GENERAL~~

~~OPS 1.005 General~~

~~(a) An operator shall not operate an aeroplane for the purpose of commercial air transportation other than in accordance with OPS Part 1. For operations of Performance Class B aeroplanes, alleviated requirements can be found in Appendix 1 to OPS 1.005(a).~~

Comment [WSI1]:
Covered in the CR OPS, Article 3.

Comment [WSI2]:
The alleviation are/will be included in the applicable paragraphs.

~~(b) An operator shall comply with the applicable retroactive airworthiness requirements for aeroplanes operated for the purpose of commercial air transportation.~~

Comment [WSI3]:
Addressed in Part-OR.

~~(c) Each aeroplane shall be operated in compliance with the terms of its Certificate of Airworthiness and within the approved limitations contained in its Aeroplane Flight Manual.~~

Comment [WSI4]:
Addressed by ER chapter 6 and Part-M.

~~(d) All Synthetic Training Devices (STD), such as Flight Simulators or Flight Training Devices (FTD), replacing an aeroplane for training and/or checking purposes are to be qualified in accordance with the requirements applicable to Synthetic Training Devices. An operator intending to use such STD must obtain approval from the Authority.~~

Comment [WSI5]:
This is addressed through OR.ATO. A requirement is also added in OR.OPS.FC.

~~OR.OPS.GEN.105(f) OPS 1.020 Laws, Regulations and Procedures Operator's responsibilities~~

...

(f) The operator shall ensure that all personnel are made aware that they shall comply with the laws, regulations and procedures of those States in which operations are conducted and which are pertinent to the performance of their duties.

An operator must ensure that:

1. All employees are made aware that they shall comply with the laws, regulations and procedures of those States in which operations are conducted and which are pertinent to the performance of their duties; and
2. All crew members are familiar with the laws, regulations and procedures pertinent to the performance of their duties.

Subpart B | Revised rule text

Part-CAT | IR

Subpart A – General requirements

Section 1 – Aeroplanes and helicopters

~~CAT.GEN.AH.120~~ **OPS 1.025 Common Language**

An ~~The~~ operator ~~must~~ **shall** ensure that all crew members can communicate in a common language. ~~(b) — An operator must ensure that all operations personnel are able to understand the language in which those parts of the Operations Manual which pertain to their duties and responsibilities are written.~~

Comment [WSI6]:
OR.OPS.MLR.100 (k).

~~OPS 1.030~~ **Minimum Equipment Lists — Operator's Responsibilities**

(a) — An operator shall establish, for each aeroplane, a Minimum Equipment List (MEL) approved by the Authority. This shall be based upon, but no less restrictive than, the relevant Master Minimum Equipment List (MMEL) (if this exists) accepted by the Authority.

(b) — An operator shall not operate an aeroplane other than in accordance with the MEL unless permitted by the Authority. Any such permission will in no circumstances permit operation outside the constraints of the MMEL.

Comment [WSI7]:
OR.OPS.MLR

~~OPS 1.035~~ **Quality**

(a) — An operator shall establish one Quality System and designate one Quality Manager to monitor compliance with, and adequacy of, procedures required to ensure safe operational practices and airworthy aeroplanes. Compliance monitoring must include a feed-back system to the Accountable Manager (see also OPS 1.175 (h)) to ensure corrective action as necessary.

(b) — The Quality System must include a Quality Assurance Programme that contains procedures designed to verify that all operations are being conducted in accordance with all applicable requirements, standards and procedures.

(c) — The Quality System and the Quality Manager must be acceptable to the Authority.

(d) — The Quality System must be described in relevant documentation.

(e) — Notwithstanding subparagraph (a) above, the Authority may accept the nomination of two Quality Managers, one for operations and one for maintenance provided that the operator has designated one Quality Management Unit to ensure that the Quality System is applied uniformly throughout the entire operation.

Comment [WSI8]:
OR.GEN.200

~~OPS 1.037~~ **Accident prevention and flight safety**

(a) — An operator shall establish and maintain an accident prevention and flight safety programme, which may be integrated with the Quality System, including:

Comment [WSI9]:
Covered in OR.GEN .200.

Subpart B | Revised rule text

- ~~(1.) Programmes to achieve and maintain risk awareness by all persons involved in operations; and~~
- ~~(2.) An occurrence reporting scheme to enable the collation and assessment of relevant incident and accident reports in order to identify adverse trends or to address deficiencies in the interests of flight safety. The scheme shall protect the identity of the reporter and include the possibility that reports may be submitted anonymously; and~~
- ~~(3.) Evaluation of relevant information relating to accidents and incidents and the promulgation of related information, but not the attribution of blame; and~~
- ~~(4.) A flight data monitoring programme for those aeroplanes in excess of 27 000 kg MCTOM. Flight Data Monitoring (FDM) is the pro active use of digital flight data from routine operations to improve aviation safety. The flight data monitoring programme shall be non punitive and contain adequate safeguards to protect the source(s) of the data; and~~
- ~~(5.) The appointment of a person accountable for managing the programme.~~
- ~~(b) Proposals for corrective action resulting from the accident prevention and flight safety programme shall be the responsibility of the person accountable for managing the programme.~~
- ~~(c) The effectiveness of changes resulting from proposals for corrective action identified by the accident and flight safety programme shall be monitored by the Quality Manager.~~

CAT.GEN.AH.115~~OPS 1.040~~ Personnel or cGrew members other than cabin crew in the passenger compartment

- ~~(a) An operator shall ensure that all operating flight and cabin crew members have been trained in, and are proficient to perform, their assigned duties.~~
- ~~(b) Where there are **The operator shall ensure that personnel or** crew members, other than cabin crew members, ~~who~~ **carrying** out their duties in the passenger compartment of an aeroplane ~~aircraft~~, an operator shall ensure that these:~~
- ~~(a1) are not confused by the passengers with the cabin crew members;~~
- ~~(b2) do not occupy required cabin crew assigned stations; and~~
- ~~(c3) do not impede the cabin crew members in their duties. ~~OPS 1.050 Search and rescue information~~~~

Comment [WSI10]:
Deleted because already addressed in OR.OPS.AOC.125 (b).

Comment [WSI11]:
CAT.GEN.180(14)

~~An operator shall ensure that essential information pertinent to the intended flight concerning search and rescue services is easily accessible on the flight crew compartment deck.~~

CAT.GEN.AH.145~~OPS 1.055~~ Information on emergency and survival equipment carried

~~An **The operator shall at all times have** ensure that there are available for immediate communication to rescue coordination centres (**RCCs**), lists containing information on the emergency and survival equipment carried on board ~~of any~~ **of their aircraft**. ~~his aeroplanes.~~~~

*Subpart B | Revised rule text***[CAT.GEN | AMC/GM]****AMC1-CAT.GEN.AH.145 Information on emergency and survival equipment carried****ITEMS FOR COMMUNICATION TO RCC**

The information ~~shall~~ **should** include, as applicable, the number, colour and type of life-rafts and pyrotechnics;; details of emergency medical supplies;; water supplies; and the type and frequencies of emergency portable radio equipment.

[CAT.GEN | IR]**CAT.GEN.AH.150~~OPS 1.060~~ Ditching - aeroplanes**

~~An~~ **The** operator shall not operate an aeroplane with a passenger seating configuration of more than 30 ~~passengers~~ on overwater flights at a distance from land suitable for making an emergency landing, greater than 120 minutes at cruising speed, or 400 nautical miles, whichever is ~~the lesser~~, unless the aeroplane complies with the ditching requirements prescribed in the applicable airworthiness code.

CAT.GEN.AH.155~~OPS 1.065~~ Carriage of weapons of war and munitions of war

- (a) ~~An~~ **The** operator shall not transport weapons of war **or** ~~and~~ munitions of war by air unless an approval to do so has been granted by all States ~~concerned~~ **whose airspace is intended to be used for the flight and any likely diversion.**
- (b) **If an approval has been granted, the** ~~An~~ operator shall ensure that weapons of war and munitions of war are:
- (1) ~~s~~ **Stowed in the aeroplane—aircraft** in a place which is inaccessible to passengers during flight; and
 - (2) ~~i~~ **n the case of firearms, unloaded, unless, before the commencement of the flight, approval has been granted by all States concerned that such weapons of war and munitions of war may be carried in circumstances that differ in part or in total from those indicated in this subparagraph.**
- (c) ~~An~~ **The** operator shall ensure that, **before a flight begins**, the commander is notified ~~before a flight begins~~ of the details and location on board the ~~aeroplane~~ **aircraft** of any weapons of war and munitions of war intended to be carried.

CAT.GEN.AH.160~~OPS 1.070~~ Carriage of sporting weapons and ammunition

- (a) ~~An~~ **The** operator shall take all reasonable measures to ensure that any sporting weapons intended to be carried by air are reported to him~~r~~.
- (b) ~~An~~ **The** operator accepting the carriage of sporting weapons shall ensure that they are:

Subpart B | Revised rule text

(1) ~~Stowed in the aeroplane~~ **aircraft** in a place which is inaccessible to passengers during flight ~~unless the Authority has determined that compliance is impracticable and has accepted that other procedures might apply~~; and

(2) ~~in~~ the case of firearms or other weapons that can contain ~~ammunition~~, unloaded.

(c) Ammunition for sporting weapons may be carried in passengers' checked baggage, subject to certain limitations, in accordance with the Technical Instructions. ~~(see OPS 1.1160 (b)(5)) as defined in OPS 1.1150 (a)(15).~~

Comment [WSI12]:
Text deleted because this requires an Article 14 procedure.

CAT.GEN.AH.161 Carriage of sporting weapons and ammunition - alleviations

Notwithstanding CAT.GEN.AH.160(b), for helicopters with a maximum certificated take-off mass (MCTOM) of 3 175 kg or less operated by day and over routes navigated by reference to visual landmarks, a sporting weapon may be carried in a place which is accessible during flight, provided it is impracticable to stow it in an inaccessible stowage during flight, and the operator has established appropriate procedures.

CAT.GEN.AH.165 ~~OPS 1.075~~ Method of carriage of persons

~~The~~ operator shall take all measures to ensure that no person is in any part of an ~~aeroplane~~ **aircraft** in flight which is not a ~~part~~ designed for the accommodation of persons unless temporary access has been granted by the commander: ~~to any part of the aeroplane.~~

(a) ~~For~~ the purpose of taking action necessary for the safety of the ~~aeroplane~~ **aircraft** or of any person, animal or goods therein; or

(b) ~~for a part of the aircraft~~ ~~in~~ which cargo or ~~stores~~ **supplies** are carried, being a part which is designed to enable a person to have access thereto while the ~~aeroplane~~ **aircraft** is in flight.

~~OPS 1.080 Intentionally blank~~

CAT.GEN.AH.100 ~~OPS 1.085~~ Crew responsibilities

(a) ~~A~~ **Crew members** shall be responsible for the proper execution of their duties that **are**:

(1) ~~are~~ related to the safety of the ~~aeroplane~~ **aircraft** and its occupants; and

(2) ~~are~~ specified in the instructions and procedures ~~laid down~~ in the ~~Operations Manual~~ **operations manual**.

(b) ~~A~~ **Crew members** shall:

(1) report to the commander any fault, failure, malfunction or defect which ~~he/she~~ **they** believes may affect the airworthiness or safe operation of the ~~aeroplane~~ **aircraft** including emergency systems;

(2) report to the commander any incident that endangered, or could have endangered, the safety of **the** operation;

Subpart B | Revised rule text

~~(3) Make use of the operator's occurrence reporting schemes in accordance with OPS 1.037(a)(2). In all such cases, a copy of the report(s) shall be communicated to the commander concerned.~~ **comply with the relevant requirements of the operator's occurrence reporting schemes;**

(4) comply with all flight and duty time limitations and rest requirements applicable to their activities; and

(5) when undertaking duties for more than one operator:

(i) maintain their individual records regarding flight and duty times and -rest periods as referred to in OR.OPS.FTL;

(ii) provide each operator with the data that they need to schedule activities in accordance with the applicable FTL requirements.

Comment [WSI13]:
Added in line with discussions in the Air Safety Committee to particular address crew members who work for more than one operator.

~~(c) Nothing in paragraph (b) above shall oblige a crew member to report an occurrence which has already been reported by another crew member.~~

Comment [WSI14]:
Deleted because obvious.

~~(d) A-Crew members shall not perform duties on an aircraft:~~ **aeroplane:**

~~(1) when under the influence of psychoactive substances or alcohol or for other reasons referred to in 7.g. of Annex IV of Regulation (EC) No 216/2008;~~ **while under the influence of any drug that may affect his/her faculties in a manner contrary to safety;**

~~2.-(2) until a reasonable time period has elapsed after following deep seawater diving or following blood donation—except when a reasonable time period has elapsed;~~

Comment [WSI15]:
Text aligned with JAR-OPS 3.

~~3.-(3) following blood donation except when a reasonable time period has elapsed;~~

~~4.-(3) if applicable medical requirements are not fulfilled;~~ **or**

(4) if they are he/she is in any doubt of being able to accomplish his/her their assigned duties; or

~~5.-(5) if he/she they knows or suspects that they he/she is—are suffering from fatigue taking into account the requirement in 7.f. of Annex IV of Regulation (EC) No 216/2008;~~ **or feels otherwise unfit, to the extent that the flight may be endangered.**

[CAT.GEN | AMC/GM]

AMC1-CAT.GEN.AH.100(c) Crew responsibilities

ALCOHOL CONSUMPTION

~~(c) A crew member shall be subject to appropriate requirements on the consumption of alcohol which shall be established by the operator and acceptable by the Authority, and which shall not be less restrictive than the following.~~ **The operator should instructions concerning the consumption of alcohol by crew members. The requirements should be no less restrictive than the following:**

Comment [WSI16]:
Redrafted for providing more clarity.

Subpart B | Revised rule text

1. no alcohol ~~should~~**shall** be consumed less than 8 hours prior to the specified reporting time for flight duty or the commencement of standby;
2. the blood alcohol level ~~should~~**shall** not exceed **the lower of the national requirements or 0,72** promille at the start of a flight duty period;
3. no alcohol ~~should~~**shall** be consumed during the flight duty period or whilst on standby.

[CAT.GEN | IR]

CAT.GEN.AH.105 Responsibilities of the commander

(fa) The commander, **in addition to complying with CAT.GEN.AH.100**, shall:

- (1)- be responsible for the safety of all crew members, passengers and cargo on board, as soon as **the commander** ~~he/she~~ arrives on board ~~of the aircraft~~, until ~~he/she~~ **the commander** leaves the ~~aircraft~~ ~~aeroplane~~ at the end of the flight;
- (2)- be responsible for the operation and safety of the ~~aeroplane~~ **aircraft**:
 - (i) **for aeroplanes**, from the moment the aeroplane is first ready to move for the purpose of taxiing prior to take-off, until the moment it finally comes to rest at the end of the flight and the engine(s) used as primary propulsion units are shut down;
 - (ii) **for helicopters, when the rotors are turning**;
- (3)- have authority to give all commands ~~he/she deems necessary~~ **and take any appropriate actions** for the purpose of securing ~~the~~ **the** safety of the ~~aeroplane~~ **aircraft** and of persons **and/or** property carried therein **in accordance with 7.c. of Annex IV of Regulation (EC) No 216/2008**;
- ÷
- (4)- have authority to disembark any person, or any part of the cargo, which, ~~in his/her opinion~~, may represent a potential hazard to the safety of the ~~aircraft~~ ~~aeroplane~~ or its occupants;
- (5)- not allow a person to be carried in the ~~aircraft~~ ~~aeroplane~~ who appears to be under the influence of alcohol or drugs to the extent that the safety of the ~~aeroplane~~ **aircraft** or its occupants is likely to be endangered;
- (6)- have the right to refuse transportation of inadmissible passengers, deportees or persons in custody if their carriage **increases** ~~poses any~~ **the** risk to the safety of the ~~aeroplane~~ **aircraft** or its occupants;
- (7)- ensure that all passengers are briefed on the location of emergency exits and the location and use of relevant safety and emergency equipment;
- (8)- ensure that all operational procedures and check-lists are complied with in accordance with the ~~Operations Manual~~ **operations manual**;

Subpart B | Revised rule text

- (9) ~~not permit any crew member to perform any activity during **critical phases of flight**, take-off, initial climb, final approach and landing except those duties required for the safe operation of the **aircraft**;~~ ~~aeroplane;~~
- (10) ~~not permit~~ **ensured that means installed on board for recording data of flight recorders:**
- (i) **are not disabled or switched off during flight; and**
 - (ii) **in the event of an accident or an incident:**
 - (A) **are not intentionally erased;**
 - (B) **are deactivated immediately after the flight is completed;**
 - (C) **are reactivated only with the agreement of the investigating authority;**
- ~~(i) a flight data recorder to be disabled, switched off or erased during flight nor permit recorded data to be erased after flight in the event of an accident or an incident subject to mandatory reporting;~~
- ~~(ii) a cockpit voice recorder to be disabled or switched off during flight unless he/she believes that the recorded data, which otherwise would be erased automatically, should be preserved for incident or accident investigation nor permit recorded data to be manually erased during or after flight in the event of an accident or an incident subject to mandatory reporting;~~
- (11) ~~decide **on acceptance of the aircraft** whether or not to accept an aeroplane with unserviceabilities **in accordance with**~~ ~~the **configuration deviation list (CDL) or the minimum equipment list (MEL)**~~; and
- (12) ~~ensure that the pre-flight inspection has been carried out **in accordance with the requirements of Part-M;**~~
- (13) be satisfied that relevant emergency equipment remains easily accessible for immediate use.**
- (g**b**) The commander, or the pilot to whom conduct of the flight has been delegated, shall, in an emergency situation that requires immediate decision and action, take any action he/she considers necessary under the circumstances **in accordance with 7.d. of annex IV of Regulation (EC) No 216/2008**. In such cases he/she may deviate from rules, operational procedures and methods in the interest of safety.
- (c) Whenever an aircraft in flight has manoeuvred in response to an airborne collision avoidance system (ACAS) resolution advisory (RA), the commander shall notify the air traffic service (ATS) unit concerned and submit an ACAS report to the competent authority.**
- (d) Bird hazards and strikes**

Comment [WSI17]:
OPS 1.330

Comment [WSI18]:
1.420 (d)(2).

Comment [WSI19]:
1.420 (d)(3).

Subpart B | Revised rule text

- (1) **Whenever a potential bird hazard is observed, the commander shall immediately inform the ATS unit whenever a potential bird hazard is observed.**
- (2) **Whenever an aircraft for which the commander is responsible suffers a bird strike that results in significant damage to the aircraft or the loss or malfunction of any essential service, the commander shall submit a written bird strike report after landing to the competent authority.**

CAT.GEN.AH.110~~OPS 1.090~~ Authority of the commander

An operator shall take all reasonable measures to ensure that all persons carried in the ~~aeroplane~~ **aircraft** obey all lawful commands given by the commander for the purpose of securing the safety of the ~~aeroplane~~ **aircraft** and of persons or property carried therein.

CAT.GEN.AH.125~~OPS 1.095~~ Authority to taxi an aeroplane

An **aeroplane** operator shall take all reasonable steps to ensure that an aeroplane in his charge is not **be** taxied on the movement area of an aerodrome by a person other than a flight crew member, unless ~~that person, seated at the controls:~~ **that person, seated at the controls:**

- (1) ~~has been duly authorised by the operator or a designated agent;~~
- (2) **is trained to taxi the aircraft;**
 - (i) ~~taxi the aeroplane;~~
- (3) **is trained to use the radio-telephone;**
- (4) ~~and~~
- (2) ~~has received instruction in respect of aerodrome layout, routes, signs, marking, lights, air traffic control (ATC) signals and instructions, phraseology and procedures;~~ and
- (5) is able to conform to the operational standards required for safe aeroplane movement at the aerodrome.

CAT.GEN.AH.130~~OPS 3.210(d)~~ Rotor engagement - helicopters

An operator shall not permit a helicopter rotor **shall only** ~~to be~~ turned under power for the purpose of flight with a qualified pilot at the controls.

CAT.GEN.AH.135~~OPS 1.100~~ Admission to flight crew compartmentdeck

- (a) ~~An~~ **The** operator ~~must~~ **shall** ensure that no person, other than a flight crew member assigned to a flight, is admitted to, or carried in, the flight ~~deck~~ **crew compartment** unless that person is:
 - (1) ~~an operating crew member;~~
 - (2) ~~a representative of the competent or inspecting authority, if Authority responsible for certification, licensing or inspection if this is required to be there for the performance of his/her official duties; or~~

Subpart B | Revised rule text

- (3) ~~permitted by,~~ and carried in accordance with instructions contained in the ~~Operations m~~Manual.
- (b) The commander shall ensure that:
- (1) ~~In the interests of safety,~~ admission to the flight deck ~~crew compartment~~ does not cause distraction ~~and/or interference~~ with the flight's operation ~~of the flight~~; and
- (2) ~~a~~All persons carried ~~on~~in the flight ~~crew compartment~~deck are made familiar with the relevant safety procedures.
- (c) **The commander shall make t**The final decision regarding the admission to the flight ~~crew compartment~~deck shall be the responsibility of the commander.

~~OPS 1.105 Unauthorised carriage~~

Comment [WSI20]:
Covered in OR.OPS.SEC.

~~An operator shall take all reasonable measures to ensure that no person secretes himself/herself or secretes cargo on board an aeroplane.~~

CAT.GEN.AH.140~~OPS 1.110~~ Portable electronic devices

~~An~~**The** operator shall not permit any person to use, ~~and take all reasonable measures to ensure that no person does use,~~ on board an aeroplane a portable electronic device **on board an aircraft** that **could** ~~can~~ adversely affect the performance of the aeroplane's **aircraft's** systems and equipment, **and shall take all reasonable measures to prevent such use.**

CAT.GEN.AH.170~~OPS 1.115~~ Alcohol and drugs

~~An~~**The** operator shall ~~not permit any person to enter or be in,~~ and take all reasonable measures to ensure that no person enters or is in, an aeroplane **aircraft** when under the influence of alcohol or drugs to the extent that the safety of the aeroplane **aircraft** or its occupants is likely to be endangered.

CAT.GEN.AH.175~~OPS 1.120~~ Endangering safety

~~An~~**The** operator shall take all reasonable measures to ensure that no person recklessly or negligently acts or omits to act **so as to**:

- (a) ~~so as to~~ endanger an aeroplane **aircraft** or person therein;
- (b) ~~so as to~~ cause or permit an aeroplane **aircraft** to endanger any person or property. ~~OPS 1.125 Documents to be carried~~(a) ~~An operator shall ensure that the following documents or copies thereof are carried on each flight:~~
1. ~~The Certificate of Registration;~~
 2. ~~The Certificate of Airworthiness;~~
 3. ~~The original or a copy of the Noise Certificate (if applicable), including an English translation, where one has been provided by the Authority responsible for issuing the noise certificate;~~
 4. ~~The original or a copy of the Air Operator Certificate;~~

Comment [WSI21]:
Be replaced by CAT.GEN.AH.180.

Subpart B | Revised rule text

~~5. — The Aircraft Radio Licence; and~~

~~6. — The original or a copy of the Third party liability Insurance Certificate(s).~~

~~(b) — Each flight crew member shall, on each flight, carry a valid flight crew licence with appropriate rating(s) for the purpose of the flight.~~

~~OPS 1.130 Manuals to be carried~~

~~An operator shall ensure that:~~

~~1. — The current parts of the Operations Manual relevant to the duties of the crew are carried on each flight;~~

~~2. — Those parts of the Operations Manual which are required for the conduct of a flight are easily accessible to the crew on board the aeroplane; and~~

~~3. — The current Aeroplane Flight Manual is carried in the aeroplane unless the Authority has accepted that the Operations Manual prescribed in OPS 1.1045, Appendix 1, Part B contains relevant information for that aeroplane.~~

~~OPS 1.135 Additional information and forms to be carried~~

~~(a) — An operator shall ensure that, in addition to the documents and manuals prescribed in OPS 1.125 and OPS 1.130, the following information and forms, relevant to the type and area of operation, are carried on each flight:~~

~~1. — Operational Flight Plan containing at least the information required in OPS 1.1060;~~

~~2. — Aeroplane Technical Log containing at least the information required in Part M, paragraph M. A. 306 Operator's technical log system;~~

~~3. — Details of the filed ATS flight plan;~~

~~4. — Appropriate NOTAM/AIS briefing documentation;~~

~~5. — Appropriate meteorological information;~~

~~6. — Mass and balance documentation as specified in Subpart J;~~

~~7. — Notification of special categories of passenger such as security personnel, if not considered as crew, handicapped persons, inadmissible passengers, deportees and persons in custody;~~

~~8. — Notification of special loads including dangerous goods including written information to the commander as prescribed in OPS 1.1215 (c);~~

~~9. — Current maps and charts and associated documents as prescribed in OPS 1.290 (b)(7);~~

~~10. — Any other documentation which may be required by the States concerned with this flight, such as cargo manifest, passenger manifest etc; and~~

~~11. — Forms to comply with the reporting requirements of the Authority and the operator.~~

~~(b) — The Authority may permit the information detailed in subparagraph (a) above, or parts thereof, to be presented in a form other than on printed paper. An acceptable standard of accessibility, usability and reliability must be assured.~~

Comment [WSI22]:
Be replaced by CAT.GEN.AH.180.

Comment [WSI23]:
Be replaced by CAT.GEN.AH.180.

*Subpart B | Revised rule text***CAT.GEN.AH.180 Documents, manuals and information to be carried**

Comment [WSI24]:
Replaces OPS 1.050, 1.125, 1.130,
1.135

- (a) The following documents, manuals and information shall be carried on each flight, as originals or copies unless otherwise specified:
- (1) the aircraft flight manual, or equivalent document(s);
 - (2) the original certificate of registration;
 - (3) the original certificate of airworthiness;
 - (4) the noise certificate, if applicable, including an English translation, where one has been provided by the authority responsible for issuing the noise certificate;
 - (5) a certified true copy of the air operator certificate;
 - (6) the operations specifications relevant to the aircraft type, issued with the air operator certificate;
 - (7) the original aircraft radio licence, if applicable;
 - (8) the third party liability insurance certificate(s);
 - (9) the journey log, or equivalent, for the aircraft;
 - (10) the aircraft technical log, in accordance with Part-M;
 - (11) details of the filed ATS flight plan, if applicable;
 - (12) current and suitable aeronautical charts for the route of the proposed flight and all routes along which it is reasonable to expect that the flight may be diverted;
 - (13) procedures and visual signals information for use by intercepting and intercepted aircraft;
 - (14) information concerning search and rescue services for the area of the intended flight, which shall be easily accessible in the flight crew compartment;
 - (15) the current parts of the operations manual which are relevant to the duties of the crew and be easily accessible to the crew;
 - (16) the MEL;
 - (17) appropriate notices to airmen (NOTAM) and aeronautical information service (AIS) briefing documentation;
 - (18) appropriate meteorological information;
 - (19) cargo and/or passenger manifests, if applicable;
 - (20) mass and balance documentation;
 - (21) the operational flight plan, if applicable;
 - (22) notification of special categories of passenger and special loads, if applicable; and
 - (23) any other documentation which may be pertinent to the flight or is required by the States concerned with the flight.

Subpart B | Revised rule text

- (b) **Notwithstanding (a) above, for VFR day operations with other-than-complex motor-powered aircraft taking off and landing at the same aerodrome/operating site within 24 hours, or remaining within a local area specified in the operations manual, the following documents and information may be retained at the aerodrome/operating site, for other flights:**
- (1) **noise certificate;**
 - (2) **aircraft radio licence;**
 - (3) **journey log, or equivalent;**
 - (4) **aircraft technical log;**
 - (5) **NOTAM/AIS briefing documentation;**
 - (6) **meteorological information;**
 - (7) **notification of special categories of passenger;**
 - (8) **mass and balance documentation.**
- (c) **Notwithstanding (a) above, in case of loss or theft of documents specified in (a)(2) to (a)(4), (a)(7) or (a)(8), the operation may continue until the flight reaches its destination or a place where replacement documents can be provided.**

CAT.GEN.AH.185~~OPS 1.140~~ Information to be retained on the ground

- (a) The operator shall ensure that: ~~a~~At least for the duration of each flight or series of flights: ~~r~~
- (1) ~~i~~Information relevant to the flight and appropriate for the type of operation is preserved on the ground;
 - (2) ~~t~~The information is retained until it has been duplicated at the place at which it will be stored ~~in accordance with OPS 1.1065~~; or, if this is impracticable
 - (3) ~~t~~The same information is carried in a fireproof container in the ~~aeroplane aircraft~~.
- (b) The information referred to in ~~subparagraph~~(a) above includes:
- (1) ~~a~~A copy of the operational flight plan, where appropriate;
 - (2) ~~c~~Copies of the relevant part(s) of the ~~aeroplane-aircraft~~ technical log;
 - (3) ~~r~~Route--specific NOTAM documentation if specifically edited by the operator;
 - (4) ~~m~~Mass and balance documentation if required ~~(OPS 1.625 refers)~~; and
 - (5) ~~s~~Special loads notification.

CAT.GEN.AH.190~~OPS 1.145~~ Power to inspect

~~The operator shall ensure that any person authorised by the Authority is permitted at any time to board and fly in any aeroplane operated in accordance with an AOC issued by that Authority and to enter and remain on the flight deck provided that the~~

Comment [WSI25]:
Already covered in
CAT.GEN.AH.135.

Subpart B | Revised rule text

~~commander may refuse access to the flight deck if, in his/her opinion, the safety of the aeroplane would thereby be endangered.~~

~~OPS 1.150 Production of documentation and records~~

~~(a) An operator shall:~~

- ~~1. Give any person authorised by the Authority access to any documents and records which are related to flight operations or maintenance; and~~
- ~~2. Produce all such documents and records, when requested to do so by the Authority, within a reasonable period of time.~~

Comment [WSI26]:
Already covered through
OR.GEN.140 Access.

~~(b) The commander shall, within a reasonable time of being requested to do so by a person authorised by an authority, provide produce to that person the documentation required to be carried on board.~~ **OPS 1.155 Preservation of documentation**

Comment [WSI27]:
Transposed in OR.OPS.MLR.115
(e)(f)

~~An operator shall ensure that:~~

~~(1). Any original documentation, or copies thereof, that he is required to preserve is preserved for the required retention period even if he ceases to be the operator of the aeroplane; and~~

~~(2). Where a crew member, in respect of whom an operator has kept flight duty, duty and rest period records, becomes a crew member for another operator, that record is made available to the new operator.~~

CAT.GEN.AH.195 ~~OPS 1.160~~ Preservation, production and use of flight recorder recordings - aeroplanes

~~(a) Preservation of recordings:~~

~~(a)1. Following an accident **or incident, which is subject to mandatory reporting**, the operator of an aeroplane on which a flight recorder is carried shall, to the extent possible, preserve the original recorded data pertaining to that accident, as retained by the recorder for a period of 60 days unless otherwise directed by the investigating authority.~~

(b) The operator shall conduct operational checks and evaluations of flight data recorder (FDR) recordings, cockpit voice recorder (CVR) recordings and data-link recordings to ensure the continued serviceability of the recorders.

~~2. Unless prior permission has been granted by the Authority, following an incident that is subject to mandatory reporting, the operator of an aeroplane on which a flight recorder is carried shall, to the extent possible, preserve the original recorded data pertaining to that incident, as retained by the recorder for a period of 60 days unless otherwise directed by the investigating authority.~~

~~3. Additionally, when the Authority so directs, the operator of an aeroplane on which a flight recorder is carried shall preserve the original recorded data for a period of 60 days unless otherwise directed by the investigating authority.~~

Subpart B | Revised rule text

(c) The operator shall save the recordings for the period of operating time of the FDR as required by CAT.IDE.A.270, except that, for the purpose of testing and maintaining the FDR, up to one hour of the oldest recorded material at the time of testing may be erased.

(d) The operator shall keep and maintain up to date documentation which presents the necessary information to convert FDR raw data into parameters expressed in engineering units.

~~4. When a flight data recorder is required to be carried aboard an aeroplane, the operator of that aeroplane shall:~~

~~(i) save the recordings for the period of operating time as required by OPS 1.715, 1.720 and 1.725 except that, for the purpose of testing and maintaining flight data recorders, up to one hour of the oldest recorded material at the time of testing may be erased; and~~

~~(ii) keep a document which presents the information necessary to retrieve and convert the stored data into engineering units.~~

~~(b) Production of recordings~~

(e) The operator shall make available any flight recorder recording that has been preserved, if so determined by the competent authority.

~~The operator of an aeroplane on which a flight recorder is carried shall, within a reasonable time after being requested to do so by the Authority, produce any recording made by a flight recorder which is available or has been preserved.~~

(ef) Without prejudice to national criminal law: Use of recordings

~~(1) The cockpit voice recorder **CVR** recordings may **shall** not be used for purposes other than for the investigation of an accident or incident subject to mandatory reporting, except with the consent of all crew members concerned.~~

~~(2) The flight data recorder **FDR** recordings may **shall** not be used for purposes other than for the investigation of an accident or incident subject to mandatory reporting, except when such records are:~~

~~(i) used by the operator for airworthiness or maintenance purposes only; or~~

~~(ii) de-identified; or~~

~~(iii) disclosed under secure procedures.~~

(3) Data link recordings shall not be used for purposes other than for the investigation of an accident or incident which is subject to mandatory reporting, except when such records are:

(1) de-identified; or

(2) disclosed under secure procedures. OPS 1.165 Leasing

Comment [WSI28]:
Transposed in OR.OPS.AOC.

~~(a) Terminology~~

~~— Terms used in this paragraph have the following meaning:~~

~~1. Dry lease — Is when the aeroplane is operated under the AOC of the lessee.~~

Subpart B | Revised rule text

~~2. Wet lease — Is when the aeroplane is operated under the AOC of the lessor.~~

~~(b) Leasing of aeroplanes between Community operators~~

~~1. Wet lease out. A Community operator providing an aeroplane and complete crew to another Community operator, in accordance with Council Regulation (EEC) No 2407/92 of 23 July 1992 on licensing of air carriers¹, and retaining all the functions and responsibilities prescribed in Subpart C, shall remain the operator of the aeroplane.~~

~~2. All leases except wet lease out~~

~~(i) Except as provided by subparagraph (b)(1) above, a Community operator utilising an aeroplane from, or providing it to, another Community operator, must obtain prior approval for the operation from his respective Authority. Any conditions which are part of this approval must be included in the lease agreement.~~

~~(ii) Those elements of lease agreements which are approved by the Authority, other than lease agreements in which an aeroplane and complete crew are involved and no transfer of functions and responsibilities is intended, are all to be regarded, with respect to the leased aeroplane, as variations of the AOC under which the flights will be operated.~~

~~(c) Leasing of aeroplanes between a Community operator and any entity other than a Community operator:~~

~~1. Dry lease in~~

~~(i) A Community operator shall not dry lease in an aeroplane from an entity other than another Community operator, unless approved by the Authority. Any conditions which are part of this approval must be included in the lease agreement.~~

~~(ii) A Community operator shall ensure that, with regard to aeroplanes that are dry leased in, any differences from the requirements prescribed in Subparts K, L, and/or OPS 1.005(b), are notified to and are acceptable to the Authority.~~

~~2. Wet lease in~~

~~(i) A Community operator shall not wet lease in an aeroplane from an entity other than another Community operator without the approval of the Authority.~~

~~(ii) A Community operator shall ensure that, with regard to aeroplanes that are wet leased in:~~

~~(A) The safety standards of the lessor with respect to maintenance and operation are equivalent to those established by the present Regulation;~~

¹ OJ L 240, 24.8.1992, p. 1.

Subpart B | Revised rule text

- ~~(B) The lessor is an operator holding an AOC issued by a State which is a signatory to the Chicago Convention;~~
- ~~(C) The aeroplane has a standard Certificate of Airworthiness issued in accordance with ICAO Annex 8. Standard Certificates of Airworthiness issued by a Member State other than the State responsible for issuing the AOC, will be accepted without further showing when issued in accordance with Part 21; and~~
- ~~(D) Any requirement made applicable by the lessee's Authority is complied with.~~

~~3. Dry lease out~~

~~— A Community operator may dry lease out an aeroplane for the purpose of commercial air transportation to any operator of a State which is signatory to the Chicago Convention provided that the following conditions are met:~~

- ~~(A) The Authority exempted the operator from the relevant provisions of OPS Part 1 and, after the foreign regulatory authority has accepted responsibility in writing for surveillance of the maintenance and operation of the aeroplane(s), has removed the aeroplane from its AOC; and~~
- ~~(B) The aeroplane is maintained according to an approved maintenance programme.~~

~~4. Wet lease out~~

~~— A Community operator providing an aeroplane and complete crew to another entity, in accordance with Regulation (EEC) No 2407/92, and retaining all the functions and responsibilities prescribed in Subpart C, shall remain the operator of the aeroplane.~~

~~Appendix 1 to OPS 1.005(a) Operations of performance class B aeroplanes~~~~(a) Terminology~~

- ~~1. A to A operations — Take off and landing are made at the same place.~~
- ~~2. A to B operations — Take off and landing are made at different places.~~
- ~~3. Night — The hours between the end of evening civil twilight and the beginning of morning civil twilight or such other period between sunset and sunrise, as may be prescribed by the appropriate authority.~~

~~(b) Operations, to which this Appendix is applicable, may be conducted in accordance with the following alleviations.~~

- ~~1. OPS 1.035 Quality System: In the case of a very small operator, the post of Quality Manager may be held by a nominated postholder if external auditors are used. This applies also where the accountable manager is holding one or several of the nominated posts.~~
- ~~2. Reserved~~
- ~~3. OPS 1.075 Methods of carriage of persons: Not required for VFR operations of single engine aeroplanes.~~

Comment [WSI29]:
Transposed in the relevant Sections, where appropriate.

Subpart B | Revised rule text

- ~~4. OPS 1.100 Admission to the flight deck:~~
- ~~(i) An operator must establish rules for the carriage of passengers in a pilot seat.~~
- ~~(ii) The commander must ensure that:~~
- ~~(A) Carriage of passengers in a pilot seat does not cause distraction and/or interference with the operation of the flight; and~~
- ~~(B) The passenger occupying a pilot seat is made familiar with the relevant restrictions and safety procedures.~~
- ~~5. OPS 1.105 Unauthorised Carriage: Not required for VFR operations of single engine aeroplanes.~~
- ~~6. OPS 1.135 Additional information and forms to be carried:~~
- ~~(i) For A to A VFR operations of single engine aeroplanes by day, the following documents need not be carried:~~
- ~~(A) Operational Flight Plan;~~
- ~~(B) Aeroplane Technical Log;~~
- ~~(C) NOTAM/AIS briefing documentation;~~
- ~~(D) Meteorological Information;~~
- ~~(E) Notification of special categories of passengers ... etc.; and~~
- ~~(F) Notification of special loads including dangerous goods ... etc.~~
- ~~(ii) For A to B VFR operations of single engine aeroplanes by day, notification of special categories of passengers as described in OPS 1.135 (a)(7) does not need to be carried.~~
- ~~(iii) For A to B VFR operations by day, the Operational Flight Plan may be in a simplified form and must meet the needs of the type of operation.~~
- ~~7. OPS 1.215 Use of Air Traffic Services: For VFR operations of single engine aeroplanes by day, non mandatory contact with ATS shall be maintained to the extent appropriate to the nature of the operation. Search and rescue services must be ensured in accordance with OPS 1.300.~~
- ~~8. OPS 1.225 Aerodrome Operating Minima: For VFR operations, the standard VFR operating minima will normally cover this requirement. Where necessary, the operator shall specify additional requirements taking into account such factors as radio coverage, terrain, nature of sites for take off and landing, flight conditions and ATS capacity~~
- ~~9. OPS 1.235 Noise abatement procedures: Not applicable to VFR operations of single engine aeroplanes.~~
- ~~10. OPS 1.240 Routes and Areas of Operation:~~
- ~~— Subparagraph (a)(1) is not applicable to A to A VFR operations of single engine aeroplanes by day.~~
- ~~11. OPS 1.250 Establishment of minimum flight altitudes:~~

Subpart B | Revised rule text

~~For VFR operations by day, this requirement is applicable as follows. An operator shall ensure that operations are only conducted along such routes or within such areas for which a safe terrain clearance can be maintained and shall take account of such factors as temperature, terrain, unfavourable meteorological conditions (e.g. severe turbulence and descending air currents, corrections for temperature and pressure variations from standard values).~~

~~12. OPS 1.255 Fuel Policy:~~

~~(i) For A to A Flights — An operator shall specify the minimum fuel contents at which a flight must end. This minimum, final reserve, fuel must not be less than the amount needed to fly for a period of 45 minutes.~~

~~(ii) For A to B Flights — An operator shall ensure that the pre flight calculation of usable fuel required for a flight includes;~~

~~(A) Taxi fuel — Fuel consumed before take off, if significant; and~~

~~(B) Trip fuel (Fuel to reach the destination); and~~

~~(C) Reserve fuel —~~

~~1 — Contingency fuel — Fuel that is not less than 5 % of the planned trip fuel or, in the event of in flight re-planning, 5 % of the trip fuel for the remainder of the flight; and~~

~~2 — Final reserve fuel — Fuel to fly for an additional period of 45 minutes (piston engines) or 30 minutes (turbine engines); and~~

~~(D) Alternate fuel — Fuel to reach the destination alternate via the destination, if a destination alternate is required; and~~

~~(E) Extra fuel — Fuel that the commander may require in addition to that required under subparagraphs (A) — (D) above.~~

~~13. OPS 1.265 Carriage of inadmissible passengers, deportees or persons in custody: For VFR operations of single engine aeroplanes and where it is not intended to carry inadmissible passengers, deportees or persons in custody, an operator is not required to establish procedures for the carriage of such passengers.~~

~~14. OPS 1.280 Passenger Seating: Not Applicable to VFR operations of single engine aeroplanes.~~

~~15. OPS 1.285 Passenger Briefing: Demonstration and briefing shall be given as appropriate to the kind of operations. In single pilot operations, the pilot may not be allocated tasks distracting him/her from his/her flying duties.~~

~~16. OPS 1.290 Flight Preparation:~~

~~(i) Operational Flight Plan for A to A operations — Not Required.~~

~~(ii) A to B operations under VFR by day — An operator shall ensure that a simplified form of an operational flight plan which is relevant to the type of operation is completed for each flight.~~

Subpart B | Revised rule text

- ~~17. OPS 1.295 Selection of aerodromes: Not applicable to VFR operations. The necessary instructions for the use of aerodromes and sites for take-off and landing are to be issued with reference to OPS 1.220.~~
- ~~18. OPS 1.310 Crew members at stations:
— For VFR operations, instructions on this matter are required only where two pilot operations are conducted.~~
- ~~19. OPS 1.375 In-flight fuel management:
— Appendix 1 to OPS 1.375 is not required to be applied to VFR operations of single-engine aeroplanes by day.~~
- ~~20. OPS 1.405 Commencement and continuation of approach:
— Not applicable to VFR operations.~~
- ~~21. OPS 1.410 Operating procedures—threshold crossing height:
— Not applicable to VFR operations.~~
- ~~22. OPS 1.430 to 1.460, including appendices:
— Not applicable to VFR operations.~~
- ~~23. OPS 1.530 Take-off:~~
- ~~(i) Subparagraph (a) applies with the following addition. The Authority may, on a case-by-case basis, accept other performance data produced by the operator and based on demonstration and/or documented experience. Subparagraphs (b) and (c) apply with the following addition. Where the requirements of this paragraph cannot be complied with due to physical limitations relating to extending the runway and there is a clear public interest and necessity for the operation, the Authority may accept, on a case-by-case basis, other performance data, not conflicting with the Aeroplane Flight Manual relating to special procedures, produced by the operator based on demonstration and/or documented experience.~~
- ~~(ii) An operator wishing to conduct operations according to subparagraph (i) must have the prior approval of the Authority issuing the AOC. Such an approval will:~~
- ~~(A) Specify the type of aeroplane;~~
- ~~(B) Specify the type of operation;~~
- ~~(C) Specify the aerodrome(s) and runways concerned;~~
- ~~(D) Restrict the take-off to be conducted under VMC;~~
- ~~(E) Specify the crew qualification, and~~
- ~~(F) Be limited to aeroplanes where the first type certificate was first issued before 1 January 2005.~~
- ~~(iii) The operation must be accepted by the State in which the aerodrome is located.~~
- ~~24. OPS 1.535 Take-off Obstacle Clearance—Multi Engine aeroplanes:~~

Subpart B | Revised rule text

- ~~(i) Subparagraphs (a)(3), (a)(4), (a)(5), (b)(2), (c)(1), (c)(2) and the Appendix are not applicable to VFR operations by day.~~
 - ~~(ii) For IFR or VFR operations by day, subparagraphs (b) and (c) apply with the following variations.~~
 - ~~(A) Visual course guidance is considered available when the flight visibility is 1 500 m or more~~
 - ~~(B) The maximum corridor width required is 300 m when flight visibility is 1 500 m or more.~~
- ~~25. OPS 1.545 Landing — Destination and Alternate Aerodromes:~~
- ~~(i) The paragraph applies with the following addition. Where the requirements of this paragraph cannot be complied with due to physical limitations relating to extending the runway and there is a clear public interest and operational necessity for the operation, the Authority may accept, on a case by case basis, other performance data, not conflicting with the Aeroplane Flight Manual relating to special procedures, produced by the operator based on demonstration and/or documented experience.~~
 - ~~(ii) An operator wishing to conduct operations according to subparagraph (I) must have prior approval of the Authority issuing the AOC. Such an approval will:~~
 - ~~(A) Specify the type of aeroplane;~~
 - ~~(B) Specify the type of operation;~~
 - ~~(C) Specify the aerodrome(s) and runways concerned;~~
 - ~~(D) Restrict the final approach and landing to be conducted under VMC;~~
 - ~~(E) Specify the crew qualification, and~~
 - ~~(F) Be limited to aeroplanes where the type certificate was first issued before 1 January 2005.~~
 - ~~(iii) The operation must be accepted by the State in which the aerodrome is located.~~
- ~~26. OPS 1.550 Landing — Dry Runways:~~
- ~~(i) The paragraph applies with the following addition. Where the requirements of this paragraph cannot be complied with due to physical limitations relating to extending the runway and there is a clear public interest and operational necessity for the operation, the Authority may accept, on a case by case basis, other performance data, not conflicting with the Aeroplane Flight Manual relating to special procedures, produced by the operator based on demonstration and/or documented experience.~~
 - ~~(ii) An operator wishing to conduct operations according to subparagraph (i) must have prior approval of the Authority issuing the AOC. Such an approval will:~~
 - ~~(A) Specify the type of aeroplane;~~
 - ~~(B) Specify the type of operation;~~

Subpart B | Revised rule text

- ~~(C) Specify the aerodrome(s) and runways concerned;~~
- ~~(D) Restrict the final approach and landing to be conducted under VMC;~~
- ~~(E) Specify the crew qualification; and~~
- ~~(F) Be limited to aeroplanes where the first type certificate was issued before 1 January 2005.~~
- ~~(iii) The operation must be accepted by the State in which the aerodrome is located.~~
- ~~27. Reserved~~
- ~~28. OPS 1.650 Day VFR operations:~~
- ~~— Paragraph 1.650 is applicable with the following addition. Single engine aeroplanes, first issued with an individual certificate of airworthiness before 22 May 1995, may be exempted from the requirements of subparagraphs (f), (g), (h) and (i) by the Authority if the fulfilment would require retrofitting.~~
- ~~29. Part M, paragraph M.A.704, Continuing Airworthiness Management Exposition~~
- ~~— The Continuing Airworthiness Management Exposition may be adapted to the operation to be conducted;~~
- ~~30. Part M, paragraph M. A. 306, Operator's technical log system:~~
- ~~— The Authority may approve an abbreviated form of Technical Log System, relevant to the type of operation conducted.~~
- ~~31. OPS 1.940 Composition of Flight Crew:~~
- ~~— Subparagraphs (a)(2), (a)(4), and (b) are not applicable to VFR operations by day, except that (a)(4) must be applied in full where 2 pilots are required by OPS 1.~~
- ~~32. OPS 1.945 Conversion training and checking:~~
- ~~(i) Subparagraph (a)(7) Line flying under supervision (LIFUS) may be performed on any aeroplane within the applicable class. The amount of LIFUS required is dependent on the complexity of the operations to be performed.~~
- ~~(ii) Subparagraph (a)(8) is not required.~~
- ~~33. OPS 1.955 Nomination as commander:~~
- ~~— Subparagraph (b) applies as follows. The Authority may accept an abbreviated command course relevant to the type of operation conducted.~~
- ~~34. OPS 1.960 Commanders holding a Commercial Pilot Licence~~
- ~~— Subparagraph (a)(1)(i) is not applicable to VFR operations by day.~~
- ~~35. OPS 1.965 Recurrent training and checking:~~
- ~~(i) Subparagraph (a)(1) shall be applied as follows for VFR operations by day. All training and checking shall be relevant to the type of operation~~

Subpart B | Revised rule text

~~and class of aeroplane on which the flight crew member operates with due account taken of any specialised equipment used.~~

- ~~(ii) Subparagraph (a)(3)(ii) applies as follows. Training in the aeroplane may be conducted by a Class Rating Examiner (CRE), a Flight Examiner (FE) or a Type Rating Examiner (TRE).~~
- ~~(iii) Subparagraph (a)(4)(i) applies as follows. Operator proficiency check may be conducted by a Type Rating Examiner (TRE), Class Rating Examiner (CRE) or by a suitably qualified commander nominated by the operator and acceptable to the Authority, trained in CRM concepts and the assessment of CRM skills.~~
- ~~(iv) Subparagraph (b)(2) shall be applicable as follows for VFR operations by day. In those cases where the operations are conducted during seasons not longer than 8 consecutive months, 1 operator proficiency check is sufficient. This proficiency check must be undertaken before commencing commercial air transport operations.~~

~~36. OPS 1.968 Pilot qualification for either pilot's seat:~~

~~— Appendix 1 is not applicable to VFR operations of single engine aeroplanes by day.~~

~~37. OPS 1.975 Route and Aerodrome Competence:~~

- ~~(i) For VFR operations by day, subparagraphs (b), (c) and (d) are not applicable, except that the operator shall ensure that in the cases where a special approval by the state of the aerodrome is required, the associated requirements are observed.~~
- ~~(ii) For IFR operations or VFR operations by night, as an alternative to subparagraphs (b) — (d), route and aerodrome competence may be revalidated as follows:~~
 - ~~(A) Except for operations to the most demanding aerodromes, by completion of at least 10 sectors within the area of operation during the preceding 12 months in addition to any required self briefing.~~
 - ~~(B) Operations to the most demanding aerodromes may be performed only if:~~
 - ~~1. The commander has been qualified at the aerodrome within the preceding 36 months by a visit as an operating flight crew member or as an observer;~~
 - ~~2. The approach is performed in VMC from the applicable minimum sector altitude; and~~
 - ~~3. An adequate self briefing has been made prior to the flight~~

~~38. OPS 1.980 More than one type or variant:~~

- ~~(i) Not applicable if operations are limited to single pilot classes of piston engine aeroplanes under VFR by day.~~
- ~~(ii) For IFR and VFR Night Operations, the requirement in Appendix 1 to OPS 1.980, subparagraph (d)(2)(i) for 500 hours in the relevant crew position before exercising the privileges of 2 licence endorsements, is reduced to~~

Subpart B | Revised rule text

~~100 hours or sectors if one of the endorsements is related to a class. A check flight must be completed before the pilot is released for duties as Commander.~~

~~39. OPS 1.981 Operation of helicopters and aeroplanes:~~

~~— Subparagraph (a)(1) is not applicable if operations are limited to single pilot classes of piston engine aeroplanes.~~

~~40. Reserved~~

~~41. OPS 1.1060 Operational flight plan:~~

~~— Not required for A to A VFR/Day operations. For A to B VFR/Day operations the requirement is applicable but the flight plan may be in a simplified form relevant to the kind of operations conducted. (cf. OPS 1.135).~~

~~42. OPS 1.1070 Continuing Airworthiness Management Exposition~~

~~— The Continuing Airworthiness Management Exposition may be adapted to the operation to be conducted.~~

~~43. OPS 1.1071 Aeroplane technical log:~~

~~— Applicable as indicated for Part M, paragraph M. A. 306 Operators technical log system.~~

~~44. Reserved~~

~~45. Reserved~~

~~46. OPS 1.1240 Training programmes:~~

~~— The training programmes shall be adapted to the kind of operations performed. A self study training programme may be acceptable for VFR operations.~~

~~47. OPS 1.1250 Aeroplane search procedure checklist:~~

~~— Not applicable for VFR operations by day.~~

~~Appendix 1 to JAR OPS 3.005(f) Operations for small helicopters (VFR day only)~~

~~(a) Terminology.~~

~~(1) Local Operations. Flight conducted within a local and defined geographical area acceptable to the Authority, which start and end at the same location on the same day.~~

~~(b) Approval. An operator wishing to conduct operations in accordance with this Appendix must have the prior approval of the Authority issuing the AOC. Such an approval shall specify:~~

~~(1) The type of helicopter; and~~

~~(2) The type of operation.~~

~~(3) The geographical limitations of local operations in the context of this appendix (see ACJ to Appendix 1 to JAR OPS 3.005(f) paragraph (b)(3)).~~

Comment [WSI30]:
Transposed in the relevant Sections, where appropriate.

Subpart B | Revised rule text

- ~~(c) Prohibition. The following activities are prohibited:~~
- ~~(1) JAR OPS 3.065. Carriage of weapons of war and munitions of war.~~
 - ~~(2) JAR OPS 3.265. Carriage of inadmissible passengers, deportees or persons in custody.~~
 - ~~(3) JAR OPS 3.305. Refuelling/defuelling with passengers embarking, on board or disembarking.~~
 - ~~(4) JAR OPS 3.335. Smoking on board.~~
- ~~(d) Alleviation. The following rules are alleviated:~~
- ~~(1) JAR OPS 3.100 Admission to cockpit:~~
 - ~~(i) An operator must establish rules for the carriage of passengers in a pilot seat, if applicable.~~
 - ~~(ii) The commander must ensure that:~~
 - ~~(A) carriage of passengers in the pilot seat does not cause distraction and/or interference with the flight's operation; and~~
 - ~~(B) the passenger occupying a pilot seat is made familiar with the relevant restrictions and safety procedures.~~
 - ~~(2) JAR OPS 3.135 Additional information and forms to be carried.~~
 - ~~(i) For local operations the following documents need not be carried:~~
 - ~~(A) JAR OPS 3.135(a)(1) Operational Flight Plan~~
 - ~~(B) JAR OPS 3.135(a)(2) Technical Log (except where required for land-away)~~
 - ~~(C) JAR OPS 3.135(a)(4) Notam/AIS documentation~~
 - ~~(D) JAR OPS 3.135(a)(5) Meteorological information~~
 - ~~(E) JAR OPS 3.135(a)(7) Notification of special passengers, etc.~~
 - ~~(F) JAR OPS 3.135(a)(8) Notification of special loads, etc.~~
 - ~~(ii) For non-local operations:~~
 - ~~(A) JAR OPS 3.135(a)(1) Operational Flight Plan. The flight plan may be in a simplified form, relevant to the kind of operations conducted and acceptable to the Authority.~~
 - ~~(B) JAR OPS 3.135(a)(7) Notification of special passengers. Is not required.~~
 - ~~(3) JAR OPS 3.140 Information retained on the ground. Information need not be retained on the ground when other methods of recording are employed.~~
 - ~~(4) JAR OPS 3.165 Leasing. Applicable only where formal leasing agreement exists.~~
- ~~Note: The case where the contract to carry the passengers are transferred to another operator to whom the passengers will pay for the transport, is not considered as leasing.~~

Subpart B | Revised rule text

- ~~(5) JAR OPS 3.215 Use of Air Traffic Services. Not applicable unless mandated by air space requirements and providing search and rescue service arrangements are acceptable to the Authority.~~
- ~~(6) JAR OPS 3.220 Authorisation of Heliports by the operator. An operator shall establish a procedure to qualify the Commanders for the selection of heliports or landing sites, suitable for the type of helicopter and the type of operation.~~
- ~~(7) JAR OPS 3.255 Fuel policy. Subparagraphs (b) to (d) are not applicable when the fuel policy prescribed in JAR OPS 3.255(a) ensures that, on completion of the flight, or series of flights, the fuel remaining is not less than an amount of fuel sufficient for 30 minutes flying time at normal cruising (this may be reduced to 20 minutes when operating within an area providing continuous and suitable precautionary landing sites). Final reserve fuel must be specified in the operations manual in order to be able to comply with JAR OPS 3.375(c).~~
- ~~(8) JAR OPS 3.280 Passenger seating. Procedures are not required to be established.~~
- ~~Note: The intent of this paragraph is achieved by the pilot using normal judgement. JAR OPS 3.260 is applicable and is considered to address the need for procedures.~~
- ~~(9) JAR OPS 3.285 Passenger briefing.~~
- ~~(i) Paragraph (a)(1). Unless to do so would be unsafe, passengers are verbally briefed about safety matters, parts or all of which may be given by an audio visual presentation. Prior approval must be given for the use of portable electronic devices.~~
- ~~(10) JAR OPS 3.290 Flight preparation.~~
- ~~(i) For local operations:~~
- ~~(A) JAR OPS 3.290(a). An operational flight plan is not required.~~
- ~~(ii) For non local operations:~~
- ~~(A) JAR OPS 3.290(a). An operational flight plan may be prepared in a simplified form relevant to the kind of operation.~~
- ~~(11) JAR OPS 3.375 In flight fuel management. Appendix 1 to JAR OPS 3.375 need not be applied (see (d)(14) below).~~
- ~~(12) JAR OPS 3.385 Use of supplemental oxygen. With prior approval of the authority, excursions between 10 000 ft and 16 000 ft for a short duration may be undertaken without the use of supplemental oxygen in accordance with procedures contained in the Operations Manual. (In such circumstances, the operator must ensure that the passengers are informed before departure that supplemental oxygen will not be provided.)~~
- ~~(13) Appendix 1 to JAR OPS 3.270 Stowage of baggage and cargo. As appropriate to the type of operation and helicopter.~~

Subpart B | Revised rule text

- ~~(14) Appendix 1 to JAR OPS 3.375 In-flight fuel management. Not applicable.~~
- ~~(15) JAR OPS 3.630 General Introduction. Instruments and Equipment. Alternative equipment that does not meet current JTSO standards but does meet the safety standard of the original equipment may be acceptable to the Authority.~~
- ~~(16) JAR OPS 3.775 Supplemental Oxygen Non pressurised helicopters. With prior approval of the authority, excursions of a short duration between 10 000 ft and 16 000 ft may be undertaken without supplemental oxygen, in accordance with procedures contained in the Operations Manual.~~
- ~~(17) Appendix 1 to JAR OPS 3.775 Supplemental oxygen for non pressurised helicopters. Not applicable in accordance with (12) & (16) above.~~
- ~~(18) JAR OPS 3.955(b) Upgrading to Commander. The Authority may accept an abbreviated command course relevant to the type of operation to be undertaken.~~
- ~~(19) JAR OPS 3.970(a) Recent Experience. As an alternative to the requirement of JAR OPS 3.970(a), with prior approval of the Authority, the 90 day recency may be satisfied if a pilot has performed 3 takeoffs, 3 circuits and 3 landings on any helicopter in the same designated group in the preceding 90 days (see ACJ to Appendix 1 to JAR OPS 3.005(f) paragraph (d)(19)). The recency qualification for the helicopter type to be operated is conditional upon:~~
- ~~(i) the Type Rating Proficiency Check (TRPC) on the type being valid; and~~
 - ~~(ii) the achievement of 2 flying hours on the type or variant within the last 6 months; and~~
 - ~~(iii) an OPC being valid on one of the helicopters in the designated group; and~~
 - ~~(iv) a strict rotation of OPCs for all helicopters being flown in the designated group; and~~
 - ~~(v) the composition of designated groups and the procedure for validation of TRPCs, OPCs and recency, being contained in the operations manual.~~
- ~~(20) Appendix 1 to JAR OPS 3.965 Recurrent Training and checking. A syllabus applicable to the type of operation may be accepted by the Authority.~~
- ~~(21) JAR OPS 3.1060 Operational flight plan. See (2)(i)(A) & (2)(ii)(A) above.~~
- ~~(22) JAR OPS 3.1235 Security requirements. Applicable only when operating in States where the national security program applies to the operations covered in this Appendix.~~
- ~~(23) JAR OPS 3.1240 Training programs. Training programs shall be adapted to the kind of operations performed. A suitable self study training program may be acceptable to the Authority.~~
- ~~(24) JAR OPS 3.1250 Helicopter search procedure checklist. No checklist is required.~~
- ~~Appendix 1 to JAR OPS 3.005(g) Local area operations (VFR day only)~~

Comment [WSI31]:
Transposed in the relevant Sections, where appropriate.

Subpart B | Revised rule text

- ~~(a) Approval. An operator wishing to conduct operations in accordance with this Appendix must have the prior approval of the Authority issuing the AOC. Such an approval will specify:~~
- ~~(1) The type of helicopter~~
 - ~~(2) Type of operation~~
 - ~~(3) The geographical limitations of operations in the context of this appendix (see ACJ to Appendix 1 to JAR OPS 3.005(g) paragraph (a)(3)).~~
- ~~(b) Prohibition. The following activities are prohibited:~~
- ~~(1) JAR OPS 3.065. Carriage of weapons of war and munitions of war.~~
 - ~~(2) JAR OPS 3.265. Carriage of inadmissible passengers, deportees or persons in custody.~~
 - ~~(3) JAR OPS 3.305. Refuelling/defuelling with passengers embarking, on board or disembarking.~~
 - ~~(4) JAR OPS 3.335. Smoking on board.~~
- ~~(c) Alleviation. The following rules are alleviated:~~
- ~~(1) JAR OPS 3.135 Additional information and forms to be carried.~~
 - ~~(i) JAR OPS 3.135(a)(1) Operational Flight Plan. The flight plan may be in a simplified form, relevant to the kind of operations conducted and acceptable to the Authority.~~
 - ~~(ii) JAR OPS 3.135(a)(4) Notam/AIS documentation. Are not required.~~
 - ~~(iii) JAR OPS 3.135(a)(5) Meteorological information. Is not required.~~
 - ~~(iv) JAR OPS 3.135(a)(7) Notification of special passengers, etc. Is not required.~~
 - ~~(v) JAR OPS 3.135(a)(8) Notification of special loads, etc. Is not required.~~
 - ~~(2) JAR OPS 3.140 Information retained on the ground. Information need not be retained on the ground when other methods of recording are employed.~~
 - ~~(3) JAR OPS 3.165 Leasing. Applicable only where a formal leasing agreement exists.~~
- ~~Note: — The case where the contract to carry the passengers are transferred to another operator to whom the passengers will pay for the transport, is not considered as leasing.~~
- ~~(4) JAR OPS 3.215 Use of Air Traffic Services. Not applicable unless mandated by air space requirements and providing search and rescue service arrangements are acceptable to the Authority.~~
 - ~~(5) JAR OPS 3.220 Authorisation of Heliports by the operator. An operator shall establish a procedure to qualify the Commanders for the selection of heliports or landing sites, suitable for the type of helicopter and the type of operation.~~

Subpart B | Revised rule text

- ~~(6) JAR OPS 3.255 Fuel policy. Subparagraphs (b) to (d) are not applicable when the fuel policy prescribed in JAR OPS 3.255(a) ensures that, on completion of the flight, or series of flights, the fuel remaining is not less than an amount of fuel sufficient for 30 minutes flying time at normal cruising (this may be reduced to 20 minutes when operating within an area providing continuous and suitable precautionary landing sites). Final reserve fuel must be established in the operations manual in order to be able to comply with JAR OPS 3.375(c).~~
- ~~(7) JAR OPS 3.290(a). See (C)(1)(i) above.~~
- ~~(8) JAR OPS 3.375 In flight fuel management. Appendix 1 to JAR OPS 3.375 need not be applied (see (c)(10) below).~~
- ~~(9) JAR OPS 3.385 Use of supplemental oxygen. With prior approval of the authority excursions between 10 000 ft and 13 000 ft for a short duration may be undertaken without the use of supplemental oxygen in accordance with procedures contained in the Operations Manual. (In such circumstances, the operator must ensure that passengers are informed before departure that supplemental oxygen will not be provided.)~~
- ~~(10) Appendix 1 to JAR OPS 3.375 Inflight fuel management. Not applicable.~~
- ~~(11) JAR OPS 3.630 General Introduction. Instruments and Equipment. Alternative equipment that does not meet current JTSO standards but does meet the safety standard of the original equipment may be acceptable to the Authority.~~
- ~~(12) JAR OPS 3.775 Supplemental Oxygen—Non pressurised helicopters. With prior approval of the authority, excursions of a short duration between 10 000 ft and 16 000 ft may be undertaken without supplemental oxygen, in accordance with procedures contained in the Operations Manual.~~
- ~~(13) Appendix 1 to JAR OPS 3.775 Supplemental oxygen for non pressurised helicopters. Not applicable in accordance with (9) & (12) above.~~
- ~~(14) JAR OPS 3.1060 Operational flight plan. See (C)(1)(i) above.~~
- ~~(15) JAR OPS 3.1235 Security requirements. Applicable only in States where the national security program applies to the operations covered in this Appendix.~~

*Subpart B | Revised rule text***[CAT.GEN | AMC/GM]****AMC1-CAT.GEN.AH.180(a) Documents, manuals and information to be carried**
~~Appendix 1 to OPS 1.125 Documents to be carried~~

~~SEE OPS 1.125.~~

LOSS OR THEFT OF DOCUMENTS

In case of loss or theft of documents ~~specified in OPS 1.125~~, the operation is allowed to continue until the flight reaches the base or a place where a replacement document can be provided.

[CAT.GEN | IR]**CAT.GEN.AH.200~~OPS.GEN.030~~ Transport of dangerous goods**

- (a) **Unless otherwise permitted by this Part, t**he transport of dangerous goods by air shall be conducted in accordance **with Annex 18 to the Chicago Convention as last amended and amplified by** ~~with the 2007-2008 Edition of the~~ Technical Instructions for the Safe Transport of Dangerous Goods by Air **(ICAO Doc 9284-AN/905), including its attachments, supplements and any other addenda** ~~published by decision of the Council of the International Civil Aviation Organization. (ICAO Doc 9284-AN/905.).~~
- (b) Dangerous goods shall only be transported by ~~an~~ **the** operator approved in accordance with ~~OPS-SPA.DG~~, except when:
- (1) they are not subject to the Technical Instructions in accordance with Part 1 of those Instructions; ~~or~~
 - (2) ~~required on board the aircraft in accordance with airworthiness and operational requirements;~~
 - (3) ~~required on board the aircraft for specialised purposes;~~
 - (4) **they are** carried by passengers or crew members, **or are in baggage**, in accordance with **Part 8 of** the Technical Instructions; ~~or.~~
 - (5) ~~in baggage which has been separated from its owner.~~
- (c) **An operator shall establish procedures to ensure that all** ~~all~~ reasonable measures **are** ~~shall~~ be taken to prevent dangerous goods from being carried on board inadvertently.
- (d) **The operator shall provide personnel with the necessary information enabling them to carry out their responsibilities, as required by the Technical Instructions.**
- ~~(e)~~ The operator shall, in accordance with the Technical Instructions, report without delay **to the competent authority and the appropriate authority of the State of occurrence in the event of:** ~~to the competent authority and the authority of the State where the accident or incident occurred:~~

Subpart B | Revised rule text

- (1) any **dangerous goods accidents or** incidents—~~or accidents involving dangerous goods; and~~
 - (2) the finding of undeclared or misdeclared dangerous goods discovered in cargo or ~~passengers' baggage~~; **mail; or**
 - (3) the finding of dangerous goods carried by passengers or crew, or in their baggage, when not in accordance with Part 8 of the Technical Instructions.**
- (f) **The operator shall ensure that passengers are provided with information about dangerous goods as required by the Technical Instructions.**
- (g) **The operator shall ensure that notices giving information about the transport of dangerous goods are provided at acceptance points for cargo as required by the Technical Instructions.**

*Subpart B | Revised rule text***Part-CAT | AMC-GM****Subpart A – General requirements****Section 1 – Aeroplanes and helicopters****AMC1-CAT.GEN.AH.100(b) Crew responsibilities****COPIES OF REPORTS**

Where written reports are required, a copy of the reports should be communicated to the commander concerned, unless the terms of the operator's reporting schemes prevent this.

GM1-CAT.GEN.AH.100(c) Crew responsibilities**ELAPSED TIME BEFORE RETURNING TO FLYING DUTY**

24 hours is a suitable minimum length of time to allow after normal blood donation or normal recreational (sport) diving before returning to flying duties. This should be considered by operators when determining a reasonable time period for the guidance of crew members.

AMC1-CAT.GEN.AH.115 Personnel or crew members other than cabin crew in the passenger compartment

Comment [WSI32]:
OPS 1.989(b).

MEASURES TO PREVENT

Personnel or crew members other than cabin crew should not wear a uniform or perform tasks which might identify them as members of the operating cabin crew.

AMC1-CAT.GEN.AH.130 ~~ACJ OPS 3-210~~(d) Rotor engagement - helicopters

ROTOR ENGAGEMENT

The intent of this paragraph is to ensure that the pilot **should** remain at the controls when the rotors are turning under power. **The requirement, however, should not** ~~whilst not preventing~~ ground runs being conducted by qualified personnel other than pilots. The operator should ensure that the qualification of personnel, other than pilots, who are authorised to conduct ground runs, is described in the appropriate manual. **Ground runs should not include taxiing the helicopter.**

*Subpart B | Revised rule text***AMC1-CAT.GEN.AH.135(a)(3) Admission to flight crew compartment****INSTRUCTIONS FOR SINGLE-PILOT VFR DAY OPERATIONS**

Where an aircraft is used in a single-pilot VFR day operation but has more than one pilot station, the instructions of the operator may permit passengers to be carried in the unoccupied pilot seat(s), provided that the commander is satisfied that:

- 1. it will not cause distraction or interference with the operation of the flight; and**
- 2. the passenger occupying a pilot seat is familiar with the relevant restrictions and safety procedures.**

GM1-CAT.GEN.AH.155~~IEM OPS 3.065~~ Carriage of weapons of war and munitions of war**WEAPONS OF WAR AND MUNITIONS OF WAR**

1. There is no internationally agreed definition of weapons of war and munitions of war. Some States may have defined them for their particular purposes or for national need.
2. It ~~should be~~ **is** the responsibility of the operator to check, with the State(s) concerned, whether or not a particular weapon or munition is regarded as a weapon of war or munitions of war. In this context, States which may be concerned with granting approvals for the carriage of weapons of war or munitions of war are those of origin, transit, overflight and destination of the consignment and the State of the operator.
3. Where weapons of war or munitions of war are also dangerous goods by definition (e.g. torpedoes, bombs, etc.), **CAT.GEN.AH.200 Transport of dangerous goods** ~~Subpart R will also apply.~~

GM1-CAT.GEN.AH.160~~IEM OPS 3.070~~ Carriage of sporting weapons and ammunitions**SPORTING WEAPONS**

1. There is no internationally agreed definition of sporting weapons. In general ~~they~~ **it** may be any weapon which is not a weapon of war or munitions of war ~~(See IEM OPS 3.065)~~. Sporting weapons include hunting knives, bows and other similar articles. An antique weapon, which at one time may have been a weapon of war or munitions of war, such as a musket, may now be regarded as a sporting weapon.
2. A firearm is any gun, rifle or pistol which fires a projectile.
3. ~~In the absence of a specific definition, for the purpose of JAR OPS and in order to provide some guidance to operators,~~ **T**he following firearms are generally regarded as being sporting weapons:
 - a. those designed for shooting game, birds and other animals;

Subpart B | Revised rule text

- b. those used for target shooting, clay-pigeon shooting and competition shooting, providing the weapons are not those on standard issue to military forces;
 - c. airguns, dart guns, starting pistols, etc.
4. A firearm, which is not a weapon of war or munitions of war, should be treated as a sporting weapon for the purposes of its carriage on **an aircraft-helicopter**.

AMC1-CAT.GEN.AH.161 Carriage of sporting weapons and ammunition - alleviations**SPORTING WEAPONS**

~~5. Other procedures for the carriage of sporting weapons may need to be considered if the helicopter does not have a separate compartment in which the weapons can be stowed. These procedures should take into account the nature of the flight, its origin and destination, and the possibility of unlawful interference. As far as possible, the weapons should be stowed so they are not immediately accessible to the passengers, (e.g. in locked boxes, in checked baggage which is stowed under other baggage or under fixed netting). If procedures other than those in CAT.GEN.AH.JAR OPS 3.070(b)(1) are applied, the commander should be notified accordingly.~~

AMC1-CAT.GEN.AH.180 Documents, manuals and information to be carried**GENERAL**

The documents, manuals and information may be available in a form other than on printed paper. Accessibility, usability and reliability should be assured.

AMC1-CAT.GEN.AH.180(a)(1) Documents, manuals and information to be carried**AIRCRAFT FLIGHT MANUAL OR EQUIVALENT DOCUMENT(S)**

'Aircraft flight manual, or equivalent document(s)' means; the flight manual for the aircraft, or other documents containing information required for the operation of the aircraft within the terms of its certificate of airworthiness, unless this data is available in the parts of the operations manual carried on board.

GM1-CAT.GEN.AH.180(a)(5) Documents, manuals and information to be carried**THE AIR OPERATOR CERTIFICATE**

Certified true copies may be provided:

1. **directly by the competent authority; or**
2. **by persons holding privileges for certification of official documents in accordance with applicable Member State's legislation, e.g., public notaries, authorised officials in public services.**

Subpart B | Revised rule text

AMC1-CAT.GEN.AH.180(a)(9) Documents, manuals and information to be carried

JOURNEY LOG OR EQUIVALENT

'Journey log, or equivalent' means; that the required information may be recorded in documentation other than a log book, such as the operational flight plan or the aircraft technical log.

AMC1-CAT.GEN.AH.180(a)(13) Documents, manuals and information to be carried

PROCEDURES AND VISUAL SIGNALS FOR USE BY INTERCEPTING AND INTERCEPTED AIRCRAFT

The procedures and the visual signals for use by intercepting and intercepted aircraft should reflect those contained in ICAO Annex 2. This may be part of the operations manual.

GM1-CAT.GEN.AH.180(a)(14) Documents, manuals and information to be carried

SEARCH AND RESCUE INFORMATION

This information is usually found in the State's aeronautical information publication.

GM1-CAT.GEN.AH.180(a)(23) Documents, manuals and information to be carried

DOCUMENTS WHICH MAY BE PERTINENT TO THE FLIGHT

Any other documents which may be pertinent to the flight or required by the States concerned with the flight may include, for example, forms to comply with reporting requirements.

STATES CONCERNED WITH THE FLIGHT

The States concerned are those of origin, transit, overflight and destination of the flight.

AMC1-CAT.GEN.AH.195 Preservation, production and use —of flight recorder recordings - aeroplanes

OPERATIONAL CHECKS

Whenever a recorder is required to be carried, the operator should:

1. perform an annual inspection of FDR recording, CVR recording, and, if applicable, data-link recording; and-

Subpart B | Revised rule text

2. **check every five years or in accordance with the recommendations of the sensor manufacturer, that the parameters dedicated to the FDR and not monitored by other means are being recorded within the calibration tolerances.**

GM1-CAT.GEN.AH.195IEM-OPS-3.160(a) Preservation of recordings, production and use of flight recorder recordings - aeroplanes

PROCEDURES FOR THE INSPECTIONS AND MAINTENANCE PRACTICES

Procedures for the inspections and maintenance practices of the FDR and CVR systems are given in ICAO Annex 6, Part I and in Annex II-B of EUROCAE ED-112.

REMOVAL OF RECORDERS

The need for removal of the recorders from the aircraft will be determined by the investigating authority with due regard to the seriousness of an occurrence and the circumstances, including the impact on the operation.

AMC1-CAT.GEN.AH.200(e) Transport of dangerous goods

DANGEROUS GOODS ACCIDENT AND -INCIDENT REPORTING

1. **Any type of dangerous goods accident or incident, or the finding of undeclared or misdeclared dangerous goods should be reported, irrespective of whether the dangerous goods are contained in cargo, mail, passengers' baggage or crew baggage. For the purposes of the reporting of undeclared and misdeclared dangerous goods found in cargo, the Technical Instructions considers this to include items of operators' stores that are classified as dangerous goods.**
2. **The first report should be dispatched within 72 hours of the event. It may be sent by any means, including e-mail, telephone or fax. This report should include the details that are known at that time, under the headings identified in 3. below. If necessary, a subsequent report should be made as soon as possible giving all the details that were not known at the time the first report was sent. If a report has been made verbally, written confirmation should be sent as soon as possible.**
3. **The first and any subsequent report should be as precise as possible and **should** contain such of the following data, that are **where** relevant:**
 - a. **d** ~~D~~ate of the incident or accident or the finding of undeclared or misdeclared dangerous goods;
 - b. **l** ~~L~~ocation, the flight number and flight date;
 - c. **d** ~~D~~escription of the goods and the reference number of the air waybill, pouch, baggage tag, ticket, etc;

Subpart B | Revised rule text

- d. ~~p~~Proper shipping name (including the technical name, if appropriate) and UN/ID number, when known;
 - e. ~~c~~Class or division and any subsidiary risk;
 - f. ~~t~~Type of packaging, and the packaging specification marking on it;
 - g. ~~q~~Quantity;
 - h. ~~n~~Name and address of the shipper, passenger, etc;
 - i. ~~a~~Any other relevant details;
 - j. ~~s~~Suspected cause of the incident or accident;
 - k. ~~a~~Action taken;
 - l. ~~a~~Any other reporting action taken; and
 - m. ~~n~~Name, title, address and telephone number of the person making the report.
4. Copies of relevant documents and any photographs taken should be attached to a **the** report.
 5. A dangerous goods accident or incident may also constitute an aircraft accident, serious incident or incident. **Reports should be made for** ~~The criteria for reporting~~ both types of occurrences **when the criteria for each should be are** met.
 6. **The following ~~d~~Dangerous ~~g~~Goods ~~r~~Reporting ~~f~~Form should be used, but other forms, including electronic transfer of data, may be used provided that at least the minimum information of this AMC is supplied:**

DANGEROUS GOODS OCCURRENCE REPORT		DGOR No:
1. Operator:	2. Date of Occurrence:	3. Local time of occurrence:
4. Flight date:	5. Flight No:	
6. Departure aerodrome:	7. Destination aerodrome:	
8. Aircraft type:	9. Aircraft registration:	
10. Location of occurrence:	11. Origin of the goods:	
12. Description of the occurrence, including details of injury, damage, etc. (if necessary continue on the reverse of this form):		

Subpart B | Revised rule text

13. Proper shipping name (including the technical name):			14. UN/ID No (when known):
15. Class/Division (when known):	16. Subsidiary risk(s):	17. Packing group:	18. Category (Class 7 only):
19. Type of packaging:	20. Packaging specification marking:	21. No of packages:	22. Quantity (or transport index, if applicable):
23. Reference No of Airway Bill:			
24. Reference No of courier pouch, baggage tag, or passenger ticket:			
25. Name and address of shipper, agent, passenger, etc.:			
26. Other relevant information (including suspected cause, any action taken):			
27. Name and title of person making report:		28. Telephone No:	
29. Company:		30. Reporters ref:	
31. Address:		32. Signature:	
		33. Date:	
Description of the occurrence (continuation)			

Notes for completion of the form:

1. Any type of dangerous goods occurrence ~~must~~ **should** be reported, irrespective of whether the dangerous goods are contained in cargo, mail or baggage.

Subpart B | Revised rule text

2. A dangerous goods accident is an occurrence associated with and related to the transport of dangerous goods which results in fatal or serious injury to a person or major property damage. For this purpose serious injury is an injury which is sustained by a person in an accident and which:
 - a. requires hospitalisation for more than 48 hours, commencing within 7 day from the date the injury was received; or
 - b. results in a fracture of any bones (except simple fractures of fingers, toes or nose); or
 - c. involves lacerations which cause severe haemorrhage, nerve, muscle or tendon damage; or
 - d. involves injury to any internal organ; or
 - e. involves second or third degree burns, or any burns affecting more than 5 % of the body surface; or
 - f. involves verified exposure to infectious substances or injurious radiation. A dangerous goods accident may also be an aircraft accident; in which case the normal procedure for reporting of air accidents ~~must~~**should** be followed.
3. A dangerous goods incident is an occurrence, other than a dangerous goods accident, associated with and related to the transport of dangerous goods, not necessarily occurring on board an aircraft, which results in injury to a person, property damage, fire, breakage, spillage, leakage of fluid or radiation or other evidence that the integrity of the packaging has not been maintained. Any occurrence relating to the transport of dangerous goods which seriously jeopardises the aircraft or its occupants is also deemed to constitute a dangerous goods incident.
4. This form should also be used to report any occasion when undeclared or misdeclared dangerous goods are discovered in cargo, mail or unaccompanied baggage or when accompanied baggage contains dangerous goods which passengers or crew are not permitted to take on aircraft.
5. An initial report, which may be made by any means, ~~must~~**should** be dispatched within 72 hours of the occurrence, to the competent authority of the State (a) of the operator; and (b) in which the incident occurred, unless exceptional circumstances prevent this. This occurrence report form, duly completed, ~~must~~**should** be sent as soon as possible, even if all the information is not available.
6. Copies of all relevant documents and any photographs should be attached to this report.
7. Any further information, or any information not included in the initial report, ~~must~~**should** be sent as soon as possible to authorities identified in ~~paragraph~~**5 above**.
8. Providing it is safe to do so, all dangerous goods, packagings, documents, etc., relating to the occurrence ~~must~~**should** be retained until after the initial report has been sent to the authorities identified in ~~paragraph~~**5. above** and they have indicated whether or not these should continue to be retained.

*Subpart B | Revised rule text***GM1-CAT.GEN.AH.200 Transport of dangerous goods**

GENERAL

1. The requirements to transport dangerous goods by air in accordance with the ~~2007–2008 Edition of the Technical Instructions for the Safe Transport of Dangerous Goods by Air published by decision of the Council of the International Civil Aviation Organization. (ICAO Doc 9284-AN/905.)~~ is irrespective of whether:
 - a. **the flight is wholly or partly within or wholly outside the territory of a state; or**
 - b. ~~an approval to carry dangerous goods in accordance with OPS.SPA.DG.001.DG is held.~~
2. **The Technical Instructions provide that in certain circumstances dangerous goods, which are normally forbidden on an aircraft, may be carried. These circumstances include cases of extreme urgency or when other forms of transport are inappropriate or when full compliance with the prescribed requirements is contrary to the public interest. In these circumstances all the States concerned may grant exemptions from the provisions of the Technical Instructions provided that an overall level of safety which is at least equivalent to that provided by the Technical Instructions is achieved. Although exemptions are most likely to be granted for the carriage of dangerous goods which are not permitted in normal circumstances, they may also be granted in other circumstances, such as when the packaging to be used is not provided for by the appropriate packing method or the quantity in the packaging is greater than that permitted. The Technical Instructions also make provision for some dangerous goods to be carried when an approval has been granted only by the State of Origin and the State of the Operator, or in the case of non-commercial operations with other-than-complex motor-powered aircraft, the State of Registry.**
3. **When an exemption is required, the States concerned are those of origin, transit, overflight and destination of the consignment and that of the operator. For the State of overflight, if none of the criteria for granting an exemption are relevant, an exemption may be granted based solely on whether it is believed that an equivalent level of safety in air transport has been achieved.**
4. **The Technical Instructions provide that exemptions and approvals are granted by the "appropriate national authority", which is intended to be the authority responsible for the particular aspect against which the exemption or approval is being sought. The Instructions do not specify who should seek exemptions and, depending on the legislation of the particular State, this may mean the operator, the shipper or an agent. If an exemption or approval has been granted to other than the operator, the operator should ensure a copy has been obtained before the relevant flight. The operator should ensure all relevant conditions on an exemption or approval are met.**

Subpart B | Revised rule text

- 5. The exemption or approval referred to in 2. to 4. is in addition to the approval required by SPA.DG.**

Subpart D | Revised rule text

Scope

This document shows changes to

- Subpart D of EU-OPS and JAR-OPS3;
- Related Section 2 material of JAR-OPS1 and JAR-OPS3.

This document contains the revised rule text for

- Annex I – Definitions;
- Part-OR: text moved to OR.OPS.GEN;
- Part-SPA: text moved to SPA.RVSM, SPA.MNPS, SPA.ETOPS
- Part-CAT: CAT.OP.AH.

Subpart D | Revised rule text

Table of contents

[1]Annex I - Definitions for terms used in Annexes II – VI.....	8
[2]Part-OR	10
Subpart OPS – Air Operations.....	10
SECTION I – GENERAL REQUIREMENTS	10
OR.OPS.GEN.105 Operator responsibilities.....	10
OR.OPS.GEN.105 Operator responsibilities.....	10
OR.OPS.GEN.105 Operator responsibilities.....	10
[5]Part-CAT - IR.....	12
Subpart B – Operating procedures	12
Section I – Aeroplanes and helicopters	12
CAT.OP.AH.100 Use of air traffic services	12
CAT.OP.AH.105 Use of aerodromes and operating sites	12
CAT.OP.AH.106 Use of isolated aerodromes - aeroplanes	13
CAT.OP.AH.125 Instrument departure and approach procedures	13
CAT.OP.AH.130 Noise abatement procedures	14
[AMC/GM CAT.OP].....	14
AMC1-CAT.OP.AH.130 Noise abatement procedures.....	14
NDAP DESIGN - AEROPLANES	14
[IR CAT.OP]	14
CAT.OP.AH.135 Routes and areas of operation - general	14
CAT.OP.AH.136 Routes and areas of operation - single-engine aeroplanes.....	15
CAT.OP.AH.137 Routes and areas of operation - helicopters	15
[3]Part-SPA	16
Subpart D - Operations in airspace with reduced vertical separation minima	16
SPA.RVSM.100 RVSM operations	16
Subpart C – Operations with specified minimum navigation performance.16	
SPA.MNPS.100 MNPS operations	16
SPA.MNPS.105 MNPS operational approval	16
[6]Part-CAT - IR.....	18
[IR CAT.OP]	18
CAT.OP.AH.140 Maximum distance from an adequate aerodrome for two-engined aeroplanes without an ETOPS approval	18

Subpart D | Revised rule text

[AMC/GM CAT.OP]	19
GM1-CAT.OP.AH.140 Maximum distance from an adequate aerodrome for two-engined aeroplanes without an ETOPS approval	19
ONE-ENGINE-INOPERATIVE (OEI) CRUISING SPEED	19
[4]Part-SPA	20
Subpart F - Extended range operations with two-engined aeroplanes	20
SPA.ETOPS.100.A ETOPS.....	20
SPA.ETOPS.105.A ETOPS operational approval	20
SPA.ETOPS.110.A ETOPS en-route alternate	20
[7]Part-CAT	22
[IR CAT.OP]	22
CAT.OP.AH.145 Establishment of minimum flight altitudes.....	22
[AMC/GM CAT.OP]	22
AMC1-CAT.OP.AH.145(a) Establishment of minimum flight altitudes	22
CONSIDERATIONS FOR ESTABLISHING MINIMUM FLIGHT ALTITUDES.....	22
VFR OPERATIONS OF OTHER-THAN-COMPLEX MOTOR-POWERED AIRCRAFT BY DAY	23
[IR CAT.OP]	23
CAT.OP.AH.150 Fuel policy	23
CAT.OP.AH.151 Fuel policy - alleviations	24
CAT.OP.AH.155 Carriage of special categories of passengers (SCPs)	25
CAT.OP.AH.160 Stowage of baggage and cargo.....	25
CAT.OP.AH.165 Passenger seating.....	26
CAT.OP.AH.170 Passenger briefing	26
[AMC/GM CAT.OP]	26
AMC1-CAT.OP.AH.170 Passenger briefing	26
PASSENGER BRIEFING	26
TRAINING PROGRAMME.....	27
[IR CAT.OP]	28
CAT.OP.AH.175 Flight preparation	28
CAT.OP.AH.180 Selection of aerodromes - aeroplanes.....	29
CAT.OP.AH.181 Selection of aerodromes and operating sites - helicopters	30
CAT.OP.AH.185 Planning minima for IFR flights - aeroplanes	31
CAT.OP.AH.186 Planning minima for IFR flights - helicopters	33
CAT.OP.AH.190 Submission of ATS flight plan	34

Subpart D | Revised rule text

CAT.OP.AH.195 Refuelling/defuelling with passengers embarking, on board or disembarking	34
CAT.OP.AH.200 Refuelling/defuelling with wide-cut fuel.....	34
CAT.OP.AH.205 Push back and towing - aeroplanes	34
[AMC/GM CAT.OP].....	35
AMC1-CAT.OP.AH.205 Push back and towing - aeroplanes	35
BARLESS TOWING	35
[IR CAT.OP]	35
CAT.OP.AH.210 Crew members at stations	35
CAT.OP.AH.215 Use of headset - aeroplanes	36
CAT.OP.AH.216 Use of headset - helicopters	37
CAT.OP.AH.220 Assisting means for emergency evacuation	37
CAT.OP.AH.225 Seats, safety belts and harnesses	37
CAT.OP.AH.230 Securing of passenger cabin and galley(s)	38
CAT.OP.AH.235 Life-jackets - helicopters.....	38
CAT.OP.AH.240 Smoking on board	38
CAT.OP.AH.245 Meteorological conditions	38
CAT.OP.AH.250 Ice and other contaminants – ground procedures	40
CAT.OP.AH.255 Ice and other contaminants – flight procedures	40
CAT.OP.AH.260 Fuel and oil supply	40
CAT.OP.AH.265 Take-off conditions	40
CAT.OP.AH.270 Minimum flight altitudes	41
CAT.OP.AH.275 Simulated abnormal situations in flight.....	41
CAT.OP.AH.280 In-flight fuel management - aeroplanes.....	41
CAT.OP.AH.281 In-flight fuel management - helicopters	42
CAT.OP.AH.285 Use of supplemental oxygen	43
CAT.OP.AH.290 Ground proximity detection.....	43
CAT.OP.AH.295 Use of airborne collision avoidance system (ACAS II)	43
CAT.OP.AH.300 Approach and landing conditions.....	44
CAT.OP.AH.305 Commencement and continuation of approach	44
[AMC/GM CAT.OP].....	45
GM1-CAT.OP.AH.305(f) Commencement and continuation of approach	45
EXPLANATION OF THE TERM "RELEVANT"	45
[IR CAT.OP]	45
CAT.OP.AH.310 Operating procedures – threshold crossing height - aeroplanes	45

Subpart D | Revised rule text

CAT.OP.AH.315 Flight hours reporting - helicopters	46
[AMC/GM CAT.OP].....	48
AMC1-CAT.OP.AH.150 Fuel policy	48
PROCEDURES - AEROPLANES	48
LOCATION OF THE FUEL EN-ROUTE ALTERNATE (FUEL ERA) AERODROME	52
AMC1-CAT.OP.AH.160 Stowage of baggage and cargo	54
STOWAGE PROCEDURES.....	54
AMC1-CAT.OP.AH.195 Refuelling/defuelling with passengers embarking, on board or disembarking	54
OPERATIONAL PROCEDURES - AEROPLANES	54
Part-CAT – AMC/GM	56
Subpart B – Operating procedures	56
Section I – Aeroplanes and Helicopters	56
AMC1-CAT.OP.AH.105 Use of aerodromes and operating sites.....	56
DEFINING OPERATING SITES - HELICOPTERS	56
HELIDECK	57
GM1-CAT.OP.AH.130 Noise abatement procedures	61
TERMINOLOGY	61
GENERAL	62
EXAMPLE	62
GM1-CAT.OP.AH.137(a)(2) Routes and areas of operation - helicopters.....	62
COASTAL TRANSIT.....	62
AMC1-CAT.OP.AH.150 Fuel policy	65
PLANNING CRITERIA - HELICOPTER	65
GM1-CAT.OP.AH.150 Fuel policy.....	67
CONTINGENCY FUEL STATISTICAL METHOD - AEROPLANES	67
GM1-CAT.OP.AH.150(c)(3)(i) Fuel policy	67
CONTINGENCY FUEL.....	67
GM1-CAT.OP.AH.150(c)(3)(ii) Fuel policy	68
DESTINATION ALTERNATE AERODROME	68
AMC1-CAT.OP.AH.155 Carriage of special categories of passengers (SCPs)	68
GENERAL	68
GM1-CAT.OP.AH.155 Carriage of special categories of passengers (SCPs).....	68
GENERAL	68
AMC1-CAT.OP.AH.160 Stowage of baggage and cargo	68

Subpart D | Revised rule text

CARRIAGE OF CARGO IN THE PASSENGER CABIN	68
AMC1-CAT.OP.AH.165 Passenger seating.....	69
PROCEDURES	69
ACCESS TO EMERGENCY EXITS	69
GM1-CAT.OP.AH.165 Passenger seating	70
AMC1-CAT.OP.AH.175(a) Flight preparation	70
OPERATIONAL FLIGHT PLAN – COMPLEX MOTOR-POWERED AIRCRAFT	70
OPERATIONAL FLIGHT PLAN - OTHER-THAN-COMPLEX MOTOR-POWERED AIRCRAFT AND LOCAL OPERATIONS	71
GM1-CAT.OP.AH.175(b)(5) Flight preparation	71
CONVERSION TABLES	71
AMC1-CAT.OP.AH.180 Selection of aerodromes - aeroplanes	71
OPERATIONAL CRITERIA FOR SMALL TWO-ENGINED AEROPLANES WITHOUT ETOPS CAPABILITY	71
GM1-CAT.OP.AH.180 Selection of aerodromes - aeroplanes	77
APPLICATION OF AERODROME FORECASTS.....	77
AMC1-CAT.OP.AH.181(c)(1) Selection of aerodromes and operating sites - helicopters.....	78
OFFSHORE AERODROME	78
AMC1-CAT.OP.AH.181(e) Selection of aerodromes and operating sites - helicopters.....	79
HELIDECK.....	79
GM1-CAT.OP.AH.181 Selection of aerodromes and operating sites - helicopters	81
OFFSHORE ALTERNATES.....	81
LANDING FORECAST	81
GM1-CAT.OP.AH.185 Planning minima for IFR flights - aeroplanes.....	82
PLANNING MINIMA FOR ALTERNATE AERODROMES.....	82
AMC1-CAT.OP.AH.190 Submission of ATS flight plan.....	82
FLIGHTS WITHOUT ATS FLIGHT PLAN.....	82
AMC1-CAT.OP.AH.195 Refuelling/defuelling with passengers embarking, on board or disembarking	83
OPERATIONAL PROCEDURES - GENERAL.....	83
OPERATIONAL PROCEDURES - HELICOPTERS	83
GM1-CAT.OP.AH.200 Refuelling/defuelling with wide-cut fuel	84
PROCEDURES	84
AMC1-CAT.OP.AH.210 Crew members at stations	85

Subpart D | Revised rule text

CABIN CREW SEATING POSITIONS	85
GM1-CAT.OP.AH.210 Crew members at stations.....	85
MITIGATING MEASURES – CONTROLLED REST	85
GM1-CAT.OP.AH.250 Ice and other contaminants – ground procedures	87
TERMINOLOGY	87
ANTI-ICING CODES.....	88
GM2-CAT.OP.AH.250 Ice and other contaminants – ground procedures	89
DE-ICING/ANTI-ICING - PROCEDURES	89
GM3-CAT.OP.AH.250 Ice and other contaminants – ground procedures	93
DE-ICING/ANTI-ICING BACKGROUND INFORMATION	93
AMC1-CAT.OP.AH.255 Ice and other contaminants – flight procedures	96
FLIGHT IN EXPECTED OR ACTUAL ICING CONDITIONS	96
GM1-CAT.OP.AH.255 Ice and other contaminants – flight procedures.....	97
PROCEDURES - HELICOPTERS	97
GM1-CAT.OP.AH.270 Minimum flight altitudes.....	98
MINIMUM FLIGHT ALTITUDES.....	98
AMC1-CAT.OP.AH.281 In-flight fuel management - helicopters.....	102
COMPLEX MOTOR-POWERED HELICOPTERS, OTHER THAN LOCAL OPERATIONS	102
GM1-CAT.OP.AH.290 –Ground proximity detection	103
GUIDANCE MATERIAL FOR TERRAIN AWARENESS WARNING SYSTEM (TAWS)	
FLIGHT CREW TRAINING PROGRAMMES	103
GM1-CAT.OP.AH.295 Use of airborne collision avoidance system (ACAS II) ..	113
GENERAL	113
ACAS FLIGHT CREW TRAINING PROGRAMMES.....	113
GM1-CAT.OP.AH.300 Approach and landing conditions	125
IN-FLIGHT DETERMINATION OF THE LANDING DISTANCE.....	125
GM1-CAT.OP.AH.315 Flight hours reporting - helicopters.....	126
FLIGHT HOURS REPORTING	126

Subpart D | Revised rule text

[1]Annex I - Definitions for terms used in Annexes II – VI**SUBPART D
OPERATIONAL PROCEDURES****OPS 1.192 Terminology**

The terms which are listed below are for use within the context of this regulation.

(a) ~~'Adequate aAerodrome'~~ **means aAn** aerodrome which the operator considers to be satisfactory, **on which the aircraft can be operated**, taking account of the applicable performance requirements and runway characteristics; ~~at the expected time of use, the aerodrome will be available and equipped with necessary ancillary services such as ATS, sufficient lighting, communications, weather reporting, nav aids and emergency services.~~

Comment [WSI1]:
Deleted half sentence added into the rule text.

(b) ~~ETOPS (Extended Range Operations for two engine aeroplanes). ETOPS operations are those with two engine aeroplanes approved by the Authority (ETOPS approval), to operate beyond the threshold distance determined in accordance with OPS 1.245 (a) from an Adequate Aerodrome.~~

Comment [WSI2]:
The content will be transposed in SPA.ETOPS.

(c) ~~Adequate ETOPS en route alternate aerodrome. An adequate aerodrome, which additionally, at the expected time of use, has an ATC facility and at least one instrument approach procedure.~~

Comment [WSI3]:
Integrated in SPA.ETOPS.110

(d) ~~'En-rRoute aAlternate (ERA) aAerodrome'~~ **means aAn** adequate aerodrome along the route, which may be required at the planning stage.

(e) ~~3%'Fuel en-route alternate (fuel ERA)'~~ **means: aAn** en route alternate **ERA** aerodrome selected for the purposes of reducing contingency fuel ~~to 3%.~~

(f) ~~Isolated aerodrome. If acceptable to the Authority, the destination aerodrome can be considered as an isolated aerodrome, if the fuel required (diversion plus final) to the nearest adequate destination alternate aerodrome is more than:~~

Comment [WSI4]:
The content of this definition has been transferred to CAT.OP.AH.180.A (g)

~~For aeroplanes with reciprocating engines, fuel to fly for 45 minutes plus 15 % of the flight time planned to be spent at cruising level or two hours, whichever is less; or~~

~~For aeroplanes with turbine engines, fuel to fly for two hours at normal cruise consumption above the destination aerodrome, including final reserve fuel.~~

(g) ~~Equivalent Position. A position that can be established by means of a DME distance, a suitably located NDB or VOR, SRE or PAR fix or any other suitable fix between 3 and 5 miles from threshold that independently establishes the position of the aeroplane.~~

Comment [WSI5]:
Deleted as term no longer used

(h) ~~'Critical phases of flight' in the case of aeroplanes~~ **means** the take-off run, the take-off flight path, the final approach, **the missed approach,** the landing, including the landing roll, and any other phases of flight ~~at the discretion of~~ **as determined by the pilot-in-command or commander** ~~the commander.~~

Comment [WSI6]:
OPST Working Paper proposal.

'Critical phases of flight' in the case of helicopters means phases specified by the pilot-in-command or commander and included taxiing, hovering, take-off, final approach, missed approach and landing.

Subpart D | Revised rule text

(i) ~~'Contingency fFuel'~~ **means t**The fuel required to compensate for unforeseen factors which could have an influence on the fuel consumption to the destination aerodrome.

~~such as deviations of an individual aeroplane from the expected fuel consumption data, deviations from forecast meteorological conditions and deviations from planned routings and/or cruising levels/altitudes.~~

(j) ~~'Separate rRunways'~~ **means-R** runways at the same aerodrome that are separate landing surfaces. These runways may overlay or cross in such a way that if one of the runways is blocked, it will not prevent the planned type of operations on the other runway. Each runway shall have a separate approach procedure based on a separate navigation aid.

~~(k) Approved One Engine Inoperative Cruise Speed. For ETOPS, the approved one engine inoperative cruise speed for the intended area of operation shall be a speed, within the certified limits of the aeroplane, selected by the operator and approved by the regulatory authority.~~

Comment [WSI7]:
Not transposed, the rule covers the content.

~~(l) ETOPS Area. An ETOPS Area is an area containing airspace within which an ETOPS approved aeroplane remains in excess of the specified flying time in still air (in standard conditions) at the approved one engine inoperative cruise speed from an adequate ETOPS Route Alternate aerodrome.~~

Comment [WSI8]:
Not transposed, the rule covers the content.

~~(m) Dispatch. ETOPS planning minima applies until dispatch. Dispatch is when the aircraft first moves under its own power for the purpose of taking off.~~

'Local helicopter operation' **means a CAT operation of helicopters with a maximum certificated take-off mass (MCTOM) over 3 175 kg and a maximum approved passenger seating configuration (MPSC) of nine or less, by day, over routes navigated by reference to visual landmarks, conducted within a local and defined geographical area specified in the operations manual**

Comment [WSI9]:
This definition will permit alleviations from JAR-OPS 3.005(f) and (g).

Subpart D | Revised rule text

[2]Part-OR

Subpart OPS – Air Operations

SECTION I – GENERAL REQUIREMENTS

OR.OPS.GEN.105 ~~OPS 1.195~~Operational ControlOperator responsibilities

An operator shall:...

(c) An operator shall establish and maintain a system for exercising operational control over any flight operated under the terms of its declaration or certificate.

...~~(a) Establish and maintain a method of exercising operational control approved by the Authority; and~~

~~(b) Exercise operational control over any flight operated under the terms of his AOC.~~

~~OPS 1.200~~Operations manual

Comment [WSI10]:
Covered in OR.OPS.MLR.

~~An operator shall provide an Operations Manual in accordance with Subpart P for the use and guidance of operations personnel.~~

OR.OPS.GEN.1005 ~~OPS 1.205~~Competence of operations personnelOperator responsibilities

~~An operator shall ensure that all personnel assigned to, or directly involved in, ground and flight operations are properly instructed, have demonstrated their abilities in their particular duties and are aware of their responsibilities and the relationship of such duties to the operation as a whole...~~

(f) An operator shall establish procedures and instructions for the safe operation of each aircraft type, containing ground staff and crew member duties and responsibilities for all types of operation on the ground and in flight. These procedures shall not require crew members to perform any activities during critical phases of flight other than those required for the safe operation of the aircraft.

...

OR.OPS.GEN.105~~OPS 1.210~~Establishment of procedures Operator responsibilities

~~(a) An operator shall establish procedures and instructions, for each aeroplane type, containing ground staff and crew members' duties for all types of operation on the ground and in flight.~~

~~(b) An operator shall establish a check list system to be used by crew members for all phases of operation of the aeroplane under normal, abnormal and emergency conditions as applicable, to ensure that the operating procedures in the Operations Manual are followed.~~

Subpart D | Revised rule text

~~(c) An operator shall not require a crew member to perform any activities during critical phases of the flight other than those required for the safe operation of the aeroplane (see OPS 1.192)...~~

(h) An operator shall establish a checklist system for each aircraft type to be used by crew members in all phases of flight under normal, abnormal and emergency conditions to ensure that the operating procedures in the operations manual are followed. The design and utilisation of checklists shall observe human factor principles and take into account the latest relevant documentation from the aircraft manufacturer.

...

Subpart D | Revised rule text

[5]Part-CAT - IR

Subpart B – Operating procedures

Section I – Aeroplanes and helicopters

CAT.OP.AH.100 ~~OPS 1.215~~ Use of air traffic services

(a) ~~An operator~~**The operator** shall ensure that:

- (1) ~~a~~**Air t**raffic ~~S~~services **(ATS)** **appropriate to the airspace and the applicable rules of the air** requirements are used for all flights whenever available;-

Comment [WSI11]:
Text changed on the basis of comments received.

~~OPS 1.216~~In flight operational instructions

- (2) ~~An operator shall ensure that in-flight operational instructions involving a change to the air traffic flight plan shall, when practicable, be~~**are** coordinated with the appropriate **ATS unit** ~~Air Traffic Service Unit~~ before transmission to an **aircraft**.~~aeroplane.~~

(b) Notwithstanding (a), ~~For VFR operations of single engine aeroplanes by day, non-mandatory contact with ATS shall be maintained to the extent appropriate to the nature of the operation~~

Comment [WSI12]:
Inclusion of alleviation in Appendix 1 to OPS 1.005 7.

Formatted: N (a)

the use of ATS is not required unless mandated by air space requirements for:-

- (1) **visual flight rules (VFR) day operations of other-than-complex motor-powered aeroplanes;**
- (2) **helicopters with a maximum certificated take-off mass (MCTOM) of 3 175 kg or less operated by day and over routes navigated by reference to visual landmarks; or**
- (3) **local helicopter operations, provided that search and rescue service arrangements can be maintained.**

CAT.OP.AH.105 ~~OPS 1.220~~ Authorisation Use of aerodromes and operating sites~~by the Operator~~

~~(See OPS 1.192)~~

(a) ~~An operator~~**The operator** shall only ~~authorise use of~~ aerodromes that are adequate for the type(s) of **aircraft**~~aeroplane~~ and operation(s) concerned.

(b) The operator may also use operating sites that are adequate for the type(s) of aircraft and operation(s) concerned for

Comment [WSI13]:
Text added to align with content of JAR-OPS 3

- (1) **other--than--complex motor-powered aeroplanes; and**
- (2) **helicopters.**

Subpart D | Revised rule text

CAT.OP.AH.106 Use of isolated aerodromes - aeroplanes

- (a) **Using an isolated aerodrome as destination aerodrome with aeroplanes requires the prior approval of the competent authority.**
- (b) **An isolated aerodrome is one for which the alternate and final fuel reserve required to the nearest adequate destination alternate aerodrome is more than:**
- (1) **for aeroplanes with reciprocating engines, fuel to fly for 45 minutes plus 15 % of the flight time planned to be spent at cruising level or two hours, whichever is less; or**
 - (2) **for aeroplanes with turbine engines, fuel to fly for two hours at normal cruise consumption above the destination aerodrome, including final reserve fuel.**

Comment [WSI14]:
Due to safety considerations and based on the recommendation of the RG01.

~~OPS 1.225~~ Aerodrome operating minima

- ~~(a) An operator shall specify aerodrome operating minima, established in accordance with OPS 1.430 for each departure, destination or alternate aerodrome authorised to be used in accordance with OPS 1.220.~~
- ~~(b) Any increment imposed by the Authority must be added to the minima specified in accordance with subparagraph (a) above.~~
- ~~(c) The minima for a specific type of approach and landing procedure are **be** considered applicable :~~
- ~~(1) The ground equipment shown on the respective chart required for the intended procedure is operative;~~
 - ~~(2) The aeroplane systems required for the type of approach are operative;~~
 - ~~(3) The required aeroplane performance criteria are met; and~~
 - ~~(4) Crew is qualified accordingly.~~

Comment [WSI15]:
Merged with OPS 1.430 in a new CAT.OP.AH.110.

CAT.OP.AH.125 ~~OPS 1.230~~ Instrument departure and approach procedures

- (a) ~~An operator~~ **The operator** shall ensure that instrument departure and approach procedures established by the State in which the aerodrome is located are used.
- (b) Notwithstanding ~~subparagraph (a) above,~~ **a** ~~the~~ commander may accept an **air traffic control (ATC)** clearance to deviate from a published departure or arrival route, provided obstacle clearance criteria are observed and full account is taken of the operating conditions. **In any case, the** final approach **shall** ~~must~~ be flown visually or in accordance with the established instrument approach procedures.
- (c) **Notwithstanding (a) above, the operator may use** ~~Different procedures to~~ **other than** those required to be used in accordance with ~~subparagraph~~ **referred to in** (a) above ~~may only be implemented by an operator provided they have been approved by the State in which the aerodrome is located, if required, and accepted by the Authority.~~ **and are specified in the operations manual.**

Subpart D | Revised rule text

CAT.OP.AH.130 OPS 1.235 Noise abatement procedures~~(See OPS 1.192)~~**(a) Aeroplanes**

Except for VFR operations of other-than-complex motor-powered aeroplanes, ~~the~~ operator shall establish appropriate operating departure and arrival/approach procedures for each aircraft ~~aircraft~~ type in accordance with the following: **taking into account the need to minimize the effect of aircraft noise.**

Comment [WSI16]:
The added text better clarifies the intent of the rule.

(a) ~~The operator~~ procedures shall:

ensure that

(1) **ensure that** safety has priority over noise abatement; and(b2) ~~These procedures shall be designed~~ be simple and safe to operate with no significant increase in crew workload during critical phases of flight, and**(b) Helicopters**

The operator shall ensure that take-off and landing procedures take into account the need to minimise the effect of helicopter noise.

[AMC/GM CAT.OP]**AMC1-CAT.OP.AH.130 Noise abatement procedures****NDAP DESIGN - AEROPLANES**

1. ~~(c)~~ For each aeroplane type two departure procedures ~~should~~ shall be defined, in accordance with ICAO Doc. 8168 (Procedures for Air Navigation Services, "PANS-OPS"), Volume I:

a. ~~(1)~~ **nNoise aAbatement dDeparture pProcedure oOne** (NADP 1), designed to meet the close-in noise abatement objective; and

b. ~~(2)~~ **nNoise aAbatement dDeparture pProcedure tTwo** (NADP 2), designed to meet the distant noise abatement objective; and.

2. ~~(3)~~ **In addition, each NADP climb profile can only have one sequence of actions. For each type of NADP (1 and 2), a single climb profile should be specified for use at all aerodromes, which is associated with a single sequence of actions. The NADP 1 and NADP2 profiles may be identical.**

Comment [WSI17]:
Rule source: JAA NPA-OPS 53

[IR CAT.OP]**CAT.OP.AH.135 OPS 1.240 Routes and areas of operation - general**

(a) ~~An operator~~ **The operator** shall ensure that operations are only conducted along such routes, or within such areas, for which:

Subpart D | Revised rule text

- (1) ~~g~~Ground facilities and services, including meteorological services, ~~are provided which are adequate for the planned operation,~~ **are provided;**
- (2) ~~t~~The performance of the **aircraft** ~~aeroplane~~intended to be used is adequate to comply with minimum flight altitude requirements;
- (3) ~~T~~the equipment of the **aircraft** ~~aeroplane~~intended to be used meets the minimum requirements for the planned operation; **and**
- (4) ~~a~~Appropriate maps and charts are available. ~~;(OPS 1.135 (a)(9) refers);~~
- ~~(5) If two engine aeroplanes are used, adequate aerodromes are available within the time/distance limitations of OPS 1.245;~~
- ~~(6) If single engine aeroplanes are used, surfaces are available which permit a safe forced landing to be executed.~~
- (b) ~~An operator~~**The operator** shall ensure that operations are conducted in accordance with any restriction on the routes or the areas of operation, ~~imposed~~**specified** by the **competent Authority**~~authority~~.
- (c) **(a)(1) above, shall not apply to VFR day operations of other than complex-motor powered aircraft on flights that depart from and arrive at the same aerodrome or operating site.**

Comment [WSI18]:
Deleted because the content is already covered in CAT.OP.AH.140.

Comment [WSI19]:
Moved to CAT.OP.AH.135.A

CAT.OP.AH.136 Routes and areas of operation - single-engine aeroplanes

The operator shall ensure that operations of single-engine aeroplanes are only conducted along routes, or within areas, where surfaces are available which permit a safe forced landing to be executed.

CAT.OP.AH.137 Routes and areas of operation - helicopters

The operator shall ensure that:

- (a) **for helicopters operated in performance class 3, surfaces are available which permit a safe forced landing to be executed, except when the helicopter has an approval to operate in accordance with CAT.POL.H.420;**
- (b) **for helicopters operated in performance class 3 and conducting 'coastal transit' operations, the operations manual contains procedures to ensure that the width of the coastal corridor, and the equipment carried, is consistent with the conditions prevailing at the time.**

Subpart D | Revised rule text

[3]Part-SPA

Subpart D - Operations in airspace with reduced vertical separation minima

~~OPS 1.241 Operation in defined airspace with Reduced Vertical Separation Minima (RVSM)~~

Comment [WSI20]:
Transposed in SPA.RVSM.100

~~An operator shall not operate an aeroplane in defined portions of airspace where, based on Regional Air Navigation Agreement, a vertical separation minimum of 300 m (1 000 ft) applies unless approved to do so by the Authority (RVSM Approval). (See also OPS 1.872).~~

SPA.RVSM.100 RVSM operations

An aircraft shall only be operated in designated airspace where a reduced vertical separation minimum of 300 m (1 000 ft) applies between flight level (FL) 290 and FL 410, inclusive, if the operator has been granted an approval by the competent authority to conduct such operations.

...

Subpart C – Operations with specified minimum navigation performance

~~OPS 1.243 Operation in areas with specified navigation performance requirements~~

Comment [WSI21]:
Transposed in SPA.MNPS.100, 105 (e).

- ~~(a) An operator shall ensure that an aeroplane operated in areas, or through portions of airspace, or on routes where navigation performance requirements have been specified, is certified according to these requirements, and, if required, that the Authority has granted the relevant operational approval. (See also OPS 1.865 (c)(2), OPS 1.870 and OPS 1.872).~~
- ~~(b) An operator of an aeroplane operating in (a) shall ensure that all contingency procedures, specified by the authority responsible for the airspace concerned, have been included in the Operations Manual.~~

SPA.MNPS.100 MNPS operations

An aircraft shall only be operated in designated Minimum Navigation Performance Specifications (MNPS) airspace in accordance with Regional Supplementary Procedures, where minimum navigation performance specifications are established, if the operator has been granted an approval by the competent authority to conduct such operations.

SPA.MNPS.105 MNPS operational approval

To obtain an MNPS operational approval from the competent authority, the operator shall provide evidence that:

Subpart D | Revised rule text

- (a) the navigation equipment meets the required performance;**
- (b) navigation display, indicators and controls are visible and operable by either pilot seated at his/her duty station;**
- (c) a training programme for the flight crew involved in these operations has been established; and**
- (d) operating procedures have been established specifying**
 - (1) the equipment to be carried, including its operating limitations and appropriate entries in the Minimum Equipment List (MEL);**
 - (2) flight crew composition and experience requirements;**
 - (3) normal procedures;**
 - (4) contingency procedures including those specified by the authority responsible for the airspace concerned; and**
 - (5) monitoring and incident reporting.**

Subpart D | Revised rule text

[6]Part-CAT - IR

[IR CAT.OP]

CAT.OP.AH.140~~OPS 1.245~~ Maximum distance from an adequate aerodrome for two-engined aeroplanes without an ETOPS approval

(See OPS 1.192)

- (a) Unless specifically approved by the **competent Authority** in accordance with **SPA.ETOPS OPS 1.246 (a)** (ETOPS approval), ~~an operator~~ **the operator** shall not operate a two-engined aeroplane over a route ~~which~~ **that** contains a point further from an adequate aerodrome, ~~(under standard conditions in still air,)~~ than, ~~in the case of:~~
- (1) **for p**Performance **c**Class A aeroplanes with either:
 - (i) ~~a~~ **A** maximum ~~approved~~ passenger seating configuration of 20 or more; or
 - (ii) ~~a~~ **A** maximum take-off mass of 45 360 kg or more,
 the distance flown in 60 minutes at the one-engine-inoperative (**OEI**) **cruising** speed determined in accordance with ~~subparagraph~~ (b) below;
 - (2) **for p**Performance **c**Class A aeroplanes with:
 - (i) ~~A~~ **A** maximum ~~approved~~ passenger seating configuration of 19 or less; and
 - (ii) ~~a~~ **A** maximum take-off mass less than 45 360 kg,
 the distance flown in 120 minutes or, **subject to approval** if approved by the **competent authority**, up to 180 minutes for turbo-jet aeroplanes, at the ~~one engine inoperative~~ **OEI** cruise speed determined in accordance with ~~subparagraph~~ (b) below;
 - (3) **for p**Performance **c**Class B or C aeroplanes:
 - (i) ~~t~~ The distance flown in 120 minutes at the ~~one engine inoperative~~ **OEI** cruise speed determined in accordance with ~~subparagraph~~ (b) below; or
 - (ii) 300 ~~nautical miles~~ **NM**, whichever is less.
- (b) ~~An operator~~ **The operator** shall determine a speed for the calculation of the maximum distance to an adequate aerodrome for each two-engined aeroplane type or variant operated, not exceeding V_{MO} (**maximum operating speed**), based upon the true airspeed that the aeroplane can maintain with ~~one engine inoperative~~ **one engine inoperative**.
- (c) ~~An operator~~ **The operator** ~~must~~ **shall** ensure that ~~include~~ the following data, specific to each type or variant, ~~is included in the Operations Manual~~ **operations manual**:
- (1) ~~t~~ The **determined** ~~one engine inoperative~~ **OEI** ~~cruise speed~~ **cruising speed** determined in accordance with ~~subparagraph (b) above~~; and

Subpart D | Revised rule text

(2) ~~t~~The **determined** maximum distance from an adequate aerodrome ~~determined in accordance with subparagraphs (a) and (b) above.~~

(d) To obtain the approval referred to in (a)(2) above, the operator shall provide evidence that:

Comment [WSI22]:
The criteria for the approval have been added for legal reasons.

(1) the aeroplane / engine combination holds an extended range twin-engine operations (ETOPS) type design and reliability approval for the intended operation;

(2) a set of conditions has been implemented to ensure that the aeroplane and its engines are maintained to meet the necessary reliability criteria; and

(3) the flight crew and all other operations personnel involved are trained and suitably qualified to conduct the intended operation.

(e) An aerodrome shall be considered adequate if, at the expected time of use, the aerodrome is available and equipped with necessary ancillary services such as air traffic services (ATS), sufficient lighting, communications, weather reporting, navigation aids and emergency services.

[AMC/GM CAT.OP]

GM1-CAT.OP.AH.140 Maximum distance from an adequate aerodrome for two-engined aeroplanes without an ETOPS approval

ONE-ENGINE-INOPERATIVE (OEI) CRUISING SPEED

~~Note:—The OEI speed~~**crising speeds**~~specified above are~~ **is** only intended to be used **solely** for establishing the maximum distance from an adequate aerodrome.

Subpart D | Revised rule text

[4]Part-SPA

Subpart F - Extended range operations with two-engined aeroplanes

~~OPS 1.246~~ Extended range operations with two-engined aeroplanes (ETOPS)

~~(See OPS 1.192)~~

- ~~(a) An operator shall not conduct operations beyond the threshold distance determined in accordance with OPS 1.245 unless approved to do so by the Authority (ETOPS approval).~~
- ~~(b) Prior to conducting an ETOPS flight, an operator shall ensure that an adequate ETOPS en route alternate is available, within either the operator's approved diversion time, or a diversion time based on the MEL generated serviceability status of the aeroplane, whichever is shorter. (See also OPS 1.297 (d)).~~

Comment [WSI23]:
Moved to SPA.ETOPS

Formatted: N (a)

SPA.ETOPS.100.A ETOPS

In a commercial air transport operation, a two-engined aeroplane shall only be operated over a route which contains a position further from an adequate aerodrome which is greater than the threshold distance determined in accordance with CAT.OP.AH.140, if the operator has been granted an ETOPS approval by the competent authority.

SPA.ETOPS.105.A ETOPS operational approval

To obtain an ETOPS operational approval from the competent authority, the operator shall provide evidence that

- (a) the aeroplane / engine combination holds an ETOPS Type Design and Reliability approval for the intended operation;**
- (b) a training programme for the flight crew and all other operations personnel involved in these operations has been established and the flight crew all other operations personnel involved are suitably qualified to conduct the intended operation;**
- (c) the operator's organisation and experience are appropriate to support the intended operation;**
- (d) operating procedures have been established.**

SPA.ETOPS.110.A ETOPS en-route alternate

- (a) An ETOPS en-route alternate aerodrome shall be considered adequate, if, at the expected time of use, the aerodrome is available and equipped with necessary ancillary services such as air traffic services (ATS), sufficient lighting, communications, weather reporting, navigation aids and emergency services and has at least one instrument approach procedure available.**

Subpart D | Revised rule text

- (b) Prior to conducting an ETOPS flight, an operator shall ensure that an ETOPS en-route alternate is available, within either the operator's approved diversion time, or a diversion time based on the MEL-generated serviceability status of the aeroplane, whichever is shorter.**

Subpart D | Revised rule text

[7]Part-CAT**[IR CAT.OP]****CAT.OP.AH.145~~OPS 1.250~~ Establishment of minimum flight altitudes**

- (a) ~~An operator~~**The operator** shall establish ~~minimum flight altitudes and the methods to determine those altitudes~~ for all route segments to be flown:
- (1) minimum flight altitudes** ~~which that~~ provide the required terrain clearance, taking into account the requirements of ~~Subparts F to~~ **ICAT.POL; and**
 - (2) a method to determine those altitudes.**
- (b) ~~Every~~**The** method for establishing minimum flight altitudes ~~must~~**shall** be approved by the ~~competent Authority~~**authority**.
- (c) Where **the** minimum flight altitudes established by **the operator and a** States overflown ~~differ~~**are higher than those established by the operator**, the higher values shall apply.

[AMC/GM CAT.OP]**AMC1-CAT.OP.AH.145(a) Establishment of minimum flight altitudes****CONSIDERATIONS FOR ESTABLISHING MINIMUM FLIGHT ALTITUDES**

- 1.**~~(d) An operator~~**The operator should** ~~shall~~ take into account the following factors when establishing minimum flight altitudes:
- a.**~~(1) t~~The accuracy with which the position of the ~~aircraft~~**aeroplane** can be determined;
 - b.**~~(2) t~~The probable inaccuracies in the indications of the altimeters used;
 - c.**~~(3) t~~The characteristics of the terrain, **such as** ~~(e.g. sudden changes in the elevation)~~, along the routes or in the areas where operations are to be conducted;
 - d.**~~(4) t~~The probability of encountering unfavourable meteorological conditions, **such as** ~~(e.g. severe turbulence and descending air currents)~~; and
 - e.**~~(5) p~~Possible inaccuracies in aeronautical charts.
- 2.**~~(e) In fulfilling the requirements prescribed in subparagraph (d) above due consideration shall be given to~~**The operator should also consider:**
- a.**~~(1) c~~Corrections for temperature and pressure variations from standard values;
 - b.**~~(2) t~~The ATC requirements; and
 - c.**~~(3) a~~Any foreseeable contingencies along the planned route.

Subpart D | Revised rule text

VFR OPERATIONS OF OTHER-THAN-COMPLEX MOTOR-POWERED AIRCRAFT BY DAY

- 3. For VFR operations of other-than-complex motor-powered aircraft by day, the safety objective should be satisfied if the operator ensures that operations are only conducted along such routes or within such areas for which a safe terrain clearance can be maintained and take account of such factors as temperature, terrain and, unfavourable meteorological conditions.**

Comment [WSI24]:
Inclusion of alleviation from Appendix 1 to OPS 1.005(a) 11.

[IR CAT.OP]**CAT.OP.AH.150~~OPS 1.255~~ Fuel policy**

~~(See Appendix 1 and Appendix 2 to OPS 1.255)~~

- (a) ~~An operator~~**The operator shall** must establish a fuel policy for the purpose of flight planning and in-flight ~~re-planning~~**replanning** to ensure that every flight carries sufficient fuel for the planned operation and reserves to cover deviations from the planned operation. **The fuel policy and any change to it require a prior approval of the competent authority.**
- (b) ~~An operator~~**The operator** shall ensure that the planning of flights is ~~at least~~ based upon **at least** ~~(1) and (2)~~ below:
- (1) procedures contained in the ~~Operations Manual~~**operations manual** and **data derived from** ~~data derived from~~:
 - (i) ~~d~~**Data** provided by the ~~aeroplane~~**aircraft** manufacturer; or
 - (ii) ~~c~~**Current** ~~aeroplane~~**aircraft**-specific data derived from a fuel consumption monitoring system;
 - (2) the operating conditions under which the flight is to be conducted including:
 - (i) ~~Realistic~~ ~~aeroplane~~**aircraft** fuel consumption data;
 - (ii) ~~a~~**Anticipated** masses;
 - (iii) ~~e~~**Expected** meteorological conditions; and
 - (iv) ~~a~~**Air** ~~n~~**Navigation** ~~s~~**Services** ~~p~~**Provider(s)** procedures and restrictions.
- (c) ~~An operator~~**The operator** shall ensure that the pre-flight calculation of usable fuel required for a flight includes:
- (1) taxi fuel; ~~and~~
 - (2) trip fuel; ~~and~~
 - (3) reserve fuel consisting of:
 - (i) contingency fuel~~(see OPS 1.192); and~~
 - (ii) alternate fuel, if a destination alternate aerodrome is required. ~~(This does not preclude selection of the departure aerodrome as the destination alternate aerodrome); and~~
 - (iii) final reserve fuel; ~~and~~

Comment [WSI25]:
Is transposed as a GM1 to this rule.

Subpart D | Revised rule text

- (iv) additional fuel, if required by the type of operation ~~(e.g. ETOPS)~~; and
 - (4) extra fuel if required by the commander.
- (d) ~~An operator~~**The operator** shall ensure that in-flight ~~re-planning~~**replanning** procedures for calculating usable fuel required when a flight has to proceed along a route or to a destination aerodrome other than originally planned includes:
- (1) trip fuel for the remainder of the flight; and
 - (2) reserve fuel consisting of:
 - (i) contingency fuel; and
 - (ii) alternate fuel, if a destination alternate aerodrome is required ~~(This does not preclude selection of the departure aerodrome as the destination alternate aerodrome)~~; and
 - (iii) final reserve fuel; and
 - (iv) additional fuel, if required by the type of operation ~~(e.g. ETOPS)~~; and
 - (3) extra fuel if required by the commander.

CAT.OP.AH.151 Fuel policy - alleviations**Notwithstanding CAT.OP.AH.150, (b) to (d),****(a) for operations of performance class B aeroplanes:**

- (1) for **flights that depart from and arrive at the same aerodrome or operating site**, ~~A to A Flights~~ ~~An operator~~**the operator** shall specify the minimum fuel contents at which a flight ~~must~~**shall** end. This minimum final reserve fuel ~~must~~**shall** not be less than the amount needed to fly for a period of 45 minutes.
- (2) for **other A to B Flights**, ~~An operator~~**the operator** shall ensure that the pre-flight calculation of usable fuel required for a flight includes:
 - (A) taxi fuel ~~Fuel consumed before take-off~~, if significant; and
 - (B) trip fuel ~~(Fuel to reach the destination)~~; and
 - (C) reserve fuel, **consisting of:**
 - (A) ~~c~~**1.** ~~contingency fuel~~ ~~Fuel that is not less than 5% of the planned trip fuel or, in the event of in-flight re-planning~~**replanning**, 5% of the trip fuel for the remainder of the flight; and
 - (B) ~~f~~**2.** ~~inal reserve fuel~~ ~~Fuel to fly for an additional period of 45 minutes for (reciprocating piston engines) or 30 minutes for (turbine engines)~~; and
 - (D) alternate fuel ~~Fuel to reach the destination alternate aerodrome via the destination, if a destination alternate aerodrome is required~~; and
 - (E) extra fuel, **if specified by** ~~Fuel that the commander may require in addition to that required under subparagraphs (A) to (D) above.~~

Subpart D | Revised rule text

- (b) for helicopters with a maximum certificated take-off mass (MCTOM) of 3 175 kg or less, by day and over routes navigated by reference to visual landmarks or local helicopter operations, the fuel policy shall ensure that, on completion of the flight, or series of flights the fuel reserve fuel is not less than an amount sufficient for:
- (1) 30 minutes flying time at normal cruising; or
 - (2) 20 minutes flying time at normal cruising when operating within an area providing continuous and suitable precautionary landing sites.

~~OPS 1.260~~ **Carriage of Persons with Reduced Mobility**

- (a) An operator shall establish procedures for the carriage of Persons with Reduced Mobility (PRMs).
- (b) An operator shall ensure that PRMs are not allocated, nor occupy, seats where their presence could:
- (1) Impede the crew in their duties;
 - (2) Obstruct access to emergency equipment; or
 - (3) Impede the emergency evacuation of the aeroplane.
- (c) The commander must be notified when PRMs are to be carried on board.

Comment [WSI26]:
Deleted because the content is proposed to be included in CAT.OP.AH.155.

Formatted: Normal

~~CAT.OP.AH.155~~ ~~OPS 1.265~~ **Carriage of special categories of passengers (SCPs) inadmissible passengers, deportees or persons in custody**

An operator shall establish procedures for the transportation of inadmissible passengers, deportees or persons in custody to ensure the safety of the aeroplane and its occupants. The commander must be notified when the above mentioned persons are to be carried on board.

- (a) **Special categories of passengers (SCPs) requiring special assistance, conditions or devices shall be carried under conditions that ensure the safety of the aircraft and its occupants according to procedures established by the operator.**
- (b) **SCPs shall not be allocated, nor occupy, seats that permit direct access to emergency exits or where their presence could:**
- (1) impede the crew in their duties;
 - (2) obstruct access to emergency equipment; or
 - (3) impede the emergency evacuation of the aircraft.
- (c) **The commander shall be notified in advance when SCPs are to be carried on board.**

Comment [WSI27]:
Inclusion of alleviation from Appendix 1 to OPS 1.005 13. and 15. have not been taken into account because it is considered that with the redrafting these alleviations are not necessary.

Comment [WSI28]:
(JAR) ACJ OPS 1.280 (b)

~~CAT.OP.AH.160~~ ~~OPS 1.270~~ **Stowage of baggage and cargo**

(See Appendix 1 to OPS 1.270)

- (a) ~~An operator~~ **The operator** shall establish procedures to ensure that:

Subpart D | Revised rule text

- (a) only such hand baggage **that can be adequately and securely stowed** is taken into the passenger cabin; ~~and as can be adequately and securely stowed.~~
- (b) ~~An operator shall establish procedures to ensure that all baggage and cargo on board, which might cause injury or damage, or obstruct aisles and exits if displaced, is~~ **stowed so as** ~~placed in stowages designed to prevent movement.~~

Comment [WSI29]:
This text is more restrictive than that for helicopters because it implies stowage areas; consider using the helicopter text: "is stowed so as to prevent"

~~OPS 1.275~~ Intentionally blank~~CAT.OP.AH.165~~ ~~OPS 1.280~~ Passenger sSeating

~~An operator~~ **The operator** shall establish procedures to ensure that passengers are seated where, in the event that an emergency evacuation is required, they may best assist and not hinder evacuation from the **aircraft. ~~aeroplane.~~**

Comment [WSI30]:
Alleviation from Appendix 1 to OPS 1.005 14.

"Except for FR operations of single engine other than complex motor-powered aircraft"

has not been considered.

~~CAT.OP.AH.170~~ ~~OPS 1.285~~ Passenger briefing

~~An operator~~ **The operator** shall ensure that:

÷

- (a) ~~General(1)~~ ~~Passengers are given a verbal briefings and demonstrations relating to about safety matters in a form that facilitates their application in the event of an emergency. Parts or all of the briefing may be provided by an audio visual presentation;~~ **and**
- (b) ~~(2)~~ ~~Passengers~~ **passengers** are provided with a safety briefing card on which picture type instructions indicate the operation of emergency equipment and exits likely to be used by passengers.

[AMC/GM CAT.OP]**AMC1-CAT.OP.AH.170 Passenger briefing****PASSENGER BRIEFING****Passenger briefings should contain the following:****1.** ~~(b)~~ Before take-off

~~a.(1)~~ **p**Passengers are **should be** briefed on the following items if applicable:

- ~~i.(i)~~ **s**Smoking regulations;
- ~~ii.(ii)~~ **b**Back of the seat to be in the upright position and tray table stowed;
- ~~iii.(iii)~~ **l**ocation of emergency exits;
- ~~iv.(iv)~~ **l**ocation and use of floor proximity escape path markings;
- ~~v.(v)~~ **s**Stowage of hand baggage;
- ~~vi.(vi)~~ **r**estrictions on the use of portable electronic devices; and

Subpart D | Revised rule text

~~vii.(vii)~~ **t**The location and the contents of the safety briefing card;~~;~~

and;

~~b.(2)~~**p**Passengers **should** receive a demonstration of the following:

- ~~i.(i)~~ **t**The use of safety belts ~~and/or~~ safety harnesses, including how to fasten and unfasten the safety belts ~~and/or~~ safety harnesses;
- ~~ii.(ii)~~ **t**The location and use of oxygen equipment, if required,~~(OPS 1.770 and OPS 1.775 refer)~~. Passengers ~~must~~ **should** also be briefed to extinguish all smoking materials when oxygen is being used; and
- ~~iii.(iii)~~ **t**The location and use of life--jackets, if required. ~~(OPS 1.825 refers)~~.

~~2.(e)~~ After take-off

~~a.(1)~~**p**Passengers ~~are~~ **should be** reminded of the following, if applicable:

- ~~i.(i)~~ **s**Smoking regulations; and
- ~~ii.(ii)~~ **u**Use of safety belts ~~and/or~~ safety harnesses including the safety benefits of having safety belts fastened when seated irrespective of seat belt sign illumination.

~~3.(d)~~ Before landing

~~a.(1)~~**p**Passengers ~~are~~ **should be** reminded of the following, if applicable:

- ~~i.(i)~~ **s**Smoking regulations;
- ~~ii.(ii)~~ **u**Use of safety belts ~~and/or~~ safety harnesses;
- ~~iii.(iii)~~ **b**Back of the seat to be in the upright position and tray table stowed;
- ~~iv.(iv)~~ **r**Re-stowage of hand baggage; and
- ~~v.(v)~~ **r**Restrictions on the use of portable electronic devices.

~~4.(e)~~ After landing

~~a.(1)~~**p**Passengers ~~are~~ **should be** reminded of the following:

- ~~i.(i)~~ **s**Smoking regulations; and
- ~~ii.(ii)~~ **u**Use of safety belts and/or safety harnesses.

TRAINING PROGRAMME

- 1. The operator may replace the briefing/demonstration with a passenger training programme covering all safety and emergency procedures for a given type of aircraft.**
- 2. Only passengers who have been trained according to this programme and have flown on the aircraft type within the last 90 days may be carried on board without receiving a briefing/demonstration.**

Comment [WSI31]:
Added to provide further flexibility to briefing.

~~(f)~~ In an emergency during flight, passengers are instructed in such emergency action as may be appropriate to the circumstances.

Comment [WSI32]:
Deleted because it is mentioned in the ER.

Subpart D | Revised rule text

[IR CAT.OP]**CAT.OP.AH.175~~OPS 1.290~~ Flight preparation**

- (a) ~~An operator shall ensure that a~~An operational flight plan **shall be** ~~is~~ completed for each intended flight **based on considerations of aircraft performance, other operating limitations and relevant expected conditions on the route to be followed and at the aerodromes/operating sites concerned.**
- (b) ~~A~~**The** flight shall not be commenced unless the commander is satisfied that:
- (1) all items stipulated in 2.a.3 of Annex IV to Regulation (EC) No. 216/2008 can be complied with;**
- ~~(1) The aeroplane is airworthy;~~
- (2) the ~~aeroplane~~**aircraft** is not operated contrary to the provision of the ~~c~~Configuration ~~d~~Deviation ~~I~~List (CDL);
- ~~(3) The instruments and equipment required for the flight to be conducted, in accordance with Subparts K and L, are available;~~
- ~~(4) The instruments and equipment are in operable condition except as provided in the MEL;~~
- ~~(53) these parts of the operations manual which~~**that** are required for the conduct of the flight are available;
- ~~(64) the documents, additional information and forms required to be available by CAT.GEN.180 OPS 1.125 and OPS 1.135 are on board;~~
- ~~(75) current maps, charts and associated documentation or equivalent data are available to cover the intended operation of the aeroplane~~**aircraft** including any diversion ~~which~~**that** may reasonably be expected. ~~This shall include any conversion tables necessary to support operations where metric heights, altitudes and flight levels must be used;~~
- ~~(86) ground facilities and services required for the planned flight are available and adequate;~~
- (97) the provisions specified in the operations manual in respect of fuel, oil, ~~and oxygen requirements~~, minimum safe altitudes, aerodrome operating minima, and availability of alternate aerodromes, where required, can be complied with for the planned flight; **and**
- ~~(10) The load is properly distributed and safely secured;~~
- ~~(11) The mass of the aeroplane, at the commencement of take-off roll, will be such that the flight can be conducted in compliance with Subparts F to I as applicable; and~~
- ~~(128) any~~ **additional** operational limitation in addition to those covered by subparagraphs ~~(9) and (11) above~~ can be complied with.

Comment [WSI33]:
 Moved to GM1-CAT.OP.AH.175(b)(7)
 Flight preparation.

Subpart D | Revised rule text

(c) **Notwithstanding (a) above, an operational flight plan is not required for:**

- (1) **VFR operations of other-than-complex motor-powered aircraft taking off and landing at the same aerodrome or operating site within 24 hours; or**
- (2) **helicopters with a maximum certificated take-off mass (MCTOM) of 3 175 kg or less, by day and over routes navigated by reference to visual landmarks in a local area.**

CAT.OP.AH.180OPS 1.295 Selection of aerodromes - aeroplanes

(a) ~~An operator shall establish procedures for the selection of destination and/or alternate aerodromes in accordance with OPS 1.220 when planning a flight.~~

Comment [WSI34]:
General requirement to establish procedures. The safety objective is not to have procedures but the safety objective relates to how and which aerodromes should be selected.

(ba) ~~An operator select in the operational flight plan a take off alternate aerodrome if it would not~~ **Where it is not** ~~be possible to use return to the departure aerodrome as a take-off alternate aerodrome due to~~ **for meteorological or performance reasons, the operator shall select another adequate take-off alternate aerodrome, which is no further from** ~~. The take off alternate aerodrome, in relation to the departure aerodrome than, shall be located within:~~

(1) ~~f~~ **For two-engined aeroplanes, either:**

- (i) ~~o~~ **One hour flight time at an one engine inoperative OEI** ~~OEI~~ **cruising speed according to the aircraft flight manual (Aircraft Flight Manual (AFM))** ~~in still air standard conditions based on the actual take-off mass; or~~
- (ii) ~~t~~ **The operator's approved ETOPS diversion time approved in accordance with SPA.ETOPS, subject to any minimum equipment list (MEL) restriction, up to a maximum of two hours, at the one-engine inoperative OEI** ~~OEI~~ **cruising speed according to the AFM in still air standard conditions based on the actual take-off mass for aeroplanes and crews authorised for ETOPS; or**

Comment [WSI35]:
Already defined in SPA.ETOPS.

(2) **for three and four-engined aeroplanes, t** ~~Two hours flight time at a the one engine inoperative OEI~~ **cruising speed according to the AFM in still air standard conditions based on the actual take-off mass for three and four-engined aeroplanes.**

and

(3) ~~If the AFM does not contain an one engine inoperative OEI~~ **OEI** ~~cruising speed, the speed to be used for calculation must~~ **shall** ~~be that which is achieved with the remaining engine(s) set at maximum continuous power.~~

(be) ~~An operator~~ **The operator must shall** ~~select at least one destination alternate aerodrome for each instrument flight rules (IFR) flight unless the destination aerodrome is an isolated aerodrome or:~~

~~(1) Both:~~

- (1i) ~~t~~ **The duration of the planned flight from take-off to landing or, in the event of in-flight re-planning replanning** ~~replanning~~ **in accordance with CAT.OP.AH.150(d) OPS 1.255(d), the remaining flying time to destination does not exceed six hours; ;** and

Subpart D | Revised rule text

~~(2#) t~~Two separate runways ~~(see OPS 1.192)~~are available and usable at the destination aerodrome and the appropriate weather reports **and/or** forecasts for the destination aerodrome, ~~or any combination thereof,~~ indicate that, for the period from one hour before until one hour after the expected time of arrival at the destination aerodrome, the ceiling will be at least 2 000 ft or circling height +500 ft, whichever is greater, and the **ground** visibility will be at least 5 km.†

or

~~(2) The destination aerodrome is isolated.~~

~~(cd) An operator~~**The operator must shall** select two destination alternate aerodromes when:

(1) ~~t~~The appropriate weather reports **and/or** forecasts for the destination aerodrome, ~~or any combination thereof,~~ indicate that during a period commencing one hour before and ending one hour after the estimated time of arrival, the weather conditions will be below the applicable planning minima ~~(see OPS 1.297(b)-);~~ or

(2) ~~n~~No meteorological information is available.

~~(de) An operator~~**The operator** shall specify any required alternate aerodrome(s) in the operational flight plan.

CAT.OP.AH.181 Selection of aerodromes and operating sites - helicopters

(a) For flights under instrument meteorological conditions (IMC), the commander shall select a take-off alternate aerodrome within one hour flight time at normal cruising speed if it would not be possible to return to the site of departure due to meteorological reasons.

(b) For IFR flights or when flying VFR and navigating by means other than by reference to visual landmarks, the commander shall specify at least one destination alternate aerodrome in the operational flight plan unless:

(1) the destination is a coastal aerodrome and the helicopter is routing from offshore;

(2) for a flight to any other land destination, the duration of the flight and the meteorological conditions prevailing are such that, at the estimated time of arrival at the site of intended landing, an approach and landing may be made under visual meteorological conditions (VMC); or

(3) the site of intended landing is isolated and no alternate is available; in this case, a point of no return (PNR) shall be determined.

(c) The operator shall select two destination alternate aerodromes when:

(1) the appropriate weather reports and/or forecasts for the destination aerodrome indicate that during a period commencing one hour before and ending one hour after the estimated time of arrival the weather conditions will be below the applicable planning minima; or

Subpart D | Revised rule text

- (2) no meteorological information is available for the destination aerodrome.
- (d) Off-shore destination alternate aerodromes may be selected subject to the following:
- (1) an off-shore destination alternate aerodrome shall be used only after a PNR. Prior to PNR, on-shore alternate aerodromes shall be used;
 - (2) OEI landing capability shall be attainable at the alternate aerodrome;
 - (3) to the extent possible, deck availability shall be guaranteed. The dimensions, configuration and obstacle clearance of individual helidecks or other sites shall be assessed in order to establish operational suitability for use as an alternate aerodrome by each helicopter type proposed to be used;
 - (4) weather minima shall be established taking accuracy and reliability of meteorological information into account;
 - (5) the MEL shall contain specific provisions for this type of operation; and
 - (6) an off-shore alternate aerodrome shall not be selected unless the operator has established a procedure in the operations manual.
- (e) The operator shall specify any required alternate aerodrome(s) in the operational flight plan.

Comment [WSI36]:
From ICAO Annex 6.

CAT.OP.AH.185OPS-1.297 Planning minima for IFR flights - aeroplanes

- (a) Planning minima for a take-off alternate aerodrome-
- ~~An operator~~**The operator** shall only select an aerodrome as a take-off alternate aerodrome when the appropriate weather reports **and/or** forecasts ~~or any combination thereof~~ indicate that, during a period commencing one hour before and ending one hour after the estimated time of arrival at the aerodrome, the weather conditions will be at or above the applicable landing minima specified in accordance with **CAT.OP.AH.110.OPS-1.225**. The ceiling ~~must~~**shall** be taken into account when the only approach **operations** es-available are **non-precision approaches (non-precision NPA)** and/or circling ~~approaches~~**operations**. Any limitation related to one-engine inoperative ~~OEI~~ operations ~~must~~**shall** be taken into account.
- (b) Planning minima for a destination aerodrome ~~(other than except an isolated destination aerodromes)~~.
- ~~The An operator~~ shall only select the destination aerodrome ~~and~~ when:
- (1) the appropriate weather reports **and/or** forecasts, ~~or any combination thereof~~, indicate that, during a period commencing one hour before and ending one hour after the estimated time of arrival at the aerodrome, the weather conditions will be at or above the applicable planning minima as follows:
 - (i) RVR/visibility **(VIS)** specified in accordance with ~~OPS 1.225~~**CAT.OP.AH.110**; and

Subpart D | Revised rule text

(ii) ~~F~~or an ~~non-precision approach~~ **NPA** or a circling approach **operation**, the ceiling at or above MDH;

or

(2) two destination alternate aerodromes are selected ~~under OPS 1.295(d)~~.

(c) Planning minima for a ~~Destination~~ **destination** alternate aerodrome, ~~or~~ isolated aerodrome, ~~or~~ **3% fuel en-route alternate (fuel ERA)** aerodrome, ~~or~~ En-route alternate aerodrome ~~required at the planning stage~~.

~~The~~ An operator shall only select an aerodrome for one of ~~these~~ **these** purposes when the appropriate weather reports **and/or** forecasts, ~~or any combination thereof~~, indicate that, during a period commencing one hour before and ending one hour after the estimated time of arrival at the aerodrome, the weather conditions will be at or above the planning minima in Table 1 ~~below~~.

Table 1: Planning minima –

Destination alternate aerodrome, isolated destination aerodrome, ~~3%~~ fuel ERA and en-route alternate aerodrome

Type of approach	Planning mMinima
CATat II and III	CATat I (Note 1) RVR
Cat CATI	Non-precision NPA (Notes 1 & 2) RVR/VIS Ceiling shall be at or above MDH
Non-precision NPA	Non-precision NPA RVR/VIS + 1 000 m Ceiling shall be at or above MDH + 200 ft (Notes 1 & 2) plus 200 ft / 1000 m
Circling	Circling

Note 1 RVR:

Note 2 The ceiling must be at or above the MDH.

~~(d) Planning minima for an ETOPS en-route alternate aerodrome:~~

~~An operator shall only select an aerodrome as an ETOPS en-route alternate aerodrome when the appropriate weather reports or forecasts, or any combination thereof, indicate that, between the anticipated time of landing until one hour after the latest possible time of landing, conditions calculated by adding the additional limits of Table 2 will exist. An operator shall include in the Operations Manual the method for determining the operating minima at the planned ETOPS en-route alternate aerodrome.~~

Comment [WSI37]:
Moved to SPA.ETOPS.115

Subpart D | Revised rule text

Table 2: Planning minima—ETOPS

Approach Facility	Alternate Airfield Ceiling	Weather Minima Visibility/RVR
Precision Approach procedure.	Authorised DH/DA plus an increment of 200 ft	Authorised visibility plus an increment of 800 metres
Non-Precision Approach or Circling Approach	Authorised MDH/MDA plus an increment of 400 ft	Authorised visibility plus an increment of 1500 metres

Formatted: Table N

Formatted: Table N

CAT.OP.AH.186 Planning minima for IFR flights - helicopters**(a) Planning minima for take-off alternate aerodrome(s)**

The operator shall only select an aerodrome or landing site as a take-off alternate aerodrome when the appropriate weather reports and/or forecasts indicate that, during a period commencing one hour before and ending one hour after the estimated time of arrival at the take-off alternate aerodrome, the weather conditions will be at or above the applicable landing minima specified in accordance with CAT.OP.AH.110. The ceiling shall be taken into account when the only approach operations available are NPA operations. Any limitation related to OEI operations shall be taken into account.

(b) Planning minima for destination aerodrome and destination alternate aerodrome(s)

The operator shall only select the destination and/or destination alternate aerodrome(s) when the appropriate weather reports and/or forecasts indicate that, during a period commencing one hour before and ending one hour after the estimated time of arrival at the aerodrome/operating site, the weather conditions will be at or above the applicable planning minima as follows:

- (1) except as provided in CAT.OP.AH.181(d), planning minima for a destination aerodrome shall be:
 - (i) RVR/VIS specified in accordance with CAT.OP.AH.110; and
 - (ii) for NPA operations, the ceiling at or above MDH;
- (2) planning minima for destination alternate aerodrome(s) are as shown in Table 1.

Subpart D | Revised rule text

**Table 1: Planning minima
destination alternate aerodrome**

Type of approach	Planning minima
CAT II and III	CAT I RVR
CAT I	CAT I + 200 ft / 400 m visibility
NPA	NPA RVR/VIS + 400 m Ceiling shall be at or above MDH + 200ft

Comment [WSI38]:
Modified by accepting comments.

CAT.OP.AH.190 OPS 1.300 Submission of ATS flight plan

~~An operator shall ensure that a flight is not commenced unless an ATS flight plan has been submitted, or~~

- (a) **If an ATS flight plan is not submitted because it is not required by the rules of the air**, adequate information ~~has been~~ **shall be** deposited in order to permit alerting services to be activated if required.
- (b) **When operating from a site where it is impossible to submit an ATS flight plan, the ATS flight plan shall be transmitted as soon as possible after take-off by the commander or the operator.**

CAT.OP.AH.195 OPS 1.305 Refuelling/defuelling with passengers embarking, on board or disembarking

(See Appendix 1 to OPS 1.305)

- (a) ~~An operator shall ensure that an aircraft/aeroplane is~~ **shall not be** refuelled/defuelled with Avgas or wide-cut type fuel (e.g. Jet B or equivalent) or ~~when a mixture of these types of fuel might occur~~, when passengers are embarking, on board or disembarking. ~~In all other cases~~
- (b) **For all other types of fuel**, necessary precautions ~~must~~ **shall** be taken and the ~~aircraft/aeroplane must~~ **shall** be properly manned by qualified personnel ready to initiate and direct an evacuation of the ~~aircraft/aeroplane~~ by the most practical and expeditious means available.

CAT.OP.AH.200 OPS 1.307 Refuelling/defuelling with wide-cut fuel

~~Refuelling/defuelling An operator shall establish procedures for refuelling/defuelling with wide-cut fuel (e.g. Jet B or equivalent) shall only be conducted if the operator has established appropriate procedures taking into account the high risk of using wide-cut fuel types. if this is required.~~

Comment [WSI39]:
Text amendments to clarify the intent of the rule.

CAT.OP.AH.205 OPS 1.308 Push back and towing - aeroplanes

~~(a) Push back and towing procedures~~ **specified by the operator shall be conducted in accordance with established** ~~comply with appropriate aviation standards and procedures.~~

Subpart D | Revised rule text

[AMC/GM CAT.OP]**AMC1-CAT.OP.AH.205 Push back and towing - aeroplanes**~~TOWBARLESS TOWING~~

- 1. Barless towing should be based on the applicable SAE ARP (Aerospace Recommended Practices), i.e. 4852B/4853B/5283/5284/5285 (as amended).**
2. ~~(b)The operator shall ensure that p~~Pre- or post-taxi positioning of the aeroplanes is **should only not be** executed by ~~towbarless towing unless if:~~
 - ~~a.(1)an aeroplane is protected by its own design from damage to the nose wheel steering system; due to towbarless towing operation, or~~
 - ~~b.(2)a system/procedure is provided to alert the flight crew that such damage referred to in 2.a. may have or has occurred; or~~
 - ~~c.(3)the towbarless-towing vehicle is designed to prevent damage to the aeroplane type; or and type.~~
- d4. the aeroplane manufacturer has published procedures and these are included in the operations manual.**

Comment [WSI40]:
[ACJ OPS 1.308

Comment [WSI41]:
Text added on the basis of comments received.

[IR CAT.OP]**CAT.OP.AH.210**~~OPS 1.310~~ **Crew Members**~~members~~ **at stations**

- (a) Flight crew members
 - (1) During take-off and landing each flight crew member required to be on ~~flight deck duty~~ **duty in the flight crew compartment** shall be at ~~his/her the~~ **assigned** station.
 - (2) During all other phases of flight each flight crew member required to be on ~~flight deck duty~~ **duty in the flight crew compartment** shall remain at **the assigned** ~~his/her~~ station unless ~~his/her~~ absence is necessary for the performance of ~~his/her~~ duties in connection with the operation, or for physiological needs, provided at least one suitably qualified pilot remains at the controls of the ~~aircraft~~ **aeroplane** at all times.
 - (3) During all phases of flight each flight crew member required to be on ~~flight deck duty~~ **duty in the flight crew compartment shall** remain alert. If a lack of alertness is encountered, appropriate countermeasures shall be used. If unexpected fatigue is experienced, a controlled rest procedure, organised by the commander, ~~can~~ **may** be used if workload permits. Controlled rest taken in this way ~~may never~~ **shall not** be considered to be part of a rest period for purposes of calculating flight time limitations nor used to justify any **extension of the** duty period.

Comment [WSI42]:
alleviation from Appendix 1 to OPS 1.005 18 has not been transposed.

Subpart D | Revised rule text

(b) Cabin crew members-

~~On all the decks of the aeroplane that are occupied by passengers, During critical phases of flight, each required cabin crew members shall be seated at their assigned stations and shall not perform any activities other than those required for the safe operation of the aircraft during critical phases of flight.~~

Comment [WSI43]:
Text modified on the basis of comments received.

~~**OPS 1.311 Minimum number of cabin crew required to be on board an aeroplane during ground operations with passengers (see Appendix 1 to OPS 1.311)**~~

Comment [WSI44]:
Replaced by OR.OPS.CC.207

An operator shall ensure that, whenever any passengers are on board an aeroplane, the minimum number of cabin crew required in accordance with OPS 1.990(a), (b), (c) and (d) are present in the passenger cabin, except:

(a) ~~When the aeroplane is on the ground at a parking place, the number of cabin crew present in the passenger cabin may be reduced below the number determined by OPS 1.990(a), (b) and (c). The minimum number of cabin crew required in these circumstances shall be one per pair of floor level emergency exits on each passenger deck, or one for every 50, or fraction of 50, passengers present on board, whichever is greater, provided that:~~

Formatted: N (a)

- ~~(1) The operator has established a procedure for the evacuation of passengers with this reduced number of cabin crew that has been accepted by the Authority as providing equivalent safety; and~~
- ~~(2) No refuelling/defuelling is taking place; and~~
- ~~(3) The senior cabin crew member has performed the pre-boarding safety briefing to the Cabin Crew; and~~
- ~~(4) The senior cabin crew member is present in the passenger cabin; and~~
- ~~(5) The pre-boarding cabin checks have been completed.~~

Formatted: N (1)

~~This reduction is not permitted when the number of cabin crew is determined by using OPS 1.990(d).~~

(b) ~~During disembarkation when the number of passengers remaining on board is less than 20, the minimum number of cabin crew present in the passenger cabin may be reduced below the minimum number of cabin crew required in accordance with OPS 1.990(a), (b), (c) and (d), provided that:~~

Formatted: N (a)

- ~~(1) The operator has established a procedure for the evacuation of passengers with this reduced number of cabin crew that has been accepted by the Authority as providing equivalent safety; and~~
- ~~(2) The senior cabin crew member is present in the passenger cabin.~~

Formatted: N (1)

CAT.OP.AH.215~~OPS 1.313~~ Use of headset - aeroplanes

(a) Each flight crew member required to be on flight deck ~~duty~~ **duty in the flight crew compartment** shall wear the ~~a~~ headset with boom microphone or equivalent required by. **The headset shall be** OPS 1.650(p) and/or 1.652(s) and used it as the primary device ~~for to listen to the voice communications with Air Traffic Services~~ **ATS:**

Subpart D | Revised rule text

- (1) **when** ~~—on the ground;~~
- (i) ~~—when receiving the ATC departure clearance via voice communication;~~
and
 - (ii) ~~—when engines are running;~~
- (2) **when** ~~—in flight:~~
- (i) ~~below transition altitude; or~~
 - (ii) ~~10,000 feet~~**ft, whichever** ~~is higher;~~ **and**
- (3) ~~—whenever deemed necessary by the commander.~~
- (b) In the conditions of ~~paragraph (a)~~**±** above, the boom microphone or equivalent shall be in a position ~~which~~**that** permits its use for two-way radio communications.

CAT.OP.AH.216 Use of headset - helicopters

Each flight crew member required to be on duty on the flight crew compartment shall wear a headset with boom microphone, or equivalent, and use it as the primary device to communicate with ATS.

CAT.OP.AH.220OPS-1.315 Assisting means for emergency evacuation

~~An operator~~**The operator** shall establish procedures to ensure that before taxiing, take-off and landing, and when safe and practicable to do so, **all means of assistance** ~~an assisting means~~ for emergency evacuation that deploys automatically, ~~is~~**are** armed.

CAT.OP.AH.225OPS-1.320 Seats, safety belts and harnesses

- (a) Crew members
- (1) During take-off and landing, and whenever ~~deemed necessary~~**decided** by the commander in the interest of safety, each crew member shall be properly secured by all safety belts and harnesses provided.
 - (2) During other phases of the flight, each flight crew member ~~on~~**in** the flight deck ~~crew compartment~~ shall keep **the assigned station** ~~his/her~~ safety harness fastened while at his/her station.
- (b) Passengers
- (1) Before take-off and landing, and during taxiing, and whenever deemed necessary in the interest of safety, the commander shall **be satisfied** ~~ensure~~ that each passenger on board occupies a seat or berth with his/her safety belt or harness ~~where provided~~ properly secured.
 - (2) ~~An operator~~**The operator** shall make provisions for **multiple occupancy of aircraft seats which is only allowed on specified seats.** ~~The~~ ~~,~~ ~~and~~ ~~the~~ commander shall **be satisfied** ~~ensure~~ that multiple occupancy of ~~aeroplane seats may only be allowed on specified seats and~~ does not occur other than by one adult and one infant who is properly secured by a supplementary loop belt or other restraint device.

Subpart D | Revised rule text

Comment [WSI45]:
Covered in CAT.GEN.105(a)(13).

CAT.OP.AH.230~~OPS 1.325~~ Securing of passenger cabin and galley(s)

- (a) ~~An operator~~**The operator** shall establish procedures to ensure that before taxiing, take-off and landing all exits and escape paths are unobstructed.
- (b) The commander shall **be satisfied** ~~ensure~~ that before take-off and landing, and whenever deemed necessary in the interest of safety, all equipment and baggage is properly secured.

CAT.OP.AH.235~~OPS 1.330~~ Life-jackets - helicopters~~Accessibility of emergency equipment~~

~~The commander shall ensure that relevant emergency equipment remains easily accessible for immediate use.~~

The operator shall establish procedures to ensure that, when operating a helicopter over water in performance class 3, account is taken of the duration of the flight and conditions to be encountered when deciding if life-jackets are to be worn by all occupants.

CAT.OP.AH.240~~OPS 1.335~~ Smoking on board

- (a) ~~—The commander shall ensure that not person on board is allowed to smoke~~**ing on board:**
- (a~~1~~) ~~w~~**Whenever considered necessary** ~~deemed necessary~~ in the interest of safety;
- (b) during fuelling and de-fuelling of the aircraft;**
- (2**b**) ~~w~~**While the aeroplane—aircraft is on the ground unless the operator has determined** specifically permitted in accordance with procedures **to mitigate the risks during ground operations** defined in the Operations Manual;
- (3**d**) ~~o~~**Outside designated smoking areas, in the aisle(s) and in the lavatory(ies); toilet(s);**
- (4**e**) ~~i~~**n cargo compartments and/or other areas where cargo is carried which—that is not stored in flame-resistant containers or covered by flame-resistant canvas; and**
- (5**f**) ~~i~~**n those areas of the cabin where oxygen is being supplied.**

CAT.OP.AH.245~~OPS 1.340~~ Meteorological cConditions

- (a) On ~~an~~ IFR flights **the** ~~a~~ commander shall only:
- (1) commence take-off; or
 - (2) continue beyond the point from which a revised flight plan applies in the event of in-flight ~~re-planning~~**replanning,**
- when information is available indicating that the expected weather conditions, at the time of arrival, at the destination and—/—or required alternate aerodrome(s) ~~prescribed in OPS 1.295~~ are at or above the planning minima, ~~prescribed in OPS 1.297.~~
- (b) On ~~an~~ IFR flights, ~~a~~**the** commander shall only continue towards the planned destination aerodrome when the latest information available indicates that, at the

Subpart D | Revised rule text

expected time of arrival, the weather conditions at the destination, or at least one destination alternate aerodrome, are at or above the ~~planning~~ applicable aerodrome operating minima.

Comment [WSI46]:
The word "planning" is confusing in this text. It is proposed to be deleted.

- (c) On an IFR flight **with aeroplanes**, ~~a the commander of an aeroplane~~ shall only continue beyond:
 - (1) the decision point when using the ~~r~~Reduced ~~c~~Contingency ~~f~~Fuel **(RCF) p**Procedure; ~~(see Appendix 1 to OPS 1.255);~~ or
 - (2) the pre-determined point when using the **pre-determined point (PDP)** ~~predetermined point procedure, (see Appendix 1 to OPS 1.255),~~
 when information is available indicating that the expected weather conditions, at the time of arrival, at the destination and/or required alternate aerodrome(s) ~~prescribed in OPS 1.295~~ are at or above the applicable aerodrome operating minima ~~prescribed in OPS 1.225~~.
- (d) On a ~~VFR flights~~, ~~the~~ a commander shall only commence take-off when the appropriate weather reports **and/or** forecasts, ~~or any combination thereof,~~ indicate that the meteorological conditions along the ~~route or that part of the route to be flown under VFR will,~~ at the appropriate time, **be at or above the VFR limits** ~~be such as to render compliance with these rules possible.~~
- (e) **On VFR flights overwater with helicopters, the commander shall only commence take-off when the appropriate weather reports and/or forecasts indicate that the cloud ceiling will be above 600 ft by day or 1 200 ft by night.**
- (f) **Notwithstanding (e), when flying between helidecks located in class G airspace where the overwater sector is less than 10 NM, VFR flights may be conducted when the limits are at, or better than, the following:**

Table 1: Minima for flying between helidecks located in class G airspace

	Day		Night	
	Height *	Visibility	Height *	Visibility
Single pilot	300 ft	3 km	500 ft	5 km
Two pilots	300 ft	2 km **	500 ft	5 km ***

- *: **The cloud base shall be such as to allow flight at the specified height, below and clear of cloud**
- **: **Helicopters may be operated in flight visibility down to 800 m provided the destination or an intermediate structure are continuously visible.**
- ***: **Helicopters may be operated in flight visibility down to 1 500 m provided the destination or an intermediate structure are continuously visible.**

Subpart D | Revised rule text

- (g) Flight with **helicopters to a helideck or elevated aerodrome shall only be operated when the mean wind speed at the helideck or elevated aerodrome is reported to be less than 60 knots (kts).**

CAT.OP.AH.250OPS 1.345 Ice and other contaminants – ground procedures

- (a) ~~An operator~~**The operator** shall establish procedures to be followed when ground de-icing and anti-icing and related inspections of the ~~aircraft/aeroplane(s)~~ are necessary **to allow the safe operation of the aircraft.**
- (b) ~~A-~~**The** commander shall not commence take-off unless the ~~aircraft is~~ **external surfaces are** clear of any deposit ~~which that~~ might adversely affect the performance and/or controllability of the ~~aircraft, aeroplane~~ **aircraft, aeroplane** except as permitted in the ~~Aeroplane Flight Manual~~**AFM.**

Comment [WSI47]:
Changed on the basis of comments received.

CAT.OP.AH.255OPS 1.346 Ice and other contaminants – flight procedures

- (a) ~~An operator~~**The operator** shall establish procedures for flights in expected or actual icing conditions.
- (b) ~~A-~~**The** commander shall not commence a flight nor intentionally fly into expected or actual icing conditions unless the ~~aeroplane-aircraft~~ **aircraft** is certified ~~equipped~~ and equipped to cope with such conditions.

CAT.OP.AH.260OPS 1.350 Fuel and oil supply

~~A-~~**The** commander shall only commence a flight or continue in the event of in-flight ~~re-planning~~**replanning**, when he/she is satisfied that the ~~aircraft/aeroplane~~ carries at least the planned amount of usable fuel and oil to complete the flight safely, taking into account the expected operating conditions.

CAT.OP.AH.265OPS 1.355 Take-off conditions

Before commencing take-off, ~~a-~~**the** commander ~~must~~ **shall be satisfied** ~~by himself/herself~~ that:

- (a) according to the information available to him/her, the weather at the aerodrome/**operating site** and the condition of the runway/**FATO** intended to be used should not prevent a safe take-off and departure;-

OPS 1.360Application of take-off minima

- (b) ~~Before commencing take-off, a commander must satisfy himself/herself that~~ the RVR/**VIS** or visibility in the take-off direction of the ~~aeroplane~~ **aircraft** is equal to or better than the applicable minimum.

Subpart D | Revised rule text

CAT.OP.AH.270~~OPS 1.365~~ Minimum flight altitudes

The commander or the pilot to whom conduct of the flight has been delegated shall not fly below specified minimum altitudes except when:

- (1) necessary for take-off or landing; ~~or~~ |
- (2) **descending in accordance with procedures approved by the competent authority.**

Comment [WSI48]:
Added to align with JAR-OPS3.

CAT.OP.AH.275~~OPS 1.370~~ Simulated abnormal situations in flight

~~An~~**The** operator shall establish procedures to ensure that abnormal or emergency **procedures or circumstances that would require such procedures and IMC are not simulated** situations requiring the application of part or all of abnormal or emergency procedures and simulation of IMC by artificial means ~~are not simulated during commercial air transportation flight operations.~~

Comment [PR-49]:
Deleted because simulation is only possibly by artificial means.

CAT.OP.AH.280~~OPS 1.375~~ In-flight fuel management - aeroplanes

~~An~~**The** operator shall establish a procedure to ensure that in-flight fuel checks and fuel management are carried out according to the following criteria.:

- (a) In-flight fuel checks-
 - (1) ~~A~~**The** commander ~~must~~**shall** ensure that fuel checks are carried out in-flight at regular intervals. The usable remaining fuel ~~must~~**shall** be recorded and evaluated to:
 - (i) compare actual consumption with planned consumption;
 - (ii) check that the usable remaining fuel is sufficient to complete the flight, in accordance with ~~paragraph (b) 'In-flight fuel management' below;~~ and
 - (iii) determine the expected usable fuel remaining on arrival at the destination aerodrome.
 - (2) The relevant fuel data ~~must~~**shall** be recorded.
- (b) In-flight fuel management-
 - (1) The flight ~~must~~**shall** be conducted so that the expected usable fuel remaining on arrival at the destination aerodrome is not less than:
 - (i) the required alternate fuel plus final reserve fuel, or
 - (ii) the final reserve fuel if no alternate aerodrome is required.
 - (2) ~~However, if, as a result of an in-flight fuel check~~ **shows that** ~~the expected usable fuel remaining on arrival at the destination aerodrome is less than:~~
 - (i) the required alternate fuel plus final reserve fuel, the commander ~~must~~**shall** take into account the traffic and the operational conditions prevailing at the destination aerodrome, at the destination alternate aerodrome and at any other adequate aerodrome, in deciding whether to proceed to the destination aerodrome or to divert so as to perform a safe landing with not less than final reserve fuel; ~~or~~

Subpart D | Revised rule text

- (ii) the final reserve fuel if no alternate aerodrome is required, the commander ~~must~~**shall** take appropriate action and proceed to an adequate aerodrome so as to perform a safe landing with not less than final reserve fuel.
- (3) The commander shall declare an emergency when **the** calculated usable fuel on landing, at the nearest adequate aerodrome where a safe landing can be performed, is less than final reserve fuel.
- (4) Additional conditions for specific procedures
 - (i) On a flight using the RCF procedure, ~~in order to~~ proceed to the ~~D~~destination 1 aerodrome, the commander ~~must~~**shall** ensure that the usable fuel remaining at the decision point is at least the total of:
 - (A) ~~t~~Trip fuel from the decision point to the ~~d~~Destination 1 aerodrome; ~~and~~;
 - (B) ~~c~~Contingency fuel equal to 5% of trip fuel from the decision point to the destination 1 aerodrome; ~~and~~
 - (C) ~~d~~Destination 1 aerodrome alternate fuel, if a destination 1 alternate aerodrome is required; ~~and~~
 - (D) ~~f~~Final reserve fuel.
 - (ii) On a flight using the PDP procedure ~~in order to~~ proceed to the destination aerodrome, the commander ~~must~~**shall** ensure that the usable fuel remaining at the PDP is at least the total of:
 - (A) ~~t~~Trip fuel from the PDP to the destination aerodrome; ~~and~~
 - (B) ~~c~~Contingency fuel from the PDP to the destination aerodrome~~calculated in accordance with Appendix 1 to OPS 1.255 Paragraph 1.3; and~~
 - (C) ~~a~~Fuel required according to Appendix 1 to OPS 1.255 Paragraph 3.1.d.**Additional fuel.**

CAT.OP.AH.281 In-flight fuel management - helicopters

- (a) **The operator shall establish a procedure to ensure that in-flight fuel checks and fuel management are carried out.**
- (b) **The commander shall ensure that the amount of usable fuel remaining in flight is not less than the fuel required to proceed to an aerodrome/operating site where a safe landing can be made, with final reserve fuel remaining.**
- (c) **The commander shall declare an emergency when the actual usable fuel on board is less than final reserve fuel.**

Subpart D | Revised rule text

~~OPS 1.380~~ Intentionally blank**CAT.OP.AH.285**~~OPS 1.385~~ Use of supplemental oxygen

~~A~~**The** commander shall ensure that flight crew members engaged in performing duties essential to the safe operation of an ~~aircraft~~**aeroplane** in flight use supplemental oxygen continuously whenever **the** cabin altitude exceeds 10 000 ft for a period ~~in excess of~~**of more than** 30 minutes and whenever the cabin altitude exceeds 13 000 ft.

~~OPS 1.390~~ Cosmic radiation

~~(a)~~ An operator shall take account of the in flight exposure to cosmic radiation of all crew members while on duty (including positioning) and shall take the following measures for those crew liable to be subject to exposure of more than 1 mSv per year;

- ~~(1)~~ Assess their exposure;
 - ~~(2)~~ Take into account the assessed exposure when organising working schedules with a view to reduce the doses of highly exposed crew members;
 - ~~(3)~~ Inform the crew members concerned of the health risks their work involves;
 - ~~(4)~~ Ensure that the working schedules for female crew members, once they have notified the operator that they are pregnant, keep the equivalent dose to the foetus as low as can reasonably be achieved and in any case ensure that the dose does not exceed 1 mSv for the remainder of the pregnancy;
 - ~~(5)~~ Ensure that individual records are kept for those crew members who are liable to high exposure. These exposures are to be notified to the individual on an annual basis, and also upon leaving the operator.
- ~~(b)~~
- ~~(1)~~ An operator shall not operate an aeroplane above 15 000m (49 000 ft) unless the equipment specified in OPS 1.680(a)(1) is serviceable, or the procedure prescribed in OPS 1.680(a)(2) is complied with.
 - ~~(2)~~ The commander or the pilot to whom conduct of the flight has been delegated shall initiate a descent as soon as practicable when the limit values of cosmic radiation dose rate specified in the Operations Manual are exceeded.

Comment [WSI50]:
Covered by Directive 96/29.

Formatted: N (a)

CAT.OP.AH.290~~OPS 1.395~~ Ground proximity detection

When undue proximity to the ground is detected by ~~any~~**a** flight crew member or by a ground proximity warning system, the ~~commander or the pilot to whom conduct of the flight has been delegated~~**pilot flying** shall ensure that ~~take~~**take** corrective action is initiated immediately to establish safe flight conditions.

CAT.OP.AH.295~~OPS 1.398~~ Use of ~~a~~**A**irborne ~~c~~**C**ollision ~~a~~**A**voidance ~~s~~**S**ystem (ACAS II)

- ~~(a)~~ ~~An operator~~**The operator** shall establish procedures to ensure that ~~±w~~
- ~~(a)~~ When ACAS **II** is installed and serviceable, it shall be used ~~in~~**during** flight in a mode that enables ~~r~~**R**esolution ~~a~~**A**dvisories (RA) to be produced **for the flight crew** unless to do so would not be appropriate for conditions existing at the time.

Comment [WSI51]:
Aligned with ARU.TCAS.

Subpart D | Revised rule text

when undue proximity to another aircraft is detected, unless inhibition of RA mode using traffic advisory (TA) only or equivalent is called for by an abnormal procedure or due to performance limiting conditions.

(b) When an RA is produced by ACAS II:

- (1) the pilot flying shall immediately conform to the indications of the RA, even if this conflicts with an ATC instruction, unless doing so would jeopardise the safety of the aircraft;**
- (2) as soon as permitted by flight crew workload, notify the appropriate ATC unit of any RA that requires a deviation from the current ATC instruction or clearance; and**
- (3) when the conflict is resolved, the aircraft shall:**
 - (i) be promptly returned to the terms of the acknowledged ATC instruction or clearance and ATC notified of the manoeuvre; or**
 - (ii) comply with any amended ATC clearance or instruction issued.**

~~(b) When undue proximity to another aircraft (RA) is detected by ACAS, the commander or the pilot to whom conduct of the flight has been delegated must ensure that any corrective action indicated by the RA is initiated immediately, unless doing so would jeopardize the safety of the aeroplane.~~

~~— The corrective action must shall:~~

- ~~(1i) Never be in a sense opposite to that indicated by the RA~~
- ~~(2ii) Be in the correct sense indicated by the RA even if this is in conflict with the vertical element of an ATC instruction.~~
- ~~(3iii) Be the minimum possible to comply with the RA indication.~~
- ~~(c) Prescribed ACAS ATC communications are specified.~~
- ~~(d) When the conflict is resolved the aeroplane is promptly returned to the terms of the ATC instructions or clearance.~~

CAT.OP.AH.3000PS-1.400 Approach and landing conditions

Before commencing an approach to land, the commander ~~must~~**shall be satisfied** ~~himself/herself~~ that, according to the information available to him/her, the weather at the aerodrome and the condition of the runway intended to be used should not prevent a safe approach, landing or missed approach, having regard to the performance information contained in the ~~Operations Manual~~**operations manual**.

CAT.OP.AH.3050PS-1.405 Commencement and continuation of approach

- (a) The commander or the pilot to whom conduct of the flight has been delegated may commence an instrument approach regardless of the reported RVR.
- (b) If the reported RVR is less than the applicable minimum** ~~AVIS~~ **but the** approach shall not be continued:

Subpart D | Revised rule text

- (1) **below 1 000 ft above the aerodrome;** ~~or beyond the outer marker, or equivalent position,~~
- (2) **into the final approach segment in the case where the DH/MDH is more than 1 000 ft above the aerodrome.**~~,~~

if the reported RVR/VIS is less than the applicable minima (see OPS 1.192).

(cb) Where RVR is not available, RVR values may be derived by converting the reported visibility.

(de) If, after passing **1 000 ft above the aerodrome**, the reported RVR/VIS falls below the applicable minimum, the approach may be continued to DA/H or MDA/H.~~(d) —Where no outer marker or equivalent position exists, the commander or the pilot to whom conduct of the flight has been delegated shall make the decision to continue or abandon the approach before descending below 1 000 ft above the aerodrome on the final approach segment. If the MDA/H is at or above 1 000 ft above the aerodrome, the operator shall establish a height, for each approach procedure, below which the approach shall not be continued if RVR/visibility is less than applicable minima.~~

Comment [WSI52]:
Deleted because already covered in (a)(2).

(ede) The approach may be continued below DA/H or MDA/H and the landing may be completed provided that the required visual reference **adequate for the type of approach operation and for the intended runway** is established at the DA/H or MDA/H and is maintained.

Comment [WSI53]:
The AMC specifies the visual reference for the different types of approach operations.

(fef) The touchdown zone RVR **shall** ~~is~~ always **be** controlling. If reported and relevant, the midpoint and stopend RVR **shall** ~~are~~ also **be** controlling. The minimum RVR value for the midpoint shall be 125 m or the RVR required for the touchdown zone if less, and 75 m for the stopend. For ~~aeroplanes~~ **aircraft** equipped with a rollout guidance or control system, the minimum RVR value for the midpoint shall be 75 m.

[AMC/GM CAT.OP]

GM1-CAT.OP.AH.305(f) Commencement and continuation of approach

EXPLANATION OF THE TERM "RELEVANT"

~~Note:~~—"Relevant", in this context, means that part of the runway used during the high-speed phase of the landing down to a speed of approximately 60 knots (**kts**).

[IR CAT.OP]

~~CAT.OP.AH.310~~~~OPS 1.410~~ **Operating procedures – tThreshold crossing height - aeroplanes**

~~An operator~~**The operator must** ~~shall~~ establish operational procedures designed to ensure that an aeroplane ~~being used to conducting~~ **precision** approaches crosses the threshold **of the runway** by a safe margin, with the aeroplane in the landing configuration and attitude.

Subpart D | Revised rule text

OPS 1.415 Journey log

A commander shall ensure that the Journey log is completed.

CAT.OP.AH.315 Flight hours reporting - helicopters

The operator shall make available to the competent authority the hours flown for each helicopter operated during the previous calendar year.

OPS 1.420 Occurrence reporting**(a) Terminology**

- (1) Incident. An occurrence, other than an accident, associated with the operation of an aircraft which affects or could affect the safety of operation.
- (2) Serious Incident. An incident involving circumstances indicating that an accident nearly occurred.
- (3) Accident. An occurrence associated with the operation of an aircraft which takes place between the time any person boards the aircraft with the intention of flight until such time as all persons have disembarked, in which:
- (i) a person is fatally or seriously injured as a result of:
 - (A) being in the aircraft;
 - (B) direct contact with any part of the aircraft, including parts which have become detached from the aircraft; or
 - (C) direct exposure to jet blast;
 except when the injuries are from natural causes, self-inflicted or inflicted by other persons, or when the injuries are to stowaways hiding outside the areas normally available to the passengers and crew; or
 - (ii) the aircraft sustains damage or structural failure which adversely affects the structural strength, performance or flight characteristics of the aircraft, and would normally require major repair or replacement of the affected component, except for engine failure or damage, when the damage is limited to the engine, its cowlings or accessories; or for damage limited to propellers, wing tips, antennas, tyres, brakes, fairings, small dents or puncture holes in the aircraft skin; or
 - (iii) the aircraft is missing or is completely inaccessible.

Comment [WSI54]:
Covered in Regulation (EC) No. 996/2010

(b) Incident reporting. An operator shall establish procedures for reporting incidents taking into account responsibilities described below and circumstances described in subparagraph (d) below.

- (1) OPS 1.085(b) specifies the responsibilities of crew members for reporting incidents that endangers, or could endanger, the safety of operation.
- (2) The commander or the operator of an aeroplane shall submit a report to the Authority of any incident that endangers or could endanger the safety of operation.

Comment [WSI55]:
OR.OPS.100 and Part-M

Subpart D | Revised rule text

- ~~(3) Reports must be despatched within 72 hours of the time when the incident was identified unless exceptional circumstances prevent this.~~
- ~~(4) A commander shall ensure that all known or suspected technical defects and all exceedances of technical limitations occurring while he/she was responsible for the flight are recorded in the aircraft technical log. If the deficiency or exceedance of technical limitations endangers or could endanger the safety of operation, the commander must in addition initiate the submission of a report to the Authority in accordance with paragraph (b)(2) above.~~
- ~~(5) In the case of incidents reported in accordance with subparagraph (b)(1), (b)(2) and (b)(3) above, arising from, or relating to, any failure, malfunction or defect in the aeroplane, its equipment or any item of ground support equipment or which cause or might cause adverse effects on the continuing airworthiness of the aeroplane, the operator must also inform the organisation responsible for the design or the supplier or, if applicable, the organisation responsible for continued airworthiness, at the same time as a report is submitted to the Authority.~~

~~(c) Accident and Serious Incident Reporting.~~

~~An operator shall establish procedures for reporting accidents and serious incidents taking into account responsibilities described below and circumstances described in subparagraph (d) below.~~

- ~~(1) A commander shall notify the operator of any accident or serious incident occurring while he/she was responsible for the flight. In the event that the commander is incapable of providing such notification, this task shall be undertaken by any other member of the crew if they are able to do so, note being taken of the succession of command specified by the operator.~~
- ~~(2) An operator shall ensure that the Authority in the State of the operator, the nearest appropriate Authority (if not the Authority in the State of the operator), and any other organisation required by the State of the operator to be informed, are notified by the quickest means available of any accident or serious incident and — in the case of accidents only — at least before the aeroplane is moved unless exceptional circumstances prevent this.~~
- ~~(3) The commander or the operator of an aeroplane shall submit a report to the authority in the State of the operator within 72 hours of the time when the accident or serious incident occurred.~~

~~(d) Specific Reports.~~

~~Occurrences for which specific notification and reporting methods must be used are described below:~~

- ~~(1) Air traffic incidents. A commander shall without delay notify the air traffic service unit concerned of the incident and shall inform them of his/her intention to submit an air traffic incident report after the flight has ended whenever an aircraft in flight has been endangered by:~~
- ~~(i) A near collision with any other flying device;~~
- ~~(ii) Faulty air traffic procedures or lack of compliance with applicable procedures by air traffic services or by the flight crew;~~

Comment [WSI56]:
To be covered in Regulation (EC) No. 966/2010

Comment [WSI57]:
To be covered in SERA.

Subpart D | Revised rule text

~~(iii) failure of air traffic services facilities.~~

~~— In addition, the commander shall notify the Authority of the incident.~~

~~(2) Airborne Collision Avoidance System Resolution Advisory. A commander shall notify the air traffic service unit concerned and submit an ACAS report to the Authority whenever an aircraft in flight has manoeuvred in response to an ACAS Resolution Advisory.~~

Comment [WSI58]:
Covered in CAT.GEN.105(c).

~~(3) Bird Hazards and Strikes~~

Comment [WSI59]:
Covered in CAT.GEN.105(d).

~~(i) A commander shall immediately inform the local air traffic service unit whenever a potential bird hazard is observed.~~

~~(ii) If he/she is aware that a bird strike has occurred, a commander shall submit a written bird strike report after landing to the Authority whenever an aircraft for which he/she is responsible suffers a bird strike that results in significant damage to the aircraft or the loss or malfunction of any essential service. If the bird strike is discovered when the commander is not available, the operator is responsible for submitting the report.~~

~~(4) Dangerous Goods Incidents and Accidents. An operator shall report dangerous goods incidents and accidents to the Authority and the appropriate Authority in the State where the accident or incident occurred, as provided for in Appendix 1 to OPS 1.1225. The first report shall be dispatched within 72 hours of the event unless exceptional circumstances prevent this and include the details that are known at that time. If necessary, a subsequent report must be made as soon as possible giving whatever additional information has been established. (See also OPS 1.1225).~~

Comment [WSI60]:
Covered in SPA.DG.

~~(5) Unlawful Interference. Following an act of unlawful interference on board an aircraft, the commander or, in his/her absence, the operator shall submit a report, as soon as practicable to the local Authority and to the Authority in the State of the operator. (See also OPS 1.1245)~~

Comment [WSI61]:
Covered in OR.OPS.SEC.

~~(6) Encountering Potential Hazardous Conditions. A commander shall notify the appropriate air traffic services unit as soon as practicable whenever a potentially hazardous condition such as an irregularity in a ground or navigational facility, a meteorological phenomenon or a volcanic ash cloud is encountered during flight.~~

Comment [WSI62]:
Covered in CAT.GEN.105.

OPS 1.425 Reserved

[AMC/GM CAT.OP]

AMC1-CAT.OP.AH.150 ~~Appendix 1 to OPS 1.255~~ Fuel policy

PROCEDURES - AEROPLANES

~~An operator~~**The operator should** must base the ~~company~~**the defined** fuel policy, including calculation of the amount of fuel to be on board for departure, on the following planning criteria:

Subpart D | Revised rule text

1. Basic pProcedure

The usable fuel to be on board for departure ~~should~~**must** be the ~~amount~~**sum** of:

a. ~~1.1~~ Taxi fuel, which ~~shall~~**should** not be less than the amount, expected to be used prior to take-off. Local conditions at the departure aerodrome and **auxiliary power unit (APU)** consumption ~~shall~~**should** be taken into account.

b.1.2 Trip fuel, which ~~shall~~**should** include:

i.~~(a)~~ **f**Fuel for take-off and climb from aerodrome elevation to initial cruising level/altitude, taking into account the expected departure routing; and

ii.~~(b)~~ **f**Fuel from top of climb to top of descent, including any step climb/descent; and

iii.~~(c)~~ **f**Fuel from top of descent to the point where the approach is initiated, taking into account the expected arrival procedure; and

iv.~~(d)~~ **f**Fuel for approach and landing at the destination aerodrome.

c.1.3 Contingency fuel, except as provided for in **2. below** ~~Paragraph 2 'Reduced Contingency Fuel' RCF~~, which ~~shall~~**should** be the higher of ~~a.(i) or b.(ii)~~ below:

i. ~~(a)~~ Either:

A.~~(i)~~ 5% of the planned trip fuel or, in the event of in-flight ~~re-planning~~**replanning**, 5% of the trip fuel for the remainder of the flight; ~~or~~

B.~~(ii)~~ ~~n~~Not less than 3% of the planned trip fuel or, in the event of in-flight ~~re-planning~~**replanning**, 3% of the trip fuel for the remainder of the flight, provided that an en-route alternate aerodrome is available; ~~in accordance with Appendix 2 to OPS 1.255; or~~

C.~~(iii)~~ ~~a~~An amount of fuel sufficient for 20 minutes flying time based upon the planned trip fuel consumption, provided that the operator has established a fuel consumption monitoring programme for individual aeroplanes and uses valid data determined by means of such a programme for fuel calculation; ~~or~~

D.~~(iv)~~ ~~a~~An amount of fuel based on a statistical method ~~approved by the Authority~~ that ensures an appropriate statistical coverage of the deviation from the planned to the actual trip fuel. This method is used to monitor the fuel consumption on each city pair/aeroplane combination and the operator uses this data for a statistical analysis to calculate contingency fuel for that city pair/aeroplane combination;

~~or~~

ii.~~(b)~~ ~~a~~An amount to fly for 5 minutes at holding speed at 1 500 ft (450 m), above the destination aerodrome in ~~s~~**Standard c**Conditions.

d.1.4 Alternate fuel, which ~~shall~~**should**:

Subpart D | Revised rule text

i.(a) include:

- A.(i)** ~~f~~Fuel for a missed approach from the applicable **DA/H or MDA/DH** at the destination aerodrome to missed approach altitude, taking into account the complete missed approach procedure; ~~and~~
- B.(ii)** ~~f~~Fuel for climb from missed approach altitude to cruising level/altitude, taking into account the expected departure routing; ~~and~~
- C.(iii)** ~~f~~Fuel for cruise from top of climb to top of descent, taking into account the expected routing; ~~and~~
- D.(iv)** ~~f~~Fuel for descent from top of descent to the point where the approach is initiated, taking into account the expected arrival procedure; ~~and~~
- E.(v)** ~~f~~Fuel for executing an approach and landing at the destination alternate aerodrome; ~~selected in accordance with OPS 1.295.~~

ii.(b) ~~where two destination alternate aerodromes are required in accordance with OPS 1.295(d), be sufficient to proceed to the alternate aerodrome which that~~ requires the greater amount of alternate fuel.

e.1.5 Final reserve fuel, which ~~shall~~**should** be:

- i.(a)** ~~f~~For aeroplanes with reciprocating engines, fuel to fly for 45 minutes; or
- ii.(b)** ~~f~~For aeroplanes with turbine engines, fuel to fly for 30 minutes at holding speed at 1 500 ft (450 m) above aerodrome elevation in standard conditions, calculated with the estimated mass on arrival at the destination alternate aerodrome or the destination aerodrome, when no destination alternate aerodrome is required.

f.1.6 The minimum additional fuel, which ~~shall~~**should** permit:

- i.(a)** ~~t~~The aeroplane to descend as necessary and proceed to an adequate alternate aerodrome in the event of engine failure or loss of pressurisation, whichever requires the greater amount of fuel based on the assumption that such a failure occurs at the most critical point along the route, and
 - A.(i)** hold there for 15 minutes at 1 500 ft (450 m) above aerodrome elevation in standard conditions; and
 - B.(ii)** make an approach and landing,

except that additional fuel is only required, if the minimum amount of fuel calculated in accordance with ~~1.sub-paragraphs b1.2 to 1.e.1.5~~ above is not sufficient for such an event; ~~7~~ and
- ii.(b)** ~~h~~Holding for 15 minutes at 1 500 ft (450 m) above destination aerodrome elevation in standard conditions, when a flight is operated without a destination alternate aerodrome. ~~7~~

g.1.7 Extra fuel, which ~~shall~~**should** be at the discretion of the commander.

Subpart D | Revised rule text

2. ~~Reduced Contingency Fuel (RCF) p~~Procedure

If ~~an operator~~**the operator's** fuel policy includes pre-flight planning to a ~~d~~**d**Destination 1 aerodrome (commercial destination) with a reduced contingency fuel procedure using a decision point along the route and a ~~d~~**d**Destination 2 aerodrome (optional refuel destination), the amount of usable fuel, on board for departure, ~~shall~~**should** be the greater of ~~2.a.2-1~~ or ~~2.b.2-2~~ below:

~~a.2-1~~The sum of:

- ~~i.(a) t~~**i.(a) t**Taxi fuel; ~~and~~
- ~~ii.(b) t~~**ii.(b) t**Trip fuel to the ~~d~~**d**Destination 1 aerodrome, via the decision point; ~~and~~
- ~~iii.(c) c~~**iii.(c) c**Contingency fuel equal to not less than 5% of the estimated fuel consumption from the decision point to the ~~d~~**d**Destination 1 aerodrome; ~~and~~
- ~~iv.(d) a~~**iv.(d) a**Alternate fuel or no alternate fuel if the decision point is at less than six hours from the ~~d~~**d**Destination 1 aerodrome and the requirements of ~~OPS 1.295~~**CAT.OP.AH.180, (b)(1)(ii)**, are fulfilled; ~~and~~
- ~~v.(e) f~~**v.(e) f**Final reserve fuel; ~~and~~
- ~~vi.(f) a~~**vi.(f) a**Additional fuel; and
- ~~vii.(g) e~~**vii.(g) e**Extra fuel if required by the commander.

~~b.2-2~~ The sum of:

- ~~i.(a) t~~**i.(a) t**Taxi fuel; ~~and~~
- ~~ii.(b) t~~**ii.(b) t**Trip fuel to the ~~d~~**d**Destination 2 aerodrome, via the decision point; ~~and~~
- ~~iii.(c) c~~**iii.(c) c**Contingency fuel equal to not less than the amount calculated in accordance with ~~1.c.subparagraph 1.3~~ above from departure aerodrome to the ~~d~~**d**Destination 2 aerodrome; ~~and~~
- ~~iv.(d) a~~**iv.(d) a**Alternate fuel, if a ~~d~~**d**Destination 2 alternate aerodrome is required; ~~and~~
- ~~v.(e) f~~**v.(e) f**Final reserve fuel; ~~and~~
- ~~vi.(f) a~~**vi.(f) a**Additional fuel; and
- ~~vii.(g) e~~**vii.(g) e**Extra fuel if required by the commander.

3. ~~Pre-Determined Point (PDP) p~~Procedure

If ~~an operator~~**the operator's** fuel policy includes planning to a destination alternate aerodrome where the distance between the destination aerodrome and the destination alternate aerodrome is such that a flight can only be routed via a predetermined point to one of these aerodromes, the amount of usable fuel, on board for departure, ~~shall~~**should** be the greater of ~~3.a.3-1~~ or ~~3.b.3-2~~ below:

~~a.3-1~~The sum of:

- ~~i.(a) t~~**i.(a) t**Taxi fuel; ~~and~~
- ~~ii.(b) t~~**ii.(b) t**Trip fuel from the departure aerodrome to the destination aerodrome, via the predetermined point; ~~and~~

Subpart D | Revised rule text

~~iii.(c)~~ **c**Contingency fuel calculated in accordance with ~~1.c.sub-paragraph 1.3~~ above; ~~and~~

~~iv.(d)~~ **a**Additional fuel if required, but not less than:

~~A.i.)~~ **f**For aeroplanes with reciprocating engines, fuel to fly for 45 minutes plus 15% of the flight time planned to be spent at cruising level or two hours, whichever is less; or

~~B.ii.)~~ **f**For aeroplanes with turbine engines, fuel to fly for two hours at normal cruise consumption above the destination aerodrome;

~~t~~**h**is ~~shall~~**should** not be less than final reserve fuel; and

~~v.(e)~~ **e**Extra fuel if required by the commander;

or

~~b.3.2~~ **t**The sum of:

~~i.(a)~~ **t**Taxi fuel; ~~and~~

~~ii.(b)~~ **t**Trip fuel from the departure aerodrome to the destination alternate aerodrome, via the predetermined point; ~~and~~

~~iii.(c)~~ **c**Contingency fuel calculated in accordance with ~~1.c.sub-paragraph 1.3~~ above; ~~and~~

~~iv.(d)~~ **a**Additional fuel if required, but not less than:

~~A.i.-~~ **f**For aeroplanes with reciprocating engines: fuel to fly for 45 minutes; or

~~B.ii.-~~ **f**For aeroplanes with turbine engines: fuel to fly for 30 minutes at holding speed at 1 500 ft (450 m) above the destination alternate aerodrome elevation in standard conditions.

~~t~~**h**is ~~shall~~**should** not be less than final reserve fuel; and

~~v.(e)~~ **e**Extra fuel if required by the commander.

4. Isolated ~~a~~**Aerodrome Procedure**~~procedure~~

If ~~an operator~~**the operator's** fuel policy includes planning to an isolated aerodrome, the last possible point of diversion to any available en-route alternate aerodrome ~~shall~~**should** be used as the pre-determined point. ~~See paragraph 3 above.~~

~~Appendix 2 to OPS 1.255~~**Fuel policy**

~~LOCATION OF THE 3% FUEL EN-ROUTE ALTERNATE (3% FUEL ERA) AERODROME FOR THE PURPOSES OF REDUCING CONTINGENCY FUEL TO 3% (SEE APPENDIX 1 TO OPS 1.255 (1.3)(A)(II) AND OPS 1.192).~~

1. The ~~3% fuel~~ ERA aerodrome ~~should~~**shall** be located within a circle having a radius equal to 20% of the total flight plan distance, the centre of which lies on the planned route at a distance from the destination aerodrome of 25% of the total flight plan distance, or at least 20% of the total flight plan distance plus 50-~~nm~~ **NM**,

Subpart D | Revised rule text

whichever is greater. All distances are to ~~be~~ **should** be calculated in still air conditions (see Figure 1).

Figure 1 Location of the 3% En-Route Alternate (3% ERA) aerodrome for the purposes of reducing contingency fuel to 3%

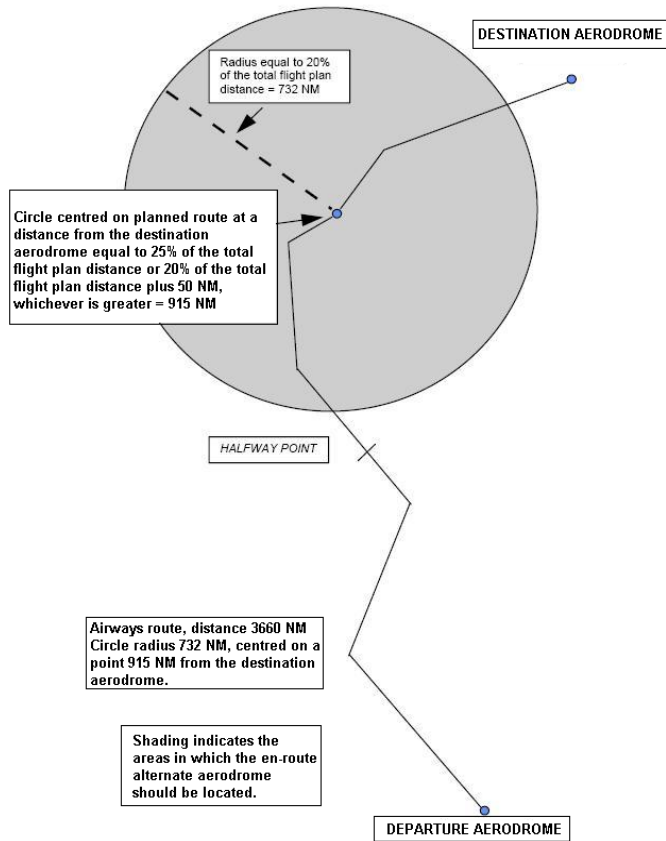

Figure 1: Location of the fuel ERA aerodrome for the purposes of reducing contingency fuel to 3%

Subpart D | Revised rule text

AMC1-CAT.OP.AH.160~~Appendix 1 to OPS 1.270~~ **Stowage of baggage and cargo**

STOWAGE PROCEDURES

Procedures established by ~~an operator~~ **the operator** to ensure that hand baggage and cargo ~~is~~ **are** adequately and securely stowed ~~should~~ **must** take account of the following:

- 1.1) ~~e~~ Each item carried in a cabin ~~must~~ **should** be stowed only in a location that is capable of restraining it;
- 2.2) ~~m~~ Mass limitations placarded on or adjacent to stowages ~~should~~ **must** not be exceeded;
- 3.3) ~~u~~ Under seat stowages ~~should~~ **must** not be used unless the seat is equipped with a restraint bar and the baggage is of such size that it may adequately be restrained by this equipment;
- 4.4) ~~i~~ Items ~~should~~ **must** not be stowed in ~~lavatories~~ ~~toilets~~ or against bulkheads that are incapable of restraining articles against movement forwards, sideways or upwards and unless the bulkheads carry a placard specifying the greatest mass that may be placed there;
- 5.5) ~~b~~ Baggage and cargo placed in lockers ~~should~~ **must** not be of such size that they prevent latched doors from being closed securely;
- 6.6) ~~b~~ Baggage and cargo ~~should~~ **must** not be placed where it can impede access to emergency equipment; and
- 7.7) ~~c~~ Checks ~~should~~ **must** be made before take-off, before landing, and whenever the fasten seat belts signs are illuminated or it is otherwise so ordered to ensure that baggage is stowed where it cannot impede evacuation from the aircraft or cause injury by falling (or other movement) as may be appropriate to the phase of flight.

AMC1-CAT.OP.AH.195~~Appendix 1 to OPS 1.305~~ **Refuelling/defuelling with passengers embarking, on board or disembarking**

OPERATIONAL PROCEDURES - AEROPLANES

...

3. Operational~~An operator must establish operational procedures~~ **should specify that at least**~~for re/defuelling with passengers embarking, on board or disembarking to ensure~~ the following precautions are taken:

- a.(1) ~~o~~ One qualified person ~~must~~ **should** remain at a specified location during fuelling operations with passengers on board. This qualified person ~~should~~ **must** be capable of handling emergency procedures concerning fire protection and fire-fighting, handling communications and initiating and directing an evacuation;
- b.(2) ~~t~~ ~~a~~ ~~t~~ Two-way communication ~~should~~ **shall** be established and ~~should~~ **shall** remain available by the aeroplane's inter-communication system or other suitable means between the ground crew supervising the refuelling and the qualified personnel on board the aeroplane;

Subpart D | Revised rule text

- c.~~(3)~~ **c**Crew, ~~staff~~**personnel** and passengers ~~should~~**must** be warned that re/defuelling will take place;
- d.~~(4)~~ "Fasten Seat Belts" signs ~~should~~**must** be off;
- e.~~(5)~~ "NO SMOKING" signs ~~should~~**must** be on, together with interior lighting to enable emergency exits to be identified;
- f.~~(6)~~ **p**Passengers ~~should~~**must** be instructed to unfasten their seat belts and refrain from smoking;
- g.~~(7)~~ **t**The minimum required number of cabin crew ~~specified by OPS 1.990~~**should** be on board and be prepared for an immediate emergency evacuation;
- h.~~(8)~~ **i**f the presence of fuel vapour is detected inside the aeroplane, or any other hazard arises during re/defuelling, fuelling ~~should~~**must** be stopped immediately;
- i.~~(9)~~ **t**The ground area beneath the exits intended for emergency evacuation and slide deployment areas ~~should~~**must** be kept clear **at doors where stairs are not in position for use in the event of evacuation;** and
- j.~~(10)~~ **p**Provision is made for a safe and rapid evacuation.

...

~~Appendix 1 to OPS 1.311~~Minimum number of cabin crew required to be on board an aeroplane during ground operations with passengers

~~When operating under OPS 1.311 an operator shall establish operational procedures to ensure that:~~

- ~~(1) — Electrical power is available on the aeroplane,~~
- ~~(2) — A means of initiating an evacuation is available to the senior cabin crew member, or at least one member of the flight crew is on the flight deck,~~
- ~~(3) — Cabin crew stations and associated duties are specified in the operations manual, and~~
- ~~(4) — Cabin crew remain aware of the position of servicing and loading vehicles at and near the exits.~~

Subpart D | Revised rule text

Part-CAT – AMC/GM

Subpart B – Operating procedures

Section I – Aeroplanes and Helicopters

AMC1-CAT.OP.AH.105 Use of aerodromes and operating sites

DEFINING OPERATING SITES - HELICOPTERS

When defining operating sites (including infrequent or temporary sites) for the type(s) of helicopter(s) and operation(s) concerned, the operator should take account of the following:

1. An adequate site is a site that the operator considers to be satisfactory, taking account of the applicable performance requirements and site characteristics (guidance on standards and criteria are contained in ICAO Annex 14 Volume 2 and in the ICAO *Helicopter Manual* (Doc 9261-AN/903)).
2. The operator should have in place a procedure for the survey of sites by a competent person. Such a procedure should take account for possible changes to the site characteristics which may have taken place since last surveyed.
3. Sites that are presurveyed should be specifically specified in the operations manual. The operations manual should contain diagrams or/and ground and aerial photographs, and depiction (pictorial) and description of:
 - a. the overall dimensions of the site;
 - b. location and height of relevant obstacles to approach and take-off profiles, and in the manoeuvring area;
 - c. approach and take-off flight paths;
 - d. surface condition (blowing dust/snow/sand);
 - e. helicopter types authorised with reference to performance requirements;
 - f. provision of control of third parties on the ground (if applicable);
 - g. procedure for activating site with land owner or controlling authority;
 - h. other useful information, for example appropriate ATS agency and frequency; and
 - j. lighting (if applicable).
4. For sites that are not pre-surveyed, the operator should have in place a procedure that enables the pilot to make, from the air, a judgment on the suitability of a site. 3.a. to 3.f. should be considered.

Subpart D | Revised rule text

5. **Operations to non-pre-surveyed sites by night (except in accordance with SPA.HEMS.125, (b)(3)) should not be permitted.**

HELIDECK

6. **The content of Part C of the operations manual relating to the specific usage of helidecks should contain both the listing of helideck limitations in a helideck limitations list (HLL) and a pictorial representation (template) of each helideck showing all necessary information of a permanent nature. The HLL should show, and be amended as necessary to indicate, the most recent status of each helideck concerning non-compliance with ICAO Annex 14 Volume 2, limitations, warnings, cautions or other comments of operational importance. An example of a typical template is shown in Figure 1 below.**
7. **In order to ensure that the safety of flights is not compromised, the operator should obtain relevant information and details for compilation of the HLL, and the pictorial representation, from the owner/operator of the helideck.**
8. **When listing helidecks, if more than one name of the helideck exists, the most common name should be used, other names should also be included. After renaming a helideck, the old name should be included in the HLL for the ensuing six months.**
9. **All helideck limitations should be included in the HLL. Helidecks without limitations should also be listed. With complex installations and combinations of installations (e.g. co-locations), a separate listing in the HLL, accompanied by diagrams where necessary, may be required.**
10. **Each helideck should be assessed based on limitations, warnings, cautions or comments to determine its acceptability with respect to the following which, as a minimum, should cover the factors listed below:**
- a. **The physical characteristics of the helideck.**
 - b. **The preservation of obstacle-protected surfaces is the most basic safeguard for all flights.**
These surfaces are:
 - i. **the minimum 210° obstacle-free surface (OFS);**
 - ii. **the 150° limited obstacle surface (LOS); and**
 - iii. **the minimum 180° falling "5:1" - gradient with respect to significant obstacles. If this is infringed or if an adjacent installation or vessel infringes the obstacle clearance surfaces or criteria related to a helideck, an assessment should be made to determine any possible negative effect that may lead to operating restrictions.**
 - c. **Marking and lighting:**
 - i. **adequate perimeter lighting;**
 - ii. **adequate floodlighting;**

Subpart D | Revised rule text

- iii. **status lights (for night and day operations e.g. signalling lamp);**
 - iv. **dominant obstacle paint schemes and lighting;**
 - v. **helideck markings; and**
 - vi. **general installation lighting levels. Any limitations in this respect should be annotated "daylight only operations" on the HLL.**
- d. Deck surface:**
- i. **surface friction;**
 - ii. **helideck net;**
 - iii. **drainage system;**
 - iv. **deck edge netting;**
 - v. **tie down system; and**
 - vi. **cleaning of all contaminants.**
- e. Environment:**
- i. **foreign object damage;**
 - ii. **physical turbulence generators;**
 - iii. **bird control;**
 - iv. **air quality degradation due to exhaust emissions, hot gas vents or cold gas vents; and**
 - v. **adjacent helideck may need to be included in air quality assessment.**
- f. Rescue and fire fighting:**
- i. **primary and complementary media types, quantities, capacity and systems personal protective equipment and clothing, breathing apparatus; and**
 - ii. **crash box;**
- g. Communications & navigation:**
- i. **aeronautical radio(s);**
 - ii. **radio/telephone (R/T) call sign to match helideck name and side identification which should be simple and unique;**
 - iii. **Non directional beacon (NDB) or equivalent (as appropriate);**
 - iv. **radio log; and**
 - v. **light signal (e.g. signalling lamp).**
- h. Fuelling facilities:**
- i. **in accordance with the relevant national guidance and regulations.**
- i. Additional operational and handling equipment:**

Subpart D | Revised rule text

- i. **windsock;**
 - ii. **wind recording;**
 - iii. **deck motion recording and reporting where applicable;**
 - iv. **passenger briefing system;**
 - v. **chocks;**
 - vi. **tie downs; and**
 - vii. **weighing scales.**
- j. Personnel:**
- i. **trained helideck staff (e.g. helicopter landing officer/helicopter deck assistant and fire fighters etc.).**
- k. Other:**
- i. **as appropriate.**
- 11. For helidecks about which there is incomplete information, 'limited' usage based on the information available may be specified by the operator prior to the first helicopter visit. During subsequent operations and before any limit on usage is lifted, information should be gathered and the following should apply:**
- a. Pictorial (static) representation:**
 - i. **template (see figure 1) blanks should be available, to be filled out during flight preparation on the basis of the information given by the helideck owner/operator and flight crew observations;**
 - ii. **where possible, suitably annotated photographs may be used until the HLL and template have been completed;**
 - iii. **until the HLL and template have been completed, operational restrictions (e.g. performance, routing etc.) may be applied;**
 - iv. **any previous inspection reports should be obtained by the operator; and**
 - v. **an inspection of the helideck should be carried out to verify the content of the completed HLL and template, following which the helideck may be considered as fully adequate for operations.**
 - b. With reference to the above, the HLL should contain at least the following:**
 - i. **HLL revision date and number;**
 - ii. **generic list of helideck motion limitations;**
 - iii. **name of helideck;**
 - iv. **'D' value; and**
 - v. **limitations, warnings, cautions and comments.**

Subpart D | Revised rule text

- c. The template should contain at least the following (see example below):**
- i. installation/vessel name;**
 - ii. R/T call sign;**
 - iii. helideck identification marking;**
 - iv. side panel identification marking;**
 - v. helideck elevation;**
 - vi. maximum installation/vessel height;**
 - vii. 'D' value;**
 - viii. type of installation/vessel;**
 - fixed manned**
 - fixed unmanned**
 - ship type (e.g. diving support vessel)**
 - semi-submersible**
 - jack-up**
 - ix. name of owner/operator;**
 - x. geographical position;**
 - xi. Communication and navigation (Com/Nav) frequencies and ident;**
 - xii. general drawing preferably looking into the helideck with annotations showing location of derrick, masts, cranes, flare stack, turbine and gas exhausts, side identification panels, windsock etc.;**
 - xiii. plan view drawing, chart orientation from the general drawing, to show the above. The plan view will also show the 210° orientation in degrees true;**
 - xiv. type of fuelling:**
 - pressure and gravity**
 - pressure only**
 - gravity only**
 - none**
 - xv. type and nature of fire fighting equipment;**
 - xvi. availability of GPU;**
 - xvii. deck heading;**
 - xviii. maximum allowable mass;**
 - xix. status light (Yes/No); and**

Subpart D | Revised rule text

xx. revision date of publication.

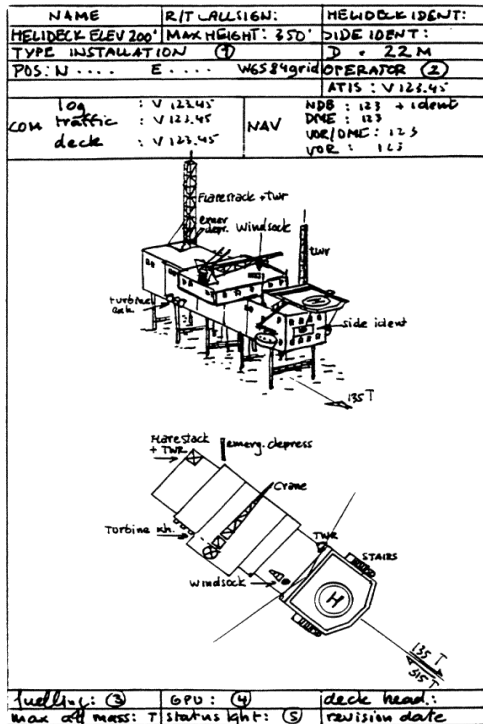

1. Fixed manned; fixed unmanned; small ship; large ship; semi-submersible; jack-up.
2. NAM, AMOCO etc.
3. Pressure/gravity; pressure; gravity; no.
4. Yes; no; 28V DC.
5. Yes; no.

Figure 1 – Helideck template

Formatted: Font: Bold

GM1-CAT.OP.AH.130 Noise abatement procedures

Comment [WSI63]:
ACJ to JAR-OPS 1.235

TERMINOLOGY

1. 'Climb profile' means in this context the vertical path of the NADP as it results from the pilot's actions (engine power reduction, acceleration, slats/flaps retraction).
2. 'Sequence of actions' means the order in which these pilot's actions are done and their timing.

*Subpart D | Revised rule text***GENERAL**

3. The requirement addresses only the vertical profile of the departure procedure. Lateral track has to comply with the Standard Instrument Departure (SID).

EXAMPLE

4. For a given aeroplane type, when establishing the distant NADP, the operator should choose either to reduce power first and then accelerate, or to accelerate first and then wait until slats/flaps are retracted before reducing power. The two methods constitute two different sequences of actions.
5. For an aeroplane type, each of the two departure climb profiles may be defined by one sequence of actions (one for close-in, one for distant) and two above aerodrome level (AAL) altitudes/heights. These are:
 - a. the altitude of the first pilot's action (generally power reduction with or without acceleration). This altitude should not be less than 800 ft AAL; or
 - b. the altitude of the end of the noise abatement procedure. This altitude should usually not be more than 3 000 ft AAL.

These two altitudes may be runway specific when the aeroplane flight management system (FMS) has the relevant function which permits the crew to change thrust reduction and/or acceleration altitude/height. If the aeroplane is not FMS equipped or the FMS is not fitted with the relevant function, two fixed heights should be defined and used for each of the two NADPs.

GM1-CAT.OP.AH.137(a)(2) Routes and areas of operation - helicopters**COASTAL TRANSIT**

1. General
 - a. A helicopter operating overwater in performance class 3 has to have certain equipment fitted. This equipment varies with the distance from land that the helicopter is expected to operate. The aim of this GM is to discuss that distance, bring into focus what fit is required and to clarify the operator's responsibility, when a decision is made to conduct coastal transit operations.
 - b. In the case of operations north of 45N or south of 45S, the coastal corridor facility may or may not be available in a particular state, as it is related to the State definition of open sea area as described in the definition of hostile environment.
 - c. Where the term 'coastal transit' is used, it means the conduct of operations overwater within the coastal corridor in conditions where there is reasonable expectation that
 - i. the flight can be conducted safely in the conditions prevailing;

Subpart D | Revised rule text

- ii. following an engine failure, a safe forced landing and successful evacuation can be achieved; and

survival of the crew and passengers can be assured until rescue is effected.

- d. Coastal corridor is a variable distance from the coastline to a maximum distance corresponding to three minutes' flying at normal cruising speed.

2. Establishing the width of the coastal corridor

- a. The maximum distance from land of coastal transit, is defined as the boundary of a corridor that extends from the land, to a maximum distance of up to three minutes at normal cruising speed (approximately 5 - 6 NM). Land in this context includes sustainable ice (see a. to c. below) and, where the coastal region includes islands, the surrounding waters may be included in the corridor and aggregated with the coast and each other. Coastal transit need not be applied to inland waterways, estuary crossing or river transit.

- i. In some areas, the formation of ice is such that it can be possible to land, or force land, without hazard to the helicopter or occupants. Unless the competent authority considers that operating to, or over, such ice fields is unacceptable, the operator may regard the definition of the "land" extends to these areas.

- ii. The interpretation of the following rules may be conditional on a. above:

CAT.OP.AH.137(a)(2)

CAT.IDE.H.290

CAT.IDE.H.295

CAT.IDE.H.300

CAT.IDE.H.320.

- iii. In view of the fact that such featureless and flat white surfaces could present a hazard and could lead to white-out conditions, the definition of land does not extend to flights over ice fields in the following rules:

CAT.IDE.H.125, (d)

CAT.IDE.H.145.

- b. The width of the corridor is variable from not safe to conduct operations in the conditions prevailing, to the maximum of three minutes wide. A number of factors will, on the day, indicate if it can be used - and how wide it can be. These factors will include but not be restricted to:

Subpart D | Revised rule text

- i. the meteorological conditions prevailing in the corridor;
 - ii. the instrument fit of the aircraft;
 - iii. the certification of the aircraft - particularly with regard to floats;
 - iv. the sea state;
 - v. the temperature of the water;
 - vi. the time to rescue; and
 - vii. the survival equipment carried.
- c. These can be broadly divided into three functional groups:
- i. those which meet the requirement for safe flying – b.i. and ii.;
 - b. those which meet the requirement for a safe forced landing and evacuation – b.i. to iv.; and
 - c. those which meet the requirement for survival following a forced landing and successful evacuation – b.i., iv. to vii..

3. Requirement for safe flying

- a. It is generally recognised that when flying out of sight of land in certain meteorological conditions, such as occur in high pressure weather patterns (goldfish bowl - no horizon, light winds and low visibility), the absence of a basic panel (and training) can lead to disorientation. In addition, lack of depth perception in these conditions demands the use of a radio altimeter with an audio voice warning as an added safety benefit - particularly when autorotation to the surface of the water may be required.
- b. In these conditions a helicopter, without the required instruments and radio altimeter, should be confined to a corridor in which the pilot can maintain reference using the visual cues on the land.

4. Requirement for a safe forced landing and evacuation

- a. Weather and sea state both affect the outcome of an autorotation following an engine failure. It is recognised that the measurement of sea state is problematical and when assessing such conditions, good judgement has to be exercised by the operator and the commander.
- b. Where floats have been certificated only for emergency use (and not for ditching), operations should be limited to those sea states which meet the requirement for such use - where a safe evacuation is possible.

Ditching certification requires compliance with a comprehensive number of requirements relating to rotorcraft water entry, flotation and trim, occupant egress and occupant survival. Emergency flotation systems, generally fitted to smaller CS-27 rotorcraft, are approved against a broad requirement that the equipment should perform its intended function and not hazard the rotorcraft or its occupants. In

Subpart D | Revised rule text

practice, the most significant difference between ditching and emergency flotation systems is substantiation of the water entry phase. Ditching requirements call for water entry procedures and techniques to be established and promulgated in the AFM. The fuselage/flotation equipment should thereafter be shown to be able to withstand loads under defined water entry conditions which relate to these procedures. For emergency flotation equipment, there is no requirement to define the water entry technique and no specific conditions defined for the structural substantiation.

5. Requirements for survival

- a. Survival of crew members and passengers, following a successful autorotation and evacuation, is dependent on the clothing worn, the equipment carried and worn, the temperature of the sea and the sea state. Search and rescue response/capability consistent with the anticipated exposure should be available before the conditions in the corridor can be considered non-hostile.
- b. Coastal transit can be conducted (including north of 45N and south of 45S - when the definition of open sea areas allows) providing the requirements of 3. and 4. are met, and the conditions for a non-hostile coastal corridor are satisfied.

AMC1-CAT.OP.AH.150 Fuel policy**PLANNING CRITERIA - HELICOPTER**

The operator should base the company fuel policy, including calculation of the amount of fuel to be carried, on the following planning criteria:

1. The amount of:
 - a. taxi fuel, which should not be less than the amount expected to be used prior to take-off. Local conditions at the departure site and APU consumption should be taken into account;
 - b. trip fuel, which should include:
 - i. fuel for take-off and climb from aerodrome elevation to initial cruising level/altitude, taking into account the expected departure routing;
 - ii. fuel from top of climb to top of descent, including any step climb/descent;
 - iii. fuel from top of descent to the point where the approach procedure is initiated, taking into account the expected arrival procedure; and
 - iv. fuel for approach and landing at the destination site.
 - c. contingency fuel, which should be:
 - i. for IFR flights, or for VFR flights in a hostile environment, 10% of the planned trip fuel; or

Subpart D | Revised rule text

- ii. for VFR flights in a non-hostile environment, 5% of the planned trip fuel;
 - d. alternate fuel, which should be:
 - i. fuel for a missed approach from the applicable MDA/DH at the destination aerodrome to missed approach altitude, taking into account the complete missed approach procedure;
 - ii. fuel for a climb from missed approach altitude to cruising level/altitude;
 - iii. fuel for the cruise from top of climb to top of descent;
 - iv. fuel for descent from top of descent to the point where the approach is initiated, taking into account the expected arrival procedure;
 - v. fuel for executing an approach and landing at the destination alternate selected in accordance with CAT.OP.AH.181; and
 - vi. or helicopters operating to or from helidecks located in a hostile environment, 10% of 1.d.i. to v. above.
 - e. final reserve fuel, which should be:
 - i. for VFR flights navigating by day with reference to visual landmarks, 20 minutes' fuel at best range speed; or
 - ii. for IFR flights or when flying VFR and navigating by means other than by reference to visual landmarks or at night, fuel to fly for 30 minutes at holding speed at 1 500 ft (450 m) above the destination aerodrome in standard conditions calculated with the estimated mass on arrival above the alternate, or the destination, when no alternate is required;

and
 - f. extra fuel, which should be at the discretion of the commander.
2. Isolated aerodrome IFR procedure
- If the operator's fuel policy includes planning to an isolated aerodrome flying IFR, or when flying VFR and navigating by means other than by reference to visual landmarks, for which a destination alternate does not exist, the amount of fuel at departure should include:
- a. taxi fuel;
 - b. trip fuel;
 - c. contingency fuel calculated in accordance with 1.c. above;
 - d. additional fuel to fly for two hours at holding speed, including final reserve fuel; and
 - e. extra fuel at the discretion of the commander.

Subpart D | Revised rule text

3. **Sufficient fuel should be carried at all times to ensure that following the failure of an engine occurring at the most critical point along the route, the helicopter is able to:**
 - a. **descend as necessary and proceed to an adequate aerodrome;**
 - b. **hold there for 15 minutes at 1 500 ft (450 m) above aerodrome elevation in standard conditions; and**
 - c. **make an approach and landing.**

GM1-CAT.OP.AH.150 Fuel policy**CONTINGENCY FUEL STATISTICAL METHOD - AEROPLANES**

1. **As an example, the following values of statistical coverage of the deviation from the planned to the actual trip fuel provide appropriate statistical coverage.**
 - a. **99% coverage plus 3% of the trip fuel, if the calculated flight time is less than two hours, or more than two hours and no suitable ERA aerodrome is available.**
 - b. **99% coverage if the calculated flight time is more than two hours and a suitable ERA aerodrome is available.**
 - c. **90% coverage if:**
 - i. **the calculated flight time is more than two hours;**
 - ii. **a suitable ERA aerodrome is available; and**
 - iii. **at the destination aerodrome two separate runways are available and usable, one of which is equipped with an ILS/MLS, and the weather conditions are in compliance with GM1-CAT.OP.AH.180, or the ILS/MLS is operational to CAT II/III operating minima and the weather conditions are at or above 500 ft.**
2. **The fuel consumption database used in conjunction with these values should be based on fuel consumption monitoring for each route/aeroplane combination over a rolling two-year period.**

GM1-CAT.OP.AH.150(c)(3)(i) Fuel policy**CONTINGENCY FUEL**

Factors that may influence fuel required on a particular flight in an unpredictable way include deviations of an individual aeroplane from the expected fuel consumption data, deviations from forecast meteorological conditions and deviations from planned routings and/or cruising levels/altitudes.

*Subpart D | Revised rule text***GM1-CAT.OP.AH.150(c)(3)(ii) Fuel policy****DESTINATION ALTERNATE AERODROME**

The departure aerodrome may be selected as the destination alternate aerodrome.

AMC1-CAT.OP.AH.155 Carriage of special categories of passengers (SCPs)**GENERAL**

The procedures established by the operator for the carriage of special categories of passengers should take into account:

1. the number and the categories of such passengers;
2. the total number of passengers carried on board;
3. the aircraft type and cabin configuration; and
3. the number and composition of the operating crew.

GM1-CAT.OP.AH.155 Carriage of special categories of passengers (SCPs)**GENERAL**

Persons who should be considered as special categories of passengers requiring special conditions, assistance and/or devices when carried on a flight, include:

1. persons with reduced mobility (PRMs); this is understood to mean persons whose mobility is reduced due to physical incapacity, (sensory or locomotory), an intellectual deficiency, age, illness or any other cause of disability;
2. children (whether accompanied or not) and infants;
3. passengers with animals; and
4. deportees, inadmissible passengers or prisoners in custody.

AMC1-CAT.OP.AH.160 Stowage of baggage and cargo

...

CARRIAGE OF CARGO IN THE PASSENGER CABIN

The following should be observed before carrying cargo in the passenger compartment:

1. for aeroplanes, dangerous goods should not be allowed;
2. for aeroplanes, a mix of passengers and live animals should only be allowed for pets weighing not more than 8 kg and guide dogs;
3. the mass of cargo should not exceed the structural loading limits of the floor or seats;

Comment [WSI64]:
AMC OPS 1.270

Subpart D | Revised rule text

4. the number/type of restraint devices and their attachment points should be capable of restraining the cargo in accordance with applicable certification specifications; and
5. the location of the cargo should be such that, in the event of an emergency evacuation, it will not hinder egress nor impair the crew's view.

AMC1-CAT.OP.AH.165 Passenger seating

Comment [WSI65]:
ACJ OPS 1.280, ACJ OPS 3.280

PROCEDURES

1. The operator should make provision so that:
 - a. those passengers who are allocated seats that permit direct access to emergency exits appear to be reasonably fit, strong and able to assist the rapid evacuation of the aircraft in an emergency after an appropriate briefing by the crew;
 - b. in all cases, passengers who, because of their condition, might hinder other passengers during an evacuation or who might impede the crew in carrying out their duties, should not be allocated seats that permit direct access to emergency exits. If procedures cannot be reasonably implemented at the time of passenger 'check-in', the operator should establish an alternative procedure which ensures that the correct seat allocations will, in due course, be made.
2. 1. above should not apply to aircraft where the normal exit also serves as an emergency exit. However in these circumstances, the operator should ensure when choosing passengers to sit next to a normal exit, that evacuation is not hindered in the case of an emergency.

ACCESS TO EMERGENCY EXITS

Comment [WSI66]:
[ACJ] OPS 1.280

3. The following categories of passengers are among those who should not be allocated to, or directed to seats that permit direct access to emergency exits:
 - a. passengers suffering from obvious physical or mental handicap to the extent that they would have difficulty in moving quickly if asked to do so;
 - b. passengers who are either substantially blind or substantially deaf to the extent that they might not readily assimilate printed or verbal instructions given;
 - c. passengers who because of age or sickness are so frail that they have difficulty in moving quickly;
 - d. passengers who are so obese that they would have difficulty in moving quickly or reaching and passing through the adjacent emergency exit;
 - e. children (whether accompanied or not) and infants;
 - f. deportees or persons in custody; and

Subpart D | Revised rule text

- g. passengers with animals.**

GM1-CAT.OP.AH.165 Passenger seating

Comment [WSI67]:
ACJ OPS 1.280, ACJ OPS 3.280

“Direct access” means a seat from which a passenger can proceed directly to the exit without entering an aisle or passing around an obstruction.

AMC1-CAT.OP.AH.175(a) Flight preparation

Comment [WSI68]:
Transposed from OPS 1.1060

OPERATIONAL FLIGHT PLAN – COMPLEX MOTOR-POWERED AIRCRAFT

- 1. The operational flight plan used and the entries made during flight should contain the following items:**
 - a. aircraft registration;**
 - b. aircraft type and variant;**
 - c. date of flight;**
 - d. flight identification;**
 - e. names of flight crew members;**
 - f. duty assignment of flight crew members;**
 - g. place of departure;**
 - h. time of departure (actual off-block time, take-off time);**
 - i. place of arrival (planned and actual);**
 - j. time of arrival (actual landing and on-block time);**
 - k. type of operation (ETOPS, VFR, ferry flight, etc.);**
 - l. route and route segments with checkpoints/waypoints, distances, time and tracks;**
 - m. planned cruising speed and flying times between check-points/waypoints (estimated and actual times overhead);**
 - n. safe altitudes and minimum levels;**
 - o. planned altitudes and flight levels;**
 - p. fuel calculations (records of in-flight fuel checks);**
 - q. fuel on board when starting engines;**
 - r. alternate(s) for destination and, where applicable, take-off and en-route, including information required in 1.l.-o. above;**
 - s. initial ATS flight plan clearance and subsequent reclearance;**
 - t. in-flight replanning calculations; and**
 - u. relevant meteorological information.**
- 2. Items that are readily available in other documentation or from another acceptable source or are irrelevant to the type of operation may be omitted from the operational flight plan.**

Comment [WSI69]:
This shall cover any alleviation of operations of smaller aircraft from Appendix 1 to OPS 1.005 16.

Subpart D | Revised rule text

3. The operational flight plan and its use should be described in the operations manual.
4. All entries on the operational flight plan should be made concurrently and be permanent in nature.

OPERATIONAL FLIGHT PLAN - OTHER-THAN-COMPLEX MOTOR-POWERED AIRCRAFT AND LOCAL OPERATIONS

An operational flight plan may be established in a simplified form relevant to the kind of operation.

GM1-CAT.OP.AH.175(b)(5) Flight preparation

CONVERSION TABLES

The documentation should include any conversion tables necessary to support operations where metric heights, altitudes and flight levels are used.

AMC1-CAT.OP.AH.180 Selection of aerodromes - aeroplanes

Comment [WSI70]:
AMC OPS 1.245(a)(2)

OPERATIONAL CRITERIA FOR SMALL TWO-ENGINE AEROPLANES WITHOUT ETOPS CAPABILITY

1. For operations between 120 and 180 minutes, due account should be taken of the aeroplane's design and capabilities as outlined below and the operator's experience related to such operations. Relevant information should be included in the operations manual and the operator's maintenance procedures. The term "the aeroplane's design" in this AMC does not imply any additional type design approval requirements beyond the applicable original type certification (TC) requirements.

2. **Systems capability**

Aeroplanes should be certificated to CS-25 as appropriate or equivalent (e.g. FAR-25). With respect to the capability of the aeroplane systems, the objective is that the aeroplane is capable of a safe diversion from the maximum diversion distance with particular emphasis on operations with OEI or with degraded system capability. To this end, the operator should give consideration to the capability of the following systems to support such a diversion:

- a. **Propulsion systems** - the aeroplane engine should meet the applicable requirements prescribed in CS-25 and CS-E or equivalent (e.g. FAR-25, FAR-E), concerning engine TC, installation and system operation. In addition to the performance standards established by the Agency or competent authority at the time of engine certification, the engines should comply with all subsequent mandatory safety standards specified by the Agency or competent authority, including those necessary to maintain an acceptable level of reliability. In addition, consideration should be given to the effects of extended duration single-engine operation (e.g. the effects of higher power demands such as bleed and electrical).

Subpart D | Revised rule text

- b. Airframe systems - with respect to electrical power, three or more reliable as defined by CS-25 or equivalent (e.g. FAR-25) and independent electrical power sources should be available, each of which should be capable of providing power for all essential services which should at least include the following:**
- i. sufficient instruments for the flight crew providing, as a minimum, attitude, heading, air speed and altitude information;**
 - ii. appropriate pitot heating;**
 - iii. adequate navigation capability;**
 - iv. adequate radio communication and intercommunication capability;**
 - v. adequate flight deck and instrument lighting and emergency lighting;**
 - vi. adequate flight controls;**
 - vii. adequate engine controls and restart capability with critical type fuel (from the stand-point of flame-out and restart capability) and with the aeroplane initially at the maximum relight altitude;**
 - viii. adequate engine instrumentation;**
 - ix. adequate fuel supply system capability including such fuel boost and fuel transfer functions that may be necessary for extended duration single or dual-engine operation;**
 - x. such warnings, cautions and indications as are required for continued safe flight and landing;**
 - xi. fire protection (engines and APU);**
 - xii. adequate ice protection including windshield de-icing; and**
 - xiii. adequate control of the flight deck and cabin environment including heating and pressurisation.**

The equipment including avionics necessary for extended diversion times should have the ability to operate acceptably following failures in the cooling system or electrical power systems.

For single-engine operations, the remaining power electrical, hydraulic, and pneumatic should continue to be available at levels necessary to permit continued safe flight and landing, and to provide those services necessary for the overall safety of the passengers and crew. As a minimum, following the failure of any two of the three electrical power sources, the remaining source should be capable of providing power for all of the items necessary for the duration of any diversion. If one or more of the required electrical power sources are provided by an APU, hydraulic system or air driven generator/ram air turbine (ADG/RAT), the following criteria should apply as appropriate:

Subpart D | Revised rule text

- A. to ensure hydraulic power (hydraulic motor generator) reliability, it may be necessary to provide two or more independent energy sources;
 - B. the ADG/RAT, if fitted, should not require engine dependent power for deployment; and
 - C. the APU should meet the criteria in 2.c..
 - c. APU - the APU, if required for extended range operations, should be certificated as an essential APU and should meet the applicable CS-25 and CS-APU provisions or equivalent (e.g. FAR-25).
 - d. Fuel supply system - consideration should include the capability of the fuel supply system to provide sufficient fuel for the entire diversion taking account of aspects such as fuel boost and fuel transfer.
- 3. Engine events and corrective action**
- a. All engine events and operating hours should be reported by the operator to the airframe and engine supplemental type certificate (STC) holders as well as to the competent authority.
 - b. These events should be evaluated by the operator in consultation with the competent authority and with the engine and airframe (S)TC holders. The competent authority may consult the Agency to ensure that world wide data is evaluated.
 - c. Where statistical assessment alone is not applicable, e.g. where the fleet size or accumulated flight hours are small, individual engine events should be reviewed on a case-by-case basis.
 - d. The evaluation or statistical assessment, when available, may result in corrective action or the application of operational restrictions.
 - e. Engine events could include engine shut downs, both on ground and in-flight, excluding normal training events, including flameout, occurrences where the intended thrust level was not achieved or where crew action was taken to reduce thrust below the normal level for whatever reason, and unscheduled removals.
 - f. Arrangements to ensure that all corrective actions required by the Agency are implemented.
- 4. Maintenance**
- The maintenance programme in accordance with Part-M should be based upon reliability programmes including, but not limited to, the following elements:
- a. engine oil consumption programmes - such programmes are intended to support engine condition trend monitoring; and
 - b. engine condition monitoring programme - a programme for each engine that monitors engine performance parameters and trends of degradation that provides for maintenance actions to be undertaken prior to significant performance loss or mechanical failure.

*Subpart D | Revised rule text***5. Flight crew training**

Flight crew training for this type of operation should include, in addition to the requirements of OR.OPS.FC, particular emphasis on the following:

- a. Fuel management - verifying required fuel on board prior to departure and monitoring fuel on board en-route including calculation of fuel remaining. Procedures should provide for an independent cross-check of fuel quantity indicators, e.g. fuel flow used to calculate fuel burned compared to indicate fuel remaining. Confirmation that the fuel remaining is sufficient to satisfy the critical fuel reserves.
- b. Procedures for single and multiple failures in-flight that may give rise to go/no-go and diversion decisions - policy and guidelines to aid the flight crew in the diversion decision making process and the need for constant awareness of the closest suitable alternate aerodrome in terms of time.
- c. OEI performance data - drift down procedures and OEI service ceiling data.
- d. Weather reports and flight requirements – meteorological aerodrome reports (METARs) and aerodrome forecast (TAF) reports and obtaining in-flight weather updates on the ERA, destination and destination alternate aerodromes. Consideration should also be given to forecast winds including the accuracy of the forecast compared to actual wind experienced during flight and meteorological conditions along the expected flight path at the OEI cruising altitude and throughout the approach and landing.

6. Pre-departure check

A pre-departure check, additional to the pre-flight inspection required by Part-M should be reflected in the operations manual. Flight crew members who are responsible for the pre-departure check of an aeroplane should be fully trained and competent to do it. The training programme required should cover all relevant tasks with particular emphasis on checking required fluid levels.

7. MEL

The MEL should take into account all items specified by the manufacturer relevant to operations in accordance with this AMC.

8. Dispatch/flight planning requirements

The operator's dispatch requirements should address the following:

- a. Fuel and oil supply - an aeroplane should not be dispatched on an extended range flight unless it carries sufficient fuel and oil to comply with the applicable operational requirements and any additional reserves determined in accordance with the following:
 - i. Critical fuel scenario - the critical point is the furthest point from an alternate aerodrome assuming a simultaneous failure of an engine and the pressurisation system. For those aeroplanes that

Subpart D | Revised rule text

are type certificated to operate above flight level 450, the critical point is the furthest point from an alternate aerodrome assuming an engine failure. The operator should carry additional fuel for the worst case fuel burn condition (one engine vs. two engines operating), if this is greater than the additional fuel calculated in accordance with the fuel requirements in CAT.OP.AH, as follows:

- A. fly from the critical point to an alternate aerodrome:
 - 1. at 10 000 ft;
 - 2. at 25 000 ft or the single-engine ceiling, whichever is lower, provided that all occupants can be supplied with and use oxygen for the time required to fly from the critical point to an alternate aerodrome; or
 - 3. at the single-engine ceiling, provided that the aeroplane is type certificated to operate above flight level 450;
 - B. descend and hold at 1 500 ft for 15 minutes in international standard atmosphere (ISA) conditions;
 - C. descend to the applicable MDA/DH followed by a missed approach (taking into account the complete missed approach procedure); followed by
 - D. a normal approach and landing.
- ii. Ice protection - additional fuel used when operating in icing conditions (e.g. operation of ice protection systems (engine/airframe as applicable)) and, when manufacturer's data is available, take account of ice accumulation on unprotected surfaces if icing conditions are likely to be encountered during a diversion.
 - iii. APU operation - if an APU has to be used to provide additional electrical power, consideration should be given to the additional fuel required.
- b. Communication facilities - the availability of communications facilities in order to allow reliable two-way voice communications between the aeroplane and the appropriate ATC unit at OEI cruise altitudes.
 - c. Aircraft technical log review to ensure proper MEL procedures, deferred items, and required maintenance checks completed.
 - d. ERA aerodrome(s) - ensuring that ERA aerodromes are available for the intended route, within 180 minutes based upon the OEI cruising speed which is a speed within the certificated limits of the aeroplane, selected by the operator, and confirmation that, based on the available meteorological information, the weather conditions at ERA aerodromes are at or above the applicable minima for the period of time during which the aerodrome(s) may be used.

*Subpart D | Revised rule text***Table 1: Planning minima**

Approach facility	Alternate aerodrome ceiling	Weather minima RVR/VIS
PA	DH/DA +200 ft	RVR/VIS +800 m
NPA Circling Approach	MDH/A +400 ft	RVR/VIS +1 500 m

Subpart D | Revised rule text

GM1-CAT.OP.AH.180 Selection of aerodromes - aeroplanes

APPLICATION OF AERODROME FORECASTS

APPLICATION OF AERODROME FORECASTS (TAF & TREND) TO PRE-FLIGHT PLANNING (ICAO Annex 3 refers)																																																														
<p>1. APPLICATION OF INITIAL PART OF TAF Applicable time period: a. From the start of the TAF validity period up to the time of applicability of the first subsequent 'FM...*' or 'BECMG' or, if no 'FM' or 'BECMG' is given, up to the end of the validity period of the TAF. b. The prevailing weather conditions forecast in the initial part of the TAF should be fully applied with the exception of the mean wind and gusts (and crosswind) which should be applied in accordance with the policy in the column 'BECMG AT and FM' in the table below. This may however be overruled temporarily by a 'TEMPO' or 'PROB**' if applicable according to the table below.</p>																																																														
<p>2. APPLICATION OF FORECAST FOLLOWING CHANGE INDICATORS IN TAF AND TREND</p> <table border="1"> <thead> <tr> <th rowspan="2">TAF or TREND for AERODROME PLANNED AS:</th> <th colspan="2">FM (alone) and BECMG AT:</th> <th colspan="2">BECMG (alone), BECMG FM, BECMG TL, BECMG FM...* TL in case of:</th> <th colspan="2">TEMPO (alone), TEMPO FM, TEMPO TL, TEMPO FM...* TL, PROB 30/40 (alone)</th> <th rowspan="2">PROB TEMPO</th> </tr> <tr> <th>Deterioration and Improvement</th> <th>Deterioration</th> <th>Improvement</th> <th>Deterioration</th> <th>Improvement</th> </tr> </thead> <tbody> <tr> <td>DESTINATION at ETA ± 1 hr</td> <td>Applicable from the start of the change</td> <td>Applicable from the time of start of change</td> <td>Applicable from the time of start of change</td> <td>Not applicable</td> <td>Applicable</td> <td>Applicable</td> <td>Deterioration may be disregarded; Improvement should be disregarded including mean wind and gusts</td> </tr> <tr> <td>TAKE-OFF ALTERNATE at ETA ± 1 hr</td> <td>Mean wind should be within required limits</td> <td></td> <td></td> <td>Mean wind should be within required limits</td> <td></td> <td></td> <td></td> </tr> <tr> <td>ENROUTE ALTERNATE at ETA ± 1 hr</td> <td>Gusts may be disregarded</td> <td></td> <td></td> <td>Mean wind and gusts exceeding required limits may be disregarded</td> <td></td> <td></td> <td></td> </tr> <tr> <td>ETOPS ENROUTE ALTERNATE at earliest/latest ETA ± 1 hr</td> <td>Applicable from the time of start of change</td> <td>Applicable from the time of start of change</td> <td>Applicable from the time of end of change</td> <td>Applicable if below applicable landing minima</td> <td></td> <td></td> <td></td> </tr> <tr> <td></td> <td>Mean wind should be within required limits</td> <td></td> <td></td> <td></td> <td></td> <td></td> <td></td> </tr> <tr> <td></td> <td>Gusts exceeding crosswind limits should be fully applied.</td> <td></td> <td></td> <td></td> <td></td> <td></td> <td></td> </tr> </tbody> </table>		TAF or TREND for AERODROME PLANNED AS:	FM (alone) and BECMG AT:		BECMG (alone), BECMG FM, BECMG TL, BECMG FM...* TL in case of:		TEMPO (alone), TEMPO FM, TEMPO TL, TEMPO FM...* TL, PROB 30/40 (alone)		PROB TEMPO	Deterioration and Improvement	Deterioration	Improvement	Deterioration	Improvement	DESTINATION at ETA ± 1 hr	Applicable from the start of the change	Applicable from the time of start of change	Applicable from the time of start of change	Not applicable	Applicable	Applicable	Deterioration may be disregarded; Improvement should be disregarded including mean wind and gusts	TAKE-OFF ALTERNATE at ETA ± 1 hr	Mean wind should be within required limits			Mean wind should be within required limits				ENROUTE ALTERNATE at ETA ± 1 hr	Gusts may be disregarded			Mean wind and gusts exceeding required limits may be disregarded				ETOPS ENROUTE ALTERNATE at earliest/latest ETA ± 1 hr	Applicable from the time of start of change	Applicable from the time of start of change	Applicable from the time of end of change	Applicable if below applicable landing minima					Mean wind should be within required limits								Gusts exceeding crosswind limits should be fully applied.						
TAF or TREND for AERODROME PLANNED AS:	FM (alone) and BECMG AT:		BECMG (alone), BECMG FM, BECMG TL, BECMG FM...* TL in case of:		TEMPO (alone), TEMPO FM, TEMPO TL, TEMPO FM...* TL, PROB 30/40 (alone)		PROB TEMPO																																																							
	Deterioration and Improvement	Deterioration	Improvement	Deterioration	Improvement																																																									
DESTINATION at ETA ± 1 hr	Applicable from the start of the change	Applicable from the time of start of change	Applicable from the time of start of change	Not applicable	Applicable	Applicable	Deterioration may be disregarded; Improvement should be disregarded including mean wind and gusts																																																							
TAKE-OFF ALTERNATE at ETA ± 1 hr	Mean wind should be within required limits			Mean wind should be within required limits																																																										
ENROUTE ALTERNATE at ETA ± 1 hr	Gusts may be disregarded			Mean wind and gusts exceeding required limits may be disregarded																																																										
ETOPS ENROUTE ALTERNATE at earliest/latest ETA ± 1 hr	Applicable from the time of start of change	Applicable from the time of start of change	Applicable from the time of end of change	Applicable if below applicable landing minima																																																										
	Mean wind should be within required limits																																																													
	Gusts exceeding crosswind limits should be fully applied.																																																													
<p>Note 1: 'required limits' are those contained in the operations manual Note 2: If promulgated aerodrome forecasts do not comply with the requirements of ICAO Annex 3, operators should ensure that guidance in the application of these reports is provided. * The space following 'FM' should always include a time group e.g. 'FM 1030'.</p>																																																														

Formatted: Font:

*Subpart D | Revised rule text***AMC1-CAT.OP.AH.181(c)(1) Selection of aerodromes and operating sites - helicopters****OFFSHORE AERODROME**

- 1. Any alleviation from the requirement to select an alternate aerodrome for a flight to a coastal aerodrome under IFR is applicable only to helicopters routing from offshore, and should be based on an individual safety case assessment.**
- 2. The following should be taken into account:**
 - a. suitability of the weather based on the landing forecast for the destination;**
 - b. the fuel required to meet the IFR requirements of CAT.OP.AH.150 less alternate fuel;**
 - c. where the destination coastal aerodrome is not directly on the coast it should be:**
 - i. within a distance that, with the fuel specified in 2.b. above, the helicopter can, at any time after crossing the coastline, return to the coast, descend safely and carry out a visual approach and landing with VFR fuel reserves intact; and**
 - ii. geographically sited so that the helicopter can, within the rules of the air, and within the landing forecast:**
 - A. proceed inbound from the coast at 500 ft AGL and carry out a visual approach and landing; or**
 - B. proceed inbound from the coast on an agreed route and carry out a visual approach and landing;**
 - d. procedures for coastal aerodromes should be based on a landing forecast no worse than:**
 - i. by day, a cloud base of DH/MDH +400 ft, and a visibility of 4 km, or, if descent over the sea is intended, a cloud base of 600 ft and a visibility of 4 km; or**
 - ii. by night, a cloud base of 1 000 ft and a visibility of 5 km;**
 - e. the descent to establish visual contact with the surface should take place over the sea or as part of the instrument approach;**
 - f. routings and procedures for coastal aerodromes nominated as such should be included in the operations manual, Part C;**
 - g. the MEL should reflect the requirement for airborne radar and radio altimeter for this type of operation; and**
 - h. operational limitations for each coastal aerodrome should be specified in the operations manual.**

*Subpart D | Revised rule text***AMC1-CAT.OP.AH.181(e) Selection of aerodromes and operating sites - helicopters****HELIDECK****1. Offshore alternate helideck landing environment**

The landing environment of a helideck that is proposed for use as an offshore alternate should be presurveyed and, as well as the physical characteristics, the effect of wind direction and strength, and turbulence established. This information, which should be available to the Commander at the planning stage and in flight, should be published in an appropriate form in the operations manual Part C (including the orientation of the helideck) such that the suitability of the helideck for use as an offshore alternate aerodrome, can be assessed. The alternate helideck should meet the criteria for size and obstacle clearance appropriate to the performance requirements of the type of helicopter concerned.

2. Performance considerations

The use of an offshore alternate is restricted to helicopters which can achieve OEI in ground effect (IGE) hover at an appropriate power rating at the offshore alternate aerodrome. Where the surface of the offshore alternate helideck, or prevailing conditions (especially wind velocity), precludes an OEI IGE, OEI out of ground effect (OGE) hover performance at an appropriate power rating should be used to compute the landing mass. The landing mass should be calculated from graphs provided in the relevant Part B of the operations manual. When arriving at this landing mass, due account should be taken of helicopter configuration, environmental conditions and the operation of systems which have an adverse effect on performance. The planned landing mass of the helicopter including crew, passengers, baggage, cargo plus 30 minutes final reserve fuel, should not exceed the OEI landing mass at the time of approach to the offshore alternate aerodrome.

3. Weather considerations**a. Meteorological observations**

When the use of an offshore alternate helideck is planned, the meteorological observations at the destination and alternate aerodrome should be taken by an observer acceptable to the authority responsible for the provision of meteorological services. Automatic meteorological observations stations may be used.

b. Weather minima

When the use of an offshore alternate helideck is planned, the operator should not select a helideck as a destination or offshore alternate helideck unless the aerodrome forecast indicates that, during a period commencing one hour before and ending one hour after the expected time of arrival at the destination and offshore

Subpart D | Revised rule text

alternate aerodrome, the weather conditions will be at or above the planning minima shown in Table 1 below.

Table 1: Planning minima

	Day	Night
Cloud Base	600 ft	800 ft
Visibility	4 km	5 km

c. Conditions of Fog

Where fog is forecast, or has been observed within the last two hours within 60 NM of the destination or alternate aerodrome, offshore alternate aerodromes should not be used.

4. Actions at point of no return

Before passing the point of no return - which should not be more than 30 minutes from the destination - the following actions should have been completed:

- a. confirmation that navigation to the destination and offshore alternate helideck can be assured;
- b. radio contact with the destination and offshore alternate helideck (or master station) has been established;
- c. the landing forecast at the destination and offshore alternate helideck have been obtained and confirmed to be at or above the required minima;
- d. the requirements for OEI landing (see 2. above) have been checked in the light of the latest reported weather conditions to ensure that they can be met; and
- e. to the extent possible, having regard to information on current and forecast use of the offshore alternate helideck and on conditions prevailing, the availability of the offshore alternate helideck should be guaranteed by the duty holder (the rig operator in the case of fixed installations and the owner in the case of mobiles) until the landing at the destination, or the offshore alternate aerodrome, has been achieved or until offshore shuttling has been completed.

5. Offshore shuttling

Provided that the actions in 4. above have been completed, offshore shuttling, using an offshore alternate aerodrome, may be carried out.

*Subpart D | Revised rule text***GM1-CAT.OP.AH.181 Selection of aerodromes and operating sites - helicopters****OFFSHORE ALTERNATES**

When operating offshore, any spare payload capacity should be used to carry additional fuel if it would facilitate the use of an onshore alternate.

LANDING FORECAST

1. The procedures contained in AMC1-CAT.OP.AH.181(e) are weather-critical. Consequently, meteorological data conforming to the standards contained in the Regional Air Navigation Plan and ICAO Annex 3 has been specified. As the following meteorological data is point-specific, caution should be exercised when associating it with nearby aerodromes (or helidecks).
2. Meteorological reports (METARs)
 - a. Routine and special meteorological observations at offshore installations should be made during periods and at a frequency agreed between the meteorological authority and the operator concerned. They should comply with the requirements contained in the meteorological section of the ICAO Regional Air Navigation Plan, and should conform to the standards and recommended practices, including the desirable accuracy of observations, promulgated in ICAO Annex 3.
 - b. Routine and selected special reports are exchanged between meteorological offices in the METAR or SPECI code forms prescribed by the World Meteorological Organisation.
3. Aerodrome forecasts (TAFS)
 - a. The aerodrome forecast consists of a concise statement of the mean or average meteorological conditions expected at an aerodrome or aerodrome during a specified period of validity, which is normally not less than nine hours, or more than 24 hours in duration. The forecast includes surface wind, visibility, weather and cloud, and expected changes of one or more of these elements during the period. Additional elements may be included as agreed between the meteorological authority and the operators concerned. Where these forecasts relate to offshore installations, barometric pressure and temperature should be included to facilitate the planning of helicopter landing and take-off performance.
 - b. Aerodrome forecasts are most commonly exchanged in the TAF code form, and the detailed description of an aerodrome forecast is promulgated in the ICAO Regional Air Navigation Plan and also in ICAO Annex 3, together with the operationally desirable accuracy elements. In particular, the observed cloud height should remain within $\pm 30\%$ of the forecast value in 70% of cases, and the observed

Subpart D | Revised rule text

visibility should remain within $\pm 30\%$ of the forecast value in 80% of cases.

4. Landing forecasts (TRENDS)

- a. The landing forecast consists of a concise statement of the mean or average meteorological conditions expected at an aerodrome or aerodrome during the two-hour period immediately following the time of issue. It contains surface wind, visibility, significant weather and cloud elements, and other significant information, such as barometric pressure and temperature, as may be agreed between the meteorological authority and the operators concerned.
- b. The detailed description of the landing forecast is promulgated in the ICAO Regional Air Navigation Plan and also in ICAO Annex 3, together with the operationally desirable accuracy of the forecast elements. In particular, the value of the observed cloud height and visibility elements should remain within $\pm 30\%$ of the forecast values in 90% of the cases.
- c. Landing forecasts most commonly take the form of routine or special selected meteorological reports in the METAR code, to which either the code words "NOSIG", i.e. no significant change expected; "BECMG" (becoming), or "TEMPO" (temporarily), followed by the expected change, are added. The two-hour period of validity commences at the time of the meteorological report.

GM1-CAT.OP.AH.185 Planning minima for IFR flights - aeroplanes

PLANNING MINIMA FOR ALTERNATE AERODROMES

Non-precision minima in Table 1 of CAT.OP.AH.185 means the next highest minima that that apply in the prevailing wind and serviceability conditions. Localiser only approaches, if published, are considered to be non-precision in this context. It is recommended that operators wishing to publish tables of planning minima choose values that are likely to be appropriate on the majority of occasions (e.g. regardless of wind direction). Unserviceabilities should, however, be fully taken into account.

AMC1-CAT.OP.AH.190 Submission of ATS flight plan

Comment [WSI71]:
AMC OPS 1.300

FLIGHTS WITHOUT ATS FLIGHT PLAN

1. When unable to submit or to close the ATS flight plan due to lack of ATS facilities or any other means of communications to ATS, the operator should establish procedures, instructions and a list of nominated persons to be responsible for alerting search and rescue services.
2. To ensure that each flight is located at all times, these instructions should:

Subpart D | Revised rule text

- a. provide the nominated person with at least the information required to be included in a VFR flight plan, and the location, date and estimated time for reestablishing communications;
- b. if an aircraft is overdue or missing, provide for notification to the appropriate ATS or search and rescue facility; and
- c. provide that the information will be retained at a designated place until the completion of the flight.

AMC1-CAT.OP.AH.195 Refuelling/defuelling with passengers embarking, on board or disembarking

OPERATIONAL PROCEDURES - GENERAL

- 1. When refuelling/defuelling with passengers on board, ground servicing activities and work inside the aeroplane, such as catering and cleaning, should be conducted in such a manner that they do not create a hazard and that the aisles and emergency doors are unobstructed.
- 2. The deployment of integral aircraft stairs or the opening of emergency exits as a prerequisite to refuelling is not necessarily required.

...

OPERATIONAL PROCEDURES - HELICOPTERS

- 4. Operational procedures should specify that at least the following precautions are taken:
 - a. door(s) on the refuelling side of the helicopter remain closed;
 - b. door(s) on the non-refuelling side of the helicopter remain open, weather permitting;
 - c. fire-fighting facilities of the appropriate scale be positioned so as to be immediately available in the event of a fire;
 - d. sufficient personnel be immediately available to move passengers clear of the helicopter in the event of a fire;
 - e. sufficient qualified personnel be on board and be prepared for an immediate emergency evacuation;
 - f. if the presence of fuel vapour is detected inside the helicopter, or any other hazard arises during refuelling/defuelling, fuelling be stopped immediately;
 - g. the ground area beneath the exits intended for emergency evacuation and slide deployment areas be kept clear; and
 - h. provision made for a safe and rapid evacuation.

*Subpart D | Revised rule text***GM1-CAT.OP.AH.200 Refuelling/defuelling with wide-cut fuel****PROCEDURES**

1. **'Wide cut fuel' (designated JET B, JP-4 or AVTAG) is an aviation turbine fuel that falls between gasoline and kerosene in the distillation range and consequently, compared to kerosene (JET A or JET A1), it has the properties of higher volatility (vapour pressure), lower flash point and lower freezing point.**
2. **Wherever possible, the operator should avoid the use of wide-cut fuel types. If a situation arises such that only wide-cut fuels are available for refuelling/defuelling, operators should be aware that mixtures of wide-cut fuels and kerosene turbine fuels can result in the air/fuel mixture in the tank being in the combustible range at ambient temperatures. The extra precautions set out below are advisable to avoid arcing in the tank due to electrostatic discharge. The risk of this type of arcing can be minimised by the use of a static dissipation additive in the fuel. When this additive is present in the proportions stated in the fuel specification, the normal fuelling precautions set out below are considered adequate.**
3. **Wide-cut fuel is considered to be "involved" when it is being supplied or when it is already present in aircraft fuel tanks.**
4. **When wide-cut fuel has been used, this should be recorded in the technical log. The next two uplifts of fuel should be treated as though they too involved the use of wide-cut fuel.**
5. **When refuelling/defuelling with turbine fuels not containing a static dissipator, and where wide-cut fuels are involved, a substantial reduction on fuelling flow rate is advisable. Reduced flow rate, as recommended by fuel suppliers and/or aeroplane manufacturers, has the following benefits:**
 - a. **it allows more time for any static charge build-up in the fuelling equipment to dissipate before the fuel enters the tank;**
 - b. **it reduces any charge which may build up due to splashing; and**
 - c. **until the fuel inlet point is immersed, it reduces misting in the tank and consequently the extension of the flammable range of the fuel.**
6. **The flow rate reduction necessary is dependent upon the fuelling equipment in use and the type of filtration employed on the aeroplane fuelling distribution system. It is difficult, therefore, to quote precise flow rates. Reduction in flow rate is advisable whether pressure fuelling or over-wing fuelling is employed.**
7. **With over-wing fuelling, splashing should be avoided by making sure that the delivery nozzle extends as far as practicable into the tank. Caution should be exercised to avoid damaging bag tanks with the nozzle.**

Subpart D | Revised rule text

AMC1-CAT.OP.AH.210 Crew members at stations

Comment [WSI72]:
IEM OPS 1.310(b)

Comment [WSI73]:
alleviation from Appendix 1 to OPS 1.005
18 has not been transposed.

CABIN CREW SEATING POSITIONS

1. When determining cabin crew seating positions, the operator should ensure that they are:
 - a. close to a floor level exit;
 - b. provided with a good view of the area(s) of the passenger cabin for which the cabin crew member is responsible; and
 - c. evenly distributed throughout the cabin, in the above order of priority.
2. 1. above should not be taken as implying that, in the event of there being more such cabin crew stations than required cabin crew, the number of cabin crew members should be increased.

GM1-CAT.OP.AH.210 Crew members at stations

Comment [WSI74]:
[ACJ OPS 1.310(a)(3)]

MITIGATING MEASURES – CONTROLLED REST

1. This Guidance Material addresses controlled rest taken by the minimum certified flight crew. It is not related to planned in-flight rest by members of an augmented crew.
2. Although flight crew members should stay alert at all times during flight, unexpected fatigue can occur as a result of sleep disturbance and circadian disruption. To cover for this unexpected fatigue, and to regain a high level of alertness, a controlled rest procedure in the flight crew compartment, organised by the commander may be used, if workload permits. 'Controlled rest' means a period of time 'off task' that may include actual sleep. The use of controlled rest has been shown to significantly increase the levels of alertness during the later phases of flight, particularly after the top of descent, and is considered to be good use of crew resource management (CRM) principles. Controlled rest should be used in conjunction with other on-board fatigue management countermeasures such as physical exercise, bright cockpit illumination at appropriate times, balanced eating and drinking, and intellectual activity.
3. Controlled rest taken in this way should not be considered to be part of a rest period for the purposes of calculating flight time limitations, nor used to justify any duty period. Controlled rest may be used to manage both sudden unexpected fatigue and fatigue which is expected to become more severe during higher workload periods later in the flight. Controlled rest is not related to fatigue management, which is planned before flight.
4. Controlled rest periods should be agreed according to individual needs and the accepted principles of CRM; where the involvement of the cabin crew is required, consideration should be given to their workload.
5. When applying controlled rest procedures, the commander should ensure that:

Subpart D | Revised rule text

- a. **the other flight crew member(s) is/are adequately briefed to carry out the duties of the resting flight crew member;**
 - b. **one flight crew member is fully able to exercise control of the aircraft at all times; and**
 - c. **any system intervention which would normally require a cross-check according to multi-crew principles is avoided until the resting flight crew member resumes his/her duties.**
- 6. Controlled rest procedures should satisfy the following criteria:**
- a. **only one flight crew member at a time should take rest at his/her station; the harness should be used and the seat positioned to minimise unintentional interference with the controls;**
 - b. **the rest period should be no longer than 45 minutes (in order to limit any actual sleep to approximately 30 minutes) to limit deep sleep and associated long recovery time (sleep inertia);**
 - c. **after this 45-minute period, there should be a recovery period of 20 minutes during which sole control of the aircraft should not be entrusted to the flight crew member during his/her recovery period;**
 - d. **in the case of two-crew operations, means should be established to ensure that the non-resting flight crew member remains alert. This may include:**
 - i. **appropriate alarm systems;**
 - ii. **on-board systems to monitor flight crew activity; and**
 - iii. **frequent cabin crew checks. In this case, the commander should inform the senior cabin crew member of the intention of the flight crew member to take controlled rest, and of the time of the end of that rest; frequent contact should be established between the non-resting flight crew member and the cabin crew by communication means, and the cabin crew should check that the resting flight crew member is alert at the end of the period;**
 - e. **there should be a minimum of 20 minutes between two subsequent controlled rest periods in order to overcome the effects of sleep inertia and allow for adequate briefing;**
 - f. **if necessary, a flight crew member may take more than one rest period, if time permits, on longer sectors, subject to the restrictions above; and**
 - g. **controlled rest periods should terminate at least 30 minutes before the top of descent.**

*Subpart D | Revised rule text***GM1-CAT.OP.AH.250 Ice and other contaminants – ground procedures****TERMINOLOGY**

Terms used in the context of de-icing/anti-icing have the meaning defined in the following subparagraphs.

1. 'Anti-icing fluid' includes, but is not limited to, the following:
 - a. Type I fluid if heated to min 60 °C at the nozzle;
 - b. mixture of water and Type I fluid if heated to min 60 °C at the nozzle;
 - c. Type II fluid;
 - d. mixture of water and Type II fluid;
 - e. Type III fluid;
 - f. mixture of water and Type III fluid;
 - g. Type IV fluid;
 - h. mixture of water and Type IV fluid.

On uncontaminated aircraft surfaces Type II, III and IV anti-icing fluids are normally applied unheated.
2. 'Clear ice': a coating of ice, generally clear and smooth, but with some air pockets. It forms on exposed objects, the temperatures of which are at, below or slightly above the freezing temperature, by the freezing of super-cooled drizzle, droplets or raindrops.
3. Conditions conducive to aircraft icing on the ground (e.g. freezing fog, freezing precipitation, frost, rain or high humidity (on cold soaked wings), snow or mixed rain and snow).
4. 'Contamination', in this context, is understood as being all forms of frozen or semi-frozen moisture, such as frost, snow, slush or ice.
5. 'Contamination check': a check of aircraft for contamination to establish the need for de-icing.
6. 'De-icing fluid': such fluid includes, but is not limited to, the following:
 - a. heated water;
 - b. Type I fluid;
 - c. mixture of water and Type I fluid;
 - d. Type II fluid;
 - e. mixture of water and Type II fluid;
 - f. Type III fluid;
 - g. mixture of water and Type III fluid;
 - h. Type IV fluid;

*Subpart D | Revised rule text***i. mixture of water and Type IV fluid.**

De-icing fluid is normally applied heated to ensure maximum efficiency.

- 7. 'De-icing/anti-icing': this is the combination of de-icing and anti-icing performed in either one or two steps.**
- 8. 'Ground ice detection system (GIDS)': system used during aircraft ground operations to inform the personnel involved in the operation and/or the flight crew about the presence of frost, ice, snow or slush on the aircraft surfaces.**
- 9. 'Lowest operational use temperature (LOUT)': the lowest temperature at which a fluid has been tested and certified as acceptable in accordance with the appropriate aerodynamic acceptance test whilst still maintaining a freezing point buffer of not less than:**
 - a. 10°C for a Type I de-icing/anti-icing fluid; or**
 - b. 7°C for Type II, III or IV de-icing/anti-icing fluids.**
- 10. 'Post-treatment check': an external check of the aircraft after de-icing and/or anti-icing treatment accomplished from suitably elevated observation points (e.g. from the de-icing/anti-icing equipment itself or other elevated equipment) to ensure that the aircraft is free from any frost, ice, snow, or slush.**
- 11. 'Pre take-off check': an assessment normally performed from within the flight deck, to validate the applied HoT.**
- 12. 'Pre take-off contamination check': a check of the treated surfaces for contamination, performed when the HoT has been exceeded or if any doubt exists regarding the continued effectiveness of the applied anti-icing treatment. It is normally accomplished externally, just before commencement of the take-off run.**

ANTI-ICING CODES

- 13. The following are examples of anti-icing codes:**
 - a. "Type I" at (start time) – to be used if anti-icing treatment has been performed with a Type I fluid;**
 - b. "Type II/100" at (start time) – to be used if anti-icing treatment has been performed with undiluted Type II fluid;**
 - c. "Type II/75" at (start time) – to be used if anti-icing treatment has been performed with a mixture of 75% Type II fluid and 25% water;**
 - d. "Type IV/50" at (start time) – to be used if anti-icing treatment has been performed with a mixture of 50% Type IV fluid and 50% water.**
- 14. When a two-step de-icing/anti-icing operation has been carried out, the anti-icing code should be determined by the second step fluid. Fluid brand names may be included, if desired.**

*Subpart D | Revised rule text***GM2-CAT.OP.AH.250 Ice and other contaminants – ground procedures****DE-ICING/ANTI-ICING - PROCEDURES**

- 1. De-icing and/or anti-icing procedures should take into account manufacturer's recommendations, including those that are type-specific and cover:**
 - a. contamination checks, including detection of clear ice and under-wing frost; limits on the thickness/area of contamination published in the AFM or other manufacturers' documentation should be followed;**
 - b. procedures to be followed if de-icing and/or anti-icing procedures are interrupted or unsuccessful;**
 - c. post-treatment checks;**
 - d. pre-take-off checks;**
 - e. pre-take-off contamination checks;**
 - f. the recording of any incidents relating to de-icing and/or anti-icing; and**
 - g. the responsibilities of all personnel involved in de-icing and/or anti-icing.**
- 2. Operator's procedures should ensure that:**
 - a. When aircraft surfaces are contaminated by ice, frost, slush or snow, they are de-iced prior to take-off, according to the prevailing conditions. Removal of contaminants may be performed with mechanical tools, fluids (including hot water), infra-red heat or forced air, taking account of aircraft type-specific requirements.**
 - b. Account is taken of the wing skin temperature versus outside air temperature (OAT), as this may affect:**
 - i. the need to carry out aircraft de-icing and/or anti-icing; and/or**
 - ii. the performance of the de-icing/anti-icing fluids.**
 - c. When freezing precipitation occurs or there is a risk of freezing precipitation occurring which would contaminate the surfaces at the time of take-off, aircraft surfaces should be anti-iced. If both de-icing and anti-icing are required, the procedure may be performed in a one- or two-step process, depending upon weather conditions, available equipment, available fluids and the desired hold-over time (HoT). One-step de-icing/anti-icing means that de-icing and anti-icing are carried out at the same time, using a mixture of de-icing/anti-icing fluid and water. Two-step de-icing/anti-icing means that de-icing and anti-icing are carried out in two separate steps. The aircraft is first de-iced using heated water only or a heated mixture of de-icing/anti-icing fluid and water. After completion of the de-icing operation a layer of a mixture of de-icing/anti-icing fluid and water, or of de-**

Subpart D | Revised rule text

icing/anti-icing fluid only, is sprayed over the aircraft surfaces. The second step will be applied before the first step fluid freezes, typically within three minutes and, if necessary, area by area.

- d. When an aircraft is anti-iced and a longer HoT is needed/desired, the use of a less diluted Type II or Type IV fluid should be considered.
 - e. All restrictions relative to OAT and fluid application (including, but not necessarily limited to, temperature and pressure) published by the fluid manufacturer and/or aircraft manufacturer, are followed and procedures, limitations and recommendations to prevent the formation of fluid residues are followed.
 - f. During conditions conducive to aircraft icing on the ground or after de-icing and/or anti-icing, an aircraft is not dispatched for departure unless it has been given a contamination check or a post-treatment check by a trained and qualified person. This check should cover all treated surfaces of the aircraft and be performed from points offering sufficient accessibility to these parts. To ensure that there is no clear ice on suspect areas, it may be necessary to make a physical check (e.g. tactile).
 - g. The required entry is made in the technical log.
 - h. The commander continually monitors the environmental situation after the performed treatment. Prior to take-off he/she performs a pre-take-off check, which is an assessment of whether the applied HoT is still appropriate. This pre-take-off check includes, but is not limited to, factors such as precipitation, wind and OAT.
 - i. If any doubt exists as to whether a deposit may adversely affect the aircraft's performance and/or controllability characteristics, the commander should arrange for a pre take-off contamination check to be performed in order to verify that the aircraft's surfaces are free of contamination. Special methods and/or equipment may be necessary to perform this check, especially at night time or in extremely adverse weather conditions. If this check cannot be performed just before take-off, re-treatment should be applied.
 - j. When retreatment is necessary, any residue of the previous treatment should be removed and a completely new de-icing/anti-icing treatment should be applied.
 - k. When a ground ice detection system (GIDS) is used to perform an aircraft surfaces check prior to and/or after a treatment, the use of GIDS by suitably trained personnel should be part of the procedure.
3. Special operational considerations
- a. When using thickened de-icing/anti-icing fluids, the operator should consider a two-step de-icing/anti-icing procedure, the first step preferably with hot water and/or un-thickened fluids.

Subpart D | Revised rule text

- b. The use of de-icing/anti-icing fluids should be in accordance with the aircraft manufacturer's documentation. This is particularly important for thickened fluids to assure sufficient flow-off during take-off.**
- c. The operator should comply with any type-specific operational requirement(s), such as an aircraft mass decrease and/or a take-off speed increase associated with a fluid application.**
- d. The operator should take into account any flight handling procedures (stick force, rotation speed and rate, take-off speed, aircraft attitude etc.) laid down by the aircraft manufacturer when associated with a fluid application.**
- e. The limitations or handling procedures resulting from 3.c. and/or 3.d. above should be part of the flight crew pre take-off briefing.**

4. Communications

- a. Before aircraft treatment. When the aircraft is to be treated with the flight crew on board, the flight and personnel involved in the operation should confirm the fluid to be used, the extent of treatment required and any aircraft type-specific procedure(s) to be used. Any other information needed to apply the HoT tables should be exchanged.**
- b. Anti-icing code. The operator's procedures should include an anti-icing code, which indicates the treatment the aircraft has received. This code provides the flight crew with the minimum details necessary to estimate a HoT and confirms that the aircraft is free of contamination.**
- c. After treatment. Before reconfiguring or moving the aircraft, the flight crew should receive a confirmation from the personnel involved in the operation that all de-icing and/or anti-icing operations are complete and that all personnel and equipment are clear of the aircraft.**

5. Hold-over protection

The operator should publish in the operations manual, when required, the HoTs in the form of a table or a diagram, to account for the various types of ground icing conditions and the different types and concentrations of fluids used. However, the times of protection shown in these tables are to be used as guidelines only and are normally used in conjunction with the pre take-off check.

6. Training

The operator's initial and recurrent de-icing and/or anti-icing training programmes (including communication training) for flight crew and those of its personnel involved in the operation who are involved in de-icing and/or anti-icing should include additional training if any of the following is introduced:

Subpart D | Revised rule text

- a. a new method, procedure and/or technique;
- b. a new type of fluid and/or equipment; or
- c. a new type of aircraft.

7. Contracting

When the operator contracts training on de-icing/anti-icing, the operator should ensure that the contractor complies with the operator's training/qualification procedures, together with any specific procedures in respect of:

- a. de-icing and/or anti-icing methods and procedures;
- b. fluids to be used, including precautions for storage and preparation for use;
- c. specific aircraft requirements (e.g. no-spray areas, propeller/engine de-icing, APU operation etc.); and
- d. checking and communications procedures.

8. Special maintenance considerations**a. General**

The operator should take proper account of the possible side-effects of fluid use. Such effects may include, but are not necessarily limited to, dried and/or re-hydrated residues, corrosion and the removal of lubricants.

b. Special considerations regarding residues of dried fluids

The operator should establish procedures to prevent or detect and remove residues of dried fluid. If necessary the operator should establish appropriate inspection intervals based on the recommendations of the airframe manufacturers and/or the operator's own experience:

i. Dried fluid residues

Dried fluid residues could occur when surfaces have been treated and the aircraft has not subsequently been flown and has not been subject to precipitation. The fluid may then have dried on the surfaces.

ii. Re-hydrated fluid residues

Repetitive application of thickened de-icing/anti-icing fluids may lead to the subsequent formation/build up of a dried residue in aerodynamically quiet areas, such as cavities and gaps. This residue may re-hydrate if exposed to high humidity conditions, precipitation, washing, etc., and increase to many times its original size/volume. This residue will freeze if exposed to conditions at or below 0 °C. This may cause moving parts, such as elevators, ailerons, and flap actuating mechanisms to stiffen

Subpart D | Revised rule text

or jam in-flight. Re-hydrated residues may also form on exterior surfaces, which can reduce lift, increase drag and stall speed. Re-hydrated residues may also collect inside control surface structures and cause clogging of drain holes or imbalances to flight controls. Residues may also collect in hidden areas, such as around flight control hinges, pulleys, grommets, on cables and in gaps.

- iii. Operators are strongly recommended to obtain information about the fluid dry-out and re-hydration characteristics from the fluid manufacturers and to select products with optimised characteristics.
- iv. Additional information should be obtained from fluid manufacturers for handling, storage, application and testing of their products.

GM3-CAT.OP.AH.250 Ice and other contaminants – ground procedures**DE-ICING/ANTI-ICING BACKGROUND INFORMATION**

Further guidance material on this issue is given in the International Civil Aviation Organisation (ICAO) *Manual of Aircraft Ground De-icing/Anti-icing Operations* (Doc 9640) (hereinafter referred to as the *ICAO Manual of Aircraft Ground De-icing/Anti-icing Operations*).

1. General

- a. Any deposit of frost, ice, snow or slush on the external surfaces of an aircraft may drastically affect its flying qualities because of reduced aerodynamic lift, increased drag, modified stability and control characteristics. Furthermore, freezing deposits may cause moving parts, such as elevators, ailerons, flap actuating mechanism etc., to jam and create a potentially hazardous condition. Propeller/engine/auxiliary power unit (APU)/systems performance may deteriorate due to the presence of frozen contaminants on blades, intakes and components. Also, engine operation may be seriously affected by the ingestion of snow or ice, thereby causing engine stall or compressor damage. In addition, ice/frost may form on certain external surfaces (e.g. wing upper and lower surfaces, etc.) due to the effects of cold fuel/structures, even in ambient temperatures well above 0 °C.
- b. Procedures established by the operator for de-icing and/or anti-icing are intended to ensure that the aircraft is clear of contamination so that degradation of aerodynamic characteristics or mechanical interference will not occur and, following anti-icing, to maintain the airframe in that condition during the appropriate HoT.
- c. Under certain meteorological conditions, de-icing and/or anti-icing procedures may be ineffective in providing sufficient protection for

Subpart D | Revised rule text

continued operations. Examples of these conditions are freezing rain, ice pellets and hail, heavy snow, high wind velocity, fast dropping OAT or any time when freezing precipitation with high water content is present. No HoT guidelines exist for these conditions.

- d. Material for establishing operational procedures can be found, for example, in:
- i. ICAO Annex 3, Meteorological Service for International Air Navigation;
 - ii. ICAO Manual of Aircraft Ground De-icing/Anti-icing Operations;
 - iii. ISO 11075 Aircraft - De-icing/anti-icing fluids - ISO type I;
 - iv. ISO 11076 Aircraft - De-icing/anti-icing methods with fluids;
 - v. ISO 11077 Aerospace - Self propelled de-icing/anti-icing vehicles - Functional requirements;
 - vi. ISO 11078 Aircraft - De-icing/anti-icing fluids -- ISO types II, III and IV;
 - vii. AEA "Recommendations for de-icing/anti-icing of aircraft on the ground";
 - viii. AEA "Training recommendations and background information for de-icing/anti-icing of aircraft on the ground";
 - ix. EUROCAE ED-104A Minimum Operational Performance Specification for Ground Ice Detection Systems;
 - x. SAE AS5681 Minimum Operational Performance Specification for Remote On-Ground Ice Detection Systems;
 - xi. SAE ARP4737 Aircraft - De-icing/anti-icing methods;
 - xii. SAE AMS1424 De-icing/anti-Icing Fluid, Aircraft, SAE Type I;
 - xiii. SAE AMS1428 Fluid, Aircraft De-icing/anti-Icing, Non-Newtonian, (Pseudoplastic), SAE Types II, III, and IV;
 - xiv. SAE ARP1971 Aircraft De-icing Vehicle - Self-Propelled, Large and Small Capacity;
 - xv. SAE ARP5149 Training Programme Guidelines for De-icing/anti-icing of Aircraft on Ground; and
 - xvi. ARP5646 Quality Program Guidelines for De-icing/anti-icing of Aircraft on the Ground.

2. Fluids

- a. Type I fluid: Due to its properties, Type I fluid forms a thin, liquid-wetting film on surfaces to which it is applied which, under certain weather conditions, gives a very limited HoT. With this type of fluid, increasing the concentration of fluid in the fluid/water mix does not provide any extension in HoT.

Subpart D | Revised rule text

- b. **Type II and Type IV fluids contain thickeners which enable the fluid to form a thicker liquid-wetting film on surfaces to which it is applied. Generally, this fluid provides a longer HoT than Type I fluids in similar conditions. With this type of fluid, the HoT can be extended by increasing the ratio of fluid in the fluid/water mix.**
 - c. **Type III fluid is a thickened fluid especially intended for use on aircraft with low rotation speeds.**
 - d. **Fluids used for de-icing and/or anti-icing should be acceptable to the operator and the aircraft manufacturer. These fluids normally conform to specifications such as SAE AMS1424, SAE AMS1428 or equivalent. Use of non-conforming fluids is not recommended due to their characteristics being unknown. The anti-icing and aerodynamic properties of thickened fluids may be seriously degraded by, for example, inappropriate storage, treatment, application, application equipment and age.**
- 3. Hold-over protection**
- a. **Hold-over protection is achieved by a layer of anti-icing fluid remaining on and protecting aircraft surfaces for a period of time. With a one-step de-icing/anti-icing procedure, the HoT begins at the commencement of de-icing/anti-icing. With a two-step procedure, the HoT begins at the commencement of the second (anti-icing) step. The hold-over protection runs out:**
 - i. **at the commencement of the take-off roll (due to aerodynamic shedding of fluid); or**
 - ii. **when frozen deposits start to form or accumulate on treated aircraft surfaces, thereby indicating the loss of effectiveness of the fluid.**
 - b. **The duration of hold-over protection may vary depending on the influence of factors other than those specified in the HoT tables. Guidance should be provided by the operator to take account of such factors, which may include:**
 - i. **atmospheric conditions, e.g. exact type and rate of precipitation, wind direction and velocity, relative humidity and solar radiation; and**
 - ii. **the aircraft and its surroundings, such as aircraft component inclination angle, contour and surface roughness, surface temperature, operation in close proximity to other aircraft (jet or propeller blast) and ground equipment and structures.**
 - c. **HoTs are not meant to imply that flight is safe in the prevailing conditions if the specified HoT has not been exceeded. Certain meteorological conditions, such as freezing drizzle or freezing rain, may be beyond the certification envelope of the aircraft.**

Subpart D | Revised rule text

- d. **References to usable HoT tables may be found in the AEA "Recommendations for de-icing/anti-icing of aircraft on the ground".**

AMC1-CAT.OP.AH.255 Ice and other contaminants – flight procedures**FLIGHT IN EXPECTED OR ACTUAL ICING CONDITIONS**

1. **In accordance with 2.a.5 of Annex IV to Regulation (EC) No 216/2008 (Essential requirements for air operations), in case of flight into known or expected icing conditions, the aircraft must be certified, equipped and/or treated to operate safely in such conditions. The procedures to be established by the operator should take account of the design, the equipment, the configuration of the aircraft and the necessary training. For these reasons, different aircraft types operated by the same company may require the development of different procedures. In every case the relevant limitations are those which are defined in the AFM and other documents produced by the manufacturer.**
2. **The operator should ensure that the procedures take account of the following:**
 - a. **the equipment and instruments which must be serviceable for flight in icing conditions;**
 - b. **the limitations on flight in icing conditions for each phase of flight. These limitations may be imposed by the aircraft's de-icing or anti-icing equipment or the necessary performance corrections that have to be made;**
 - c. **the criteria the flight crew should use to assess the effect of icing on the performance and/or controllability of the aircraft;**
 - d. **the means by which the flight crew detects, by visual cues or the use of the aircraft's ice detection system, that the flight is entering icing conditions; and**
 - e. **the action to be taken by the flight crew in a deteriorating situation (which may develop rapidly) resulting in an adverse affect on the performance and/or controllability of the aircraft, due to:**
 - i. **the failure of the aircraft's anti-icing or de-icing equipment to control a build-up of ice; and/or**
 - ii. **ice build-up on unprotected areas.**
3. **Training for dispatch and flight in expected or actual icing conditions. The content of the operations manual should reflect the training, both conversion and recurrent, which flight crew, cabin crew and all other relevant operational personnel require in order to comply with the procedures for dispatch and flight in icing conditions:**

Subpart D | Revised rule text

- a. For the flight crew, the training should include:**
 - i. instruction on how to recognise, from weather reports or forecasts which are available before flight commences or during flight, the risks of encountering icing conditions along the planned route and on how to modify, as necessary, the departure and in-flight routes or profiles;**
 - ii. instruction on the operational and performance limitations or margins;**
 - iii. the use of in-flight ice detection, anti-icing and de-icing systems in both normal and abnormal operation; and**
 - iv. instruction on the differing intensities and forms of ice accretion and the consequent action which should be taken.**
- b. For the cabin crew, the training should include;**
 - i. awareness of the conditions likely to produce surface contamination; and**
 - ii. the need to inform the flight crew of significant ice accretion.**

GM1-CAT.OP.AH.255 Ice and other contaminants – flight procedures**PROCEDURES - HELICOPTERS**

- 1. The procedures to be established by the operator should take account of the design, the equipment or the configuration of the helicopter and also of the training which is needed. For these reasons, different helicopter types operated by the same company may require the development of different procedures. In every case, the relevant limitations are those that are defined in the AFM and other documents produced by the manufacturer.**
- 2. For the required entries in the operations manual, the procedural principles which apply to flight in icing conditions are referred to under OR.OPS.MLR and should be cross-referenced, where necessary, to supplementary, type-specific data.**
- 3. Technical content of the procedures**

The operator should ensure that the procedures take account of the following:

- a. CAT.IDE.H.165;**
- b. the equipment and instruments that should be serviceable for flight in icing conditions;**
- c. the limitations on flight in icing conditions for each phase of flight. These limitations may be specified by the helicopter's de-icing or anti-icing equipment or the necessary performance corrections which have to be made;**

Subpart D | Revised rule text

- d. the criteria the flight crew should use to assess the effect of icing on the performance and/or controllability of the helicopter;
 - e. the means by which the flight crew detects, by visual cues or the use of the helicopter's ice detection system, that the flight is entering icing conditions; and
 - f. the action to be taken by the flight crew in a deteriorating situation (which may develop rapidly) resulting in an adverse effect on the performance and/or controllability of the helicopter, due to either:
 - i. the failure of the helicopter's anti-icing or de-icing equipment to control a build-up of ice; and/or
 - ii. ice build-up on unprotected areas.
4. Training for dispatch and flight in expected or actual icing conditions
- The content of the operations manual, Part D, should reflect the training, both conversion and recurrent, which flight crew, and all other relevant operational personnel will require in order to comply with the procedures for dispatch and flight in icing conditions.
- a. For the flight crew, the training should include:
 - i. instruction on how to recognise, from weather reports or forecasts that are available before flight commences or during flight, the risks of encountering icing conditions along the planned route and on how to modify, as necessary, the departure and in-flight routes or profiles;
 - ii. instruction on the operational and performance limitations or margins;
 - iii. the use of in-flight ice detection, anti-icing and de-icing systems in both normal and abnormal operation; and
 - iv. instruction on the differing intensities and forms of ice accretion and the consequent action which should be taken.
 - b. For crew members other than flight crew, the training should include;
 - i. awareness of the conditions likely to produce surface contamination; and
 - ii. the need to inform the flight crew of significant ice accretion.

GM1-CAT.OP.AH.270 Minimum flight altitudes**MINIMUM FLIGHT ALTITUDES**

1. The following are examples of some of the methods available for calculating minimum flight altitudes.

Subpart D | Revised rule text

2. KSS formula:

a. Minimum obstacle clearance altitude (MOCA)

i. MOCA is the sum of:

- A. the maximum terrain or obstacle elevation, whichever is higher; plus
- B. 1 000 ft for elevation up to and including 6 000 ft; or
- C. 2 000 ft for elevation exceeding 6 000 ft rounded up to the next 100 ft.

ii. The lowest MOCA to be indicated is 2 000 ft.

iii. From a VOR station, the corridor width is defined as a borderline starting 5 NM either side of the VOR, diverging 4° from centreline until a width of 20 NM is reached at 70 NM out, thence paralleling the centreline until 140 NM out, thence again diverging 4° until a maximum width of 40 NM is reached at 280 NM out. Thereafter the width remains constant (see Figure 1).

Figure 1 of GM1-CAT.OP.AH.270

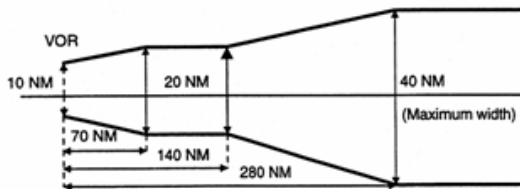

iv. From a non-directional beacon (NDB), similarly, the corridor width is defined as a borderline starting 5 NM either side of the NDB diverging 7° until a width of 20 NM is reached 40 NM out, thence paralleling the centreline until 80 NM out, thence again diverging 7° until a maximum width of 60 NM is reached 245 NM out. Thereafter the width remains constant (see Figure 2).

Figure 2 of GM1-CAT.OP.AH.270

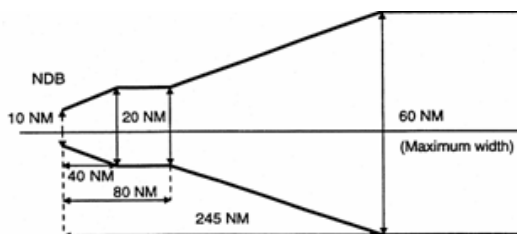

v. MOCA does not cover any overlapping of the corridor.

Subpart D | Revised rule text

- b. Minimum off-route altitude (MORA).** MORA is calculated for an area bounded by each or every second LAT/LONG square on the route facility chart (RFC)/terminal approach chart (TAC) and is based on a terrain clearance as follows:
 - i.** terrain with elevation up to 6 000 ft (2 000 m) – 1 000 ft above the highest terrain and obstructions;
 - ii.** terrain with elevation above 6 000 ft (2 000 m) – 2 000 ft above the highest terrain and obstructions.
- 3. Jeppesen Formula (see Figure 3)**
 - a.** MORA is a minimum flight altitude computed by Jeppesen from current operational navigation charts (ONCs) or world aeronautical charts (WACs). Two types of MORAs are charted which are:
 - i.** route MORAs e.g. 9800a; and
 - ii.** grid MORAs e.g. 98.
 - b.** Route MORA values are computed on the basis of an area extending 10 NM to either side of route centreline and including a 10 NM radius beyond the radio fix/reporting point or mileage break defining the route segment.
 - c.** MORA values clear all terrain and man-made obstacles by 1 000 ft in areas where the highest terrain elevation or obstacles are up to 5 000 ft. A clearance of 2 000 ft is provided above all terrain or obstacles that are 5 001 ft and above.
 - d.** A grid MORA is an altitude computed by Jeppesen and the values are shown within each grid formed by charted lines of latitude and longitude. Figures are shown in thousands and hundreds of feet (omitting the last two digits so as to avoid chart congestion). Values followed by ± are believed not to exceed the altitudes shown. The same clearance criteria as explained in 3.c. apply.

Subpart D | Revised rule text

Figure 3 of GM1-CAT.OP.AH.270

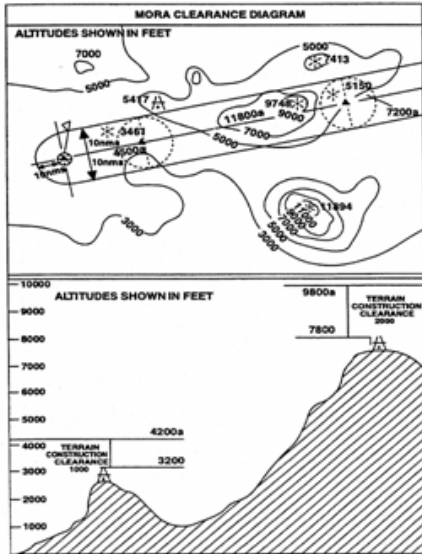

4. ATLAS Formula

- a. Minimum safe en-route altitude (MEA). Calculation of the MEA is based on the elevation of the highest point along the route segment concerned (extending from navigational aid to navigational aid) within a distance on either side of track as specified in table 1 below:

Table 1: Minimum safe en-route altitude

Segment length	Distance either side of track
Up to 100 NM	10 NM *
More than 100 NM	10% of segment length up to a maximum of 60 NM **

*: This distance may be reduced to 5 NM within TMAs where, due to the number and type of available navigational aids, a high degree of navigational accuracy is warranted.

** : In exceptional cases, where this calculation results in an operationally impracticable value, an additional special MEA may be calculated based on a distance of not less than 10 NM either side of track. Such special MEA will be shown together with an indication of the actual width of protected airspace.

- b. The MEA is calculated by adding an increment to the elevation specified above as appropriate, following table 2 below. The resulting value is adjusted to the nearest 100 ft.

Subpart D | Revised rule text

Table 2: Increment added to the elevation *

Elevation of highest point	Increment
Not above 5 000 ft	1 500 ft
Above 5 000 ft but not above 10 000 ft	2 000 ft
Above 10 000 ft	10% of elevation plus 1 000 ft

*: *For the last route segment ending over the initial approach fix, a reduction to 1 000 ft is permissible within TMAs where, due to the number and type of available navigation aids, a high degree of navigational accuracy is warranted.*

- c. **Minimum safe grid altitude (MGA)** Calculation of the MGA is based on the elevation of the highest point within the respective grid area.

The MGA is calculated by adding an increment to the elevation specified above as appropriate, following table 3 below. The resulting value is adjusted to the nearest 100 ft.

Table 3: Minimum safe grid altitude

Elevation of highest point	Increment
Not above 5 000 ft	1 500 ft
Above 5 000 ft but not above 10 000 ft	2 000 ft
Above 10 000 ft	10% of elevation plus 1 000 ft

AMC1-CAT.OP.AH.281 In-flight fuel management - helicopters

COMPLEX MOTOR-POWERED HELICOPTERS, OTHER THAN LOCAL OPERATIONS

The operator should base in-flight fuel management procedures on the following criteria:

1. **In-flight fuel checks**
 - a. The commander should ensure that fuel checks are carried out in-flight at regular intervals. The remaining fuel should be recorded and evaluated to:

Subpart D | Revised rule text

- i. compare actual consumption with planned consumption;
 - ii. check that the remaining fuel is sufficient to complete the flight; and
 - iii. determine the expected fuel remaining on arrival at the destination.
 - b. The relevant fuel data should be recorded.
- 2. In-flight fuel management**
- a. If, as a result of an in-flight fuel check, the expected fuel remaining on arrival at the destination is less than the required alternate fuel plus final reserve fuel, the commander should:
 - i divert; or
 - ii. replan the flight in accordance with CAT.OP.AH.181, (e)(1) unless he/she considers it safer to continue to the destination.
 - b. At an on-shore destination, when two suitable, separate touchdown and lift-off areas are available and the weather conditions at the destination comply with those specified for planning in CAT.OP.AH.245, (a)(2), the commander may permit alternate fuel to be used before landing at the destination.
- 3. If, as a result of an in-flight fuel check on a flight to an isolated destination, planned in accordance with 2. above, the expected fuel remaining at the point of last possible diversion is less than the sum of:**
- a. fuel to divert to an operating site selected in accordance with CAT.OP.AH.181, (b);
 - b. contingency fuel; and
 - c. final reserve fuel,
- the commander should:**
- d. divert; or
 - e. proceed to the destination provided that at on-shore destinations, two suitable, separate touchdown and lift-off areas are available at the destination and the expected weather conditions at the destination comply with those specified for planning in CAT.OP.AH.245, (a)(2).

GM1-CAT.OP.AH.290 –Ground proximity detection**GUIDANCE MATERIAL FOR TERRAIN AWARENESS WARNING SYSTEM (TAWS)
FLIGHT CREW TRAINING PROGRAMMES****1. Introduction**

- a. This Guidance Material contains performance-based training objectives for TAWS flight crew training.

Subpart D | Revised rule text

- b. **The training objectives cover five areas: theory of operation; pre-flight operations; general in-flight operations; response to TAWS cautions; and response to TAWS warnings.**
- c. **The term 'TAWS' in this GM means a ground proximity warning system (GPWS) enhanced by a forward-looking terrain avoidance function. Alerts include both cautions and warnings.**
- d. **The content of this GM is intended to assist operators who are producing training programmes. The information it contains has not been tailored to any specific aircraft or TAWS equipment, but highlights features which are typically available where such systems are installed. It is the responsibility of the individual operator to determine the applicability of the content of this guidance material to each aircraft and TAWS equipment installed and their operation. Operators should refer to the AFM and/or aircraft/flight crew operating manual A/FCOM, or similar documents, for information applicable to specific configurations. If there should be any conflict between the content of this guidance material and that published in the other documents described above, then information contained in the AFM or A/FCOM will take precedence.**

2. Scope

- a. **The scope of this GM is designed to identify training objectives in the areas of: academic training; manoeuvre training; initial evaluation; and recurrent qualification. Under each of these four areas, the training material has been separated into those items which are considered essential training items and those which are considered to be desirable. In each area, objectives and acceptable performance criteria are defined.**
- b. **No attempt is made to define how the training programme should be implemented. Instead, objectives are established to define the knowledge that a pilot operating a TAWS is expected to possess and the performance expected from a pilot who has completed TAWS training. However, the guidelines do indicate those areas in which the pilot receiving the training should demonstrate his/her understanding, or performance, using a real-time, interactive training device, i.e. a flight simulator. Where appropriate notes are included within the performance criteria which amplify or clarify the material addressed by the training objective.**

3. Performance-based training objectives

- a. **TAWS academic training**
 - i. **This training is typically conducted in a classroom environment. The knowledge demonstrations specified in this section may be completed through the successful completion of written tests or by providing correct responses to non-real-time CBT questions.**

Subpart D | Revised rule text

- ii. **Theory of operation.** The pilot should demonstrate an understanding of TAWS operation and the criteria used for issuing cautions and warnings. This training should address system operation. **Objective:** To demonstrate knowledge of how a TAWS functions. **Criteria:** The pilot should demonstrate an understanding of the following functions:
- A. Surveillance**
1. The GPWS computer processes data supplied from an air data computer, a radio altimeter, an instrument landing system (ILS)/microwave landing system (MLS)/multi-mode (MM) receiver, a roll attitude sensor, and actual position of the surfaces and of the landing gear.
 2. The forward looking terrain avoidance function utilises an accurate source of known aircraft position, such as that which may be provided by a flight management system (FMS) or GPS, or an electronic terrain database. The source and scope of the terrain, obstacle and airport data, and features such as the terrain clearance floor, the runway picker, and geometric altitude (where provided), should all be described.
 3. Displays required to deliver TAWS outputs include a loudspeaker for voice announcements, visual alerts (typically amber and red lights), and a terrain awareness display (that may be combined with other displays). In addition, means should be provided for indicating the status of the TAWS and any partial or total failures that may occur.
- B. Terrain avoidance.** Outputs from the TAWS computer provide visual and audio synthetic voice cautions and warnings to alert the flight crew about potential conflicts with terrain and obstacles.
- C. Alert thresholds.** **Objective:** To demonstrate knowledge of the criteria for issuing cautions and warnings. **Criteria:** The pilot should be able to demonstrate an understanding of the methodology used by a TAWS to issue cautions and alerts and the general criteria for the issuance of these alerts, including:
1. basic GPWS alerting modes specified in the ICAO Standard:
 - Mode 1: excessive sink rate;
 - Mode 2: excessive terrain closure rate;

Subpart D | Revised rule text

Mode 3: descent after take-off or go-around;

Mode 4: unsafe proximity to terrain;

Mode 5: descent below ILS glide slope (caution only); and

2. **an additional, optional alert mode:- Mode 6: radio altitude call-out (information only); TAWS cautions and warnings which alert the flight crew to obstacles and terrain ahead of the aircraft in line with or adjacent to its projected flight path (Forward-Looking Terrain Avoidance (FLTA) and Premature Descent Alert (PDA) functions).**

D. TAWS limitations. Objective: To verify that the pilot is aware of the limitations of TAWS. Criteria: The pilot should demonstrate knowledge and an understanding of TAWS limitations identified by the manufacturer for the equipment model installed, such as:

1. **navigation should not be predicated on the use of the terrain display;**
2. **unless geometric altitude data is provided, use of predictive TAWS functions is prohibited when altimeter subscale settings display 'QFE';**
3. **nuisance alerts can be issued if the aerodrome of intended landing is not included in the TAWS airport database;**
4. **in cold weather operations, corrective procedures should be implemented by the pilot unless the TAWS has in-built compensation, such as geometric altitude data;**
5. **loss of input data to the TAWS computer could result in partial or total loss of functionality. Where means exist to inform the flight crew that functionality has been degraded, this should be known and the consequences understood;**
6. **radio signals not associated with the intended flight profile (e.g. ILS glide path transmissions from an adjacent runway) may cause false alerts;**
7. **inaccurate or low accuracy aircraft position data could lead to false or non-annunciation of terrain or obstacles ahead of the aircraft; and**
8. **minimum equipment list (MEL) restrictions should be applied in the event of the TAWS becoming partially**

Subpart D | Revised rule text

or completely unserviceable. (It should be noted that basic GPWS has no forward-looking capability.)

- E. TAWS inhibits. Objective: To verify that the pilot is aware of the conditions under which certain functions of a TAWS are inhibited. Criteria: The pilot should demonstrate knowledge and an understanding of the various TAWS inhibits, including the following:**
- 1. a means of silencing voice alerts;**
 - 2. a means of inhibiting ILS glide path signals (as may be required when executing an ILS back beam approach);**
 - 3. a means of inhibiting flap position sensors (as may be required when executing an approach with the flaps not in a normal position for landing);**
 - 4. a means of inhibiting the FLTA and PDA functions; and**
 - 5. a means of selecting or deselecting the display of terrain information, together with appropriate annunciation of the status of each selection.**
- b. Operating procedures. The pilot should demonstrate the knowledge required to operate TAWS avionics and to interpret the information presented by a TAWS. This training should address the following topics:**
- i. Use of controls. Objective: To verify that the pilot can properly operate all TAWS controls and inhibits. Criteria: The pilot should demonstrate the proper use of controls, including the following:**
 - A. the means by which, before flight, any equipment self-test functions can be initiated;**
 - B. the means by which TAWS information can be selected for display; and**
 - C. the means by which all TAWS inhibits can be operated and what the consequent annunciations mean with regard to loss of functionality.**
 - ii. Display interpretation. Objective: To verify that the pilot understands the meaning of all information that can be annunciated or displayed by a TAWS. Criteria: The pilot should demonstrate the ability to properly interpret information annunciated or displayed by a TAWS, including the following:**
 - A. knowledge of all visual and aural indications that may be seen or heard;**
 - B. response required on receipt of a caution;**

Subpart D | Revised rule text

- C. **response required on receipt of a warning; and**
 - D. **response required on receipt of a notification that partial or total failure of the TAWS has occurred (including annunciation that the present aircraft position is of low accuracy).**
- iii. **Use of basic GPWS or use of the FLTA function only. Objective: To verify that the pilot understands what functionality will remain following loss of the GPWS or of the FLTA function. Criteria: The pilot should demonstrate knowledge of the following:**
- A. **how to recognise un-commanded loss of the GPWS function, or how to isolate this function and how to recognise the level of the remaining controlled flight into terrain (CFIT) protection (essentially, this is the FLTA function); and**
 - B. **how to recognise un-commanded loss of the FLTA function, or how to isolate this function and how to recognise the level of the remaining CFIT protection (essentially, this is the basic GPWS).**
- iv. **Crew co-ordination. Objective: To verify that the pilot adequately briefs other flight crew members on how TAWS alerts will be handled. Criteria: The pilot should demonstrate that the pre-flight briefing addresses procedures that will be used in preparation for responding to TAWS cautions and warnings, including the following:**
- A. **the action to be taken, and by whom, in the event that a TAWS caution and/or warning is issued; and**
 - B. **how multi-function displays will be used to depict TAWS information at take-off, in the cruise and for the descent, approach, landing (and any go-around). This will be in accordance with procedures specified by the operator, who will recognise that it may be more desirable that other data is displayed at certain phases of flight and that the terrain display has an automatic 'pop-up' mode in the event that an alert is issued.**
- v. **Reporting requirements. Objective: To verify that the pilot is aware of the requirements for reporting alerts to the controller and other authorities. Criteria: The pilot should demonstrate knowledge of the following:**
- A. **when, following recovery from a TAWS alert or caution, a transmission of information should be made to the appropriate air traffic control unit; and**

Subpart D | Revised rule text

- B. **the type of written report which is required, how it is to be compiled, and whether any cross reference should be made in the aircraft technical log and/or voyage report (in accordance with procedures specified by the operator), following a flight in which the aircraft flight path has been modified in response to a TAWS alert, or if any part of the equipment appears not to have functioned correctly.**
- vi. **Alert thresholds. Objective: To demonstrate knowledge of the criteria for issuing cautions and warnings. Criteria: The pilot should be able to demonstrate an understanding of the methodology used by a TAWS to issue cautions and warnings and the general criteria for the issuance of these alerts, including:**
 - A. **awareness of the modes associated with basic GPWS, including the input data associated with each; and**
 - B. **awareness of the visual and aural annunciations that can be issued by TAWS and how to identify which are cautions and which are warnings.**
- c. **TAWS manoeuvre training. The pilot should demonstrate the knowledge required to respond correctly to TAWS cautions and warnings. This training should address the following topics:**
 - i. **Response to cautions:**
 - A. **Objective: To verify that the pilot properly interprets and responds to cautions. Criteria: The pilot should demonstrate an understanding of the need, without delay:**
 1. **to initiate action required to correct the condition which has caused the TAWS to issue the caution and to be prepared to respond to a warning, if this should follow; and**
 2. **if a warning does not follow the caution, to notify the controller of the new position, heading and/or altitude/flight level of the aircraft, and what the commander intends to do next.**
 - B. **The correct response to a caution might require the pilot:**
 1. **to reduce a rate of descent and/or to initiate a climb;**
 2. **to regain an ILS glide path from below, or to inhibit a glide path signal if an ILS is not being flown;**
 3. **to select more flap, or to inhibit a flap sensor if the landing is being conducted with the intent that the normal flap setting will not be used;**
 4. **to select gear down; and/or**

Subpart D | Revised rule text

5. **to initiate a turn away from the terrain or obstacle ahead and towards an area free of such obstructions if a forward-looking terrain display indicates that this would be a good solution and the entire manoeuvre can be carried out in clear visual conditions.**
- ii. **Response to warnings. Objective: To verify that the pilot properly interprets and responds to warnings. Criteria: The pilot should demonstrate an understanding of the following:**
 - A. **The need, without delay, to initiate a climb in the manner specified by the operator.**
 - B. **The need, without delay, to maintain the climb until visual verification can be made that the aircraft will clear the terrain or obstacle ahead or until above the appropriate sector safe altitude (if certain about the location of the aircraft with respect to terrain) even if the TAWS warning stops. If, subsequently, the aircraft climbs up through the sector safe altitude, but the visibility does not allow the flight crew to confirm that the terrain hazard has ended, checks should be made to verify the location of the aircraft and to confirm that the altimeter subscale settings are correct.**
 - C. **When the workload permits, that the flight crew should notify the air traffic controller of the new position and altitude/flight level, and what the commander intends to do next.**
 - D. **That the manner in which the climb is made should reflect the type of aircraft and the method specified by the aircraft manufacturer (which should be reflected in the operations manual) for performing the escape manoeuvre. Essential aspects will include the need for an increase in pitch attitude, selection of maximum thrust, confirmation that external sources of drag (e.g. spoilers/speed brakes) are retracted, and respect of the stick shaker or other indication of eroded stall margin.**
 - E. **That TAWS warnings should never be ignored. However, the pilot's response may be limited to that which is appropriate for a caution, only if:**
 1. **the aircraft is being operated by day in clear, visual conditions; and**
 2. **it is immediately clear to the pilot that the aircraft is in no danger in respect of its configuration, proximity to terrain or current flight path.**

*Subpart D | Revised rule text***d. TAWS initial evaluation:**

- i. The flight crew member's understanding of the academic training items should be assessed by means of a written test.**
- ii. The flight crew member's understanding of the manoeuvre training items should be assessed in a FSTD equipped with TAWS visual and aural displays and inhibit selectors similar in appearance and operation to those in the aircraft which the pilot will fly. The results should be assessed by a flight simulation training instructor, synthetic flight examiner, type rating instructor or type rating examiner.**
- iii. The range of scenarios should be designed to give confidence that proper and timely responses to TAWS cautions and warnings will result in the aircraft avoiding a CFIT accident. To achieve this objective, the pilot should demonstrate taking the correct action to prevent a caution developing into a warning and, separately, the escape manoeuvre needed in response to a warning. These demonstrations should take place when the external visibility is zero, though there is much to be learnt if, initially, the training is given in 'mountainous' or 'hilly' terrain with clear visibility. This training should comprise a sequence of scenarios, rather than be included in line orientated flying training (LOFT).**
- iv. A record should be made, after the pilot has demonstrated competence, of the scenarios that were practised.**

e. TAWS recurrent training:

- i. TAWS recurrent training ensures that pilots maintain the appropriate TAWS knowledge and skills. In particular, it reminds pilots of the need to act promptly in response to cautions and warnings, and of the unusual attitude associated with flying the escape manoeuvre.**
- ii. An essential item of recurrent training is the discussion of any significant issues and operational concerns that have been identified by the operator. Recurrent training should also address changes to TAWS logic, parameters or procedures and to any unique TAWS characteristics of which pilots should be aware.**

f. Reporting procedures:

- i. Verbal reports. Verbal reports should be made promptly to the appropriate air traffic control unit:
 - A. whenever any manoeuvre has caused the aircraft to deviate from an air traffic clearance;****

Subpart D | Revised rule text

- B. **when, following a manoeuvre which has caused the aircraft to deviate from an air traffic clearance, the aircraft has returned to a flight path which complies with the clearance; and/or**
 - C. **when an air traffic control unit issues instructions which, if followed, would cause the pilot to manoeuvre the aircraft towards terrain or obstacle or it would appear from the display that a potential CFIT occurrence is likely to result.**
- ii. **Written reports. Written reports should be submitted in accordance with the operator's occurrence reporting scheme and they also should be recorded in the aircraft technical log:**
 - A. **whenever the aircraft flight path has been modified in response to a TAWS alert (false, nuisance or genuine);**
 - B. **whenever a TAWS alert has been issued and is believed to have been false; and/or**
 - C. **if it is believed that a TAWS alert should have been issued, but was not.**
- iii. **Within this GM, and with regard to reports:**
 - A. **the term 'false' means that the TAWS issued an alert which could not possibly be justified by the position of the aircraft in respect to terrain and it is probable that a fault or failure in the system (equipment and/or input data) was the cause;**
 - B. **the term 'nuisance' means that the TAWS issued an alert which was appropriate, but was not needed because the flight crew could determine by independent means that the flight path was, at that time, safe;**
 - C. **the term 'genuine' means that the TAWS issued an alert which was both appropriate and necessary; and**
 - D. **the report terms described in 3.f.iii above are only meant to be assessed after the occurrence is over, to facilitate subsequent analysis, the adequacy of the equipment and the programmes it contains. The intention is not for the flight crew to attempt to classify an alert into any of these three categories when visual and/or aural cautions or warnings are annunciated.**

*Subpart D | Revised rule text***GM1-CAT.OP.AH.295 Use of airborne collision avoidance system (ACAS II)****GENERAL**

1. The ACAS operational procedures and training programmes established by the operator should take into account this Guidance Material. It incorporates advice contained in:
 - a. ICAO Annex 10, Volume IV;
 - b. ICAO PANS-OPS, Volume 1;
 - c. ICAO PANS-ATM; and
 - d. ICAO guidance material "ACAS Performance-Based Training Objectives" (published under Attachment E of State Letter AN 7/1.3.7.2-97/77).
2. Additional guidance material on ACAS may be referred to, including information available from such sources as EUROCONTROL.

ACAS FLIGHT CREW TRAINING PROGRAMMES

1. During the implementation of ACAS, several operational issues were identified which had been attributed to deficiencies in flight crew training programmes. As a result, the issue of flight crew training has been discussed within the ICAO, which has developed guidelines for operators to use when designing training programmes.
2. This Guidance Material contains performance-based training objectives for ACAS II flight crew training. Information contained in this paper related to traffic advisories (TAs) is also applicable to ACAS I and ACAS III users. The training objectives cover five areas: theory of operation; pre-flight operations; general in-flight operations; response to TAs; and response to resolution advisories (RAs).
3. The information provided is valid for version 7 and 7.1 (ACAS II). Where differences arise, these are identified.
4. The performance-based training objectives are further divided into the areas of: academic training; manoeuvre training; initial evaluation and recurrent qualification. Under each of these four areas, the training material has been separated into those items which are considered essential training items and those which are considered desirable. In each area, objectives and acceptable performance criteria are defined.
5. ACAS academic training
 - a. This training is typically conducted in a classroom environment. The knowledge demonstrations specified in this section may be completed through the successful completion of written tests or through providing correct responses to non-real-time computer-based training (CBT) questions.

*Subpart D | Revised rule text***b. Essential items**

- i. Theory of operation.** The flight crew member should demonstrate an understanding of ACAS II operation and the criteria used for issuing TAs and RAs. This training should address the following topics:

A. System operation

Objective: to demonstrate knowledge of how ACAS functions.

Criteria: the flight crew member should demonstrate an understanding of the following functions:

1. Surveillance

- a. ACAS interrogates other transponder-equipped aircraft within a nominal range of 14 NM.**
- b. ACAS surveillance range can be reduced in geographic areas with a large number of ground interrogators and/or ACAS II-equipped aircraft.**
- c. If the operator's ACAS implementation provides for the use of the Mode S extended squitter, the normal surveillance range may be increased beyond the nominal 14 NM. However, this information is not used for collision avoidance purposes.**

2. Collision avoidance

- a. TAs can be issued against any transponder-equipped aircraft which responds to the ICAO Mode C interrogations, even if the aircraft does not have altitude reporting capability.**
- b. RAs can be issued only against aircraft that are reporting altitude and in the vertical plane only.**
- c. RAs issued against an ACAS-equipped intruder are co-ordinated to ensure complementary RAs are issued.**
- d. Failure to respond to an RA deprives own aircraft of the collision protection provided by own ACAS.**
- e. Additionally, in ACAS-ACAS encounters, it also restricts the choices available to the other aircraft's ACAS and thus renders the other**

Subpart D | Revised rule text

aircraft's ACAS less effective than if own aircraft were not ACAS equipped.

B. Advisory thresholds

Objective: to demonstrate knowledge of the criteria for issuing TAs and RAs.

Criteria: the flight crew member should demonstrate an understanding of the methodology used by ACAS to issue TAs and RAs and the general criteria for the issuance of these advisories, including the following:

- 1. ACAS advisories are based on time to closest point of approach (CPA) rather than distance. The time should be short and vertical separation should be small, or projected to be small, before an advisory can be issued. The separation standards provided by ATS are different from the miss distances against which ACAS issues alerts.**
- 2. Thresholds for issuing a TA or an RA vary with altitude. The thresholds are larger at higher altitudes.**
- 3. A TA occurs from 15 to 48 seconds and an RA from 15 to 35 seconds before the projected CPA.**
- 4. RAs are chosen to provide the desired vertical miss distance at CPA. As a result, RAs can instruct a climb or descent through the intruder aircraft's altitude.**

C. ACAS limitations

Objective: to verify that the flight crew member is aware of the limitations of ACAS.

Criteria: the flight crew member should demonstrate knowledge and understanding of ACAS limitations, including the following:

- 1. ACAS will neither track nor display non-transponder-equipped aircraft, nor aircraft not responding to ACAS Mode C interrogations.**
- 2. ACAS will automatically fail if the input from the aircraft's barometric altimeter, radio altimeter or transponder is lost.**
 - a. In some installations, the loss of information from other on board systems such as an inertial reference system (IRS) or attitude heading reference system (AHRS) may result**

Subpart D | Revised rule text

in an ACAS failure. Individual operators should ensure that their flight crews are aware of the types of failure which will result in an ACAS failure.

- b. ACAS may react in an improper manner when false altitude information is provided to own ACAS or transmitted by another aircraft. Individual operators should ensure that their flight crew are aware of the types of unsafe conditions which can arise. Flight crew members should ensure that when they are advised, if their own aircraft is transmitting false altitude reports, an alternative altitude reporting source is selected, or altitude reporting is switched off.**
- 3. Some aeroplanes within 380 ft above ground level (AGL) (nominal value) are deemed to be 'on ground' and will not be displayed. If ACAS is able to determine an aircraft below this altitude is airborne, it will be displayed.**
- 4. ACAS may not display all proximate transponder-equipped aircraft in areas of high density traffic.**
- 5. The bearing displayed by ACAS is not sufficiently accurate to support the initiation of horizontal manoeuvres based solely on the traffic display.**
- 6. ACAS will neither track nor display intruders with a vertical speed in excess of 10 000 ft/min. In addition, the design implementation may result in some short-term errors in the tracked vertical speed of an intruder during periods of high vertical acceleration by the intruder.**
- 7. Ground proximity warning systems/ground collision avoidance systems (GPWSs/GCASs) warnings and wind shear warnings take precedence over ACAS advisories. When either a GPWS/GCAS or wind shear warning is active, ACAS aural annunciations will be inhibited and ACAS will automatically switch to the 'TA only' mode of operation.**

D. ACAS inhibits

Objective: to verify that the flight crew member is aware of the conditions under which certain functions of ACAS are inhibited.

Subpart D | Revised rule text

Criteria: the flight crew member should demonstrate knowledge and understanding of the various ACAS inhibits, including the following:

1. "Increase Descent" RAs are inhibited below 1 450 ft AGL;
2. "Descend" RAs are inhibited below 1 100 ft AGL;
3. all RAs are inhibited below 1 000 ft AGL;
4. all TA aural annunciations are inhibited below 500 ft AGL; and
5. altitude and configuration under which "Climb" and "Increase Climb" RAs are inhibited. ACAS can still issue "Climb" and "Increase Climb" RAs when operating at the aeroplane's certified ceiling. (In some aircraft types, "Climb" or "Increase Climb" RAs are never inhibited.)

ii. Operating procedures

The flight crew member should demonstrate the knowledge required to operate the ACAS avionics and interpret the information presented by ACAS. This training should address the following:

A. Use of controls

Objective: to verify that the pilot can properly operate all ACAS and display controls.

Criteria: demonstrate the proper use of controls including:

1. aircraft configuration required to initiate a self-test;
2. steps required to initiate a self-test;
3. recognising when the self-test was successful and when it was unsuccessful. When the self-test is unsuccessful, recognising the reason for the failure and, if possible, correcting the problem;
4. recommended usage of range selection. Low ranges are used in the terminal area and the higher display ranges are used in the en-route environment and in the transition between the terminal and en-route environment;
5. recognising that the configuration of the display does not affect the ACAS surveillance volume;
6. selection of lower ranges when an advisory is issued, to increase display resolution;

Subpart D | Revised rule text

7. **proper configuration to display the appropriate ACAS information without eliminating the display of other needed information;**
8. **if available, recommended usage of the above/below mode selector. The above mode should be used during climb and the below mode should be used during descent; and**
9. **if available, proper selection of the display of absolute or relative altitude and the limitations of using this display if a barometric correction is not provided to ACAS.**

B. Display interpretation

Objective: to verify that the flight crew member understands the meaning of all information that can be displayed by ACAS. The wide variety of display implementations require the tailoring of some criteria. When the training programme is developed, these criteria should be expanded to cover details for the operator's specific display implementation.

Criteria: the flight crew member should demonstrate the ability to properly interpret information displayed by ACAS, including the following:

1. **other traffic, i.e. traffic within the selected display range that is not proximate traffic, or causing a TA or RA to be issued;**
2. **proximate traffic, i.e. traffic that is within 6 NM and $\pm 1\ 200$ ft;**
3. **non-altitude reporting traffic;**
4. **no bearing TAs and RAs;**
5. **off-scale TAs and RAs: the selected range should be changed to ensure that all available information on the intruder is displayed;**
6. **TAs: the minimum available display range which allows the traffic to be displayed should be selected, to provide the maximum display resolution;**
7. **RAs (traffic display): the minimum available display range of the traffic display which allows the traffic to be displayed should be selected, to provide the maximum display resolution;**

Subpart D | Revised rule text

8. **RAs (RA display):** flight crew members should demonstrate knowledge of the meaning of the red and green areas or the meaning of pitch or flight path angle cues displayed on the RA display. Flight crew members should also demonstrate an understanding of the RA display limitations, i.e. if a vertical speed tape is used and the range of the tape is less than 2 500 ft/min, an increase rate RA cannot be properly displayed; and
9. **if appropriate,** awareness that navigation displays oriented on "Track-Up" may require a flight crew member to make a mental adjustment for drift angle when assessing the bearing of proximate traffic.

C. Use of the TA only mode

Objective: to verify that a flight crew member understands the appropriate times to select the TA only mode of operation and the limitations associated with using this mode.

Criteria: the flight crew member should demonstrate the following:

1. **Knowledge of the operator's guidance for the use of TA only.**
2. **Reasons for using this mode. If TA only is not selected when an airport is conducting simultaneous operations from parallel runways separated by less than 1 200 ft, and to some intersecting runways, RAs can be expected. If for any reason TA only is not selected and an RA is received in these situations, the response should comply with the operator's approved procedures.**
3. **All TA aural annunciations are inhibited below 500 ft AGL. As a result, TAs issued below 500 ft AGL may not be noticed unless the TA display is included in the routine instrument scan.**

D. Crew co-ordination

Objective: to verify that the flight crew member understands how ACAS advisories will be handled.

Criteria: the flight crew member should demonstrate knowledge of the crew procedures that should be used when responding to TAs and RAs, including the following:

Subpart D | Revised rule text

1. **task sharing between the pilot flying and the pilot monitoring;**
2. **expected call-outs; and**
3. **communications with ATC.**

E. Phraseology requirements

Objective: to verify that the flight crew member is aware of the requirements for reporting RAs to the controller.

Criteria: the flight crew member should demonstrate the following:

1. **the use of the phraseology contained in ICAO PANS-OPS;**
2. **an understanding of the procedures contained in ICAO PANS-ATM and ICAO Annex 2; and**
3. **the understanding that verbal reports should be made promptly to the appropriate ATC unit:**
 - a. **whenever any manoeuvre has caused the aeroplane to deviate from an air traffic clearance;**
 - b. **when, subsequent to a manoeuvre that has caused the aeroplane to deviate from an air traffic clearance, the aeroplane has returned to a flight path that complies with the clearance; and/or**
 - c. **when air traffic issue instructions that, if followed, would cause the crew to manoeuvre the aircraft contrary to an RA with which they are complying.**

F. Reporting requirements

Objective: to verify that the flight crew member is aware of the requirements for reporting RAs to the operator.

Criteria: the flight crew member should demonstrate knowledge of where information can be obtained regarding the need for making written reports to various states when an RA is issued. Various states have different reporting requirements and the material available to the flight crew member should be tailored to the operator's operating environment. For operators involved in commercial operations, this responsibility is satisfied by the flight crew member reporting to the operator according to the applicable reporting requirements.

*Subpart D | Revised rule text***c. Non-essential items: advisory thresholds**

Objective: to demonstrate knowledge of the criteria for issuing TAs and RAs.

Criteria: the flight crew member should demonstrate an understanding of the methodology used by ACAS to issue TAs and RAs and the general criteria for the issuance of these advisories, including the following:

- i. the minimum and maximum altitudes below/above which TAs will not be issued;
- ii. when the vertical separation at CPA is projected to be less than the ACAS-desired separation, a corrective RA which requires a change to the existing vertical speed will be issued. This separation varies from 300 ft at low altitude to a maximum of 700 ft at high altitude;
- iii. when the vertical separation at CPA is projected to be just outside the ACAS-desired separation, a preventive RA that does not require a change to the existing vertical speed will be issued. This separation varies from 600 to 800 ft; and
- iv. RA fixed range thresholds vary between 0.2 and 1.1 NM.

6. ACAS manoeuvre training

- a. Demonstration of the flight crew member's ability to use ACAS displayed information to properly respond to TAs and RAs should be carried out in a full flight simulator equipped with an ACAS display and controls similar in appearance and operation to those in the aircraft. If a full flight simulator is utilised, CRM should be practised during this training.
- b. Alternatively, the required demonstrations can be carried out by means of an interactive CBT with an ACAS display and controls similar in appearance and operation to those in the aircraft. This interactive CBT should depict scenarios in which real-time responses should be made. The flight crew member should be informed whether or not the responses made were correct. If the response was incorrect or inappropriate, the CBT should show what the correct response should be.
- c. The scenarios included in the manoeuvre training should include: corrective RAs; initial preventive RAs; maintain rate RAs; altitude crossing RAs; increase rate RAs; RA reversals; weakening RAs; and multi-aircraft encounters. The consequences of failure to respond correctly should be demonstrated by reference to actual incidents such as those publicised in EUROCONTROL ACAS II 'safety flash' Bulletins.

*Subpart D | Revised rule text***i. TA responses**

Objective: to verify that the pilot properly interprets and responds to TAs.

Criteria: the pilot should demonstrate the following:

- A.** Proper division of responsibilities between the pilot flying and the pilot monitoring. The pilot flying should fly the aircraft using any type-specific procedures and be prepared to respond to any RA that might follow. For aircraft without an RA pitch display, the pilot flying should consider the likely magnitude of an appropriate pitch change. The pilot monitoring should provide updates on the traffic location shown on the ACAS display, using this information to help visually acquire the intruder.
- B.** Proper interpretation of the displayed information. Flight crew members should confirm that the aircraft they have visually acquired is that which has caused the TA to be issued. Use should be made of all information shown on the display, note being taken of the bearing and range of the intruder (amber circle), whether it is above or below (data tag), and its vertical speed direction (trend arrow).
- C.** Other available information should be used to assist in visual acquisition, including ATC "party-line" information, traffic flow in use, etc..
- D.** Because of the limitations described, the pilot flying should not manoeuvre the aircraft based solely on the information shown on the ACAS display. No attempt should be made to adjust the current flight path in anticipation of what an RA would advise, except that if own aircraft is approaching its cleared level at a high vertical rate with a TA present, vertical rate should be reduced to less than 1 500 ft/min.
- E.** When visual acquisition is attained, and as long as no RA is received, normal right of way rules should be used to maintain or attain safe separation. No unnecessary manoeuvres should be initiated. The limitations of making manoeuvres based solely on visual acquisition, especially at high altitude or at night, or without a definite horizon should be demonstrated as being understood.

ii. RA responses

Objective: to verify that the pilot properly interprets and responds to RAs.

Criteria: the pilot should demonstrate the following:

Subpart D | Revised rule text

- A. Proper response to the RA, even if it is in conflict with an ATC instruction and even if the pilot believes that there is no threat present.**
- B. Proper task sharing between the pilot flying and the pilot monitoring. The pilot flying should respond to a corrective RA with appropriate control inputs. The pilot monitoring should monitor the response to the RA and should provide updates on the traffic location by checking the traffic display. Proper crew resource management (CRM) should be used.**
- C. Proper interpretation of the displayed information. The pilot should recognise the intruder causing the RA to be issued (red square on display). The pilot should respond appropriately.**
- D. For corrective RAs, the response should be initiated in the proper direction within five seconds of the RA being displayed. The change in vertical speed should be accomplished with an acceleration of approximately $\frac{1}{4}$ g (gravitational acceleration of 9.81 m/sec^2).**
- E. Recognition of the initially displayed RA being modified. Response to the modified RA should be properly accomplished, as follows:**
 - 1. For increase rate RAs, the vertical speed change should be started within two and a half seconds of the RA being displayed. The change in vertical speed should be accomplished with an acceleration of approximately $\frac{1}{3}$ g.**
 - 2. For RA reversals, the vertical speed reversal should be started within two and a half seconds of the RA being displayed. The change in vertical speed should be accomplished with an acceleration of approximately $\frac{1}{3}$ g.**
 - 3. For RA weakenings, the vertical speed should be modified to initiate a return towards the original clearance.**
 - 4. An acceleration of approximately $\frac{1}{4}$ g will be achieved if the change in pitch attitude corresponding to a change in vertical speed of 1 500 ft/min is accomplished in approximately five seconds, and of $\frac{1}{3}$ g if the change is accomplished in approximately three seconds. The change in pitch attitude required to establish a rate of climb or descent of 1 500 ft/min from level flight will be approximately 6° when the true airspeed (TAS) is**

Subpart D | Revised rule text

150 kts, 4° at 250 kts, and 2° at 500 kts. (These angles are derived from the formula: 1 000 divided by TAS.).

- F. Recognition of altitude crossing encounters and the proper response to these RAs.**
- G. For preventive RAs, the vertical speed needle or pitch attitude indication, should remain outside the red area on the RA display.**
- H. For maintain rate RAs, the vertical speed should not be reduced. Pilots should recognise that a maintain rate RA may result in crossing through the intruder's altitude.**
- I. When the RA weakens, or when the green 'fly to' indicator changes position, the pilot should initiate a return towards the original clearance, and when "clear of conflict" is annunciated, the pilot should complete the return to the original clearance.**
- J. The controller should be informed of the RA as soon as time and workload permit, using the standard phraseology.**
- K. When possible, an ATC clearance should be complied with while responding to an RA. For example, if the aircraft can level at the assigned altitude while responding to RA (an "adjust vertical speed" RA (version 7) or "level off" (version 7.1) it should be done; the horizontal (turn) element of an ATC instruction should be followed.**
- L. Knowledge of the ACAS multi-aircraft logic and its limitations, and that ACAS can optimise separations from two aircraft by climbing or descending towards one of them. For example, ACAS only considers intruders which it considers to be a threat when selecting an RA. As such, it is possible for ACAS to issue an RA against one intruder which results in a manoeuvre towards another intruder which is not classified as a threat. If the second intruder becomes a threat, the RA will be modified to provide separation from that intruder.**

7. ACAS initial evaluation

- a. The flight crew member's understanding of the academic training items should be assessed by means of a written test or interactive CBT that records correct and incorrect responses to phrased questions.**
- b. The flight crew member's understanding of the manoeuvre training items should be assessed in a full flight simulator equipped with an ACAS display and controls similar in appearance and operation to**

Subpart D | Revised rule text

those in the aircraft the flight crew member will fly, and the results assessed by a qualified instructor, inspector, or check airman. The range of scenarios should include: corrective RAs; initial preventive RAs; maintain rate RAs; altitude crossing RAs; increase rate RAs; RA reversals; weakening RAs; and multi-threat encounters. The scenarios should also include demonstrations of the consequences of not responding to RAs, slow or late responses, and manoeuvring opposite to the direction called for by the displayed RA.

- c. Alternatively, exposure to these scenarios can be conducted by means of an interactive CBT with an ACAS display and controls similar in appearance and operation to those in the aircraft the pilot will fly. This interactive CBT should depict scenarios in which real-time responses should be made and a record made of whether or not each response was correct.

8. ACAS recurrent training

- a. ACAS recurrent training ensures that flight crew members maintain the appropriate ACAS knowledge and skills. ACAS recurrent training should be integrated into and/or conducted in conjunction with other established recurrent training programmes. An essential item of recurrent training is the discussion of any significant issues and operational concerns that have been identified by the operator. Recurrent training should also address changes to ACAS logic, parameters or procedures and to any unique ACAS characteristics which flight crew members should be made aware of.
- b. It is recommended that operator's recurrent training programmes using full flight simulators include encounters with conflicting traffic when these simulators are equipped with ACAS. The full range of likely scenarios may be spread over a two-year period. If a full flight simulator, as described above, is not available, use should be made of an interactive CBT that is capable of presenting scenarios to which pilot responses should be made in real-time.

GM1-CAT.OP.AH.300 Approach and landing conditions

Comment [WSI75]:
IEM OPS 1.400

IN-FLIGHT DETERMINATION OF THE LANDING DISTANCE

The in-flight determination of the landing distance should be based on the latest available meteorological or runway state report, preferably not more than 30 minutes before the expected landing time.

Subpart D | Revised rule text

GM1-CAT.OP.AH.315 Flight hours reporting - helicopters

FLIGHT HOURS REPORTING

- 1. The requirement in CAT.OP.AH.315 may be achieved by making available either:**
 - a. the flight hours flown by each helicopter – identified by its serial number and registration mark - during the previous calendar year; or**
 - b. the total flight hours of each helicopter – identified by its serial number and registration mark – on the 31st of December of the previous calendar year.**
- 2. Where possible, the operator should have available, for each helicopter, the breakdown of hours for CAT operations. If the exact hours for the functional activity cannot be established, the estimated proportion will be sufficient.**

Subpart E | Revised rule text

Scope

This document shows the transposition of EU-OPS Subpart F-I into the new European OPS rules.

It also contains the related Section 2 material of JAR-OPS1.

Track changes show changes to the EU-OPS text.

*Subpart E | Revised rule text***Table of Contents**

[05]Part-CAT	6
Subpart B - Operating procedures	6
Section 1 – Aeroplanes and helicopters	6
CAT.OP.AH.110 Aerodrome operating minima	6
CAT.OP.AH.115 Approach flight technique - aeroplanes	8
CAT.OP.AH.120 Airborne radar approaches	8
[01]Annex I - Definitions for terms used in Annexes II - VI.....	9
[10]Part-SPA.....	10
Subpart E - Low visibility operations	10
SPA.LVO.100 Low visibility operations	10
SPA.LVO.105 LVO approval	11
SPA.LVO.110 General operating requirements	11
SPA.LVO.115 Aerodrome considerations	12
SPA.LVO.120 Flight crew training and qualifications	12
SPA.LVO.125 Operating procedures.....	12
SPA.LVO.130 Minimum equipment	13
[06]Part-CAT	26
Subpart B - Operating procedures – AMC/GM.....	26
AMC1-CAT.OP.AH.110 Aerodrome operating minima	26
TAKE-OFF OPERATIONS	26
[11]Part-SPA.....	29
Subpart E – Low visibility operations – AMC/GM	29
AMC1-SPA.LVO.100 Low visibility operations	29
LVTO OPERATIONS	29
[02]Annex I - Definitions for terms used in Annexes II - VI.....	32
[07]Part-CAT	32
Subpart B - Operating procedures – AMC/GM.....	32
AMC1-CAT.OP.AH.110 Aerodrome operating minima	32
NPA, APV, CAT I OPERATIONS.....	32
[12]Part-SPA.....	46

Subpart E | Revised rule text

Subpart E – Low visibility operations – AMC/GM	46
AMC1-SPA.LVO.100 Low visibility operations	46
FAILED OR DOWNGRADED EQUIPMENT	46
AMC1-SPA.LVO.100 Low visibility operations	48
LTS CAT I OPERATIONS.....	48
[03]Annex I - Definitions for terms used in Annexes II - VI.....	50
[13]Part-SPA.....	51
Subpart E – Low visibility operations – AMC/GM	51
AMC1-SPA.LVO.100 Low visibility operations	51
CAT II AND OTS CAT II OPERATIONS.....	51
[04]Annex I - Definitions for terms used in Annexes II - VI.....	54
[14]Part-SPA.....	55
Subpart E – Low visibility operations – AMC/GM	55
AMC1-SPA.LVO.100 Low visibility operations	55
CAT III OPERATIONS	55
OPERATIONS UTILISING EVS	56
[08]Part-CAT	60
Subpart B - Operating procedures – AMC/GM.....	60
AMC1-CAT.OP.AH.110 Aerodrome operating minima	60
CIRCLING OPERATIONS - AEROPLANES.....	60
ONSHORE CIRCLING OPERATIONS - HELICOPTERS	61
VISUAL APPROACH OPERATIONS.....	61
CONVERSION OF REPORTED METEOROLOGICAL VISIBILITY TO RVR.....	61
Subpart B - Operating procedures	63
CAT.OP.AH.325 Aeroplane categories	63
[15]Part-SPA.....	64
Subpart E – Low visibility operations – AMC/GM	64
AMC1-SPA.LVO.105 LVO approval	64
GENERAL STANDARDS	64
OPERATIONAL DEMONSTRATION - AEROPLANES	64
OPERATIONAL DEMONSTRATION - HELICOPTERS.....	65
CONTINUOUS MONITORING – ALL AIRCRAFT	66

Subpart E | Revised rule text

[18]Part-AR.....	68
Subpart OPS – Specific requirements related to air operations	68
Section II - Approvals.....	68
AMC3-AR.OPS.200 Specific Approval Procedure	68
PROCEDURES FOR LOW VISIBILITY APPROVALS - TRANSITIONAL PERIODS FOR CAT II OR CAT III	68
[16]Part-SPA.....	69
Subpart E – Low visibility operations – AMC/GM	69
AMC1-SPA.LVO.105 LVO approval	69
MAINTENANCE OF CAT II, CAT III AND LVTO EQUIPMENT	69
ELIGIBLE AERODROMES AND RUNWAYS	69
AMC1-SPA.LVO.120 Flight crew training and qualifications	70
GENERAL STANDARDS	70
GROUND TRAINING	72
FSTD TRAINING AND/OR FLIGHT TRAINING	73
CONVERSION TRAINING.....	75
TYPE AND COMMAND EXPERIENCE	77
LVTO OPERATIONS	77
RECURRENT TRAINING AND CHECKING	78
LTS CAT I, OTS CAT II, OPERATIONS UTILISING EVS	79
AMC1-SPA.LVO.125 Operating procedures	80
GENERAL.....	80
[09]Part-CAT	83
Subpart B - Operating procedures	83
AMC1-CAT.OP.AH.310(d) Commencement and continuation of approach	83
VISUAL REFERENCES FOR INSTRUMENT APPROACH OPERATIONS	83
Subpart B - Operating procedures – AMC/GM.....	85
AMC1-CAT.OP.AH.110.A Aerodrome operating minima	85
CIRCLING – AEROPLANES.....	85
GM2-CAT.OP.AH.110 Aerodrome operating minima	88
ONSHORE AERODROME DEPARTURE PROCEDURES – HELICOPTERS	88
GM3-CAT.OP.AH.110 Aerodrome operating minima	88
APPROACH LIGHT SYSTEMS – ICAO, FAA	88
GM1-CAT.OP.AH.110(c) Aerodrome operating minima	89

Subpart E | Revised rule text

INCREMENTS SPECIFIED BY THE COMPETENT AUTHORITY	89
GM1-CAT.OP.AH.115 Approach flight technique - aeroplanes.....	89
CONTINUOUS DESCENT FINAL APPROACH (CDFA).....	89
AMC1-CAT.OP.AH.115 Approach flight technique - aeroplanes	92
CONTINUOUS DESCENT FINAL APPROACH (CDFA).....	92
AMC1-CAT.OP.AH.120 Airborne radar approaches (ARAs) for overwater operations - helicopters	102
GENERAL.....	102
GM1-CAT.OP.AH.120 Airborne radar approaches (ARAs) for overwater operations - helicopters	103
GENERAL.....	103
[17]Part-SPA.....	108
Subpart E – Low visibility operations – AMC/GM	108
GM1-SPA.LVO.100 Low visibility operations.....	108
DOCUMENTS CONTAINING INFORMATION RELATED TO LOW VISIBILITY OPERATIONS	108
GM2-SPA.LVO.100 Low visibility operations.....	108
USE OF ENHANCED VISION SYSTEMS (EVS)	108
GM3-SPA.LVO.100 Low visibility operations.....	110
CREW ACTIONS IN CASE OF AUTOPILOT FAILURE AT OR BELOW DH IN FAIL-PASSIVE CAT III OPERATIONS.....	110
GM4-SPA.LVO.100 Low visibility operations.....	110
ESTABLISHMENT OF MINIMUM RVR FOR CAT II AND CAT III OPERATIONS	110
GM5-SPA.LVO.100 Low visibility operations.....	113
ILS CLASSIFICATION	113
AMC2-SPA.LVO.105 LVO approval.....	113
OPERATIONAL DEMONSTRATION AND DATA COLLECTION/ANALYSIS.....	113
GM1-SPA.LVO.105 LVO approval.....	115
CRITERIA FOR A SUCCESSFUL CAT II, OTS CAT, CAT III APPROACH AND AUTOMATIC LANDING	115
GM1-SPA.LVO.120 Flight crew training and qualifications	115
FLIGHT CREW TRAINING	115

Subpart E | Revised rule text

[05]Part-CAT**SUBPART E-Subpart B - Operating procedures****Section 1 – Aeroplanes and helicopters****ALL-WEATHER OPERATIONS****CAT.OP.AH.110 Aerodrome operating minima ~~OPS 1.430 Aerodrome Operating Minima—General~~****(See Appendix 1 (Old) and Appendix 1 (New) to OPS 1.430)**

(a) ~~(1) An~~ **The operator shall establish aerodrome operating minima**, for each **departure, destination or alternate** aerodrome planned to be used, ~~aerodrome operating minima that are not lower than the values given in Appendix 1 (Old) or Appendix 1 (New) as applicable. The method of determination of such minima must be acceptable to the Authority.~~ **These** Such minima shall not be lower than any **those** ~~seat~~ may be established for such aerodromes by the State in which the aerodrome is located, except when specifically approved by that State. **Any increment specified by the competent authority shall be added to the minima.**

Comment [WSI1]:
This article also contains OPS 1.225.

Comment [WSI2]:
Half-sentence deleted because the values in the Appendix are an AMC (to which no reference can be made in an IR).

Comment [WSI3]:
Covered in (d).

Comment [WSI4]:
OPS 1.225 (b)

(b) The use of **head-up displays (HUD), head-up display landing systems (HUDLS) or enhanced vision systems (EVS)** may allow operations with lower visibilities than normally associated with the **established** aerodrome operating minima **if approved in accordance with SPA.LVO.** ~~States which promulgate aerodrome operating minima may also promulgate regulations for reduced visibility minima associated with the use of HUD or EVS.~~

Comment [WSI5]:
Guidance material and therefore deleted.

~~(a) (2) Notwithstanding paragraph (a)(1) above, in flight calculation of minima for use at unplanned alternate aerodromes and/or for approaches utilising EVS shall be carried out in accordance with a method acceptable to the Authority.~~

Comment [WSI6]:
Deleted because this rule is not specific enough.

(bc) **When establishing aerodrome operating minima, the operator shall take the following into account:** ~~In establishing the aerodrome operating minima which will apply to any particular operation, an operator must take full account of:~~

- (1) ~~t~~ **The type, performance and handling characteristics of the aeroplane/aircraft;**
- (2) ~~t~~ **The composition, of the flight crew, their competence and experience of the flight crew;**
- (3) ~~t~~ **The dimensions and characteristics of the runways / final approach and take-off areas (FATOs) which that may be selected for use;**
- (4) ~~t~~ **The adequacy and performance of the available visual and non-visual ground aids—(See Appendix 1 (New) to OPS 1.430 Table 6a);**
- (5) ~~t~~ **The equipment available on the aeroplane—aircraft for the purpose of navigation and/or control of the flight path, as appropriate, during the take-off, the approach, the flare, the landing, roll-out/rollout and the missed approach;**

~~(6) for the determination of obstacle clearance, the obstacles in the approach, missed approach and the climb-out areas necessary for the execution of contingency procedures~~ **The obstacles in the approach,**

Comment [WSI7]:
Revised text to improve readability.

Subpart E | Revised rule text

~~missed approach and the climb out areas required for the execution of contingency procedures and necessary clearance;;~~

- ~~(7) The obstacle clearance altitude/height for the instrument approach procedures;~~
- ~~(8) The means to determine and report meteorological conditions; **and and**~~
- ~~(9) The flight technique to be used during the final approach.-~~

~~(e) The aeroplane categories referred to in this Subpart must be derived in accordance with the method given in Appendix 2 to OPS 1.430 (c).~~

Comment [WSI8]:
Transposed in CAT.OP.AH.115.

~~(d)(1) All approaches shall be flown as stabilised approaches (SAp) unless otherwise approved by the Authority for a particular approach to a particular runway.~~

~~(d)(2) All non-precision approaches shall be flown using the continuous descent final approaches (CDFA) technique unless otherwise approved by the Competent Authority for a particular approach to a particular runway. When calculating the minima in accordance with Appendix 1 (New), the operator shall ensure that the applicable minimum RVR is increased by 200 metres (m) for Cat A/B aeroplanes and by 400 m for Cat C/D aeroplanes for approaches not flown using the CDFA technique, providing that the resulting RVR/CMV value does not exceed 5000m.~~

~~(d)(3) Notwithstanding the requirements in (d)(2) above, an Competent Authority may exempt an operator from the requirement to increase the RVR when not applying the CDFA technique.(d)(4) Exemptions as described in paragraph (d)(3) must be limited to locations where there is a clear public interest to maintain current operations. The exemptions must be based on the operator's experience, training programme and flight crew qualification. The exemptions must be reviewed at regular intervals and must be terminated as soon as facilities are improved to allow application of the CDFA technique.~~

~~(e)(1) An operator must ensure that either Appendix 1 (Old) or Appendix 1 (New) to OPS 1.430 is applied. However, an operator must ensure that Appendix 1 (New) to OPS 1.430 is applied not later than three years after publication date.~~

Comment [WSI9]:
Deleted because it is not applicable anymore.

~~(e)(2) Notwithstanding the requirements in (e)(1) above, an Authority may exempt an operator from the requirement to increase the RVR above 1500 m (Cat A/B aeroplanes) or above 2400 m (Cat C/D aeroplanes), when approving an operation to a particular runway where it is not practicable to fly an approach using the CDFA technique or where the criteria in paragraph (c) of Appendix 1 (New) to OPS 1.430 cannot be met.(e)(3) Exemptions as described in paragraph (e)(2) must be limited to locations where there is a clear public interest to maintain current operations. The exemptions must be based on the operator's experience, training programme and flight crew qualification. The exemptions must be reviewed at regular intervals and must be terminated as soon as facilities are improved to allow application of the CDFA technique.~~

Comment [WSI10]:
Deleted because it should be dealt with an alternative means of compliance procedure.

(d) The operator shall specify the method of determining aerodrome operating minima in the operations manual.

(e) The minima for a specific approach and landing procedure shall only be used if all the following conditions are met:

Comment [WSI11]:
Integrating OPS 1. 225.

- (1) the ground equipment shown on the chart required for the intended procedure is operative;**

Subpart E | Revised rule text

- (2) the aircraft systems required for the type of approach are operative;
- (3) the required aircraft performance criteria are met; and
- (4) the crew is appropriately qualified.

CAT.OP.AH.115 Approach flight technique - aeroplanes

Comment [WSI12]:
Transposes 1.430 (c).

- (a) All approaches shall be flown as stabilised approaches unless otherwise approved by the competent authority for a particular approach to a particular runway.
- (b) **Non-precision approaches**
 - (1) The continuous descent final approach (CDFA) technique shall be used for all non-precision approaches.
 - (2) Notwithstanding (1) above, another approach flight technique may be used for a particular approach / runway combination if approved by the competent authority. In such cases, the applicable minimum runway visual range (RVR)
 - (i) shall be increased by 200 m for Category A and B aeroplanes and by 400 m for Category C and D aeroplanes; or
 - (ii) for aerodromes where there is a public interest to maintain current operations and the CDFA technique cannot be applied, shall be established and regularly reviewed by the competent authority taking into account the operator's experience, training programme and flight crew qualification.

CAT.OP.AH.120 ~~Operating minima — Helicopter Airborne Radar~~ Approaches

Comment [WSI13]:
Transposed from OPS.CAT.150.H.

- (a) An ARA shall only be undertaken ~~provided if:~~
 - (1) the radar provides course guidance to ensure obstacle clearance; and
 - (2) **either:**
 - (i) the ~~m~~Minimum ~~d~~Descent ~~h~~Height (MDH) is determined from a radio altimeter; or
 - (ii) the ~~m~~Minimum ~~d~~Descent ~~a~~Altitude (MDA) plus an adequate margin is applied.
- (b) ~~— ARAs to moving rigs or vessels that are under way shall only be conducted in multi-crew operations.~~
- (c) The decision range shall provide adequate obstacle clearance in the missed approach from any destination for which ~~the an~~ ARA is planned.
- (d) ~~An~~ **The** approach shall only be continued beyond decision range or below MDA/~~HH/A~~ when visual reference with the destination has been established.
- (e) For single-~~pilot~~ operations, appropriate increments shall be added to the MDA/~~AH/A~~ **H** and decision range.

Subpart E | Revised rule text

[01]Annex I - Definitions for terms used in Annexes II - VIOPS 1.435
Terminology

Terms used in this Subpart have the following meaning:

...

- (~~xx1~~) Circling **means** ~~the~~ visual phase of an instrument approach to bring an aircraft into position for landing on a runway/**FATO** which is not suitably located for a straight-in approach.
- (~~xx2~~) Low Visibility Procedures (LVP) **means** ~~procedures~~ applied at an aerodrome for the purpose of ensuring safe operations during Lower than Standard Category I, Other than Standard Category II, Category II and **Category III** approaches and Low Visibility Take-Offs.
- (~~xx3~~) Low Visibility Take-Off (LVTO) ~~means~~ **A** take-off ~~where the~~ **with a** Runway Visual Range (RVR) ~~is lower~~ less than 400 m **but not less** than **75 m**.
- (~~xx4~~) Flight control system **means in the context of low visibility operations,** ~~A~~ a system which includes an automatic landing system and/or a hybrid landing system.
- (~~xx5~~) Fail-~~Passive~~ **passive** flight control system **means** ~~A~~ a flight control system is fail-passive if, in the event of a failure, there is no significant out-of-trim condition or deviation of flight path or attitude but the landing is not completed automatically. For a fail-passive automatic flight control system the pilot assumes control of the aeroplane after a failure.
- (~~xx6~~) Fail-~~Operational~~ **operational** flight control system **means** ~~A~~ a flight control system ~~is fail operational if~~ **with which**, in the event of a failure below alert height, the approach, flare and landing, can be completed automatically. In the event of a failure, the automatic landing system will operate as a fail-passive system.
- (~~xx7~~) Fail-operational hybrid landing system ~~means~~ **A** a system which consists of a primary fail-passive automatic landing system and a secondary independent guidance system enabling the pilot to complete a landing manually after failure of the primary system.
- (~~xx8~~) Visual approach **means** ~~A~~ an approach when either part or all of an instrument approach procedure is not completed and the approach is executed with visual reference to the terrain.
- (~~xx9~~) Continuous Descent Final Approach (CDFA) **means** ~~A~~ a specific technique, **consistent with stabilized approach procedures**, for flying the final-approach segment of a non-precision instrument approach procedure as a continuous descent, without level-off, from an altitude / height at or above the Final Approach Fix altitude / height to a point approximately 15 m (50 ft) above the landing runway threshold or the point where the flare manoeuvre ~~should~~ **shall** begin for the type of ~~aeroplane~~ **aircraft** flown.
- (~~xx10~~) Stabilised Approach (SAp) **means** ~~A~~ an approach which is flown in a controlled and appropriate manner in terms of configuration, energy and control of the flight path from a ~~pre-determined~~ **pre-determined** point or altitude/height down to a point 50 feet above the threshold or the point where the flare manoeuvre is initiated if higher.

Comment [WSI14]:
 Aligned with ICAO PANS-OPS definition.

Subpart E | Revised rule text

~~(xx11)~~ Head-Up Display (HUD) **means** ~~—A—~~ a display system which presents flight information into the pilot's forward external field of view and which does not significantly restrict the external view.

~~(xx12)~~ Head-Up Guidance Landing System (HUDLS) **means** ~~—T—the~~ total airborne system which provides head-up guidance to the pilot during the approach and landing and/or go-around **missed approach procedure**. It includes all sensors, computers, power supplies, indications and controls. A HUDLS is typically used for primary approach guidance to ~~decision height~~ **DHs** of 50 ft.

~~(xx13)~~ Hybrid Head-Up Display Landing System (Hybrid HUDLS) **means** ~~—A—a~~ system which consists of a primary fail-passive automatic landing system and a secondary independent HUD/HUDLS enabling the pilot to complete a landing manually after failure of the primary system.

Comment [WSI15]:
Moved to AMC

~~Note: Typically, the secondary independent HUD/HUDLS provides guidance which normally takes the form of command information, but it may alternatively be situation (or deviation) information.~~

~~(14xx)~~ Enhanced Vision System (EVS) **means** ~~—A an~~ electronic means of displaying a real-time image of the external scene through the use of imaging sensors.

~~(15xx)~~ Converted Meteorological Visibility (CMV) **means** ~~—A—a~~ value, (equivalent to an RVR,) which is derived from the reported meteorological visibility, ~~as converted in accordance with the requirements in this subpart.~~

~~(16xx)~~ Lower than Standard Category I (**LTS CAT I**) ~~Operation~~ **operation means a—A** Category I Instrument Approach and Landing Operation using Category I ~~DDHH~~, with an RVR lower than would normally be associated with the applicable DH **but not lower than 400 m.**

~~(17)~~ ~~Other than Standard Category II Operation. A Category II Instrument Approach and Landing Operation to a runway where some or all of the elements of the ICAO Annex 14 Precision Approach Category II lighting system are not available.~~

Comment [WSI16]:
Replaced by the definition specified further below.

~~(18xx)~~ **GBAS** ~~NSS~~ Landing System (GLS) **means** ~~—An—an~~ approach **landing system** operation using **ground based** augmented GNSS information to provide guidance to the aircraft based on its lateral and vertical GNSS position. ~~(It uses geometric altitude reference for its final approach slope.)~~

Comment [WSI17]:
Aligned with ICAO PANS ATM and PANS ABC.
Moved to AMC.

...

[10]Part-SPA

Subpart E - Low visibility operations (LVO)

SPA.LVO.100 Low visibility operations

The operator shall only conduct the following low visibility operations (LVO) when approved by the competent authority:

- (a) low visibility take-off (LVTO) operation;
- (b) lower than Standard Category I (LTS CAT I) operation;

Subpart E | Revised rule text

- (c) **Standard Category II (CAT II) operation;**
- (d) **Standard other than Standard Category II (OTS CAT II) operation;**
- (e) **Category III (CAT III) operation; and**
- (f) **approach operation utilising enhanced vision systems (EVS) for which an operational credit on the runway visual range (RVR) minima is applied.**

SPA.LVO.105 LVO approval

To obtain competent authority approval for LVOs, the operator shall demonstrate compliance with the requirements of this Subpart.

SPA.LVO.110~~OPS 1.440~~ **Low visibility operations—General operating rules requirements**~~(See Appendix 1 to OPS 1.440)~~

- (a) **The operator shall only conduct LTS CAT I operations if:**
- (1) **each aircraft concerned is certified for operations to conduct CAT II operations; and**
 - (2) **the approach is flown:**
 - (i) **auto-coupled to an auto-land which needs to be approved for CAT IIIA operations; or**
 - (ii) **using an approved head-up display landing system (HUDLS) to at least 150 ft above the threshold.**
- (ba) ~~An operator~~**The operator** shall **only not** ~~conduct Category II CAT II, Other than Standard Category II OTS CAT II or IICAT III operations unless~~**if:**
- (1) ~~Each aeroplane~~**aircraft** concerned is certified ~~rated~~ **equipped** for operations with a decision heights **(DH)** below 200 ft, or no decision height **DH**, and equipped in accordance with **the applicable airworthiness requirements**~~CS-AWO on all weather operations or an equivalent accepted by the Authority;~~
 - (2) ~~a~~**A** suitable system for recording approach and/or automatic landing success and failure is established and maintained to monitor the overall safety of the operation;
 - ~~(3) The operations are approved by the Authority;~~
 - (4) ~~The flight crew consists of at least 2 pilots; and~~
 - (5) ~~the DH~~**Decision Height** is determined by means of a radio altimeter; **and**
 - (4) **the flight crew consists of at least two pilots.**
- (b) ~~An operator shall not conduct low visibility take offs in less than 150 m RVR (Category A, B and C aeroplanes) or 200 m RVR (Category D aeroplanes) unless approved by the Authority.~~
- (c) ~~An operator shall not conduct Lower than Standard Category I operations unless approved by the Authority.~~
- (c) **The operator shall only conduct approach operations utilising an EVS if:**
- (1) **the EVS is certified;**

Comment [WSI18]:
Rule Source of added text:
Appendix 1 to OPS 1.430 (h)
approval.

Comment [WSI19]:
Already stipulated in SPA.LVO.100.

Comment [WSI20]:
Already stipulated in SPA.LVO.100.
Text has been moved from
Appendix 1 (New) to OPS 1.430
(e).

Comment [WSI21]:
Rule Source: Appendix 1 to OPS
1.430

Subpart E | Revised rule text

(2) call-out heights below 200 ft above the aerodrome threshold are determined by means of a radio altimeter; and

Comment [WSI22]:
Appendix 1 to OS 1.455 (b)(2)(ix).

(3) the flight crew consists of at least two pilots.

Comment [WSI23]:
ACJ OPS to Appendix 1 (New) to JAR-OPS 1.430(h)

SPA.LVO.115 ~~OPS 1.445 Low visibility operations~~ Aerodrome considerations

(a) ~~An operator~~ **The operator** shall not use an aerodrome for ~~low-LVOs~~ **visibility operations** unless:

(1) the aerodrome has been is approved for such operations by the State **of in** which the aerodrome is located; **and-**

(b2) An operator shall verify that low visibility procedures (LVP) have been established, **and will be enforced,** at those aerodromes.

(b) At aerodromes where the term LVP is not used, operator **the operator shall ensure that there are equivalent procedures that adhere to the requirements of LVP at the aerodrome. This situation shall be clearly noted in the operations manual or procedures manual including guidance to the flight crew on how to determine that the equivalent LVP are in effect.**

Comment [WSI24]:
Added in response to a comment.

SPA.LVO.120 ~~OPS 1.450 Low visibility operations~~ — Flight crew tTraining and Qualifications
(See Appendix 1 to OPS 1.450)

~~An operator~~ **The operator** shall ensure that, prior to conducting ~~an LVO~~ **Low Visibility Take-Off, Lower than Standard Category I, Other than Standard Category II, Category II and III operations or approach utilising EVS:**

(a±) eEach flight crew member:±

(1i) c ~~Completes~~ **complies with** the training and checking requirements prescribed in ~~the operations manual, Appendix 1~~ including **flight simulation training device (Flight simulator-FSTD)** training, in operating to the limiting values of RVR/CMV (**converted meteorological visibility**) and ~~Decision Height-DH~~ **specific to the operation and the aircraft type** ~~appropriate to the operator's approval; and~~

(2#) i ~~Is~~ qualified in accordance with **the standards prescribed in the operations manual** ~~Appendix 1;~~

(b2) t ~~The training and checking is conducted in accordance with a detailed syllabus, approved by the Competent Authority and included in the Operations Manual. This training is in addition to that prescribed in Subpart N;~~ **and**

Comment [WSI25]:
Deleted because it has a characteristic of a note or GM.

SPA.LVO.125 ~~OPS 1.455 Low visibility operations~~ — Operating pProcedures
(See Appendix 1 to OPS 1.455)

(a) ~~An~~ **The operator must** ~~shall~~ establish procedures and instructions to be used for ~~LVOs~~ **Low Visibility Take-Off, approaches utilising EVS, Lower than Standard Category I, Other than Standard Category II, Category II and III operations. These procedures must** ~~shall~~ be included in the ~~Operations Manual~~ **operations manual or procedures manual** and contain the duties of flight crew members during taxiing,

Subpart E | Revised rule text

take-off, approach, flare, landing, ~~roll-out~~ rollout and missed approach **operations**, as appropriate.

- (b) **Prior to commencing an LVO, the commander/pilot-in-command/commander shall be satisfied** ~~by himself/herself that:~~
 - (1) ~~The status of the visual and non-visual facilities is sufficient prior to commencing a Low Visibility Take-Off, an Approach utilising EVS, a Lower than Standard Category I, an Other than Standard Category II, or a Category II or III approach;~~
 - (2) ~~Appropriate LVPs are in force according to information received from **air traffic services (ATS)** Air Traffic Services, before commencing a Low Visibility Take-off, a Lower than Standard Category I, an Other than Standard Category II, or a Category II or III approach; and~~
 - (3) ~~The flight crew members are properly qualified prior to commencing a Low Visibility Take-off in an RVR of less than 150 m (Category A, B and C aeroplanes) or 200 m (Cat D aeroplanes), an Approach utilising EVS, a Lower than Standard Category I, an Other than Standard Category II or a Category II or III approach.~~

SPA.LVO.130OPS 1.460 Low-visibility operations — Minimum equipment

- (a) ~~An~~ **The operator must shall** include in the Operations Manual the minimum equipment that has to be serviceable at the commencement of an **LVO** ~~Low Visibility Take-off, a Lower than Standard Category I approach, an Other than Standard Category II approach, an approach utilising EVS, or a Category II or III approach in accordance with the **aircraft flight manual (AFM)** or other approved document **in the operations manual or procedures manual, as applicable.**~~
- (b) The **pilot-in-command/commander shall be satisfied** ~~y himself/herself that the status of the ~~aeropl~~ane **aircraft** and of the relevant airborne systems is appropriate for the specific operation to be conducted.~~

~~OPS 1.465 VFR Operating minima (See Appendix 1 to OPS 1.465)~~

Comment [WSI26]:
Should be covered by Part-SERA. Verification of EC requested.

~~An operator shall ensure that:~~

- ~~1) VFR flights are conducted in accordance with the Visual Flight Rules and in accordance with the Table in Appendix 1 to OPS 1.465.~~
- ~~2) Special VFR flights are not commenced when the visibility is less than 3 km and not otherwise conducted when the visibility is less than 1,5 km.~~

~~Appendix 1 (Old) to OPS 1.430 Aerodrome Operating Minima~~

Comment [WSI27]:
Deleted because not anymore applicable.

~~(a) Take-off Minima~~

~~(1) General~~

~~(i) Take off minima established by the operator must be expressed as visibility or RVR limits, taking into account all relevant factors for each aerodrome planned to be used and the aeroplane characteristics. Where there is a specific need to see and avoid~~

Subpart E | Revised rule text

~~obstacles on departure and/or for a forced landing, additional conditions (e.g. ceiling) must be specified.~~

~~(ii) — The commander shall not commence take-off unless the weather conditions at the aerodrome of departure are equal to or better than applicable minima for landing at that aerodrome unless a suitable take-off alternate aerodrome is available.~~

~~(iii) — When the reported meteorological visibility is below that required for take-off and RVR is not reported, a take-off may only be commenced if the commander can determine that the RVR/visibility along the take-off runway is equal to or better than the required minimum.~~

~~(iv) — When no reported meteorological visibility or RVR is available, a take-off may only be commenced if the commander can determine that the RVR/visibility along the take-off runway is equal to or better than the required minimum.~~

~~(2) — Visual reference. The take-off minima must be selected to ensure sufficient guidance to control the aeroplane in the event of both a discontinued take-off in adverse circumstances and a continued take-off after failure of the critical power unit.~~

~~(3) — Required RVR/Visibility~~

~~(i) — For multi-engined aeroplanes, whose performance is such that, in the event of a critical power unit failure at any point during take-off, the aeroplane can either stop or continue the take-off to a height of 1 500 ft above the aerodrome while clearing obstacles by the required margins, the take-off minima established by an operator must be expressed as RVR/Visibility values not lower than those given in Table 1 below except as provided in paragraph (4) below:~~

Subpart E | Revised rule text

Table 1
 RVR/Visibility for take-off

Take-off RVR/Visibility	
Facilities	RVR/Visibility (Note 3)
Nil (Day only)	500 m
Runway edge lighting and/or centreline marking	250/300 m (Notes 1 & 2)
Runway edge and centreline lighting	200/250 m (Note 1)
Runway edge and centreline lighting and multiple RVR information	150/200 m (Notes 1 & 4)

Note 1: The higher values apply to Category D aeroplanes.

Note 2: For night operations at least runway edge and runway end lights are required.

Note 3: The reported RVR/Visibility value representative of the initial part of the take off run can be replaced by pilot assessment.

Note 4: The required RVR value must be achieved for all of the relevant RVR reporting points with the exception given in Note 3 above.

(ii) For multi-engined aeroplanes whose performance is such that they cannot comply with the performance conditions in subparagraph (a)(3)(i) above in the event of a critical power unit failure, there may be a need to re-land immediately and to see and avoid obstacles in the take-off area. Such aeroplanes may be operated to the following take-off minima provided they are able to comply with the applicable obstacle clearance criteria, assuming engine failure at the height specified. The take-off minima established by an operator must be based upon the height from which the one-engine inoperative net take-off flight path can be constructed. The RVR minima used may not be lower than either of the values given in Table 1 above or Table 2 below.

Subpart E | Revised rule text

(1) System minima

(i) An operator must ensure that system minima for non precision approach procedures, which are based upon the use of ILS without glide path (LLZ only), VOR, NDB, SRA and VDF are not lower than the MDH values given in Table 3 below.

Table 3
System minima for non precision approach aids

System minima Facility	Lowest MDH
ILS (no glide path — LLZ)	250 ft
SRA (terminating at ½ NM)	250 ft
SRA (terminating at 1 NM)	300 ft
SRA (terminating at 2 NM)	350 ft
VOR	300 ft
VOR/DME	250 ft
NDB	300 ft
VDF (QDM & QGH)	300 ft

(2) Minimum Descent Height. An operator must ensure that the minimum descent height for a non precision approach is not lower than either:

- (i) The OCH/OCL for the category of aeroplane; or
- (ii) The system minimum.

(3) Visual Reference. A pilot may not continue an approach below MDA/MDH unless at least one of the following visual references for the intended runway is distinctly visible and identifiable to the pilot:

- (i) Elements of the approach light system;
- (ii) The threshold;
- (iii) The threshold markings;
- (iv) The threshold lights;
- (v) The threshold identification lights;
- (vi) The visual glide slope indicator;
- (vii) The touchdown zone or touchdown zone markings;
- (viii) The touchdown zone lights;
- (ix) Runway edge lights; or

Subpart E | Revised rule text

(x) — Other visual references accepted by the Authority.

(4) — Required RVR. The lowest minima to be used by an operator for non-precision approaches are:

Table 4a
RVR for non-precision approach — full facilities

Non-precision approach minima Full facilities (Notes (1), (5), (6) and (7))				
MDH	RVR/Aeroplane Category			
	A	B	C	D
250 — 299 ft	800 m	800 m	800 m	1 200 m
300 — 449 ft	900 m	1 000 m	1 000 m	1 400 m
450 — 649 ft	1 000 m	1 200 m	1 200 m	1 600 m
650 ft and above	1 200 m	1 400 m	1 400 m	1 800 m

Table 4b
RVR for non-precision approach — intermediate facilities

Non-precision approach minima Intermediate facilities (Notes (2), (5), (6) and (7))				
MDH	RVR/Aeroplane Category			
	A	B	C	D
250 — 299 ft	1 000 m	1 100 m	1 200 m	1 400 m
300 — 449 ft	1 200 m	1 300 m	1 400 m	1 600 m
450 — 649 ft	1 400 m	1 500 m	1 600 m	1 800 m
650 ft and above	1 500 m	1 500 m	1 800 m	2 000 m

Table 4c
RVR for non-precision approach — basic facilities

Non-precision approach minima Basic facilities (Notes (3), (5), (6) and (7))	
MDH	RVR/Aeroplane Category

Subpart E | Revised rule text

	A	B	C	D
250—299 ft	1-200 m	1-300 m	1-400 m	1-600 m
300—449 ft	1-300 m	1-400 m	1-600 m	1-800 m
450—649 ft	1-500 m	1-500 m	1-800 m	2-000 m
650 ft and above	1-500 m	1-500 m	2-000 m	2-000 m

Table 4d
RVR for non-precision approach — Nil approach light facilities

Non-precision approach minima Nil approach light facilities (Notes (4), (5), (6) and (7))				
MDH	RVR/Aeroplane Category			
	A	B	C	D
250—299 ft	1-500 m	1-500 m	1-600 m	1-800 m
300—449 ft	1-500 m	1-500 m	1-800 m	2-000 m
450—649 ft	1-500 m	1-500 m	2-000 m	2-000 m
650 ft and above	1-500 m	1-500 m	2-000 m	2-000 m

Note 1: Full facilities comprise runway markings, 720 m or more of HI/MI approach lights, runway edge lights, threshold lights and runway end lights. Lights must be on.

Note 2: Intermediate facilities comprise runway markings, 420–719 m of HI/MI approach lights, runway edge lights, threshold lights and runway end lights. Lights must be on.

Note 3: Basic facilities comprise runway markings, <420 m of HI/MI approach lights, any length of LI approach lights, runway edge lights, threshold lights and runway end lights. Lights must be on.

Note 4: Nil approach light facilities comprise runway markings, runway edge lights, threshold lights, runway end lights or no lights at all.

Note 5: The tables are only applicable to conventional approaches with a nominal descent slope of not greater than 4°. Greater descent slopes will usually require that visual glide slope guidance (e.g. PAPI) is also visible at the Minimum Descent Height.

Note 6: The above figures are either reported RVR or meteorological visibility converted to RVR as in subparagraph (h) below.

Note 7: The MDH mentioned in Table 4a, 4b, 4c and 4d refers to the initial calculation of MDH. When selecting the associated RVR, there is no need to take account

Subpart E | Revised rule text

~~of a rounding up to the nearest ten feet, which may be done for operational purposes, e.g. conversion to MDA.~~

~~(5) — Night operations. For night operations at least runway edge, threshold and runway end lights must be on.~~

~~(c) — Precision approach — Category I operations~~

~~(1) — General. A Category I operation is a precision instrument approach and landing using ILS, MLS or PAR with a decision height not lower than 200 ft and with a runway visual range not less than 550 m.~~

~~(2) — Decision Height. An operator must ensure that the decision height to be used for a Category I precision approach is not lower than:~~

~~(i) — The minimum decision height specified in the Aeroplane Flight Manual (AFM) if stated;~~

~~(ii) — The minimum height to which the precision approach aid can be used without the required visual reference;~~

~~(iii) — The OCH/OCL for the category of aeroplane; or~~

~~(iv) — 200 ft.~~

~~(3) — Visual Reference. A pilot may not continue an approach below the Category I decision height, determined in accordance with subparagraph (c)(2) above, unless at least one of the following visual references for the intended runway is distinctly visible and identifiable to the pilot:~~

~~(i) — Elements of the approach light system;~~

~~(ii) — The threshold;~~

~~(iii) — The threshold markings;~~

~~(iv) — The threshold lights;~~

~~(v) — The threshold identification lights;~~

~~(vi) — The visual glide slope indicator;~~

~~(vii) — The touchdown zone or touchdown zone markings;~~

~~(viii) — The touchdown zone lights; or~~

~~(ix) — Runway edge lights.~~

~~(4) — Required RVR. The lowest minima to be used by an operator for Category I operations are:~~

Table 5
RVR for Cat I approach vs. facilities and DH

Category I minima	
Decision height (Note 7)	Facilities/RVR (Note 5)

Subpart E | Revised rule text

	Full (Notes 1 & 6)	Interm (Notes 2 & 6)	Basic (Notes 3 & 6)	Nil (Notes 4 & 6)
200 ft	550 m	700 m	800 m	1 000 m
201-250 ft	600 m	700 m	800 m	1 000 m
251-300 ft	650 m	800 m	900 m	1 200 m
301 ft and above	800 m	900 m	1 000 m	1 200 m

Note 1: — Full facilities comprise runway markings, 720 m or more of HI/MI approach lights, runway edge lights, threshold lights and runway end lights. Lights must be on.

Note 2: — Intermediate facilities comprise runway markings, 420-719 m of HI/MI approach lights, runway edge lights, threshold lights and runway end lights. Lights must be on.

Note 3: — Basic facilities comprise runway markings, <420 m of HI/MI approach lights, any length of LI approach lights, runway edge lights, threshold lights and runway end lights. Lights must be on.

Note 4: — Nil approach light facilities comprise runway markings, runway edge lights, threshold lights, runway end lights or no lights at all.

Note 5: — The above figures are either the reported RVR or meteorological visibility converted to RVR in accordance with paragraph (h).

Note 6: — The Table is applicable to conventional approaches with a glide slope angle up to and including 4° (degree).

Note 7: — The DH mentioned in the Table 5 refers to the initial calculation of DH. When selecting the associated RVR, there is no need to take account of a rounding up to the nearest ten feet, which may be done for operational purposes, (e.g. conversion to DA).

(5) — Single pilot operations. For single pilot operations, an operator must calculate the minimum RVR for all approaches in accordance with OPS 1.430 and this Appendix. An RVR of less than 800 m is not permitted except when using a suitable autopilot coupled to an ILS or MLS, in which case normal minima apply. The Decision Height applied must not be less than 1,25 x the minimum use height for the autopilot.

(6) — Night operations. For night operations at least runway edge, threshold and runway end lights must be on.

(d) — Precision approach — Category II operations

(1) — General. A Category II operation is a precision instrument approach and landing using ILS or MLS with:

(i) — A decision height below 200 ft but not lower than 100 ft; and

(ii) — A runway visual range of not less than 300 m.

Subpart E | Revised rule text

(2) — Decision Height. An operator must ensure that the decision height for a Category II operation is not lower than:

- (i) — The minimum decision height specified in the AFM, if stated;
- (ii) — The minimum height to which the precision approach aid can be used without the required visual reference;
- (iii) — The OCH/OCL for the category of aeroplane;
- (iv) — The decision height to which the flight crew is authorised to operate; or
- (v) — 100 ft.

(3) — Visual reference. A pilot may not continue an approach below the Category II decision height determined in accordance with subparagraph (d)(2) above unless visual reference containing a segment of at least 3 consecutive lights being the centre line of the approach lights, or touchdown zone lights, or runway centre line lights, or runway edge lights, or a combination of these is attained and can be maintained. This visual reference must include a lateral element of the ground pattern, i.e. an approach lighting crossbar or the landing threshold or a barette of the touchdown zone lighting.

(4) — Required RVR. The lowest minima to be used by an operator for Category II operations are:

Table _____ 6
RVR for Cat II approach vs DH

Category II minima		
	Auto coupled to below DH (see Note 1)	
Decision height	RVR/Aeroplane Category A, B & C	RVR/Aeroplane Category D
100 ft - 120 ft	300 m	300 m (Note 2)/350 m
121 ft - 140 ft	400 m	400 m
141 ft and above	450 m	450 m

Note 1: — The reference to "auto coupled to below DH" in this table means continued use of the automatic flight control system down to a height which is not greater than 80 % of the applicable DH. Thus airworthiness requirements may, through minimum engagement height for the automatic flight control system, affect the DH to be applied.

Note 2: — 300 m may be used for a Category D aeroplane conducting an auto land.

(e) — Precision approach — Category III operations

(1) — General. Category III operations are subdivided as follows:

(i) — Category III A operations. A precision instrument approach and landing using ILS or MLS with:

Subpart E | Revised rule text

~~(A) — A decision height lower than 100 ft; and~~

~~(B) — A runway visual range not less than 200 m.~~

~~(ii) — Category III-B operations. A precision instrument approach and landing using ILS or MLS with:~~

~~(A) — A decision height lower than 50 ft, or no decision height; and~~

~~(B) — A runway visual range lower than 200 m but not less than 75 m.~~

~~Note: Where the decision height (DH) and runway visual range (RVR) do not fall within the same category, the RVR will determine in which category the operation is to be considered.~~

~~(2) — Decision Height. For operations in which a decision height is used, an operator must ensure that the decision height is not lower than:~~

~~(i) — The minimum decision height specified in the AFM, if stated;~~

~~(ii) — The minimum height to which the precision approach aid can be used without the required visual reference; or~~

~~(iii) — The decision height to which the flight crew is authorised to operate.~~

~~(3) — No Decision Height Operations. Operations with no decision height may only be conducted if:~~

~~(i) — The operation with no decision height is authorised in the AFM;~~

~~(ii) — The approach aid and the aerodrome facilities can support operations with no decision height; and~~

~~(iii) — The operator has an approval for CAT III operations with no decision height.~~

~~Note: In the case of a CAT III runway it may be assumed that operations with no decision height can be supported unless specifically restricted as published in the AIP or NOTAM.~~

~~(4) — Visual reference~~

~~(i) — For Category IIIA operations, and for category IIIB operations with fail passive flight control systems, a pilot may not continue an approach below the decision height determined in accordance with subparagraph (e)(2) above unless a visual reference containing a segment of at least 3 consecutive lights being the centreline of the approach lights, or touchdown zone lights, or runway centre line lights, or runway edge lights, or a combination of these is attained and can be maintained.~~

~~(ii) — For Category IIIB operations with fail operational flight control systems using a decision height, a pilot may not continue an approach below the Decision Height, determined in accordance with subparagraph (e)(2) above, unless a visual reference containing at least one centreline light is attained and can be maintained.~~

~~(iii) — For Category III operations with no decision height there is no requirement for visual contact with the runway prior to touchdown.~~

~~(5) — Required RVR. The lowest minima to be used by an operator for Category III operations are:~~

~~Table _____ 7
RVR for Cat III approach vs. DH and roll-out control/guidance system~~

Subpart E | Revised rule text

Category III minima			
Approach Category	Decision Height (ft) (Note 2)	Roll-out — Control/ Guidance System	RVR (m)
III A	Less than 100 ft	Not required	200 — m
III B	Less than 100 ft	Fail passive	150 — m (Notes 1)
III B	Less than 50 ft	Fail passive	125 m
III B	Less than 50 ft or no Decision Height	Fail operational	75 m

Note 1: — For aeroplanes certificated in accordance with CS AWO on all weather operations 321(b)(3).

Note 2: — Flight control system redundancy is determined under CS AWO on all weather operations by the minimum certificated decision height.

(f) — Circling

(1) — The lowest minima to be used by an operator for circling are:

Table ————— 8
Visibility and MDH for circling vs. aeroplane category

	Aeroplane Category			
	A	B	C	D
MDH	400 ft	500 ft	600 ft	700 ft
Minimum meteorological visibility	1 500 m	1 600 m	2 400 m	3 600 m

(2) — Circling with prescribed tracks is an accepted procedure within the meaning of this paragraph

(g) — Visual Approach. An operator shall not use an RVR of less than 800 m for a visual approach.

(h) — Conversion of Reported Meteorological Visibility to RVR

(1) — An operator must ensure that a meteorological visibility to RVR conversion is not used for calculating take-off minima, Category II or III minima or when a reported RVR is available.

Note: If the RVR is reported as being above the maximum value assessed by the aerodrome operator, e.g. "RVR more than 1 500 metres", it is not considered to be a reported RVR in this context and the Conversion Table may be used.

Subpart E | Revised rule text

(2) ~~When converting meteorological visibility to RVR in all other circumstances than those in subparagraph (h)(1) above, an operator must ensure that the following Table is used:~~

Table _____ 9
 Conversion of visibility to RVR

Lighting elements in operation	RVR = Reported Met. Visibility x	
	Day	Night
HI approach and runway lighting	1-5	2-0
Any type of lighting installation other than above	1-0	1-5
No lighting	1-0	Not applicable

Subpart E | Revised rule text

[06]Part-CAT**Subpart B - Operating procedures – AMC/GM****AMC1-CAT.OP.AH.110 Appendix 1 (New) to OPS 1.430 Aerodrome Operating operating Minima****TAKE-OFF OPERATIONS** ~~(A) — TAKE OFF MINIMA~~**1. Take-off operations****a.** ~~(1)~~ General

- (i.) Take-off minima established by the operator ~~must~~ **should** be expressed as visibility or **runway visual range (RVR)** limits, taking into account all relevant factors for each aerodrome planned to be used and the ~~aeroplane~~ **aircraft** characteristics. Where there is a specific need to see and avoid obstacles on departure and/or for a forced landing, additional conditions, (e.g. ceiling), ~~must~~ **should** be specified.
- (ii.) The commander ~~shall~~ **should** not commence take-off unless the weather conditions at the aerodrome of departure are equal to or better than applicable minima for landing at that aerodrome unless a suitable take-off alternate aerodrome is available.
- (iii.) When the reported meteorological visibility is below that required for take-off and RVR is not reported, a take-off ~~may~~ **should** only be commenced if the commander can determine that the RVR/visibility along the take-off runway/**area** is equal to or better than the required minimum.
- (iv.) When no reported meteorological visibility or RVR is available, a take-off ~~may~~ **should** only be commenced if the commander can determine that the RVR/visibility along the take-off runway/**area** is equal to or better than the required minimum.

b. ~~(2)~~ Visual reference-

- i. The take-off minima ~~must~~ **should** be selected to ensure sufficient guidance to control the ~~aeroplane~~ **aircraft** in the event of both a ~~discontinued~~ **rejected** take-off in adverse circumstances and a continued take-off after failure of the critical ~~power unit~~ **engine**.
- ii. **For night operations, ground lights should be available to illuminate the runway/final approach and take-off area (FATO) and any obstacles.**

Comment [WSI28]:
Source: NPA

c. ~~(3)~~ Required RVR/**Visibility – aeroplanes**

- (i.) For multi-engined aeroplanes, ~~whose~~ **with** performance ~~is~~ such that, in the event of a critical ~~power unit~~ **engine** failure at any point during take-off, the aeroplane can either stop or continue the take-off to a height of 1 500 ft above the aerodrome while clearing obstacles by the required

Subpart E | Revised rule text

margins, the take-off minima ~~established~~ **specified** by an operator ~~the operator must~~ **should** be expressed as RVR/**CMV** ~~visibility~~ **(converted meteorological visibility)** values not lower than those ~~given~~ **specified** in Table 1.A ~~below except as provided in paragraph (4) below.~~

- (ii.) For multi-engined aeroplanes ~~whose~~ **without the** performance is such that they ~~cannot to~~ comply with the performance conditions in sub-paragraph (a)(3)(i) **1.c.i.** above in the event of a critical ~~power unit~~ **engine** failure, there may be a need to re-land immediately and to see and avoid obstacles in the take-off area. Such aeroplanes may be operated to the following take-off minima provided they are able to comply with the applicable obstacle clearance criteria, assuming engine failure at the height specified. The take-off minima ~~established~~ **specified** by an operator ~~the operator must~~ **should** be based upon the height from which the **one-engine-inoperative (OEI)** ~~one engine inoperative~~ net take-off flight path can be constructed. The RVR minima used ~~may~~ **should** not be lower than either of the values ~~given~~ **specified** in Table 1.A ~~above or~~ Table 2.A ~~below.~~
- (iii.) When ~~reported~~ RVR, or meteorological visibility is not available, the commander ~~shall~~ **should** not commence take-off unless he/**she** can determine that the actual conditions satisfy the applicable take-off minima.

Table 1.A: Take-off – aeroplanes (without an approval for low visibility take-off (LVTO))
RVR/CMV ~~visibility~~ for take-off

Take-off RVR/ visibility	RVR/ CMV (m) * visibility (Note 3)
Facilities	
Day only: Nil**-(Day only)	500 m
Day: at least rRunway edge lights ing and/or runway centrelinecentreline markings	400 250/300 m (Notes 1 & 2)
Night: at least runway edge lights or runway centreline lights and runway end lights	
Runway edge and centreline lighting	200/250 m (Note 1)
Runway edge and centreline lighting and multiple RVR information	150/200 m (Notes 1 & 4)

*Note 1: ~~The higher values apply to Category D aeroplanes.~~

Note 2: ~~For night operations at least runway edge and runway end lights are required.~~

Note 3: ~~The reported RVR/~~**CMV** ~~visibility~~ value representative of the initial part of the take-off run can be replaced by pilot assessment.

Subpart E | Revised rule text

- **:** The pilot is able to continuously identify the take-off surface and maintain directional control. ~~Note 4: — The required RVR value must be achieved for all of the relevant RVR reporting points with the exception given in Note 3 above.~~

Table 2.A: Take-off - aeroplanes
Assumed engine failure height above the runway versus RVR/Visibility/CMV

Assumed engine failure height above the take-off runway (ft)	RVR/CMV (m) **
<<50 ft	400 (200 with LVTO approval) ¶
51 - 100 ft	400 (300 with LVTO approval) ¶
101 - 150 ft	400 ¶
151 - 200 ft	500 ¶
201 - 300 ft	1 000 ¶
>>300 ft *	1 500 m (Note 1)

~~Note 1*:~~ 1 500 m is also applicable if no positive take-off flight path can be constructed.

~~Note 2**:~~ The reported RVR/Visibility value representative of the initial part of the take-off run can be replaced by pilot assessment.

d. Required RVR/VIS – helicopters:

- i. For performance class 1 operations, the operator should specify an RVR/VIS as take-off minima in accordance with Table 1.H.
- ii. For performance class 2 operations onshore, the commander should operate to take-off minima of 800 m RVR/CMV and remain clear of cloud during the take-off manoeuvre until reaching performance class 1 capabilities.
- iii. For performance class 2 operations offshore, the commander should operate to minima not less than that for performance class 1 and remain clear of cloud during the take-off manoeuvre until reaching performance class 1 capabilities.
- iv. Table 9 for converting reported meteorological visibility to RVR, should not be used for calculating take-off minima.

Comment [WSI29]:
Inserted in accordance with the NPA.

Table 1.H: Take-off – helicopters (without LVTO approval)
RVR/CMV

Onshore aerodromes with instrument flight rules (IFR) departure procedures	RVR/CMV (m)
No light and no markings (day only)	400 or the rejected take-off distance, whichever is the

Subpart E | Revised rule text

	greater
No markings (night)	800
Runway edge/FATO light and centreline marking	400
Runway edge/FATO light, centreline marking and relevant RVR information	400
Offshore helideck *	
Two-pilot operations	400
Single-pilot operations	500

*: The take-off flight path to be free of obstacles.

[11]Part-SPA

Subpart E – Low visibility operations (LVO)

AMC1-SPA.LVO.100 Low visibility operations

LVTO OPERATIONS(4) — ~~EXCEPTIONS TO SUB-PARAGRAPH (A)(3)(I) ABOVE:~~

~~(I) SUBJECT TO THE APPROVAL OF THE AUTHORITY, AND PROVIDED THE REQUIREMENTS IN PARAGRAPHS (A) TO (E) BELOW HAVE BEEN SATISFIED, AN OPERATOR MAY REDUCE THE TAKE-OFF MINIMA TO 125 M RVR (CATEGORY A, B AND C AEROPLANES) OR 150 M RVR (CATEGORY D AEROPLANES) WHEN:~~

~~(A) LOW VISIBILITY PROCEDURES ARE IN FORCE;~~

~~(B) HIGH INTENSITY RUNWAY CENTRELINE LIGHTS SPACED 15 M OR LESS AND HIGH INTENSITY EDGE LIGHTS SPACED 60 M OR LESS ARE IN OPERATION;~~

~~(C) FLIGHT CREW MEMBERS HAVE SATISFACTORILY COMPLETED TRAINING IN A FLIGHT SIMULATOR;~~

~~(D) A 90 M VISUAL SEGMENT IS AVAILABLE FROM THE COCKPIT AT THE START OF THE TAKE-OFF RUN; AND~~

~~(E) THE REQUIRED RVR VALUE HAS BEEN ACHIEVED FOR ALL OF THE RELEVANT RVR REPORTING POINTS~~

~~(II) SUBJECT TO THE APPROVAL OF THE AUTHORITY, AN OPERATOR OF AN AEROPLANE USING EITHER: (A) AN APPROVED LATERAL GUIDANCE SYSTEM; OR,~~

~~(B) AN APPROVED HUD / HUDLS FOR TAKE OFF MAY REDUCE THE TAKE-OFF MINIMA TO AN RVR LESS THAN 125 M (CATEGORY A, B AND C AEROPLANES) OR 150 M (CATEGORY D AEROPLANES) BUT NOT LOWER THAN 75 M PROVIDED RUNWAY~~

Subpart E | Revised rule text

~~PROTECTION AND FACILITIES EQUIVALENT TO CATEGORY III LANDING OPERATIONS ARE AVAILABLE.~~

1. Aeroplanes

In addition to the take-off standards specified in Part-CAT, Part-SPO, Part-NCC, Part-NCO and subject to the approval of the competent authority, the operator may conduct:

- a. a low visibility take-off (LVTO) with a runway visual range (RVR) below 400 m if the criteria specified in Table 1.A are met;
- b. an LVTO with an RVR below 150 m to 125 m if:
 - i. high intensity runway centreline lights spaced 15 m or less and high intensity edge lights spaced 60 m or less are in operation;
 - ii. a 90 m visual segment is available from the flight crew compartment at the start of the take-off run; and
 - iii. the required RVR value has been achieved for all of the relevant RVR reporting points;
- c. an LVTO with an RVR below 125m to 75m, if:
 - i. runway protection and facilities equivalent to CAT III landing operations are available; and
 - ii. the aircraft is equipped either with:
 - A. an approved lateral guidance system; or,
 - B. an approved head-up display / head-up display landing system (HUD / HUDLS) for take-off.

Table 1.A: LVTO – aeroplanes
RVR/CMV (converted meteorological visibility)

Comment [WSI30]:
This table includes a commenter's table which contained the result of a harmonised table with the FAA.

Facilities	RVR/CMV (m) *, **
Day: runway edge lights and runway centreline markings	300
Night: runway edge lights or runway centreline lights and runway end lights	
Runway edge lights and runway centreline lights	200
Runway edge lights and runway centreline lights and relevant RVR information ***	TDZ, MID, rollout 150
High intensity runway centreline lights spaced 15 m or less and high intensity edge lights spaced 60 m or less are in operation ***	TDZ, MID, rollout 125
Runway protection and facilities equivalent to CAT III landing operations are available and	TDZ, MID, rollout 125

Subpart E | Revised rule text

the aircraft is equipped either with an approved lateral guidance system or an approved HUD / HUDLS for take-off.

- *: The reported RVR/CMV (converted meteorological visibility) value representative of the initial part of the take-off run can be replaced by pilot assessment.
- ** : Multi-engined aeroplanes, which in the event of an engine failure at any point during take-off can either stop or continue the take-off to a height of 1 500 ft above the aerodrome while clearing obstacles by the required margins.
- ***: The required RVR value to be achieved for all relevant RVRs
 TDZ: touchdown zone
 MID: midpoint

2. Helicopters

In addition to the take-off standards specified in Part-CAT, Part-SPO, Part-NCC, Part-NCO and subject to the approval of the competent authority, the operator may conduct take-offs if the criteria specified in Table 1.H are met.

Table 1.H: Take-off – helicopters with LVTO approval
 RVR/CMV

Onshore aerodromes with IFR departure procedures	RVR/ CMV (m)
No light and no markings (day only)	250 or the rejected take-off distance, whichever is the greater
No markings (night)	800
Runway edge/FATO light and centreline marking	200
Runway edge/FATO light, centreline marking and relevant RVR information	150
Offshore helideck *	
Two-pilot operations	250
Single-pilot operations	500

- *: The take-off flight path to be free of obstacles.
 FATO: final approach and take-off area

Subpart E | Revised rule text

[02]Annex I - Definitions for terms used in Annexes II - VI

...

~~(b) Category I, APV and Non-precision Approach Operations~~

~~(1xx) A Category I **CAT I** approach operation **means** is a precision instrument approach and landing using ILS, MLS, GLS (GNSS/GBAS) or PAR with a decision height **DH** not lower than 200 ft and with an RVR not less than 550 m **for aeroplanes and 500 m for helicopters**, unless accepted by the Authority.~~

~~(xx2) A Non-Precision Approach (NPA) operation **means** is an instrument approach using any of the facilities described in Table 3 (System Minima), with a MDH, or DH **when flying a CDFA technique**, not lower than 250 ft and an RVR/CMV of not less than 750 m **for aeroplanes and 600 m for helicopters**, unless accepted by the Authority.~~

~~(xx3) An **Approach Procedure with Vertical Guidance (APV)** operation **means** is an instrument approach which utilises lateral and vertical guidance, but does not meet the requirements established for precision approach and landing operations, with a DH not lower than ~~250-200 ft~~ and an ~~runway visual range~~ **RVR** of not less than **550 m for aeroplanes and 500 m for helicopters** ~~600m unless approved by the Authority.~~~~

Comment [WSI31]:
This has been lowered to DH 200ft because the new OPS rules also include LPV.

...

[07]Part-CAT**Subpart B - Operating procedures – AMC/GM****AMC1-CAT.OP.AH.110 Aerodrome operating minima**

...

NPA, APV, CAT I OPERATIONS

~~1.(4) Decision Height (DH). An operator must ensure that t~~The decision height (**DH**) to be used for an **NPA, approach procedure with vertical guidance (APV) or CAT I approach operation** ~~is~~ **should** not be lower than **the highest of:**

~~a.(i) t~~The minimum height to which the approach aid can be used without the required visual reference; ~~or~~

~~b.(ii) t~~The **obstacle clearance height (OCH)** for the category of ~~aeroplane~~ **aircraft**; ~~or~~

~~c.(iii) t~~The published approach procedure ~~decision height~~ **DH** where applicable; ~~or~~

~~(iv) 200 ft for Category I approach operations; or~~

~~d.(v) t~~The system minimum **specified** in Table 3; ~~or~~

~~e.(vi) t~~The lowest ~~minimum~~ decision height **DH** specified in the **aircraft flight manual (Aeroplane Flight Manual (AFM))** or equivalent document, if stated. ~~;~~

~~2. whichever is higher.~~

Subpart E | Revised rule text

- (5) ~~Minimum Descent Height (MDH). An operator must ensure that the minimum descent height~~ **The minimum descent height (MDH) for an NPA approach operation is should not be lower than the highest of:**
- ~~a.(i) The OCH for the category of aeroplane aircraft; or~~
 - ~~b.(ii) The system minimum specified in Table 3; or~~
 - ~~c.(iii) The minimum minimum descent height MDH specified in the Aeroplane Flight Manual (AFM), if stated.~~

whichever is higher.

- ~~(6) Visual Reference. A pilot may not continue an approach below MDA/MDH unless at least one of the following visual references for the intended runway is distinctly visible and identifiable to the pilot:~~

Comment [WSI32]:
Moved to AMC1-CAT.OP.AH.300

- ~~(i) Elements of the approach light system;~~
- ~~(ii) The threshold;~~
- ~~(iii) The threshold markings;~~
- ~~(iv) The threshold lights;~~
- ~~(v) The threshold identification lights;~~
- ~~(vi) The visual glide slope indicator;~~
- ~~(vii) The touchdown zone or touchdown zone markings;~~
- ~~(viii) The touchdown zone lights;~~
- ~~(ix) Runway edge lights; or~~
- ~~(x) Other visual references accepted by the Authority.~~

Table 3: System minima vs facilities

Comment [WSI33]:
The table now also includes additional GNSS facilities.

Facility	Lowest DH/ MDH (ft)
ILS	200
GNSS/SBAS (LPV)	200
GNSS (LNAV)	250
GNSS/Baro-VNAV (LNAV/ VNAV)	250
LOC with or without DME	250 ft
SRA (terminating at 1/2 NM)	250 ft
SRA (terminating at 1 NM)	300 ft
SRA (terminating at 2 NM or more)	350 ft

Comment [WSI34]:
In accordance with PANS OPS criteria.

Subpart E | Revised rule text

RNAV / LNAV	300 ft
VOR	300 ft
VOR/DME	250 ft
NDB	350 ft
NDB/DME	300 ft
VDF	350 ft

DME: distance measuring equipment;

GNSS: global navigation satellite system;

ILS: instrument landing system;

LNAV: lateral navigation;

LOC: localiser;

SBAS: satellite-based augmentation system;

SRA: surveillance radar approach;

VDF: VHF direction finder;

VNAV: vertical navigation;

VOR: VHF omnidirectional radio range.

3.(c) Aeroplanes

The following criteria for establishing RVR/~~Converted Met Visibility~~ **CMV should apply:**~~(Ref Table 6)~~

a.~~(1)~~ In order to qualify for the lowest allowable values of RVR/**CMV** ~~detailed~~ **specified** in Table 6.A ~~(applicable to each approach grouping)~~ the instrument approach ~~shall~~ **should** meet at least the following facility requirements and associated conditions:

(i.) Instrument approaches with designated vertical profile up to and including 4.5° for Category A and B aeroplanes, or 3.77° for Category C and D aeroplanes, unless other approach angles are approved by the ~~Authority~~ **competent authority for a particular aircraft / runway combination**, where the facilities are:

(A.) **instrument landing system (ILS) / microwave landing system (MLS) / GBAS landing system (GLS) / precision approach radar (PAR);**~~ILS / MLS / GLS / PAR;~~ or

(B.) APV; and

where the final approach track is offset by not more than 15~~degrees~~° for Category A and B aeroplanes or by not more than 5~~degrees~~° for Category C and D aeroplanes.

(ii.) Instrument approach ~~operations~~ flown using the **continuous descent final approach (CDFA)** technique with a nominal vertical profile, up to and including 4.5° for Category A and B aeroplanes, or 3.77° for Category

Subpart E | Revised rule text

C and D aeroplanes, unless other approach angles are approved by the Authority, **competent authority for a particular aircraft / runway combination**, where the facilities are NDB, NDB/DME, VOR, VOR/DME, LOC, LOC/DME, VDF, SRA or **GNSS/LNAV/RNAV/LNAV**, with a final approach segment of at least 3 NM, which also fulfil the following criteria:

- (A.) ~~t~~The final approach track is offset by not more than ~~15-30~~**30** degrees° for Category A and B aeroplanes or by not more than ~~15~~**15** degrees° for Category C and D aeroplanes; and
- (B.) ~~t~~The **final approach fix (FAF)** or another appropriate fix where descent is initiated is available, or distance to **threshold (THR)** is available by **flight management system / area navigation (FMS/RNAV)** or DME; and
- (C.) ~~i~~f the **missed approach point (MAPt)** is determined by timing, the distance from FAF to THR is ≤ 8 NM.

- (iii.) Instrument approaches where the facilities are NDB, NDB/DME, VOR, VOR/DME, LOC, LOC/DME, VDF, SRA or **GNSS/LNAV/RNAV/LNAV**, not fulfilling the criteria in **3.a.paragraph (c)(1)(ii.)** above, or with an MDH ≥ 1 200 ft.

- b.(2)**The missed approach **operation**, after an approach **operation** has been flown using the CDFA technique, ~~shall~~**should** be executed when reaching the ~~decision altitude (height)~~**DH/A** or the MAPt, whichever occurs first. The lateral part of the missed approach procedure ~~must~~**should** be flown via the MAPt unless otherwise stated on the approach chart.

4.(d) Aeroplanes

~~Determination of~~ **The RVR/-CMV/-VIS** Visibility minima for Category **CAT I**, APV and **NPAN** Non-Precision Approach operations **should be determined as follows:**

- a(1.)**The minimum RVR/-CMV/-**VIS** Visibility ~~shall~~**should** be the highest of the values ~~derived~~**specified from** in Table 5 or Table 6.**A** but not greater than the maximum values ~~shown~~**specified** in Table 6.**A**, where applicable.

- b(2.)**The values in Table 5 ~~are~~**should be** derived from the formula below,-

Required RVR/**VIS** Visibility (m) = [(DH/MDH (ft) × 0.3048) / tan α] - length of approach lights (m)

~~Note 1: where~~ α is the calculation angle, being a default value of 3.00 degrees° increasing in steps of **0.10° for each line in Table 5 up to 3.77° and then remains constant.**

- c(4.)**If the approach is flown with a level flight segment at or above MDA/H, 200 ~~metres~~**m** ~~shall~~**should** be added for Category A and B aeroplanes and 400 metres for Category C and D aeroplanes to the minimum RVR/-CMV/**VIS** value resulting from the application of Tables 5 and 6.

~~d~~**Note:** The added value corresponds to the time/distance required to establish the aeroplane on the final descent.

- (5.)** An RVR of less than 750 metres as indicated in Table 5 may be used:

- (i.) for Category **ICAT I** approach operations to runways with **full approach light system (FALS)** ~~(see below)~~, **r**Runway **t**Touchdown **z**Zone **l**Lights

Subpart E | Revised rule text

(RTZL) and ~~r~~Runway ~~c~~Centreline ~~I~~Lights (RCLL) ~~provided that the DH is not more than 200 ft; or~~

(ii.) for ~~Category I~~**CAT I** approach operations to runways without RTZL and RCLL when using an approved **head-up display landing system (HUDLS)**, or equivalent approved system, or when conducting a coupled approach or flight-director-flown approach to a DH ~~equal to or greater than 200 ft~~. The ILS ~~must~~**should** not be ~~promulgated~~**published** as a restricted facility; or

(iii.) for APV approach operations to runways with FALS, RTZL and RCLL when using an approved HUD.

~~e(6).~~ The Authority may approve RVR values lower **Lower values** than those given **specified** in Table 5, for HUDLS and auto-land ~~auto-land~~ operations **may be used if approved in accordance with SPA.LVO.** ~~in accordance with paragraph (e) of this Appendix.~~

~~f.(7)~~ The visual aids **should** comprise standard runway day markings and approach and runway lighting ~~lights (runway edge lights, threshold lights, runway end lights and in some cases also touch down zone and/or runway centre line lights).~~ **as specified** ~~The approach light configurations acceptable are classified and listed in Table 4 below.~~

Comment [WSI35]:
Deleted because this sentence has the nature of a note.

~~(8)~~ Notwithstanding the requirements in paragraph (d)(7) above, ~~t~~The **competent** authority may approve that RVR values relevant to a ~~Basic Approach Lighting System (BALs)~~ are used on runways where the approach lights are restricted in length below 210 m due to terrain or water, but where at least one cross-bar is available.

~~g.(9)~~ For night operations or for any operation where credit for runway and approach lights is required, the lights ~~must~~**should** be on and serviceable except as provided for in ~~Table 6a~~**Table 7**.

~~h.~~ **For single-pilot operations, the minimum RVR/VIS should be calculated in accordance with the following additional criteria:**

Comment [WSI36]:
Text moved up from below.

i. **an RVR of less than 800 m as indicated in Table 5 may be used for CAT I approaches provided any of the following is used at least down to the applicable DH:**

A. **a suitable autopilot, coupled to an ILS, MLS or GLS that is not published as restricted; or**

B. **an approved HUDLS, including, where appropriate, EVS, or equivalent approved system;**

ii. **where RTZL and/or RCLL are not available, the minimum RVR/CMV should not be less than 600 m; and**

iii. **an RVR of less than 800 m as indicated in Table 5 may be used for APV operations to runways with FALS, RTZL and RCLL when using an approved HUDLS, or equivalent approved system, or when conducting a coupled approach to a DH equal to or greater than 250 ft.**

Subpart E | Revised rule text

Table 4: Approach light systems

OPS-CE Class of lighting Facility	Length, configuration and intensity of approach lights
FALS (Full Approach Light System)	ICAO: Precision Approach CAT I Lighting System (HIALS 720 m ≥) dDistance cCoded cCentreline, BBarrette cCentreline
IALS (Intermediate Approach Light System)	ICAO: Simple aApproach Lighting System (HIALS 420 -- 719 m) sSingle sSource, Barrette
BALS (Basic Approach Light System)	Any other aApproach Lighting System (HIALS, MIALS or ALS 210-419 m)
NALS (No Approach Light System)	Any other aApproach Lighting System (HIALS, MIALS or ALS <210 m) or nNo aApproach Lights

Comment [WS137]:
Deleted because ICAO requires 900 m (Annex 14 5.3.4.10).

Note: HIALS: high intensity approach light system;
MIALS: medium intensity approach light system.

Table 5: RVR/-/CMV (See Table 11) vs. DH/-/MDH

DH or MDH			Class of Lighting Facility			
			FALS	IALS	BALS	NALS
			See 4.d., e., h. para (d)(5), (d)(6) and (d)(10) above about RVR <<750/800 m			
Rft			RVR/CMV (Metresm)			
200	-	210	550	750	1 000	1 200
211	-	220	550	800	1 000	1 200
221	-	230	550	800	1 000	1 200
231	-	240	550	800	1 000	1 200
241	-	250	550	800	1 000	1 300
251	-	260	600	800	1 100	1 300
261	-	280	600	900	1 100	1 300
281	-	300	650	900	1 200	1 400
301	-	320	700	1 000	1 200	1 400
321	-	340	800	1 100	1 300	1 500
341	-	360	900	1 200	1 400	1 600

Subpart E | Revised rule text

DH or MDH			Class of Lighting Facility			
			FALS	IALS	BALS	NALS
			See 4.d., e., h. para (d)(5), (d)(6) and (d)(10) above about RVR <<750/800 m			
Ftft			RVR/CMV (Metresm)			
361	-	380	1 000	1 300	1 500	1 700
381	-	400	1 100	1 400	1 600	1 800
401	-	420	1 200	1 500	1 700	1 900
421	-	440	1 300	1 600	1 800	2 000
441	-	460	1 400	1 700	1 900	2 100
461	-	480	1 500	1 800	2 000	2 200
481		500	1 500	1 800	2 100	2 300
501	-	520	1 600	1 900	2 100	2 400
521	-	540	1 700	2 000	2 200	2 400
541	-	560	1 800	2 100	2 300	2 500
561	-	580	1 900	2 200	2 400	2 600
581	-	600	2 000	2 300	2 500	2 700
601	-	620	2 100	2 400	2 600	2 800
621	-	640	2 200	2 500	2 700	2 900
641	-	660	2 300	2 600	2 800	3 000
661	-	680	2 400	2 700	2 900	3 100
681	-	700	2 500	2 800	3 000	3 200
701	-	720	2 600	2 900	3 100	3 300
721	-	740	2 700	3 000	3 200	3 400
741	-	760	2 700	3 000	3 300	3 500
761	-	800	2 900	3 200	3 400	3 600
801	-	850	3 100	3 400	3 600	3 800

Subpart E | Revised rule text

DH or MDH			Class of Lighting Facility			
			FALS	IALS	BALS	NALS
			See 4.d., e., h. para (d)(5), (d)(6) and (d)(10) above about RVR <<750/800 m			
Ftft			RVR/CMV (Metresm)			
851	-	900	3 300	3 600	3 800	4 000
901	-	950	3 600	3 900	4 100	4 300
951	-	1 000	3 800	4 100	4 300	4 500
1 001	-	1 100	4 100	4 400	4 600	4 900
1 101	-	1 200	4 600	4 900	5 000	5 000
1 201 and above			5 000	5 000	5 000	5 000

Table 6.A: CAT I, APV, NPA - aeroplanes
Minimum and mMaximum applicable RVR-/CMV Converted Met visibility (See Table 11) for all instrument approaches down to CAT I Minima (Lower and uUpper cut-off limits):

Facility/cConditions	RVR-/CMV (m)	Aeroplane category			
		A	B	C	D
ILS, MLS, GLS, PAR, GNSS/SBAS, GNSS/VNAV and APV	Min	According to Table 5			
	Max	1 500	1 500	2 400	2 400
NDB, NDB/DME, VOR, VOR/DME, LOC, LOC/DME, VDF, SRA, RNAV/LNAV GNSS/LNAV -with a procedure which that fulfils the criteria in paragraph (e)(1)(3.a.ii):	Min	750	750	750	750
	Max	1 500	1 500	2 400	2 400
For NDB, NDB/DME, VOR, VOR/DME, LOC, LOC/DME, VDF, SRA, RNAV GNSS/LNAV : - not fulfilling the criteria in paragraph (e)(1)(3.a.ii) above , or - with a DH or MDH \geq -1 200 ft	Min	1 000	1 000	1 200	1 200
	Max	According to Table 5 if flown using the CDFA technique, otherwise an add-on of 200/400 m-m applies to the values in Table 5 but not to result in a value exceeding 5 000 -m.			

Subpart E | Revised rule text

~~(10) Single pilot operations. For single pilot operations, an operator must calculate the minimum RVR/visibility for all approaches in accordance with OPS 1.430 and this Appendix.~~

Comment [WSI38]:
Text moved up right after (9).

- ~~(i) An RVR of less than 800 metres as indicated in Table 5 may be used for Category I approaches provided any of the following is used at least down to the applicable DH:~~
 - ~~(A) a suitable autopilot, coupled to an ILS or MLS which is not promulgated as restricted; or~~
 - ~~(B) an approved HUDLS (including, where appropriate, EVS), or equivalent approved system.~~
- ~~(ii) Where RTZL and/or RCLL are not available, the minimum RVR/CMV shall not be less than 600 m.~~
- ~~(iii) An RVR of less than 800 metres as indicated in Table 5 may be used for APV operations to runways with FALS, RTZL and RCLL when using an approved HUDLS, or equivalent approved system, or when conducting a coupled approach to a DH equal to or greater than 250 ft.~~

5. Helicopters

The RVR/CMV/VIS minima for NPA, APV and CAT I operations should be determined as follows:

- a. ~~For non-precision approaches~~ **NPA operations** ~~by helicopters operated in performance class 1 (PC1) or performance class 2 (PC2), the minima given~~ **specified** in Table ~~56.1.H~~ should apply:
 - i. ~~Where the missed approach point is within ½ nm~~ **NM** of the landing threshold, the approach minima ~~given~~ **specified** for full facilities may be used regardless of the length of approach ~~lighting~~ **lights** available. However, FATO/runway edge lights, threshold lights, end lights and FATO/runway markings are still required;
 - ii. ~~For night operations, ground lighting~~ **lights must** ~~should~~ be available to illuminate the FATO/runway and any obstacles; **and**
 - iii. ~~For single-pilot operations, the minimum RVR is 800 m or the minima in Table 66.2.H, whichever is higher.~~
- b. ~~For CAT I approaches~~ **operations** ~~by helicopters operated in PC1 or PC2, the minima given~~ **specified** in Table ~~6.2.H~~ should apply:
 - i. ~~For night operations, ground lighting~~ **light must** ~~should~~ be available to illuminate the FATO/runway and any obstacles;
 - ii. ~~For single-pilot operations, the minimum RVR/VIS should be calculated in accordance with the following additional criteria: the minimum RVR should be calculated based on CAT.OP.110 and its AMC material.~~
 - A. a** ~~An RVR of less than 800 m should not be used except when using a suitable autopilot coupled to an ILS, or MLS or GLS, in which case normal minima apply;~~ **and**

Subpart E | Revised rule text

- B. The DH applied should not be less than 1.25 times the minimum use height for the autopilot.

Table 56.1.H Onshore ~~non-precision approach-NPA~~ minima

MDH (ft) *	Facilities/RVR (m) **, ***, ****			
	Full (Note 1)	Intermediate (Note 2)	Basic (Note 3)	Nil (Note 4)
250 - 299	600	800	1 000	1 000
300 - 449	800	1 000	1 000	1 000
450 and above	1 000	1 000	1 000	1 000

*: **The MDH refers to the initial calculation of MDH. When selecting the associated RVR, there is no need to take account of a rounding up to the nearest ten ft, which may be done for operational purposes, e.g. conversion to MDA.**

~~Note 1: Full facilities comprise FATO/runway markings, 720 m or more of HI/MI approach lights, FATO/runway edge lights, threshold lights and FATO/runway end lights. Lights must be on.~~

~~Note 2: Intermediate facilities comprise FATO/runway markings, 420 - 719 m of HI/MI approach lights, FATO/runway edge lights, threshold lights and FATO/runway end lights. Lights must be on.~~

~~Note 3: Basic facilities comprise FATO/runway markings, <420 m of HI/MI approach lights, any length of LI approach lights, FATO/runway edge lights, threshold lights and FATO/runway end lights. Lights must be on.~~

~~Note 4: Nil approach light facilities comprise FATO/runway markings, FATO/runway edge lights, threshold lights, FATO/runway end lights or no lights at all.~~

~~Note 5*: The tables are only applicable to conventional approaches with a nominal descent slope of not greater than 4 degrees°. Greater descent slopes will usually require that visual glide slope guidance (e.g. **precision path approach indicator (PAPI)**) is also visible at the MDH.~~

~~Note 6***: The above figures are either reported RVR or CMV.~~

~~Note 7: The MDH mentioned in Table 6.A refers to the initial calculation of MDH. When selecting the associated RVR, there is no need to take account of a rounding up to the nearest ten feet, which may be done for operational purposes, e.g.~~

conversion to MDA.*: Full facilities comprise FATO/runway markings, 720 m or more of high intensity / medium intensity (HI/MI) approach lights, FATO/runway edge lights, threshold lights and FATO/runway end lights. Lights to be on.**

Intermediate facilities comprise FATO/runway markings, 420 - 719 m of HI/MI approach lights, FATO/runway edge lights, threshold lights and FATO/runway end lights. Lights to be on.

Basic facilities comprise FATO/runway markings, <420 m of HI/MI approach lights, any length of LI approach lights, FATO/runway edge lights, threshold lights and FATO/runway end lights. Lights to be on.

Subpart E | Revised rule text

Nil approach light facilities comprise FATO/runway markings, FATO/runway edge lights, threshold lights, FATO/runway end lights or no lights at all.

Table 6.2.H Onshore precision approach minima — Category ICAT I minima

MDH (ft) *	Facilities/RVR (m) **, ***, ****			
	Full (Note 1)	Intermediate (Note 2)	Basic (Note 3)	Nil (Note 4)
200	500	600	700	1 000
201 – 250	550	650	750	1 000
251 – 300	600	700	800	1 000
301 and above	750	800	900	1 000

***:** The MDH refers to the initial calculation of MDH. When selecting the associated RVR, there is no need to take account of a rounding up to the nearest ten ft, which may be done for operational purposes, e.g. conversion to DA.

****:** The above figures are either the reported RVR or CMV.

*****:** The table is applicable to conventional approaches with a glide slope up to and including 4°.

~~Note 1****:~~ Full facilities comprise FATO/runway markings, 720 m or more of HI/MI approach lights, FATO/runway edge lights, threshold lights and FATO/runway end lights. Lights ~~must to~~ be on.

~~Note 2:~~ Intermediate facilities comprise FATO/runway markings, 420 - 719 m of HI/MI approach lights, FATO/runway edge lights, threshold lights and FATO/runway end lights. Lights ~~must to~~ be on.

~~Note 3:~~ Basic facilities comprise FATO/runway markings, <420 m of HI/MI approach lights, any length of LI approach lights, FATO/runway edge lights, threshold lights and FATO/runway end lights. Lights ~~must to~~ be on.

~~Note 4:~~ Nil approach light facilities comprise FATO/runway markings, FATO/runway edge lights, threshold lights, FATO/runway end lights or no lights at all.

~~Note 5:~~ The above figures are either the reported RVR or CMV.

~~Note 6:~~ The table is applicable to conventional approaches with a glide slope up to and including 4 degrees.

~~Note 7:~~ The MDH mentioned in Table 7.H refers to the initial calculation of MDH. When selecting the associated RVR, there is no need to take account of a rounding up to the nearest ten feet, which may be done for operational purposes, e.g. conversion to DA. AMC OPS 1.430(b)(4)

Failed or downgraded ground equipment Effect on Landing Minima of temporarily failed or downgraded Ground Equipment

See JAR OPS 1.430(b)(4)

Subpart E | Revised rule text

1. Introduction

~~1.1 This AMC provides operators with instructions for flight crews on the effects on landing minima of temporary failures or downgrading of ground equipment.~~

~~1.2 Aerodrome facilities are expected to be installed and maintained to the standards prescribed in~~

~~1. ICAO Annexes 10 and 14. Any deficiencies are expected to be repaired without unnecessary delay.~~

2. General:

These instructions are intended for use both pre-flight and in-flight. It is **however** not expected ~~however~~ that the commander would consult such instructions after passing ~~the outer marker or equivalent position~~ **1 000 ft above the aerodrome**. If failures of ground aids are announced at such a late stage, the approach could be continued at the commander's discretion. If, ~~however~~, failures are announced before such a late stage in the approach, their effect on the approach should be considered as described in ~~Tables 1A and 1B below~~ **Table 7**, and the approach may have to be abandoned ~~to allow this to happen~~.

~~3. Operations with no Decision Height (DH)~~
~~3.1 An operator should ensure that, for aeroplanes authorised to conduct no-DH operations with the lowest RVR limitations, the following applies in addition to the content of Tables 1A and 1B, below:~~

~~i. RVR. At least one RVR value must be available at the aerodrome;~~

~~ii. Runway lights~~

~~a. No runway edge lights, or no centre lights — Day — RVR 200 m; Night — Not allowed;~~

~~b. No TDZ lights — No restrictions;~~

~~c. No standby power to runway lights — Day — RVR 200 m; Night — not allowed.~~

~~2.4. Conditions applicable to Tables ~~71A & 1B~~:~~

~~a.i. Multiple failures of runway/~~FATO~~ lights other than indicated in Table ~~71B~~ are ~~should~~ not ~~be~~ acceptable;~~

~~b.ii. Deficiencies of approach and runway/~~FATO~~ lights are treated separately; and~~

~~iii. Category II or III operations. A combination of deficiencies in runway lights and RVR assessment equipment is not allowed.~~

~~c.iv. Failures other than ILS, **MLS** affect RVR only and not DH.~~

Subpart E | Revised rule text

Table 7: -Failed or downgraded equipment – effect on landing minima: Operations without a low visibility operations (LVO) approval

Comment [WSI39]:
Table split into a CAT.OP and SPA version.

Table modified with contributions of a commenter which harmonises the rules with FAA rules.

Failed or downgraded equipment (Note 1)	Effect on landing minima				
	CAT-III B (Note 2)	CAT-III A	CAT-II	CAT-I	Non precision
ILS stand by transmitter	Not allowed		No effect		
Outer Marker	No effect if replaced by published equivalent position				Not applicable
Middle marker	No effect				No effect unless used as MAPT
Touchdown Zone RVR assessment system	May be temporarily replaced with midpoint RVR if approved by the State of the aerodrome. RVR may be reported by human observation			No effect	
Midpoint or stopend RVR	No effect				
Anemometer for runway in use	No effect if other ground source available				
Celiometer	No effect				
Approach lights	Not allowed for operations with DH > 50ft		Not allowed	Minima as for nil facilities	
Approach lights except the last 210 m	No effect		Not allowed	Minima as for nil facilities	
Approach lights except the last 420 m	No effect			Minima as for intermediate facilities	
Standby power for approach lights	No effect			No effect	
Whole runway light system	Not allowed			Day — Minima as for nil facilities Night — Not allowed	
Edge lights	Day only; Night — not allowed				
Centreline lights	Day — RVR 300m Night — not allowed		Day — RVR 300m Night — 550m	No effect	
Centreline lights	RVR 150m	No effect			

Subpart E | Revised rule text

spacing increased to 30 m			
Touchdown zone lights	Day — RVR 200m Night — 300m	Day — RVR 300m Night — 550m	No effect
Standby power for runway lights	Not allowed		No effect
Taxiway light system	No effect — except delays due to reduced movement rate		

Note 1: — Conditions applicable to Table 6a:

(a) — Multiple failures of runway lights other than indicated in Table 6a are not acceptable.

(b) — Deficiencies of approach and runway lights are treated separately.

(c) — Category II or III operations. A combination of deficiencies in runway lights and RVR assessment equipment is not allowed.

(d) — Failures other than ILS affect RVR only and not DH.

Note 2: — For CAT IIIB operations with no DH, an operator shall ensure that, for aeroplanes authorised to conduct no DH operations with the lowest RVR limitations, the following applies in addition to the content of Table 6a:

(a) — RVR. At least one RVR value must be available at the aerodrome;

(b) — Runway lights

(i) — No runway edge lights, or no centre lights — Day — RVR 200 m; Night — Not allowed;

(ii) — No TDZ lights — No restrictions;

(iii) — No standby power to runway lights — Day — RVR 200 m; Night — Not allowed.

Failed or downgraded equipment	Effect on landing minima	
	CAT I	APV, NPA
ILS/MLS stand-by transmitter	No effect	
Outer Marker	Not allowed except if replaced by equivalent position	APV – not applicable
		NPA with FAF: no effect unless used as FAF
		If the FAF cannot be identified (e.g. no method available for timing of descent), non-precision operations cannot be conducted
Middle marker	No effect	No effect unless used as MAPt

Subpart E | Revised rule text

Failed or downgraded equipment	Effect on landing minima	
	CAT I	APV, NPA
RVR Assessment Systems	No effect	
Approach lights	Minima as for NALS	
Approach lights except the last 210 m	Minima as for BALS	
Approach lights except the last 420 m	Minima as for IALS	
Standby power for approach lights	No effect	
Edge lights, threshold lights and runway end lights	Day - no effect; Night – Not allowed	
Centreline lights	No effect if F/D, HUDLS or auto-land otherwise RVR 750 m	No effect
Centreline lights spacing increased to 30 m	No effect	
Touchdown zone lights	No effect if F/D, HUDLS or auto-land; otherwise RVR 750 m	No effect
Taxiway light system	No effect	

[12]Part-SPA

Subpart E – Low visibility operations (LVO)

AMC1-SPA.LVO.100 Low visibility operations

FAILED OR DOWNGRADED EQUIPMENT

1. General

Subpart E | Revised rule text

These instructions are intended for use both pre-flight and in-flight. It is however not expected that the pilot-in-command/commander would consult such instructions after passing 1 000 ft above the aerodrome. If failures of ground aids are announced at such a late stage, the approach could be continued at the pilot-in-command/commander's discretion. If failures are announced before such a late stage in the approach, their effect on the approach should be considered as described in Table 6, and the approach may have to be abandoned.

2. Conditions applicable to the tables below:

- a. multiple failures of runway/FATO lights other than indicated in Table 6 should not be acceptable;
- b. deficiencies of approach and runway/FATO lights are treated separately;
- c. CAT II or CAT III operations. A combination of deficiencies in runway/FATO lights and RVR assessment equipment should not be permitted; and
- d. failures other than ILS, MLS affect RVR only and not DH.

**Table 6: Failed or downgraded equipment – effect on landing minima
Operations with an LVO approval**

Failed or downgraded equipment	Effect on landing minima			
	CAT IIIIB (no DH)	CAT IIIIB	CAT IIIA	CAT II
ILS/MLS stand-by transmitter	Not allowed	RVR 200 m	No effect	
Outer marker	Not allowed except if replaced by equivalent position			
Middle marker		No effect		
RVR assessment systems	At least one RVR value to be available on the aerodrome	On runways equipped with 2 or more RVR assessment units, one may be inoperative		
Approach lights	No effect	Not allowed for operations with DH >50 ft		Not allowed
Approach lights except the last 210 m	No effect			Not allowed
Approach lights except the last 420 m	No effect			

Subpart E | Revised rule text

Failed or downgraded equipment	Effect on landing minima			
	CAT IIIB (no DH)	CAT IIIB	CAT IIIA	CAT II
Standby power for approach lights	No effect			
Edge lights, threshold lights and runway end lights	No effect		Day - no effect	Day - no effect
			Night - min RVR 550 m	Night - not allowed
Centreline lights	Day - RVR 200 m	Not allowed	Day -RVR 300 m	Day -RVR 350 m
	Night - not allowed		Night - RVR 400 m	Night - RVR 550 m (400 m with HUDLS or auto-land)
Centreline lights spacing increased to 30 m	RVR 150 m		No effect	
Touchdown zone lights	No effect	Day - RVR 200 m	Day - RVR 300 m	
		Night - RVR 300 m	Night - RVR 550 m;	
			350 m with HUDLS or auto-land	
Taxiway light system	No effect			

AMC1-SPA.LVO.100 Low visibility operations**LTS CAT I OPERATIONS**

1.(e) For Lower than Standard Category I (LTS CAT I) Operations operations the following standards should apply:

- a.(1) Decision Height: The decision height (DH) of an A-Lower than Standard Category I LTS CAT I Operation operation decision height must should not be lower than the highest of:**

Subpart E | Revised rule text

- (i.) ~~t~~The minimum ~~decision height~~ **DH** specified in the **aircraft flight manual (AFM)**, if stated; ~~or~~
- (ii.) ~~t~~The minimum height to which the precision approach aid can be used without the required visual reference; ~~or~~
- (iii.) ~~t~~The **applicable obstacle clearance height (OCH)** for the category of aeroplane; ~~or~~
- (iv.) ~~t~~The ~~decision height~~ **DH** to which the flight crew is ~~authorised~~ **qualified** to operate; or
- (v.) 200 ft.

~~b~~whichever is higher.

(2). ~~Type of facility.~~ An **instrument landing system / microwave landing system (ILS-/MLS)** which supports an ~~Lower than Standard Category~~ **ILTS CAT I** operation ~~must~~ **should** be an unrestricted facility with a straight-in course, ($\leq 3^\circ$ offset), and the ILS ~~must~~ **should** be certified ~~rated~~ to:

- (i.) ~~E~~class I/T/1 for operations to a minimum of 450 m RVR; or
- (ii.) ~~E~~class II/D/2 for operations to less than 450 m RVR.

Single ILS facilities are only acceptable if Level 2 performance is provided.

~~c.(3) Required RVR/CMV.~~ The lowest **RVR/CMV** minima to be used by an operator ~~the operator~~ for ~~Lower than Standard Category~~ **ILTS CAT I** operations are ~~stipulated~~ **specified** in ~~Table 6b~~ **Table 1.** below:

~~Table 6b~~ **Table 1: Lower than Standard Category ILTS CAT I operation minima**
RVR/CMV vs. a Approach Light sSystem

DH (ft)	Class of light facility *			
	FALS	IALS	BALS	NALS
	RVR/CMV (m)			
200 - 210	400	500	600	750
211 - 220	450	550	650	800
221 - 230	500	600	700	900
231 - 240	500	650	750	1 000
241 - 249	550	700	800	1 100

~~Note* 1:~~ The visual aids comprise standard runway day markings, approach ~~lighting~~ **lights**, runway edge lights, threshold lights, runway end lights and, for operations below 450 m, ~~shall~~ **should** include touch-down zone and/or runway ~~centre line~~ **centreline** lights.

FALS: full approach landing system
IALS: intermediate approach landing system

Subpart E | Revised rule text

BALS: basic approach lighting system**NALS: no approach light system**

~~(4) Visual reference. A pilot shall not continue an approach below decision height unless visual reference containing a segment of at least 3 consecutive lights being the centre line of the approach lights, or touchdown zone lights, or runway centre line lights, or runway edge lights, or a combination of these is attained and can be maintained. This visual reference must include a lateral element of the ground pattern, i.e. an approach lighting crossbar or the landing threshold or a barrette of the touchdown zone lighting unless the operation is conducted utilising an approved HUDLS usable to at least 150ft.~~

Comment [WSI40]:
Moved to AMC1-CAT.OP.AH.300.

~~(5) Approval.~~

Comment [WSI41]:
upgraded to SPA.LVO.110.

~~To conduct Lower than Standard Category I operations:~~

- ~~(i) The approach shall be flown auto coupled to an auto land; or an approved HUDLS shall be used to at least 150ft above the threshold.~~
- ~~(ii) The aeroplane shall be certificated in accordance with CS AWO to conduct Category II operations;~~
- ~~(iii) The auto land system shall be approved for Category IIIA operations;~~
- ~~(iv) In service proving requirements shall be completed in accordance with Appendix 1 to OPS 1.440 paragraph (h);~~
- ~~(v) Training specified in Appendix 1 to OPS 1.450 paragraph (h) shall be completed, this shall include training and checking in a Flight Simulator using the appropriate ground and visual aids at the lowest applicable RVR;~~
- ~~(vi) The Operator must ensure that Low Visibility procedures are established and in operation at the intended aerodrome of landing; and~~
- ~~(vii) The Operator shall be approved by the Authority.~~

[03]Annex I - Definitions for terms used in Annexes II - VI

...

~~(f) Precision approach — Category II and other than Standard Category II Operations~~

~~(1) General.~~

~~(xxi) A Category II (**CAT II**) operation— **means** is a precision instrument approach and landing **operation** using ILS or MLS with:~~

~~(1A) A **DH** decision height below 200 ft but not lower than 100 ft; and~~

~~(2B) A runway visual range **RVR** of not less than 300 m.~~

~~(xxii) An **Other than Standard Category II** **CAT II (OTS CAT II)** operation— **means** is a precision instrument approach and landing **operation** using ILS or MLS **where some or all of the elements of the ICAO Annex 14 precision approach category II light system are not available, and** which meets facility requirements as established in paragraph (iii) below with:~~

Subpart E | Revised rule text

~~(A1) A decision height—DH below 200 ft but not lower than 100 ft; (See Table 7b below) and~~

~~(2B) A runway visual range—RVR of not less than 350/400 m. (See Table 7b below)~~

...

[13]Part-SPA

Subpart E – Low visibility operations – AMC/GM

AMC1-SPA.LVO.100 Low visibility operations

...

CAT II AND OTS CAT II OPERATIONS

1. For CAT II and other than Standard Category II (OTS CAT II) operations the following facility standards should apply.

~~a.(iii)~~ The ILS / MLS that supports other than a Standard ~~OTS Category II~~ **CAT II** operation ~~shall~~ **should** be an unrestricted facility with a straight in course ($\leq 3^\circ$ offset) and the ILS ~~shall~~ **should** be certified ~~ated to-~~:

~~(A)~~ Class I/T/1 for operations down to 450m RVR and to a DH of 200 ft or more; ~~or,~~

~~(B)~~ Class II/D/2 for operations in RVRs of less than 450m or to a DH of less than 200ft.

Single ILS facilities are only acceptable if Level 2 performance is provided.

~~b.(2)~~ Decision Height. ~~An~~ **The operator must—should** ensure that the decision—**DH** height ~~for ÷~~

~~(i)~~ **CAT II and** Other than Standard Category II ~~OTS CAT II and Category II~~ operation is not lower than **the highest of:**

~~(Ai.)~~ ~~t~~The minimum decision height—**DH** specified in the AFM, if stated; ~~or~~

~~(Bii.)~~ ~~t~~The minimum height to which the precision approach aid can be used without the required visual reference; ~~or~~

~~(Ciii.)~~ ~~t~~The **applicable** OCH for the category of aeroplane; ~~or~~

~~(Div.)~~ ~~t~~The decision height—**DH** to which the flight crew is ~~authorised~~ **qualified** to operate; or

~~(Ev.)~~ 100 ft.

~~c~~whichever is higher.

~~(3)~~ Visual reference. A pilot may not continue an approach below either the Category II or the other than Standard Category II decision height determined in accordance with sub paragraph (d)(2) above unless visual reference containing a segment of at least 3 consecutive lights being the centre line of the approach lights, or touchdown zone lights, or runway centre line lights, or

Comment [WSI42]:
Known error rectified.

Comment [WSI43]:
Moved to AMC.CAT.OP.AH.300.

Subpart E | Revised rule text

runway edge lights, or a combination of these is attained and can be maintained. This visual reference must include a lateral element of the ground pattern, i.e. an approach lighting crossbar or the landing threshold or a barrette of the touchdown zone lighting unless the operation is conducted utilising an approved HUDLS to touchdown.

- (4). **The operator should use the following RVR minima:**
 - (i) Required RVR.
 - i. The lowest minima to be used by an operator for Category II operations areas specified in Table 2; and
 - ii. for OTS CAT II operations as specified in Table 3.
 - d. For OTS CAT II operations, the operator should verify that the terrain ahead of the runway threshold has been surveyed.

Comment [WSI44]:
moved up from below.

Comment [WSI45]:
Added to account any safety risk for applying a radio altimeter.

Table 2: CAT II operation minima - aeroplanes RVR for Cat II Operations vs. DH

Category II minima

DH (ft)	Auto-coupled / Approved HUDLS to below DH * (Note 1a)	
	Aeroplane Categories -A, B, & C RVR (m)	Aeroplane Category D RVR (m)
100 - 120	300m	300/350 **m (Note 2a)
121 - 140	400m	400m
141 and above 199	450m	450m

Note 1*a: The reference to 'auto-coupled to below DH / Approved HUDLS' in this table means **Continued** use of the automatic flight control system or the HUDLS down to a height of 80% of the DH. Thus **airworthiness** requirements may, through minimum engagement height for the automatic flight control system, affect the DH to be applied.

Note 2*a: 300 m may be used for a Category D aeroplane conducting an **auto-land**.

- (ii) Required RVR. The lowest minima to be used by an operator for other than Standard Category II operations are:

Comment [WSI46]:
Moved up.

Table 3: Other than Standard Category II OTS CAT II operation minima - aeroplanes RVR vs. Approach Light System

Other than Standard Category II Minima

Subpart E | Revised rule text

Auto-land or a Approved HUDLS utilised to touchdown					
Class of Lighting Facility *					
FALS		IALS	BALS	NALS	
Categories A – C	Category D	Categories A – D	Categories A – D	Categories A - D	
DH (ft)	RVR (m)Metres				
100 - 120	350	400	450	600	700
121 - 140	400	450	500	600	700
141 - 160	450	500	500	600	750
161 - 199	450	500	550	650	750

Comment [WSI47]:
 Changed due to inconsistency with values LTS cat I and OTS cat II.

Comment [WSI48]:
 Changed due to inconsistency with values LTS cat I and OTS cat II.

Note*: The visual aids required to conduct Other than Standard Category II **OTS CAT II** operations comprise standard runway day markings and approach and runway lighting lights as specified in Table 1 for **LTS CAT I:** {runway edge lights, threshold lights, runway end lights}.

For operations below 450 m, they should include touch-down zone and/or runway centreline lights.

For operations in RVR of 400 m or less, they should include centreline lights.

For operations in RVR of 400 m or less, centre line lights must be available. The approach light configurations are classified and listed in Table 4 above.

(iii) To conduct other than Standard Category II operations the operator must ensure that appropriate Low Visibility procedures are established and in operation at the intended aerodrome of landing.

Comment [WSI49]:
 Already covered in SPA.LVO.115 (b).

(g) Precision approach Category III operations

(1) General. Category III operations are subdivided as follows:

Subpart E | Revised rule text

[04]Annex I - Definitions for terms used in Annexes II - VI

...

(~~ix~~) ~~Category III~~**CAT III**-A operation **means** ~~s. A-a~~ a precision instrument approach and landing **operation** using ILS or MLS with:

(~~A1~~) ~~A decision height-DH~~ lower than 100 ft; and

(~~B2~~) ~~A runway visual range-RVR~~ not less than 200 m.

(~~ix~~) ~~Category III~~**CAT III**-B operations ~~s. A~~ **means a** precision instrument approach and landing **operation** using ILS or MLS with:

(~~A1~~) ~~A decision height-DH~~ lower than 100 ft, or no ~~decision height~~**DH**; and

(~~B2~~) ~~A runway visual range-RVR~~ lower than 200 m but not less than 75 m.

...

Subpart E | Revised rule text

[14]Part-SPA

Subpart E – Low visibility operations – AMC/GM

AMC1-SPA.LVO.100 Low visibility operations

...

CAT III OPERATIONS

1. The following standards should apply to CAT III operations:

- a. ~~Note:—Where the decision height (DH) and runway visual range (RVR) do not fall within the same Category, the RVR will determine in which Category the operation is to be considered.~~
- b.(2) ~~Decision Height.—For operations in which a decision height—DH is used, an operator—the must ensure that the decision height—DH should is not be lower than:~~
- (i.) ~~tThe minimum decision height—DH specified in the AFM, if stated; or~~
 - (ii.) ~~tThe minimum height to which the precision approach aid can be used without the required visual reference; or~~
 - (iii.) ~~tThe decision height—DH to which the flight crew is authorised—qualified to operate.~~
- c.(3) ~~No Decision Height Operations.—Operations with no decision height—DH may should only be conducted if:~~
- (i.) ~~tThe operation with no decision height—DH is authorised—specified in the AFM; and~~
 - (ii.) ~~tThe approach aid and the aerodrome facilities can support operations with no decision height—DH; and~~
 - (iii.) ~~tThe operator—the operator has an approval for CAT III operations with no decision height—DH, and | Note:| In the case of a CAT III runway it may be assumed that operations with no decision height can be supported unless specifically restricted as published in the AIP or NOTAM.~~
- (4) ~~Visual reference~~
- (i) ~~For Category IIIA operations, and for Category IIIB operations conducted either with fail passive flight control systems, or with the use of an approved HUDLS, a pilot may not continue an approach below the decision height determined in accordance with sub paragraph (g)(2) above unless a visual reference containing a segment of at least 3 consecutive lights being the centreline of the approach lights, or touchdown zone lights, or runway centreline lights, or runway edge lightsd., or a combination of these is attained and can be maintained.~~
 - (ii) ~~For Category IIIB operations conducted either with fail operational flight control systems or with a fail operational hybrid landing system (comprising e.g. a HUDLS) using a decision height a pilot may not continue an approach below the Decision Height, determined in~~

Comment [WSI50]:
Deleted because the text has the nature of a GM.

Comment [WSI51]:
Moved to AMC1-OPS.CAT.300.

Subpart E | Revised rule text

~~accordance with sub paragraph (e)(2) above, unless a visual reference containing at least one centreline light is attained and can be maintained.~~

- ~~(5) Required RVR.~~ The lowest **RVR** minima to be used by an operator **operators** for ~~Category III~~ **CAT III** operations are **specified in Table 4.**

~~Table 3~~ **Table 4: RVR for CAT III Operations-operations minima RVR vs. DH and roll-out/rollout control/guidance system**

Category III minima

CategoryCAT	DH Decision Height (ft.) * (Note 2)	Roll-out/rollout Control/guidance System	RVR (m-)
IIIA	Less than 100-ft	Not required	200- m
IIIB	Less than 100-ft	Fail-passive	150 ** - m (Note 1)
IIIB	Less than 50 ft	Fail-passive	125 m
IIIB	Less than 50 ft-or no DH No-Decision Height	Fail-operational *** (Note 3)	75 m

~~Note 1:~~ For aeroplanes certified in accordance with CS-AWO 321(b)(3) or equivalent.

~~Note 2~~*: Flight control system redundancy is determined under CS-AWO by the minimum certified ~~ated~~ decision height **DH**.

****:** For aeroplanes certified in accordance with CS-AWO 321(b)(3) or equivalent.

~~Note 3~~***: The fail-operational system referred to may consist of a fail-operational hybrid system.

OPERATIONS UTILISING EVS

~~(h) Enhanced Vision Systems~~

~~(1) 1.A-~~ The pilot using an enhanced vision system **a certified enhanced vision system (EVS)** certified for the purpose of this paragraph and used in accordance with the procedures and limitations of the ~~approved flight manual~~ **AFM**, may:

a.

- ~~(i) c~~ Continue an approach below DH ~~or~~ /MDH to 100 feet above the threshold elevation of the runway provided that ~~at least one of the following~~ **a** visual references is displayed and identifiable on the **EVS image**; ~~enhanced vision system~~; **and**

~~b.~~ (A) Elements of the approach lighting; or

(B) The runway threshold, identified by at least one of the following: the beginning of the runway landing surface, the threshold lights, the threshold identification lights; and the touchdown zone, identified by at least one of the following: the runway touchdown zone landing surface,

Comment [WS152]:
Moved to AMC1-CAT.OP.AH.300(d)

Subpart E | Revised rule text

~~the touchdown zone lights, the touchdown zone markings or the runway lights.~~

- (ii) Reduce the calculated RVR/CMV for the approach from the value in column- 1 of ~~Table 9~~ **Table 5** below to the value in column 2 ~~for ILS, MLS, precision approach radar (PAR), GBAS landing system (GLS) and APV operations with a DH not lower than 200 ft and an approach flown using approved vertical flight path guidance to a DH/MDH no lower than 250 ft.~~

Comment [WSI53]:
Moved up from below.

- 2. For operations where call-outs below 200 ft above the threshold are necessary, the operator should verify that the terrain ahead of the runway threshold has been surveyed.

Comment [WSI54]:
Added to account any safety risk for applying a radio altimeter.

**Table 5: Operations utilising EVS
RVR/CMV reduction vs. normal RVR/CMV**

~~Table 9~~ Approach utilising EVS RVR/CMV Reduction vs Normal RVR/C

n RVR/CMV (m) Normally required	RVR/CMV (m) for approach utilising EVS
550	350
600	400
650	450
700	450
750	500
800	550
900	600
1 000	650
1 100	750
1 200	800
1 300	900
1 400	900
1 500	1 000
1 600	1 100
1 700	1 100
1 800	1 200

Subpart E | Revised rule text

1 900	1 300
2 000	1 300
2 100	1 400
2 200	1 500
2 300	1 500
2 400	1 600
2 500	1 700
2 600	1 700
2 700	1 800
2 800	1 900
2 900	1 900
3 000	2 000
3 100	2 000
3 200	2 100
3 300	2 200
3 400	2 200
3 500	2 300
3 600	2 400
3 700	2 400
3 800	2 500
3 900	2 600
4 000	2 600
4 100	2 700
4 200	2 800
4 300	2 800
4 400	2 900

Subpart E | Revised rule text

4 500	3 000
4 600	3 000
4 700	3 100
4 800	3 200
4 900	3 200
5 000	3 300

~~(2)~~
~~Paragraph (h)(1) above may only be used for ILS, MLS, PAR, GLS and APV Operations with a DH no lower than 200 feet or an approach flown using approved vertical flight path~~

Comment [WSI55]:
 Moved up.

guidance to a MDH or DH no lower than 250 feet.

~~(3) A pilot may not continue an approach below 100 feet above runway threshold elevation for the intended runway, unless at least one of the visual references specified below is distinctly visible and identifiable to the pilot without reliance on the enhanced vision system:~~

- ~~(A) The lights or markings of the threshold; or~~
- ~~(B) The lights or markings of the touchdown zone.~~

Comment [WSI56]:
 Moved to AMC1-CAT.OP.AH.300(d).

Subpart E | Revised rule text

~~(i)~~ **Intentionally left blank**

[08]Part-CAT

Subpart B - Operating procedures – AMC/GM

AMC1-CAT.OP.AH.110 Aerodrome operating minima

...

CIRCLING OPERATIONS - AEROPLANES

1. Circling minima ~~circling operations~~

The following standards should apply for establishing circling minima for operations with aeroplanes:

~~a.(1) Minimum Descent Height (MDH). The MDH for circling shall be the highest of:~~ **should** be the highest of:

- ~~(i.) The published circling OCH for the aeroplane category; or~~
- ~~(ii.) The minimum circling height derived from Table 8 below; or~~
- ~~(iii.) The DH/-MDH of the preceding instrument approach procedure;-~~

~~b.(2) Minimum Descent Altitude (MDA). The MDA for circling shall be calculated by adding the published aerodrome elevation to the MDH, as determined by 1.a. by (1) above;-~~ **should** be calculated by adding the published aerodrome elevation to the MDH, as determined **by 1.a. by (1) above;-**

~~c.(3) Visibility. The minimum visibility for circling shall be the highest of:~~ **should** be the highest of:

- ~~(i.) The circling visibility for the aeroplane category, if published; or~~
- ~~(ii.) The minimum visibility derived from Table 8 below; or~~
- ~~(iii.) The RVR/CMV derived from Tables 5 and 6 for the preceding instrument approach procedure.~~

~~(4) Notwithstanding the requirements in sub paragraph (3) above, an Authority may exempt an operator from the requirement to increase the visibility above that derived from Table 10.~~

Comment [WSI57]:
Should be subject of an alternative MC procedure.

~~(5) Exemptions as described in para (4) must be limited to locations where there is a clear public interest to maintain current operations. The exemptions must be based on the operator's experience, training programme and flight crew qualification. The exemptions must be reviewed at regular intervals.~~

Comment [WSI58]:
Should be subject of an alternative MC procedure.

~~Table 10 Minimum Visibility and MDH for circling vs. aeroplane category~~

Table 8: Circling - aeroplanes MDH and minimum visibility vs. aeroplane category

	Aeroplane Category			
	A	B	C	D

Subpart E | Revised rule text

MDH (ft)	400	500	600	700
Minimum meteorological visibility (m)	1500	1600	2400	3600

~~(2) Circling with prescribed tracks is an accepted procedure within the meaning of this paragraph.~~

ONSHORE CIRCILING OPERATIONS - HELICOPTERS

~~(j) Circling~~ **For circling the specified MDH should not be less than 250 ft, and the meteorological visibility not less than 800 m.**

VISUAL APPROACH OPERATIONS

~~(k) Visual Approach. An operator~~ **The operator shall** ~~shall~~ **not use an RVR of less than 800 m for a visual approach operation.**

CONVERSION OF REPORTED METEOROLOGICAL VISIBILITY TO RVR

~~1. Conversion of Reported Meteorological Visibility to RVR/CMV.~~

~~a1. An operator must ensure that a~~ **conversion from** ~~meteorological visibility to RVR/CMV conversion is~~ **should not be used when**

- a. reported RVR is available;**
- b. for calculating take-off minima; and**
- c. for other RVR minima less than 800 m.** ~~for takeoff, for calculating any other required RVR minimum less than 800 m, or when reported RVR is available.~~

~~2b. Note: If the RVR is reported as being above the maximum value assessed by the aerodrome operator, e.g. "RVR more than 1 500 metres m", it is~~ **should not be considered to be as** ~~a reported value for the purpose of this paragraph.~~

~~3e.2~~ **When converting meteorological visibility to RVR in all other circumstances other than those in sub-paragraph a.(1) and b. above, an operator must ensure that the following Table is** ~~conversion factors specified in Table 9 should be used.~~

~~Table 11~~ **Table 9: Conversion of reported meteorological visibility to RVR/CMV**

LightingLight elements in operation	RVR/CMV = rReported mMeteteorological- vVisibility x	
	Day	Night
HI approach and runway lightinglights	1 51.5	2 02.0
Any type of lightinglight installation other than above	1 01.0	1 51.5
No lightinglights	1 01.0	nNot applicable

Subpart E | Revised rule text

Subpart E | Revised rule text

Subpart B - Operating procedures**CAT.OP.AH.325 Appendix 2 to OPS 1.430 (c) Aeroplane categories****AEROPLANE CATEGORIES — ALL WEATHER OPERATIONS**

- (a) ~~Classification of aeroplanes~~The criteria taken into consideration for the classification of aeroplanes by categories **shall be** ~~is~~ the indicated airspeed at threshold (V_{AT}) which is equal to the stalling speed (V_{SO}) multiplied by 1.3 or **1 g stall speed (V_{S1G})** multiplied by 1.23 in the landing configuration at the maximum certified landing mass. If both V_{SO} and V_{S1G} are available, the higher resulting V_{AT} shall be used.
- (b) The aeroplane categories corresponding to V_{AT} values are **specified** in the Table below:

Table 1: Aeroplane categories corresponding to V_{AT} values

Aeroplane Category	V_{AT}
A	Less than 91 kts
B	From 91 to 120 kts
C	From 121 to 140 kts
D	From 141 to 165 kts
E	From 166 to 210 kts

- (c) The landing configuration which is to be taken into consideration shall be **specified** ~~defined by the operator or by the aeroplane manufacturer~~**in the operations manual.**
- (d) ~~Permanent change of category (maximum landing mass)~~
- (1) ~~An operator~~**The operator** may ~~impose~~**apply** a permanent, lower, landing mass, and use this mass for determining the V_{AT} if approved by the ~~Authority~~**competent authority.**
- (2) ~~Such a lower landing mass~~ The category defined for a given aeroplane shall be a permanent value, and ~~thus~~ independent of the changing conditions of day-to-day operations.

Subpart E | Revised rule text

[15]Part-SPA

Subpart E – Low visibility operations – AMC/GM

AMC1-SPA.LVO.105 Appendix 1 to OPS 1.440 Low Visibility Operations – General Operating Rules LVO approval

GENERAL STANDARDS

1. ~~General.~~The following procedures **should** apply to the introduction and approval of ~~low visibility operations~~**LVO. The standards for CAT II should apply to OTS CAT II in the same way.**

OPERATIONAL DEMONSTRATION - AEROPLANES

2. ~~Operational Demonstration.~~The purpose of the operational demonstration is to determine or validate the use and effectiveness of the applicable aircraft flight guidance systems, including HUDLS if appropriate, training, flight crew procedures, maintenance programme, and manuals applicable to the ~~CAT~~category II/III programme being approved.
 - a. At least 30 approaches and landings ~~must~~**should** be accomplished in operations using the ~~Category II~~**CAT II/III** systems installed in each aircraft type if the requested DH is 50 ft or higher. If the DH is less than 50 ft, at least 100 approaches and landings ~~will need to~~**should** be accomplished. ~~unless otherwise approved by the Authority.~~
 - b. If ~~an operator~~**the operator** has different variants of the same type of aircraft utilising the same basic flight control and display systems, or different basic flight control and display systems on the same type of aircraft, ~~the operator~~**the operator** ~~must~~**should** show that the various variants have satisfactory performance, but ~~the operator~~ need not conduct a full operational demonstration for each variant. ~~The Authority may also accept a reduction of~~ ~~the number of approaches~~ ~~and landings~~ ~~with an AOC issued in accordance with OPS 1~~ ~~using the same aeroplane type or variant and procedures.~~ **may be** based on credit given for the experience gained by another operator, ~~with an AOC issued in accordance with OPS 1~~ using the same aeroplane type or variant and procedures.
 - c. If the number of unsuccessful approaches exceeds 5-~~%~~**%** of the total, (e.g. unsatisfactory landings, system disconnects, **etc.**, the evaluation programme ~~must~~**should** be extended in steps of at least 10 approaches and landings until the overall failure rate does not exceed 5-~~%~~**%**.
3. ~~Data Collection For Operational Demonstrations.~~ Each applicant ~~must develop~~ ~~The operator should establish~~ a data collection method (e.g. a form to be used by the flight crew) to record approach and landing performance. The resulting data and a summary of the demonstration data ~~shall~~**should** be made available to the ~~Authority~~**competent authority** for evaluation.
4. ~~Data Analysis.~~ Unsatisfactory approaches and/or automatic landings ~~shall~~**should** be documented and analysed.

Comment [WS159]:
This has been deleted because it would be subject of an AMC procedure which would require an approval of the competent authority.

Subpart E | Revised rule text

OPERATIONAL DEMONSTRATION - HELICOPTERS

Comment [WSI60]:
transposed from AMC1-
OPS.SPA.001.LVO.

- 5. The operator should comply with the provisions prescribed below when introducing a helicopter type that is new to the European Union into CAT II or III service.**
- a. Operational reliability**
The CAT II and III success rate should not be less than that required by CS-AWO or equivalent.
- b. Criteria for a successful approach**
An approach is regarded as successful if:
- i. the criteria as specified in CS-AWO or equivalent are met; and
 - ii. no relevant helicopter system failure occurs.
- For helicopter types already used for CAT II or III operations in another Member State, the in-service proving programme in 9. should be used instead.
- 6. Data collection during airborne system demonstration - general**
- a. The operator should establish a reporting system to enable checks and periodic reviews to be made during the operational evaluation period before the operator is approved to conduct CAT II or III operations. The reporting system should cover all successful and unsuccessful approaches, with reasons for the latter, and include a record of system component failures. This reporting system should be based upon flight crew reports and automatic recordings as prescribed in 7. and 8. below.**
- b. The recordings of approaches may be made during normal line flights or during other flights performed by the operator.**
- 7. Data collection during airborne system demonstration – operations with DH not less than 50 ft**
- a. For operations with DH not less than 50 ft, data should be recorded and evaluated by the operator and evaluated by the competent authority when necessary.**
- b. It is sufficient for the following data to be recorded by the flight crew:**
- i. FATO and runway used;
 - ii. weather conditions;
 - iii. time;
 - iv. reason for failure leading to an aborted approach;
 - v. adequacy of speed control;
 - vi. trim at time of automatic flight control system disengagement;
 - vii. compatibility of automatic flight control system, flight director and raw data;
 - viii. an indication of the position of the helicopter relative to the ILS, MLS centreline when descending through 30 m (100 ft); and

*Subpart E | Revised rule text***ix. touchdown position.**

- c. The number of approaches made during the initial evaluation should be sufficient to demonstrate that the performance of the system in actual airline service is such that a 90% confidence and a 95% approach success will result.**

8. Data collection during airborne system demonstration – operations with DH less than 50 ft or no DH

- a. For operations with DH less than 50 ft or no DH, a flight data recorder (FDR), or other equipment giving the appropriate information, should be used in addition to the flight crew reports to confirm that the system performs as designed in actual airline service. The following data should be recorded:**
 - i. distribution of ILS, MLS deviations at 30 m (100 ft), at touchdown and, if appropriate, at disconnection of the rollout control system and the maximum values of the deviations between those points; and**
 - ii. sink rate at touchdown.**
- b. Any landing irregularity should be fully investigated using all available data to determine its cause.**

9. In-service proving

The operator fulfilling the provisions of 6. above should be deemed to have met the in-service proving contained in this subparagraph.

- a. The system should demonstrate reliability and performance in line operations consistent with the operational concepts. A sufficient number of successful landings should be accomplished in line operations, including training flights, using the auto-land and rollout system installed in each helicopter type.**
- b. The demonstration should be accomplished using a CAT II or CAT III ILS. Demonstrations may be made on other ILS, MLS facilities if sufficient data are recorded to determine the cause of unsatisfactory performance.**
- c. If the operator has different variants of the same type of helicopter utilising the same basic flight control and display systems, or different basic flight control and display systems on the same type of helicopter, the operator should show that the variants comply with the basic system performance criteria, but the operator need not conduct a full operational demonstration for each variant.**
- d. Where the operator introduces a helicopter type that has already been approved by the competent authority of any Member State for CAT II and/or CAT III operations a reduced proving programme may be acceptable.**

CONTINUOUS MONITORING – ALL AIRCRAFT

~~(e)~~**10. Continuous mMonitoring**

Subpart E | Revised rule text

- a.**(1) After obtaining the initial ~~authorisation~~ **approval**, the operations ~~must~~ **should** be continuously monitored by the operator to detect any undesirable trends before they become hazardous. Flight crew reports may be used to achieve this.
- b.**(2) The following information ~~must~~ **should** be retained for a period of 12 months:
- (i.) ~~t~~ The total number of approaches, by ~~aeroplane~~ **aircraft** type, where the airborne ~~Category~~ **HCAT II** or III equipment was utilised to make satisfactory, actual or practice, approaches to the applicable ~~Category~~ **HCAT II** or III minima; and
 - (ii.) ~~r~~ Reports of unsatisfactory approaches and/or automatic landings, by aerodrome and ~~aeroplane~~ **aircraft** registration, in the following categories:
 - (A.) ~~a~~ Airborne equipment faults;
 - (B.) ~~g~~ Ground facility difficulties;
 - (C.) ~~m~~ Missed approaches because of ATC instructions; or
 - (D.) ~~o~~ Other reasons.
- c.**(3) ~~An operator~~ **The operator** ~~must~~ **should** establish a procedure to monitor the performance of the automatic landing system or HUDLS to touchdown performance, as appropriate, of each ~~aeroplane~~ **aircraft**.

Subpart E | Revised rule text

[18]Part-AR

Subpart OPS – Specific requirements related to air operations

Section II - Approvals

AMC3-AR.OPS.200 Specific Approval Procedure

PROCEDURES FOR LOW VISIBILITY APPROVALS - TRANSITIONAL PERIODS FOR CAT II OR CAT III

1.(f) Transitional periods

~~(1)~~ Operators with no previous ~~Category II~~ **CAT II** or III experience

~~a(i.) An operator~~ **Operators** without previous ~~Category II~~ **CAT II** or III operational experience may be approved for ~~Category II~~ **CAT II** or IIIA operations, having gained a minimum experience of ~~6~~ **six** months of ~~Category I~~ **CAT I** operations on the ~~aeroplane~~ **aircraft** type.

~~b(ii.) On completing 6~~ **six** months of ~~Category II~~ **CAT II** or IIIA operations on the ~~aeroplane~~ **aircraft** type ~~the operator~~ **the operator** may be approved for ~~Category III~~ **CAT III** B operations. When granting such an approval, the ~~Authority~~ **competent authority** may impose higher minima than the lowest applicable for an additional period. The increase in minima ~~will~~ **should** normally only refer to RVR and/or a restriction against operations with no ~~DH~~ **decision height** and ~~must~~ **should** be selected such that they will not require any change of the operational procedures.

2.(2) Operators with previous CAT II or III experience

~~a(i.) Operators with previous Category II or III experience. An operator~~ **Operators** with previous ~~Category II~~ **CAT II** or III experience may obtain ~~authorisation~~ **approval** for a reduced transition period. ~~by application to the Authority.~~

~~b(ii.) An~~ **The Operator** ~~operator~~ **operator** ~~authorised~~ **approved** for ~~Category II~~ **CAT II** or III operations using auto-~~coupled~~ approach procedures, with or without ~~auto-~~ **auto-land**, and subsequently introducing manually flown ~~Category II~~ **CAT II** or III operations using a HUDLS ~~shall~~ **should** be considered to be a "nNew ~~Category II/III~~ **CAT II/III** operator" for the purposes of the demonstration period provisions.

Subpart E | Revised rule text

[16]Part-SPA

Subpart E – Low visibility operations – AMC/GM

AMC1-SPA.LVO.105 LVO approval

...

MAINTENANCE OF CAT II, CAT III AND LVTO EQUIPMENT

~~(g)~~ **11.** Maintenance of Category II, Category III and LVTO equipment. Maintenance instructions for the on-board guidance systems ~~must~~**should** be established by the ~~operator~~**the operator**, in liaison with the manufacturer, and included in the ~~operator~~**the operator's** aeroplane ~~aircraft~~ maintenance programme ~~prescribed in accordance with Part-M, paragraph M.A.302 which must be approved by the Authority.~~

ELIGIBLE AERODROMES AND RUNWAYS

~~(h)~~ **12.** Eligible ~~a~~Aerodromes and ~~r~~Runways

- ~~a.~~(1) Each aeroplane ~~aircraft~~ type/runway combination ~~must~~**should** be verified by the successful completion of at least one approach and landing in ~~Category II~~**CAT II** or better conditions, prior to commencing ~~Category III~~**CAT III** operations.
- ~~b.~~(2) For runways with irregular pre-threshold terrain or other foreseeable or known deficiencies, each aeroplane ~~aircraft~~ type/runway combination ~~must~~**should** be verified by operations in ~~standard Category I~~**CAT I** or better conditions, prior to commencing ~~Lower than Standard Category I~~**ILTS CAT I**, ~~Other than Standard Category II~~**OTS CAT II** or ~~Category III~~**CAT III** operations.
- ~~c.~~(3) If an ~~operator~~**the operator** has different variants of the same type of aeroplane ~~aircraft~~ in accordance with ~~sub paragraph 13.d.4~~ below, utilising the same basic flight control and display systems, or different basic flight control and display systems on the same type of aeroplane ~~aircraft~~ in accordance with ~~sub paragraph 12.d.4~~ below, ~~the operator~~**the operator** ~~must~~**should** show that the variants have satisfactory operational performance, but ~~the operator~~ need not conduct a full operational demonstration for each variant/runway combination.
- ~~d.~~(4) For the purpose of ~~this AMC paragraph (h)~~, an aeroplane ~~aircraft~~ type or variant of an aeroplane type ~~is~~**should be** deemed to be the same type/variant of aeroplane ~~aircraft~~ if that type/variant has the same or similar:
- ~~(i.)~~ **l**Level of technology, including the:
 - ~~(A.)~~ **f**light control/guidance system (FGS) and associated displays and controls;
 - ~~(B.)~~ ~~The~~FMS and level of integration with the FGS; **and**
 - ~~(C.)~~ **u**se of HUDLS;
 - ~~(ii.)~~ **o**Operational procedures, including:
 - ~~(A.)~~ **a**Alert height;
 - ~~(B.)~~ **m**Manual landing /automatic landing;

Subpart E | Revised rule text

- ~~(C.) nNo DHdecision height operations; and~~
~~(D.) uUse of HUD/HUDLS in hybrid operations;:-~~
- (iii.) ~~hHandling characteristics, including:~~
- ~~(A.) mManual landing from automatic or HUDLS guided approach;~~
~~(B.) mManual go-aroundmissed approach procedure from automatic approach; and~~
~~(C.) aAutomatic/manual roll-out.~~
- e.(5) Operators using the same ~~aeroplane~~**aircraft** type/class or variant of a type in accordance with ~~paragraph 12.d.4~~ above may take credit from ~~each others'~~**each other's** experience and records in complying with this ~~sub~~paragraph.
- ~~(6) Operators conducting Other than Standard Category II operations shall comply with Appendix 1 to OPS 1.440 Low Visibility Operations General Operating Rules applicable to Category II operations.~~

Comment [WSI61]:
 Already specified in the first sentence of this AMC.

AMC1-SPA.LVO.120Appendix 1 to OPS 1.450 Low Visibility Operations Flight crew tTraining and & Qualificationsqualifications

GENERAL STANDARDS

- 1.(a) ~~General: An~~**The** operator ~~must~~**should** ensure that flight crew member training programmes for ~~Low Visibility OperationsLVO~~ include structured courses of ground, ~~Flight SimulatorFSTD~~ and/or flight training. ~~The operator may abbreviate the course content as prescribed by sub paragraphs (2) and (3) below provided the content of the abbreviated course is acceptable to the authority.~~
- a.(1) Flight crew members with no ~~Category IICAT II~~ or ~~Category IIICAT III~~ experience ~~must~~**should** complete the full training programme prescribed in ~~sub paragraphs (b)2., (c)3., and (d)4.~~ below.
- b.(2) Flight crew members with ~~Category IICAT II~~ or ~~Category IIICAT III~~ experience with a similar type of operation (auto--coupled--/ auto-land**auto-land**, HUDLS/~~H~~hybrid HUDLS or EVS) or ~~Category IICAT II~~ with manual land, if appropriate, with another ~~Community~~**European Union** operator may undertake an:
- (i.) ~~a~~**A**bbreviated ground training course if operating a different type ~~or/~~ class from that on which the previous ~~Category IICAT II~~ or ~~Category IIICAT III~~ experience was gained;
- (ii.) ~~a~~**A**bbreviated ground, ~~Flight Simulator~~**FSTD** and/or flight training course if operating the same type ~~or/~~ class and variant of the same type or class on which the previous ~~Category IICAT II~~ or ~~Category IIICAT III~~ experience was gained. The abbreviated course ~~is to~~**should** include at least the requirements ~~standards~~ of sub paragraphs ~~(d)4.(1)a., (d)4.(2)b.(i)i. or (d)4.(2)b.(ii)ii.~~ as appropriate and ~~(d)4.(3)c.(i)i.~~ ~~With the approval of the Authority, t~~The operator may reduce the number of approaches/landings required by ~~sub paragraph (d)4.(2)b.(i)i.~~ if the type/class or the variant of the type or class has the same or similar:
- (A)~~A.~~ ~~I~~**I**level of technology - ~~f~~**F**light control/guidance system (FGS); ~~and~~

Comment [WSI62]:
 The first sentence is a repetition of paragraph (2) and not necessary. The second sentence is embedded in the overall approval which requires demonstration of sufficient FC training.

Comment [WSI63]:
 Deleted because this is part of the LVO approval.

Subpart E | Revised rule text

- ~~(B)~~ **B. o** Operating ~~onal~~-procedures;
- ~~(C)~~ **C. h** Handling characteristics ~~(See paragraph 4 below);~~
as the previously operated type or class, otherwise the requirement of ~~(d)(2)(i)~~ has to be met in full.
- ~~(D)~~ **D. u** Use of HUDLS/~~h~~Hybrid HUDLS; **and**
- ~~(E)~~ **E. u** Use of EVS

as the previously operated type or class, otherwise the standards of 4.b.i. should be met.

- ~~c(3).~~ Flight crew members with ~~Category II~~ **Category II** or ~~Category III~~ **Category III** experience with ~~the operator~~ **the operator** may undertake an abbreviated ground, ~~Flight simulator~~ **FSTD** and/or flight training course.

~~The abbreviated course when changing:~~

- (i.) **When changing a** ~~Aeropl~~**aircraft** type or ~~class,~~ **the abbreviated course should** ~~is to include~~ at least the ~~requirements~~ **standards** of subparagraphs ~~(d)4.(1)a., (d)4.(2)b.(i)i. or (d)4.(2)b.(ii)ii.~~ as appropriate and ~~(d)4.(3)c.(i)i.~~.

- (ii.) **When changing t** ~~To~~ a different variant of ~~aeropl~~**aircraft** within the same type or class rating that has the same or similar:

- ~~(A)~~ **A. l** Level of technology - flight control/guidance system (FGS); **and**
- ~~(B)~~ **B. o** Operating ~~onal~~-procedures - integrity;
- ~~(C)~~ **C. h** Handling characteristics ~~(See paragraph 4 below);~~
- ~~(D)~~ **D. u** Use of HUDLS/Hybrid HUDLS; **and**
- ~~(E)~~ **E. u** Use of EVS

as the previously operated type or class, ~~then~~ a difference course or familiarisation appropriate to the change of variant **should** fulfil the abbreviated course ~~requirements~~**standards**.

- (iii.) **When changing t** ~~To~~ a different variant of ~~aeropl~~**aircraft** within the same type or class rating that has a significantly different:

- ~~(A)~~ **A. l** Level of technology - flight control/guidance system (FGS); **and**
- ~~(B)~~ **B. o** Operating ~~onal~~-procedures - integrity;
- ~~(C)~~ **C. h** Handling characteristics ~~(See paragraph 4 below);~~
- ~~(D)~~ **D. u** Use of HUDLS/Hybrid HUDLS; **or**
- ~~(E)~~ **E. u** Use of EVS,

~~then~~ the ~~requirements~~ **standards** of sub-paragraphs ~~(d)4.(1)a., (d)4.(2)b.(i)i. or (d)4.(2)b.(ii)ii.~~ as appropriate and ~~(d)4.(3)c.(i)i.~~ shall **should** be fulfilled. With the approval of the Authority the operator may ~~reduce the number of approaches/landings required by sub-paragraph (d)(2)(i).~~

- ~~d.(4) An~~ **The operator must** ~~should~~ ensure when undertaking ~~Category II~~ **Category II** or ~~Category III~~ **Category III** operations with different variant(s) of ~~aeropl~~**aircraft** within the same type or class rating that the differences and/or similarities of the ~~aeropl~~**aircraft** concerned justify such operations, taking account at least the following:

Subpart E | Revised rule text

- (i.) the level of technology, including the:
 - (A.) FGS and associated displays and controls;
 - (B.) ~~The Flight Management System~~ **FMS** and its integration or not with the FGS; **and**
 - (C.) ~~u~~**Use** of HUD/HUDLS with hybrid systems and/or EVS;-
- (ii) ~~o~~**Operating** ~~en~~ procedures, including:
 - (A.) ~~f~~**Fail**-passive / fail-operational, alert height;
 - (B.) ~~m~~**Manual** landing / automatic landing;
 - (C.) ~~n~~**No decision height** **DH** operations; **and**
 - (D.) ~~u~~**Use** of HUD/HUDLS with hybrid systems;-
- (iii) ~~h~~**Handling** characteristics, including:
 - (A.) ~~m~~**Manual** landing from automatic HUDLS and/or EVS guided approach;
 - (B.) ~~m~~**Manual go-around** **missed approach procedure** from automatic approach; **and**
 - (C.) ~~a~~**Automatic**/manual roll-out.

GROUND TRAINING

- (b) ~~2. Ground Training. An~~ **The** operator must ensure that the initial ground training course for ~~Low Visibility Operations~~ **LVO** **should include** ~~covers~~ at least:
 - (1) ~~a. t~~**The** characteristics and limitations of the ILS and/or MLS;
 - (2) ~~b. t~~**The** characteristics of the visual aids;
 - (3) ~~c. t~~**The** characteristics of fog;
 - (4) ~~d. t~~**The** operational capabilities and limitations of the particular airborne system to include HUD symbology and EVS characteristics if appropriate;
 - (5) ~~e. t~~**The** effects of precipitation, ice accretion, low level wind shear and turbulence;
 - (6) ~~f. t~~**The** effect of specific ~~aeroplane~~ **aircraft**/system malfunctions;
 - (7) ~~g. t~~**The** use and limitations of RVR assessment systems;
 - (8) ~~h. t~~**The** principles of obstacle clearance requirements;
 - (9) ~~i. r~~**Recognition** of and action to be taken in the event of failure of ground equipment;
 - (10) ~~j. t~~**The** procedures and precautions to be followed with regard to surface movement during operations when the RVR is 400 m or less and any additional procedures required for take-off in conditions below 150 m (200 m for Category D aeroplanes);
 - (11) ~~k. t~~**The** significance of ~~decision height~~ **DHs** based upon radio altimeters and the effect of terrain profile in the approach area on radio altimeter readings and on the automatic approach/landing systems;
 - (12) ~~l. t~~**The** importance and significance of ~~a~~ **Alert** ~~h~~ **Height**, if applicable, and the action in the event of any failure above and below the ~~a~~ **Alert** ~~h~~ **Height**;

Subpart E | Revised rule text

- ~~(13)~~**m.** ~~t~~The qualification requirements for pilots to obtain and retain approval to conduct **LVOs**~~Low Visibility Take-offs and Category II or III operations~~; and
- ~~(14)~~**n.** ~~t~~The importance of correct seating and eye position.

FSTD TRAINING AND/OR FLIGHT TRAINING~~(c)~~**3.** ~~Flight Simulator~~**FSTD** training and/or flight training

- ~~(1)~~**a.** ~~An operator must ensure that Flight Simulator~~**FSTD** and/or flight training for ~~Low Visibility Operations~~**LVO should** include **at least**:
- ~~(i)~~**i.** ~~c~~Checks of satisfactory functioning of equipment, both on the ground and in flight;
 - ~~(ii)~~**ii.** ~~e~~Effect on minima caused by changes in the status of ground installations;
 - ~~(iii)~~**iii.** ~~m~~Monitoring of:
 - ~~(A)~~**A.** ~~a~~Automatic flight control systems and auto-land status annunciators with emphasis on the action to be taken in the event of failures of such systems; and
 - ~~(B)~~**B.** HUD/HUDLS/EVS guidance status and annunciators as appropriate, to include ~~h~~Head-~~d~~Down ~~d~~Displays;-
 - ~~(iv)~~**iv.** ~~a~~Actions to be taken in the event of failures such as engines, electrical systems, hydraulics or flight control systems;
 - ~~(v)~~**v.** ~~t~~The effect of known unserviceabilities and use of ~~minimum equipment list~~**MELs**;
 - ~~(vi)~~**vi.** ~~o~~Operating limitations resulting from airworthiness certification;
 - ~~(vii)~~**vii.** ~~g~~Guidance on the visual cues required at ~~decision height~~**DH** together with information on maximum deviation allowed from glide path or localiser; and
 - ~~(viii)~~**viii.** ~~t~~The importance and significance of ~~a~~Alert ~~h~~Height if applicable and the action in the event of any failure above and below the ~~a~~Alert ~~h~~Height.
- ~~(2)~~**b.** ~~F~~An operator must ensure that each flight crew member **should be** is-trained to carry out **their** ~~his/her~~ duties and instructed on the coordination required with other crew members. Maximum use should be made of **suitably equipped FSTDs for this purpose**~~flight simulators~~.
- ~~(3)~~**c.** Training ~~must~~**should** be divided into phases covering normal operation with no ~~aeroplane~~**aircraft** or equipment failures but including all weather conditions which may be encountered and detailed scenarios of ~~aeroplane~~**aircraft** and equipment failure which could affect ~~Category II~~**CAT II** or III operations. If the ~~aeroplane~~**aircraft** system involves the use of hybrid or other special systems, (such as HUD/HUDLS or enhanced vision equipment), then flight crew members ~~must~~**should** practise the use of these systems in normal and abnormal modes during the ~~Flight Simulator~~**FSTD** phase of training.
- ~~(4)~~**d.** Incapacitation procedures appropriate to ~~Low Visibility Take-offs~~**LVTO** and ~~Category II~~**CAT II** and ~~Category III~~**CAT III** operations ~~shall~~**should** be practised.

Subpart E | Revised rule text

- (5)e. For ~~aeroplanes~~**aircraft** with no ~~Flight Simulator~~**FSTD** available to represent that specific ~~aeroplane~~**aircraft**, operators ~~must~~**should** ensure that the flight training phase specific to the visual scenarios of ~~Category II~~**CAT II** operations is conducted in a specifically approved ~~Flight Simulator~~**FSTD**. Such training ~~must~~**should** include a minimum of ~~4~~**four** approaches. ~~Thereafter, the~~ training and procedures that are type specific ~~shall~~**should** be practised in the ~~aeroplane~~**aircraft**.
- (6)f. Initial ~~Category II~~**CAT II** and III training ~~shall~~**should** include at least the following exercises:
- (i)i. ~~a~~**A** Approach using the appropriate flight guidance, autopilots and control systems installed in the ~~aeroplane~~**aircraft**, to the appropriate ~~decision height~~**DH** and to include transition to visual flight and landing;
 - (ii)ii. ~~a~~**A** Approach with all engines operating using the appropriate flight guidance systems, autopilots, HUDLS and/or EVS and control systems installed in the ~~aeroplane~~**aircraft** down to the appropriate ~~decision height~~**DH** followed by missed approach; all without external visual reference;
 - (iii)iii. ~~w~~**W** Where appropriate, approaches utilising automatic flight systems to provide automatic flare, **hover**, landing and ~~roll-out~~**rollout**; and
 - (iv)iv. ~~n~~**N** Normal operation of the applicable system both with and without acquisition of visual cues at ~~decision height~~**DH**.
- (7)g. Subsequent phases of training ~~must~~**should** include at least:
- (i)i. ~~a~~**A** Approaches with engine failure at various stages on the approach;
 - (ii)ii. ~~a~~**A** Approaches with critical equipment failures, **such as** (~~e.g.~~ electrical systems, auto flight systems, ground and/or airborne ~~ILS/MLS~~**ILS, MLS/GLS** systems and status monitors);
 - (iii)iii. ~~a~~**A** Approaches where failures of auto flight equipment and/or HUD/HUDLS/EVS at low level require either;
 - (A)**A. r** Reversion to manual flight to control flare, **hover**, landing and roll out or missed approach; or
 - (B)**B. r** Reversion to manual flight or a downgraded automatic mode to control missed approaches from, at or below ~~decision height~~**DH** including those which may result in a touchdown on the runway;
 - (iv)iv. ~~f~~**F** Failures of the systems which will result in excessive localiser and/or glide slope deviation, both above and below ~~decision height~~**DH**, in the minimum visual conditions ~~authorised~~**specified** for the operation. In addition, a continuation to a manual landing ~~must~~**should** be practised if a head-up display forms a downgraded mode of the automatic system or the head-up display forms the only flare mode; and
 - (v)v. ~~f~~**F** Failures and procedures specific to ~~aeroplane~~**aircraft** type or variant.
- (8)h. The training programme ~~must~~**should** provide practice in handling faults which require a reversion to higher minima.
- (9)i. The training programme ~~must~~**should** include the handling of the ~~aeroplane~~**aircraft** when, during a fail-passive ~~Category III~~**CAT III** approach,

Subpart E | Revised rule text

the fault causes the autopilot to disconnect at or below ~~decision height~~**DH** when the last reported RVR is 300 m or less.

- ~~(10)~~**j.** Where take-offs are conducted in RVRs of 400 m and below, training ~~must~~**should** be established to cover systems failures and engine failure resulting in continued as well as rejected take-offs.
- ~~(11)~~**k.** The training programme ~~must~~**should** include, where appropriate, approaches where failures of the HUDLS and/or EVS equipment at low level require either:
- ~~(i)~~**i.** ~~r~~Reversion to head down displays to control missed approach; or
 - ~~(ii)~~**ii.** ~~r~~Reversion to flight with no, or downgraded, HUDLS ~~g~~Guidance to control missed approaches from ~~decision height~~**DH** or below, including those which may result in a touchdown on the runway.
- ~~(12)~~**l.** An ~~W~~operator shall ensure that when undertaking ~~Low Visibility Take-off~~**LVTO**, ~~Lower than Standard Category I~~**ILTS CAT I**, ~~Other than Standard Category II~~**HOTS CAT II**, and ~~Category II~~**CAT II** and ~~CAT III~~**CAT III** ~~Operations~~**operations** utilising a HUD/HUDLS or ~~h~~Hybrid HUD/HUDLS or an EVS, that the training and checking programme ~~should~~**should** include, where appropriate, the use of the HUD/HUDLS in normal operations during all phases of flight.

CONVERSION TRAINING

~~(d)~~**4.** ~~Conversion Training Requirements to conduct Low Visibility Take off, Lower than Standard Category I, Other than Standard Category II, Approach utilising EVS and Category II and III Operations. An operator shall ensure that each~~ ~~F~~flight crew members ~~should~~**should** completes the following ~~Low Visibility Procedures~~**LVPs** training if converting to a new type ~~or~~ /class or variant of ~~aeroplane~~**aircraft** in which ~~Low Visibility Take-off~~**LVTO**, ~~Lower than Standard Category I~~**ILTS CAT I**, ~~Other than Standard Category II~~**HOTS CAT II**, ~~a~~Approach ~~operations~~**operations** utilising EVS with an RVR of 800 m or less and ~~Category II~~**CAT II** and ~~CAT III~~**CAT III** ~~o~~Operations will be conducted. The flight crew member experience requirements to undertake an ~~Conditions for abbreviated courses~~**Conditions for** abbreviated courses are prescribed in subparagraphs ~~(a)1.(2)~~**b.**, ~~(a)1.(3)~~**c.** and ~~(a)1.(4)~~**d.**, above.÷

~~(1)~~**a.** Ground ~~t~~training-

The appropriate ~~requirements~~**standards** prescribed in subparagraph ~~(b)2.~~ above, taking into account the flight crew member's ~~Category II~~**CAT II** and ~~Category III~~**CAT III** training and experience.

~~(2)~~**b.** Flight Simulator ~~t~~Training and/or ~~f~~Flight training-

- ~~(i)~~**i.** A minimum of ~~six~~**6, respectively** ~~(eight~~ for HUDLS with or without EVS), approaches and/or landings in an ~~Flight Simulator~~**FSTD**. The ~~requirements~~**standards** for ~~8~~**eight** HUDLS approaches may be reduced to ~~6~~**six** when conducting ~~h~~Hybrid HUDLS operations. See subparagraph ~~(4)~~**(i)** below.
- ~~(ii)~~**ii.** Where no ~~Flight simulator~~**FSTD** is available to represent that specific ~~aeroplane~~**aircraft**, a minimum of ~~3~~**three, respectively** ~~(5~~ for HUDLS and/or EVS), approaches including at least ~~1~~**one go-around**missed approach procedure** is required on the ~~aeroplane~~**aircraft**. For ~~h~~Hybrid**

Subpart E | Revised rule text

HUDLS operations a minimum of ~~3~~**three** approaches are required, including at least ~~1~~**one go-around**~~missed approach procedure~~.

- ~~(iii)~~**iii.** Appropriate additional training if any special equipment is required such as head-up displays or enhanced vision equipment. When approach operations utilising EVS are conducted with an RVR of less than 800 m, a minimum of ~~5~~**five** approaches, including at least one ~~go-around~~**missed approach procedure** are required on the ~~aeropl~~**aircraft**.

~~(3)~~**c.** Flight ~~c~~**Q**ualification:

The flight crew qualification ~~requirements~~**standards** are specific to the ~~operator~~**the operator** and the type of ~~aeropl~~**aircraft** operated.

- ~~(i)~~**i.** ~~The operator~~**The operator must** ensure that each flight crew member completes a check before conducting ~~Category I~~**CAT II** or III operations.
- ~~(ii)~~**ii.** The check ~~prescribed~~**specified** in subparagraph ~~4.c.(i)~~**4.c.(i)** above may be replaced by successful completion of the ~~Flight Simulator~~**FSTD** and/or flight training ~~specified~~**specified** ~~prescribed in subparagraph (d)4.(2)b.~~ above.

~~(4)~~**d.** Line ~~f~~**S**upervision:

~~An Foperator must ensure that each flight crew member~~ **should** undergoes the following line flying under supervision (LIFUS):

- ~~(i)~~**i.** For ~~Category I~~**CAT II** when a manual landing or a HUDLS approach to touchdown is required, a minimum of:
- ~~(A)~~**A.** ~~3~~**three** landings from autopilot disconnect; **and**
- ~~(B)~~**B.** ~~4~~**four** landings with HUDLS used to touchdown;
- except that only ~~one~~**1** manual landing, **respectively** ~~(2~~**two** using HUDLS to touchdown) is required when the training required in ~~sub-paragraph (d)4.(2)b.~~ above has been carried out in an ~~Flight Simulator~~**FSTD** qualified for zero flight time conversion.
- ~~(ii)~~**ii.** For ~~Category I~~**CAT III**, a minimum of ~~2~~**two** auto-lands except that:
- ~~(A)~~**A.** ~~only 1~~**one** ~~autoland~~**auto-land** is required when the training required in sub-paragraph ~~(d)4.(2)b.~~ above has been carried out in an ~~Flight Simulator~~**FSTD** qualified for zero flight time conversion;
- ~~(B)~~**B.** ~~No autoland~~**auto-land** is required during LIFUS when the training required in sub-paragraph ~~(d)4.(2)b.~~ above has been carried out in an ~~Flight Simulator~~**FSTD** qualified for zero flight time (ZFT) conversion and the flight crew member successfully completed the ZFT type rating conversion course; **and**
- ~~(C)~~**C.** ~~The flight crew member, trained and qualified in accordance with paragraph (B)B. above, is qualified to operate during the conduct of LIFUS to the lowest approved DA/(H) and RVR as stipulated in the Operations Manual~~**operations manual**.
- ~~(iii)~~**iii.** For ~~Category I~~**CAT III** approaches using HUDLS to touchdown a minimum of ~~4~~**four** approaches.

Subpart E | Revised rule text

TYPE AND COMMAND EXPERIENCE~~(e)5.~~ Type and command experience-

~~(1)a.~~ Before commencing ~~Category I~~ **CAT II** operations, the following additional requirements ~~standards~~ **are should be** applicable to ~~commanders~~ **pilots-in-command/commanders**, or pilots to whom conduct of the flight may be delegated, who are new to the ~~aeroplane~~ **aircraft** type ~~or/~~ class:

~~(i)i.~~ 50 hours or 20 sectors on the type, including ~~line flying under supervision~~ **LIFUS**; and

~~(ii)ii.~~ 100 m ~~must~~ **should** be added to the applicable ~~Category I~~ **CAT II** RVR minima when the operation requires a ~~Category I~~ **CAT II** manual landing or use of HUDLS to touchdown until:

~~(A)A.~~ a total of 100 hours or 40 sectors, including LIFUS has been achieved on the type; or

~~(B)B.~~ a total of 50 hours or 20 sectors, including LIFUS has been achieved on the type where the flight crew member has been previously qualified for ~~Category I~~ **CAT II** manual landing operations with an ~~Community~~ **European Union** operator;

~~(C)C.f~~ For HUDLS operations the sector requirements ~~standards~~ in paragraphs ~~(e)5.(1)a.~~ and ~~(e)5.(2)b.(i)i.~~ **shall should** always be applicable, the hours on type ~~or/~~ class does not fulfil the ~~requirement~~ **standard**.

~~(2)b.~~ Before commencing ~~Category II~~ **CAT III** operations, the following additional requirements ~~standards should be~~ **are** applicable to ~~commanders~~ **pilots-in-command/commanders**, or pilots to whom conduct of the flight may be delegated, who are new to the ~~aeroplane~~ **aircraft** type:

~~(i)i.~~ 50 hours or 20 sectors on the type, including ~~line flying under supervision~~ **LIFUS**; and

~~(ii)ii.~~ 100 m ~~must~~ **should** be added to the applicable ~~Category I~~ **CAT II** or ~~Category II~~ **CAT III** RVR minima unless he/**she** has previously qualified for ~~Category I~~ **CAT II** or III operations with an ~~Community~~ **European Union** operator, until a total of 100 hours or 40 sectors, including ~~line flying under supervision~~ **LIFUS**, has been achieved on the type.

~~(3)~~ The Authority may authorise a reduction in the above command experience requirements for flight crew members who have ~~Category II or Category III~~ command experience-

Comment [WSI64]:
Deleted because this is part of an aMC procedure.

LVTO OPERATIONS~~(f)6.~~ Low Visibility Take Off **LVTO** with RVR less than ~~150/200~~ **400** m

~~(1)a.~~ An ~~operator~~ **P**operator must ensure that prior to authorisation to conducting take-offs in RVRs below ~~150~~ **400** m, (~~below 200 m for Category D aeroplanes~~) the **flight crew should undergo the** following training ~~is carried out~~:

~~(i)i.~~ ~~n~~Normal take-off in minimum **approved** ~~authorised~~ RVR conditions;

~~(ii)ii.~~ ~~t~~Take-off in minimum ~~authorised~~ **approved** RVR conditions with an engine failure:

Subpart E | Revised rule text

- A. for aeroplanes between V_1 and V_2 , (**take-off safety speed**) or as soon as safety considerations permit;
- B. for helicopters at or after take-off decision point (TDP); and
- (iii)iii. Take-off in minimum ~~authorised~~ **approved** RVR conditions with an engine failure:
 - A. for aeroplanes before V_1 resulting in a rejected take-off;
 - B. for helicopters before the TDP.
- (2)b. ~~An operator~~ **The operator must** ~~approved for LVTOs with an RVR below 150 m should~~ ensure that the training ~~required~~ **specified** by subparagraph 6.(1)a. above is carried out in an ~~Flight Simulator~~ **FSTD**. This training ~~must~~ **should** include the use of any special procedures and equipment. ~~Where no Flight Simulator is available to represent that specific aeroplane, the Authority may approve such training in an aeroplane without the requirement for minimum RVR conditions (See Appendix 1 to OPS 1.965).~~
- (3)c. ~~An operator~~ **The operator must** ~~should~~ ensure that a flight crew member has completed a check before conducting ~~low visibility take-offs~~ **LVTO** in RVRs of less than 150 m (~~less than 200 m for Category D aeroplanes~~) if applicable. The check may ~~only~~ be replaced by successful completion of the ~~Flight Simulator~~ **FSTD** and/or flight training prescribed in ~~subparagraph (f) 6.(1)a.~~ **6.(1)a.** on conversion to an ~~aeroplane~~ **aircraft** type.

Comment [WSI65]:
Deleted for safety reasons. There should be no LVTO with an RVR below 150 m without an appropriate FSTD training.

RECURRENT TRAINING AND CHECKING**(g)7. Recurrent ~~t~~Training and ~~c~~Checking – ~~Low Visibility Operations~~ **LVO****

- (1)a. ~~An~~ **The operator must** ~~should~~ ensure that, in conjunction with the normal recurrent training and ~~operator~~ **operator's** proficiency checks, ~~a~~ **the pilot's** knowledge and ability to perform the tasks associated with the particular category of operation, for which ~~he/she~~ **the pilot** is authorised **by the operator**, is checked. The required number of approaches to be undertaken in the ~~Flight Simulator~~ **FSTD** within the validity period of the operator's proficiency check (~~as prescribed in OPS 1.965 (b)~~) ~~is to~~ **should** be a minimum of ~~2two, (respectively 4four~~ when HUDLS and/or EVS is utilised to touchdown), one of which ~~must~~ **should** be a landing at the lowest approved RVR. ~~In addition one, respectively (2two for HUDLS and/or operations utilising EVS),~~ of these approaches may be substituted by an approach and landing in the ~~aeroplane~~ **aircraft** using approved ~~Category II~~ **CAT II** and **CAT III** procedures. One missed approach ~~shall~~ **should** be flown during the conduct of ~~the operator~~ **an operators** proficiency check. If ~~the operator~~ **the operator** is ~~authorised~~ **approved** to conduct take-off with RVR less than 150 ~~/200~~ m at least one LVTO to the lowest applicable minima ~~shall~~ **should** be flown during the conduct of the operator's proficiency check.
- (2)b. For ~~Category III~~ **CAT III** operations ~~an operator~~ **the operator must** ~~should~~ use ~~an Flight Simulator~~ **FSTD approved for this purpose.**
- (3)c. ~~An operator~~ **F** ~~must ensure that,~~ for ~~Category III~~ **CAT III** operations on ~~aeroplanes~~ **aircraft** with a fail-passive flight control system, including HUDLS, a missed approach ~~is~~ **should be** completed **by each flight crew member** at least once over the period of three consecutive operator proficiency checks as

Subpart E | Revised rule text

the result of an autopilot failure at or below ~~decision height~~**DH** when the last reported RVR was 300 m or less.

~~(4) The Authority may authorise recurrent training and checking for Category II and LVTO operations in an aeroplane type where no Flight Simulator to represent that specific aeroplane or an acceptable alternate is available.~~

Comment [WSI66]:
Deleted in the interest of safety.

~~Note: Recency for LVTO and Category II/III based upon automatic approaches and/or auto lands is maintained by the recurrent training and checking as prescribed in this paragraph.~~

Comment [WSI67]:
Deleted because it is GM.

LTS CAT I, OTS CAT II, OPERATIONS UTILISING EVS

~~(h)8. Additional tTraining sRequirements tandards for Operators conducting Lower than Standard Category I, Approaches utilising EVS and Other than Standard Category II Operations.~~

~~(1)~~a. General

Operators conducting ~~Lower than Standard Category I~~**LTS CAT I operations, OTS CAT II operations and operations utilising EVS with RVR of 800 m or less shall** ~~should~~ comply with the ~~standards~~ requirements of Appendix 1 to OPS 1.450 — Low Visibility Operations — Training & Qualifications applicable to ~~Category II~~**CAT II operations and** to include the requirements ~~standards~~ applicable to HUDLS, (if appropriate). ~~The operator~~**The operator** may combine these additional requirements ~~standards~~ where appropriate provided that the operational procedures are compatible.

b. LTS CAT I

During conversion training the total number of approaches ~~required~~ **shall** ~~should~~ not be additional to the requirements of ~~OR.OPS.FCOPS Subpart N~~ provided the training is conducted utilising the lowest applicable RVR. During recurrent training and checking ~~the operator~~**the operator** may also combine the separate requirements provided the above operational procedure ~~requirement~~ **standard** is met, ~~provided that~~ **and** at least one approach using ~~Lower than Standard Category I~~**LTS CAT I** minima is conducted at least once every 18 months.

~~(2)~~c. OTS CAT II

~~Operators conducting Other than Standard Category II operations shall comply with the requirements of Appendix 1 to OPS 1.450 — Low Visibility Operations — Training & Qualifications applicable to Category II operations to include the requirements applicable to HUDLS (if appropriate). The operator may combine these additional requirements where appropriate provided that the operational procedures are compatible.~~ During conversion training the total number of approaches ~~required~~ **shall** ~~should~~ not be less than ~~that required~~ **those** to complete ~~Category II~~**CAT II** training utilising a HUD/HUDLS. During recurrent training and checking ~~the operator~~**the operator** may also combine the separate requirements ~~standards~~ provided the above operational procedure requirement is met **and**, ~~provided that~~ at least one approach using ~~Other than Standard Category II~~**OTS CAT II** minima is conducted at least once every 18 months.

Subpart E | Revised rule text

~~(3)c. Operators conducting Approach-O~~ Operations utilising EVS with RVR of 800 m or less

~~shall comply with the requirements of Appendix 1 to OPS 1.450—Low Visibility Operations—Training & Qualifications applicable to Category II operations to include the requirements applicable to HUD (if appropriate). The operator may combine these additional requirements where appropriate provided that the operational procedures are compatible. During conversion training the total number of approaches required shall~~**should** ~~not be less than that required to complete Category II~~**CAT II** ~~training utilising a HUD. During recurrent training and checking the operator~~**the operator** ~~may also combine the separate requirements—standards~~ provided the above operational procedure requirement—**standard** is met **and** ~~—provided that~~ at least one approach utilising EVS is conducted at least once every 12 months.

AMC1-SPA.LVO.125~~Appendix 1 to OPS 1.455 Low Visibility Operations—~~
Operating procedures

GENERAL

~~(a)~~**1. General. Low Visibility OperationsLVOs should** include:

~~(1)~~**a. m**Manual take-off, (with or without electronic guidance systems or HUDLS/~~h~~**h**Hybrid HUD/HUDLS);

~~b.(2)~~**a**Auto-coupled approach to below DH, with manual flare, landing and roll-out;

~~(3)~~**a**Approach flown with the use of a HUDLS/~~h~~**h**Hybrid HUD/HUDLS and/or EVS);

c. auto-coupled approach to below DH, with manual flare, hover, landing and rollout;

~~(4)~~**d.a**Auto-coupled approach followed by auto-flare, **hover**, auto—landing and manual roll-out**rollout**; and

~~(5)~~**e.a**Auto-coupled approach followed by auto-flare, **hover**, auto—landing and auto-roll-out**rollout**, when the applicable RVR is less than 400 m.

~~Note 1: A hybrid system may be used with any of these modes of operations.~~

~~Note 2: Other forms of guidance systems or displays may be certificated and approved.~~

Comment [WSI68]:
Nature of a Guidance Material.

Procedures and instructions

~~(b)~~**2. The operator should specify detailed operating procedures and instructions in the operations manual.** ~~Procedures and Operating Instructions~~

~~(1)~~**a.**The precise nature and scope of procedures and instructions given **should** depend upon the airborne equipment used and the flight deck procedures followed. ~~An—~~**The** operator ~~must~~**should** clearly define flight crew member duties during take-off, approach, flare, **hover**, ~~roll-out~~**rollout** and missed approach in the ~~Operations Manual~~**operations manual**. Particular emphasis ~~must~~**should** be placed on flight crew responsibilities during transition from non-visual conditions to visual conditions, and on the procedures to be used in deteriorating visibility or when failures occur. Special attention ~~must~~**should** be paid to the distribution of flight deck duties so as to ensure that the workload

Subpart E | Revised rule text

of the pilot making the decision to land or execute a missed approach enables him/her to devote himself/herself to supervision and the decision making process.

~~(2)~~**b.** ~~An operator must specify the detailed operating procedures and instructions in the Operations Manual. The instructions must~~**should** be compatible with the limitations and mandatory procedures contained in the ~~Aeroplane Flight Manual~~**AFM** and cover the following items in particular:

Comment [WSI69]:
Already mentioned above.

- ~~(i)~~**i.** ~~c~~**Checks** for the satisfactory functioning of the ~~aeroplane~~**aircraft** equipment, both before departure and in flight;
- ~~(ii)~~**ii.** ~~e~~**Effect** on minima caused by changes in the status of the ground installations and airborne equipment;
- ~~(iii)~~**iii.** ~~p~~**Procedures** for the take-off, approach, flare, **hover**, landing, ~~roll-out~~**rollout** and missed approach;
- ~~(iv)~~**iv.** ~~p~~**Procedures** to be followed in the event of failures, warnings to include HUD/HUDLS/EVS and other non-normal situations;
- ~~(v)~~**v.** ~~t~~**The** minimum visual reference required;
- ~~(vi)~~**vi.** ~~t~~**The** importance of correct seating and eye position;
- ~~(vii)~~**vii.** ~~a~~**Action** ~~which~~**that** may be necessary arising from a deterioration of the visual reference;
- ~~(viii)~~**viii.** ~~a~~**Allocation** of crew duties in the carrying out of the procedures according to ~~subparagraphs 2.b.(i) i. to (iv) iv. and (vi) vi.~~ above, to allow the **pilot-in-command/c**ommander to devote himself/herself mainly to supervision and decision making;
- ~~(ix)~~**ix.** ~~t~~**The** requirement for all height calls below 200 ft to be based on the radio altimeter and for one pilot to continue to monitor the ~~aeroplane~~**aircraft** instruments until the landing is completed;
- ~~(x)~~**x.** ~~t~~**The** requirement for the ~~I~~**Localiser** ~~s~~**Sensitive** ~~a~~**Area** to be protected;
- ~~(xi)~~**xi.** ~~t~~**The** use of information relating to wind velocity, wind shear, turbulence, runway contamination and use of multiple RVR assessments;
- ~~(xii)~~**xii.** ~~p~~**Procedures** to be used for:
 - ~~(A)~~**A.** ~~Lower than Standard Category~~**ILTS CAT I**;
 - ~~(B)~~**B.** ~~Other than Standard Category~~**HOTS CAT II**;
 - ~~(C)~~**C.** ~~a~~**Approach** ~~operations~~**es** utilising EVS; and
 - ~~(D)~~**D.** ~~p~~**Practice** approaches and landing on runways at which the full ~~Category II~~**CAT II** or ~~Category III~~**CAT III** aerodrome procedures are not in force;
- ~~(xiii)~~**xiii.** ~~o~~**Operating** limitations resulting from airworthiness certification; and
- ~~(xiv)~~**xiv.** ~~i~~**Information** on the maximum deviation allowed from the ILS glide path and/or localiser.

Appendix 1 to OPS 1.465
Minimum Visibilities for VFR Operations

Comment [WSI70]:
Deleted because should be in Part-SERA. Verification of EC requested.

Subpart E | Revised rule text

Airspace class		A B C D E (Note 1)	F G
			Above 900 m (3 000 ft) AMSL or above 300 m (1 000 ft) above terrain, whichever is the higher
			At and below 900 m (3 000 ft) AMSL or 300 m (1 000 ft) above terrain, whichever is the higher
Distance from cloud		1 500 m horizontally 300 m (1000 ft) vertically	Clear of cloud and in sight of the surface
Flight visibility		8 km at and above 3 050 m (10 000 ft) AMSL (Note 2) 5 km below 3 050 m (10 000 ft) AMSL	5 km (Note 3)

Note 1: VMC Minima for Class A airspace are included for guidance but do not imply acceptance of VFR Flights in Class A airspace

Note 2: When the height of the transition altitude is lower than 3 050 m (10 000 ft) AMSL, FL 100 should be used in lieu of 10 000ft.

Note 3: Cat A and B aeroplanes may be operated in flight visibilities down to 3 000 m, provided the appropriate ATS authority permits use of a flight visibility less than 5 km, and the circumstances are such, that the probability of encounters with other traffic is low, and the IAS is 140 kt or less.

Subpart E | Revised rule text

[09]Part-CAT

Subpart B - Operating procedures

AMC1-CAT.OP.AH.310(d) Commencement and continuation of approach

VISUAL REFERENCES FOR INSTRUMENT APPROACH OPERATIONS

1. NPA, APV and CAT I operations

At DH or MDH, at least one of the visual references specified below should be distinctly visible and identifiable to the pilot:

- a. elements of the approach light system;
- b. the threshold;
- c. the threshold markings;
- d. the threshold lights;
- e. the threshold identification lights;
- f. the visual glide slope indicator;
- g. the touchdown zone or touchdown zone markings;
- h. the touchdown zone lights;
- i. runway edge lights; or
- j. other visual references specified in the operations manual.

2. LTS CAT I operations

At DH, the visual references specified below should be distinctly visible and identifiable to the pilot:

- a. a segment of at least three consecutive lights, being the centreline of the approach lights, or touchdown zone lights, or runway centreline lights, or runway edge lights, or a combination of these;
- b. this visual reference should include a lateral element of the ground pattern, such as an approach light crossbar or the landing threshold or a barrette of the touchdown zone light unless the operation is conducted utilising an approved HUDLS usable to at least 150 ft.

3. CAT II or OTS CAT II operations

At DH, the visual references specified below should be distinctly visible and identifiable to the pilot:

- a. a segment of at least three consecutive lights being the centreline of the approach lights, or touchdown zone lights, or runway centreline lights, or runway edge lights, or a combination of these;
- b. this visual reference should include a lateral element of the ground pattern, such as an approach light crossbar or the landing threshold or a barrette of the touchdown zone light unless the operation is conducted utilising an approved HUDLS to touchdown.

4. CAT III operations

Subpart E | Revised rule text

- a. For CAT IIIA operations and for CAT IIIB operations conducted either with fail-passive flight control systems or with the use of an approved HUDLS: at DH, a segment of at least three consecutive lights being the centreline of the approach lights, or touchdown zone lights, or runway centreline lights, or runway edge lights, or a combination of these is attained and can be maintained by the pilot.
 - b. For CAT IIIB operations conducted either with fail-operational flight control systems or with a fail-operational hybrid landing system using a DH: at DH, at least one centreline light is attained and can be maintained by the pilot.
 - c. For CAT IIIB operations with no DH there is no requirement for visual reference with the runway prior to touchdown.
5. Approach operations utilising EVS
- a. At DH or MDH, the following visual references should be displayed and identifiable to the pilot on the EVS:
 - i. elements of the approach light; or
 - ii. the runway threshold, identified by at least one of the following: the beginning of the runway landing surface, the threshold lights, the threshold identification lights; and the touchdown zone, identified by at least one of the following: the runway touchdown zone landing surface, the touchdown zone lights, the touchdown zone markings or the runway lights.
 - b. At 100 ft above runway threshold elevation at least one of the visual references specified below should be distinctly visible and identifiable to the pilot without reliance on the EVS:
 - i. the lights or markings of the threshold; or
 - ii. the lights or markings of the touchdown zone.

Subpart B - Operating procedures – AMC/GM

GAMC1-CAT.OP.AH.110.A Aerodrome operating minima

Comment [WSI71]:
Source: ACJ to Appendix 1 to JAR-OPS 1.430, paragraph (j)

CIRCLING – AEROPLANES

...

1. ~~Visual Manoeuvring (circling)~~

The purpose of this ACJ guidance material is to provide operators with supplemental information regarding the application of aerodrome operating minima in relation to circling approaches. 2. Conduct of flight – gGeneral:

2.1.a. ~~t~~The Minimum Descent Height (MDH) and Obstacle Clearance Height (OCH) included in the procedure are referenced to aerodrome elevation;

2.2.b. ~~t~~The Minimum Descent Altitude (MDA) is referenced to mean sea level;

2.3.c. ~~f~~For these procedures, the applicable visibility is the meteorological **visibility**; and

d. ~~o~~**Operators should all provide tabular guidance of the relationship between height above threshold and the in-flight visibility (VIS) required to obtain and sustain visual contact during the circling manoeuvre.**

3.3.4. Instrument approach followed by visual manoeuvring (circling) without prescribed tracks

3.1.a. ~~When the aeroplane is on the initial instrument approach, before visual reference is stabilised, but not below MDH/MDA/H - the aeroplane should follow the corresponding instrument approach procedure until the appropriate instrument Missed Approach Point (MAPt) is reached.~~

3.2.b. At the beginning of the level flight phase at or above the MDH/MDA/H, the instrument approach track determined by radio navigation aids, RNAV, RNP or **ILS, MLS, GLS, XLS** should be maintained until **the pilot:**

a. ~~The~~ **i.** ~~the pilot~~ estimates that, in all probability, visual contact with the runway of intended landing or the runway environment will be maintained during the entire circling procedure; and

b. ~~The~~ **ii.** ~~the pilot~~ estimates that the aeroplane is within the circling area before commencing circling; and

c. ~~The~~ **iii.** ~~the pilot~~ is able to determine the aeroplane's position in relation to the runway of intended landing with the aid of the appropriate external references.

3.3.c. When reaching the published instrument MAPt and the conditions stipulated in paragraph 3.2 above, **3.4.b.7** are unable to be established by the pilot, a missed approach should be carried out in accordance with that instrument approach procedure. See paragraph 5.

3.4.d. After the aeroplane has left the track of the initial (~~letdown~~) instrument approach, the flight phase outbound from the runway should be limited to an

Subpart E | Revised rule text

appropriate distance, which is required to align the aeroplane onto the final approach. Such manoeuvres should be conducted to enable the aeroplane:

- a. ~~To~~ **to** attain a controlled and stable descent path to the intended landing runway; and
- b. ~~Remain~~ **remain** within the circling area and in such way that visual contact with the runway of intended landing or runway environment is maintained at all times.†

~~3.5e.~~ Flight manoeuvres should be carried out at an altitude/height that is not less than the circling ~~MDH/MDA/~~**H**.†

~~3.6f.~~ Descent below ~~MDH/MDA/~~**H** should not be initiated until the threshold of the runway to be used has been appropriately identified ~~and the~~. **The** aeroplane **should be** ~~is~~ in a position to continue with a normal rate of descent and land within the touchdown zone.

445. Instrument approach followed by a visual manoeuvring (circling) with prescribed track†

~~4.1a.~~ The aeroplane should remain on the initial instrument approach ~~or letdown~~ procedure until one of the following is reached:

- ai. ~~t~~ The prescribed divergence point to commence circling on the prescribed track; or
- bii. ~~t~~ The ~~appropriate initial instrument~~ ~~MAPt~~.†

~~4.2b.~~ The aeroplane should be established on the instrument approach track determined by the radio navigation aids, RNAV, RNP, or **ILS, MLS, GLS** ~~MLS~~ in level flight at or above the ~~MDH/MDA/~~**H** at or by the circling manoeuvre divergence point.†

~~4.3c.~~ If the divergence point is reached before the required visual reference is acquired, a missed approach should be initiated not later than the ~~initial instrument approach~~ ~~MAPt~~ and completed in accordance with the ~~initial instrument approach~~ procedure.†

~~4.4d.~~ When commencing the prescribed ~~track~~-circling manoeuvre at the published divergence point, the subsequent manoeuvres should be conducted to comply with the published routing and ~~promulgated~~ **published** heights/altitudes.†

~~4.5e.~~ Unless otherwise specified, once the aeroplane is established on the prescribed track(s), the ~~promulgated~~ **published** visual reference ~~should~~ **does not need** ~~be required to be maintained unless:~~

- a. ~~Required~~ **required** by the ~~Authority~~; **State of the aerodrome; or**
- b. ~~The~~ **ii. the c** Circling MAPt (if published) is reached.†

~~4.6f.~~ If the prescribed ~~track~~-circling manoeuvre has a published MAPt and the required visual reference has not been obtained **by that point**, a missed approach should be executed in accordance with ~~5 paragraphs 5.26.b. and 5.3 below~~ **6.c.**†

~~4.7g.~~ Subsequent further descent below ~~MDH/MDA/~~**H** should only commence when the required visual reference ~~is~~ **has been** obtained.†

Subpart E | Revised rule text

~~4.8h.~~ Unless otherwise specified in the procedure, final descent should not be initiated ~~commenced~~ from MDH/MDA/H until the threshold of the intended landing runway has been appropriately identified and the aeroplane is in a position to continue with a normal rate of descent ~~and to land within the~~ touchdown zone.

556. Missed approach

~~5.1a.~~ Missed ~~Approach~~ **approach** during ~~the Instrument Approach~~ **instrument procedure** prior to ~~Circling~~ **circling**:

- ~~ai.~~ ~~If the decision to carry out a missed approach~~ **procedure is required to be flown** ~~taken~~ when the aeroplane is positioned on the instrument approach track defined by radio-navigation aids RNAV, RNP, or ~~LSILS, MLS, and before commencing the circling manoeuvre, the published missed approach for the instrument approach should be followed;~~ **or**
- ~~bii.~~ ~~If the instrument approach procedure is carried out with the aid of an LSILS, MLS or Stabilised Approach (an stabilised approach (SAp)), the (MAPt) associated with an LSILS, MLS procedure without glide path (GP-out procedure) or the SAp, where applicable, should be used.~~

~~5.2b.~~ If a prescribed missed approach is published for the circling manoeuvre, this overrides the manoeuvres prescribed below.

~~5.3c.~~ If visual reference is lost while circling to land after the aeroplane has departed from the initial instrument approach track, the missed approach specified for that particular instrument approach should be followed. It is expected that the pilot will make an initial climbing turn toward the intended landing runway **to a position** ~~and continue~~ overhead the aerodrome where the pilot will establish the aeroplane in a climb on the instrument missed approach ~~track.~~ **segment.**

~~5.4d.~~ The aeroplane should not leave the visual manoeuvring (circling) area, which is obstacle protected, unless:

- ~~a.~~ ~~Established~~ **established** on the appropriate missed approach ~~track~~ **procedure**; or
- ~~b.~~ ~~At~~ **at** ~~m~~ **Minimum s** ~~Sector a~~ **Altitude (MSA).**

~~5.5e.~~ All turns should ~~(see Note 1 below)~~ be made in the same direction and the aeroplane should remain within the circling protected area while climbing to either:

- ~~a.~~ ~~The~~ **the** altitude assigned to any published circling missed approach manoeuvre if applicable;
- ~~b.~~ ~~The~~ **the** altitude assigned to the missed approach of the initial instrument approach;
- ~~c.~~ ~~The~~ **the** ~~Minimum Sector Altitude (MSA);~~
- ~~d.~~ ~~The~~ **the** ~~m~~ **Minimum- h** ~~A~~ **Altitude (MHA)** applicable for transition to a holding facility or fix, or continue to climb to ~~an MSA~~ **Minimum Safe Altitude**; or
- ~~e.~~ ~~As~~ **as** directed by ~~ATS/Control (C).~~

Subpart E | Revised rule text

~~Note: 1. When the go-around~~ **missed approach procedure** is commenced on the “downwind” leg of the circling manoeuvre, an “S” turn may be undertaken to align the aeroplane on the initial instrument approach missed approach path, provided the aeroplane remains within the protected circling area.

~~Note: 2. The commander should be responsible for ensuring adequate terrain clearance during the above-stipulated manoeuvres, particularly during the execution of a missed approach initiated by ATS.~~

~~5.6f. In as much as~~ **Because** the circling manoeuvre may be accomplished in more than one direction, different patterns will be required to establish the aeroplane on the prescribed missed approach course depending on its position at the time visual reference is lost. In particular, all turns are to be in the prescribed direction if this is restricted, e.g. to the west/east (left or right hand) to remain within the protected circling area.

~~5.7g. If a missed approach procedure is promulgated~~ **published** for the ~~a particular runway (XX)~~ onto which the aeroplane is conducting a circling approach and the aeroplane has commenced a manoeuvre to align with the runway, the missed approach for this direction may be accomplished. The ATS **unit** should be informed of the intention to fly the ~~promulgated~~ **published** missed approach procedure for **that particular** runway ~~XX~~.

~~5.8. When the option described in paragraph 5.7 above is undertaken the commander should whenever possible, advise at the earliest opportunity, the ATS(C) of the intended go-around procedure. This dialogue should, if possible occur during the initial approach phase and include the intended missed approach to be flown and the level off altitude.~~

~~5.9h. In addition to 5.8 above,~~ **The commander should advise ATS(C) when any go-around missed approach procedure has been commenced, the height / altitude the aeroplane is climbing to and the position the aeroplane is proceeding towards and / or heading the aeroplane is established on.**

Comment [WSI72]:
Transposed from GM4
OPS.GEN.150.H

GM2-CAT.OP.AH.110 Aerodrome operating minima

ONSHORE AERODROME DEPARTURE PROCEDURES – HELICOPTERS

The cloud base and visibility should be such as to allow the helicopter to be clear of cloud at ~~t~~Take-off ~~d~~Decision ~~p~~Point (TDP), and for the pilot flying to remain in sight of the surface until reaching the minimum speed for flight in instrument meteorological conditions **(IMC)** given in the AFM.

GM3-CAT.OP.AH.110 Aerodrome operating minima

APPROACH LIGHT SYSTEMS – ICAO, FAA

The following table provides a comparison of ICAO and FAA specifications.

Table 1: Approach light systems

Class of lighting facility	Length, configuration and intensity of approach lights
----------------------------	--

Subpart E | Revised rule text

FALS	<p>ICAO: CAT I light system (HIALS \geq 900 m) distance coded centreline, Barrette centreline</p> <p>FAA: ALSF1, ALSF2, SSALR, MALSR, high or medium intensity and/or flashing lights, 720 m or more</p>
IALS	<p>ICAO: simple approach light system (HIALS 420 – 719 m) single source, Barrette</p> <p>FAA: MALSF, MALS, SALS/SALSF, SSALF, SSALS, high or medium intensity and/or flashing lights, 420 – 719 m</p>
BALS	<p>Any other approach light system (HIALS, MIALS or ALS 210-419 m)</p> <p>FAA: ODALS, high or medium intensity or flashing lights 210 - 419 m</p>
NALS	<p>Any other approach light system (HIALS, MIALS or ALS <210 m) or no approach lights</p>

Note: **ALSF:** approach lighting system with sequenced flashing lights;
MALS: medium intensity approach light system;
MALSF: medium intensity approach lighting system with sequenced flashing lights;
MALSR: medium intensity approach lighting system with runway alignment indicator lights;
ODALS: omnidirectional approach lighting system;
SALS: simple approach lighting system;
SALSF: short approach lighting system with sequenced flashing lights;
SSALF: simplified short approach lighting system with sequenced flashing lights; **SSALR:** simplified short approach lighting system with runway alignment indicator lights;
SSALS: simplified short approach lighting system.

GM1-CAT.OP.AH.110(c) Aerodrome operating minima**INCREMENTS SPECIFIED BY THE COMPETENT AUTHORITY**

Additional increments to the published minima may be specified by the competent authority to take into account special operations, such as downwind approaches and single-pilot operations.

GM1-CAT.OP.AH.115 Approach flight technique - aeroplanes

Comment [WSI73]:
Source: ACJ OPS 1.430

CONTINUOUS DESCENT FINAL APPROACH (CDFA)

1. Introduction†

~~1.1a.~~ Controlled-flight-into-terrain (CFIT) is a major **hazard in** causal category of accident and hull loss in commercial aviation. Most CFIT accidents occur in the final approach segment of non-precision approaches; the use of stabilised-

Subpart E | Revised rule text

approach criteria on a continuous descent with a constant, pre-determined vertical path is seen as a major improvement in safety during the conduct of such approaches. Operators should ensure that the following techniques are adopted as widely as possible, for all approaches.

- 1.2b.** The elimination of level flight segments at ~~Minimum Descent Altitude (MDA)~~ close to the ground during approaches, and the avoidance of major changes in attitude and power/~~thrust~~ close to the runway which can destabilise approaches, are seen as ways to reduce operational risks significantly.
- ~~c1.3c.~~ For completeness this ~~ACJ guidance~~ also includes criteria which should be considered to ensure the stability of an approach (in terms of the aeroplane's ~~aeroplanes~~ energy and approach path control).
- 1.4d.** The term ~~Continuous Descent Final Approach (CDFA)~~ has been selected to cover a technique for any type of non-precision approach.
- ~~d1.5e.~~ Non-precision approaches operated other than using a constant ~~pre-determined~~ **pre-determined** vertical path or when the facility requirements and associated conditions do not meet the conditions specified in **AMC1-CAT.OP.115 1. and Para 2.4 below**, RVR penalties apply. However, this should not preclude ~~an operator~~ **an operator** from applying CDFA technique to such approaches. Those operations should be classified as special ~~letdown~~ **let down** procedures, since it has been shown that such operations, flown without additional training, may lead to inappropriately steep descent to the MDA(~~/H~~), with continued descent below the MDA(~~/H~~) in an attempt to gain (adequate) visual reference. **(s).**
- e1.6f.** The advantages of CDFA are **as follows:**
- ai.** ~~t~~The technique enhances safe approach operations by the utilisation of standard operating practices;
 - ~~bii.~~ The profile reduces the probability of infringement of obstacle clearance along the final approach segment and allows the use of MDA as DA;
 - eiii.** ~~t~~The technique is similar to that used when flying an ILS approach, including when executing the missed approach and the associated ~~go-around~~ **missed approach procedure** manoeuvre;
 - ~~diiiv.~~ ~~t~~The aeroplane attitude may enable better acquisition of visual cues;
 - iev.** ~~t~~The technique may reduce pilot workload;
 - fvi.** ~~t~~The ~~a~~Approach profile is fuel-efficient;
 - gvii.** ~~t~~The ~~a~~Approach profile affords reduced noise levels;
 - ~~hviiv.~~ ~~t~~The technique affords procedural integration with APV approach operations; **and**
 - ~~viiiix.~~ ~~w~~When used and the approach is flown in a stabilised manner, **CDFA is the safest approach technique for all approach operations.**
2. CDFA ~~(Continuous Descent Final Approach)~~
- ~~2.1a.~~ Continuous ~~d~~Descent ~~f~~Final ~~a~~Approach **is defined in Annex I to the Cover Regulation Air Operations.** A specific technique for flying the final approach

Subpart E | Revised rule text

~~segment of a non-precision instrument approach procedure as a continuous descent, without level-off, from an altitude/height at or above the final approach fix altitude/height to a point approximately 15m (50 ft) above the landing runway threshold or the point where the flare manoeuvre should begin for the type of aircraft flown.~~

~~2.2b.~~ An approach is only suitable for application of **a** CDFA technique when it is flown along a ~~predetermined~~ **pre-determined** vertical **approach** slope (see sub-paragraph (a) below) which follows a designated or nominal vertical profile (see sub-paragraphs (b) and (c) below):

~~a.~~ ~~Predetermined Approach Slope:~~ Either the designated or nominal vertical profile of an approach:

- ~~i.~~ ~~d~~ **Designated v** ~~Vertical p~~ **Profile:** ~~a~~ **A** continuous vertical approach profile which forms part of the approach procedure design. APV is considered to be an approach with a designated vertical profile; ~~or a~~
- ~~ii.~~ ~~n~~ **Nominal v** ~~Vertical p~~ **Profile:** ~~a~~ **A** vertical profile not forming part of the approach procedure design, but which can be flown as a continuous descent.

~~Note:~~ The nominal vertical profile information may be published or displayed (on the approach chart) to the pilot by depicting the nominal slope or range/distance vs. height. Approaches with a nominal vertical profile are considered to be:

- ~~a.~~ **A.** NDB, NDB/DME;
- ~~b.~~ **B.** VOR, VOR/DME;
- ~~c.~~ **C.** LOC, LOC/DME;
- ~~d.~~ **D.** VDF, SRA; or
- ~~e.~~ **E.** RNAVGNSS/LNAV.

~~2.3~~ ~~c.~~ **Stabilised a** ~~Approach (SAP) is defined in Annex I to the Cover Regulation Air Operations.~~ An approach which is flown in a controlled and appropriate manner in terms of configuration, energy and control of the flight path from a pre-determined point or altitude/height down to a point 50 feet above the threshold or the point where the flare manoeuvre is initiated if higher:

- ~~ai.~~ The control of the descent path is not the only consideration when using the CDFA technique. Control of the aeroplane's configuration and energy is also vital to the safe conduct of an approach.
- ~~bii.~~ The control of the flight path, described above as one of the requirements for conducting an SAP, should not be confused with the path requirements for using the CDFA technique. The ~~pre-determined~~ **pre-determined** path requirements for conducting **an** SAP are established by the operator and published in the ~~Operations Manual (OM) Part~~ **operations manual part B**; guidance for conducting SAP operations is given in paragraph 5 below.
- ~~ei.~~ The ~~predetermined~~ **pre-determined** approach slope requirements for applying the CDFA technique are established by **the following**:

Subpart E | Revised rule text

- ~~iA.~~ ~~t~~The instrument-procedure design when the approach has a designated vertical profile;
 - ~~iiB.~~ ~~t~~The published 'nominal' slope information when the approach has a nominal vertical profile; **and**
 - ~~iiC.~~ ~~t~~The designated final-approach segment minimum of ~~3nm3 nmNM~~, and maximum, when using timing techniques, of ~~8nm8 nmNM~~.
- ~~div.~~ An ~~Stabilised Approach~~ **SAP** will never have any level segment of flight at DA(H) (or MDA(H) as applicable). This enhances safety by mandating a prompt ~~go-around~~ **missed approach procedure** manoeuvre at DA(H) (or MDA(H)).
- ~~ev.~~ An approach using the CDFA technique will always be flown as an SAP, since this is a requirement for applying CDFA. ~~H~~However, an SAP does not have to be flown using the CDFA technique, for example a visual approach.

AMC1-CAT.OP.AH.115 Approach flight technique - aeroplanes

Comment [WSI74]:
Source: ACJ OPS 1.430

CONTINUOUS DESCENT FINAL APPROACH (CDFA)

~~1.2.4d.~~ Approach with a designated vertical profile using the CDFA technique:

- ~~aa~~~~i.~~ The optimum angle for the approach slope is ~~3-degrees°~~, and the gradient should preferably not exceed ~~6.511% percent~~ which equates to a slope of ~~3.775-degrees°~~, (400-~~372~~ ft/~~NmnmNM~~) for procedures intended for conventional aeroplane types ~~or/~~ classes and/or operations. ~~In any case, conventional approach slopes should be limited to 4.5 degrees for Category A and B aeroplanes and 3.77 degrees for Category C and D aeroplanes, which are the upper limits for applying the CDFA technique. A 4.5-degree approach slope is the upper limit for certification of conventional aeroplanes.~~
- ~~bb~~~~ii.~~ The approach is to be flown utilising operational flight techniques and ~~onboard~~ **on board** navigation system(s) and navigation aids to ensure it can be flown on the desired vertical path and track in a stabilised manner, without significant vertical path changes during the final-segment descent to the runway. APV is included.
- ~~cc~~~~iii.~~ The approach is flown to a DA(H).
- ~~dd~~~~iv.~~ No MAPt is published for these procedures.

~~2.2.5e.~~ Approach with a nominal vertical profile using the CDFA technique:

- ~~aa~~~~i.~~ The optimum angle for the approach slope is ~~3-degrees°~~, and the gradient should preferably not exceed ~~6.5 percent%~~ which equates to a slope of ~~3.77 degrees°~~, (400 ft/~~NmnmNM~~) for ~~procedures intended for conventional aeroplane types / class and / or operations. In any case, conventional approaches should be limited to 4.5 degrees for Category A and B aeroplanes and 6.1%, which equates to a slope of 3.53.77 degrees° for Category C and D aeroplanes, which are the upper limits for applying CDFA technique. A 4.5-degree approach slope is the upper limit for certification of conventional aeroplanes.~~

Subpart E | Revised rule text

~~bi.~~ The approach **procedure** should meet at least the following facility requirements and associated conditions ~~—(NDB, NDB/DME, VOR, VOR/DME, LOC, LOC/DME, VDF, SRA, RNAV{/LNAV) and fulfil the following criteria with a procedure which fulfils~~ **and fulfil** the following criteria:

~~ii.~~ **A.** ~~t~~The final approach track off-set is ~~≤ -5 degrees~~ **≤ -5 degrees**^o except for Category A and B aeroplanes, where the approach-track off-set is ~~≤ -15 degrees~~; and

~~iii.~~ **B.** ~~a~~A FAF, or another appropriate fix where descent is initiated is available; and

~~iiii.~~ **C.** ~~t~~The distance from the FAF to the **Threshold (THR)** is less than or equal to 8 ~~NM~~ **Nm** in the case of timing; or

~~v.~~ **D.** ~~t~~The distance to the ~~threshold~~ **(THR)** is available by FMS/RNAV or DME; or

~~vi.~~ **E.** ~~t~~The minimum final-segment of the designated constant angle approach path should ~~not be less than 3 NM~~ **3 Nm** from the THR unless **otherwise** approved by the **competent Authority**. ~~authority.~~

~~ci.~~ CDFA may also be applied utilising the following:

~~ii.~~ **A.** RNAV **GNSS**/LNAV with altitude/height cross checks against positions or distances from the THR; or

~~iii.~~ **B.** Height crosscheck compared with DME distance values. ~~.~~

~~di.~~ The approach is flown to a DA{/H}; **it may be necessary to apply an add-on to the published minima to ensure obstacle clearance. The add-on, if applicable, should be specified in the operations manual – (aerodrome operating minima).**

~~ei.~~ The approach is flown as an SAp.

~~Note:~~ Generally, ~~an~~ MAPt is published for these procedures.

3. Operational Procedures ~~procedures:~~

~~3.1~~ **Aa.** ~~An~~ MAPt should be specified to apply CDFA with a nominal vertical profile as for any non-precision approach. ~~.~~

~~3.2b.~~ The flight techniques associated with CDFA employ ~~the use of a predetermined~~ **pre-determined** approach slope. The approach, in addition, is flown in a stabilised manner, in terms of configuration, energy and control of the flight path. The approach should be flown to a DA{/H} at which the decision to land or ~~go around~~ **missed approach procedure** is made immediately. This approach technique should be used when conducting **all NPAs meeting the specified CDFA criteria in 1. and 2. above:**

~~a.~~ All non-precision approaches (NPA) ~~i. all NPAs meeting the specified CDFA criteria in Para 2.4; d., and~~

~~ii.~~ ~~b.~~ All ~~all~~ approaches categorised as APV. ~~.~~

~~3.3c.~~ The flight techniques and operational procedures prescribed above should always be applied; in particular with regard to control of the descent path and the stability of the aeroplane on the approach prior to reaching MDA{/H}. Level flight at MDA{/H} should be avoided as far as practicable. In addition

Subpart E | Revised rule text

appropriate procedures and training should be established and implemented to facilitate the applicable elements of ~~paragraphs 4.7, 5. and 8.6.~~ Particular emphasis should be placed on ~~subparagraphs 4.8, h., 5.1a. to 5.7g. and 8.4.d.~~

- ~~3.4d.~~ In cases where the CDFA technique is not used with a high MDA(H), it may be appropriate to make an early descent to MDA(H) with appropriate safeguards to include the above training requirements, as applicable, and the application of a significantly higher RVR/~~visibility.~~
- ~~3.5e.~~ For Circling Approaches **circling approaches (visual manoeuvring)**, all the applicable criteria with respect to the stability of the final descent path to the runway should apply, **as follows:-**
- ~~i.~~ In particular, ~~T~~the control of the desired final nominal descent path to the threshold should be conducted to facilitate the techniques described in ~~paragraphs 4. and 5 of this ACJ.~~
 - ~~aii.~~ Stabilisation during the final ~~straight-in segment for a~~ **of the instrument approach used to reach the circling approach should MDA/H should** ideally be accomplished by 1 000 ft above aerodrome elevation for turbo-jet aeroplanes.
 - ~~biiii.~~ For a circling approach where the landing runway threshold and appropriate visual landing aids may be visually acquired from a point on the designated or published procedure (prescribed tracks), stabilisation should be achieved not later than 500 ft above aerodrome elevation. It is however recommended that the aeroplane be stabilised when passing 1 000 ft above aerodrome elevation.
 - ~~div.~~ When a low-level final turning manoeuvre is required in order to align the aeroplane visually with the landing runway, a height of 300 ft above the runway threshold elevation, or aerodrome elevation as appropriate, should be considered as the lowest height for approach stabilisation with wings level.
 - ~~div.~~ Dependent upon aeroplane type ~~or~~ class the operator may specify an appropriately higher minimum stabilisation height for circling approach operations.
 - ~~eivi.~~ The operator should specify in the ~~OM~~ **operations manual** the procedures and instructions for conducting circling approaches ~~to include,~~ **including** at least:
 - ~~i.~~ ~~The~~ **A. the** minimum required visual reference; ~~and~~
 - ~~ii.~~ ~~The~~ **B. the** corresponding actions for each segment of the circling manoeuvre; ~~and~~
 - ~~iii.~~ ~~The~~ **C. the** relevant ~~go-around~~ **missed approach procedure** actions if the required visual reference is lost; ~~and~~
 - ~~iv.~~ ~~The~~ **D. the** visual reference requirements for any operations with a prescribed track circling manoeuvre to include the MDA(H) and any published MAPt.
- ~~3.6f.~~ Visual Approach **approach.** All the applicable criteria with respect to the stability of the final descent path to the runway should apply to the operation

Subpart E | Revised rule text

of visual approaches. In particular, the control of the desired final nominal descent path to the threshold should be conducted to facilitate the appropriate techniques and procedures described in paragraphs 6. and 7. of this proposed AC.:

- ai. ~~s~~Stabilisation during the final straight-in segment for a visual approach should ideally be accomplished by 500 ft above runway threshold elevation for turbo-jet aeroplanes;
 - bii. ~~w~~When a low level final turning manoeuvre is required in order to align the aeroplane with the landing runway, a minimum height of 300 ft above the runway threshold elevation (or aerodrome elevation, as appropriate) should be considered as the lowest height for visual approach stabilisation with wings level;
 - ciii. ~~d~~Dependent upon aeroplane type ~~or~~ /class, the operator may specify an appropriately higher minimum stabilisation height for visual approach operations; **and**
 - div. ~~t~~The operator should specify in the ~~Operations manual~~ **Operations manual** the procedures and instructions for conducting visual approaches to include at least:
 - i. ~~The~~**A. the** minimum required visual reference; ~~and~~
 - ii. ~~The~~**B. the** corresponding actions if the required visual reference is lost during a visual approach manoeuvre; ~~and~~
 - iii. ~~The~~**C. the** appropriate ~~go-around-missed approach~~ **missed approach** actions;
- ~~3.7g.~~ The control of the descent path using the CDFA technique ensures that the descent path to the runway threshold is flown using ~~either~~:
- i. ~~a.~~ A variable descent rate or flight path angle to maintain the desired path, which may be verified by appropriate crosschecks; ~~or~~ **or**
 - b. ~~Aii.~~ **a** pre-computed constant rate of descent from the FAF, or other appropriate fix which is able to define a descent point and/or from the final approach segment step-down fix; or
 - c. ~~Vertical~~**iii.** **vertical guidance, including APV,** ~~including APV.~~
- The above techniques also support a common method for the implementation of flight-director-guided or auto-coupled RNAV(~~VNAV~~) ~~or~~ **GLS** approaches.
- ~~3.8 Missed Approach~~ **h.** The manoeuvre associated with the vertical profile of the missed approach should be initiated not later than reaching the MAPt or the DA(H) specified for the approach, whichever occurs first. The lateral part of the missed approach procedure ~~must~~ **should** be flown via the MAPt unless otherwise stated on the approach chart.
- ~~3.9i.~~ In case the CDFA technique is not used the approach should be flown to an altitude/height at or above the MDA(H) where a level flight segment at or above MDA(H) may be flown to the MAPt.
- ~~3.10j.~~ In case the CDFA technique is not used when flying an approach, ~~an~~ **operator** ~~operator~~ **the operator** should implement procedures to ensure that early descent to the MDA(H) will not result in a subsequent flight below MDA(H) without adequate visual reference. These procedures could include:

Subpart E | Revised rule text

- a. ~~Awareness~~ **i. awareness** of radio altimeter information with reference to the approach profile;
 - b. ~~Enhanced~~ **ii. enhanced** ~~g~~Ground ~~p~~Proximity ~~w~~Warning ~~s~~System **(GPWS)** and ~~/~~or ~~t~~Terrain ~~a~~Awareness information;
 - c. ~~Limitation~~ **iii. limitation** of rate of descent;
 - d. ~~Limitation~~ **iv. limitation** of the number of repeated approaches;
 - e. ~~Safeguards~~ **v. safeguards** against too early descents with prolonged flight at MDA~~(/H)~~; **and**
 - f. ~~Specification~~ **vi. specification** of visual requirements for the descent from the MDA~~(/H)~~.
4. Flight techniques~~†~~
- 4.1a. The CDFA technique can be used on almost any published non-precision approach when the control of the descent path is aided by either:
 - i. a. ~~A~~ recommended descent rate, based on estimated ground speed, which may be provided on the approach chart; or
 - b. ~~The~~ **ii. the** descent path as depicted on the chart.~~†~~
 - 4.2b. In order to facilitate the ~~requirement~~ **provision** of paragraph 4.1.2 ~~above~~, **4.a.ii.**, the operator should either provide charts which depict the appropriate cross check altitudes/heights with the corresponding appropriate range information, or such information should be calculated and provided to the flight- crew in an appropriate and ~~useable~~ **usable** format.~~†~~
 - 4.3c. For approaches flown coupled to a designated descent path using computed electronic glide-slope guidance ~~(normally a 3°-degree path)~~, the descent path should be appropriately coded in the flight management system data base and the specified navigational accuracy (RNP) should be determined and maintained throughout the operation of the approach.~~†~~
 - 4.4d. With an actual or estimated ground speed, a nominal vertical profile and required descent rate, the approach should be flown by crossing the FAF configured and on-speed. The tabulated or required descent rate is established and flown to not less than the DA~~(/H)~~, observing any step-down crossing altitudes if applicable.~~†~~
 - 4.5e. To assure the appropriate descent path is flown, the pilot ~~not flying~~ **monitoring** should announce crossing altitudes as published fixes and other designated points are crossed, giving the appropriate altitude or height for the appropriate range as depicted on the chart. The pilot flying should promptly adjust the rate of descent as appropriate.~~†~~
 - 4.6f. With the required visual reference requirements established, the aeroplane should be in position to continue descent through the DA~~(/H)~~ or MDA~~(/H)~~ with little or no adjustment to attitude or thrust/power.~~†~~
 - 4.7g. When applying CDFA on an approach with a nominal vertical profile to a DA~~(/H)~~, it may be necessary to apply an add-on to the published minima (vertical profile only) to ensure sufficient obstacle clearance. The add-on, if applicable, should be published in the ~~OM~~ **operations manual** ~~(Aerodrome~~

Subpart E | Revised rule text

~~Operating Minima~~). However, the resulting procedure minimum will still be referred to as the DA(H) for the approach.

- 4.8h.** Operators should establish a procedure to ensure that an appropriate callout (automatic or oral) is made when the aeroplane is approaching DA(H). If the required visual references are not established at DA(H), the missed approach procedure is to be executed promptly. Visual contact with the ground alone is not sufficient for continuation of the approach. With certain combinations of DA(H), RVR and approach slope, the required visual references may not be achieved at the DA(H) in spite of the RVR being at or above the minimum required for the conduct of the approach. The safety benefits of CDFA are negated if prompt ~~go-around~~ **missed approach procedure** action is not initiated.
- 4.9i.** The following bracketing conditions in relation to angle of bank, rate of descent and thrust/power management are considered to be suitable for most aeroplane types ~~or~~ **classes** to ensure the ~~predetermined~~ **pre-determined** vertical path approach is conducted in a stabilised manner:
- ai.** Bank angle: ~~As prescribed in the AOM~~ **As prescribed in the operations manual, this** should generally be less than 30 ~~degrees~~.
- bii.** Rate of descent (ROD): ~~The target ROD should not exceed 1 000 fpm. The ROD should deviate by no more than ± 1300 feet per minute (fpm) from the target ROD. Prolonged rates of descent which differ from the target ROD by more than 300 fpm indicate that the vertical path is not being maintained in a stabilised manner. The ROD should not exceed 1 200 fpm, except under exceptional circumstances, which have been anticipated and briefed prior to commencing the approach; for example, a strong tailwind.~~
- Note:** ~~zero~~ **Zero** rate of descent may be used when the descent path needs to be regained from below the profile. The target ROD may need to be initiated prior to reaching the required descent point (typically 0.3 ~~NM~~ **NM** before the descent point, dependent upon ground speed, which may vary for each type ~~or~~ class of aeroplane). ~~See (c) below. (Refer to 4.i.iii.)~~
- ei.** Thrust/power management: ~~The limits of thrust/power and the appropriate range should be specified in the OM,~~ **The limits of thrust/power and the appropriate range should be specified in the operations manual Part B or equivalent documents.**
- 4.10j.** Transient corrections/~~Overshoots~~ **overshoots**: ~~The above-specified range of corrections should normally be used to make occasional momentary adjustments in order to maintain the desired path and energy of the aeroplane. Frequent or sustained overshoots should require the approach to be abandoned and a go-around~~ **missed approach procedure** initiated. A correction philosophy should be applied similar to that described in ~~paragraph 5 below.~~ **5.**
- 4.11k.** The relevant elements of ~~paragraph 4 above~~ **4.** should, in addition, be applied to approaches not flown using the CDFA technique; the procedures thus developed, thereby ensure a controlled flight path to MDA(H). Dependent upon the number of step down fixes and the aeroplane type ~~or~~ class, the aeroplane should be appropriately configured to ensure safe control of the flight path prior to the final descent to MDA(H).

Subpart E | Revised rule text

5. Stabilisation of energy/speed and configuration of the aeroplane on the approach:
- ~~5.1a.~~ The control of the descent path is not the only consideration. Control of the aeroplane's configuration and energy is also vital to the safe conduct of an approach.
- ~~5.2b.~~ The approach should be considered to be fully stabilised when the aeroplane is:
- ~~ai.~~ tracking on the required approach path and profile; ~~and~~
 - ~~bii.~~ in the required configuration and attitude; ~~and~~
 - ~~aiii.~~ flying with the required rate of descent and speed; and
 - ~~div.~~ flying with the appropriate thrust/power and trim.
- ~~5.3c.~~ The following flight path control criteria should be met and maintained when the aeroplane passes the gates described in ~~paragraphs 5.6. and 5.7. below.~~
- ~~5.4d.~~ The aeroplane is considered established on the required approach path at the appropriate energy for stable flight using the CDFA technique when:
- ~~a. —~~~~iti.~~ **it** is tracking on the required approach path with the correct track set, approach aids tuned and identified as appropriate to the approach type flown and on the required vertical profile; and
 - ~~b. —~~~~itii.~~ **it** is at the appropriate attitude and speed for the required target ROD with the appropriate thrust/power and trim.
- ~~5.5e.~~ It is recommended to compensate for strong wind/gusts on approach by speed increments given in the ~~Aeroplane Operations Manual (AOM).~~ **operations manual.** To detect wind shear and magnitude of winds aloft, all available aeroplane equipment such as **flight management system (FMS), inertial navigation system (INS)**, etc. should be used.
- ~~5.6f.~~ It is recommended that stabilisation during any straight-in approach without visual reference to the ground should be achieved at the latest when passing 1,000 ft above runway threshold elevation. For approaches with a designated vertical profile applying CDFA, a later stabilisation in speed may be acceptable if higher than normal approach speeds are required by ATC procedures or allowed by the ~~OM.~~ **operations manual.** Stabilisation should, however, be achieved not later than 500 ft above runway threshold elevation.
- ~~5.7g.~~ For approaches where the pilot has visual reference with the ground, stabilisation should be achieved not later than 500 ft above aerodrome elevation. However, it is recommended that the aeroplane should be stabilised when passing ~~1,000 ft above runway threshold~~ **1 000 ft above runway threshold elevation; in the case of circling approaches flown after a CDFA, it is recommended that the aircraft be stabilised in the circling configuration not later than passing 1 000 ft above the runway elevation.**
- ~~5.8h.~~ The relevant elements of ~~paragraph 5. above~~ **5.** should, in addition, be applied to approaches not flown using the CDFA technique; the procedures thus developed ensure that a controlled and stable path to MDA{/H} is achieved. Dependent upon the number of step down fixes and the aeroplane

Subpart E | Revised rule text

type ~~or~~ class, the aeroplane should be appropriately configured to ensure safe and stable flight prior to the final descent to MDA~~(/H)~~.

6. Visual ~~Reference~~**reference** and path-control below MDA~~(/H)~~ when not using the CDFA technique
- ~~6.1~~. In addition to the ~~requirements~~**provisions** stated in ~~Appendix 1 to JAR-OPS 1.430, NCC.OP-150-CAT.OP and its AMC material~~ the pilot should have attained a combination of visual cues to safely control the aeroplane in roll and pitch to maintain the final approach path to landing. This ~~must~~**should** be included in the standard operating procedures and reflected in the ~~OM~~**Operations manual**.
7. Operational ~~Procedures~~**procedures** and ~~Instructions~~**instructions** for using the CDFA technique or not:
- ~~7.1~~**a.** The operator should establish procedures and instructions for flying approaches using the CDFA technique and not. These procedures should be included in the ~~OM~~**Operations manual** and should include the duties of the flight crew during the conduct of such operations. **In addition, :**
- ~~ai.~~ The operator should publish in the ~~OM~~**operations manual** the **provisions** requirements stated in paragraphs 4. and 5 above, as appropriate to the aeroplane type or class to be operated, **should be specified; and**
- ~~bii.~~ The checklists should be completed as early as practicable and preferably before commencing final descent towards the DA~~(/H)~~.
- ~~7.2~~**b.** The ~~operations or's~~ manuals should at least specify the maximum ROD for each aeroplane type ~~or~~ class operated and the required visual reference to continue the approach below:
- ~~a.~~**i.** the DA~~(/H)~~, when applying CDFA; **and**
- ~~b.~~**ii.** the MDA~~(/H)~~, when not applying CDFA.
- ~~7.3~~**c.** The operator should establish procedures ~~which~~**that** prohibit level flight at MDA~~(/H)~~ without the flight crew having obtained the required visual references.
- ~~Note:~~ It is not the intention of this paragraph to prohibit level flight at MDA~~(/H)~~ when conducting a circling approach, which does not come within the definition of the CDFA technique.
- ~~7.4~~**d.** The operator should provide the flight crew with:
- ~~a.~~ Unambiguous **unambiguous** details of the technique used (CDFA or not).
- ~~b.~~ The corresponding relevant minima should include:
- i. ~~Type~~**type** of decision, whether DA~~(/H)~~ or MDA~~(/H)~~;
- ii. MAPt as applicable; **and**
- iii. ~~Appropriate~~**appropriate** RVR/Visibility for the approach classification and aeroplane category.
- ~~7.5~~**e.** Specific types ~~or~~ classes of aeroplanes, in particular certain ~~Performance Class~~**performance class** B and **performance c**Class C aeroplanes, may be unable to comply fully with the requirements of this ~~ACJ~~**guidance** relating to

Subpart E | Revised rule text

the operation of CDFA. This problem arises because some aeroplanes ~~must~~ **should** not be configured fully into the landing configuration until required visual references are obtained for landing, because of inadequate missed-approach performance engine out. For such aeroplanes, the operator should either:

- a. ~~Obtain~~i. **obtain** approval from ~~submit to~~ the **competent Authority** ~~authority~~ for an appropriate modification to the stipulated procedures and flight techniques prescribed herein; or
- b. ~~Increase~~ii. **increase** the required minimum RVR to ensure the aeroplane will be operated safely during the configuration change on the final approach path to landing.

8. Training

~~8.1a.~~ The operator should ensure that, ~~p~~Prior to using the CDFA technique or not ~~(as appropriate)~~, each flight crew member **should** undertake:

a. ~~The~~ ~~the~~ appropriate training and checking as required by ~~Subpart N.~~**Part OR.OPS.FC.** Such training should cover the techniques and procedures appropriate to the operation which are stipulated in ~~paragraphs 4. and 5. of this AC~~

b. The operator's proficiency check, ~~if applicable~~, should include at least one approach to a landing or ~~go-around~~ **missed approach** as appropriate using the CDFA technique or not. The approach should be operated to the lowest appropriate DA(H) or MDA(H) as appropriate; and, if conducted in a ~~FSTD Simulator~~ **simulator**, the approach should be operated to the lowest approved RVR.

~~Note.~~ The approach required by ~~paragraph 8.1.2~~ is not in addition to any manoeuvre currently required by either ~~JAR Part-FCL or JAR OPS 1.~~**Part-CATNCC.** The requirement may be fulfilled by undertaking any currently required approach, ~~(engine out or otherwise)~~, other than a precision approach, whilst using the CDFA technique.

~~8.2b.~~ The policy for the establishment of constant ~~predetermined~~ **pre-determined** vertical path and approach stability ~~are~~ **is** to be enforced both during initial and recurrent pilot training and checking. The relevant training procedures and instructions should be documented in the ~~OM.~~**operations manual.**

~~8.3c.~~ The training should emphasise the need to establish and facilitate joint crew procedures and CRM to enable accurate descent path control and the requirement to establish the aeroplane in a stable condition as required by the operator's operational procedures. If barometric ~~VNAV~~ **vertical navigation** is used, the crews should be trained in **awareness of** the errors associated with these systems.

~~8.4d.~~ During training, emphasis should be placed on the flight crew's need to:

- a. ~~Maintain~~i. **maintain** situational awareness at all times, in particular with reference to the required vertical and horizontal profile;
- b. ~~Ensure~~ii. **ensure** good communication channels throughout the approach;

Subpart E | Revised rule text

- e. ~~Ensure~~**iii. ensure** accurate descent-path control particularly during any manually-flown descent phase. The ~~monitoring non-operating/non-handling~~ pilot should facilitate good flight path control by:
- i. ~~Communicating~~**A. communicating** any altitude/height crosschecks prior to the actual passing of the range/altitude or height crosscheck;
 - ii. ~~Prompting~~**B. prompting**, as appropriate, changes to the target ROD; **and**
 - iii. ~~Monitoring~~**C. monitoring** flight path control below DA/MDA;-
- d. ~~Understand~~**iv. understand** the actions to be taken if the MAPt is reached prior to the MDA{/H}-;
- e. ~~Ensure~~**v. ensure** that the decision **for a missed approach is taken no later than when to go around must, at the latest, have been taken upon reaching the DA{/H} or MDA{/H}-;**
- f. ~~Ensure~~**vi. ensure** that prompt ~~go around~~ **action for a missed approach** is taken immediately when reaching DA{/H} if the required visual reference has not been obtained as there may be no obstacle protection if the ~~go around~~**missed approach procedure** manoeuvre is delayed-;
- g. ~~Understand~~**vii. understand** the significance of using the CDFA technique to a DA{/H} with an associated MAPt and the implications of early ~~go around~~**missed approach** manoeuvres-; **and**
- h. ~~Understand~~**viii. understand** the possible loss of the required visual reference (due to pitch-change/climb) when not using the CDFA technique for aeroplane types **or /classes which that** require a late change of configuration and/or speed to ensure the aeroplane is in the appropriate landing configuration-;
- 8.5e. Additional specific training when not using the CDFA technique with level flight at or above MDA{/H}-;
- ai. The training should detail:
- i. ~~The~~**A. the** need to facilitate ~~good~~ CRM-; with ~~good~~**appropriate** flight- crew communication in particular-;
 - ii. ~~The~~**B. the** additional known safety risks associated with the 'dive-and-drive' approach philosophy which may be associated with non-CDFA-;
 - iii. ~~The~~**C. the** use of DA{/H} during approaches flown using the CDFA technique-;
 - iv. ~~The~~**D. the** significance of the MDA{/H} and the MAPt where appropriate-;
 - v. ~~The~~**E. the** actions to be taken at the MAPt and the need to ensure **that** the aeroplane remains in a stable condition and on the nominal and appropriate vertical profile until the landing-;
 - vi. ~~The~~**F. the** reasons for increased RVR/Visibility minima when compared to the application of CDFA-;

Subpart E | Revised rule text

- ~~vii. The~~**G. the** possible increased obstacle infringement risk when undertaking level flight at MDA{/H} without the required visual references;
- ~~viii. The~~**H. the** need to accomplish a prompt **missed approach go-around** manoeuvre if the required visual reference is lost;
- ~~ix. The~~**I. the** increased risk of an unstable final approach and an associated unsafe landing if a rushed approach is attempted either from:
 - ~~A. Inappropriate~~**1. inappropriate** and close-in acquisition of the required visual reference; **or**
 - ~~B. Unstable~~**2. unstable** aeroplane energy and or flight path control; **and**
- ~~xj. The~~**J. the** increased risk of CFIT ~~(see introduction).~~

9. ~~Approvals~~**Approaches requiring level flights:**

- ~~9.1a. The procedures which~~**that** are flown with level flight at/or above MDA{/H} ~~must~~**should** be approved by the Authority and listed in the ~~OM~~**operations manual.**
- ~~9.2b. Operators should classify~~**categorise** aerodromes where there are approaches ~~which~~**that** require level flight at/or above MDA{/H} as ~~being B and or C categorised.~~ Such aerodrome categorisation will depend upon the operator's experience, operational exposure, training programme(s) and flight crew qualification(s).
- ~~9.3 Exemptions granted in accordance with JAR OPS 1.430, paragraph (d)(2) should be limited to locations where there is a clear public interest to maintain current operations. The exemptions should be based on the operators experience, training programme and flight crew qualification. The exemptions should be reviewed at regular intervals and should be terminated as soon as facilities are improved to allow SAp or CDFA.]~~

AMC1-CAT.OP.AH.120 Airborne radar approaches (ARAs) for overwater operations - helicopters

Comment [WSI75]:
Transferred from AMC
OPS.CAT.150.H.

GENERAL

1. Before commencing the final approach the ~~pilot in command~~**commander** should ensure that a clear path exists on the radar screen for the final and missed approach segments. If lateral clearance from any obstacle will be less than ~~one nm~~**1 NM**(nautical mile), the ~~pilot in command~~**commander** should:
 - a. approach to a nearby target structure and thereafter proceed visually to the destination structure; or
 - b. make the approach from another direction leading to a circling manoeuvre.
2. ~~The pilot in command should ensure that~~**The** cloud ceiling is ~~is~~**should be** sufficiently clear above the helideck to permit a safe landing.

Subpart E | Revised rule text

3. ~~Notwithstanding the minima in AMC OPS.CAT.H.150-3.a. and b., the Minimum Descent Height (MDH) should not be less than 50 ft (feet) above the elevation of the helideck.~~
 - a. The MDH for an airborne radar approach should not be lower than:
 - i. 200 ft by day; or
 - ii. 300 ft by night.
 - b. The MDH for an approach leading to a circling manoeuvre should not be lower than:
 - i. 300 ft by day; or
 - ii. 500 ft by night.
4. ~~A Minimum Descent Altitude (MDA) may only be used if the radio altimeter is unserviceable. The MDA should be a minimum of MDH +200 ft and should be based on a calibrated barometer at the destination or on the lowest forecast QNH for the region.~~
5. The decision range should not be less than $\frac{3}{4}$ ~~NM~~nm.
6. The MDA/H for a single-pilot ARA should be 100 ft higher than that calculated using ~~AMC OPS.CAT.H.150-3. and 4.~~ **above**. The decision range should not be less than **1 NM**~~one nm~~.

GM1-CAT.OP.AH.120 Airborne radar approaches (ARAs) for overwater operations - helicopters

Comment [WSI76]:
Transferred from GM
OPS.CAT.150.H.

GENERAL

1. General:
 - a. The helicopter ARA procedure may have as many as five separate segments. These are the arrival, initial, intermediate, final, and missed approach segments. In addition, the requirements of the circling manoeuvre to a landing under visual conditions should be considered. The individual approach segments can begin and end at designated fixes, however, the segments of an ARA may often begin at specified points where no fixes are available.
 - b. The fixes, or points, are named to coincide with the associated segment. For example, the intermediate segment begins at the ~~i~~Intermediate ~~f~~Fix (IF) and ends at the ~~f~~Final ~~a~~Approach ~~f~~Fix (FAF). Where no fix is available or appropriate, the segments begin and end at specified points; for example, ~~i~~Intermediate ~~p~~Point (IP) and final approach point (FAP). The order in which this guidance material discusses the segments is the order in which the pilot would fly them in a complete procedure: that is, from the arrival through initial and intermediate to a final approach and, if necessary, the missed approach.
 - c. Only those segments ~~which~~**that** are required by local conditions applying at the time of the approach need be included in a procedure. In constructing the procedure, the final approach track, ~~{~~which should be orientated so as to be substantially into wind~~}~~ should be identified first as it is the least flexible and most critical of all the segments. When the origin and the orientation of the final approach have been determined, the other necessary segments should be

Subpart E | Revised rule text

integrated with it to produce an orderly manoeuvring pattern ~~which~~**that** does not generate an unacceptably high work-load for the flight crew.

- d. Examples of ARA procedures, vertical profile and missed approach procedures are contained in Figures 1 to 5 ~~of GM-OPS.CAT.H.150.~~

2. Obstacle environment:

- a. Each segment of the ARA is located in an over-water area ~~which~~**that** has a flat surface at sea level. However, due to the passage of large vessels which are not required to notify their presence, the exact obstacle environment cannot be determined. As the largest vessels and structures are known to reach elevations exceeding 500 ft ~~amsl~~ (above mean sea level (**AMSL**)), the uncontrolled offshore obstacle environment applying to the arrival, initial and intermediate approach segments can reasonably be assumed to be capable of reaching to at least 500 ft ~~amsl~~**AMSL**. But, in the case of the final approach and missed approach segments, specific areas are involved within which no radar returns are allowed. In these areas the height of wave crests and the possibility that small obstacles may be present ~~which~~**that** ~~are~~ not visible on radar, results in an uncontrolled surface environment ~~which~~**that** extends to an elevation of 50 ft ~~amsl~~**AMSL**.
- b. Under normal circumstances, the relationship between the approach procedure and the obstacle environment is governed according to the concept that vertical separation is very easy to apply during the arrival, initial and intermediate segments, while horizontal separation, which is much more difficult to guarantee in an uncontrolled environment, is applied only in the final and missed approach segments.

3. Arrival segment:

The arrival segment commences at the last en-route navigation fix, where the aircraft leaves the helicopter route, and it ends either at the ~~i~~**a**Initial ~~a~~**f**ix (IAF) or, if no course reversal, or similar manoeuvre is required, it ends at the IF. Standard en-route obstacle clearance criteria should be applied to the arrival segment.

4. Initial approach segment:

The initial approach segment is only required if a course reversal, race track, or arc procedure is necessary to join the intermediate approach track. The segment commences at the IAF and on completion of the manoeuvre ends at the IP. The ~~m~~**o**Minimum ~~o~~**c**learance (MOC) assigned to the initial approach segment is 1 000 ft.

5. Intermediate approach segment:

The intermediate approach segment commences at the IP, or in the case of "straight-in" approaches, where there is no initial approach segment, it commences at the IF. The segment ends at the FAP and should not be less than ~~two nm~~**2 NM** in length. The purpose of the intermediate segment is to align and prepare the helicopter for the final approach. During the intermediate segment the helicopter should be lined up with the final approach track, the speed should be stabilised, the destination should be identified on the radar, and the final approach and missed approach areas should be identified and verified to be clear of radar returns. The MOC assigned to the intermediate segment is 500 ft.

Subpart E | Revised rule text

6. Final approach segment-
- a. The final approach segment commences at the FAP and ends at the ~~m~~**Missed Approach Point (MAPt)**. The final approach area, which should be identified on radar, takes the form of a corridor between the FAP and the radar return of the destination. This corridor should not be less than ~~two nm~~**2 NM** wide in order that the projected track of the helicopter does not pass closer than ~~1 nm~~**1 NM** to the obstacles lying outside the area.
 - b. On passing the FAP, the helicopter will descend below the intermediate approach altitude, and follow a descent gradient which should not be steeper than 6-.5%. At this stage vertical separation from the offshore obstacle environment will be lost. However, within the final approach area the MDA/H₇ will provide separation from the surface environment. Descent from 1 000 ft ~~amsl~~**AMSL** to 200 ft ~~amsl~~**AMSL** at a constant 6-.5% gradient will involve a horizontal distance of ~~two nm~~**2 NM**. In order to follow the guideline that the procedure should not generate an unacceptably high work-load for the flight crew, the required actions of levelling at MDH, changing heading at the ~~o~~**Offset Initiation Point (OIP)**, and turning away at MAPt should not be planned to occur at the same time. Consequently, the FAP should not normally be located at less than ~~four nm~~**4 NM** from the destination.
 - c. During the final approach, compensation for drift should be applied and the heading which, if maintained, would take the helicopter directly to the destination, should be identified. It follows that, at an OIP located at a range of ~~1.5 nm~~**1.5 NM**, a heading change of 10° is likely to result in a track offset of 15° at 1 ~~nm~~**NM**, and the extended centreline of the new track can be expected to have a mean position lying some 300 - 400 ~~metres m~~**metres m** to one side of the destination structure. The safety margin built in to the ~~0.75 nm~~**0.75 NM** ~~d~~**Decision Range (DR)** is dependent upon the rate of closure with the destination. Although the air-speed should be in the range 60/90 kts (~~knots~~) during the final approach, the ground speed, after due allowance for wind velocity, should be no greater than 70 kts.
7. Missed approach segment-
- a. The missed approach segment commences at the MAPt and ends when the helicopter reaches minimum en-route altitude. The missed approach manoeuvre is a "turning missed approach" which should be of not less than 30° and should not, normally, be greater than 45°. A turn away of more than 45° does not reduce the collision risk factor any further, nor will it permit a closer DR. However, turns of more than 45° may increase the risk of pilot disorientation and, by inhibiting the rate of climb (especially in the case of an ~~One-Engine-Inoperative (OEI) go-around~~**missed approach procedure**), may keep the helicopter at an extremely low level for longer than is desirable.
 - b. The missed approach area to be used should be identified and verified as a clear area on the radar screen during the intermediate approach segment. The base of the missed approach area is a sloping surface at 2-.5% gradient starting from MDH at the MAPt. The concept is that a helicopter executing a turning missed approach will be protected by the horizontal boundaries of the missed approach area until vertical separation of more than 130 ft is achieved

Subpart E | Revised rule text

between the base of the area, and the offshore obstacle environment of 500 ft ~~amsl~~ **AMSL** which prevails outside the area.

- c. A missed approach area, taking the form of a 45° sector orientated left or right of the final approach track, originating from a point ~~5 nm~~ **3 NM** short of the destination, and terminating on an arc ~~three nm~~ **3 NM** beyond the destination, will normally satisfy the requirements of a 30° turning missed approach.

8. The required visual reference:

The visual reference required is that the destination should be in view in order that a safe landing may be carried out.

9. Radar equipment:

During the ARA procedure, colour mapping radar equipment with a 120° sector scan and 2-~~5 nm~~ **3 NM** range scale selected, may result in dynamic errors of the following order:

- a. ~~b~~ **B**earing/tracking error $\pm 4.5^\circ$ with 95% accuracy;
- b. ~~m~~ **M**ean ranging error ± 250 ~~metres m~~ **(m)**; **or**
- c. ~~r~~ **R**andom ranging error ± 250 m with 95% accuracy.

Figure 1 of GM1-CAT.OP.AH.120.H ~~GM-OPS-CAT.150.H~~ Arc procedure

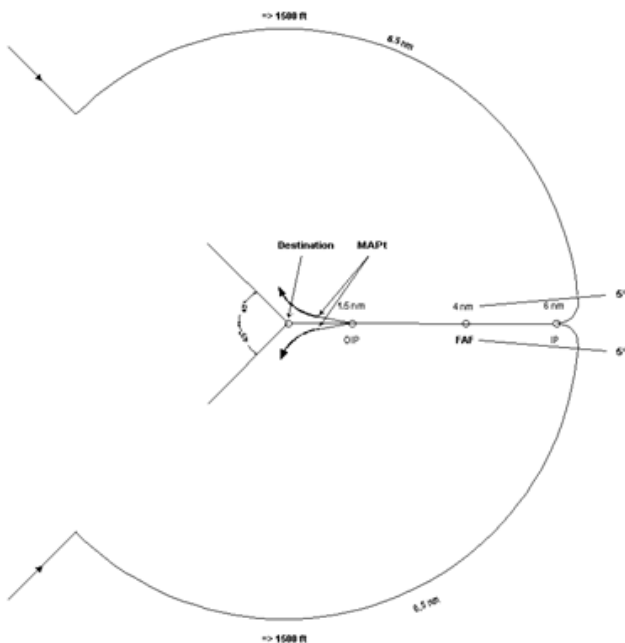

Figure 2 of GM1-CAT.OP.AH.120.H ~~GM-OPS-CAT.150.H~~ Base tFurn pProcedure - dDirect aApproach

Subpart E | Revised rule text

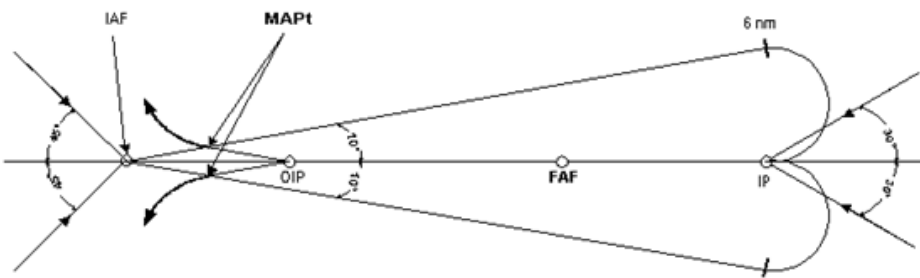

Figure 3 of GM1-CAT.OP.AH.120.H GM-OPS.CAT.150.H Holding Pattern & Race Track Procedure

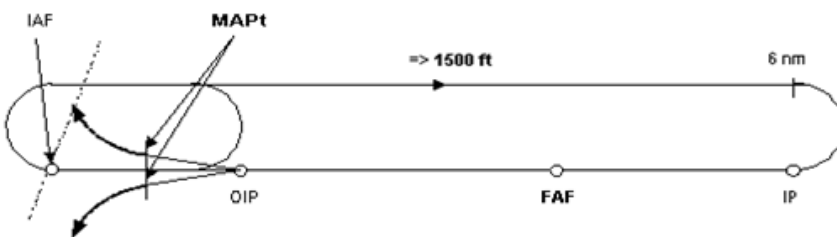

Figure 4 of GM1-CAT.OP.AH.120.H GM-OPS.CAT.150.H Vertical Profile

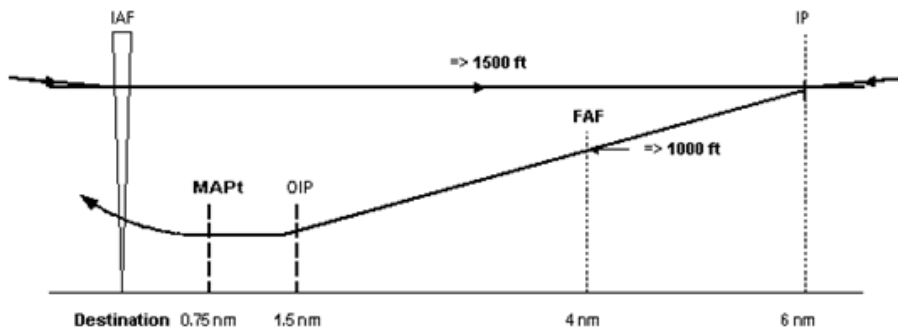
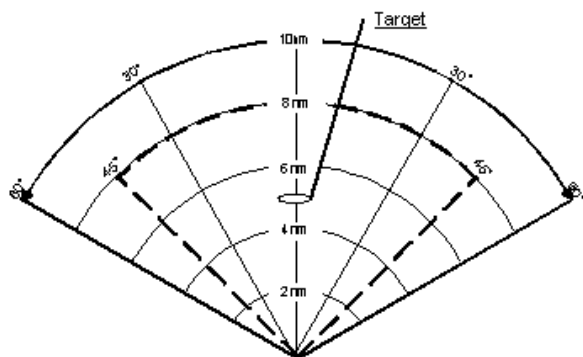

Figure 5 of GM1-CAT.OP.AH.120.H GM-OPS.CAT.150.H Missed Approach Area Left & Right



Subpart E | Revised rule text

[17]Part-SPA

Subpart E – Low visibility operations – AMC/GM

GM1-SPA.LVO.100 Low visibility operations

DOCUMENTS CONTAINING INFORMATION RELATED TO ~~LOW-VISIBILITY OPERATIONS~~ **LOW VISIBILITY OPERATIONS**

The following documents provide **further** information ~~related to~~ **low visibility operations (LVO)**:

1. ICAO Annex 2 / Rules of the Air;
2. ICAO Annex 6 / Operation of Aircraft;
3. ICAO Annex 10 / Telecommunications Vol. 1;
4. ICAO Annex 14 / Aerodromes Vol. 1;
5. ICAO Doc ~~8186~~ **8168** / PANS - OPS Aircraft Operations;
6. ICAO Doc 9365 / AWO Manual;
7. ICAO Doc 9476 / SMGCS Manual (~~s~~Surface ~~m~~Movement ~~g~~Guidance and ~~c~~Control ~~s~~Systems);
8. ICAO Doc 9157 / Aerodrome Design Manual;
9. ICAO Doc 9328 / Manual **of RVR Observing and Reporting Practices**~~for RVR Assessment~~;
- 10. ICAO EUR Doc. 013: EUROPEAN GUIDANCE MATERIAL ON AERODROME OPERATIONS UNDER LIMITED VISIBILITY CONDITIONS**
- ~~110.~~ ECAC Doc 17, Issue 3 (~~partly incorporated in this Part OPS~~); and
- ~~121.~~ CS-AWO (Airworthiness Certification).

Comment [WSI77]:
Corresponds to IEM OPS 1.430 and GM2 OPS.SPA.001.LVO.

Changes shown are to the NPA version.

GM2-SPA.LVO.100 Low visibility operations

USE OF ENHANCED VISION SYSTEMS (EVS)

1. Introduction
 - ~~a1.1.~~ Enhanced vision systems use sensing technology to improve a pilot's ability to detect objects, such as runway lights or terrain, which may otherwise not be visible. The image produced from the sensor and/or image processor can be displayed to the pilot in a number of ways including use of a ~~head-up display~~ **HUD**. The systems can be used in all phases of flight and can improve situational awareness. In particular, infrared systems can display terrain during operations at night, improve situational awareness during night and low-visibility taxiing, and may allow earlier acquisition of visual references during instrument approaches.
2. Background to EVS provisions
 - ~~a.2.1~~ The provisions for EVS were developed after an operational evaluation of two different EVS systems, along with data and support ~~kindly~~ provided by the

Comment [WSI78]:
Corresponds to ACJ OPS to Appendix 1 (New) to JAR-OPS 1.430(h) and GM OPS.SPA.001.LVO(b)(2).

Changes shown are to the NPA version.

Subpart E | Revised rule text

FAA. Approaches using EVS were flown in a variety of conditions including fog, rain and snow showers, as well as at night to aerodromes located in mountainous terrain. The infrared EVS performance can vary depending on the weather conditions encountered. Therefore, the provisions take a conservative approach to cater for the wide variety of conditions which may be encountered. It may be necessary to amend the provisions in the future to take account of greater operational experience.

~~2.2b.~~ Provisions for the use of EVS during take-off have not been developed. The systems evaluated did not perform well when the RVR was below 300 **m metres**. There may be some benefit for use of EVS during take-off with greater visibility and reduced ~~lighting~~**light**; however, such operations would need to be evaluated.

~~2.3c.~~ Provisions have been developed to cover use of infrared systems only. Other sensing technologies are not intended to be excluded; however, their use will need to be evaluated to determine the appropriateness of this, or any other provision. During the development, it was envisaged what minimum equipment should be fitted to the aircraft. Given the present state of technological development, it is considered that a HUD is an essential element of the EVS equipment.

~~2.4d.~~ In order to avoid the need for tailored charts for approaches utilising EVS, it is envisaged that ~~an operator~~**the operator** will use **AMC1-SPA.LVO.110 OPS.SPA.001.LVO(b)(2) Table 1-5** - Approach utilising EVS RVR/CMV ~~r~~**R**Reduction vs. ~~n~~**N**ormal RVR/CMV to determine the applicable RVR at the commencement of the approach.

3. Additional operational considerations

~~a3.1.~~ Enhanced vision system equipment should have:

- ~~ia.~~ a head-up display system (capable of displaying, airspeed, vertical speed, aircraft attitude, heading, altitude, command guidance as appropriate for the approach to be flown, path deviation indications, flight path vector, and flight path angle reference cue and the EVS imagery);
- ~~iib.~~ ~~for two pilot operation,~~ a head-down view of the EVS image, or other means of displaying the EVS-derived information easily to the pilot monitoring the progress of the approach; ~~and-~~

~~If the aircraft is equipped with a radio altimeter, it should be used only as enhanced terrain awareness during approach using EVS and should not be taken into account for the operational procedures development.~~

Comment [WSI79]:
Text deleted because it would be in contradiction with the SPA.LVO.100.

4. Two pilot operations

~~4.1 For operations in RVRs below 550 m, two pilot operation is required.~~

~~4.2 The provision for a head down view of the EVS image is intended to cover for multi pilot philosophy.~~ ~~iii.~~ ~~t~~The pilot **monitoring not flying (PNF)** is kept in the 'loop' and ~~c~~**rew r**Resource ~~m~~**M**anagement (CRM) does not break down. ~~The PNF can be very isolated from the information necessary for monitoring flight progress and decision making if the PF is the only one to have the EVS image.~~

Subpart E | Revised rule text

GM3-SPA.LVO.100 Low visibility operations**CREW ACTIONS IN CASE OF AUTOPILOT FAILURE AT OR BELOW DECISION HEIGHTDH IN FAIL-PASSIVE CATEGORY IICAT III OPERATIONS**

For operations to actual RVR values less than 300 m, a ~~go-around~~**missed approach procedure** is assumed in the event of an autopilot failure at or below DH. This means that a ~~go-around~~**missed approach procedure** is the normal action. However, the wording recognises that there may be circumstances where the safest action is to continue the landing. Such circumstances include the height at which the failure occurs, the actual visual references, and other malfunctions. This would typically apply to the late stages of the flare. In conclusion, it is not forbidden to continue the approach and complete the landing when the pilot-in-command/**commander** or the pilot to whom the conduct of the flight has been delegated, determines that this is the safest course of action. The operator's policy and the operational instructions should reflect this information.

Comment [WSI80]:
Corresponds to IEM to Appendix 1 (New) to JAR-OPS 1.430, paragraph (g)(5) - Table 8 and GM1 Appendix 3 to AMC1 OPS.SPA.020.LVO.

Changes show are to the NPA version.

GM4-SPA.LVO.100 Low visibility operations**ESTABLISHMENT OF MINIMUM RVR FOR CATEGORY IICAT II AND CAT III OPERATIONS**

1. General

- ~~a1.1~~ **a1.1** When establishing minimum RVR for ~~Category IICAT II~~ and **CAT III** ~~o~~**Operations**, operators should pay attention to the following information ~~which~~ **that** originates in ECAC Doc 17 3rd Edition, Subpart A. It is retained as background information and, to some extent, for historical purposes although there may be some conflict with current practices.
- ~~b1.2~~ **b1.2** Since the inception of precision approach and landing operations various methods have been devised for the calculation of aerodrome operating minima in terms of ~~decision heightDH~~ and runway visual range. It is a comparatively straightforward matter to establish the ~~decision heightDH~~ for an operation but establishing the minimum RVR to be associated with that ~~decision heightDH~~ so as to provide a high probability that the required visual reference will be available at that ~~decision heightDH~~ has been more of a problem.
- ~~c1.3~~ **c1.3** The methods adopted by various States to resolve the DH/RVR relationship in respect of ~~Category IICAT II~~ and ~~Category IICAT III~~ operations have varied considerably. In one instance there has been a simple approach which entailed the application of empirical data based on actual operating experience in a particular environment. This has given satisfactory results for application within the environment for which it was developed. In another instance a more sophisticated method was employed which utilised a fairly complex computer programme to take account of a wide range of variables. However, in the latter case, it has been found that with the improvement in the performance of visual aids, and the increased use of automatic equipment in the many different types of new aircraft, most of the variables cancel each other out and a simple tabulation can be constructed which is applicable to a wide range of aircraft. The basic principles which are observed in establishing the values in such a table are that the scale of visual reference required by a pilot at and below ~~decision heightDH~~ depends on the task that he/**she** has to carry out,

Comment [WSI81]:
Corresponds to IEM to Appendix 1 (New) to JAR-OPS 1.430, paragraphs (f) and (g) and GM2 Appendix 3 to AMC1 OPS.SPA.020.LVO.

Changes shows are to the NPA version.

Subpart E | Revised rule text

and that the degree to which his/**her** vision is obscured depends on the obscuring medium, the general rule in fog being that it becomes more dense with increase in height. Research using ~~flight simulator~~ **FSTDs** coupled with flight trials has shown the following:

- ia. ~~m~~ Most pilots require visual contact to be established about ~~3~~ **three** seconds above ~~decision height~~ **DH** though it has been observed that this reduces to about ~~1~~ **one** second when a fail-operational automatic landing system is being used;
- iib. ~~t~~ To establish lateral position and cross-track velocity most pilots need to see not less than a ~~3~~ **three** light segment of the ~~centre line~~ **centreline** of the approach lights, or runway ~~centre line~~ **centreline**, or runway edge lights;
- iiie. ~~f~~ For roll guidance most pilots need to see a lateral element of the ground pattern, i.e. an approach ~~lighting~~ **light** cross bar, the landing threshold, or a barrette of the touchdown zone ~~lighting~~ **light**; and
- ivd. ~~t~~ To make an accurate adjustment to the flight path in the vertical plane, such as a flare, using purely visual cues, most pilots need to see a point on the ground which has a low or zero rate of apparent movement relative to the aircraft.
- ve. With regard to fog structure, data gathered in the United Kingdom over a twenty-year period have shown that in deep stable fog there is a ~~90-%~~ **90%** probability that the slant visual range from eye heights higher than 15 ft above the ground will be less ~~that than~~ the horizontal visibility at ground level, i.e. RVR. There are at present no data available to show what the relationship is between the ~~s~~ **Slant v** ~~Visual r~~ **Range** and RVR in other low visibility conditions such as blowing snow, dust or heavy rain, but there is some evidence in pilot reports that the lack of contrast between visual aids and the background in such conditions can produce a relationship similar to that observed in fog.

2. ~~Category I~~ **CAT II** operations

~~2.1~~ The selection of the dimensions of the required visual segments which are used for ~~Category I~~ **CAT II** operations is based on the following visual requirements:

- a. ~~a~~ A visual segment of not less than ~~90-metres m~~ **90 metres m** will need to be in view at and below ~~decision height~~ **DH** for pilot to be able to monitor an automatic system;
- b. ~~a~~ A visual segment of not less than ~~120-metres m~~ **120 metres m** will need to be in view for a pilot to be able to maintain the roll attitude manually at and below ~~decision height~~ **DH**; and
- c. ~~f~~ For a manual landing using only external visual cues, a visual segment of ~~225 metres m~~ **225 metres m** will be required at the height at which flare initiation starts in order to provide the pilot with sight of a point of low relative movement on the ground.

Before using a ~~Category I~~ **CAT II** ILS for landing, the quality of the localiser between 50 ft and touchdown should be verified.

3. ~~Category III~~ **CAT III** fail-passive operations

Subpart E | Revised rule text

- a.3.1** ~~Category III~~ **Category III** operations utilising fail-passive automatic landing equipment were introduced in the late 1960's and it is desirable that the principles governing the establishment of the minimum RVR for such operations be dealt with in some detail.
- b.3.2** During an automatic landing the pilot needs to monitor the performance of the aircraft system, not in order to detect a failure which is better done by the monitoring devices built into the system, but so as to know precisely the flight situation. In the final stages ~~he/she~~ **the pilot** should establish visual contact and, by the time ~~he/she~~ **the pilot** reaches ~~decision height~~ **DH**, ~~he/she~~ **the pilot** should have checked the aircraft position relative to the approach or runway centre-line lights. For this ~~he/she~~ **the pilot** will need sight of horizontal elements (for roll reference) and part of the touchdown area. ~~He/she~~ **The pilot** should check for lateral position and cross-track velocity and, if not within the pre-stated lateral limits, ~~he/she~~ **the pilot** should carry out a ~~go-around~~ **missed approach procedure**. ~~He/she~~ **The pilot** should also check longitudinal progress and sight of the landing threshold is useful for this purpose, as is sight of the touchdown zone lights.
- c.3.3** In the event of a failure of the automatic flight guidance system below ~~decision height~~ **DH**, there are two possible courses of action; the first is a procedure which allows the pilot to complete the landing manually if there is adequate visual reference for him/her to do so, or to initiate a ~~go-around~~ **missed approach procedure** if there is not; the second is to make a ~~go-around~~ **missed approach procedure** mandatory if there is a system disconnect regardless of the pilot's assessment of the visual reference available:
- ia.** If the first option is selected then the overriding requirement in the determination of a minimum RVR is for sufficient visual cues to be available at and below ~~decision height~~ **DH** for the pilot to be able to carry out a manual landing. Data presented in Doc 17 showed that a minimum value of 300 ~~metres~~ **m** would give a high probability that the cues needed by the pilot to assess the aircraft in pitch and roll will be available and this should be the minimum RVR for this procedure.
- ii.** The second option, to require a ~~go-around~~ **missed approach procedure** to be carried out should the automatic flight-guidance system fail below ~~decision height~~ **DH**, will permit a lower minimum RVR because the visual reference requirement will be less if there is no need to provide for the possibility of a manual landing. However, this option is only acceptable if it can be shown that the probability of a system failure below ~~decision height~~ **DH** is acceptably low. It should be recognised that the inclination of a pilot who experiences such a failure would be to continue the landing manually but the results of flight trials in actual conditions and of simulator experiments show that pilots do not always recognise that the visual cues are inadequate in such situations and present recorded data reveal that pilots' landing performance reduces progressively as the RVR is reduced below 300 ~~metres~~ **m**. It should further be recognised that there is some risk in carrying out a manual ~~go-around~~ **missed approach procedure** from below 50 ft in very low visibility and it should therefore be accepted that if an RVR lower than 300 ~~metres~~ **m** is to be

Subpart E | Revised rule text

~~authorised~~**approved**, the flight deck procedure should not normally allow the pilot to continue the landing manually in such conditions and the aircraft system should be sufficiently reliable for the ~~go-around~~**missed approach procedure** rate to be low.

- d.3-4** These criteria may be relaxed in the case of an aircraft with a fail-passive automatic landing system which is supplemented by a head-up display which does not qualify as a fail-operational system but which gives guidance which will enable the pilot to complete a landing in the event of a failure of the automatic landing system. In this case it is not necessary to make a ~~go-around~~**missed approach procedure** mandatory in the event of a failure of the automatic landing system when the RVR is less than 300-~~metres~~ **m**.
4. ~~Category III~~**CAT III** fail operational operations - with a ~~Decision Height~~**DH**
- a.4.1** For ~~Category III~~**CAT III** operations utilising a fail-operational landing system with a ~~Decision Height~~**DH**, a pilot should be able to see at least ~~1-one~~ **centre line** ~~centreline~~ light.
- b.4.2** For ~~Category III~~**CAT III** operations utilising a fail-operational hybrid landing system with a ~~Decision Height~~**DH**, a pilot should have a visual reference containing a segment of at least ~~3-three~~ **consecutive** lights of the runway ~~centre line~~**centreline** lights.
5. ~~Category III~~**CAT III** fail operational operations - with ~~no~~ **No Decision Height**DH****
- a.5.1** For ~~Category III~~**CAT III** operations with ~~No Decision Height~~**DH** the pilot is not required to see the runway prior to touchdown. The permitted RVR is dependent on the level of aircraft equipment.
- b.5.2** A CAT III runway may be assumed to support operations with no ~~Decision Height~~**DH** unless specifically restricted as published in the AIP or NOTAM.

GM5-SPA.LVO.100 Low visibility operations**ILS CLASSIFICATION**

The ILS classification system is specified in ICAO Annex 10.

AMC2-SPA.LVO.105 LVO approval

OPERATIONAL DEMONSTRATION AND DATA COLLECTION/ANALYSIS

1. General
- a.1.1** Demonstrations may be conducted in line operations or any other flight where the ~~Operator's~~**operator's** procedures are being used.
- b.1.2** In unique situations where the completion of 100 successful landings could take an unreasonably long period of time due to factors such as a small number of aircraft in the fleet, limited opportunity to use runways having ~~Category II~~**CAT II/III** procedures, or inability to obtain ~~Air Traffic Services~~ (ATS) sensitive area protection during good weather conditions, and equivalent reliability assurance can be achieved, a reduction in the required number of landings may be considered on a case-by-case basis. Reduction of the number of landings to be demonstrated requires a justification for the

Comment [WS182]:
Corresponds to ACJ to Appendix 1 to JAR-OPS 1.440 and AMC2 OPS.SPA.001.LVO(b)(3).

Changes shown are to the NPA version.

Subpart E | Revised rule text

reduction. However, at the operator's option, demonstrations may be made on other runways and facilities. Sufficient information should be collected to determine the cause of any unsatisfactory performance (e.g. sensitive area was not protected).

~~c.1.3~~ If an operator ~~the operator~~ has different variants of the same type of aircraft utilising the same basic flight control and display systems, or different basic flight control and display systems on the same type ~~or~~ ~~classes~~ of aircraft, the operator should show that the various variants have satisfactory performance, but ~~the operator~~ need not conduct a full operational demonstration for each variant.

~~1.4d.~~ Not more than 30-~~%~~% of the demonstration flights should be made on the same runway.

2. Data collection for operational demonstrations

~~a.2.1~~ Data should be collected whenever an approach and landing is attempted utilising the ~~Category I~~ **CAT II/III** system, regardless of whether the approach is abandoned, unsatisfactory, or is concluded successfully.

~~b.2.2~~ The data should, as a minimum, include the following information:

- ~~ia.~~ Inability to initiate an approach. Identify deficiencies related to airborne equipment which preclude initiation of a ~~Category I~~ **CAT II/III** approach.
- ~~iib.~~ Abandoned approaches. Give the reasons and altitude above the runway at which approach was discontinued or the automatic landing system was disengaged.
- ~~iiie.~~ Touchdown or touchdown and ~~roll-out~~ **rollout** performance. Describe whether or not the aircraft landed satisfactorily (within the desired touchdown area) with lateral velocity or cross track error which could be corrected by the pilot or automatic system so as to remain within the lateral confines of the runway without unusual pilot skill or technique. The approximate lateral and longitudinal position of the actual touchdown point in relation to the runway centreline and the runway threshold, respectively, should be indicated in the report. This report should also include any ~~Category I~~ **CAT II/III** system abnormalities which required manual intervention by the pilot to ensure a safe touchdown or touchdown and ~~roll-out~~ **rollout**, as appropriate.

3. Data ~~a~~Analysis

~~3.1~~ Unsuccessful approaches due to the following factors may be excluded from the analysis:

- ~~aa.~~ ~~f~~ATS ~~f~~Factors. Examples include situations in which a flight is vectored too close to the final approach fix/point for adequate localiser and glide slope capture, lack of protection of ILS sensitive areas, or ATS requests the flight to discontinue the approach.
- ~~bb.~~ Faulty ~~n~~Navaid ~~s~~Signals. Navaid (e.g. ILS localiser) irregularities, such as those caused by other aircraft taxiing, over-flying the navaid (antenna).

Subpart E | Revised rule text

- ce. Other ~~f~~Factors. Any other specific factors that could affect the success of ~~Category II~~**CAT II**/ III operations that are clearly discernible to the flight crew should be reported.

GM1-SPA.LVO.105 LVO approvalCRITERIA FOR A SUCCESSFUL ~~CAT II~~, **OTS CAT, CAT III** APPROACH AND AUTOMATIC LANDING

1. The purpose of this ~~guidance material~~**GM** is to provide operators with supplemental information regarding the criteria for a successful approach and landing to facilitate fulfilling the requirements prescribed in ~~SPA.LVO.105.OPS.SPA.001.LVO(b)(3)~~.
2. An approach may be considered to be successful if:
 - ~~2-1a.f~~From 500-feet **ft** to start of flare:
 - ia. ~~s~~Speed is maintained as specified in AMC-AWO 231, paragraph 2 'Speed Control'; and
 - ii**b. n**No relevant system failure occurs; and
 - ~~2-2b. f~~From 300-feet **ft** to DH:
 - ia. no excess deviation occurs; and
 - ii**b. f**no centralised warning gives a ~~go-around~~**missed approach procedure** command (if installed).
3. An automatic landing may be considered to be successful if:
 - a. no relevant system failure occurs;
 - b. no flare failure occurs;
 - c. no de-crab failure occurs (if installed);
 - d. longitudinal touchdown is beyond a point on the runway 60-metres **m** -after the threshold and before the end of the touchdown zone ~~lighting~~**light** (900 metres **m** -from the threshold);
 - e. lateral touchdown with the outboard landing gear is not outside the touchdown zone ~~lighting~~**light** edge;
 - f. sink rate is not excessive;
 - g. bank angle does not exceed a bank angle limit; and
 - h. no ~~roll-out~~**rollout** failure or deviation (if installed) occurs.
4. More details can be found in CS-AWO 131, CS-AWO 231 and AMC-AWO 231.

Comment [WSI83]:
Corresponds to IEM to Appendix 1 to JAR-OPS 1.440, paragraph (b) and GM OPS.SPA.001.LVO(b)(3).

Changes show are to the NPA version.

GM1-SPA.LVO.120 Flight crew training and qualifications**FLIGHT CREW TRAINING**

The number of approaches referred to in ~~AMC1-SPA.LVO.120, 7.a. AMC OPS.SPA.001.LVO (b)(1) 7.1~~ includes one approach and landing that may be conducted in the aircraft using approved ~~Category II~~**CAT II**/III procedures. This approach and landing may be conducted in normal line operation or as a training flight.

Comment [WSI84]:
Corresponds to GM OPS.SPA.001.LVO(b)(1) and IEM OPS 1.450(g)(1).

Changes shown are to the NPA version.

EU-OPS Subpart F-I | Revised rule text

Scope

- This document shows the transposition of EU-OPS Subpart F-I into the new European OPS rules.
- It also contains the related Section 2 material of JAR-OPS 1.
- Track changes show changes to the EU-OPS text.

EU-OPS Subpart F-I | Revised rule text

Table of Contents

Annex I - Definitions for terms used in Annexes II - VI.....	6
Part-CAT.....	6
Subpart C - Aircraft performance and operating limitations	6
Section 1 - Aeroplanes.....	6
Chapter 1 - General requirements.....	6
CAT.POL.A.100 Performance classes.....	6
CAT.POL.A.105 General	7
Annex I - Definitions for terms used in Annexes II - VI.....	7
Part-CAT.....	9
Chapter 2 - Performance class A.....	9
CAT.POL.A.200 General	9
CAT.POL.A.205 Take-off	9
CAT.POL.A.210 Take-off obstacle clearance.....	10
CAT.POL.A.215 En-route – one-engine-inoperative (OEI)	11
CAT.POL.A.220 En-route – aeroplanes with three or more engines, two engines inoperative.....	12
CAT.POL.A.225 Landing – destination and alternate aerodromes.....	13
CAT.POL.A.230 Landing – dry runways	13
CAT.POL.A.235 Landing – wet and contaminated runways	14
CAT.POL.A.240 Approval of operations with increased bank angles.....	15
CAT.POL.A.245 Approval of steep approach operations	15
CAT.POL.A.250 Approval of short landing operations	16
Chapter 3 - Performance class B.....	18
CAT.POL.A.300 General	18
CAT.POL.A.305 Take-off	18
CAT.POL.A.310 Take-off obstacle clearance – multi-engined aeroplanes	19
CAT.POL.A.315 En-route – multi-engined aeroplanes.....	20
CAT.POL.A.320 En-route – single-engined aeroplanes.....	20
CAT.POL.A.325 Landing – destination and alternate aerodromes.....	21
CAT.POL.A.330 Landing – dry runways	21
CAT.POL.A.335 Landing – wet and contaminated runways	22
CAT.POL.A.340 General	22

EU-OPS Subpart F-I | Revised rule text

CAT.POL.A.345 Approval of steep approach operations	23
CAT.POL.A.350 Approval of short landing operations	24
Chapter 4 – Performance class C	26
CAT.POL.A.400 Take-off	26
CAT.POL.A.405 Take-off obstacle clearance	27
CAT.POL.A.410 En-route – all engines operating	28
CAT.POL.A.415 En-route – OEI	28
CAT.POL.A.420 En-route – aeroplanes with three or more engines, two engines inoperative	29
CAT.POL.A.425 Landing – destination and alternate aerodromes.....	29
CAT.POL.A.430 Landing – dry runways	29
CAT.POL.A.435 Landing – wet and contaminated runways	30
Subpart C – Aircraft performance and operating limitations – AMC/GM	31
Section 1 – Aeroplanes	31
Chapter 1 - General requirements.....	31
AMC1-CAT.POL.A.105 General	31
LANDING - REVERSE THRUST CREDIT	31
Chapter 2 - Performance class A	31
AMC1-CAT.POL.A.200 General	31
WET AND CONTAMINATED RUNWAY DATA.....	31
AMC1-CAT.POL.A.205 Take-off	31
LOSS OF RUNWAY LENGTH DUE TO ALIGNMENT	31
GM1-CAT.POL.A.205 Take-off	33
RUNWAY SURFACE CONDITION	33
AMC1-CAT.POL.A.210 Take-off obstacle clearance.....	33
TAKE-OFF OBSTACLE CLEARANCE	33
EFFECT OF BANK ANGLES.....	34
REQUIRED NAVIGATIONAL ACCURACY	35
GM1-CAT.POL.A.210 Take-off obstacle clearance	35
CONTINGENCY PROCEDURES FOR OBSTACLES CLEARANCES	35
AMC1-CAT.POL.A.215 En-route – one-engine-inoperative (OEI).....	36
ROUTE ANALYSIS	36
AMC1-CAT.POL.A.225 Landing – destination and alternate aerodromes .	37
MISSED APPROACH	37
ALTITUDE MEASURING.....	37

EU-OPS Subpart F-I | Revised rule text

AMC1-CAT.POL.A.230 Landing – dry runways	37
FACTORING OF AUTOMATIC LANDING DISTANCE PERFORMANCE DATA ...	37
LANDING MASS	37
Chapter 3 – Performance class B	38
AMC1-CAT.POL.A.305 Take-off	38
RUNWAY SURFACE CONDITION	38
RUNWAY SLOPE	39
GM1-CAT.POL.A.305 Take-off	39
RUNWAY SURFACE CONDITION	39
AMC1-CAT.POL.A.310 Take-off obstacle clearance – multi-engined aeroplanes	39
TAKE-OFF FLIGHT PATH – VISUAL COURSE GUIDANCE NAVIGATION	39
AMC2-CAT.POL.A.310 Take-off obstacle clearance – multi-engined aeroplanes	40
TAKE-OFF FLIGHT PATH CONSTRUCTION	40
GM1-CAT.POL.A.310 Take-off obstacle clearance – multi-engined aeroplanes	41
OBSTACLE CLEARANCE IN LIMITED VISIBILITY	41
GM2-CAT.POL.A.310 Take-off obstacle clearance – multi-engined aeroplanes	42
TAKE-OFF FLIGHT PATH CONSTRUCTION	42
GM1-CAT.POL.A.315 En-route – multi-engined aeroplanes	44
CRUISING ALTITUDE	44
AMC1-CAT.POL.A.320 En-route - single-engine aeroplanes	45
ENGINE FAILURE	45
GM1-CAT.POL.A.320 En-route – single-engine aeroplanes	45
ENGINE FAILURE	45
AMC1-CAT.POL.A.325 Landing – destination and alternate aerodromes .	45
ALTITUDE MEASURING	45
AMC1-CAT.POL.A.330 Landing – dry runways	45
LANDING DISTANCE CORRECTION FACTORS	45
GM1-CAT.POL.A.330 Landing – dry runways	46
LANDING MASS	46
GM1-CAT.POL.A.335 Landing - wet and contaminated runways	46
LANDING ON WET GRASS RUNWAYS	46
Chapter 4 – Performance class C	48

EU-OPS Subpart F-I | Revised rule text

AMC1-CAT.POL.A.400 Take-off	48
LOSS OF RUNWAY LENGTH DUE TO ALIGNMENT	48
RUNWAY SLOPE	49
GM1-CAT.POL.A.400 Take-off	50
RUNWAY SURFACE CONDITION	50
AMC1-CAT.POL.A.405 Take-off obstacle clearance.....	50
EFFECT OF BANK ANGLES.....	50
REQUIRED NAVIGATIONAL ACCURACY	50
AMC1-CAT.POL.A.415 En-route – OEI.....	51
ROUTE ANALYSIS	51
AMC1-CAT.POL.A.425 Landing – destination and alternate aerodromes .	52
ALTITUDE MEASURING.....	52
AMC1-CAT.POL.A.430 Landing – dry runways	52
LANDING DISTANCE CORRECTION FACTORS	52
RUNWAY SLOPE	53
GM1-CAT.POL.A.430 Landing - dry runways	53
LANDING MASS.....	53

EU-OPS Subpart F-I | Revised rule text

Annex I - Definitions for terms used in Annexes II - VI

SUBPART F PERFORMANCE GENERAL

'Performance class A aeroplanes' means multi-engined aeroplanes powered by turbo-propeller engines with a maximum passenger seating configuration of more than nine or a maximum take-off mass exceeding 5 700 kg, and all multi-engined turbo-jet powered aeroplanes.

~~(b) — An operator shall ensure that propeller driven aeroplanes with a maximum approved passenger seating configuration of 9 or less, and a maximum take off mass of 5 700 kg or less are operated in accordance with Subpart H (Performance Class B).~~ **'Performance class B aeroplanes'** means aeroplanes powered by propeller engines with a maximum passenger seating configuration of nine or less and a maximum take-off mass of 5 700 kg or less.

~~(c) — An operator shall ensure that aeroplanes powered by reciprocating engines with a maximum approved passenger seating configuration of more than 9 or a maximum take-off mass exceeding 5 700 kg are operated in accordance with Subpart I (Performance Class C).~~

'Performance class C aeroplanes' means aeroplanes powered by reciprocating engines with a maximum passenger seating configuration of more than nine or a maximum take-off mass exceeding 5 700 kg.

Part-CAT

Subpart C - Aircraft performance and operating limitations

Section 1 - Aeroplanes

Chapter 1 - General requirements

CAT.POL.A.100 Performance classes

- (a) **The aeroplane shall be operated in accordance with the applicable performance class requirements.**
- (b) Where full compliance with the **applicable** requirements of this **Section** e appropriate ~~Subpart~~ cannot be shown due to specific design characteristics (e.g. supersonic aeroplanes or seaplanes), the operator shall apply approved performance standards that ensure a level of safety equivalent to that of the appropriate ~~Subpart~~ **chapter**.

EU-OPS Subpart F-I | Revised rule text

~~OPS 1.475~~ **CAT.POL.A.105 General**

- (a) ~~An operator shall ensure that~~ The mass of the aeroplane:
- (1) ~~At~~ at the start of the take-off; or,
 - (2) in the event of in-flight re-planning, ~~(2) — At~~ at the point from which the revised operational flight plan applies,
- ~~is~~ shall not be greater than the mass at which the requirements of the appropriate ~~cSubpart~~ **chapter** can be complied with for the flight to be undertaken. ~~a~~ **Allowance may be made**ing for expected reductions in mass as the flight proceeds, and for such fuel jettisoning as is provided for in the particular requirement.
- (b) ~~An operator shall ensure that~~ The approved performance ~~d~~ **Data** contained in the ~~aircraft flight manual (AFM) is~~ shall be used to determine compliance with the requirements of the appropriate ~~cSubpart~~ **chapter**, supplemented as necessary with other data acceptable to the Authority as prescribed in the relevant ~~cSubpart~~ **chapter**. **The operator shall specify other data in the operations manual.** When applying the factors prescribed in the appropriate ~~cSubpart~~ **chapter**, account may be taken of any operational factors already incorporated in the ~~Aeroplane Flight Manual~~ **AFM** performance data to avoid double application of factors.
- (c) ~~When showing compliance with the requirements of the appropriate Subpart,~~ ~~d~~ **Due** account shall be taken of aeroplane configuration, environmental conditions and the operation of systems which have an adverse effect on performance.
- (d) For performance purposes, a damp runway, other than a grass runway, may be considered to be dry.
- (e) The operator shall take account of charting accuracy when assessing ~~compliance~~ with the take-off requirements of the applicable ~~csubpart~~ **chapters**.

Annex I - Definitions for terms used in Annexes II - VI~~OPS 1.480~~ **Terminology**

- (a) ~~The following terms used in Subparts F, G, H, I and J, have the following meaning:~~
- (1) 'Accelerate-stop distance available (ASDA)' ~~means:~~ ~~t~~ The length of the take-off run available plus the length of stop way, if such stop way is declared available by the appropriate Authority **State of the aerodrome** and is capable of bearing the mass of the aeroplane under the prevailing operating conditions.
 - (2) 'Contaminated runway' ~~means a~~ ~~— A~~ **runway of which** ~~is considered to be contaminated when more than 25 % of the runway surface area (whether in isolated areas or not) within the required length and width being used is covered by the following:~~
 - (i) ~~s~~ Surface water more than 3 mm (0.125 in) deep, or by slush, or loose snow, equivalent to more than 3 mm (0.125 in) of water;

EU-OPS Subpart F-I | Revised rule text

- (ii) ~~s~~Snow which has been compressed into a solid mass which resists further compression and will hold together or break into lumps if picked up (compacted snow); or
 - (iii) ~~i~~Ice, including wet ice.
- (3) 'Damp runway' ~~means a~~ **means a** runway is considered damp when ~~where~~ the surface is not dry, but when the moisture on it does not give it a shiny appearance.
 - (4) 'Dry runway' ~~means a~~ **means a** dry runway is ~~one~~ which is neither wet nor contaminated, and includes those paved runways which have been specially prepared with grooves or porous pavement and maintained to retain "effectively dry" braking action even when moisture is present.
 - (5) 'Landing distance available (LDA)' ~~means~~ **means** ~~the~~ length of the runway which is declared available by the ~~appropriate Authority~~ **State of the aerodrome** and suitable for the ground run of an aeroplane landing.
 - (6) 'Maximum approved passenger seating configuration (MPSC)' ~~means~~ **means** ~~the~~ maximum passenger seating capacity of an individual ~~aeroplane~~ **aircraft**, excluding ~~crew~~ **crew** pilot seats ~~as established during the certification process.~~ **as established during the certification process.** ~~of flight deck seats and cabin crew seats as applicable, used by the operator, approved by the Authority and specified in the Operations Manual.~~
 - (7) 'Take-off distance available (TODA)' ~~means~~ **means** ~~the~~ length of the take-off run available plus the length of the clearway ~~available~~, **if provided.**
 - (8) 'Take-off mass' ~~means~~ **means** ~~t.~~ The take-off mass of the aeroplane shall be taken to be ~~its mass,~~ including everything and everyone carried at the commencement of the **take-off for helicopters and take-off run for aeroplanes.**
 - (9) 'Take-off run available (TORA)' ~~means~~ **means** ~~the~~ length of runway which is declared available by the ~~appropriate Authority~~ **State of the aerodrome** and suitable for the ground run of an aeroplane taking off.
 - (10) 'Wet runway' ~~means~~ **means** ~~a~~ runway is considered wet when the runway ~~of which~~ **the** surface is covered with water, or equivalent, less than specified in ~~subparagraph (a)(2) above~~ **by the contaminated runway definition** or when there is sufficient moisture on the runway surface to cause it to appear reflective, but without significant areas of standing water.
 - (b) ~~The terms "accelerate stop distance", "take-off distance", "take off run", "net take-off flight path", "one engine inoperative en-route net flight path" and "two engines inoperative en-route net flight path" as relating to the aeroplane have their meanings defined in the airworthiness requirements under which the aeroplane was certificated, or as specified by the Authority if it finds that definition inadequate for showing compliance with the performance operating limitations.~~

Part-CAT**SUBPARTGChapter 2 - Performance class APERFORMANCE CLASS A****OPS 1.485CAT.POL.A.200 General**

- (a) ~~An operator shall ensure that, for determining compliance with the requirements of this Subpart, t~~The approved performance data in the ~~Aeroplane Flight Manual~~ **AFM is shall be** supplemented as necessary with other data acceptable to the ~~Authority~~ if the approved performance ~~d~~Data in the ~~Aeroplane Flight Manual~~ **AFM** is insufficient in respect of items such as:
- (1) ~~a~~Accounting for reasonably expected adverse operating conditions such as take-off and landing on contaminated runways; and
 - (2) ~~c~~Consideration of engine failure in all flight phases.
- (b) ~~An operator shall ensure that, f~~For the wet and contaminated runways ~~case,~~ performance data determined in accordance with applicable ~~requirements~~ **standards** on certification of large aeroplanes or equivalent ~~acceptable to the Authority~~ **is shall be** used.
- (c) **The use of other data referred to in (a) and equivalent requirements referred to in (b) shall be specified in the operations manual.**

OPS 1.490CAT.POL.A.205 Take-off

- (a) ~~An operator shall ensure that t~~The take-off mass ~~does~~ **shall** not exceed the maximum take-off mass specified in the ~~Aeroplane Flight Manual~~ **AFM** for the pressure altitude and the ambient temperature at the aerodrome at which the take-off is to be made.
- (b) ~~An operator must meet t~~The following requirements **shall be met** when determining the maximum permitted take-off mass:
- (1) ~~t~~The accelerate-stop distance ~~must~~**shall** not exceed the accelerate-stop distance available **(ASDA)**;
 - (2) ~~t~~The take-off distance ~~must~~**shall** not exceed the take-off distance available, with a clearway distance not exceeding half of the take-off run available **(TORA)**;
 - (3) ~~t~~The take-off run ~~must~~**shall** not exceed the ~~take-off run available~~**TORA**;
 - (4) ~~a~~Compliance with this paragraph ~~must be shown using a~~ **A** single value of V_1 **shall be used** for the rejected and continued take-off; and
 - (5) ~~On~~ **on** a wet or contaminated runway, the take-off mass ~~must~~**shall** not exceed that permitted for a take-off on a dry runway under the same conditions.
- (c) When showing compliance with ~~subparagraph (b) above,~~ ~~an operator must~~**the following shall be taken into account of the following:**
- (1) ~~t~~The pressure altitude at the aerodrome;

EU-OPS Subpart F-I | Revised rule text

- (2) ~~t~~The ambient temperature at the aerodrome;
- (3) ~~t~~The runway surface condition and the type of runway surface;
- (4) ~~t~~The runway slope in the direction of take-off;
- (5) ~~n~~Not more than 50 % of the reported head-wind component or not less than 150 % of the reported tailwind component; and
- (6) ~~t~~The loss, if any, of runway length due to alignment of the aeroplane prior to take-off.

OPS 1.495CAT.POL.A.210 Take-off obstacle clearance

- (a) ~~An operator shall ensure that t~~The net take-off flight path **shall be determined in such a way that the aeroplane** clears all obstacles by a vertical distance of at least 35 ft or by a horizontal distance of at least 90 m plus $0.125 \times D$, where D is the horizontal distance the aeroplane has travelled from the end of the take-off distance available (**TODA**) or the end of the take-off distance if a turn is scheduled before the end of the ~~take-off distance available~~**TODA**. For aeroplanes with a wingspan of less than 60 m, a horizontal obstacle clearance of half the aeroplane wingspan plus 60 m, plus $0.125 \times D$ may be used.
- (b) When showing compliance with ~~subparagraph (a) above;~~ ~~an operator must take account of the~~
 - (1) The following items shall be taken into account:**
 - (i) ~~t~~The mass of the aeroplane at the commencement of the take-off run;
 - (ii) ~~t~~The pressure altitude at the aerodrome;
 - (iii) ~~t~~The ambient temperature at the aerodrome; and
 - (iv) ~~n~~Not more than 50 % of the reported head-wind component or not less than 150 % of the reported tailwind component.
- ~~(c) When showing compliance with subparagraph (a) above:~~
 - (1) Track changes shall not be allowed up to the point at which the net take-off flight path has achieved a height equal to one half the wingspan but not less than 50 ft above the elevation of the end of the ~~take-off run available~~**TORA**. Thereafter, up to a height of 400 ft it is assumed that the aeroplane is banked by no more than 15°. Above 400 ft height bank angles greater than 15°, but not more than 25° may be scheduled;
 - (2) Any part of the net take-off flight path in which the aeroplane is banked by more than 15° ~~must~~**shall** clear all obstacles within the horizontal distances specified in ~~subparagraphs (a), (b) and (c) of this paragraph~~**(6) and (7)e) of this paragraph** by a vertical distance of at least 50 ft; ~~and.~~
 - (3) ~~An operator must use special procedures, subject to the approval of the Authority,~~**Operations which** ~~to~~ apply increased bank angles of not more than 20° between 200 ft and 400 ft, or not more than 30° above 400 ft **shall be carried out in accordance with CAT.POL.A.240.** ~~(See Appendix 1 to OPS 1.495 (c) (3)).~~

EU-OPS Subpart F-I | Revised rule text

- (45) Adequate allowance ~~must~~**shall** be made for the effect of bank angle on operating speeds and flight path including the distance increments resulting from increased operating speeds.
- (6d) ~~When showing compliance with subparagraph (a) above~~ **For** those cases where the intended flight path does not require track changes of more than 15°, the operator **does not need not to** consider those obstacles which have a lateral distance greater than:
- (1i) 300 m, if the pilot is able to maintain the required navigational accuracy through the obstacle accountability area; or
- (2ii) 600 m, for flights under all other conditions.
- (7e) ~~When showing compliance with subparagraph (a) above for those~~ **For** cases where the intended flight path ~~does~~**requires** track changes of more than 15°, the operator **does not need not to** consider those obstacles which have a lateral distance greater than:
- (1i) 600 m, if the pilot is able to maintain the required navigational accuracy through the obstacle accountability area; or
- (2ii) 900 m, for flights under all other conditions.
- (8f) **In the event of an engine failure during take-off, the aeroplane shall be able to clear all obstacles along the flight path by an adequate margin until the aeroplane is in a position to comply with CAT.POL.A.215.** The operator shall establish contingency procedures **for such an event.** ~~to satisfy the requirements of OPS 1.495 and to provide a safe route, avoiding obstacles, to enable the aeroplane to either comply with the en-route requirements of OPS 1.500, or land at either the aerodrome of departure or at a take-off alternate aerodrome.~~

Comment [WS11]:
Text aligned with ICAO Annex 6 Part I 5.2.8. The term "adequate margin" is illustrated by examples in Attachment C of Annex 6 Part I.

~~OPS 1.500~~**CAT.POL.A.215 En-route – one-engine-inoperative (one engine inoperativeOEI)**

- (a) ~~An operator shall ensure that~~ **The one engine inoperativeOEI** en-route net flight path data shown in the AFM, appropriate to the meteorological conditions expected for the flight, **shall allow demonstration of compliance** ~~ies~~ with either ~~subparagraph (b) or (c) at all points along the route.~~ The net flight path ~~must~~**shall** have a positive gradient at 1 500 ft above the aerodrome where the landing is assumed to be made after engine failure. In meteorological conditions requiring the operation of ice protection systems, the effect of their use on the net flight path ~~must~~**shall** be taken into account.
- (b) The gradient of the net flight path ~~must~~**shall** be positive at ~~at least~~ 1 000 ft above all terrain and obstructions along the route within 9.3 km (5 ~~nm~~**NM**) on either side of the intended track.
- (c) The net flight path ~~must~~**shall** permit the aeroplane to continue flight from the cruising altitude to an aerodrome where a landing can be made in accordance with ~~OPS 1.515~~**CAT.POL.A.225** or **CAT.POL.A.1.520-230**, as appropriate. ~~The~~ **the** net flight path ~~shall~~ **clearing** vertically, by at least 2 000 ft, all terrain and obstructions along the route within 9.3 km (5 ~~nm~~**NM**) on either side of the intended track in accordance with ~~subparagraphs (1) to (4) below~~ **the following**:

EU-OPS Subpart F-I | Revised rule text

- (1) ~~t~~The engine is assumed to fail at the most critical point along the route;
 - (2) ~~a~~Account is taken of the effects of winds on the flight path;
 - (3) ~~f~~Fuel jettisoning is permitted to an extent consistent with reaching the aerodrome with the required fuel reserves, if a safe procedure is used; and
 - (4) ~~t~~The aerodrome where the aeroplane is assumed to land after engine failure ~~must~~**shall** meet the following criteria:
 - (i) ~~t~~The performance requirements at the expected landing mass are met; and
 - (ii) ~~w~~Weather reports **and/or** forecasts ~~, or any combination thereof,~~ and field condition reports indicate that a safe landing can be accomplished at the estimated time of landing.
- (d) ~~When showing compliance with OPS 1.500, a~~The operator ~~must~~**shall** increase the width margins of ~~subparagraphs (b) and (c) above to 18,5 km (10 nmNM) if the navigational accuracy does not meet~~ **at least required navigation performance 5 (RNP5)** ~~the 95 % containment level.~~

Comment [WSI2]:
Revised in accordance with recommendations of the RG.

~~OPS 1.505~~**CAT.POL.A.220 En-route – a**~~Aeroplanes w~~**With t**~~Three o~~**r m**~~More e~~**Engines, t**~~Two e~~**Engines i**~~n~~**operative**

- (a) ~~An operator shall ensure that a~~**At** no point along the intended track ~~will~~**shall** an aeroplane having three or more engines be more than 90 minutes, at the all-engines long range cruising speed at standard temperature in still air, away from an aerodrome at which the performance requirements applicable at the expected landing mass are met, unless it complies with ~~subparagraphs (b) to (f) below.~~
- (b) The two~~—~~engines~~—~~inoperative en-route net flight path data ~~must~~**shall permit allow** the aeroplane to continue the flight, in the expected meteorological conditions, from the point where two engines are assumed to fail simultaneously, to an aerodrome at which it is possible to land and come to a complete stop when using the prescribed procedure for a landing with two engines inoperative. The net flight path ~~must~~**shall** clear vertically, by at least 2 000 ft, all terrain and obstructions along the route within 9,3 km (5 ~~nmNM~~) on either side of the intended track. At altitudes and in meteorological conditions requiring ice protection systems to be operable, the effect of their use on the net flight path data ~~must~~**shall** be taken into account. If the navigational accuracy does not meet **at least RNP5** ~~the 95 % containment level,~~ the operator ~~must~~**shall** increase the width margin given above to 18,5 km (10 ~~nmNM~~).
- (c) The two engines ~~are~~**shall be** assumed to fail at the most critical point of that portion of the route where the aeroplane is more than 90 minutes, at the all-engines long range cruising speed at standard temperature in still air, away from an aerodrome at which the performance requirements applicable at the expected landing mass are met.
- (d) The net flight path ~~must~~**shall** have a positive gradient at 1 500 ft above the aerodrome where the landing is assumed to be made after the failure of two engines.

Comment [WSI3]:
Revised in accordance with recommendations of the RG.

EU-OPS Subpart F-I | Revised rule text

- (e) Fuel jettisoning **shall be** ~~is permitted~~ to an extent consistent with reaching the aerodrome with the required fuel reserves, if a safe procedure is used.
- (f) The expected mass of the aeroplane at the point where the two engines are assumed to fail ~~must~~**shall** not be less than that which would include sufficient fuel to proceed to an aerodrome where the landing is assumed to be made, and to arrive there at least 1 500 ft directly over the landing area and thereafter to fly level for 15 minutes.

OPS 1.510CAT.POL.A.225 Landing – ~~d~~Destination ~~a~~And ~~a~~Alternate ~~a~~Aerodromes

- (a) ~~An operator shall ensure that~~ the landing mass of the aeroplane determined in accordance with **CAT.POL.A.105** ~~OPS 1.475 (a) does~~**shall** not exceed the maximum landing mass specified for the altitude and the ambient temperature expected for the estimated time of landing at the destination **aerodrome** and alternate aerodrome.
- (b) For instrument approaches with a missed approach **climb** gradient greater than 2,75 %, the operator shall verify that the expected landing mass of the aeroplane allows **for** a missed approach with a climb gradient equal to or greater than the applicable missed approach gradient in the ~~one engine inoperative~~**OEI** missed approach configuration and **at the associated** speed ~~(see applicable requirements on certification of large aeroplanes). The use of an alternative method must be approved by the Authority.~~
- (c) For instrument approaches with decision heights below 200 ft, the operator ~~must~~**shall** verify that the expected landing mass of the aeroplane allows a missed approach gradient of climb, with the critical engine failed and with the speed and configuration used for **a missed approach** ~~around~~ of at least 2,75 %, or the published gradient, whichever is the greater ~~(see CS AWO 243). The use of an alternative method must be approved by the Authority.~~

Comment [WSI4]:
The alternative method requires an Article 14 procedure.

Comment [WSI5]:
The alternative method requires an Article 14 procedure.

OPS 1.515CAT.POL.A.230 Landing – dry runways

- (a) ~~An operator shall ensure that~~ the landing mass of the aeroplane determined in accordance with **CAT.POL.A.105** ~~OPS 1.475 (a)~~ for the estimated time of landing at the destination aerodrome and at any alternate aerodrome **shall** allow a full stop landing from 50 ft above the threshold:
 - (1) ~~f~~For turbo-jet powered aeroplanes, within 60 % of the landing distance available (**LDA**); ~~and~~
 - (2) ~~f~~For turbo-propeller powered aeroplanes, within 70 % of the **LDA** ~~landing distance available.~~
- (~~b~~3) ~~F~~For ~~s~~Steep ~~A~~Approach procedures~~operations~~, the operator shall the Authority may approve the use of ~~the~~ landing distance ~~Data~~**data** factored in accordance with subparagraphs (a)(1) and (a)(2) above, as appropriate, based on a screen height of less than 50 ~~60~~ ft, but not less than 35 ft, **and shall comply with CAT.POL.A.245** ~~(See Appendix 1 to OPS 1.515(a)(3)).~~
- (c4) **For short landing operations, the operator shall** ~~When showing compliance with use the landing distance data factored in accordance with subparagraphs (a)(1) and (a)(2) above and shall comply with~~

Comment [WSI6]:
Revised to be consistent with NPA 25B-267 and the proposal of the JAA Performance Sub-Committee.

EU-OPS Subpart F-I | Revised rule text

~~CAT.POL.A.250.~~ the Authority may exceptionally approve, when satisfied that there is a need (see Appendix 1) the use of Short Landing Operations in accordance with Appendices 1 and 2 together with any other supplementary conditions that the Authority considers necessary in order to ensure an acceptable level of safety in the particular case.

- (~~b~~**d**) **For determining the landing mass,** ~~t~~When showing compliance with subparagraph (a) above, ~~an~~ operator ~~must~~**shall** take **the following** into account of the following:
- (1) the altitude at the aerodrome;
 - (2) not more than 50 % of the head-wind component or not less than 150 % of the tailwind component; and
 - (3) the runway slope in the direction of landing if greater than +/-2 %.
- (~~e~~**e**) **For dispatching the aeroplane** ~~i~~When showing compliance with subparagraph (a) above, ~~it t~~ ~~must~~**shall** be assumed that:
- (1) ~~t~~The aeroplane will land on the most favourable runway, in still air; and
 - (2) ~~t~~The aeroplane will land on the runway most likely to be assigned, considering the probable wind speed and direction and the ground handling characteristics of the aeroplane, and ~~considering~~ other conditions such as landing aids and terrain.
- (~~f~~**f**) If ~~an~~**the** operator is unable to comply with subparagraph (~~e~~**e**)(1) above for a destination aerodrome having a single runway where a landing depends upon a specified wind component, ~~an~~**the** aeroplane may be ~~d~~iespatched if ~~2~~**two** alternate aerodromes are designated which permit full compliance with subparagraphs (a), ~~to~~ (b) and (~~e~~**e**). Before commencing an approach to land at the destination aerodrome, the commander ~~must~~**shall** ~~satisfy himself/herself~~ **check that** ~~if~~ a landing can be made in full compliance with ~~OPS 1.510~~ **CAT.POL.A.225** and subparagraphs (a) ~~to~~ and (~~b~~**b**) above.
- (~~g~~**g**) If ~~an~~**the** operator is unable to comply with subparagraph (~~e~~**e**)(2) above for the destination aerodrome, the aeroplane ~~may~~**shall** be ~~only~~ **only** ~~d~~iespatched if an alternate aerodrome is designated which ~~permits~~**allows** full compliance with subparagraphs (a) ~~to~~ , (b) and (~~e~~**e**) **above**.

~~OPS 1.520~~**CAT.POL.A.235 Landing – w**Wet and contaminated runways

- (a) ~~An operator shall ensure that w~~When the appropriate weather reports **and**/or forecasts, ~~or a combination thereof,~~ indicate that the runway at the estimated time of arrival may be wet, the ~~landing distance available~~**LDA is** ~~is~~ **shall be** at least 115 % of the required landing distance, determined in accordance with ~~CAT.POL.A.230~~**OPS 1.515**.
- (b) ~~An operator shall ensure that w~~When the appropriate weather reports **and**/or forecasts, ~~or a combination thereof,~~ indicate that the runway at the estimated time of arrival may be contaminated, the ~~landing distance available~~**LDA must** ~~shall~~ be at least the landing distance determined in accordance with subparagraph (a) above, or at least 115 % of the landing distance determined in accordance with approved contaminated landing distance data or equivalent, ~~accepted by the~~

EU-OPS Subpart F-I | Revised rule text

Authority, whichever is greater. **The operator shall specify in the operations manual if equivalent landing distance data are to be applied.**

- (c) A landing distance on a wet runway shorter than that required by ~~subparagraph (a) above~~, but not less than that required by ~~OPS 1.515~~ **CAT.POL.A.230(a)**, may be used if the ~~Aeroplane Flight Manual~~ **AFM** includes specific additional information about landing distances on wet runways.
- (d) A landing distance on a specially prepared contaminated runway shorter than that required by ~~subparagraph (b) above~~, but not less than that required by ~~OPS 1.515~~ **CAT.POL.A.230 (a)**, may be used if the ~~Aeroplane Flight Manual~~ **AFM** includes specific additional information about landing distances on contaminated runways.
- (e) ~~When showing compliance with~~ **For** ~~subparagraphs (b), (c) and (d) above~~, the criteria of ~~OPS 1.515~~ **CAT.POL.A.230** shall be applied accordingly, except that ~~OPS 1.515~~ **CAT.POL.A.230(a)(1) and (2)** shall not be applied to ~~subparagraph (b) above~~.

Appendix 1 to OPS 1.495 (c)(3) CAT.POL.A.240 Approval of operations with of increased bank angles

- (a) **Operations with increased bank angles require prior approval from the competent authority.**
- (b) ~~For the use of the increased bank angles requiring special approval~~ **To obtain the approval, the operator shall provide evidence that** the following ~~criteria~~ **conditions** shall ~~be~~ **met**:
 - (1) ~~The Aeroplane Flight Manual~~ **AFM** ~~must~~ **contains** approved data for the required increase of operating speed and data to allow the construction of the flight path considering the increased bank angles and speeds;-
 - (2) ~~Visual guidance must be~~ **is** available for navigation accuracy;-
 - (3) ~~Weather minima and wind limitations must be~~ **are** specified for each runway ~~and approved by the Authority; and~~
- (4) **the flight crew has obtained adequate knowledge of the route to be flown and of the procedures to be used** ~~Training~~ **in accordance with OPS 1.975** ~~OR OPS.FC.~~

Appendix 1 to OPS 1.515 (a)(3) CAT.POL.A.245 Approval of sSteep aApproach Proceduresoperations

- (a) ~~The Authority may approve the application of Steep aApproach proceduresoperations~~ using glide-slope angles of 4,5° or more and with screen heights of less than ~~50~~ **60** ft, but not less than 35 ft, **require prior approval from the competent authority.**, ~~provided that the~~
- (b) **To obtain the approval, the operator shall provide evidence that the** following ~~criteria~~ **conditions** are met:

Comment [WSI7]:
Revised to be consistent with NPA 25B-267 and the proposal of the JAA Performance Sub-Committee.

EU-OPS Subpart F-I | Revised rule text

- (1) ~~t~~The ~~Aeroplane Flight Manual~~ **AFM** ~~must~~ states the maximum approved glide slope angle, any other limitations, normal, abnormal or emergency procedures for the steep approach as well as amendments to the field length data when using steep approach criteria;
- (2) **for each aerodrome at which steep approach operations are to be conducted:**
- (2i) ~~a~~A suitable glide path reference system comprising at least a visual glide path indicating system ~~must be~~ **shall be** available ~~at each aerodrome at which steep approach procedures are to be conducted;~~ and
- (3ii) ~~Weather~~ **weather** minima ~~must be~~ **shall be** specified ~~and approved for each runway to be used with a steep approach.;~~ and
- (iii) **the following items shall be taken into consideration** ~~Consideration must be given to the following:~~
- (A~~i~~) ~~t~~The obstacle situation;
- (B~~ii~~) ~~t~~The type of glide path reference and runway guidance ~~such as visual aids, MLS, 3D NAV, ILS, LLZ, VOR, NDB;~~
- (C~~iii~~) ~~t~~The minimum visual reference to be required at **decision height (DH)** and **minimum descent altitude (MDA)**;
- (D~~iv~~) ~~a~~Available airborne equipment;
- (E~~v~~) ~~p~~Pilot qualification and special aerodrome familiarisation;
- (F~~vi~~) ~~Aeroplane Flight Manual~~ **AFM** limitations and procedures; and
- (G~~vii~~) ~~m~~Missed approach criteria.

Appendix 1 to OPS 1.515 (a)(4) CAT.POL.A.250 Approval of sShort Landing oOperations

- (a) **Short landing operations require prior approval from the competent authority.**
- (b) **To obtain the approval, the operator shall provide evidence that the following conditions are met:**
- (1) ~~(a) — For the purpose of OPS 1.515 (a)(4), the distance used for the calculation of the permitted landing mass may consist of the usable length of the declared safe area plus the declared landing distance available~~ **LDA**;
- ~~The Authority may approve such operations in accordance with the following criteria:~~
- (12) ~~Demonstration of the need for Short Landing Operations. The~~ **the State of the aerodrome has determined** ~~re must be a clear public interest and operational necessity for the operation, either due to the remoteness of the airport~~ **aerodrome** or to physical limitations relating to extending the runway;
- (23) ~~Aeroplane and Operational Criteria.~~

EU-OPS Subpart F-I | Revised rule text

- (i) ~~Short landing operations will only be approved for aeroplanes where the vertical distance between the path of the pilot's eye and the path of the lowest part of the wheels, with the aeroplane established on the normal glide path, does not exceed 3 metres;-~~
- (4ii) ~~When establishing aerodrome operating minima the visibility/RVR/**VIS minimum** must~~**shall** not be less than 1: 500 km **and** .~~In addition, wind limitations must be~~**are** specified in the ~~Operations Manual~~**operations manual**;-
- (iii) ~~5 m~~**Minimum** pilot experience, training ~~requirements~~ and special aerodrome familiarisation **requirements** ~~must be~~**are** specified **and met** for such operations in the ~~Operations Manual~~;-
- (63) ~~It is assumed that the crossing height over the beginning of the usable length of the declared safe area is~~**is** 50 ft;-
- (4) ~~Additional criteria. The Authority may impose such additional conditions as are deemed necessary for a safe operation taking into account the aeroplane type characteristics, orographic characteristics in the approach area, available approach aids and missed approach/balked landing considerations. Such additional conditions may be, for instance, the requirement for VASI/PAPI type visual slope indicator system.~~

Appendix 2 to OPS 1.515(a)(4) Airfield Criteria for Short Landing Operations

Comment [WSI8]:
Deleted because it has the nature of an GM.

- (a7) ~~The use of the **declared** safe area must be~~**is** approved by the **State of the aerodrome**;~~airport authority.~~
- (b8) ~~The usable length of the declared safe area under the provisions of 1.515 (a)(4), and this Appendix, must~~**does** not exceed 90 meters;-
- (e9) ~~The width of the declared safe area shall~~**is** not be less than twice the runway width or twice the wing span, whichever is ~~the~~ greater, centred on the extended runway centre line;-
- (d10) ~~The declared safe area must be~~**is** clear of obstructions or depressions which would endanger an aeroplane undershooting the runway and no mobile object ~~shall be~~**is** permitted on the declared safe area while the runway is being used for short landing operations;-
- (e11) ~~The slope of the declared safe area must~~**does** not exceed 5 % upward nor 2 % downward in the direction of landing; **and**-
- (f) ~~For the purpose of this operation, the bearing strength requirement of OPS 1.480 (a)(5) need not apply to the declared safe area.~~
- (12) additional conditions, if specified by the competent authority, taking into account aeroplane type characteristics, orographic characteristics in the approach area, available approach aids and missed approach/balked landing considerations.**

Comment [WSI9]:
EU-OPS text is ambiguous. There is no bearing strength requirement in OPS 1.480.

EU-OPS Subpart F-I | Revised rule text

~~SUBPART H~~ Chapter 3 - Performance class B

~~OPS 1.525~~ CAT.POL.A.300 General

- (a) The operator shall not operate a single-engine aeroplane:
- (1) at night; or
 - (2) in ~~i~~Instrument ~~m~~Meteorological ~~c~~Conditions (**IMC**) except under ~~s~~Special ~~v~~Visual ~~f~~Flight ~~r~~Rules **VFR**.

~~Note: Limitations on the operation of single engine aeroplanes are covered by OPS 1.240 (a)(6).~~

Comment [WSI10]:
Accordingly to the drafting guidelines, Notes should not be used in IR.

- (b) The operator shall treat two-engined aeroplanes which do not meet the ~~certain~~ climb requirements **of CAT.POL.A.340** of ~~Appendix 1 to OPS 1.525 (b)~~ as single-engine aeroplanes.

~~OPS 1.530~~ CAT.POL.A.305 Take-off

- (a) ~~An operator shall ensure that t~~The take-off mass ~~does~~ **shall** not exceed the maximum take-off mass specified in the ~~Aeroplane Flight Manual~~ **AFM** for the pressure altitude and the ambient temperature at the aerodrome at which the take-off is to be made.
- (b) ~~An operator shall ensure that t~~The unfactored take-off distance, ~~as~~ specified in the ~~Aeroplane Flight Manual~~ **AFM**, ~~does~~ **shall** not exceed:
- (1) when multiplied by a factor of 1,725, the take-off run available (**TORA**); or
 - (2) ~~w~~When stop way and/or clearway is available, the following:
 - (i) ~~t~~The take-off run available **TORA**;
 - (ii) ~~w~~When multiplied by a factor of 1,715, the take-off distance available (**TODA**); ~~and~~ or
 - (iii) ~~w~~When multiplied by a factor of 1,73, the ~~accelerate-stop distance available~~ **ASDA**.
- (c) When showing compliance with ~~subparagraph (b) above,~~ ~~an operator~~ **the following shall be taken into account of the following:**
- (1) the mass of the aeroplane at the commencement of the take-off run;
 - (2) the pressure altitude at the aerodrome;
 - (3) the ambient temperature at the aerodrome;
 - (4) the runway surface condition and the type of runway surface;
 - (5) the runway slope in the direction of take-off; and
 - (6) not more than 50 % of the reported head-wind component or not less than 150 % of the reported tail-wind component.

OPS 1.535CAT.POL.A.310 Take-off obstacle clearance - multi-engine aeroplanes

- (a) ~~An operator shall ensure that~~ The take-off flight path of aeroplanes with two or more engines **shall be** ~~determined in such a way that the aeroplane in accordance with this subparagraph,~~ clears all obstacles by a vertical margin **distance** of at least 50 ft, or by a horizontal distance of at least 90 m plus $0,7125 \times D$, where D is the horizontal distance travelled by the aeroplane from the end of the ~~take-off distance available~~ **TODA** or the end of the take-off distance if a turn is scheduled before the end of the ~~take-off distance available~~ **TODA** except as provided in ~~subparagraphs (b) and (c) below.~~ For aeroplanes with a wingspan of less than 60 m, a horizontal obstacle clearance of half the aeroplane wingspan plus 60 m, plus $0,7125 \times D$ may be used. ~~When showing compliance with this subparagraph it must~~ **shall** be assumed that:
- (1) the take-off flight path begins at a height of 50 ft above the surface at the end of the take-off distance required by ~~OPS 1.530CAT.POL.A.305~~-(b) and ends at a height of 1 500 ft above the surface;
 - (2) the aeroplane is not banked before the aeroplane has reached a height of 50 ft above the surface, and ~~that~~ thereafter the angle of bank does not exceed 15°;
 - (3) failure of the critical engine occurs at the point on the all engine take-off flight path where visual reference for the purpose of avoiding obstacles is expected to be lost;
 - (4) the gradient of the take-off flight path from 50 ft to the assumed engine failure height is equal to the average all-engines gradient during climb and transition to the en-route configuration, multiplied by a factor of $0,777$; and
 - (5) the gradient of the take-off flight path from the height reached in accordance with ~~subparagraph (a)~~ **(a)**(4) above to the end of the take-off flight path is equal to the ~~one engine inoperative~~ **OEI** en-route climb gradient shown in the AFM.
- (b) ~~When showing compliance with subparagraph (a) above~~ For those cases where the intended flight path does not require track changes of more than 15°, the operator **does not need** ~~not to~~ consider those obstacles which have a lateral distance greater than:
- (1) 300 m, if the flight is conducted under conditions allowing visual course guidance navigation, or if navigational aids are available enabling the pilot to maintain the intended flight path with the same accuracy ~~(see Appendix 1 to OPS 1.535 (b)(1) & (c)(1))~~; or
 - (2) 600 m, for flights under all other conditions.
- (c) ~~When showing compliance with subparagraph (a) above~~ For those cases where the intended flight path requires track changes of more than 15°, the operator **does not need** ~~not to~~ consider those obstacles which have a lateral distance greater than:
- (1) 600 m, for flights under conditions allowing visual course guidance navigation ~~(see Appendix 1 to OPS 1.535 (b)(1) & (c)(1))~~; **or**

EU-OPS Subpart F-I | Revised rule text

- (2) 900 m, for flights under all other conditions.
- (d) When showing compliance with ~~subparagraphs (a) to (b) and (c) above~~, ~~an operator~~ **the following must/shall be taken into account of the following:**
- (1) the mass of the aeroplane at the commencement of the take-off run;
 - (2) the pressure altitude at the aerodrome;
 - (3) the ambient temperature at the aerodrome; and
 - (4) not more than 50 % of the reported head-wind component or not less than 150 % of the reported tail-wind component.

OPS 1.540CAT.POL.A.315 En-route – multi-engined aeroplanes

- (a) ~~An operator shall ensure that~~ **The aeroplane, in the meteorological conditions expected for the flight, and in the event of the failure of one engine, with the remaining engines operating within the maximum continuous power conditions specified, is shall be capable of continuing flight at or above the relevant minimum altitudes for safe flight stated in the Operations Manual operations manual to a point 1 000 ft above an aerodrome at which the performance requirements can be met.**
- (b) ~~When showing compliance with subparagraph (a) above~~ **It shall be assumed that, at the point of engine failure:**
- (1) the aeroplane ~~must~~ **is not be assumed to be flying at an altitude exceeding that at which the rate of climb equals 300 ft per minute with all engines operating within the maximum continuous power conditions specified; and**
 - (2) the ~~assumed~~ **en-route gradient with one engine inoperative OEI shall be the gross gradient of descent or climb, as appropriate, respectively increased by a gradient of 0,75 %, or decreased by a gradient of 0,75 %.**

OPS 1.542CAT.POL.A.320 En-route – single-engined aeroplanes

- (a) ~~An operator shall ensure that the aeroplane, in the meteorological conditions expected for the flight, and in the event of engine failure, the aeroplane is shall be capable of reaching a place at which a safe forced landing can be made. For landplanes, a place on land is required, unless otherwise approved by the Authority.~~
- (b) ~~When showing compliance with subparagraph (a) above~~ **It shall be assumed that, at the point of engine failure:**
- (1) the aeroplane ~~must~~ **is not be assumed to be flying at an altitude exceeding that at which the rate of climb equals 300 ft per minute, with the engine operating within the maximum continuous power conditions specified, at an altitude exceeding that at which the rate of climb equals 300 ft per minute; and**
 - (2) the ~~assumed~~ **en-route gradient shall be is the gross gradient of descent increased by a gradient of 0,75 %.**

Comment [WSI11]:
Reworded to better clarify the text.

~~OPS 1.545~~CAT.POL.A.325 Landing – destination and alternate aerodromes

~~An operator shall ensure that~~ The landing mass of the aeroplane determined in accordance with ~~OPS 1.475~~ **CAT.POL.A.105(a)** ~~does~~ **shall** not exceed the maximum landing mass specified for the altitude and the ambient temperature expected ~~at for~~ the estimated time of landing at the destination **aerodrome** and alternate aerodrome.

~~OPS 1.550~~CAT.POL.A.330 Landing – dry runways

(a) ~~An operator shall ensure that~~ The landing mass of the aeroplane determined in accordance with ~~OPS 1.475~~ **CAT.POL.A.105**-(a) for the estimated time of landing **at the destination aerodrome and at any alternate aerodrome shall** allow a full stop landing from 50 ft above the threshold within 70 % of the landing distance available (**LDA**) ~~at the destination aerodrome and at any alternate aerodrome~~ **taking into account:-**

~~(1) The Authority may approve the use of landing distance data factored in accordance with this paragraph based on a screen height of less than 50 ft, but not less than 35 ft (see Appendix 1 to OPS 1.550 (a));~~

Comment [WSI12]:
Moved to (b).

~~(2) The Authority may approve Short Landing landing Operations operations, in accordance with the criteria in Appendix 2 to OPS 1.550 (a).~~

Comment [WSI13]:
Moved to (c).

~~(b) When showing compliance with subparagraph (a) above, an operator shall take account of the following:-~~

- ~~(1) The altitude at the aerodrome;~~
- ~~(2) Not more than 50 % of the head-wind component or not less than 150 % of the tail-wind component;-~~
- ~~(3) The runway surface condition and the type of runway surface; and~~
- ~~(4) The runway slope in the direction of landing.;~~

(b) For steep approach operations, the operator shall use landing distance data factored in accordance with (a) above based on a screen height of less than 60 ft, but not less than 35 ft, and comply with CAT.POL.A.345.

Comment [WSI14]:
Revised to be consistent with NPA 25B-267 and the proposal of the JAA Performance Sub-Committee.

(c) For short landing operations, the operator shall use landing distance data factored in accordance with (a) above and comply with CAT.POL.A.350.

~~(d) For dispatching an~~ **(de)** the aeroplane in accordance with ~~subparagraph (a) to (c)~~ above, it ~~must~~ **shall** be assumed that:

- ~~(1) The aeroplane will land on the most favourable runway, in still air; and~~
- ~~(2) The aeroplane will land on the runway most likely to be assigned considering the probable wind speed and direction and the ground handling characteristics of the aeroplane, and considering other conditions such as landing aids and terrain.~~

~~(de)~~ If the operator is unable to comply with ~~subparagraph (de)(2)~~ above for the destination aerodrome, the aeroplane ~~may~~ **shall be only be** dispatched if an alternate aerodrome is designated which permits full compliance with ~~subparagraphs (a) to , (b) and (de)~~ above.

EU-OPS Subpart F-I | Revised rule text

~~OPS 1.555~~CAT.POL.A.335 Landing – wet and contaminated runways

- (a) ~~An operator shall ensure that w~~When the appropriate weather reports **and/or** forecasts, ~~or a combination thereof,~~ indicate that the runway at the estimated time of arrival may be wet, the ~~landing distance available~~**LDA is shall be** equal to or exceeds the required landing distance, determined in accordance with ~~OPS 1.550~~**CAT.POL.A.330**, multiplied by a factor of 1,715.
- (b) ~~An operator shall ensure that w~~When the appropriate weather reports **and/or** forecasts, ~~or a combination thereof,~~ indicate that the runway at the estimated time of arrival may be contaminated, the landing distance, ~~determined by using data acceptable to the Authority for these conditions,~~ **does shall** not exceed the ~~landing distance available~~**LDA. The operator shall specify in the operations manual the landing distance data to be applied.**
- (c) A landing distance on a wet runway shorter than that required by ~~subparagraph~~ (a) above, but not less than that required by ~~OPS 1.550~~**CAT.POL.A.330**(a), may be used if the ~~Aeroplane Flight Manual~~**AFM** includes specific additional information about landing distances on wet runways.

Appendix 1 to ~~OPS 1.525 (b)~~CAT.POL.A.340 General

~~tGeneral – take-off and Landing Climb~~The **operator of a two-engined aeroplane shall fulfil the following take-off and landing climb standards.**

- (a) Take-off climb-
- (1) All engines operating-
- (i) The steady gradient of climb after take-off ~~must~~**shall** be at least 4 % with:
- (A) take-off power on each engine;
- (B) the landing gear extended except that if the landing gear can be retracted in not more than 7 seconds, it may be assumed to be retracted;
- (C) the wing flaps in the take-off position(s); and
- (D) a climb speed not less than the greater of 1,71 V_{MCNE} **(minimum control speed on or near ground)** and 1,72 V_{S1} **(stall speed or minimum steady flight speed in the landing configuration)**~~S1~~.
- (2) ~~One engine inoperative~~**OEI-**
- (i) The steady gradient of climb at an altitude of 400 ft above the take-off surface ~~must~~**shall** be measurably positive with:
- (A) the critical engine inoperative and its propeller in the minimum drag position;
- (B) the remaining engine at take-off power;
- (C) the landing gear retracted;
- (D) the wing flaps in the take-off position(s); and

EU-OPS Subpart F-I | Revised rule text

- (E) a climb speed equal to that achieved at 50 ft.
- (ii) The steady gradient of climb ~~must~~**shall** be not less than 0,75 % at an altitude of 1 500 ft above the take-off surface with:
 - (A) the critical engine inoperative and its propeller in the minimum drag position;
 - (B) the remaining engine at not more than maximum continuous power;
 - (C) the landing gear retracted;
 - (D) the wing flaps retracted; and
 - (E) a climb speed not less than 1,2 V_{S1} .
- (b) Landing climb:
 - (1) All engines operating:
 - (i) The steady gradient of climb ~~must~~**shall** be at least 2,5 % with:
 - (A) not more than the power or thrust that is available 8 seconds after initiation of movement of the power controls from the minimum flight idle position;
 - (B) the landing gear extended;
 - (C) the wing flaps in the landing position; and
 - (D) a climb speed equal to V_{REF} (**reference landing speed**).
 - (2) One engine inoperative ~~OEL~~:
 - (i) The steady gradient of climb ~~must~~**shall** be not less than 0,75 % at an altitude of 1 500 ft above the landing surface with:
 - (A) the critical engine inoperative and its propeller in the minimum drag position;
 - (B) ~~t~~The remaining engine at not more than maximum continuous power;
 - (C) ~~t~~The landing gear retracted;
 - (D) ~~t~~The wing flaps retracted; and
 - (E) ~~a~~A climb speed not less than 1,2 V_{S1} .

~~Appendix 1 to OPS 1.550(a)~~ **CAT.POL.A.345 Approval of steep approach procedures**

- (a) ~~The Authority may approve the application of Steep Approach~~ **approach procedures** using glide-slope angles of 4.5° or more, and with screen heights of less than 50 ~~60~~ ft, but not less than 35 ft, **require prior approval in of the competent authority.**
- (b) **To obtain the approval, the operator shall provide evidence** ~~, provided that the that the~~ following ~~criteria~~**conditions** are met:

Comment [WSI15]:
Revised to be consistent with NPA 25B-267 and the proposal of the JAA Performance Sub-Committee.

EU-OPS Subpart F-I | Revised rule text

- (1) ~~t~~The ~~Aeroplane Flight Manual~~ **AFM** ~~must~~ states the maximum approved glide slope angle, any other limitations, normal, abnormal or emergency procedures for the steep approach as well as amendments to the field length data when using steep approach criteria; **and**
- (2) **for each aerodrome at which steep approach operations are to be conducted:**
- (2i) ~~a~~A suitable glide path reference system, comprising at least a visual glide path indicating system, ~~must be~~ **is** ~~available at each aerodrome at which steep approach procedures are to be conducted;~~ **and**
- (3ii) ~~w~~Weather minima ~~must are~~ **be** specified; **and** ~~and approved for each runway to be used with a steep approach.~~
- (iii) **the following items are taken into consideration** ~~Consideration must be given to the following:~~
- (iA) ~~t~~The obstacle situation;
- (iiB) ~~t~~The type of glide path reference and runway guidance ~~such as visual aids, MLS, 3D NAV, ILS, LLZ, VOR, NDB;~~
- (iiiC) ~~t~~The minimum visual reference to be required at DH and MDA;
- (ivD) ~~a~~Available airborne equipment;
- (vE) ~~p~~Pilot qualification and special aerodrome familiarisation;
- (viF) ~~Aeroplane Flight Manual~~ **AFM** limitations and procedures; **and**
- (viiG) ~~m~~Missed approach criteria.

~~Appendix 2 to OPS 1.550 (a)~~ **CAT.POL.A.350 Approval of short landing operations**

Comment [WSI16]:
Text modified to be an operator requirement.

- (a) **Short landing operations require prior approval in of the competent authority.**
- (b) **To obtain the approval, the operator shall provide evidence that the following conditions are met:**
- (1) ~~(a) — For the purpose of OPS 1.550 (a)(2), the distance used for the calculation of the permitted landing mass may consist of the usable length of the declared safe area plus the declared landing distance available~~ **LDA**; ~~The Authority may approve such operations in accordance with the following criteria:~~
- (±2) ~~t~~The use of the declared safe area ~~must be~~ **is** ~~approved by the State of the aerodrome Authority;~~
- (32) ~~t~~The declared safe area ~~must be~~ **is** ~~clear of obstructions or depressions which would endanger an aeroplane undershooting the runway; and no mobile object shall be permitted on the declared safe area while the runway is being used for short landing operations;~~
- (43) ~~t~~The slope of the declared safe area ~~does must~~ **not** exceed 5 % upward slope nor 2 % downward slope in the direction of landing;

EU-OPS Subpart F-I | Revised rule text

- (54) ~~t~~The usable length of the declared safe area ~~under the provisions of this Appendix shall~~ **does** not exceed 90 metres;
- (65) ~~t~~The width of the declared safe area ~~shall is~~ not ~~be~~ less than twice the runway width, centred on the extended runway centreline;
- (76) ~~t~~It is assumed that ~~t~~The crossing height over the beginning of the usable length of the declared safe area ~~shall is~~ not ~~be~~ less than 50 ft;-
- (7) ~~For the purpose of this operation, the bearing strength requirement of OPS 1.480 (a)(5) need not apply to the declared safe area.~~
- (8) ~~w~~Weather minima ~~must be~~ **are** specified ~~and approved~~ for each runway to be used and ~~shall not be~~ **are not** less than the greater of VFR or ~~non precision approach~~ **NPA** minima;
- (9) ~~p~~Pilot **experience, training and special aerodrome familiarisation** requirements ~~are s~~ **must be specified and met** (~~OPS 1.975 (a) refers~~);
- (10) ~~a~~The Authority may impose such additional conditions, **if specified by the competent authority**, as ~~are necessary for safe operation taking~~ing into account the aeroplane type characteristics, **orographic characteristics in the approach area, available** approach aids and missed approach/balked landing considerations.

SUBPART I Chapter 4 – Performance cClass C**~~OPS 1.560~~ General**

~~An operator shall ensure that, for determining compliance with the requirements of this Subpart, the approved performance Data in the Aeroplane Flight Manual is supplemented, as necessary, with other Data acceptable to the Authority if the approved performance Data in the Aeroplane Flight Manual is insufficient.~~

Comment [WSI17]:
A duplication with OPS 1.475 and therefore deleted.

~~OPS 1.565~~ CAT.POL.A.400 Take-off

- (a) ~~An operator shall ensure that t~~The take-off mass ~~does~~ **shall** not exceed the maximum take-off mass specified in the ~~Aeroplane Flight Manual~~ **AFM** for the pressure altitude and the ambient temperature at the aerodrome at which the take-off is to be made.
- (b) ~~An operator shall ensure that, f~~For aeroplanes which have take-off field length data contained in their AFM that ~~does~~ **es** not include engine failure accountability, the distance from the start of the take-off roll required by the aeroplane to reach a height of 50 ft above the surface with all engines operating within the maximum take-off power conditions specified, when multiplied by a factor of either:
- (1) 1.733 for aeroplanes having two engines; ~~or~~
 - (2) 1.725 for aeroplanes having three engines; or
 - (3) 1.718 for aeroplanes having four engines,
- ~~does~~ **shall** not exceed the take-off run available (**TORA**) at the aerodrome at which the take-off is to be made.
- (c) ~~An operator shall ensure that, f~~For aeroplanes which have take-off field length data contained in their AFM which accounts for engine failure, the following requirements ~~are~~ **shall be** met in accordance with the specifications in the AFM:
- (1) ~~t~~The accelerate-stop distance ~~must~~ **shall** not exceed the ~~ASDA~~ **accelerate-stop distance available**;
 - (2) ~~t~~The take-off distance ~~must~~ **shall** not exceed the take-off distance available (**TODA**), with a clearway distance not exceeding half of the ~~take-off run available~~ **TORA**;
 - (3) ~~T~~the take-off run ~~must~~ **shall** not exceed the ~~take-off run available~~ **TORA**;
 - (4) ~~a~~Compliance with this paragraph ~~must be shown using a single value of V₁ for the rejected and continued take-off~~ **shall be used**; and
 - (5) ~~o~~On a wet or contaminated runway the take-off mass ~~must~~ **shall** not exceed that permitted for a take-off on a dry runway under the same conditions.
- (d) ~~When showing compliance with subparagraphs (b) and (c) above, an operator~~ **The following must shall be taken into account of the following:**
- (1) ~~t~~The pressure altitude at the aerodrome;
 - (2) ~~t~~The ambient temperature at the aerodrome;

EU-OPS Subpart F-I | Revised rule text

- (3) ~~t~~The runway surface condition and the type of runway surface;
- (4) ~~t~~The runway slope in the direction of take-off;
- (5) ~~n~~Not more than 50 % of the reported head-wind component or not less than 150 % of the reported tail-wind component; and
- (6) ~~t~~The loss, if any, of runway length due to alignment of the aeroplane prior to take-off.

~~OPS 1.570~~CAT.POL.A.405 Take-off ~~o~~Obstacle ~~c~~Clearance

- (a) ~~An operator shall ensure that t~~The take-off flight path with ~~one engine inoperative~~**OEI shall be determined such that the aeroplane** clears all obstacles by a vertical distance of at least 50 ft plus $0,701 \times D$, or by a horizontal distance of at least 90 m plus $0,7125 \times D$, where D is the horizontal distance the aeroplane has travelled from the end of the ~~take-off distance available~~**TODA**. For aeroplanes with a wingspan of less than 60 m, a horizontal obstacle clearance of half the aeroplane wingspan plus 60 m, plus $0,7125 \times D$ may be used.
- (b) The take-off flight path ~~must~~**shall** begin at a height of 50 ft above the surface at the end of the take-off distance required by ~~OPS 1.565~~**CAT.POL.A.405** (b) or (c), as applicable, and end at a height of 1 500 ft above the surface.
- (c) When showing compliance with ~~subparagraph (a) above,~~ ~~an operator~~**the following must shall be taken into** account of the following:
 - (1) ~~t~~The mass of the aeroplane at the commencement of the take-off run;
 - (2) ~~t~~The pressure altitude at the aerodrome;
 - (3) ~~t~~The ambient temperature at the aerodrome; and
 - (4) ~~n~~Not more than 50 % of the reported head-wind component or not less than 150 % of the reported tail-wind component.
- (d) ~~When showing compliance with subparagraph (a) above, track~~**Track** changes shall not be allowed up to that point of the take-off flight path where a height of 50 ft above the surface has been achieved. Thereafter, up to a height of 400 ft it is assumed that the aeroplane is banked by no more than 15°. Above 400 ft height bank angles greater than 15°, but not more than 25°, may be scheduled. Adequate allowance ~~must~~**shall** be made for the effect of bank angle on operating speeds and flight path including the distance increments resulting from increased operating speeds.
- (e) ~~When showing compliance with subparagraph (a) above for~~**For** those cases which do not require track changes of more than 15°, the operator **does not** need ~~not~~**to** consider those obstacles which have a lateral distance greater than:
 - (1) 300 m, if the pilot is able to maintain the required navigational accuracy through the obstacle accountability area; or
 - (2) 600 m, for flights under all other conditions.
- (f) ~~When showing compliance with subparagraph (a) above for~~**For** those cases which do require track changes of more than 15°, the operator **does not** need ~~not~~**to** consider those obstacles which have a lateral distance greater than:

EU-OPS Subpart F-I | Revised rule text

- (1) 600 m, if the pilot is able to maintain the required navigational accuracy through the obstacle accountability area; or
 - (2) 900 m, for flights under all other conditions.
- (g) The operator shall establish contingency procedures ~~and~~ to provide a safe route, avoiding obstacles, **and** to enable the aeroplane to either comply with the en-route requirements of ~~OPS 1.580~~**CAT.POL.A.415**, or land at either the aerodrome of departure or at a take-off alternate aerodrome.

~~OPS 1.575~~**CAT.POL.A.410 En-route – all engines operating**

- (a) ~~An operator shall ensure that the aeroplane will~~**shall, i**In the meteorological conditions expected for the flight, at any point on its route or on any planned diversion there from, **the aeroplane shall** be capable of a rate of climb of at least 300 ft per minute with all engines operating within the maximum continuous power conditions specified at:
- (1) ~~t~~**The** minimum altitudes for safe flight on each stage of the route to be flown, or of any planned diversion therefrom, specified in, or calculated from the information contained in, the ~~Operations Manual~~**operations manual** relating to the aeroplane; and
 - (2) ~~t~~**The** minimum altitudes necessary for compliance with the conditions prescribed in ~~OPS 1.580~~**CAT.POL.A.415** and ~~1.585~~**420**, as appropriate.

~~OPS 1.580~~**CAT.POL.A.415 En-route – one engine inoperativeOEI**

- (a) ~~An operator shall ensure that t~~**The** aeroplane will, ~~i~~**In** the meteorological conditions expected for the flight, in the event of any one engine becoming inoperative at any point on its route or on any planned diversion therefrom and with the other engine ~~(s) or engines~~ operating within the maximum continuous power conditions specified, **the aeroplane shall** be capable of continuing the flight from the cruising altitude to an aerodrome where a landing can be made in accordance with ~~OPS 1.595~~**CAT.POL.A.430** ~~or OPS 1.600~~**CAT.POL.A.435**, as appropriate, clearing obstacles within 9,3 km (5 ~~n~~**nm**) either side of the intended track by a vertical interval of at least:
- (1) 1 000 ft, when the rate of climb is zero or greater; or
 - (2) 2 000 ft, when the rate of climb is less than zero.
- (b) The flight path shall have a positive slope at an altitude of 450 m (1 500 ft) above the aerodrome where the landing is assumed to be made after the failure of one engine.
- (c) ~~For the purpose of this subparagraph the~~**The** available rate of climb of the aeroplane shall be taken to be 150 ft per minute less than the gross rate of climb specified.
- (d) ~~When showing compliance with this paragraph, an operator must increase the~~**The** width margins of subparagraph (a) above **shall be increased** to 18,5 km (10 ~~nm~~**nm**) if the navigational accuracy does not meet **at least RNP5**~~the 95-% containment level.~~

EU-OPS Subpart F-I | Revised rule text

- (e) Fuel jettisoning is permitted to an extent consistent with reaching the aerodrome with the required fuel reserves, if a safe procedure is used.

~~OPS 1.585~~CAT.POL.A.420 En-route – aeroplanes with three or more engines, two engines inoperative

- (a) ~~An operator shall ensure that, a~~At no point along the intended track, ~~will~~**shall** an aeroplane having three or more engines be more than 90 minutes, at the all-engines long range cruising speed at standard temperature in still air, away from an aerodrome at which the performance requirements applicable at the expected landing mass are met, unless it complies with ~~subparagraphs~~(b) to (e) below.
- (b) The two-engines--inoperative flight path ~~shown must~~**shall** permit the aeroplane to continue the flight, in the expected meteorological conditions, clearing all obstacles within 9,73 -km (5 ~~n~~**NM**) either side of the intended track by a vertical interval of at least 2 000 ft, to an aerodrome at which the performance requirements applicable at the expected landing mass are met.
- (c) The two engines are assumed to fail at the most critical point of that portion of the route where the aeroplane is more than 90 minutes, at the all--engines long range cruising speed at standard temperature in still air, away from an aerodrome at which the performance requirements applicable at the expected landing mass are met.
- (d) The expected mass of the aeroplane at the point where the two engines are assumed to fail ~~must~~**shall** not be less than that which would include sufficient fuel to proceed to an aerodrome where the landing is assumed to be made, and to arrive there at an altitude of a least 450 m (1 500 ft) directly over the landing area and thereafter to fly level for 15 minutes.
- (e) ~~For the purpose of this subparagraph~~†The available rate of climb of the aeroplane shall be taken to be 150 ft per minute less than that specified.
- (f) ~~When showing compliance with this paragraph, an operator must increase the~~**The** width margins of ~~subparagraph~~(ba) above **shall be increased** to 18,75 km (10 ~~NM~~**NM**) if the navigational accuracy does not meet **at least RNP5** ~~the 95 % containment level.~~
- (g) Fuel jettisoning is permitted to an extent consistent with reaching the aerodrome with the required fuel reserves, if a safe procedure is used.

~~OPS 1.590~~CAT.POL.A.425 Landing – destination and alternate aerodromes

~~An operator shall ensure that~~†The landing mass of the aeroplane determined in accordance with ~~OPS 1.475~~**CAT.POL.A.105** (a) ~~does~~**shall** not exceed the maximum landing mass specified in the ~~Aeroplane Flight Manual~~**AFM** for the altitude and, if accounted for in the AFM, the ambient temperature expected for the estimated time of landing at the destination **aerodrome** and alternate aerodrome.

~~OPS 1.595~~CAT.POL.A.430 Landing – dry runways

- (a) ~~An operator shall ensure that~~†The landing mass of the aeroplane determined in accordance with **CAT.POL.A.105**~~OPS 1.475~~(a) for the estimated time of landing **at the destination aerodrome and any alternate aerodrome shall** allows a

EU-OPS Subpart F-I | Revised rule text

full stop landing from 50 ft above the threshold within 70 % of the landing distance available (**LDA**) ~~at the destination and any alternate aerodrome.~~

- ~~(b)~~ When showing compliance with subparagraph (a) above, an operator must **take into** account of the following:
- (1) ~~t~~The altitude at the aerodrome;
 - (2) ~~n~~Not more than 50 % of the head-wind component or not less than 150 % of the tail-wind component;
 - (3) ~~t~~The type of runway surface; and
 - (4) ~~t~~The slope of the runway in the direction of landing.
- ~~(eb)~~ For ~~diespatching an~~ **the** aeroplane in accordance with subparagraph (a) above it ~~must~~**shall** be assumed that:
- (1) ~~t~~The aeroplane will land on the most favourable runway in still air; and
 - (2) ~~t~~The aeroplane will land on the runway most likely to be assigned considering the probable wind speed and direction and the ground handling characteristics of the aeroplane, and ~~considering~~ other conditions such as landing aids and terrain.
- ~~(ec)~~ If the operator is unable to comply with ~~subparagraph (eb)(2)~~ above for the destination aerodrome, the aeroplane ~~may~~**shall only** be ~~diespatched~~ if an alternate aerodrome is designated which permits full compliance with ~~subparagraphs (a), (b) and (eb)~~ **above**.

~~OPS 1.600~~CAT.POL.A.435 Landing – wet and contaminated runways

- (a) ~~An operator shall ensure that w~~When the appropriate weather reports **and/or** forecasts, ~~or a combination thereof,~~ indicate that the runway at the estimated time of arrival may be wet, the ~~landing distance available~~**LDA is shall be** equal to or exceeds the required landing distance, determined in accordance with ~~OPS 1.595 CAT.POL.A.4305,~~ multiplied by a factor of 1.715.
- (b) ~~An operator shall ensure that w~~When the appropriate weather reports **and/or** forecasts, ~~or a combination thereof,~~ indicate that the runway at the estimated time of arrival may be contaminated, the landing distance ~~determined by using data acceptable to the Authority for these conditions, does~~**shall** not exceed the ~~landing distance available~~**LDA. The operator shall specify in the operations manual the landing distance data to be applied.**

EU-OPS Subpart F-I | Revised rule text

Subpart C – Aircraft performance and operating limitations – AMC/GM

Section 1 – Aeroplanes

Chapter 1 - General requirements

AMC1-CAT.POL.A.105 General Landing—Reverse Thrust Credit

LANDING - REVERSE THRUST CREDIT

Landing distance data included in the AFM (or **pilot's operating handbook (POH)**; etc.) with credit for reverse thrust can only be considered to be approved for the purpose of showing compliance with the applicable requirements if it contains a specific statement from the ~~appropriate airworthiness authority~~ **Agency** that it complies with a recognised airworthiness code (e.g. FAR 23/25, ~~JAR-**CS** 23/25 or equivalent~~, ~~BCAR Section 'D'/'K'~~).

Chapter 2 - Performance class A

AMC1-CAT.POL.A.200 General

WET AND CONTAMINATED RUNWAY DATA

If the performance data has been determined on the basis of measured runway friction coefficient, the operator should use a procedure correlating the measured runway friction coefficient and the effective braking coefficient of friction of the aeroplane type over the required speed range for the existing runway conditions.

AMC1-CAT.POL.A.205 Take-off

LOSS OF RUNWAY LENGTH DUE TO ALIGNMENT

~~1~~ Introduction

1.~~1~~ The length of the runway which is declared for the calculation of **take-off distance available (TODA)**, **accelerate-stop distance available (ASDA)** and **take-off run available (TORA)**; does not account for line-up of the aeroplane in the direction of take-off on the runway in use. This alignment distance depends on the aeroplane geometry and access possibility to the runway in use. Accountability is usually required for a 90° taxiway entry to the runway and 180° turnaround on the runway. There are two distances to be considered:

- a. ~~t~~The minimum distance of the main wheels from the start of the runway for determining TODA and TORA, "L"; and
- b. ~~t~~The minimum distance of the most forward wheel(s) from the start of the runway for determining ASDA, "N".

Figure 1: Line-up of the aeroplane in the direction of take-off - L and N

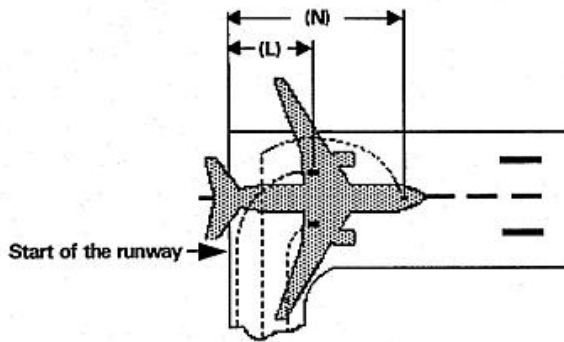

Where the aeroplane manufacturer does not provide the appropriate data, the calculation method given in paragraph 2. below may be used to determine the alignment distance.

2. Alignment Distance Calculation

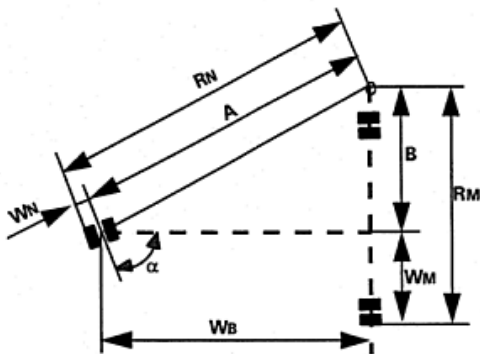

The distances mentioned in 1.(a) and 1.(b) of paragraph 1- above are:

	90° ENTRY	180° TURNAROUND
L=	RM + X	RN + Y
N=	RM + X + WB	RN + Y + WB

where:

$$RN = A + WN = WB / \cos(90^\circ - \alpha) + WN$$

$$\text{and } RM = B + WM = WB \tan(90^\circ - \alpha) + WM$$

EU-OPS Subpart F-I | Revised rule text

X = ~~s~~Safety distance of outer main wheel during turn to the edge of the runway

Y = ~~s~~Safety distance of outer nose wheel during turn to the edge of the runway

NOTE: Minimum edge safety distances for X and Y are specified in FAA AC 150/5300-13 and ICAO Annex 14, ~~paragraph~~ 3.8.3

RN = ~~r~~Radius of turn of outer nose wheel

RM = ~~r~~Radius of turn of outer main wheel

WN = ~~d~~Distance from aeroplane centre-line to outer nose wheel

WM = ~~d~~Distance from aeroplane centre-line to outer main wheel

WB = ~~w~~Wheel base

α = ~~s~~Steering angle.

GM1-CAT.POL.A.205 Take-off**RUNWAY SURFACE CONDITION**

1. Operation on runways contaminated with water, slush, snow or ice implies uncertainties with regard to runway friction and contaminant drag and therefore to the achievable performance and control of the aeroplane during take-off, since the actual conditions may not completely match the assumptions on which the performance information is based. In the case of a contaminated runway, the first option for the commander is to wait until the runway is cleared. If this is impracticable, he may consider a take-off, provided that he has applied the applicable performance adjustments, and any further safety measures he considers justified under the prevailing conditions.
2. An adequate overall level of safety will only be maintained if operations in accordance with **AMC 25.1591 or equivalent**~~JAR 25-AMJ 25X1591~~ are limited to rare occasions. Where the frequency of such operations on contaminated runways is not limited to rare occasions, ~~operator~~**the operator** should provide additional measures ensuring an equivalent level of safety. Such measures could include special crew training, additional distance factoring and more restrictive wind limitations.

AMC1-CAT.POL.A.210 Take-off obstacle clearance**TAKE-OFF OBSTACLE CLEARANCE**

1. In accordance with the definitions used in preparing the take-off distance and take-off flight path ~~d~~Data provided in the ~~Aeroplane Flight Manual~~**AFM**:
 - a. The net take-off flight path is considered to begin at a height of 35 ft above the runway or clearway at the end of the take-off distance determined for the aeroplane in accordance with ~~sub-paragraph~~(b) below.
 - b. The take-off distance is the longest of the following distances:

EU-OPS Subpart F-I | Revised rule text

- i. 115 % of the distance with all engines operating from the start of the take-off to the point at which the aeroplane is 35 ft above the runway or clearway; ~~or~~
 - ii. ~~t~~The distance from the start of the take-off to the point at which the aeroplane is 35 ft above the runway or clearway assuming failure of the critical engine occurs at the point corresponding to the decision speed (V_1) for a dry runway; or
 - iii. ~~i~~f the runway is wet or contaminated, the distance from the start of the take-off to the point at which the aeroplane is 15 ft above the runway or clearway assuming failure of the critical engine occurs at the point corresponding to the decision speed (V_1) for a wet or contaminated runway.
2. ~~JAR OPS 1.495(a) specifies that t~~The net take-off flight path, determined from the data provided in the ~~Aeroplane Flight Manual~~ **AFM** in accordance with ~~sub-paragraphs 1.(a.) and 1.(b.) above, must~~ **should** clear all relevant obstacles by a vertical distance of 35 ft. When taking off on a wet or contaminated runway and an engine failure occurs at the point corresponding to the decision speed (V_1) for a wet or contaminated runway, this implies that the aeroplane can initially be as much as 20 ft below the net take-off flight path in accordance with ~~sub-paragraph 1. above and, therefore, may clear close-in obstacles by only 15 ft. When taking off on wet or contaminated runways, the operator should exercise special care with respect to obstacle assessment, especially if a take-off is obstacle-limited and the obstacle density is high.~~

EFFECT OF BANK ANGLES

1. The ~~Aeroplane Flight Manual~~ **AFM** generally provides a climb gradient decrement for a 15° bank turn. For bank angles of less than 15°, a proportionate amount should be applied, unless the manufacturer or ~~Aeroplane Flight Manual~~ **AFM** has provided other data.
2. Unless otherwise specified in the ~~Aeroplane Flight Manual~~ **AFM** or other performance or operating manuals from the manufacturer, acceptable adjustments to assure adequate stall margins and gradient corrections are provided by the following **table**:

Table 1: Effect of bank angles

BANK	SPEED	GRADIENT CORRECTION
15°	V_2	1 x Aeroplane Flight Manual AFM 15° gradient loss
20°	$V_2 + 5$ kt	2 x Aeroplane Flight Manual AFM 15° gradient loss
25°	$V_2 + 10$ kt	3 x Aeroplane Flight Manual AFM 15° g Gradient loss

EU-OPS Subpart F-I | Revised rule text

REQUIRED NAVIGATIONAL ACCURACY

1. Flight-deck systems

The obstacle accountability semi-widths of 300 m (~~see JAR OPS 1.495(d)(1)~~) and 600 m (~~see JAR OPS 1.495(e)(1)~~) may be used if the navigation system under ~~one-engine-inoperative~~ **OEI** conditions provides a two standard deviation accuracy of 150 m and 300 m respectively.

2. Visual ~~c~~Course ~~g~~Guidance

~~2.1a.~~ The obstacle accountability semi-widths of 300 m (~~see JAR OPS 1.495(d)(1)~~) and 600 m (~~see JAR OPS 1.495(e)(1)~~) may be used where navigational accuracy is ensured at all relevant points on the flight path by use of external references. These references may be considered visible from the flight deck if they are situated more than 45° either side of the intended track and with a depression of not greater than 20° from the horizontal.

~~2.2b.~~ For visual course guidance navigation, ~~an~~ **the** operator should ensure that the weather conditions prevailing at the time of operation, including ceiling and visibility, are such that the obstacle and/or ground reference points can be seen and identified. The ~~Operations Manual~~ **operations manual** should specify, for the aerodrome(s) concerned, the minimum weather conditions which enable the flight crew to continuously determine and maintain the correct flight path with respect to ground reference points, so as to provide a safe clearance with respect to obstructions and terrain as follows:

- ~~ai.~~ **t**The procedure should be well defined with respect to ground reference points so that the track to be flown can be analysed for obstacle clearance requirements;
- ~~bii.~~ **t**The procedure should be within the capabilities of the aeroplane with respect to forward speed, bank angle and wind effects;
- ~~ciii.~~ **a**A written and/or pictorial description of the procedure should be provided for crew use; **and**
- ~~ivd.~~ **t**The limiting environmental conditions (such as wind, the lowest cloud base, ceiling, visibility, day/night, ambient lighting, obstruction lighting) should be specified.

GM12-CAT.POL.A.210 Engine failure procedures Take-off obstacle clearance**CONTINGENCY PROCEDURES FOR OBSTACLES CLEARANCE**~~ENGINE FAILURE PROCEDURES~~

If compliance with **CAT.POL.A.210**~~JAR OPS 1.495(f)~~ is based on an engine failure route that differs from the all engine departure route or SID normal departure, a "deviation point" can be identified where the engine failure route deviates from the normal departure route. Adequate obstacle clearance along the normal departure **route** with failure of the critical engine at the deviation point will normally be available. However, in certain situations the obstacle clearance along the normal departure route may be marginal and should be checked to ensure that, in case of an engine failure after the deviation point, a flight can safely proceed along the normal departure **route**.

AMC1-CAT.POL.A.215 En-route - one-engine-inoperative (one-engine inoperative OEI)

ROUTE ANALYSIS

1. The high terrain or obstacle analysis required for showing compliance with JAR-OPS 1.500 may be carried out **by a detailed analysis of the route**, in one of two ways, as explained in the following three paragraphs.
2. A detailed analysis of the route should be made using contour maps of the high terrain and plotting the highest points within the prescribed corridor's width along the route. The next step is to determine whether it is possible to maintain level flight with **one-engine-inoperative OEI** 1 000 ft above the highest point of the crossing. If this is not possible, or if the associated weight penalties are unacceptable, a driftdown procedure should be worked out, based on engine failure at the most critical point and clearing critical obstacles during the driftdown by at least 2 000 ft. The minimum cruise altitude is determined by the intersection of the two driftdown paths, taking into account allowances for decision making (see Figure 1). This method is time-consuming and requires the availability of detailed terrain maps.
3. Alternatively, the published minimum flight altitudes (**mMinimum eEn-route aAltitude**, MEA, or **mMinimum oOff-rRoute aAltitude**, MORA) may be used for determining whether **one-engine-inoperative OEI** level flight is feasible at the minimum flight altitude, or if it is necessary to use the published minimum flight altitudes as the basis for the driftdown construction (see Figure 1). This procedure avoids a detailed high terrain contour analysis, but may be more penalising than taking the actual terrain profile into account as in paragraph 2. **aAbove.**
4. In order to comply with **CAT.POL.A.215 JAR OPS 1.500(c)**, one means of compliance is the use of MORA and, with **CAT.POL.A.215 JAR OPS 1.500(d)**, MEA provided that the aeroplane meets the navigational equipment standard assumed in the definition of MEA.

Figure 1: Intersection of the two driftdown paths*

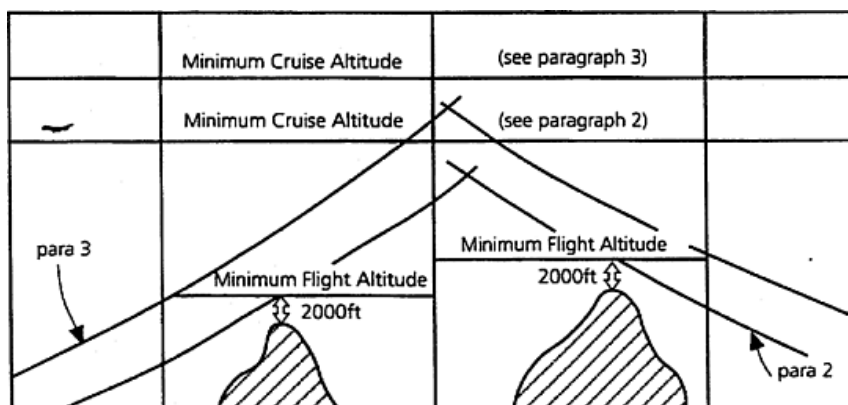

EU-OPS Subpart F-I | Revised rule text

Note*: MEA or MORA normally provide the required 2 000 ft obstacle clearance for driftdown. However, at and below 6 000 ft altitude, MEA and MORA cannot be used directly as only 1 000 ft- clearance is ensured.

AGMMC1-CAT.POL.A.225 Landing – dDestination and aAlternate aAerodromes**MISSED APPROACH**

1. ~~{The required missed approach gradient may not be achieved}~~ by all aeroplanes when operating at or near maximum certificated landing mass and in engine-out conditions.
2. ~~Operators~~**The operator** of such aeroplanes should consider mass, altitude and temperature limitations and wind for the missed approach ~~[]~~.
3. ~~{As an alternative method,}~~**The operator may use** an increase in the **DH/A**~~decision altitude/height~~ or **MDH/A**~~minimum descent altitude/height~~ ~~{and/or a contingency procedure (see JAR OPS 1.495(f)) providing a safe route and avoiding obstacles, can be approved} []~~.

ALTITUDE MEASURING

~~In showing compliance with JAR OPS 1.510 and JAR OPS 1.515, t~~The operator should use either pressure altitude or geometric altitude for his operation and this should be reflected in the ~~Operations Manual~~**operations manual**.

AMC1-CAT.POL.A.230 Factoring of Automatic Landing Distance Performance Data (Performance Class A Aeroplanes only) Landing – dry runways**FACTORING OF AUTOMATIC LANDING DISTANCE PERFORMANCE DATA (PERFORMANCE CLASS A AEROPLANES ONLY)**

In those cases where the landing requires the use of an automatic landing system, and the distance published in the ~~Aeroplane Flight Manual (AFM)~~ includes safety margins equivalent to those contained in **CAT.POL.A.230(a)(1)** ~~JAR OPS 1.515(a)(1)~~ and **CAT.POL.A.235**~~JAR OPS 1.520~~, the landing mass of the aeroplane should be the lesser of:

1. ~~t~~The landing mass determined in accordance with **CAT.POL.A.230(a)(1)**~~JAR OPS 1.515(a)(1)~~ or **CAT.POL.A.235**~~JAR OPS 1.520~~ as appropriate; or
2. ~~t~~The landing mass determined for the automatic landing distance for the appropriate surface condition, as given in the AFM, or equivalent document. Increments due to system features such as beam location or elevations, or procedures such as use of overspeed, should also be included.

LANDING MASS

1. **CAT.POL.A.230**~~JAR OPS 1.515(e)~~ establishes two considerations in determining the maximum permissible landing mass at the destination and alternate aerodromes.
2. Firstly, the aeroplane mass will be such that on arrival the aeroplane can be landed within 60 % or 70 % (as applicable) of the landing distance available (**LDA**) on the most favourable (normally the longest) runway in still air.

EU-OPS Subpart F-I | Revised rule text

Regardless of the wind conditions, the maximum landing mass for an aerodrome/aeroplane configuration at a particular aerodrome, cannot be exceeded.

3. Secondly, consideration should be given to anticipated conditions and circumstances. The expected wind, or ATC and noise abatement procedures, may indicate the use of a different runway. These factors may result in a lower landing mass than that permitted under ~~paragraph 2. above, in which case, to show compliance with JAR OPS 1.515(a),~~ dispatch should be based on this lesser mass.
4. The expected wind referred to in ~~paragraph 3.~~ is the wind expected to exist at the time of arrival.

Chapter 3 - Performance class B

AMC1-CAT.POL.A.305 Take-off

RUNWAY SURFACE CONDITION PERFORMANCE CORRECTION FACTORS

1. Unless otherwise specified in the ~~Aeroplane Flight Manual~~ **AFM** or other performance or operating manuals from the manufacturers, the variables affecting the take-off performance and the associated factors that should be applied to the ~~Aeroplane Flight Manual~~ **AFM** data are shown in ~~the~~ **Table 1** below. They should be applied in addition to the operational factors as prescribed in **CAT.POL.A.305** ~~JAR OPS 1.530(b).~~

Table 1: Runway surface condition - Variables

SURFACE TYPE	CONDITION	FACTOR
Grass (on firm soil) up to 20 cm long	Dry	-1.-20
	Wet	1.-30
Paved	Wet	1.-00

2. ~~Notes:~~ 1. —The soil **should be considered** ~~is~~ firm when there are wheel impressions but no rutting.
3. When taking off on grass with a single-engine ~~ed~~ aeroplane, care should be taken to assess the rate of acceleration and consequent distance increase.
4. When making a rejected take-off on very short grass which is wet, and with a firm subsoil, the surface may be slippery, in which case the distances may increase significantly.

EU-OPS Subpart F-I | Revised rule text

RUNWAY SLOPE

Unless otherwise specified in the ~~Aeroplane Flight Manual~~ **AFM**, or other performance or operating manuals from the manufacturers, the take-off distance should be increased by 5 % for each 1 % of upslope except that correction factors for runways with slopes in excess of 2 % **should only be applied when the operator has demonstrated to the competent authority that the necessary data in the AFM or the operations manual contain the appropriated procedures and the crew is trained to take-off in runway with slopes in excess of 2 %.** ~~require the acceptance of the Authority.~~

GM1-CAT.POL.A.305 Take-off**RUNWAY SURFACE CONDITION** ~~PERFORMANCE CORRECTION FACTORS~~

1. Due to the inherent risks, operations from contaminated runways are inadvisable, and should be avoided whenever possible. Therefore, it is advisable to delay the take-off until the runway is cleared.
2. Where this is impracticable, the commander should also consider the excess runway length available including the criticality of the overrun area.
- ~~2. The weather minima given in Appendix 1 to JAR OPS 1.430 sub paragraph (a)(3)(ii) up to and including 300 ft imply that if a take off is undertaken with minima below 300 ft a one engine inoperative flight path must be plotted starting on the all engine take off flight path at the assumed engine failure height. This path must meet the vertical and lateral obstacle clearance specified in JAR OPS 1.535. Should engine failure occur below this height, the associated visibility is taken as being the minimum which would enable the pilot to make, if necessary, a forced landing broadly in the direction of the take off. At or below 300 ft, a circle and land procedure is extremely inadvisable. Appendix 1 to JAROPS 1.430 sub paragraph (a)(3)(ii) specifies that, if the assumed engine failure height is more than 300 ft, the visibility must be at least 1500 m and, to allow for manoeuvring, the same minimum visibility should apply whenever the obstacle clearance criteria for a continued take off cannot be met.~~

Appendix 1 to OPS 1.535(b)(1) & (c)(1) **AMC1-CAT.POL.A.310 Take-off obstacle clearance – multi-engined aeroplanes**

TAKE-OFF FLIGHT PATH – VISUAL COURSE GUIDANCE NAVIGATION

1. In order to allow visual course guidance navigation, the operator ~~must~~ **should** ensure that the weather conditions prevailing at the time of operation, including ceiling and visibility, are such that the obstacle and/or ground reference points can be seen and identified.
2. The ~~Operations Manual~~ **operations manual** ~~must~~ **should** specify, for the aerodrome(s) concerned, the minimum weather conditions which enable the flight crew to continuously determine and maintain the correct flight path with respect to ground reference points, so as to provide a safe clearance with respect to obstructions and terrain as follows:

Comment [WSI18]:

This is regarded as a means to comply with the safety objective. Moreover, it would allow sufficient flexibility to account for different operational circumstances.

EU-OPS Subpart F-I | Revised rule text

- a. ~~t~~The procedure ~~must~~**should** be well defined with respect to ground reference points so that the track to be flown can be analysed for obstacle clearance requirements;
- b. ~~t~~The procedure ~~must~~**should** be within the capabilities of the aeroplane with respect to forward speed, bank angle and wind effects;
- c. ~~a~~A written and/or pictorial description of the procedure ~~must~~**should** be provided for crew use; and
- d. ~~t~~The limiting environmental conditions ~~must~~**should** be specified (e.g. wind, cloud, visibility, day/night, ambient lighting, obstruction lighting).

AMC2-CAT.POL.A.310 ~~Take-off Flight Path Construction~~ Take-off ~~o~~Obstacle Clearance – ~~m~~Multi-~~e~~Engined ~~a~~Aeroplanes

TAKE-OFF FLIGHT PATH CONSTRUCTION

1. ~~Introduction.~~—For demonstrating that ~~an~~**the** aeroplane clears all obstacles vertically, a flight path should be constructed consisting of an all-engines segment to the assumed engine failure height, followed by an engine-out segment. Where the ~~Aeroplane Flight Manual~~**AFM** does not contain the appropriate data, the approximation given in ~~paragraph~~**2.** below may be used for the all-engines segment for an assumed engine failure height of 200 ft, 300 ft, or higher.
2. Flight ~~p~~Path ~~c~~Construction
 - ~~2.1a.~~ All-~~e~~Engines ~~s~~Segment (50 ft to 300 ft)-

The average all-engines gradient for the all-engines flight path segment starting at an altitude of 50 ft at the end of the take-off distance ending at or passing through the 300 ft point is given by the following formula:

$$Y_{300} = \frac{0.57(Y_{ERC})}{1 + (V_{ERC}^2 - V_2^2) / 5647}$$

The factor of 0.77 as required by CAT.POL.A.310 is already included where:

~~NOTE: The factor of 0.77 as required by JAR OPS 1.535(a)(4) is already included where:~~

~~—————~~ Y_{300} = ~~a~~Average all-engines gradient from 50 ft to 300 ft;

~~—————~~ Y_{ERC} = ~~s~~Scheduled all engines en-route gross climb gradient;

~~—————~~ V_{ERC} = ~~e~~En-route climb speed, all engines knots **true airspeed (TAS)**;

~~—————~~ V_2 = ~~t~~Take-off speed at 50 ft, knots TAS;

EU-OPS Subpart F-I | Revised rule text

(See IEM OPS 1.535(a), Figure 1a for graphical presentation)

~~2.2b.~~ All ~~e~~Engines ~~s~~Segment (50 ft to 200 ft)-

This ~~(May be used as an alternative to 2.1a. above where weather minima permits.)~~ The average all-engines gradient for the all-engines flight path segment starting at an altitude of 50 ft at the end of the take-off distance ending at or passing through the 200 ft point is given by the following formula:

$$Y_{200} = \frac{0.51(Y_{ERC})}{1 + (V_{ERC}^2 - V_2^2) / 3388}$$

~~NOTE: The factor of 0.77 as required by CAT.POL.A.310JAR OPS 1.535(a)(4)~~ is already included where:

————— Y_{200} = ~~a~~Average all-engines gradient from 50 ft to 200 ft;

————— Y_{ERC} = ~~s~~Scheduled all engines en-route gross climb gradient;

————— V_{ERC} = ~~e~~En-route climb speed, all engines, knots TAS;

————— V_2 = ~~t~~Take-off speed at 50 ft, knots TAS.

(See IEM OPS 1.535(a), Figure 1b for graphical presentation)

~~2.3c.~~ All ~~e~~Engines ~~s~~Segment (above 300 ft)-

The all-engines flight path segment continuing from an altitude of 300 ft is given by the AFM en-route gross climb gradient, multiplied by a factor of 0.77.

~~2.4d.~~ The ~~OEI One Engine Inoperative f~~Flight ~~p~~Path-

The ~~one engine inoperative OEI~~ flight path is given by the ~~one engine inoperative OEI~~ gradient chart contained in the AFM.

GM1-CAT.POL.A.310 ~~Obstacle Clearance in Limited Visibility~~ Take-off obstacle clearance – multi-engined aeroplanes

OBSTACLE CLEARANCE IN LIMITED VISIBILITY

- 1. Unlike the airworthiness codes applicable for performance class A aeroplanes, those for performance class B aeroplanes do not necessarily provide for engine failure in all phases of flight. It is accepted that performance accountability for engine failure need not be considered until a height of 300 ft is reached.**

~~1. The intent of the complementary requirements JAR OPS 1.535 and Appendix 1 to JAR OPS 1.430 sub paragraph (a)(3)(ii) is to enhance safe operation with Performance Class B aeroplanes in conditions of limited visibility. Unlike the~~

EU-OPS Subpart F-I | Revised rule text

Performance Class A Airworthiness requirements, those for Performance Class B do not necessarily provide for engine failure in all phases of flight. It is accepted that performance accountability for engine failure need not be considered until a height of 300 ft is reached.

2. **The weather minima given up to and including 300 ft imply that if a take-off is undertaken with minima below 300 ft an OEI flight path should be plotted starting on the all-engines take-off flight path at the assumed engine failure height. This path should meet the vertical and lateral obstacle clearance specified in CAT.POL.A.310. Should engine failure occur below this height, the associated visibility is taken as being the minimum which would enable the pilot to make, if necessary, a forced landing broadly in the direction of the take-off. At or below 300 ft, a circle and land procedure is extremely inadvisable. The weather minima requirements specify that, if the assumed engine failure height is more than 300 ft, the visibility should be at least 1 500 m and, to allow for manoeuvring, the same minimum visibility should apply whenever the obstacle clearance criteria for a continued take-off cannot be met.**

~~2.5 Worked examples of the method given above are contained in IEM OPS 1.535(a).~~

GM2-CAT.POL.A.310 Take-off flight path construction – Take-off obstacle clearance – multi-engined aeroplanes

TAKE-OFF FLIGHT PATH CONSTRUCTION

1. This ~~IEM-GM~~ provides examples to illustrate the method of take-off flight path construction given in **AMC2-CAT.POL.A.310** ~~AMC OPS 1.535(a)~~. The examples shown below are based on an aeroplane for which the ~~Aeroplane Flight Manual~~ **AFM** shows, at a given mass, altitude, temperature and wind component the following performance data:

- f** Factored take-off distance – 1 000 m;
- t** Take-off speed, V_2 – 90 kt;
- e** En-route climb speed, V_{ERC} – 120 kt;
- e** En-route all-engines climb gradient, Y_{ERC} – 0.2; ~~00~~
- e** En-route ~~one-engine-inoperative~~ **OEI** climb gradient, Y_{ERC-1} – 0.032.

- a. Assumed ~~e~~Engine **f**Failure ~~h~~Height 300 ft.

The average all-engines gradient from 50 ft to 300 ft may be read from Figure 1a (~~page 2 H 8~~) or calculated with the following formula:

$$Y_{300} = \frac{0.57(Y_{ERC})}{1 + (V_{ERC}^2 - V_2^2) / 5647}$$

EU-OPS Subpart F-I | Revised rule text

The factor of 0.77 as required by CAT.POL.A.310 is already included where:

~~NOTE: The factor of 0.77 as required by JAR OPS 1.535(a)(4) is already included where:~~

~~_____ Y_{300} = **a**Average all-engines gradient from 50 ft to 300 ft;~~

~~_____ Y_{ERC} = **s**Scheduled all engines en-route gross climb gradient;~~

~~_____ V_{ERC} = **e**En-route climb speed, all engines knots TAS; **and**~~

~~_____ V_2 = **t**Take-off speed at 50 ft, knots TAS.~~

Figure 1: Assumed engine failure height 300 ft

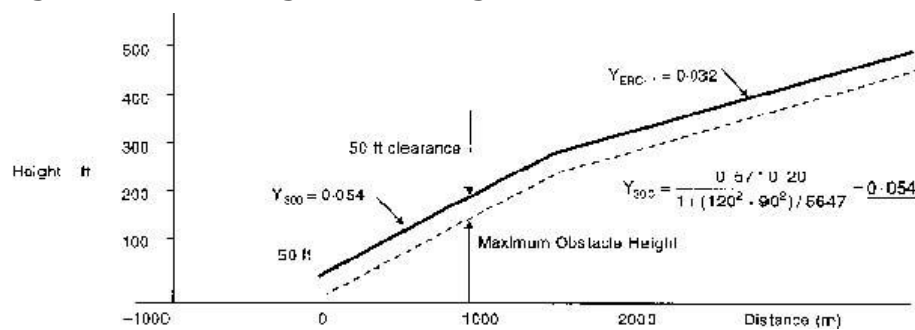

b. Assumed engine failure height 200 ft-

The average all-engines gradient from 50 ft to 200 ft may be read from Figure 21b (page 2 H 9) or calculated with the following formula:

$$Y_{200} = \frac{0.51(Y_{ERC})}{1 + (V_{ERC}^2 - V_2^2) / 3388}$$

The factor of 0.77 as required by CAT.POL.A.310 is already included where:

~~NOTE: The factor of 0.77 as required by JAR OPS 1.535(a)(4) is already included where:~~

~~Y_{200} = **a**Average all-engines gradient from 50 ft to 200 ft;~~

~~Y_{ERC} = **s**Scheduled all engines en-route gross gradient;~~

~~V_{ERC} = **e**En-route climb speed, all engines, knots TAS; **and**~~

$V_2 = V_{LOF}$ Take-off speed at 50 ft, knots TAS.

Figure 2: Assumed engine failure height 200 ft

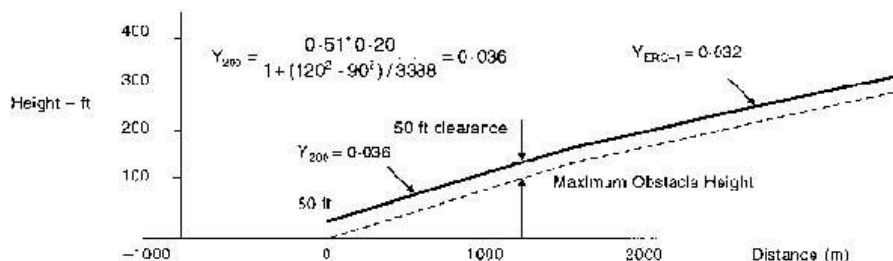

- c. Assumed engine failure height less than 200 ft-
Construction of a take-off flight path is only possible if the AFM contains the required flight path data.
- d. Assumed engine failure height more than 300 ft.
The construction of a take-off flight path for an assumed engine failure height of 400 ft is illustrated below.

Figure 3: Assumed engine failure height less than 200 ft

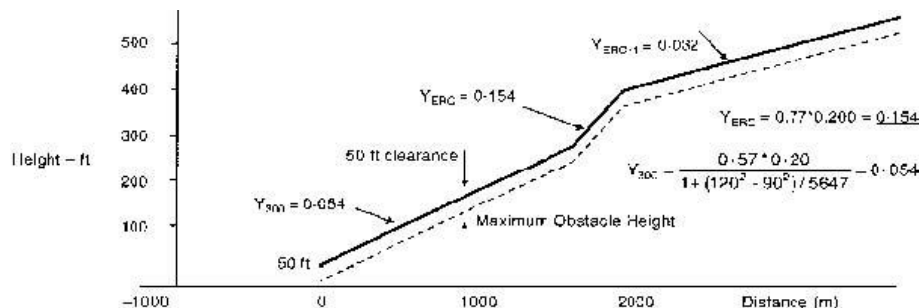

GM1-CAT.POL.A.315 En-route – multi-engined aeroplanes

CRUISING ALTITUDE

1. The altitude at which the rate of climb equals 300 ft per minute is not a restriction on the maximum cruising altitude at which the aeroplane can fly in practice, it is merely the maximum altitude from which the driftdown procedure can be planned to start.
2. Aeroplanes may be planned to clear en-route obstacles assuming a driftdown procedure, having first increased the scheduled en-route ~~one-engine inoperative~~ **OEI** descent data by 0.5 % gradient.

EU-OPS Subpart F-I | Revised rule text

AMC1-CAT.POL.A.320 En-route - sSingle-engine aeroplanes

ENGINE FAILURE

CAT.POL.A.320 ~~JAR OPS 1.542~~(a) requires ~~an~~**the** operator to ensure that in the event of an engine failure, the aeroplane should be capable of reaching a point from which a ~~successful~~**safe** forced landing can be made. Unless otherwise specified by the ~~competent a~~**Authority**, this point should be 1 000 ft above the intended landing area.}

GM1-CAT.POL.A.320 En-route – sSingle-engined Aeroplanes

ENGINE FAILURE

1. In the event of an engine failure, single-engine aeroplanes have to rely on gliding to a point suitable for a safe forced landing. Such a procedure is clearly incompatible with flight above a cloud layer ~~which~~**that** extends below the relevant minimum safe altitude.
2. ~~Operators~~**The operator** should first increase the scheduled engine-inoperative gliding performance data by 0.5 % gradient when verifying the en-route clearance of obstacles and the ability to reach a suitable place for a forced landing.
3. The altitude at which the rate of climb equals 300 ft per minute is not a restriction on the maximum cruising altitude at which the aeroplane can fly in practice, it is merely the maximum altitude from which the engine-inoperative procedure can be planned to start.

AMC1-CAT.POL.A.340–325 Landing – destination and alternate aerodromes Landing Destination and Alternate Aerodromes Landing – Dry runway

ALTITUDE MEASURING ~~LANDING DESTINATION AND ALTERNATE AERODROMES LANDING DRY RUNWAY~~

~~In showing compliance with JAR OPS 1.545 & JAR OPS 1.550,~~ **The operator** should use either pressure altitude or geometric altitude for his/**her** operation and this should be reflected in the ~~Operations Manual~~**operations manual**.

AMC12-CAT.POL.A.340-330 Landing – dry runways

LANDING DISTANCE CORRECTION FACTORS

1. Unless otherwise specified in the ~~Aeroplane Flight Manual~~**AFM**, or other performance or operating manuals {from the manufacturers, the variable affecting the landing performance and the associated factor that should be applied to the ~~Aeroplane Flight Manual~~**AFM** data is shown in the table below. It should be applied in addition to the operational factors as prescribed in **CAT.POL.A.330** ~~JAR OPS 1.550(a)~~.

Table 1: Landing distance correction factors }

EU-OPS Subpart F-I | Revised rule text

SURFACE TYPE	FACTOR
Grass (on firm soil up to 20 cm long)	1.15

2. ~~NOTE:~~ The soil **should be considered** firm when there are wheel impressions but no rutting.

GM1-CAT.POL.A.3340 ~~Landing – Dry Runway~~ Landing – dry runways**~~LANDING – DRY RUNWAY~~ LANDING MASS**

1. **CAT.POL.A.330** ~~JAR OPS 1.550(c)~~ establishes two considerations in determining the maximum permissible landing mass at the destination and alternate aerodromes.
2. Firstly, the aeroplane mass will be such that on arrival the aeroplane can be landed within ~~70 % of the landing distance available~~ **LDA** on the most favourable (normally the longest) runway in still air. ~~Regardless of the wind conditions, the maximum landing mass for an aerodrome/aeroplane configuration at a particular aerodrome, cannot be exceeded.~~
3. Secondly, consideration should be given to anticipated conditions and circumstances. The expected wind, or ATC and noise abatement procedures, may indicate the use of a different runway. These factors may result in a lower landing mass than that permitted under ~~paragraph 2. above, in which case, to show compliance with JAR OPS 1.550(a),~~ dispatch should be based on this lesser mass.
4. The expected wind referred to in ~~paragraph 3. above~~ is the wind expected to exist at the time of arrival.

~~JEM OPS 1.555~~ GM1-CAT.POL.A.335(a) Landing - wet and contaminated runways ~~Landing on Wet Grass Runways~~**LANDING ON WET GRASS RUNWAYS ~~SEE JAR OPS 1.555(A)~~**

1. When landing on very short grass which is wet, and with a firm subsoil, the surface may be slippery, in which case the distances may increase by as much as 60 % (1.60 factor).
2. As it may not be possible for a pilot to determine accurately the degree of wetness of the grass, particularly when airborne, in cases of doubt, the use of the wet factor (1.15) is recommended.

EU-OPS Subpart F-I | Revised rule text

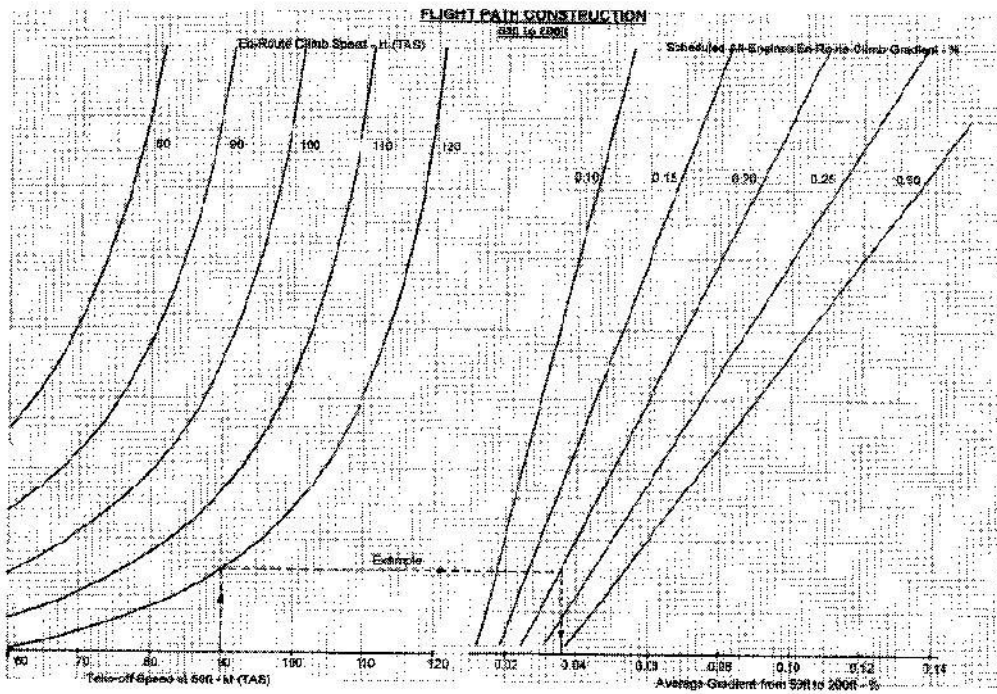
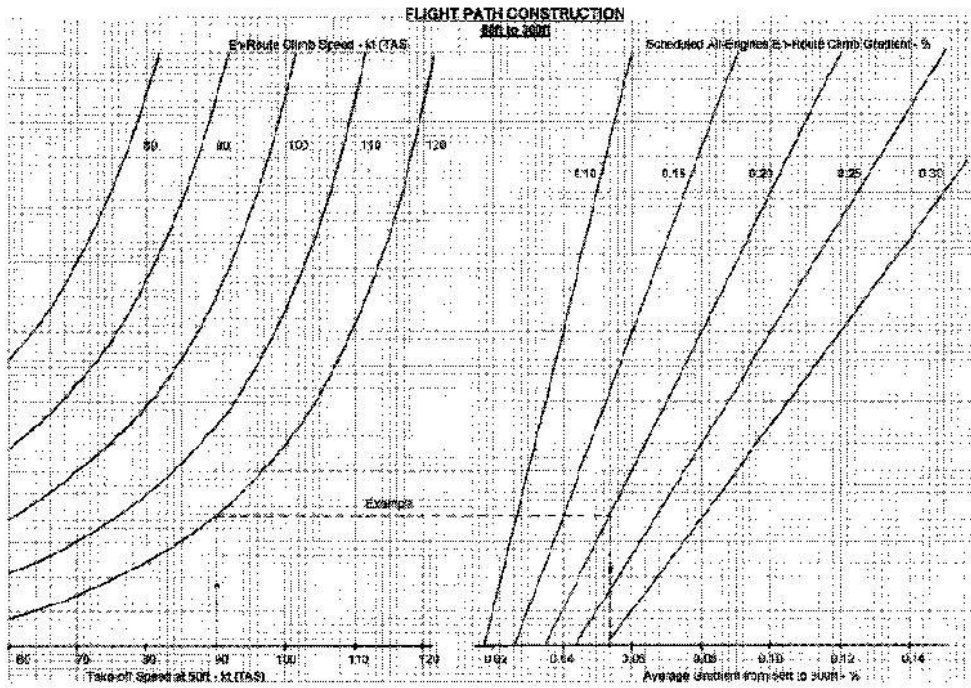

Chapter 4 – Performance class C**AMC1-CAT.POL.A.400 Take-off**~~GM2-CAT.POL.A.405 LOSS OF RUNWAY LENGTH DUE TO ALIGNMENT~~

LOSS OF RUNWAY LENGTH DUE TO ALIGNMENT

1. Introduction

1.1 The length of the runway which is declared for the calculation of TODA, ASDA and TORA, does not account for line-up of the aeroplane in the direction of take-off on the runway in use. This alignment distance depends on the aeroplane geometry and access possibility to the runway in use. Accountability is usually required for a 90° taxiway entry to the runway and 180° turnaround on the runway. There are two distances to be considered:

- a. The minimum distance of the main wheels from the start of the runway for determining TODA and TORA, "L"; and
- b. The minimum distance of the most forward wheel(s) from the start of the runway for determining ASDA, "N".

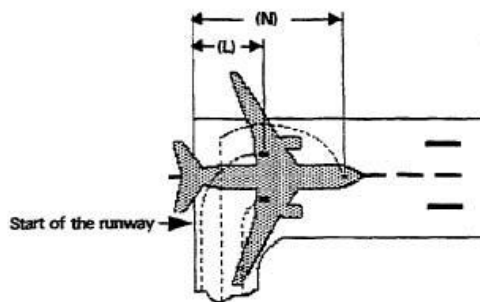
Figure 1: Line-up of the aeroplane in the direction of take-off – L and N

Where the aeroplane manufacturer does not provide the appropriate data, the calculation method given in paragraph 2. may be used to determine the alignment distance.

2. Alignment Distance Calculation

EU-OPS Subpart F-I | Revised rule text

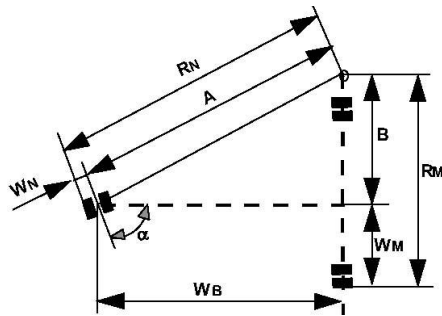

The distances mentioned in 1.(a) and 1.(b) of paragraph 1 above are:

	90° ENTRY	180° TURNAROUND
L =	RM + X	RN + Y
N =	RM + X + WB	RN + Y + WB

where:

$$RN = A + WN = \frac{WB}{\cos(90^\circ - \alpha)}$$

and

$$RM = B + WM = WB \tan(90^\circ - \alpha) + WM$$

X = ~~s~~Safety distance of outer main wheel during turn to the edge of the runway

Y = ~~s~~Safety distance of outer nose wheel during turn to the edge of the runway

NOTE: Minimum edge safety distances for X and Y are specified in FAA AC 150/5300-13 and ICAO Annex 14, ~~paragraph~~ 3.8.3

~~RN~~ = ~~r~~Radius of turn of outer nose wheel

~~RM~~ = ~~r~~Radius of turn of outer main wheel

~~WN~~ = ~~d~~Distance from aeroplane centre-line to outer nose wheel

~~WM~~ = ~~d~~Distance from aeroplane centre-line to outer main wheel

~~WB~~ = ~~w~~Wheel base

~~alpha~~ = ~~s~~Steering angle.

RUNWAY SLOPE

Unless otherwise specified in the ~~Aeroplane Flight Manual~~ **AFM**, or other performance or operating manuals from the manufacturers, the take-off distance should be increased by 5 % for each 1 % of upslope except that correction factors for runways with slopes in excess of 2 % **should only be applied when the operator has demonstrated to the competent authority that the necessary data in the AFM or the operations**

EU-OPS Subpart F-I | Revised rule text

manual contain the appropriated procedures and the crew is trained to take-off in runway with slopes in excess of 2 %. ~~need the acceptance of the Authority.~~

GM1-CAT.POL.A.405-400 Take-off

RUNWAY SURFACE CONDITION

Operation on runways contaminated with water, slush, snow or ice implies uncertainties with regard to runway friction and contaminant drag and therefore to the achievable performance and control of the aeroplane during take-off, since the actual conditions may not completely match the assumptions on which the performance information is based. An adequate overall level of safety can, therefore, only be maintained if such operations are limited to rare occasions. In case of a contaminated runway the first option for the commander is to wait until the runway is cleared. If this is impracticable, he may consider a take-off, provided that he has applied the applicable performance adjustments, and any further safety measures he considers justified under the prevailing conditions.

AMC1-CAT.POL.A.405 ~~Take-off Flight Path~~ Take-off obstacle clearance

EFFECT OF BANK ANGLES

TAKE-OFF FLIGHT PATH

1. The ~~Aeroplane Flight Manual~~ **AFM** generally provides a climb gradient decrement for a 15° bank turn. Unless otherwise specified in the ~~Aeroplane Flight Manual~~ **AFM** or other performance or operating manuals from the manufacturer, acceptable adjustments to assure adequate stall margins and gradient corrections are provided by the following:

Table 1: Effect of bank angles

BANK	SPEED	GRADIENT CORRECTION
15°	V_2	1 x Aeroplane Flight Manual AFM 15° gGradient Iloss
20°	$V_2 + 5 \text{ kt}$	2 x Aeroplane Flight Manual AFM 15° gGradient Iloss
25°	$V_2 + 10 \text{ kt}$	3 x Aeroplane Flight Manual AFM 15° gGradient Iloss

2. For bank angles of less than 15°, a proportionate amount may be applied, unless the manufacturer or ~~Aeroplane Flight Manual~~ **AFM** has provided other data.

REQUIRED NAVIGATIONAL ACCURACY

1. Flight-deck systems-

EU-OPS Subpart F-I | Revised rule text

The obstacle accountability semi-widths of 300 m (~~see JAR OPS 1.570(e)(1)~~) and 600 m (~~see JAR OPS 1.570(f)(1)~~) may be used if the navigation system under ~~one engine inoperative~~ **OEI** conditions provides a two standard deviation (~~2- σ~~) accuracy of 150 m and 300 m respectively.

2. Visual ~~c~~Course ~~g~~Guidance

~~2.1a.~~ The obstacle accountability semi-widths of 300 m (~~see JAR OPS 1.570(e)(1)~~) and 600 m (~~see JAR OPS 1.570(f)(1)~~) may be used where navigational accuracy is ensured at all relevant points on the flight path by use of external references. These references may be considered visible from the flight deck if they are situated more than 45° either side of the intended track and with a depression of not greater than 20° from the horizontal.

~~2.2b.~~ For visual course guidance navigation, ~~an~~ **the** operator should ensure that the weather conditions prevailing at the time of operation, including ceiling and visibility, are such that the obstacle and/or ground reference points can be seen and identified. The ~~Operations Manual~~ **operations manual** should specify, for the aerodrome(s) concerned, the minimum weather conditions which enable the flight crew to continuously determine and maintain the correct flight path with respect to ground reference points, so as to provide a safe clearance with respect to obstructions and terrain as follows:

- ~~ia.~~ **t**The procedure should be well defined with respect to ground reference points so that the track to be flown can be analysed for obstacle clearance requirements;
- ~~iib.~~ **t**The procedure should be within the capabilities of the aeroplane with respect to forward speed, bank angle and wind effects;
- ~~iiie.~~ **a**A written and/or pictorial description of the procedure should be provided for crew use; **and**
- ~~ivd.~~ **t**The limiting environmental conditions (such as wind, the lowest cloud base, ceiling, visibility, day/night, ambient lighting, obstruction lighting) should be specified.}

AMC1-CAT.POL.A.41520 En-rRoute – OEIOne Engine Inoperative**ROUTE ANALYSIS**~~SUBTITLE~~

The high terrain or obstacle analysis ~~required for showing compliance with JAR OPS 1.580 can~~ **may** be carried out by making a detailed analysis of the route using contour maps of the high terrain, and plotting the highest points within the prescribed corridor width along the route. The next step is to determine whether it is possible to maintain level flight with ~~one engine inoperative~~ **OEI** 1 000 ft above the highest point of the crossing. If this is not possible, or if the associated weight penalties are unacceptable, a drift-down procedure must be evaluated, based on engine failure at the most critical point, and must show obstacle clearance during the drift-down by at least 2 000- ft. The minimum cruise altitude is determined from the drift-down path, taking into account allowances for decision making, and the reduction in the scheduled rate of climb (See Figure 1).

Figure 1: Intersection of the driftdown paths

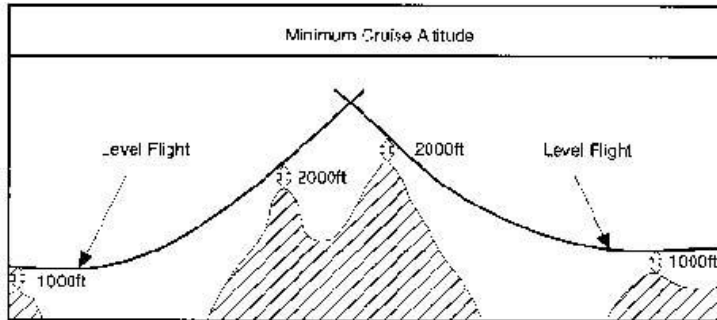

FIGURE 1

~~AMC1-CAT.POL.A.42530 & 435 Landing - dDestination and aAlternate
aAerodromes, Landing - Dry Runways~~

ALTITUDE MEASURING

SUBTITLE

~~IN SHOWING COMPLIANCE WITH JAR OPS 1.590 AND JAR OPS 1.595, THE OPERATOR
SHOULD USE EITHER PRESSURE ALTITUDE OR GEOMETRIC ALTITUDE FOR HIS/HER
OPERATION AND THIS SHOULD BE REFLECTED IN THE OPERATIONS
MANUAL OPERATIONS MANUAL.~~

~~AMC1-CAT.POL.A.430 Landing - Distance Correction Factors Landing - dry
rRunways~~

LANDING DISTANCE CORRECTION FACTORS

1. Unless otherwise specified in the ~~Aeroplane Flight Manual~~ **AFM** or other performance or operating manuals from the manufacturers, the variables affecting the landing performance and the associated factors to be applied to the ~~Aeroplane Flight Manual~~ **AFM** data are shown in the table below. It should be applied in addition to the factor specified in ~~CAT.POL.A.430~~ **JAR OPS 1.595(a)**.

Table 1: Landing distance correction factor

SURFACE TYPE	FACTOR
Grass (on firm soil up to 20 cm long)	1.2

EU-OPS Subpart F-I | Revised rule text

SURFACE TYPE	FACTOR
Grass (on firm soil up to 13 cm long)	1-20

2. ~~NOTE:~~ The soil **should be considered** is firm when there are wheel impressions but no rutting.

RUNWAY SLOPE

Unless otherwise specified in the ~~Aeroplane Flight Manual~~ **AFM**, or other performance or operating manuals ~~from the manufacturer~~, the landing distances required should be increased by 5 % for each 1 % of downslope.

GM1-CAT.POL.A.435-430 Landing - dry rRunways**LANDING MASS**

1. ~~CAT.POL.A.430~~ **CAT.POL.A.430** ~~JAR OPS 1.595(c)~~ establishes two considerations in determining the maximum permissible landing mass at the destination and alternate aerodromes.
2. Firstly, the aeroplane mass will be such that on arrival the aeroplane can be landed within 70 % of the ~~landing distance available~~ **LDA** on the most favourable (normally the longest) runway in still air. Regardless of the wind conditions, the maximum landing mass for an aerodrome/aeroplane configuration at a particular aerodrome, cannot be exceeded.
3. Secondly, consideration should be given to anticipated conditions and circumstances. The expected wind, or ATC and noise abatement procedures, may indicate the use of a different runway. These factors may result in a lower landing mass than that permitted under ~~paragraph 2. above~~, in which case, ~~to show compliance with JAR OPS 1.595(a)~~, dispatch should be based on this lesser mass.
4. The expected wind referred to in ~~paragraph 3.~~ is the wind expected to exist at the time of arrival.

Subpart J | Revised rule text

Scope

This document shows changes to

- Subpart J of EU-OPS and JAR-OPS3;
- Related Section 2 material of JAR-OPS1 and JAR-OPS3.

This document contains the revised rule text for

- Part-CAT: CAT.POL.MAB.

*Subpart J | Revised rule text***Table of Contents**

Part-CAT	4
Subpart C – Aircraft performance and operating limitations.....	4
Section 1 Mass and balance	4
Chapter 1 – Motor powered aircraft	4
CAT.POL.MAB.100 Mass and balance, loading	4
CAT.POL.MAB.105 Mass and balance data and documentation	5
Part-CAT – AMC/GM	7
Subpart C – Aircraft performance and operating limitations.....	7
Section 1 Mass and balance	7
Chapter 1 – Motor powered aircraft	7
AMC1-CAT.POL.MAB.100(b) Mass and balance, loading.....	7
WEIGHING OF AN AIRCRAFT.....	7
FLEET MASS AND CG POSITION – AEROPLANES.....	8
CENTRE OF GRAVITY LIMITS – OPERATIONAL CG ENVELOPE AND IN-FLIGHT CG	10
AMC1-CAT.POL.MAB.100(c) Mass and balance, loading	11
MASS VALUES FOR CREW.....	11
DRY OPERATING MASS	11
AMC1-CAT.POL.MAB.100(d)Mass and balance, loading.....	12
mass values for passengers and baggage	12
PROCEDURE FOR ESTABLISHING REVISED STANDARD MASS VALUES FOR PASSENGERS AND BAGGAGE.....	16
GM1-CAT.POL.MAB.100(d) Mass and balance, loading	18
ADJUSTMENT OF STANDARD MASSES	18
GM2-CAT.POL.MAB.100(d) Mass and Balance, Loading	18
STATISTICAL EVALUATION OF PASSENGERS AND BAGGAGE DATA.....	18
GM3-CAT.POL.MAB.100(d) mass and balance, loading	23
GUIDANCE ON PASSENGER WEIGHING SURVEYS	23
GM1-CAT.POL.MAB.100(g) Mass and balance, loading	25
FUEL DENSITY	25
GM1-CAT.POL.MAB.100.H(i) Mass and balance, loading	25
IN-FLIGHT CHANGES IN LOADING - HELICOPTERS.....	25
AMC1-CAT.POL.MAB.105(a) Mass and balance data and documentation.....	25

Subpart J | Revised rule text

CONTENTS AND SYSTEM 25
GM1-CAT.POL.MAB.105(c) Mass and balance data and documentation..... 26
ON BOARD INTEGRATED MASS AND BALANCE COMPUTER SYSTEM. 26
STAND-ALONE COMPUTERISED MASS AND BALANCE SYSTEM 26

Subpart J | Revised rule text

Part-CAT

Subpart C – Aircraft performance and operating limitations

~~SUBPART J~~Section 1 Mass and balance ~~ASS AND BALANCE~~

Chapter 1 – Motor pPowered aAircraft

~~OPS 1.605~~ CAT.POL.MAB.100 Mass and ~~and~~ balance, loading ~~General~~
(~~See Appendix 1 to OPS 1.605~~)

- (a) ~~An operator shall ensure that d~~ During any phase of operation, the loading, mass and centre of gravity of the ~~aeroplane~~ **aircraft shall** comply with the limitations specified in the approved ~~Aeroplane~~ **aircraft flight manual**, or the ~~Operations~~ **Manual** if more restrictive.
- (b) ~~The operator must~~ **shall** establish the mass and the centre of gravity of any ~~aeroplane~~ **aircraft** by actual weighing prior to initial entry into service and thereafter at intervals of 4 years if individual ~~aeroplane~~ **aircraft** masses are used ~~or~~ 9 years if fleet masses are used. The accumulated effects of modifications and repairs on the mass and balance ~~must~~ **shall** be accounted for and properly documented. ~~Furthermore, aeroplanes a~~ **Aircraft must** be reweighed if the effect of modifications on the mass and balance is not accurately known.
- (c) The weighing ~~must~~ **shall** be accomplished either by the manufacturer ~~of the~~ **aircraft** or by an approved maintenance organisation.
- (d) ~~The operator must~~ **shall** determine the mass of all operating items and crew members included in the ~~aeroplane~~ **aircraft** dry operating mass by weighing or by using standard masses. The influence of their position on the ~~aeroplane~~ **aircraft** centre of gravity ~~must~~ **shall** be determined.
- (e) ~~The operator must~~ **shall** establish the mass of the traffic load, including any ballast, by actual weighing or **by determining** the mass of the traffic load in accordance with standard passenger and baggage masses. ~~as specified in OPS 1.620.~~
- (f) **In addition to standard masses for passengers and checked baggage, the operator can use standard masses for other load items, if it demonstrates to the competent authority that these items have the same weight or their weight is within specified tolerances.**
- (g) An operator ~~must~~ **shall** determine the mass of the fuel load by using the actual density or, if not known, the density calculated in accordance with a method specified in the ~~Operations~~ **Manual**.
- (h) ~~Aeroplane loading~~ **The operator shall ensure that the loading of**
- (1) ~~An operator must ensure that the loading of its aeroplanes~~ **aircraft** is performed under the supervision of qualified personnel; **and**
 - (2) ~~An operator must ensure that the loading of the freight~~ **traffic load** is consistent with the data used for the calculation of the ~~aeroplane~~ **aircraft** mass and balance.
- (3i) ~~The operator must~~ **shall** comply with additional structural limits such as the floor strength limitations, the maximum load per running metre, the maximum mass per

Comment [GC1]: From Appendix 1 to JAR OPS 1.605/3.605
Added criteria for using standard masses for these items.

Subpart J | Revised rule text

cargo compartment, and ~~for~~ the maximum seating limit. ~~For helicopters, in addition, the operator shall take account of~~ in-flight changes in loading.

- (j) ~~The operator must~~**shall** specify, in the operations manual, the principles and methods involved in the loading and in the mass and balance system **that** meet the requirements of ~~OPS 1.605~~above. This system ~~must~~**shall** cover all types of intended operations.

~~OPS 1.607~~**Terminology**(a) ~~Dry Operating Mass~~. The total mass of the aeroplane ready for a specific type of operation excluding all usable fuel and traffic load. This mass includes items such as:

- ~~(1) Crew and crew baggage;~~
- ~~(2) Catering and removable passenger service equipment; and~~
- ~~(3) Potable water and lavatory chemicals.~~

~~(b) Maximum Zero Fuel Mass~~. The maximum permissible mass of an aeroplane with no usable fuel. The mass of the fuel contained in particular tanks must be included in the zero fuel mass when it is explicitly mentioned in the Aeroplane Flight Manual limitations.

~~(c) Maximum Structural Landing Mass~~. The maximum permissible total aeroplane mass upon landing under normal circumstances.

~~(d) Maximum Structural Take Off Mass~~. The maximum permissible total aeroplane mass at the start of the take off run.

~~(e) Passenger classification.~~

- ~~(1) Adults, male and female, are defined as persons of an age of 12 years and above.~~
- ~~(2) Children are defined as persons who are of an age of two years and above but who are less than 12 years of age.~~
- ~~(3) Infants are defined as persons who are less than 2 years of age.~~

~~(f) Traffic Load~~. The total mass of passengers, baggage and cargo, including any non-revenue load.

Comment [cg2]: Moved to Cover Regulation except when additionally commented below.

Comment [GC13]: General Definition of Dry Operating mass is moved to cover regulation. The specification is moved instead to AMC level.

Comment [cg4]: Only used in AMC. This is moved to AMC Definitions

Comment [cg5]: Only used in AMC. This is moved to AMC Definitions

Comment [cg6]: Not used

~~OPS 1.610~~**Loading, mass and balance**

An operator shall specify, in the Operations Manual, the principles and methods involved in the loading and in the mass and balance system that meet the requirements of OPS 1.605. This system must cover all types of intended operations.

~~OPS 1.625~~**CAT.POL.GENMAB.105 Mass and balance data and documentation (See Appendix 1 to OPS 1.625)**

- (a) **The operator shall establish mass and balance data and produce mass and balance** documentation prior to each flight specifying the load and its distribution. The mass and balance documentation ~~must~~**shall** enable the commander to determine that the load and its distribution is such that the mass and balance limits of the aeroplane ~~aircraft~~ are not exceeded. ~~The person preparing the mass and balance documentation must be named on the document. The person supervising the loading of the aeroplane must confirm by signature that the load and its distribution are in accordance with the mass and balance documentation. This document must be acceptable to the commander, his/her acceptance being~~

Comment [cg7]: Moved to Cover Regulation and changed to accommodate for extended scope

Comment [DDE8]: Moved to subparagraph (h) of CAT.POL.GEN.100

Subpart J | Revised rule text

indicated by countersignature or equivalent. (See also OPS 1.1055 (a)(12)). **The mass and balance documentation shall contain the following information:**

- (1) Aircraft registration and type;**
- (2) Flight identification number and date;**
- (3) Name of the commander;**
- (4) Name of the person who prepared the document;**
- (5) Dry operating mass and the corresponding centre of gravity (CG) of the aircraft;**
 - (i) For Performance Class B aeroplanes and for helicopters, the CG position may not need to be on the mass and balance documentation, if, for example, the load distribution is in accordance with a pre-calculated balance table or if it can be shown that for the planned operations a correct balance can be ensured, whatever the real load is.**

Comment [S9]: Since (c) allows alternative procedures to (a) and (b), which can only relate to the prescriptive part, this is transferred to AMC.

Comment [GCI10]: From Appendix 1 to OPS 1.625

- (6) ~~The~~ Mass of the fuel at take-off and the mass of trip fuel;**
- (7) Mass of consumables other than fuel, ~~if applicable~~;**
- (8) Load components ~~of the load~~ including passengers, baggage, freight and ballast;**
- (9) Take-off Mass, Landing Mass and Zero Fuel Mass;**
- (10) Applicable aircraft CG positions; and**
- (12) The limiting mass and CG values.**

Comment [GCI11]: To accommodate different kinds of aircraft

The information above shall be available in flight planning documents or mass and balance systems. Where mass and balance data and documentation is generated by a computerised mass and balance system, the operator shall verify the integrity of the output data.

(b) ~~The operator must~~ **shall** specify procedures for ~~last m~~ **Minute c**Changes to the load to ensure that:

- (1) Any last minute change after the completion of the mass and balance documentation is brought to the attention of the commander and entered in the flight planning documents containing the mass and balance documentation;**
- (2) The maximum last minute change allowed in passenger numbers or hold load is specified.**
- (3) New mass and balance documentation is prepared if this maximum number is exceeded.**

(c) The operator ~~must~~ shall obtain approval of the **competent A**authority if it wishes to use an onboard **integrated** mass and balance computer system **or a stand-alone computerised mass and balance system** as a primary source for dispatch. **The operator shall demonstrate the accuracy and reliability of that system.**

Comment [GCI12]: Paragraph added to cover computerized stand-alone systems. To Make a distinction between on-board systems intended as aircraft systems and laptop computerised systems requiring input from the user.

Subpart J | Revised rule text

~~(c) Subject to the approval of the Authority, an operator may use an alternative to the procedures required by paragraphs (a) and (b) above.~~

Part-CAT – AMC/GM

Subpart C – Aircraft performance and operating limitations

Section 1 Mass and balance

Chapter 1 – Motor powered aircraft

~~Appendix 1 to OPS 1.605~~ **AMC1-CAT.POL.MAB.100** (b) Mass and balance, loading ~~General~~
(See OPS 1.605)

Comment [WSI13]:

This is regarded as a means to comply with the safety objective. Moreover, it would allow sufficient flexibility to account for different operational circumstances.

WEIGHING OF AN AIRCRAFT

~~(a) Determination of the dry operating mass of an aeroplane~~

~~(1) WEIGHING OF AN AEROPLANE AIRCRAFT~~

~~(i) 1. New aeroplanes aircraft are normally that have been weighed at the factory and are eligible to may be placed into operation without reweighing if the mass and balance records have been adjusted for alterations or modifications to the aeroplane aircraft. Aeroplanes Aircraft transferred from one EU operator with an approved mass control programme to another EU operator with an approved programme need do not have to be weighed prior to use by the receiving operator, unless more than 4 four years have elapsed since the last weighing.~~

~~(ii) 2. The individual mass and centre of gravity (CG) position of each aeroplane aircraft shall should be revised whenever the cumulative changes to the dry operating mass exceed ± 0.5 % of the maximum landing mass or for aeroplanes the cumulative change in CG position exceeds 0.5 % of the mean aerodynamic chord. This may be done by weighing the aircraft or by calculation. re-established periodically. The maximum interval between two weighings must be defined by the operator and must meet the requirements of OPS 1.605 (b). In addition, the mass and the CG of each aeroplane shall be re-established either by:~~

~~(A) Weighing; or~~

~~(B) Calculation, if the operator is able to provide the necessary justification to prove the validity of the method of calculation chosen, whenever the cumulative changes to the dry operating mass exceed $\pm 0,5$ % of the maximum landing mass or the cumulative change in CG position exceeds 0,5 % of the mean aerodynamic chord.~~

Comment [DDE14]: Included in 1 and 2 above

~~3. (ii) When weighing an aircraft, Normal precautions must should be taken consistent with good practices such as:~~

~~(A) a. checking for completeness of the aeroplane aircraft and equipment;~~

~~(B) b. determining that fluids are properly accounted for;~~

~~(C) c. ensuring that the aircraft is clean; and~~

~~(D) d. ensuring that weighing is accomplished in an enclosed building.~~

Subpart J | Revised rule text

4.(iii) Any equipment used for weighing ~~must~~**should** be properly calibrated, zeroed, and used in accordance with the manufacturer's instructions. Each scale ~~must~~**should** be calibrated either by the manufacturer, by a civil department of weights and measures or by an appropriately authorized organisation within ~~2~~**two** years or within a time period defined by the manufacturer of the weighing equipment, whichever is less. The equipment ~~must~~**should** enable the mass of the aircraft to be established accurately. One single accuracy criterion for weighing equipment cannot be given. However, the weighing accuracy is considered satisfactory if the following accuracy criteria **in Table 1** are met by the individual scales/cells of the weighing equipment used:

Comment [cg15]: Includes IEM to Appendix 1 to JAR OPS 1/3.605 (a)(4)/(2)(iii)

- ~~a. For a scale/cell load below 2 000 kg an accuracy of ± 1%;~~
- ~~b. For a scale/cell load from 2 000 kg to 20 000 kg an accuracy of ± 20 kg; and~~
- ~~c. For a scale/cell load above 20 000 kg an accuracy of ± 0.1 %.~~

Comment [GCI16]: Text put into a table.

Table 1: -Accuracy criteria for weighing equipment

For a scale/cell load	An accuracy of
below 2 000 kg	± 1%
from 2 000 kg to 20 000 kg	± 20 kg
from 2 000 kg to 20 000 kg	± 0.1 %

FLEET MASS AND CG POSITION – AEROPLANES

~~(2) FLEET MASS AND CG POSITION~~

~~(i)1.~~ For a fleet ~~or~~ group of aeroplanes of the same model and configuration, an average dry operating mass and CG position may be used as the fleet mass and CG position, provided that:

- ~~a.~~ the dry operating mass ~~es and CG positions of the~~**an** individual aeroplane ~~s does not differ by more than ±0.5 % of the maximum structural landing mass from the established dry operating fleet mass, or~~
- ~~b.~~ **the CG position of an individual aeroplane does not differ by more than ±0.5 % of the mean aerodynamic chord from the established fleet CG.**

~~meet the tolerances specified in subparagraph (ii) below. Furthermore, the criteria specified in subparagraphs (iii), (iv) and (a)(3) below are applicable.~~

~~(ii) Tolerances~~

~~(A) If the dry operating mass of any aeroplane weighed, or the calculated dry operating mass of any aeroplane of a fleet, varies by more than ±0,5 % of the maximum structural landing mass from the established dry operating fleet mass or the CG position varies by more than ±0,5 % of the mean aerodynamic chord from the fleet CG, that aeroplane shall be omitted from that fleet. Separate fleets may be established, each with differing fleet mean masses.~~

~~(A)2.~~**The operator should verify that, after an equipment or configuration change or after weighing, the aeroplane falls within the tolerances above.**~~After the weighing of an aeroplane, or if any change occurs in the aeroplane~~

Subpart J | Revised rule text

~~equipment or configuration, the operator must verify that this aeroplane falls within the tolerances specified in subparagraph (2)(ii) above.~~

~~(C)3.~~ To add an aeroplane to a fleet operated with fleet values, the operator ~~must~~**should** verify by weighing or ~~computation~~**calculation** that its actual values fall within the tolerances specified in ~~subparagraph (2)(ii) above~~**1.a and b.**

4. To obtain fleet values, the operator should weigh, in the period between two fleet mass evaluations, a certain number of aeroplanes as specified in Table 2, where "n" is the number of aeroplanes in the fleet using fleet values. Those aeroplanes in the fleet which have not been weighed for the longest time should be selected first.

~~(iii) Use of fleet values~~

~~(3) Number of aeroplanes to be weighed to obtain fleet values~~

~~(i) If "n" is the number of aeroplanes in the fleet using fleet values, the operator must at least weigh, in the period between two fleet mass evaluations, a certain number of aeroplanes defined in the Table below:~~

Table 2: Minimum number of weighings to obtain fleet values

Number of aeroplanes in the fleet	Minimum number of weighings
2 or 3	n
4 to 9	$(n + 3)/2$
10 or more	$(n + 51)/10$

~~(ii) In choosing the aeroplanes to be weighed, aeroplanes in the fleet which have not been weighed for the longest time should be selected.~~

~~5.(iii)~~ The interval between two fleet mass evaluations ~~must~~**should** not exceed 48 months.

~~6.(iv)~~ To comply with subparagraph (2)(i) above, ~~t~~The fleet values ~~must~~**should** be updated at least at the end of each fleet mass evaluation.

~~(B)7.~~ Aeroplanes which have not been weighed since the last fleet mass evaluation ~~can~~**may** still be kept in a fleet operated with fleet values, provided that the individual values are revised by ~~computation~~**calculation** and stay within the tolerances defined in subparagraph (2)(ii) above. If these individual values no longer fall within the permitted tolerances, the operator ~~must~~**should** either determine new fleet values fulfilling the conditions of subparagraphs (2)(i) and (2)(ii) above, or operate the aeroplanes not falling within the limits with their individual values.

~~(B)8.~~ If ~~n~~ cases where ~~the~~**an individual** aeroplane mass is within the dry operating fleet mass tolerance but its CG position ~~falls outside the permitted fleet~~**exceeds the** tolerance, the aeroplane may still be operated under the applicable dry operating fleet mass but with an individual CG position.

~~(C)~~ If an individual aeroplane has, when compared with other aeroplanes of the fleet, a physical, accurately accountable difference (e.g. galley or seat configuration), that causes exceedance of the fleet tolerances, this aeroplane may be maintained in the fleet provided that appropriate corrections are applied to the mass and/or CG position for that aeroplane.

~~(D)9.~~ Aeroplanes for which no mean aerodynamic chord has been published ~~must~~**should** be operated with their individual mass and CG position values. ~~They may or must be operated under the dry operating fleet mass and CG position, subjected to approval~~**provided that a risk assessment has been completed.**

Comment [S17]: This was already deleted in the NPA and no adverse comments were received. In fact it is in contradiction with old paragraph (A), now 1.a and b above.

Comment [DDE18]: If they fall within the tolerances a separate approval may not be necessary. New wording "provided that a risk assessment has been completed" in place of "study" is adopted, also supported by the Review Group.

Subpart J | Revised rule text

~~(4) Weighing procedure~~

~~(i) The weighing must be accomplished either by the manufacturer or by an approved maintenance organisation.~~

Comment [DDE19]: Moved to IR

~~(b) Special standard masses for the traffic load. In addition to standard masses for passengers and checked baggage, an operator can submit for approval to the Authority standard masses for other load items.~~

Comment [S20]: Moved to IR

CENTRE OF GRAVITY LIMITS – OPERATIONAL CG ENVELOPE AND IN-FLIGHT CG~~(D) CENTRE OF GRAVITY LIMITS – OPERATIONAL CG ENVELOPE AND IN-FLIGHT CG~~

~~(1) Operational CG envelope. Unless seat allocation is applied and the effects of the number of passengers per seat row, of cargo in individual cargo compartments and of fuel in individual tanks is accounted for accurately in the balance calculation, operational margins must be applied to the certificated centre of gravity envelope. In determining the CG margins, possible deviations from the assumed load distribution must be considered. If free seating is applied, the operator must introduce procedures to ensure corrective action by flight or cabin crew if extreme longitudinal seat selection occurs. The CG margins and associated operational procedures, including assumptions with regard to passenger seating, must be acceptable to the Authority.~~

~~(2) In flight centre of gravity. Further to subparagraph (d)(1) above, the operator must show that the procedures fully account for the extreme variation in CG travel during flight caused by passenger/crew movement and fuel consumption/transfer.~~

Comment [GC121]: Merged with contents of Originally IEM to Appendix 1 to JAR-OPS 1.605 & IEM to Appendix 1 to JAR-OPS 3.605 sub-paragraph (d)

In the Certificate Limitations section of the aircraft flight manual, forward and aft CG limits are specified. These limits ensure that the certification stability and control criteria are met throughout the whole flight and allow the proper trim setting for take-off. ~~An~~ **The** operator should ensure that these limits are ~~observed~~ **respected** by:

1. **Defining and applying operational margins to the certified CG envelope in order to compensate for the following deviations and errors:**

~~defining operational procedures or CG envelope which compensates for deviations and errors as listed below:~~

- ~~a~~1. Deviations of actual CG at empty or operating mass from published values due, for example, to weighing errors, unaccounted modifications and/or equipment variations;
- ~~2~~b. Deviations in fuel distribution in tanks from the applicable schedule;
- ~~3~~c. Deviations in the distribution of baggage and cargo in the various compartments as compared with the assumed load distribution as well as inaccuracies in the actual mass of baggage and cargo;
- ~~4~~d. Deviations in actual passenger seating from the seating distribution assumed when preparing the mass and balance documentation. Large CG errors may occur when 'free seating', **i.e.** {freedom of passengers to select any seat when entering the aircraft}, is permitted. Although in most cases reasonably even longitudinal passenger seating can be expected, there is a risk of an extreme forward or aft seat selection causing very large and unacceptable CG errors, {assuming that the balance calculation is done on the basis of an assumed even distribution}. The largest errors may occur at a load factor of approximately 50% if all passengers are seated in either the forward or aft

Subpart J | Revised rule text

half of the cabin. Statistical analysis indicates that the risk of such extreme seating adversely affecting the CG is greatest on small aircraft;

- 5e. Deviations of the actual CG of cargo and passenger load within individual cargo compartments or cabin sections from the normally assumed mid position;
- 6f. Deviations of the CG caused by gear and flap positions and by application of the prescribed fuel usage procedure, (unless already covered by the certified limits);
- 7g. Deviations caused by in-flight movement of cabin crew, galley equipment and passengers; **and**
- h. **On small aeroplanes, deviations caused by the difference between actual passenger masses and standard passengers masses when such masses are used.**

Comment [GCI22]: Input from IEM OPS 1.620(h) & (i) Adjustment of standard masses point (b)

- 2. **Defining and applying operational procedures in order to:**
 - a. **ensure an evenly distribution of passengers in the cabin;**
 - b. **take into account any significant CG travel during flight caused by passenger/crew movement; and**
 - c. **take into account any significant CG travel during flight caused by fuel consumption/transfer.**

~~OPS 1.615~~ **AMC1-CAT.POL.MAB.100(c) Mass and balance, loading Mass values for crew**

MASS VALUES FOR CREW

- (a) **1. The operator shall** ~~shall~~ **should** use the following mass values **for crew** to determine the dry operating mass:
 - a Actual masses including any crew baggage; or
 - b Standard masses, including hand baggage, of 85 kg for flight crew/**technical crew** members and 75kg for cabin crew members. ~~;~~ ~~or~~

Comment [WSI23]: This is regarded as a means to comply with the safety objective. Moreover, it would allow sufficient flexibility to account for different operational circumstances.

~~(3) Other standard masses acceptable to the Authority.~~

Comment [S24]: Deleted. This goes through alternative AMC procedure

- (b) **2. The operator must** ~~must~~ **should** correct the dry operating mass to account for any additional baggage. The position of this additional baggage **must** ~~must~~ **should** be accounted for when establishing the centre of gravity of the aeroplane.

DRY OPERATING MASS

The dry operating mass includes:

- 1. **crew and crew baggage;**
- 2. **catering and removable passenger service equipment; and**
- 3. **tank water and lavatory chemicals.**

Subpart J | Revised rule text

~~OPS 1.620~~ **AMC1-CAT.POL.MAB.100(d) Mass and balance, loading****MASS VALUES FOR PASSENGERS AND BAGGAGE**~~MASS VALUES FOR PASSENGERS AND BAGGAGE~~

~~(a) An operator shall compute the mass of passengers and checked baggage using either the actual weighed mass of each person and the actual weighed mass of baggage or the standard mass values specified in Tables 1 to 3 below except where the number of passenger seats available is less than 10. In such cases passenger mass may be established by use of a verbal statement by, or on behalf of, each passenger and adding to it a predetermined constant to account for hand baggage and clothing. The procedure specifying when to select actual or standard masses and the procedure to be followed when using verbal statements must be included in the Operations Manual.~~ **1. When the number of passenger seats available is:**

- a. less than 10 for aeroplanes; or**
- b. less than 6 for helicopters;**

passenger mass may be calculated on the basis of a statement by, or on behalf of, each passenger, adding to it a predetermined mass to account for hand baggage and clothing.

The predetermined mass for hand baggage and clothing should be established by the operator on the basis of studies relevant to his particular operation. In any case, it should not be less than:

- a. 4 kg for clothing; and**
- b. 6 kg for hand baggage.**

The passengers' stated mass and the mass of passengers' clothing and hand baggage should be checked prior to boarding and adjusted, if necessary. The operator should establish a procedure in the operations manual when to select actual or standard masses and the procedure to be followed when using verbal statements.

~~(b) 2. If~~ **When** determining the actual mass by weighing, ~~an operator must ensure that passengers' personal belongings and hand baggage are~~ **should be** included. Such weighing ~~must~~ **should** be conducted immediately prior to boarding ~~the aircraft and at an adjacent location.~~ **the aircraft.**

~~(c) 3. If~~ **When** determining the mass of passengers **by** using standard mass values, the standard mass values in Tables 1 and 2 below ~~must~~ **should** be used. The standard masses include hand baggage and the mass of any infant ~~below 2 years of age~~ carried by an adult on one passenger seat. Infants occupying separate passenger seats ~~must~~ **should** be considered as children for the purpose of this subparagraph. ~~AMC. (1) When~~ **are** the total number of passenger seats available on an ~~aeroplane~~ **aircraft** is 20 or more, the standard masses of male and female in Table 1 ~~are applicable~~ **should be used**. As an alternative, in cases where the total number of passenger seats available is 30 or more, the "All Adult" mass values in Table 1 ~~are applicable~~ **may be used**.

Comment [WSI25]:

This is regarded as a means to comply with the safety objective. Moreover, it would allow sufficient flexibility to account for different operational circumstances.

Comment [WSI26]: Text from (a) above + AMC OPS 1.620 (a) and AMC OPS 3.620 (a)

Subpart J | Revised rule text

Table 1: Standard masses for passengers – aircraft with a total number of passenger seats of 20 or more

Passenger seats:	20 and more		30 and more
	Male	Female	All adult
All flights except holiday charters	88 kg	70 kg	84 kg
Holiday charters*	83 kg	69 kg	76 kg
Children	35 kg	35 kg	35 kg

* (2) ~~For the purpose of Table 1, a~~ holiday charter means a charter flight ~~solely intended as an element that is part of a~~ holiday travel package. On such flights the entire passenger capacity is hired by one or more charterer(s) for the carriage of passengers who are travelling, all or in part by air, on a round- or circle-trip basis for holiday purposes. The holiday charter mass values apply provided that not more than 5 % of passenger seats installed in the ~~aeroplane~~ aircraft are used for the non revenue carriage of certain categories of passengers. Categories of passengers such as company personnel, tour operators' staff, representatives of the press, authority officials etc. can be included within the 5% without negating the use of holiday charter mass values.

Comment [DDE27]: The footnote incorporates this text and IEM OPS 1.620(d)(2)

Table 2: Standard masses for passengers – aircraft with a total number of passenger seats of 19 or less

Passenger seats	1 - 5	6 - 9	10 - 19
Male	104 kg	96 kg	92 kg
Female	86 kg	78 kg	74 kg
Children	35 kg	35 kg	35 kg

~~(2)~~ On **aeroplane flights with 19 passenger seats or less and all helicopter flights** where no hand baggage is carried in the cabin or where hand baggage is accounted for separately, 6 kg may be deducted from ~~the above~~ male and female masses **in Table 2**. Articles such as an overcoat, an umbrella, a small handbag or purse, reading material or a small camera are not considered as hand baggage ~~for the purpose of this subparagraph~~.

For helicopter operations in which a survival suit is provided to passengers, 3 kg should be added to the passenger mass value.

~~(d) Mass values for passengers – 20 seats or more~~

~~(e) Mass values for passengers – 19 seats or less.~~

Subpart J | Revised rule text

~~(1) Where the total number of passenger seats available on an aeroplane is 19 or less, the standard masses in Table 2 are applicable.~~

~~(f)4.~~ Mass values for baggage.

~~(1)a.~~ **Aeroplanes.** Where the total number of passenger seats available on the aeroplane is 20 or more, the standard mass values given in Table 3 are applicable for each piece of checked baggage **of Table 3 should be used.**

b. Helicopters. When the total number of passenger seats available on the helicopters is 20 or more, the standard mass value for checked baggage is 13 kg.

c. For aeroplanes ~~aircraft~~ with 19 passenger seats or less, the actual mass of checked baggage **should be**, determined by weighing, ~~must be used.~~

Table 3: Standard masses for baggage – aeroplanes with a total number of passenger seats of 20 or more

Type of flight	Baggage standard mass
Domestic	11 kg
Within the European region	13 kg
Intercontinental	15 kg
All other	13 kg

~~(2)d.~~ For the purpose of Table 3:

~~(i)i.~~ ~~Domestic~~ **domestic** flight means a flight with origin and destination within the borders of one State.;

~~(ii)ii.~~ ~~Flights~~ **flights** within the European region means flights, other than ~~d~~Domestic flights, whose origin and destination are within the area specified in paragraph (e) in Appendix 1 to OPS 1.620.;

~~(iii)iii.~~ Intercontinental flight **means flights beyond** ~~other than flights within the European region,~~ means a flight with origin and destination in different continents.

Appendix ~~1~~ to OPS ~~1.620~~ (f)

Definition of the area for flights within the European region. Flights within the European region are flights conducted within the following area: For the purposes of OPS 1.620 (f), flights within the European region, other than domestic flights, are flights conducted within the area bounded by rhumb lines between the following points:

- N7200 E04500
- N4000 E04500
- N3500 E03700
- N3000 E03700
- N3000 W00600

Subpart J | Revised rule text

- N2700 W00900
- N2700 W03000
- N6700 W03000
- N7200 W01000
- N7200 E04500

as depicted in Figure 1: ~~of European region~~

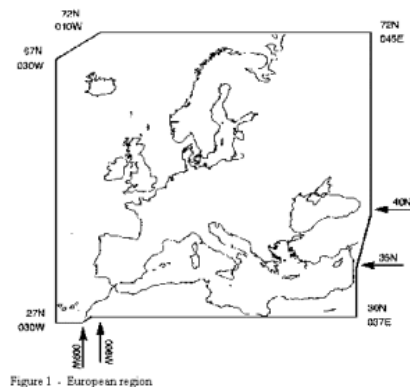

Figure 1: ~~of~~ European region

- (g) ~~5. If an operator wishes to use Other standard masses values other than those contained in Tables 1 to 3 above, he must advise the Authority of his reasons and gain its approval in advance. He must also submit for approval~~ **may be used provided they are calculated on the basis of** a detailed weighing survey plan and apply ~~a reliable~~ the statistical analysis method given in ~~is applied~~ Appendix 1 to OPS 1.620 (g). After verification and approval by the Authority of the results of the weighing survey, the revised standard mass values are only applicable to that operator. ~~The operator should advise the competent authority about the intent of the passenger weighing survey and explain the survey plan in general terms.~~ The revised standard mass values ~~can~~ **should** only be used in circumstances ~~consistent~~ **comparable** with those under which the survey was conducted. Where ~~the~~ revised standard masses exceed those in Tables 1, 2 and 3 of, then such higher values ~~must~~ **should** be used.
- (h) ~~6. On any flight identified as carrying a significant number of passengers whose masses, including hand baggage, are expected to exceed~~ **significantly deviate from** the standard passenger mass, ~~the operator must~~ **should** determine the actual mass of such passengers by weighing or by adding an adequate mass increment.
- (i) ~~7. If standard mass values for checked baggage are used and a significant number of passengers checked in baggage that is expected to exceed~~ **significantly deviate from** ~~to exceed~~ the standard baggage mass, ~~an~~ **the** operator ~~must~~ **should** determine the actual mass of such baggage by weighing or by adding an adequate mass increment.
- (j) ~~An operator shall ensure that a commander is advised when a non standard method has been used for determining the mass of the load and that this method is stated in the mass and balance documentation~~ Appendix 1 to OPS 1.620

Comment [GC128]: Move here from GM level. See corresponding comment.

Comment [DDE29]: Moved to AMC1- CAT.POL.MAB.105 (a) Mass and Balance Documentation

Subpart J | Revised rule text

PROCEDURE FOR ESTABLISHING REVISED STANDARD MASS VALUES FOR PASSENGERS AND BAGGAGE~~PROCEDURE FOR ESTABLISHING REVISED STANDARD MASS VALUES FOR PASSENGERS AND BAGGAGE~~~~(a)~~1. Passengers

~~(1)~~a. Weight sampling method. The average mass of passengers and their hand baggage ~~must~~**should** be determined by weighing, taking random samples. The selection of random samples ~~must~~**should** be by nature and extent be representative of the passenger volume, considering the type of operation, the frequency of flights on various routes, in/outbound flights, applicable season and seat capacity of the ~~aeroplane~~**aircraft**.

~~(2)~~b. Sample size. The survey plan ~~must~~**should** cover the weighing of at least the greatest of:

~~(i)~~i. A number of passengers calculated from a pilot sample, using normal statistical procedures and based on a relative confidence range (accuracy) of 1 % for all adult and 2 % for separate male and female average masses; and

~~(ii)~~ii. ~~For~~**for** aeroplanes**aircraft**:

~~(A)~~A. with a passenger seating capacity of 40 or more, a total of 2000 passengers; or

~~(B)~~B. with a passenger seating capacity of less than 40, a total number of 50 ~~×~~**multiplied by** the passenger seating capacity.

~~(3)~~c. Passenger masses. Passenger masses ~~must~~**should** include the mass of the passengers' belongings which are carried when entering the ~~aeroplane~~**aircraft**. When taking random samples of passenger masses, infants ~~shall~~**should** be weighted together with the accompanying adult ~~(See also OPS 1620 (c) (d) and (e)).~~

~~(4)~~d. Weighing location. The location for the weighing of passengers ~~shall~~**should** be selected as close as possible to the ~~aeroplane~~**aircraft**, at a point where a change in the passenger mass by disposing of or by acquiring more personal belongings is unlikely to occur before the passengers board the ~~aeroplane~~**aircraft**.

~~(5)~~e. Weighing machine. The weighing machine ~~to be~~ used for passenger weighing ~~shall~~**should** have a capacity of at least 150 kg. The mass ~~shall~~**should** be displayed at minimum graduations of 500 g. The weighing machine ~~must~~**should** be accurate ~~to within~~**have an accuracy of at least** 0,5 % or 200 g whichever is ~~the~~ greater.

~~(6)~~f. Recording of mass values. For each flight included in the survey the mass of the passengers, the corresponding passenger category (i.e. male/female/children) and the flight number ~~must~~**should** be recorded.

~~(b)~~2. Checked baggage. The statistical procedure for determining revised standard baggage mass values based on average baggage masses of the minimum required sample size ~~is basically the same as for passengers and as specified in~~**should comply with** 1.a and .b. For baggage, the relative confidence range (accuracy) **should** amounts to 1 %. A minimum of 2000 pieces of checked baggage ~~must~~**should** be weighed.

~~(c)~~3. Determination of revised standard mass values for passengers and checked baggage.

Subpart J | Revised rule text

- (1)a. To ensure that, in preference to the use of actual masses determined by weighing, the use of revised standard mass values for passengers and checked baggage does not adversely affect operational safety, a statistical analysis **must** be carried out. Such an analysis ~~will~~ **should** generate average mass values for passengers and baggage as well as other data.
- (2)b. On ~~aeroplanes~~ **aircraft** with 20 or more passenger seats, these averages apply as revised standard male and female mass values.
- (3)c. On ~~smaller aeroplanes~~ **aircraft with 19 passenger seats or less**, the following increments in **Table 4** ~~must~~ **should** be added to the average passenger mass to obtain the revised standard mass values:

Table 4: Increments for revised standard masses values

Number of passenger seats	Required mass increment
1 – 5 incl.	16 kg
6 – 9 incl.	8 kg
10 – 19 incl.	4 kg

Alternatively, all adult revised standard (average) mass values may be applied on ~~aeroplanes~~ **aircraft** with 30 or more passenger seats. Revised standard (average) checked baggage mass values are applicable to ~~aeroplanes~~ **aircraft** with 20 or more passenger seats.

- (4)d. ~~Operators have the option to submit a detailed survey plan to the Authority for approval and subsequently a deviation from the revised standard mass value provided this deviating value is determined by use of the procedure explained in this Appendix. Such deviations~~ **The revised standard masses must** be reviewed at intervals not exceeding 5 years.
- (5)e. All adult revised standard mass values ~~must~~ **should** be based on a male/female ratio of 80/20 in respect of all flights except holiday charters which are 50/50. ~~If an operator wishes to obtain approval for use of a~~ **A different ratio on specific routes or flights may be used, provided supporting** ~~then data must be submitted to the Authority showing that the alternative male/female ratio is conservative and covers at least 84 % of the actual male/female ratios on a sample of at least 100 representative flights.~~
- (6)f. The **resulting** average mass values ~~found~~ **are** ~~should~~ **be** rounded to the nearest whole number in kg. Checked baggage mass values ~~are~~ **should** be rounded to the nearest 0,5 kg figure, as appropriate.
- g. When operating on similar routes or networks, operators may pool their weighing surveys provided that in addition to the joint weighing survey results, results from individual operators participating in the joint survey are separately indicated in order to validate the joint survey results.**

Comment [DDE30]: For alternative standard masses EU-OPS foresees an approval. In this AMC the reference to approval is deleted being replaced by the alternative means of compliance procedure.

Comment [DDE31]: AMC to Appendix 1 to JAR-OPS 1.620(g) & IEM to Appendix 1 to JAR-OPS 3.620(h) sub-paragraph (c)(4), in the original also subject to approval. See comment above.

Subpart J | Revised rule text

GM1-CAT.POL.MAB.100-(d) Mass and balance, loading

ADJUSTMENT OF STANDARD MASSES

When standard mass values are used, paragraph 6 of AMC1 CAT.POL.MAB.100 (d) - MASS VALUES FOR PASSENGERS AND BAGGAGE, states that the operator should identify and adjust the passenger and checked baggage masses in cases where significant numbers of passengers or quantities of baggage are suspected of ~~exceeding~~ **significantly deviating from** the standard values. ~~Therefore it is implied that~~ the operations manual should contain ~~appropriatedirectives~~ **instructions** to ensure that:

Comment [cg32]: Originally IEM OPS 1.620(h) & (i) and IEM OPS 3.620(i) & (j)

1. Check-in, operations and cabin staff and loading personnel report or take appropriate action when a flight is identified as carrying a significant number of passengers whose masses, including hand baggage, are expected **to significantly deviate from** ~~to exceed~~ the standard passenger mass, and/or groups of passengers carrying exceptionally heavy baggage (e.g. military personnel or sports teams); and
2. On small aircraft, where the risks of overload and/or CG errors are the greatest, pilots pay special attention to the load and its distribution and make proper adjustments.

GM2-CAT.POL.MAB.100-(d) Mass and Balance, Loading

STATISTICAL EVALUATION OF PASSENGERS AND BAGGAGE DATA

1. Sample size.
 - a. For calculating the required sample size it is necessary to make an estimate of the standard deviation on the basis of standard deviations calculated for similar populations or for preliminary surveys. The precision of a sample estimate is calculated for 95% reliability or 'significance', i.e. there is a 95% probability that the true value falls within the specified confidence interval around the estimated value. This standard deviation value is also used for calculating the standard passenger mass.
 - b. As a consequence, for the parameters of mass distribution, i.e. mean and standard deviation, three cases have to be distinguished:
 - i. $\mu, \sigma =$ the true values of the average passenger mass and standard deviation, which are unknown and which are to be estimated by weighing passenger samples.
 - ii. $\mu', \sigma' =$ the 'a priori' estimates of the average passenger mass and the standard deviation, i.e. values resulting from an earlier survey, which are needed to determine the current sample size.
 - iii. $\bar{x}, s =$ the estimates for the current true values of m and s , calculated from the sample.

Comment [DDE33]: Originally IEM OPS 1.620(g) & IEM OPS 3.620(h)

The sample size can then be calculated using the following formula:

$$n \geq \frac{(1.96 * \sigma' * 100)^2}{(e'_r * \mu')^2}$$

where:

n = number of passengers to be weighed (sample size)

e'_r = allowed relative confidence range (accuracy) for the estimate of μ by x (see also equation in paragraph 3). The allowed relative

Subpart J | Revised rule text

confidence range specifies the accuracy to be achieved when estimating the true mean. For example, if it is proposed to estimate the true mean to within $\pm 1\%$, then e_r will be 1 in the above formula.

1.96 = value from the Gaussian distribution for 95% significance level of the resulting confidence interval.

2. Calculation of average mass and standard deviation. If the sample of passengers weighed is drawn at random, then the arithmetic mean of the sample (\bar{x}) is an unbiased estimate of the true average mass (μ) of the population.

a. Arithmetic mean of sample where:

$$\bar{x} = \frac{\sum_{j=1}^n x_j}{n}$$

x_j = mass values of individual passengers (sampling units).

b. Standard deviation where:

$$s = \sqrt{\frac{\sum_{j=1}^n (x_j - \bar{x})^2}{n - 1}}$$

$x_j - \bar{x}$ = deviation of the individual value from the sample mean.

3. Checking the accuracy of the sample mean. The accuracy (confidence range) which can be ascribed to the sample mean as an indicator of the true mean is a function of the standard deviation of the sample which has to be checked after the sample has been evaluated. This is done using the formula:

$$e_r = \frac{1.96 * s * 100}{\sqrt{n} * \bar{x}} (\%)$$

whereby e_r should not exceed 1% for an all adult average mass and ~~not exceed~~ 2% for an average male and/or female mass. The result of this calculation gives the relative accuracy of the estimate of μ at the 95% significance level. This means that with 95% probability, the true average mass μ lies within the interval:

$$\bar{x} \pm \frac{1.96 * s}{\sqrt{n}}$$

4. Example of determination of the required sample size and average passenger mass.
- a. Introduction. Standard passenger mass values for mass and balance purposes require passenger weighing programs be carried out. The following example shows the various steps required for establishing the sample size and evaluating the sample data. It is provided primarily for those who are not well versed in statistical computations. All mass figures used throughout the example are entirely fictitious.
- b. Determination of required sample size. For calculating the required sample size, estimates of the standard (average) passenger mass and the standard deviation are needed. The 'a priori' estimates from an earlier survey may be used for this purpose. If such estimates are not available, a small representative sample of about 100 passengers ~~has to~~ **should** be weighed so

Subpart J | Revised rule text

that the required values can be calculated. The latter has been assumed for the example.

Step 1: estimated average passenger mass.

n	x _j (kg)
1	79.9
2	68.1
3	77.9
4	74.5
5	54.1
6	X 62.2
7	89.3
8	108.7
.	.
85	63.2
86	75.4
<hr/>	
$\sum_{j=1}^{86}$	6 071.6

$$\mu' = \bar{x} = \frac{\sum x_j}{n} = \frac{6071.6}{86} = 70.6 \text{ kg}$$

Step 2: estimated standard deviation.

n	x _j	(x _j - \bar{x})	(x _j - \bar{x}) ²
1	79.9	+9.3	86.49
2	68.1	-2.5	6.25
3	77.9	+7.3	53.29
4	74.5	+3.9	15.21
5	54.1	-16.5	272.25
6	62.2	-8.4	70.56
7	89.3	+18.7	349.69
8	108.7	+38.1	1 451.61
.	.	.	.
85	63.2	-7.4	54.76
86	75.4	-4.8	23.04
<hr/>			

Subpart J | Revised rule text

$$\sum_{j=1}^{86} \quad 6071.6 \quad 34\,683.40$$

$$\sigma' = \sqrt{\frac{\sum (x_j - \bar{x})^2}{n-1}}$$

$$\sigma' = \sqrt{\frac{34\,683.40}{86-1}}$$

$$\sigma' = 20.20 \text{ kg}$$

Step 3: required sample size.

The required number of passengers to be weighed should be such that the confidence range, e'_r , does not exceed 1% as specified in paragraph 3.

$$n \geq \frac{(1.96 * \sigma' * 100)^2}{(e'_r * \mu')^2}$$

$$n \geq \frac{(1.96 * 20.20 * 100)^2}{(1 * 70.6)^2}$$

$$n \geq 3145$$

The result shows that at least 3 145 passengers ~~have to~~**should** be weighed to achieve the required accuracy. If e'_r is chosen as 2 % the result would be $n \geq 786$.

Step 4: after having established the required sample size a plan for weighing the passengers is to be worked out.

c. Determination of the passenger average mass.

Step 1: Having collected the required number of passenger mass values, the average passenger mass can be calculated. For the purpose of this example it has been assumed that 3 180 passengers were weighed. The sum of the individual masses amounts to 231 186.2 kg.

$$n = 3180$$

$$\sum_{j=1}^{3180} X_j = 231186.2 \text{ kg}$$

Subpart J | Revised rule text

$$\bar{x} = \frac{\sum x_j}{n} = \frac{231186.2}{3180} \text{ kg}$$

$$\bar{x} = 72.7 \text{ kg}$$

Step 2: calculation of the standard deviation.

For calculating the standard deviation the method shown in paragraph 4.2 step 2 should be applied.

$$\sum (x_j - \bar{x})^2 = 745\,145.20$$

$$s = \sqrt{\frac{\sum (x_j - \bar{x})^2}{n - 1}}$$

$$s = \sqrt{\frac{745\,145.20}{3180 - 1}}$$

$$s = 15.31 \text{ kg}$$

Step 3: calculation of the accuracy of the sample mean.

$$e_r = \frac{1.96 * s * 100}{\sqrt{n} * \bar{x}} \%$$

$$e_r = \frac{1.96 * 15.31 * 100}{\sqrt{3180} * 72.7} \%$$

$$e_r = 0.73 \%$$

Step 4: calculation of the confidence range of the sample mean.

$$\bar{x} \pm \frac{1.96 * s}{\sqrt{n}}$$

$$\bar{x} \pm \frac{1.96 * 15.31}{\sqrt{3180}} \text{ kg}$$

Subpart J | Revised rule text

72.7 ± 0.5 kg

The result of this calculation shows that there is a 95% probability of the actual mean for all passengers lying within the range 72.2 kg to 73.2 kg.

GM3-CAT.POL.MAB.100(d) mass and balance, loading

GUIDANCE ON PASSENGER WEIGHING SURVEYS

~~1. Information to the competent authority. An operator should advise the competent authority about the intent of the passenger weighing survey and explain the survey plan in general terms.~~

Comment [cg34]: Originally IEM to Appendix 1 to JAR-OPS 1.620(g) & IEM to Appendix 1 to JAR-OPS 3.620(h) sub-paragraph (c)(4)

21. Detailed survey plan.

Comment [GC135]: Moved to the corresponding AMC.

- a. ~~An~~ **The** operator should establish and submit to the competent authority a detailed weighing survey plan that is fully representative of the operation, i.e. the network or route under consideration and the survey should involve the weighing of an adequate number of passengers.
- b. A representative survey plan means a weighing plan specified in terms of weighing locations, dates and flight numbers giving a reasonable reflection of the operator's timetable and/or area of operation.
- c. The minimum number of passengers to be weighed is the highest of the following:
 - i. The number that follows from the means of compliance that the sample should be representative of the total operation to which the results will be applied; this will often prove to be the overriding requirement; or
 - ii. The number that follows from the statistical requirement specifying the accuracy of the resulting mean values which should be at least 2% for male and female standard masses and 1% for all adult standard masses, where applicable. The required sample size can be estimated on the basis of a pilot sample (at least 100 passengers) or from a previous survey. If analysis of the results of the survey indicates that the requirements on the accuracy of the mean values for male or female standard masses or all adult standard masses, as applicable, are not met, an additional number of representative passengers should be weighed in order to satisfy the statistical requirements.
- d. To avoid unrealistically small samples a minimum sample size of 2 000 passengers (males + females) is also required, except for small aircraft where in view of the burden of the large number of flights to be weighed to cover 2 000 passengers, a lesser number is considered acceptable.

32. Execution of weighing programme.

- a. At the beginning of the weighing programme it is important to note, and to account for, the data requirements of the weighing survey report (see 6. below).
- b. As far as is practicable, the weighing programme should be conducted in accordance with the specified survey plan.
- c. Passengers and all their personal belongings should be weighed as close as possible to the boarding point and the mass, as well as the associated passenger category (male/female/child), should be recorded.

*Subpart J | Revised rule text***43.** Analysis of results of weighing survey.

~~4.1~~—The data of the weighing survey should be analysed as explained in this GM. To obtain an insight to variations per flight, per route etc. this analysis should be carried out in several stages, i.e. by flight, by route, by area, inbound/outbound, etc. Significant deviations from the weighing survey plan should be explained as well as their possible effect(s) on the results.

54. Results of the weighing survey.

- a. The results of the weighing survey should be summarised. Conclusions and any proposed deviations from published standard mass values should be justified. The results of a passenger weighing survey are average masses for passengers, including hand baggage, which may lead to proposals to adjust the standard mass values given in AMC1CAT.POL.MAB.100 (d) Tables 1 and 2. These averages, rounded to the nearest whole number may, in principle, be applied as standard mass values for males and females on aircraft with 20 and more passenger seats. Because of variations in actual passenger masses, the total passenger load also varies and statistical analysis indicates that the risk of a significant overload becomes unacceptable for aircraft with less than 20 seats. This is the reason for passenger mass increments on small aircraft.
- b. The average masses of males and females differ by some 15 kg or more and because of uncertainties in the male/female ratio the variation of the total passenger load is greater if all adult standard masses are used than when using separate male and female standard masses. Statistical analysis indicates that the use of all adult standard mass values should be limited to aircrafts with 30 passenger seats or more.
- c. Standard mass values for all adults must be based on the averages for males and females found in the sample, taking into account a reference male/female ratio of 80/20 for all flights except holiday charters where a ratio of 50/50 applies. The operator may, based on the data from his weighing programme, or by proving a different male/female ratio, apply for approval of a different ratio on specific routes or flights.

65. Weighing survey report:

The weighing survey report, reflecting the content of paragraphs 1–4 above, should be prepared in a standard format as follows:

WEIGHING SURVEY REPORT

1 Introduction

Objective and brief description of the weighing survey.

2 Weighing survey plan

Discussion of the selected flight number, airports, dates, etc.

Determination of the minimum number of passengers to be weighed.

Survey plan.

3 Analysis and discussion of weighing survey results

Significant deviations from survey plan (if any).

Subpart J | Revised rule text

Variations in means and standard deviations in the network.

Discussion of the (summary of) results.

4 Summary of results and conclusions

Main results and conclusions.

Proposed deviations from published standard mass values.

Attachment 1

Applicable summer and/or winter timetables or flight programmes.

Attachment 2

Weighing results per flight (showing individual passenger masses and sex); means and standard deviations per flight, per route, per area and for the total network.

GM1-CAT.POL.MAB.100(g) Mass and balance, loading

Comment [cg36]: Originally IEM OPS 1.605(e) & IEM OPS 3.605(e)+ NPA OPS 39C on fuel codes.

FUEL DENSITY

1. If the actual fuel density is not known, the operator may use standard fuel density values for determining the mass of the fuel load. Such standard values should be based on current fuel density measurements for the airports or areas concerned.
2. Typical fuel density values are:

a. Gasoline (piston engine fuel)	-	0.71
b. JET A1 (Jet fuel JP 1)	-	0.79
c. JET B (Jet fuel JP 4)	-	0.76
d. Oil	-	0.88

GM1-CAT.POL.MAB.100.H(i) Mass and balance, loading

Comment [DDE37]: GM added to accommodate for text in brackets of Appendix 1 to 3.605(c)(4)

IN-FLIGHT CHANGES IN LOADING - HELICOPTERS

In-flight changes in loading may occur in hoist operations.

Appendix 1 to OPS 1.625 AMC1-CAT.POL.MAB.105(a) Mass and balance data and documentation

CONTENTS AND SYSTEM

1.(a) Mass and balance documentation

(1)a. Contents:

- (i) ~~The mass and balance documentation must contain the following information:~~
 - ~~(A.) The aeroplane registration and type;~~
 - ~~(B.) The flight identification number and date;~~

Subpart J | Revised rule text

- ~~(C.) The identity of the Commander;~~
- ~~(D.) The identity of the person who prepared the document;~~
- ~~(E.) The dry operating mass and the corresponding CG of the aeroplane;~~
- ~~(F.) The mass of the fuel at take-off and the mass of trip fuel;~~
- ~~(G.) The mass of consumables other than fuel;~~
- ~~(H.) The components of the load including passengers, baggage, freight and ballast;~~
- ~~(I.) The Take-off Mass, Landing Mass and Zero Fuel Mass;~~
- ~~(J.) The load distribution;~~
- ~~(K.) The applicable aeroplane CG positions; and~~
- ~~(L.) The limiting mass and CG values.~~

~~(ii) Subject to the approval of the Authority, an operator may omit some of this Data data from the mass and balance documentation.~~

2. ~~(j) An operator shall ensure that a~~**The mass and balance documentation should include advice to the commander is advised whenever** a non-standard method has been used for determining the mass of the load ~~and that this method is stated in the mass and balance documentation.~~

Comment [DDE38]: This is included in paragraph 3. Regarding the approval see similar comments above.

3. ~~The operator should verify the integrity of Computerised systems. Where mass and balance documentation is generated by a computerised mass and balance system, the operator must verify the integrity of the output mass and balance data and documentation generated by a computerised mass and balance system, at intervals not exceeding 6 months. The operator should establish a system to check that amendments of his-its input data are incorporated properly in the system and that the system is operating correctly on a continuous basis.~~

Comment [cg39]: Core of the rule to IR. Specifications kept in AMC

4. ~~Data link-Whenever the mass and balance documentation is sent to the aeroplanes aircraft via data link, a copy of the final mass and balance documentation as accepted by the commander must~~**should** be available on the ground.

5. ~~(e)The person supervising the loading of the aircraft should confirm by hand signature or equivalent that the load and its distribution are in accordance with the mass and balance documentation given to the commander. The commander should indicate his/her acceptance by hand signature or equivalent.~~

Comment [DDE40]: Downgraded from IR and slightly amended

GM1-CAT.POL.MAB.105(c) Mass and balance data and documentation

Comment [GCI41]: New GM to clarify new paragraphs in IR.

ON BOARD INTEGRATED MASS AND BALANCE COMPUTER SYSTEM.

An on board integrated mass and balance computer system may be an aircraft installed system capable of receiving input data either from other aircraft systems or from a mass and balance system on ground, in order to generate mass and balance data as an output.

STAND-ALONE COMPUTERISED MASS AND BALANCE SYSTEM

A stand-alone computerised mass and balance system may be a computer, either as a part of an electronic flight bag (EFB) system or solely dedicated to mass and balance purposes, requiring input from the user, in order to generate mass and balance data as an output.

EU-OPS Subpart F-I | Revised rule text

Scope

This document shows the transposition of EU-OPS Subpart F-I into the new European OPS rules.

It also contains the related Section 2 material of JAR-OPS 1.

Track changes show changes to the EU-OPS text.

Table of Contents

Part-CAT	10
Subpart D – Instrument, data, equipment	10
Section 1 – Aeroplanes	10
CAT.IDE.A.100 Instruments and equipment – general	10
CAT.IDE.A.105 Minimum equipment for flight	11
CAT.IDE.110.A Spare electrical fuses.....	11
CAT.IDE.115.A Operating lights	12
CAT.IDE.A.120 Equipment to clear windshield	12
CAT.IDE.A.125 Day VFR operations – flight and navigational instruments and associated equipment	12
CAT.IDE.A.130 IFR or night operations – flight and navigational instruments and associated equipment	14
CAT.IDE.A.135 Additional equipment for single pilot operation under IFR	17
CAT.IDE.A.140 Altitude alerting system	17
CAT.IDE.A.150 Terrain awareness warning System (TAWS)	17
CAT.IDE.A.155 Airborne Collision Avoidance System (ACAS)	18
TURBINE-POWERED AEROPLANES WITH A MAXIMUM CERTIFIED TAKE-OFF MASS OF MORE THAN 5 700 KG OR A MAXIMUM PASSENGER SEATING CONFIGURATION OF MORE THAN 19 SHALL BE EQUIPPED WITH ACAS II. 18	
CAT.IDE.A.160 AIRBORNE WEATHER DETECTING EQUIPMENT	18
CAT.IDE.A.165 Additional equipment for operations in icing conditions at night	18
CAT.IDE.A.170 Flight crew interphone system	19
CAT.IDE.A.175 Crew member interphone system.....	19
CAT.IDE.A.180 Public address system	20
CAT.IDE.A.185 Cockpit voice recorder	20
CAT.IDE.A.190 Flight data recorders	23
CAT.IDE.A.195 Data link recording.....	27
CAT.IDE.A.200 Combination Recorder	27
CAT.IDE.A.205 Seats, seat safety belts, harnesses and child restraint devices.....	28
CAT.IDE.A.210 Fasten seat belt and no smoking signs.....	29
CAT.IDE.A.215 Internal doors and curtains	29
CAT.IDE.A.220 First-aid kit	29

EU-OPS Subpart F-I | Revised rule text

CAT.IDE.A.225 Emergency medical kit.....	30
CAT.IDE.A.230 First-aid oxygen.....	30
CAT.IDE.A.235 Supplemental oxygen – pressurised aeroplanes	31
CAT.IDE.A.240 Supplemental oxygen – non-pressurised aeroplanes.....	34
CAT.IDE.A.245 Crew protective breathing equipment	35
CAT.IDE.A.250 Hand fire extinguishers	36
CAT.IDE.A.255 Crash axe and crowbar	37
CAT.IDE.A.260 Marking of break-in points.....	37
CAT.IDE.A.265 Means for emergency evacuation	38
CAT.IDE.A.270 Megaphones	39
CAT.IDE.A.275 Emergency lighting and marking	39
CAT.IDE.A.280 Emergency locator transmitter (ELT)	40
CAT.IDE.A.285 Flight over water.....	41
CAT.IDE.A.305 Survival equipment	42
CAT.IDE.A.325 Headset	50
CAT.IDE.A.330 Radio equipment.....	50
CAT.IDE.A.335 Audio selector panel	50
CAT.IDE.A.340 Radio equipment for operations under VFR over routes navigated by reference to visual landmarks.....	51
CAT.IDE.A.345 Communication and navigation equipment for operations under IFR, or under VFR over routes not navigated by reference to visual landmarks.....	51
CAT.IDE.A.350 Transponder	52
CAT.IDE.A.355 Electronic navigation data management.....	53
Subpart D – Instrument, data, equipment	55
Section 1 – Aeroplanes	55
GM1-CAT.IDE.A.100(a) Instruments and equipment – General	55
APPROVED EQUIPMENT	55
GM1-CAT.IDE.A.100(c) Instruments and equipment – General	55
INSTRUMENTS AND EQUIPMENT THAT DO NOT NEED TO BE APPROVED IN ACCORDANCE WITH REGULATION (EC) NO 1702/2003, BUT ARE CARRIED ON A FLIGHT	55
GM1-CAT.IDE.A.100(d) Instruments and equipment - General	55
POSITIONING OF INSTRUMENTS	55
GM1-CAT.IDE.A.110 Spare electrical fuses	56
FUSES.....	56
AMC1-CAT.IDE.A.120 Equipment to clear windshield	56

EU-OPS Subpart F-I | Revised rule text

MEANS TO MAINTAIN A CLEAR PORTION OF THE WINDSHIELD DURING PRECIPITATION	56
AMC1-CAT.IDE.A.125&CAT.IDE.A.130 Day VFR operations and IFR or night operations – Flight and navigational instruments and associated equipment	56
INTEGRATED INSTRUMENTS	56
AMC2-CAT.IDE.A.125 Day VFR operations – Flight and navigational instruments and associated equipment	56
LOCAL FLIGHTS.....	56
AMC1-CAT.IDE.A.125(a)(1)&CAT.IDE.A.130(a)(1) Day VFR operations and IFR or night operations – Flight and navigational instruments and associated equipment	57
MEANS OF MEASURING AND DISPLAYING MAGNETIC DIRECTION	57
AMC1-CAT.IDE.A.125(a)(2)&CAT.IDE.A.130(a)(2) Day VFR operations and IFR or night operations – Flight and navigational instruments and associated equipment	57
MEANS OF MEASURING AND DISPLAYING THE TIME	57
AMC1 CAT.IDE.A.125 (a)(3)&CAT.IDE.A.130(b) Day VFR operations and IFR or night operations – Flight and navigational instruments and associated equipment	57
CALIBRATION OF THE MEANS FOR MEASURING AND DISPLAYING PRESSURE ALTITUDE	57
AMC1-CAT.IDE.A.125(a)(4)&CAT.IDE.A.130(a)(3) Day VFR operations and IFR or night operations – Flight and navigational instruments and associated equipment	57
CALIBRATION OF THE INSTRUMENT INDICATING AIRSPEED.....	57
AMC1-CAT.IDE.A.130(a)(5) IFR or night operations – Flight and navigational instruments and associated equipment	57
SLIP INDICATOR	57
AMC2-CAT.IDE.A.130(b) IFR or night operations – Flight and navigational instruments and associated equipment	58
ALTIMETERS – IFR OR NIGHT OPERATIONS	58
AMC1-CAT.IDE.A.125(b)(1)&CAT.IDE.A.130 (c)(1) Day VFR operations and IFR or night operations – Flight and navigational instruments and associated equipment	58
MEANS OF DISPLAYING OUTSIDE AIR TEMPERATURE	58
AMC1-CAT.IDE.A.125(c)&CAT.IDE.A.130(h) Day VFR operations and IFR or night operations – Flight and navigational instruments and associated equipment	58
MULTI-PILOT OPERATIONS - DUPLICATE INSTRUMENTS	58

EU-OPS Subpart F-I | Revised rule text

AMC1-CAT.IDE.A.125(d)&CAT.IDE.A.130(d) Day VFR operations and IFR or night operations – Flight and navigational instruments and associated equipment	58
MEANS OF PREVENTING MALFUNCTION DUE TO CONDENSATION OR ICING	58
AMC1-CAT.IDE.A.130(e) IFR or night operations – Flight and navigational instruments and associated equipment	58
MEANS OF INDICATING FAILURE OF THE AIRSPEED INDICATING SYSTEM'S MEANS OF PREVENTING MALFUNCTION DUE TO EITHER CONDENSATION OR ICING	58
AMC1-CAT.IDE.A.130(i) IFR or night operations – Flight and navigational instruments and associated equipment	59
STANDBY ATTITUDE	59
AMC1-CAT.IDE.A.130(j) IFR or night operations – Flight and navigational instruments and associated equipment	59
CHART HOLDER.....	59
GM1-CAT.IDE.A.125 &CAT.IDE.A.130 Day VFR operations and IFR or night operations – Flight and navigational instruments and associated equipment	59
GENERAL.....	59
AMC1-CAT.IDE.A.150 Terrain awareness warning system (TAWS).....	61
EXCESSIVE DOWNWARDS GLIDE SLOPE DEVIATION WARNING FOR CLASS A TAWS.....	61
AMC1-CAT.IDE.A.160 Airborne weather detecting equipment	62
GENERAL.....	62
AMC1-CAT.IDE.A.170 Flight crew interphone system	62
TYPE OF FLIGHT CREW INTERPHONE	62
AMC1-CAT.IDE.A.175 Crew member interphone system.....	62
SPECIFICATIONS.....	62
AMC1.CAT.IDE.A.180 Public address system	63
SPECIFICATIONS.....	63
AMC1-CAT.IDE.A.185 Cockpit voice recorder	63
GENERAL.....	63
AMC1-CAT.IDE.A.190 Flight data recorder.....	63
LIST OF PARAMETERS TO BE RECORDED FOR AEROPLANES FIRST ISSUED WITH AN INDIVIDUAL C OF A ON OR AFTER 1 JANUARY 2016.....	63
AMC2-CAT.IDE.A.190 Flight data recorder.....	70

EU-OPS Subpart F-I | Revised rule text

LIST OF PARAMETERS TO BE RECORDED FOR AEROPLANES FIRST ISSUED WITH AN INDIVIDUAL C OF A ON OR AFTER 1 APRIL 1998 AND BEFORE 1 JANUARY 2016	70
AMC3-CAT.IDE.A.190 Flight data recorder.....	74
PERFORMANCE SPECIFICATIONS FOR THE PARAMETERS TO BE RECORDED FOR AEROPLANES FIRST ISSUED WITH AN INDIVIDUAL C OF A ON OR AFTER 1 APRIL 1998 AND BEFORE 1 JANUARY 2016	74
AMC4-CAT.IDE.A.190 Flight data recorder.....	86
LIST OF PARAMETERS TO BE RECORDED FOR AEROPLANES FIRST ISSUED WITH AN INDIVIDUAL C OF A ON OR AFTER 1 JUNE 1990 UP TO AND INCLUDING 31 MARCH 1998.....	86
AMC5-CAT.IDE.A.190 Flight data recorder.....	89
PERFORMANCE SPECIFICATIONS FOR THE PARAMETERS TO BE RECORDED FOR AEROPLANES FIRST ISSUED WITH AN INDIVIDUAL C OF A ON OR AFTER 1 JUNE 1990 UP TO AND INCLUDING 31 MARCH 1998	89
AMC6-CAT.IDE.A.190 Flight data recorder.....	94
LIST OF PARAMETERS TO BE RECORDED FOR AEROPLANES FIRST ISSUED WITH AN INDIVIDUAL C OF A BEFORE 1 JUNE 1990	94
AMC1-CAT.IDE.A.195 Data link recording.....	96
GENERAL.....	96
GM1-CAT.IDE.A.195 Data link recording	98
GENERAL.....	98
AMC1-CAT.IDE.A.200 Combination recorder	100
GENERAL.....	100
AMC1-CAT.IDE.A.205 Seats, seat safety belts, harnesses and child restraint devices	101
CHILD RESTRAINT DEVICES (CRD).....	101
AMC2-CAT.IDE.A.205 Seats, seat safety belts, harnesses and child restraint devices	103
SAFETY HARNESS.....	103
AMC3-CAT.IDE.A.205 Seats, seat safety belts, harnesses and child restraint devices	103
CABIN CREW SEATS	103
AMC1-CAT.IDE.A.215 Internal doors and curtains	103
PLACARDS' INDICATION.....	103
AMC1-CAT.IDE.A.220 First-aid kit	104
CONTENT OF FIRST_AID KIT.....	104
AMC2-CAT.IDE.A.220 First-aid kit	105
MAINTENANCE OF FIRST AID KITS	105

EU-OPS Subpart F-I | Revised rule text

AMC1-CAT.IDE.A.225 Emergency medical kit	105
CONTENT OF EMERGENCY MEDICAL KIT.....	105
AMC2-CAT.IDE.A.225 Emergency medical kit	107
CARRYING UNDER SECURITY CONDITIONS	107
AMC3-CAT.IDE.A.225 Emergency medical kit	107
ACCESS TO EMERGENCY MEDICAL KIT.....	107
AMC4-CAT.IDE.A.225 Emergency medical kit	107
MAINTENANCE OF EMERGENCY MEDICAL KIT	107
GM1-CAT.IDE.A.230 First aid oxygen.....	107
GENERAL.....	107
AMC1-CAT.IDE.A.235 Supplemental oxygen – pressurised aeroplanes .	108
GENERAL.....	108
AMC2-CAT.IDE.A.235 Supplemental oxygen – pressurised aeroplanes .	108
OXYGEN REQUIREMENTS FOR FLIGHT CREW COMPARTMENT SEAT OCCUPANTS AND CABIN CREW CARRIED IN ADDITION TO THE REQUIRED MINIMUM NUMBER OF CABIN CREW	108
AMC1-CAT.IDE.A.235(e) Supplemental oxygen – pressurised aeroplanes	109
AEROPLANES NOT CERTIFICATED TO FLY ABOVE 25 000 FT	109
GM1-CAT.IDE.A.235 Supplemental oxygen – pressurised aeroplanes...	109
QUICK DONNING MASKS	109
AMC1-CAT.IDE.A.240 –SUPPLEMENTAL Oxygen NON-pressurised aeroplanes	110
AMOUNT OF SUPPLEMENTAL OXYGEN	110
AMC1-CAT.IDE.A.245 Crew protective breathing equipment	110
PROTECTIVE BREATHING EQUIPMENT (PBE)	110
AMC1-CAT.IDE.A.250 Hand fire extinguishers.....	110
NUMBER, LOCATION AND TYPE	110
AMC1-CAT.IDE.A.255 Crash axes and crowbars	111
STORAGE OF CRASH AXES AND CROWBARS	111
AMC1-CAT.IDE.A.260 Marking of break-in points	111
COLOUR AND CORNERS’ MARKING	111
AMC1-CAT.IDE.A.270 Megaphones.....	111
LOCATION OF MEGAPHONES.....	111
AMC1-CAT.IDE.A.280 Emergency locator transmitter (ELT)	111
ELT BATTERIES	111

EU-OPS Subpart F-I | Revised rule text

AMC2-CAT.IDE.A.280 Emergency locator transmitter (ELT)	111
TYPES OF ELT AND GENERAL TECHNICAL SPECIFICATIONS	111
GM1-CAT.IDE.A.280 Emergency locator transmitter (ELT)	112
TERMINOLOGY	112
AMC1-CAT.IDE.A.285 Flight over water	112
LIFE –RAFTS AND EQUIPMENT FOR MAKING DISTRESS SIGNALS	112
GM1-CAT.IDE.A.285 Flight over water	113
SEAT CUSHIONS	113
AMC1-CAT.IDE.A.305 Survival equipment	113
ADDITIONAL SURVIVAL EQUIPMENT	113
GM1-CAT.IDE.A.305 Survival equipment.....	113
SIGNALLING EQUIPMENT	113
GM2-CAT.IDE.A.305 Survival equipment.....	114
AREAS IN WHICH SEARCH AND RESCUE WOULD BE ESPECIALLY DIFFICULT	114
AMC1-CAT.IDE.A.325 Headset.....	114
GENERAL.....	114
GM1-CAT.IDE.A.325 Headset	114
GENERAL.....	114
AMC1-CAT.IDE.A.345 Communication and navigation equipment for operations under IFR, or under VFR over routes not navigated by reference to visual landmarks.....	114
TWO INDEPENDENT MEANS OF COMMUNICATION	114
AMC2-CAT.IDE.A.345 Communication and navigation equipment for operations under IFR, or under VFR over routes not navigated by reference to visual landmarks.....	115
ACCEPTABLE NUMBER AND TYPE OF COMMUNICATION AND NAVIGATION EQUIPMENT	115
AMC3-CAT.IDE.A.345 Communication and navigation equipment for operations under IFR, or under VFR over routes not navigated by reference to visual landmarks.....	116
FAILURE OF A SINGLE UNIT.....	116
AMC4-CAT.IDE.A.345 Communication and navigation equipment for operations under IFR, or under VFR over routes not navigated by reference to visual landmarks.....	116
HF - EQUIPMENT ON CERTAIN MNPS ROUTES	116
GM1-CAT.IDE.A.345 Communication and navigation equipment for operations under IFR, or under VFR over routes not navigated by reference to visual landmarks.....	117

EU-OPS Subpart F-I | Revised rule text

APPLICABLE AIRSPACE REQUIREMENTS 117

AMC1-CAT.IDE.A.350 Transponder 117

SSR TRANSPONDER 117

AMC1-CAT.IDE.A.355 Electronic navigation data management 117

NAVIGATION DATA PRODUCTS NEEDED FOR OPERATIONS IN ACCORDANCE
WITH PART-SPA 117

EU-OPS Subpart F-I | Revised rule text

Part-CAT

~~SUBPART K~~Subpart D – Instrument, data, equipment

~~INSTRUMENTS AND EQUIPMENT~~Section 1 – Aeroplanes

~~CAT.IDE.A.100 Instruments and equipment – general~~**OPS 1.630 General introduction**

- (a) Equipment and instruments required by this Part shall be approved in accordance with Part-21, with exception of the following:**~~(a) — An operator shall ensure that a flight does not commence unless the instruments and equipment required under this Subpart are:~~
- ~~(1) Approved, except as specified in subparagraph (c), and installed in accordance with the requirements applicable to them, including the minimum performance standard and the operational and airworthiness requirements; and~~
 - ~~(2) In operable condition for the kind of operation being conducted except as provided in the MEL (OPS 1.030 refers).~~
- ~~(b) Instruments and equipment minimum performance standards are those prescribed in the applicable European Technical Standard Orders (ETSO) as listed in applicable Specifications on European Technical Standard Orders (CS-TSO), unless different performance standards are prescribed in the operational or airworthiness codes. Instruments and equipment complying with design and performance specifications other than ETSO on the date of OPS implementation may remain in service, or be installed, unless additional requirements are prescribed in this Subpart. Instruments and equipment that have already been approved do not need to comply with a revised ETSO or a revised specification, other than ETSO, unless a retroactive requirement is prescribed.~~
- (1) **spare f**~~fuses referred to in OPS 1.635;~~
 - (2) **e**~~Electric torches referred to in OPS 1.640 (a)(4);~~
 - (3) ~~—~~**aAn** ~~a~~**An** accurate time piece referred to in OPS 1.650 (b) & 1.652 (b);
 - (4) **c**~~Chart holder referred to in OPS 1.652 (n);~~
 - (5) **f**~~First-aid kits referred to in OPS 1.745;~~
 - (6) **e**~~Emergency medical kit referred to in OPS 1.755;~~
 - (7) **m**~~Megaphones referred to in OPS 1.810;~~
 - (8) **s**~~Survival and pyrotechnic signalling equipment referred to in OPS 1.835 (a) and (e); and~~
 - (9) **s**~~Sea anchors and equipment for mooring, anchoring or manoeuvring seaplanes and amphibians on water referred to in OPS 1.840; and~~
 - (10) **c**~~Child restraint devices referred to in OPS 1.730(a)(3).~~

EU-OPS Subpart F-I | Revised rule text

(b) Instruments and equipment not required by this Part that do not need to be approved in accordance with Regulation (EC) No 1702/2003, but are carried on a flight, shall comply with the following:

(1) the information provided by these instruments, equipment or accessories shall not be used by the flight crew to comply with Annex I to Regulation (EC) No 216/2008 or CAT.IDE.A.330, CAT.IDE.A.335, CAT.IDE.A.340 and CAT.IDE.A.34; and

(2) the instruments and equipment shall not affect the airworthiness of the aeroplane, even in the case of failures or malfunction.

(c) If equipment is to be used by one flight crew member at his/her station during flight, it must be readily operable from his/her ~~that~~ station. When a single item of equipment is required to be operated by more than one flight crew member it must be installed so that the equipment is readily operable from any station at which the equipment is required to be operated.

(d) Those instruments that are used by any ~~one~~ flight crew member shall be so arranged as to permit the flight crew member to see the indications readily from his/her station, with the minimum practicable deviation from the position and line of vision which ~~that~~ he/she normally assumes when looking forward along the flight path. ~~Whenever a single instrument is required in an aeroplane operated by more than 1 flight crew member it must be installed so that the instrument is visible from each applicable flight crew station.~~

(e) All required emergency equipment shall be easily accessible for immediate use.

Comment [V1]: New rule paragraph to avoid unsafe use in flight of non-approved instrument, data or equipment.

Comment [V2]: Moved in GM CAT.IDE.A.100 (e)

Comment [V3]: New rule to incorporate EU-OPS 1.030 (b)

CAT.IDE.A.105 Minimum equipment for flight

(a) A flight shall not be commenced when any of the aeroplane's instruments, items of equipment or functions required by this Part are inoperative, unless:

(1) the aeroplane is operated in accordance with the operator's minimum equipment list (MEL); or

(2) the aeroplane is approved by the competent authority to be operated within the constraints of the master minimum equipment list (MMEL).

CAT.IDE.110.A Spare electrical fuses ~~OPS 1.635 Circuit protection devices~~

(a) Aeroplanes shall be equipped with spare electrical fuses, of the ratings required for complete circuit protection, for replacement of those fuses that can be replaced in flight. ~~An operator shall not operate an aeroplane in which fuses are used unless there are spare fuses available for use in flight equal to at least 10 % of the number of fuses of each rating or three of each rating whichever is the greater.~~

(b) The number of spare fuses that are required to be carried, shall be the higher of:

(1) 10 % of the number of fuses of each rating; or

(2) three fuses for each rating.

CAT.IDE.115.A ~~OPS 1.640~~ Aeroplane operating lights**(a) Aeroplanes operated by day shall be equipped with:**

~~An operator shall not operate an aeroplane unless it is equipped with:~~

~~(a) For flight by day:~~

- ~~(1) An anti-collision light system;~~
- ~~(2) Lighting supplied from the aeroplane's electrical system to provide adequate illumination for all instruments and equipment essential to the safe operation of the aeroplane;~~
- ~~(3) Lighting supplied from the aeroplane's electrical system to provide illumination in all passenger compartments; and~~
- ~~(4) An electric torch for each required crew member readily accessible to crew members when seated at their designated stations.~~

(b) Aeroplanes operated by night shall in addition be equipped with:

~~(b) For flight by night, in addition to equipment specified in paragraph (a) above:~~

- ~~(1) Navigation/position lights; and~~
- ~~(2) Two landing lights or a single light having two separately energised filaments; and~~
- ~~(3) Lights to conform with the International Regulations for Preventing Collisions at Sea if the aircraft is amphibious. if the aeroplane is a Seaplane or an Amphibian.~~

CAT.IDE.A.120 Equipment to clear windshield ~~OPS 1.645~~ Windshield wipers

~~An operator shall not operate an~~ **Aeroplanes** ~~with a maximum certificated take-off mass (MCTOM) of more than 5 700 kg shall be~~ **unless it is equipped at each pilot station with a means a windshield wiper or equivalent means to maintain a clear a portion of the windshield during precipitation.**

CAT.IDE.A.125 ~~OPS 1.650~~ Day VFR operations – flight and navigational instruments and associated equipment

Aeroplanes operated by day under visual flight rules (VFR) shall be equipped with the following equipment, available at the pilot's station:

~~An operator shall not operate an aeroplane by day in accordance with Visual Flight Rules (VFR) unless it is equipped with the flight and navigational instruments and associated equipment and, where applicable, under the conditions stated in the following subparagraphs:~~

(a) a means of measuring and displaying:

- ~~(1a) A magnetic compass direction;~~
- ~~(2b) An accurate timepiece showing the time in hours, minutes, and seconds;~~
- ~~(3c) A sensitive pressure altimeter **altitude** calibrated in feet with a sub scale setting, calibrated in hectopascals/millibars, adjustable for any barometric pressure likely to be set during flight;~~

Comment [V4]: Moved in AMC

EU-OPS Subpart F-I | Revised rule text

- (4d) ~~An indicated airspeed indicator calibrated in knots;~~ Comment [V5]: Moved in AMC
- (5e) ~~A vertical speed indicator;~~
- (6f) ~~A turn and slip indicator, or a turn coordinator incorporating a slip indicator;~~ Comment [V6]: Moved in AMC
- (7g) ~~An attitude indicator; and~~
- (8h) ~~A stabilised direction indicator; and~~
- (b) **a means of displaying:** (i) ~~A means of indicating~~
- (1) ~~in the flight crew compartment the outside air temperature calibrated in degrees Celsius;~~ Comment [V7]: Moved in AMC
- (2) **Mach number whenever speed limitations are expressed in terms of Mach number; and**
- (3) **when power is not adequately supplied to the required flight instruments.**
- (j) ~~For flights which do not exceed 60 minutes duration, which take off and land at the same aerodrome, and which remain within 50 nm of that aerodrome, the instruments prescribed in subparagraphs (f), (g) and (h) above, and subparagraphs (k)(4), (k)(5) and (k)(6) below, may all be replaced by either a turn and slip indicator, or a turn coordinator incorporating a slip indicator, or both an attitude indicator and a slip indicator.~~ Comment [V8]: Moved in AMC
- (ck) **Whenever two pilots are required for the operation, an additional separate means of displaying the following shall be available for the second pilot shall have separate instruments as follows:**
- (1) ~~A sensitive pressure altimeter altitude calibrated in feet with a sub-scale setting calibrated in hectopascals/millibars, adjustable for any barometric pressure likely to be set during flight;~~ Comment [V9]: Moved in AMC
- (2) **indicated airspeed** ~~An airspeed indicator calibrated in knots;~~ Comment [V10]: Moved in AMC
- (3) ~~A vertical speed indicator;~~
- (4) ~~A turn and slip indicator, or a turn coordinator incorporating a slip indicator;~~ Comment [V11]: Moved in GM
- (5) ~~An attitude indicator; and~~
- (6) ~~A stabilised direction indicator.~~
- (d) ~~Each airspeed indicating system must be equipped with a heated pitot tube or equivalent. A means for preventing malfunction of the airspeed indicating systems due to either condensation or icing shall be available for:~~ Comment [V12]: Moved in AMC
- (1) ~~aeroplanes with an maximum certificated take-off mass MCTOM in excess of more than 5 700 kg or having a maximum approved passenger seating configuration (MPSC) of more than nine;~~ **and**
- (2) ~~aeroplanes first issued with an individual certificate of airworthiness C of A on or after 1 April 1999.~~
- (e) **Single engine aeroplanes, first issued with an individual C of A before 22 May 1995, are exempted from the requirements of subparagraphs (a)(6),(a)(7),(a)(8) and (b)(1) by the competent authority if the compliance would require retrofitting.** Comment [V13]: New paragraph to incorporate content of Appendix 1 to OPS 1.005 (a) 28

EU-OPS Subpart F-I | Revised rule text

- (m) ~~Whenever duplicate instruments are required, the requirement embraces separate displays for each pilot and separate selectors or other associated equipment where appropriate.~~
- (n) ~~All aeroplanes must be equipped with means for indicating when power is not adequately supplied to the required flight instruments; and~~
- (o) ~~All aeroplanes with compressibility limitations not otherwise indicated by the required airspeed indicators shall be equipped with a Mach number indicator at each pilot's station.~~
- (p) ~~An operator shall not conduct Day VFR operations unless the aeroplane is equipped with a headset with boom microphone or equivalent for each flight crew member on flight deck duty.~~

Comment [cg14]: Moved in AMC

Comment [V15]: See above

Comment [V16]: See above

Comment [V17]: Moved in CAT.IDE.A.325 Headset

CAT.IDE.A.130 ~~OPS 1.652~~ IFR or night operations – flight and navigational instruments and associated equipment

Aeroplanes operated under VFR at night or under instrument flight rules (IFR) shall be equipped with the following equipment, available at the pilot's station: An operator shall not operate an aeroplane in accordance with Instrument Flight Rules (IFR) or by night in accordance with Visual Flight Rules (VFR) unless it is equipped with the flight and navigational instruments and associated equipment and, where applicable, under the conditions stated in the following subparagraphs:

(a) a means of measuring and displaying:

- (1a) ~~A magnetic compass~~**direction;**
- (2b) ~~An accurate time piece showing the time in hours, minutes and seconds;~~**;**
- (c) ~~Two pressure altimeters calibrated in feet with sub-scale settings, calibrated in hectopascals/millibars, adjustable for any barometric pressure likely to be set during flight; These altimeters must have counter drum pointer or equivalent presentation.~~
- (3d) ~~An **indicated** airspeed indicating system with heated pitot tube or equivalent means for preventing malfunctioning due to either condensation or icing including a warning indication of pitot heater failure. The pitot heater failure warning indication requirement does not apply to those aeroplanes with a maximum approved passenger seating configuration of 9 or less or a maximum certificated take off mass of 5 700 kg or less and issued with an individual Certificate of Airworthiness prior to 1 April 1998;~~**;**
- (4e) ~~A vertical speed~~**indicator;**
- (5f) ~~Turn and slip,~~ **or in the case of aeroplanes equipped with a standby means of measuring and displaying attitude, slip**~~indicator;~~
- (6) ~~An attitude~~**indicator; and;**
- (7h) ~~A stabilised direction~~**indicator;**

Comment [V18]: Moved in AMC

Comment [cg19]: Moved to the subparagraph (e)

(b) two means of measuring and displaying pressure altitude;

(c) a means of displaying:

EU-OPS Subpart F-I | Revised rule text

- (i1) ~~A means of indicating in the flight crew compartment the outside air temperature calibrated in degrees Celsius; and~~
- (2) Mach number whenever speed limitations are expressed in terms of Mach number; and**
- (3) when power is not adequately supplied to the required flight instruments;**
- (d) a means for preventing malfunction of the airspeed indicating systems required in (a)(3) and (h)(2) due to condensation or icing;:-**
- (e) a means of indicating and annunciating to the flight crew the failure of the means required in (d) above for aeroplanes:**
- (1) issued with an individual C of A on or after 1 April 1998; or**
- (2) issued with an individual C of A before 1 April 1998 with an MCTOM of more than 5 700 kg, and with an MPSC of more than nine;**
- (fj) except for propeller-driven aeroplanes with an MCTOM of 5 700 kg or less, two independent static pressure systems, except that for propeller driven aeroplanes with maximum certificated take off mass of 5 700 kg or less, one static pressure system and one alternate source of static pressure is allowed;:-**
- (g) one static pressure system and one alternate source of static pressure for propeller-driven aeroplanes with an MCTOM of 5 700 kg or less;**
- (hk) ~~Whenever two pilots are required for the operation, a separate means of displaying for the second pilot's station shall have separate instruments as follows:~~**
- (1) ~~A sensitive pressure altimeter calibrated in feet with a sub scale setting, calibrated in hectopascals/millibars, adjustable for any barometric pressure likely to be set during flight and which may be one of the 2 altimeters required by subparagraph (c) above. These altimeters must have counter drum pointer or equivalent presentation;~~**
- (2) ~~An indicated airspeed indicating system with heated pitot tube or equivalent means for preventing malfunctioning due to either condensation or icing including a warning indication of pitot heater failure. The pitot heater failure warning indication requirement does not apply to those aeroplanes with a maximum approved passenger seating configuration of 9 or less or a maximum certificated take off mass of 5 700 kg or less and issued with an individual Certificate of Airworthiness prior to 1 April 1998;~~**
- (3) ~~A vertical speed indicator;~~**
- (4) ~~A turn and slip indicator;~~**
- (5) ~~An attitude indicator; and~~**
- (6) ~~A stabilised direction indicator;~~**
- (ii) ~~Those aeroplanes with a maximum certificated take off mass in excess of 5 700 kg or having a maximum approved passenger seating configuration of more than 9~~
standby means of measuring and displaying attitude for aeroplanes with an MCTOM of more than 5 700 kg or an MPSC of more than nine that:**

Comment [xy20]: It's not additional. Two means are already required by (a).

Comment [V21]: Moved in AMC

Comment [V22]: Moved to (e) above

EU-OPS Subpart F-I | Revised rule text

~~(seats must be equipped with an additional, standby, attitude indicator (artificial horizon), capable of being used from either pilot's station, that:~~

- ~~(1) is~~ powered continuously during normal operation and, after a total failure of the normal electrical generating system is powered from a source independent ~~of~~ **from** the normal electrical generating system;
- ~~(2) Provides~~ reliable operation for a minimum of 30 minutes after total failure of the normal electrical generating system, taking into account other loads on the emergency power supply and operational procedures;
- ~~(3) Operates~~ independently of any other attitude indicating system;
- ~~(4) is~~ operative automatically after total failure of the normal electrical generating system; ~~and~~
- ~~(5) is~~ appropriately illuminated during all phases of operation, except for aeroplanes with an **MCTOM** maximum certified take-off mass of 5 700 kg or less, already registered in a Member State on 1 April 1995, **and** equipped with a standby attitude indicator in the left-hand instrument panel;
- (6) it must be clearly evident to the flight crew when the standby attitude indicator is being operated by emergency power; and**
- (7) where the standby attitude indicator has its own dedicated power supply there shall be an associated indication, either on the instrument or on the instrument panel, when this supply is in use.**

(j) a chart holder in an easily readable position that can be illuminated for night operations.

~~(mk) In complying with subparagraph (l) above, it must be clearly evident to the flight crew when the standby attitude indicator, required by that subparagraph, is being operated by emergency power. Where the standby attitude indicator has its own dedicated power supply there shall be an associated indication, either on the instrument or on the instrument panel, when this supply is in use.~~

Comment [GC123]: Moved under (i)

~~(minn) A chart holder in an easily readable position which can be illuminated for night operations.~~

~~(o) If the standby attitude instrument system is certificated according to CS 25.1303(b)(4) or equivalent, the turn and slip indicators may be replaced by slip indicators.~~

Comment [V24]: Moved in AMC

~~(p) Whenever duplicate instruments are required, the requirement embraces separate displays for each pilot and separate selectors or other associated equipment where appropriate.~~

Comment [V25]: Moved in AMC

~~(q) All aeroplanes must be equipped with means for indicating when power is not adequately supplied to the required flight instruments; and~~

Comment [V26]: Included in paragraph (c) of this rule

~~(r) All aeroplanes with compressibility limitations not otherwise indicated by the required airspeed indicators shall be equipped with a Mach number indicator at each pilot's station.~~

Comment [V27]: Included in paragraph (c) of this rule

~~(s) An operator shall not conduct IFR or night operations unless the aeroplane is equipped with a headset with boom microphone or equivalent for each flight crew member on flight deck duty and a transmit button on the control wheel for each required pilot.~~

Comment [V28]: Moved in CAT.IDE.A.325 Headset

CAT.IDE.A.135~~OPS 1.655~~ Additional equipment for single pilot operation under IFR ~~or at night~~

Aeroplanes operated under IFR with a~~An operator shall not conduct single pilot shall be IFR operations unless the aeroplane is equipped with an autopilot with at least altitude hold and heading mode.~~

CAT.IDE.A.140~~OPS 1.660~~ Altitude alerting system

(a) Except **in the case of** aeroplanes with an ~~maximum certificated take-off mass~~**MCTOM of more than 5 700 kg or less and with an MPSC of more than nine** and first issued with an individual **C of A** before 1 April 1972, **aeroplanes shall be equipped with an altitude alerting system capable of alerting the flight crew when approaching, or deviating from, a pre-selected altitude, in the case of:**~~An operator shall not operate a~~

(1) ~~turbine-propeller-powered aeroplanes with an MCTOM maximum certificated take-off mass in excess of~~ **more than 5 700 kg or having an MPSC maximum approved passenger seating configuration of more than nine**~~9~~ seats; or

(2) ~~a turbojet-powered aeroplanes~~ **powered by turbo-jet engines.**

~~unless it is equipped with an altitude alerting system capable of:~~

~~(1) Alerting the flight crew upon approaching a preselected altitude; and~~

~~(2) Alerting the flight crew by at least an aural signal, when deviating above or below a preselected altitude;~~

CAT.IDE.A.150~~OPS 1.665~~ Ground proximity warning system and Terrain awareness warning Ssystem (TAWS)

(a) ~~An operator shall not operate a~~**Turbine-powered aeroplanes having an maximum certificated take-off mass MCTOM of more than in excess of 5 700 kg, or an maximum approved passenger seating configuration MPSC of more than 9 nine**~~unless it is~~ **shall be equipped with a TAWS that meets the requirements for Class A equipment as specified in the applicable European technical standards order (ETSO) issued by the Agency**~~ground proximity warning system that includes a predictive terrain hazard warning function (Terrain Awareness and Warning System – TAWS).~~

(b) Reciprocating-engine-powered aeroplanes with an MCTOM of more than 5 700 kg, or an MPSC of more than nine shall be equipped with a TAWS that meets the requirement for Class B equipment as specified in the applicable ETSO issued by the Agency.

~~(b) The ground proximity warning system must automatically provide, by means of aural signals, which may be supplemented by visual signals, timely and distinctive warning to the flight crew of sink rate, ground proximity, altitude loss after take-off or go-around, incorrect landing configuration and downward glide slope deviation.~~

~~(c) The terrain awareness and warning system must automatically provide the flight crew, by means of visual and aural signals and a Terrain Awareness Display, with sufficient alerting time to prevent controlled flight into terrain events, and provided a forward-looking capability and terrain clearance floor.~~

Comment [GCI29]: IR changed further to comments and consultation with certification experts.

CAT.IDE.A.155~~OPS 1.668~~ Airborne Collision Avoidance System (ACAS)

~~AN OPERATOR SHALL NOT OPERATE A TURBINE POWERED AEROPLANE HAVING A MAXIMUM CERTIFICATED TAKE-OFF MASS IN EXCESS OF 5 700 KG OR A MAXIMUM APPROVED PASSENGER SEATING CONFIGURATION OF MORE THAN 19 UNLESS IT IS EQUIPPED WITH AN AIRBORNE COLLISION AVOIDANCE SYSTEM WITH A MINIMUM PERFORMANCE LEVEL A OF AT LEAST ACAS II.~~
TURBINE-POWERED AEROPLANES WITH A MAXIMUM CERTIFIED TAKE-OFF MASS OF MORE THAN 5 700 KG OR A MAXIMUM PASSENGER SEATING CONFIGURATION OF MORE THAN 19 SHALL BE EQUIPPED WITH ACAS II.

CAT.IDE.A.160~~OPS 1.670~~ AIRBORNE WEATHER DETECTING RADAR EQUIPMENT

~~(A) AN OPERATOR SHALL NOT OPERATE:~~

The following shall be equipped with airborne weather detecting equipment when operated at night or in instrument meteorological conditions (IMC) in areas where thunderstorms or other potentially hazardous weather conditions, regarded as detectable with airborne weather detecting equipment, may be expected to exist along the route:

~~(a) (1) A pressurised aeroplanes,~~ **(a) (1) A pressurised aeroplanes,**

~~(2)~~

~~(b) An unnon-pressurised aeroplanes which with has an MCTOM maximum certificated take-off mass of more than 5 700 kg; and~~

~~(c)~~

~~(c) An unnon-pressurised aeroplane aeroplanes having with an MPSC maximum approved passenger seating configuration of more than nine. 9seats,~~

~~unless it is equipped with airborne weather radar equipment whenever such an aeroplane is being operated at night or in instrument meteorological conditions in areas where thunderstorms or other potentially hazardous weather conditions, regarded as detectable with airborne weather radar, may be expected to exist along the route.~~

~~(b) For propeller driven pressurised aeroplanes having a maximum certificated take off mass not exceeding 5 700 kg with a maximum approved passenger seating configuration not exceeding 9 seats the airborne weather radar equipment may be replaced by other equipment capable of detecting thunderstorms and other potentially hazardous weather conditions, regarded as detectable with airborne weather radar equipment, subject to approval by the Authority.~~

Comment [V30]: Moved in AMC

CAT.IDE.A.165~~OPS 1.675~~ Additional eEquipment for operations in icing conditions at night

~~(a) An operator shall not operate an aeroplane in expected or actual icing conditions unless it is certificated and equipped to operate in icing conditions.~~

Comment [V31]: Deleted as it is already contained in ER 2.a.5.

~~(ab) An operator shall not operate an~~ **Aeroplanes operated** in expected or actual icing conditions at night ~~unless it is~~ **shall be** equipped with a means to illuminate or detect the formation of ice.

EU-OPS Subpart F-I | Revised rule text

- (b) ~~Any illumination that is used must be of a type that will~~ **The means to illuminate the formation of ice shall** not cause glare or reflection that would handicap crew members in the performance of their duties.

OPS 1.680 Cosmic radiation detection equipment

- (a) ~~An operator shall not operate an aeroplane above 15 000 m (49 000 ft) unless:~~
- (1) ~~It is equipped with an instrument to measure and indicate continuously the dose rate of total cosmic radiation being received (i.e. the total of ionizing and neutron radiation of galactic and solar origin) and the cumulative dose on each flight, or~~
 - (2) ~~A system of on board quarterly radiation sampling acceptable to the Authority is established.~~

Comment [V32]: Deleted as Basic Regulation, which only addresses the mitigation of safety risks, does not provide the legal basis for their transposition or to avoid overlaps with other Community Legislation, in particular that related to health and safety at work or the protection against radiations (Council Directive 96/29/Euratom of 13 May 1996. It has therefore been necessary to delete the JAR requirement related to the cosmic radiation indicator

CAT.IDE.A.170 ~~OPS 1.685~~ Flight crew interphone system

~~An operator shall not operate an~~ **Aeroplanes operated by more than one flight crew member on which a flight crew of more than one is required unless it shall be** equipped with a flight crew interphone system, including headsets and microphones, ~~not of a handheld type,~~ for use by all ~~members of the flight crew~~ **members.**

CAT.IDE.A.175 ~~OPS 1.690~~ Crew member interphone system

(a) ~~An operator shall not operate an~~ **Aeroplanes with an MCTOM maximum certificated take off mass exceeding of more than 15 000 kg, or having with an MPSC maximum approved passenger seating configuration of more than 19 unless it shall be** equipped with a crew member interphone system except for aeroplanes first issued with an individual certificate of airworthiness **C of A** before 1 April 1965 and already registered in a Member State on 1 April 1995.

Comment [GCI33]: moved to AMC

- (b) ~~The crew member interphone system required by this paragraph must:~~
- (1) ~~Operate independently of the public address system except for handsets, headsets, microphones, selector switches and signalling devices;~~
 - (2) ~~Provide a means of two way communication between the flight crew compartment and:~~
 - (i) Each passenger compartment;**
 - (ii) ~~Each galley located other than on a passenger deck level; and~~
 - (iii) ~~Each remote crew compartment that is not on the passenger deck and is not easily accessible from a passenger compartment;~~
 - (3) ~~Be readily accessible for use from each of the required flight crew stations in the flight crew compartment;~~
 - (4) ~~Be readily accessible for use at required cabin crew member stations close to each separate or pair of floor level emergency exits;~~
 - (5) ~~Have an alerting system incorporating aural or visual signals for use by flight crew members to alert the cabin crew and for use by cabin crew members to alert the flight crew;~~

EU-OPS Subpart F-I | Revised rule text

~~(6) Have a means for the recipient of a call to determine whether it is a normal call or an emergency call; and~~

~~(7) Provide on the ground a means of two way communication between ground personnel and at least two flight crew members.~~

Comment [V34]: Moved to AMC

CAT.IDE.A.180~~OPS 1.695~~ Public address system

~~(a) An operator shall not operate an a~~**Aeroplanes with an MPSC maximum approved passenger seating configuration of more than 19 unless **shall be equipped with a public address system** is installed.**

~~(b) The public address system required by this paragraph must:~~

~~(1) Operate independently of the interphone systems except for handsets, headsets, microphones, selector switches and signalling devices;~~

~~(2) Be readily accessible for immediate use from each required flight crew member station;~~

~~(3) For each required floor level passenger emergency exit which has an adjacent cabin crew seat, have a microphone which is readily accessible to the seated cabin crew member, except that one microphone may serve more than one exit, provided the proximity of the exits allows unassisted verbal communication between seated cabin crew members;~~

~~(4) Be capable of operation within 10 seconds by a cabin crew member at each of those stations in the compartment from which its use is accessible; and~~

~~(5) Be audible and intelligible at all passenger seats, toilets and cabin crew seats and work stations.~~

Comment [V35]: Moved to AMC

CAT.IDE.A.185~~OPS 1.700~~ Cockpit voice recorders—1

(a) The following aeroplanes shall be equipped with a cockpit voice recorder (CVR):

(1) aeroplanes with an MCTOM more than 5 700 kg; and

(2) multi-engined turbine-powered aeroplanes with an MCTOM of 5 700 kg or less, and with an MPSC of more than nine and first issued with an individual C of A on or after 1 January 1990.

~~(a) An operator shall not operate an aeroplane first issued with an individual Certificate of Airworthiness, on or after 1 April 1998, which:~~

~~(1) Is multi engine turbine powered and has a maximum approved passenger seating configuration of more than 9; or~~

~~(2) Has a maximum certificated take off mass over 5 700 kg,~~

~~unless it is equipped with a cockpit voice recorder which, with reference to a time scale, records:~~

~~(i) Voice communications transmitted from or received on the flight deck by radio;~~

~~(ii) The aural environment of the flight deck, including without interruption, the audio signals received from each boom and mask microphone in use;~~

EU-OPS Subpart F-I | Revised rule text

- (iii) ~~Voice communications of flight crew members on the flight deck using the aeroplane's interphone system;~~
 - (iv) ~~Voice or audio signals identifying navigation or approach aids introduced into a headset or speaker; and~~
 - (v) ~~Voice communications of flight crew members on the flight deck using the public address system, if installed.~~
- (b) ~~The cockpit voice recorder~~**CVR** shall be capable of retaining information ~~the data~~ recorded during at least:
- (1) the last preceding 2 hours of its operation except that, for in the case of those aeroplanes referred to in (a)(1) when the individual C of A has been issued on or after 1 April 1998; with a maximum certificated take-off mass of 5 700 kg or less, this period may be reduced**
 - (2) the preceding 30 minutes for aeroplanes referred to in (a)(1) when the individual C of A has been issued before 1 April 1998; or**
 - (3) to the preceding 30 minutes, in the case of aeroplanes referred to in (a)(2).**
- (c) **The CVR shall record with reference to a timescale:**
- (1) voice communications transmitted from or received on the flight crew compartment per radio;**
 - (2) flight crew members' voice communications using the interphone system and the public address system, if installed;**
 - (3) the aural environment of the flight crew compartment, including, where practicable, without interruption, the audio signals received from each crew microphone; and**
 - (4) voice or audio signals identifying navigation or approach aids introduced into a headset or speaker.**
- (d) **The CVR shall automatically start to record** prior to the aeroplane **being capable of** moving under its own power and **shall stop automatically** ~~continue to record until the termination of the flight when~~ **after** the aeroplane is no longer incapable of moving under its own power.
- (e) ~~In addition,~~ depending on the availability of electrical power, the ~~cockpit voice recorder~~**CVR must shall** start to record as early as possible during the cockpit checks, prior to engine start at the beginning of the flight until the cockpit checks immediately following engine shutdown at the end of the flight, **in the case of:**
- (1) aeroplanes referred to in (a)(1), in the case of individual C of A issued after 1 April 1998; or**
 - (2) aeroplanes referred to in (a)(2).**
- (f) ~~The cockpit voice recorder~~**CVR must shall** have a device to assist in locating that recorder ~~it~~ in water.

EU-OPS Subpart F-I | Revised rule text

~~OPS 1.705 Cockpit voice recorders – 2~~

Comment [cg36]: Included in CAT.IDE.A.185

- ~~(a) An operator shall not operate any multi-engined turbine aeroplane first issued with an individual Certificate of Airworthiness, on or after 1 January 1990 up to and including 31 March 1998 which has a maximum certificated take-off mass of 5 700 kg or less and a maximum approved passenger seating configuration of more than 9, unless it is equipped with a cockpit voice recorder which records:~~
- ~~(1) Voice communications transmitted from or received on the flight deck by radio;~~
 - ~~(2) The aural environment of the flight deck, including where practicable, without interruption, the audio signals received from each boom and mask microphone in use;~~
 - ~~(3) Voice communications of flight crew members on the flight deck using the aeroplane's interphone system;~~
 - ~~(4) Voice or audio signals identifying navigation or approach aids introduced into a headset or speaker; and~~
 - ~~(5) Voice communications of flight crew members on the flight deck using the public address system, if installed.~~
- ~~(b) The cockpit voice recorder shall be capable of retaining information recorded during at least the last 30 minutes of its operation.~~
- ~~(c) The cockpit voice recorder must start to record prior to the aeroplane moving under its own power and continue to record until the termination of the flight when the aeroplane is no longer capable of moving under its own power. In addition, depending on the availability of electrical power, the cockpit voice recorder must start to record as early as possible during the cockpit checks, prior to the flight until the cockpit checks immediately following engine shutdown at the end of the flight.~~
- ~~(d) The cockpit voice recorder must have a device to assist in locating that recorder in water.~~

~~OPS 1.710 Cockpit voice recorders – 3~~

Comment [cg37]: Included in CAT.IDE.A.185

- ~~(a) An operator shall not operate any aeroplane with a maximum certificated take-off mass over 5 700 kg first issued with an individual certificate of airworthiness, before 1 April 1998 unless it is equipped with a cockpit voice recorder which records:~~
- ~~(1) Voice communications transmitted from or received on the flight deck by radio;~~
 - ~~(2) The aural environment of the flight deck;~~
 - ~~(3) Voice communications of flight crew members on the flight deck using the aeroplane's interphone system;~~
 - ~~(4) Voice or audio signals identifying navigation or approach aids introduced into a headset or speaker; and~~
 - ~~(5) Voice communications of flight crew members on the flight deck using the public address system, if installed.~~
- ~~(b) The cockpit voice recorder shall be capable of retaining information recorded during at least the last 30 minutes of its operation.~~

EU-OPS Subpart F-I | Revised rule text

- ~~(c) The cockpit voice recorder must start to record prior to the aeroplane moving under its own power and continue to record until the termination of the flight when the aeroplane is no longer capable of moving under its own power.~~
- ~~(d) The cockpit voice recorder must have a device to assist in locating that recorder in water.~~

CAT.IDE.A.190OPS 1.715 Flight data recorders—1
(See Appendix 1 to OPS 1.715)

(a) The following aeroplanes shall be equipped with a flight data recorder (FDR) that uses a digital method of recording and storing data and for which a method of readily retrieving that data from the storage medium is available:

- (1) aeroplanes with an MCTOM of more than 5 700 kg first issued with an individual C of A on or after 1 June 1990;**
- (2) turbine-engined aeroplanes with an MCTOM of more than 5 700 kg first issued with an individual C of A before 1 June 1990; and**
- (3) multi-engined turbine-powered aeroplanes with an MCTOM of 5 700 kg or less, and with an MPSC of more than nine, and first issued with an individual C of A on or after 1 April 1998.**

~~(a) An operator shall not operate any aeroplane first issued with an individual Certificate of Airworthiness on or after 1 April 1998 which:~~

- ~~(1) Is multi engine turbine powered and has a maximum approved passenger seating configuration of more than 9; or~~
- ~~(2) Has a maximum certificated take off mass over 5 700 kg;~~

~~unless it is equipped with a flight data recorder that uses a digital method of recording and storing data and a method of readily retrieving that data from the storage medium is available.~~

(b) The flight data recorder FDR shall record:

- (1) time, altitude, airspeed, normal acceleration and heading and** be capable of retaining the data recorded during at least the ~~last preceding~~ **25 hours of its operation except that, for those aeroplanes referred to in (a)(2) with an MCTOM of less than 27 000;** ~~with a maximum certificated take-off mass of 5 700 kg or less, this period may be reduced to 10 hours.~~
- (2) the parameters required to determine accurately the aeroplane flight path, speed, attitude, engine power and configuration of lift and drag devices and be capable of retaining the data recorded during at least the preceding 25 hours, for aeroplanes referred to in (a)(1) with an MCTOM of under 27 000 kg and first issued with an individual C of A before 1 January 2016;**
- (3) the parameters required to determine accurately the aeroplane flight path, speed, attitude, engine power, configuration and operation and be capable of retaining the data recorded during at least the preceding 25 hours, for aeroplanes referred to in (a)(1) and (a)(2) with an**

EU-OPS Subpart F-I | Revised rule text

MCTOM of over 27 000 kg; and first issued with an individual C of A before 1 January 2016;

- (4) the parameters required to determine accurately the aeroplane flight path, speed, attitude, engine power and configuration of lift and drag devices and be capable of retaining the data recorded during at least the preceding 10 hours, in the case of aeroplanes referred to in (a)(3) and first issued with an individual C of A before 1 January 2016; or**
- (5) the parameters required to determine accurately the aeroplane flight path, speed, attitude, engine power, configuration and operation and be capable of retaining the data recorded during at least the preceding 25 hours, for aeroplanes referred to in (a)(1) and (a)(3) and first issued with an individual C of A on or after 1 January 2016.**

~~(c) The flight data recorder must, with reference to a timescale, record:~~

- ~~(1) The parameters listed in Tables A1 or A2 of Appendix 1 to OPS 1.715 as applicable;~~
- ~~(2) For those aeroplanes with a maximum certificated take-off mass over 27 000 kg, the additional parameters listed in Table B of Appendix 1 to OPS 1.715;~~
- ~~(3) For aeroplanes specified in (a) above, the flight data recorder must record any dedicated parameters relating to novel or unique design or operational characteristics of the aeroplane as determined by the Authority during type or supplemental type certification; and~~
- ~~(4) For aeroplanes equipped with electronic display system the parameters listed in Table C of Appendix 1 to OPS 1.715, except that, for aeroplanes first issued with an individual Certificate of Airworthiness before 20 August 2002 those parameters for which:

 - ~~(i) The sensor is not available; or~~
 - ~~(ii) The aeroplane system or equipment generating the data needs to be modified; or~~
 - ~~(iii) The signals are incompatible with the recording system;~~~~

~~do not need to be recorded if acceptable to the Authority.~~

- ~~(cd) Data ~~must~~ **shall** be obtained from aeroplane sources ~~which~~ **that** enable accurate correlation with information displayed to the flight crew.~~
- ~~(de) The flight data recorder ~~FDR~~ **must** ~~start automatically~~ **shall automatically** start automatically to record the data prior to the aeroplane being capable of moving under its own power and ~~must~~ **shall** stop automatically after the aeroplane is incapable of moving under its own power.~~
- ~~(fe) The flight data recorder ~~FDR~~ **must** ~~have a device to assist in locating that recorder~~ **shall** have a device to assist in locating ~~that recorder~~ **it** in water.~~
- ~~(g) Aeroplanes first issued with an individual Certificate of Airworthiness on or after 1 April 1998, but not later than 1 April 2001 may not be required to comply with OPS 1.715(c) if approved by the Authority, provided that:~~

EU-OPS Subpart F-I | Revised rule text

- ~~(1) Compliance with OPS 1.715(c) cannot be achieved without extensive modification to the aeroplane systems and equipment other than the flight data recorder system; and~~
- ~~(2) The aeroplane complies with OPS 1.720(c) except that parameter 15b in Table A of Appendix 1 to OPS 1.720 need not to be recorded.~~

Comment [cg38]: Included in CAT.IDE.A.190

~~OPS 1.720 Flight data recorders – 2~~
~~(See Appendix 1 to OPS 1.720)~~

- ~~(a) An operator shall not operate any aeroplane first issued with an individual certificate of airworthiness on or after 1 June 1990 up to and including 31 March 1998 which has a maximum certificated take off mass over 5 700 kg unless it is equipped with a flight data recorder that uses a digital method of recording and storing data and a method of readily retrieving that data from the storage medium is available.~~
- ~~(b) The flight data recorder shall be capable of retaining the data recorded during at least the last 25 hours of its operation.~~
- ~~(c) The flight data recorder must, with reference to a timescale, record:

 - ~~(1) The parameters listed in Table A of Appendix 1 to OPS 1.720; and~~
 - ~~(2) For those aeroplanes with a maximum certificated take off mass over 27 000 kg the additional parameters listed in Table B of Appendix 1 to OPS 1.720.~~~~
- ~~(d) For those aeroplanes having a maximum certificated take off mass of 27 000 kg or below, if acceptable to the Authority, parameters 14 and 15b of Table A of Appendix 1 to OPS 1.720 need not be recorded, when any of the following conditions are met:

 - ~~(1) The sensor is not readily available;~~
 - ~~(2) Sufficient capacity is not available in the flight recorder system;~~
 - ~~(3) A change is required in the equipment that generates the data.~~~~
- ~~(e) For those aeroplanes having a maximum certificated take off mass over 27 000 kg, if acceptable to the Authority, the following parameters need not be recorded: 15b of Table A of Appendix 1 to OPS 1.720, and 23, 24, 25, 26, 27, 28, 29, 30 and 31 of Table B of Appendix 1, if any of the following conditions are met:

 - ~~(1) The sensor is not readily available;~~
 - ~~(2) Sufficient capacity is not available in the flight data recorder system;~~
 - ~~(3) A change is required in the equipment that generates the data;~~
 - ~~(4) For navigational data (NAV frequency selection, DME distance, latitude, longitude, ground speed and drift) the signals are not available in digital form.~~~~
- ~~(f) Individual parameters that can be derived by calculation from the other recorded parameters, need not to be recorded if acceptable to the Authority.~~
- ~~(g) Data must be obtained from aeroplane sources which enable accurate correlation with information displayed to the flight crew;~~
- ~~(h) The flight data recorder must start to record the data prior to the aeroplane being capable of moving under its own power and must stop after the aeroplane is incapable of moving under its own power.~~

EU-OPS Subpart F-I | Revised rule text

- (i) ~~The flight data recorder must have a device to assist in locating that recorder in water.~~

~~OPS 1.725 Flight data recorders—3~~
~~(See Appendix 1 to OPS 1.725)~~

Comment [cg39]: Included in CAT.IDE.A.190

- (a) ~~An operator shall not operate any turbine engine first issued with an individual Certificate of Airworthiness, before 1 June 1990 which has a maximum certificated take-off mass over 5 700 kg unless it is equipped with a flight data recorder that uses a digital method of recording and storing data and a method of readily retrieving that data from the storage medium is available.~~
- (b) ~~The flight data recorder shall be capable of retaining the data recorded during at least the last 25 hours of its operation.~~
- (c) ~~The flight data recorder must, with reference to a timescale, record:~~
- (1) ~~The parameters listed in Table A of Appendix 1 to OPS 1.725.~~
- (2) ~~For those aeroplanes with a maximum certificated take-off mass over 27 000 kg that are of a type first type certificated after 30 September 1969, the additional parameters from 6 to 15b of Table B of Appendix 1 to OPS 1.725 of this paragraph. The following parameters need not be recorded, if acceptable to the Authority: 13, 14 and 15b in Table B of Appendix 1 to OPS 1.725 when any of the following conditions are met:~~
- (i) ~~The sensor is not readily available,~~
- (ii) ~~Sufficient capacity is not available in the flight recorder system,~~
- (iii) ~~A change is required in the equipment that generates the data; and~~
- (3) ~~When sufficient capacity is available on a flight recorder system, the sensor is readily available and a change is not required in the equipment that generates the data:~~
- (i) ~~For aeroplanes first issued with an individual Certificate of Airworthiness on or after 1 January 1989, with a maximum certificated take off mass of over 5 700 kg but not more than 27 000 kg, parameters 6 to 15b of Table B of Appendix 1 to OPS 1.725; and~~
- (ii) ~~For aeroplanes first issued with an individual Certificate of Airworthiness on or after 1 January 1987, with a maximum certificated take off mass of over 27 000 kg the remaining parameters of Table B of Appendix 1 to OPS 1.725.~~
- (d) ~~Individual parameters that can be derived by calculation from the other recorded parameters, need not to be recorded if acceptable to the Authority.~~
- (e) ~~Data must be obtained from aircraft sources which enable accurate correlation with information displayed to the flight crew.~~
- (f) ~~The flight data recorder must start to record the data prior to the aeroplane being capable of moving under its own power and must stop after the aeroplane is incapable of moving under its own power.~~

EU-OPS Subpart F-I | Revised rule text

- ~~(g) The flight data recorder must have a device to assist in locating that recorder in water.~~

CAT.IDE.A.195 Data link recording

- (a) **Aeroplanes first issued with an individual C of A on or after 8 April 2014 that have the capability to operate data link communications and are required to be equipped with a CVR, shall record on a recorder, where applicable:**
- (1) data link communication messages related to air traffic services communications to and from the aeroplane;**
 - (2) information that enables correlation to any associated records related to data link communications and stored separately from the aeroplane; and**
 - (3) information on the time and priority of data link communications messages, taking into account the system's architecture.**
- (b) **The recorder shall use a digital method of recording and storing data and information and a method for retrieving that data. The recording method shall be such as to allow the data to match the data recorded on the ground.**
- (c) **The recorder shall be capable of retaining data recorded for at least the same duration as set out for CVRs in CAT.IDE.A.185.**
- (d) **The recorder shall have a device to assist in locating it in water.**
- (e) **The recorder shall start to record automatically prior to the aeroplane moving under its own power and shall continue to record until the termination of the flight when the aeroplane is no longer capable of moving under its own power.**
- (f) **Depending on the availability of electrical power, the recorder shall start to record as early as possible during the cockpit checks prior to engine start at the beginning of the flight until the cockpit checks immediately following engine shutdown at the end of the flight.**

CAT.IDE.A.200 ~~OPS 1.727~~ Combination Recorder

- ~~(a) Compliance with Cockpit Voice recorder CVR and flight data recorder FDR requirements may be achieved by:~~

- ~~(1) One flight data and cockpit voice combination recorder if in the case of the aeroplanes has required to be equipped with a cockpit voice recorder CVR or with an flight data recorder FDR only; or~~
- ~~(2) One flight data and cockpit voice combination recorder in the case of if the aeroplanes with an MCTOM maximum certificated take-off mass of 5 700 kg or less has and required to be equipped with a cockpit voice recorder CVR and an flight data recorder FDR; or~~
- ~~(3) Two flight data and cockpit voice combination recorders in the case of if the aeroplanes with a maximum take-off mass an MCTOM over of more than~~

Comment [GCI40]: In CAT.IDE.A.195, it is clearly mentioned that data link recording will be required only if the aircraft is "required to be equipped with a cockpit voice recorder", hence only the FDR carriage requirement and the CVR carriage requirement need to be taken into account to define the rule for a combination recorder. This is also addressed in AMC1-CAT.IDE.A.195

EU-OPS Subpart F-I | Revised rule text

5 700 kg ~~has~~ **and required** to be equipped with a cockpit voice recorder **CVR** and an flight data recorder **FDR**.

~~(b) — A combination recorder is a flight recorder that records:~~

~~(1) — all voice communications and aural environment required by the relevant cockpit voice recorder paragraph; and~~

~~(2) — all parameters required by the relevant flight data recorder paragraph, with the same specifications required by those paragraphs.~~

Comment [GCI41]: Moved to AMC

CAT.IDE.A.205OPS 1.730 Seats, seat safety belts, harnesses and child restraint devices

(a) ~~An operator shall not operate an A~~**aeroplanes unless it is shall be** equipped with:

~~(1) A~~**a seat or berth for each person on board older than 24 months**~~who is aged two years or more;~~

(2) seats for cabin crew members;

(3) either:

(i) a seat belt on each passenger seat and restraining belts for each berth; or

(ii) a seat belt with upper torso restraint system on each passenger seat in the case of aeroplanes with an MCTOM less than 5 700 kg and with an MPSC of less than nine after 8 April 2015;

~~(34) A~~**a child restraint device, acceptable to the Authority, for each person on board younger than 24 months**~~infant;~~

~~(45) Except as provided in subparagraph (c) below, a safety belt with shoulder harness for each flight crew seat and for any seat alongside a pilot's seat incorporating a device which~~**that** will automatically restrain the occupant's torso in the event of rapid deceleration:

(i) on each flight crew seat and for any seat alongside a pilot's seat;

(ii) on each observer's seat located in the cockpit; and

~~(56) Except as provided in subparagraph (c) below, a~~**a safety belt with shoulder harness on the seats for the minimum required cabin crew**~~for each cabin crew seat and observer's seats. However, this requirement does not preclude use of passenger seats by cabin crew members carried in excess of the required cabin crew complement.; and~~

~~(6) Seats for cabin crew members located near required floor level emergency exits except that, if the emergency evacuation of passengers would be enhanced by seating cabin crew members elsewhere, other locations are acceptable. Such seats shall be forward or rearward facing within 15° of the longitudinal axis of the aeroplane.~~

(b) ~~All safety belts with shoulder~~**Safety harnesses must shall:**

(12) include two shoulder straps and a seat belt which may be used independently; and

(23) have a single point release.

Comment [GCI42]: Change stemming from NPA 26-20 and taking into account comments received and further considerations by EASA. For detailed explanation, please refer to explanatory note.

Comment [V43]: See point (2) and associated AMC

Comment [GCI44]: Definition of safety harness included since it was missing from EU-OPS. In addition, a proposal is put forward to replace 'safety harness' with 'seat belt with upper torso restrain system' for all seats to provide flexibility for different design solutions. Those design solutions would conform to an equivalent level of safety as determined by airworthiness codes. The Agency invites comments on this particular point. Further explanation is provided in the explanatory note.

EU-OPS Subpart F-I | Revised rule text

~~(c) A safety belt with a diagonal shoulder strap for aeroplanes with a maximum certificated take-off mass not exceeding 5 700 kg or a safety belt for aeroplanes with a maximum certificated take off mass not exceeding 2 730 kg may be permitted in place of a safety belt with shoulder harness if it is not reasonably practicable to fit the latter.~~

Comment [V45]: Deleted as relief for smaller aeroplanes provided in EU-OPS 1.730 (c) is not in line legal principles. This will be subject to an Art 14 derogation demonstrating an equivalent level of protection and justifying what is "not reasonably practicable". Further explanation is provided in the explanatory note.

CAT.IDE.A.210~~OPS 1.731~~ Fasten sSeat belt and nNo sSmoking signs

~~An operator shall not operate an~~ **Aeroplanes** in which all passenger seats are not visible from the flight deck ~~crew seat(s), unless it is~~ **shall be** equipped with a means of indicating to all passengers and cabin crew when seat belts shall be fastened and when smoking is not allowed.

CAT.IDE.A.215~~OPS 1.735~~ Internal doors and curtains

~~An operator shall not operate an aeroplane unless the following equipment is installed:~~

Formatted: Normal

(a) ~~In an aeroplanes with a maximum approved passenger seating configuration of more than 19 passengers~~ **shall be equipped with:**

(1) in the case of aeroplanes with an MPSC of more than 19, a door between the passenger compartment and the flight deck ~~crew~~ compartment, with a placard **indicating** "crew only" and a locking means to prevent passengers from opening it without the permission of a member of the flight crew;

(b2) aA readily accessible means for opening each door that separates a passenger compartment from another compartment that has emergency exits ~~provisions. The means for opening must be readily accessible;~~

(3e) If it is necessary to pass through ~~aa means for securing in open position~~ **any** doorway or curtain separating the passenger cabin from other areas **that need to be accessed** to reach any required emergency exit from any passenger seat; ~~the door or curtain must have a means to secure it in the open position;~~

(4) Aa placard on each internal door or adjacent to a curtain that is the means of access to a passenger emergency exit, to indicate that it must be secured open during take off and landing; and

(5e) Aa means for any member of the crew to unlock any door that is normally accessible to passengers and that can be locked by passengers.

CAT.IDE.A.220~~OPS 1.745~~ First-aAid kKits

(a) ~~An operator shall not operate an~~ **Aeroplanes** ~~unless it is~~ **shall be** equipped with first-aid kits, **in accordance with Table 1.** ~~readily accessible for use, to the following scale:~~

Table 1: Number of first-aid kits required

Number of passenger seats installed	Number of first-aid kits required
-------------------------------------	-----------------------------------

EU-OPS Subpart F-I | Revised rule text

0 - 100	1
101 to 200 199	2
201 to 300 299	3
301 - 400 300 and more	4
401-500	5
501 or more	6

(b) ~~First-aid kits shall be~~An operator shall ensure that first-aid kits are:

- (1) readily accessible for use;**
- (2) carried in a way that prevents unauthorised access; and**
- (3) kept up-to-date.**

~~(1) Inspected periodically to confirm, to the extent possible, that contents are maintained in the condition necessary for their intended use; and~~

CAT.IDE.A.225~~OPS 1.755~~ Emergency mMedical kit

(a) ~~An operator shall not operate an~~**Aeroplanes** with an **MPSC** ~~maximum approved passenger seating configuration of more than 30 seats unless it is~~**shall be** equipped with an emergency medical kit ~~if~~**when** any point on the planned route is more than 60 minutes' flying time (at normal cruising speed) from an aerodrome at which qualified medical assistance could be expected to be available.

(b) The commander shall ensure that drugs are ~~not~~**only** administered ~~except by~~**appropriately** qualified ~~doctors, nurses or similarly qualified personnel~~**persons**.

Comment [GC146]: This persons are defined in a new AMC

(c) ~~Conditions for carriage~~**The emergency medical kit referred to in (a) above shall be:**

(1) ~~The emergency medical kit must be~~ dust and moisture proof;

(2) carried in a way that prevents unauthorised access, ~~where practicable, on the flight deck; and~~

(3) kept up-to-date. ~~An operator shall ensure that emergency medical kits are:~~

~~(i) Inspected periodically to confirm, to the extent possible, that the contents are maintained in the condition necessary for their intended use; and~~

~~(ii) Replenished at regular intervals, in accordance with instructions contained on their labels, or as circumstances warrant.~~

Comment [V47]: Moved to AMC.

CAT.IDE.A.230~~OPS 1.760~~ First-aid oxygen

(a) ~~An operator shall not operate a~~**Pressurised aeroplanes operated at pressure** altitudes above 25 000 ft, ~~when~~**in the case of operations for which** a cabin crew member is required ~~to be carried, unless it is~~**shall be** equipped with a supply of undiluted oxygen for passengers who, for physiological reasons, might require oxygen following a cabin depressurisation.

EU-OPS Subpart F-I | Revised rule text

- (b) The amount of oxygen **supply referred to in (a) above** shall be calculated using an average flow rate of at least 3 litres ~~Standard Temperature Pressure Dry~~ (STPD)/minute/person. ~~and~~ **This oxygen supply** shall be sufficient for the remainder of the flight after cabin depressurisation when the cabin altitude exceeds 8 000 ft but does not exceed 15 000 ft, for at least 2 % of the passengers carried, but in no case for less than one person.
- (c) There shall be a sufficient number of dispensing units, but in no case less than two, with a means for cabin crew to use the supply. ~~The dispensing units may be of a portable type.~~
- ~~(b) The amount of first aid oxygen required for a particular operation shall be determined on the basis of cabin pressure altitudes and flight duration, consistent with the operating procedures established for each operation and route.~~
- (de) The **first-aid** oxygen equipment ~~provided~~ shall be capable of generating a mass flow to each user of at least ~~four~~ 4 litres per minute, STPD. ~~Means may be provided to decrease the flow to not less than two litres per minute, STPD, at any altitude.~~

Comment [V48]: Moved to GM1
CAT.IDE.A.230

Comment [GCI49]: Moved to GM1
CAT.IDE.A.230

CAT.IDE.A.235 ~~OPS 1.770~~ Supplemental oxygen – pressurised aeroplanes

(See Appendix 1 to OPS 1.770)

(a) General

~~(1) An operator shall not operate a P~~ **pressurised aeroplanes operated** at pressure altitudes above 10 000 ft ~~unless~~ **shall be equipped with** supplemental oxygen equipment, capable of storing and dispensing the oxygen supplies ~~required by this paragraph, is provided~~ **in accordance with Table 1.**

~~(2) The amount of supplemental oxygen required shall be determined on the basis of cabin pressure altitude, flight duration and the assumption that a cabin pressurisation failure will occur at the altitude or point of flight that is most critical from the standpoint of oxygen need, and that, after the failure, the aeroplane will descend in accordance with emergency procedures specified in the Aeroplane Flight Manual to a safe altitude for the route to be flown that will allow continued safe flight and landing.~~

Comment [V50]: Moved to AMC1
CAT.IDE.A.235

~~(3) Following a cabin pressurisation failure, the cabin pressure altitude shall be considered the same as the aeroplane pressure altitude, unless it is demonstrated to the Authority that no probable failure of the cabin or pressurisation system will result in a cabin pressure altitude equal to the aeroplane pressure altitude. Under these circumstances, the demonstrated maximum cabin pressure altitude may be used as a basis for determination of oxygen supply.~~

Comment [V51]: Moved to AMC1
CAT.IDE.A.235

(b) Oxygen equipment and supply requirements

(1) Flight crew members

- (i) Each member of the flight crew on flight deck duty shall be supplied with supplemental oxygen in accordance with Appendix 1. ~~If all occupants of flight deck seats are supplied from the flight crew source of oxygen supply then they shall be considered as flight crew members on flight deck duty for the purpose of oxygen supply. Flight deck seat occupants,~~

EU-OPS Subpart F-I | Revised rule text

~~not supplied by the flight crew source, are to be considered as passengers for the purpose of oxygen supply.~~

- ~~(ii) Flight crew members, not covered by subparagraph (b)(1)(i) above, are to be considered as passengers for the purpose of oxygen supply.~~
- ~~(iii) Oxygen masks shall be located so as to be within the immediate reach of flight crew members whilst at their assigned duty station.~~

Formatted: N (i)

Comment [V52]: Moved to AMC2 CAT.IDE.A.235

Formatted: Indent: Hanging: 0,95 cm, Space Before: 6 pt, After: 6 pt

(b) Pressurised aeroplanes operated at pressure altitudes above 25 000 ft shall be equipped with:

~~(1)(iv) Oxygen masks for use by flight crew members in pressurised aeroplanes operating above 25 000 ft shall be a quick donning types of masks for flight crew members;~~

~~(2) (2)-sufficient spare outlets and masks, or portable oxygen units with masks distributed evenly throughout the cabin, to ensure immediate availability of oxygen for use by each required cabin crew member; Cabin crew members, additional crew members and passengers~~

~~(i) Cabin crew members and passengers shall be supplied with supplemental oxygen in accordance with Appendix 1, except when subparagraph (v) below applies. Cabin crew members carried in addition to the minimum number of cabin crew members required, and additional crew members, shall be considered as passengers for the purpose of oxygen supply.~~

Comment [V53]: Moved to AMC2 CAT.IDE.A.235

~~(3) an oxygen dispensing unit connected to oxygen supply terminals immediately available to each cabin crew member, additional crew member and occupants of passenger seats, wherever seated; and (ii) Aeroplanes intended to be operated at pressure altitudes above 25 000 ft shall be provided with sufficient spare outlets and masks and/or sufficient portable oxygen units with masks for use by all required cabin crew members. The spare outlets and/or portable oxygen units are to be distributed evenly throughout the cabin to ensure immediate availability of oxygen to each required cabin crew member regardless of his/her location at the time of cabin pressurisation failure.~~

~~(4) a device to provide a warning indication to the flight crew of any loss of pressurisation.~~

~~(iii) Aeroplanes intended to be operated at pressure altitudes above 25 000 ft shall be provided with an oxygen dispensing unit connected to oxygen supply terminals immediately available to each occupant, wherever seated. The total number of dispensing units and outlets shall exceed the number of seats by at least 10 %. The extra units are to be evenly distributed throughout the cabin.~~

Comment [V54]: See (e) below

(c) In the case of pressurised aeroplanes first issued with an individual C of A after 8 November 1998 and operated at pressure altitudes above 25 000 ft, or operated at pressure altitudes at, or below 25 000 ft under conditions that would not allow them to descend safely to 13 000 ft within 4 minutes, the individual oxygen dispensing units referred to in (b)(3) above shall be automatically deployable.

EU-OPS Subpart F-I | Revised rule text

~~(iv) Aeroplanes intended to be operated at pressure altitudes above 25 000 ft or which, if operated at or below 25 000 ft, cannot descend safely within 4 minutes to 13 000 ft, and for which the individual certificate of airworthiness was first issued on or after 9 November 1998, shall be provided with automatically deployable oxygen equipment immediately available to each occupant, wherever seated. The total number of dispensing units and outlets shall exceed the number of seats by at least 10 %. The extra units are to be evenly distributed throughout the cabin.~~

- (d) The total number of dispensing units and outlets referred to in (b)(3) and (c) above shall exceed the number of seats by at least 10 %. The extra units shall be evenly distributed throughout the cabin.**
- (e) Notwithstanding (a), the oxygen supply requirements for cabin crew member(s), additional crew member(s) and passenger(s), in the case of**
~~(v) The oxygen supply requirements, as specified in Appendix 1, for aeroplanes not certificated to fly at altitudes above 25 000 ft, may be reduced to the entire flight time between 10 000 ft and 13 000 ft cabin pressure altitudes for all required cabin crew members and for at least 10 % of the passengers if, at all points along the route to be flown, the aeroplane is able to descend safely within 4 minutes to a cabin pressure altitude of 13 000 ft.~~
- (f) The required minimum supply in Table 1, row 1 item (b)(1) and row 2, shall cover the quantity of oxygen necessary for a constant rate of descent from the aeroplane's maximum certificated operating altitude to 10 000 ft in 10 minutes and followed by 20 minutes at 10 000 ft.**
- (g) The required minimum supply in Table 1, row 1 item 1(b)(2), shall cover the quantity of oxygen necessary for a constant rate of descent from the aeroplane's maximum certificated operating altitude to 10 000 ft in 10 minutes followed by 110 minutes at 10 000 ft.**
- (h) The required minimum supply in Table 1, row 3, shall cover the quantity of oxygen necessary for a constant rate of descent from the aeroplane's maximum certified operating altitude to 15 000 ft in 10 minutes.**

Table 1: Oxygen minimum requirements for pressurised aeroplanes

Supply for:	Duration and cabin pressure altitude
1. Occupants of flight crew compartment seats on flight crew compartment duty	<p>(a) The entire flight time when the cabin pressure altitude exceeds 13 000 ft.</p> <p>(b) The remainder of the flight time when the cabin pressure altitude exceeds 10 000 ft but does not exceed 13 000 ft, after the initial 30 minutes at these altitudes, but in no case less than:</p> <p>(1) 30 minutes' supply for aeroplanes certificated to fly at altitudes not exceeding 25 000 ft; and</p> <p>(2) 2 hours' supply for aeroplanes certificated to fly at altitudes of more than 25 000 ft.</p>
2. Required cabin crew	(a) The entire flight time when the cabin pressure altitude

EU-OPS Subpart F-I | Revised rule text

Supply for:	Duration and cabin pressure altitude
members	<p>exceeds 13 000 -ft, but not less than 30 minutes' supply.</p> <p>(b) The remainder of the flight time when the cabin pressure altitude exceeds 10 000 ft but does not exceed 13 000 ft, after the initial 30 minutes at these altitudes.</p>
3. 100 % of passengers *	The entire flight time when the cabin pressure altitude exceeds 15 000 -ft, but in no case less than 10 minutes' supply.
4. 30 % of passengers *	The entire flight time when the cabin pressure altitude exceeds 14 000 ft but does not exceed 15 000 ft.
5. 10 % of passengers *	The remainder of the flight time when the cabin pressure altitude exceeds 10 000 ft but does not exceed 14 000 ft, after the initial 30 minutes at these altitudes.

* Passenger numbers in Table 1 refer to passengers actually carried on board, including persons younger than 24 months.

**CAT.IDE.A.240OPS-1.775 Supplemental oxygen – nNon-pressurised aeroplanes
(See Appendix 1 to OPS 1.775)**

(a) ~~(a)~~ General

~~(1) An operator shall not operate a~~ **Nnon-pressurised aeroplanes operated at pressure altitudes above 10 000 ft shall be equipped unless with supplemental oxygen equipment, capable of storing and dispensing the oxygen supplies in accordance with Table 1**

Table 1: Oxygen minimum requirements for non-pressurised aeroplanes

Supply for:	Duration and cabin pressure altitude
1. Occupants of flight crew compartment seats on flight crew compartment duty and crew members assisting flight crew in their duties	The entire flight time at pressure altitudes above 10 000 ft.
2. Required cabin crew members	The entire flight time at pressure altitudes above 13 000ft and for any period exceeding 30 minutes at pressure altitudes between above 10 000 ft and but not exceeding 13 000 ft.
3. Additional crew members and 100 % of passengers *	The entire flight time at pressure altitudes above 13 000ft.
4. 10 % of passengers *	The entire flight time after 30 minutes at pressure altitudes greater than 10 000 ft but not exceeding 13 000ft.

EU-OPS Subpart F-I | Revised rule text

(b) Passenger numbers in Table 1 refer to passengers actually carried on board, including persons younger than 24 months.

required, is provided.

~~(2) The amount of supplemental oxygen for sustenance required for a particular operation shall be determined on the basis of flight altitudes and flight duration, consistent with the operating procedures established for each operation in the Operations Manual and with the routes to be flown, and with the emergency procedures specified in the Operations Manual.~~

Comment [V55]: Moved to AMC.

~~(3) An aeroplane intended to be operated at pressure altitudes above 10 000 ft shall be provided with equipment capable of storing and dispensing the oxygen supplies required.~~

~~(b) Oxygen supply requirements~~

~~(1) Flight crew members. Each member of the flight crew on flight deck duty shall be supplied with supplemental oxygen in accordance with Appendix 1. If all occupants of flight deck seats are supplied from the flight crew source of oxygen supply then they shall be considered as flight crew members on flight deck duty for the purpose of oxygen supply.~~

~~(2) Cabin crew members, additional crew members and passengers. Cabin crew members and passengers shall be supplied with oxygen in accordance with Appendix 1. Cabin crew members carried in addition to the minimum number of cabin crew members required, and additional crew members, shall be considered as passengers for the purpose of oxygen supply.~~

Comment [V56]: Included in the table.

CAT.IDE.A.245OPS-1.780 Crew pProtective bBreathing eEquipment

~~(a) An operator shall not operate a Ppressurised aeroplanes or an unpressurised aeroplanes with an MCTOM maximum certificated take-off mass exceeding of more than 5 700 kg or having an MPSC maximum approved seating configuration of more than 19 seats unless shall be equipped with protective breathing equipment (PBE) to protect the eyes, nose and mouth and to provide for a period of at least 15 minutes:~~

~~(1) It has equipment to protect the eyes, nose and mouth of each flight crew member while on flight deck duty and to provide oxygen for each flight crew member on duty in the flight crew compartment; for a period of not less than 15 minutes. The supply for Protective Breathing Equipment (PBE) may be provided by the supplemental oxygen required by OPS 1.770 (b)(1) or OPS 1.775 (b)(1). In addition, when the flight crew is more than one and a cabin crew member is not carried, portable PBE must be carried to protect the eyes, nose and mouth of one member of the flight crew and to provide breathing gas for a period of not less than 15 minutes; and~~

~~(2) It has sufficient portable PBE to protect the eyes, nose and mouth of all required cabin crew members and to provide breathing gas for each required cabin crew member, adjacent to their duty station; and a period of not less than 15 minutes.~~

EU-OPS Subpart F-I | Revised rule text

- (3) breathing gas from a portable PBE for one member of the flight crew, adjacent to their duty station, in the case of aeroplanes operated with a flight crew of more than one and no cabin crew member.**
- (b) **A** PBE intended for flight crew use ~~must~~**shall** be conveniently ~~installed~~ located ~~in~~ the flight deck ~~crew compartment~~ and be easily accessible for immediate use by each required flight crew member at their assigned duty station.
- (c) **A** PBE intended for cabin crew use ~~must~~**shall** be installed adjacent to each required cabin crew member duty station.
- (d) **Aeroplanes shall be equipped with a** ~~An additional, easily accessible portable PBE must be provided and located~~ **installed** at or adjacent to the hand fire extinguishers **referred to in CAT.IDE.A.250, or** ~~required by OPS 1.790 (c) and (d) except that, where the fire extinguisher is located inside a cargo compartment, the PBE must be stowed outside but~~ adjacent to the entrance to ~~that of the cargo compartment,~~ **in case the hand fire extinguisher installed inside a cargo compartment.**
- (e) **A** PBE while in use ~~must~~**shall** not prevent **the use of the means of communication** ~~where required~~ **referred to in** ~~by~~ **CAT.IDE.A.170** ~~OPS 1.685, CAT.IDE.A.175~~ ~~OPS 1.690, CAT.IDE.A.270~~ ~~OPS 1.810 and CAT.IDE.A.330~~ ~~OPS 1.850.~~

CAT.IDE.A.250 ~~OPS 1.790~~ **Hand fire extinguishers**

- (a) ~~An operator shall not operate a~~ **An aeroplanes shall be equipped with at least one** ~~unless hand fire extinguisher s are provided for use in crew, passenger and, as applicable, cargo compartments and galleys in accordance with the following:~~ **in the flight crew compartment.**
- ~~(a) The type and quantity of extinguishing agent must be suitable for the kinds of fires likely to occur in the compartment where the extinguisher is intended to be used and, for personnel compartments, must minimise the hazard of toxic gas concentration;~~
- (b) ~~At least one hand fire extinguisher, containing Halon 1211 (bromochlorodifluoro methane, CBrClF₂), or equivalent as the extinguishing agent, must be conveniently located on the flight deck for use by the flight crew;~~
- (be) At least one hand fire extinguisher ~~must~~**shall** be located in, or readily accessible for use in, each galley not located on the main passenger deck.
- (cd) At least one ~~readily accessible~~ hand fire extinguisher ~~must~~**shall** be available for use in each ~~c~~Class A or Class **class** B cargo or baggage compartment and in each ~~Class~~ **class** E cargo compartment that is accessible to crew members in flight;
- (d) **The type and quantity of extinguishing agent for the required fire extinguishers shall be suitable for the type of fire likely to occur in the compartment where the extinguisher is intended to be used and to minimise the hazard of toxic gas concentration in compartments occupied by persons.**
- (e) **Aeroplanes shall be equipped with at least a number of hand fire extinguishers in accordance with Table 1, conveniently located to provide adequate availability for use in each passenger.**

Comment [GC157]: Now paragraph (d) below

Comment [V58]: Deleted EC 1005/2009 regulation will forbid the use of Halon

Table 1: Number of hand fire extinguishers

~~(e) — At least the following number of hand fire extinguishers must be conveniently located in the passenger compartment(s):~~

Maximum passenger seating configuration	Number of Extinguishers
7 to 30	1
31 to 60	2
61 to 200	3
201 to 300	4
301 to 400	5
401 to 500	6
501 to 600	7
601 or more	8

~~When two or more extinguishers are required, they must be evenly distributed in the passenger compartment.~~ ~~(f) — At least one of the required fire extinguishers located in the passenger compartment of an aeroplane with a maximum approved passenger seating configuration of at least 31, and not more than 60, and at least two of the fire extinguishers located in the passenger compartment of an aeroplane with a maximum approved passenger seating configuration of 61 or more must contain Halon 1211 (bromochlorodifluoromethane, CBrClF₂), or equivalent as the extinguishing agent.~~

Comment [V59]: Deleted EC 1005/2009 regulation will forbid the use of Halon

CAT.IDE.A.255 ~~OPS 1.795~~ Crash axes and crowbars

- (a) ~~An operator shall not operate an~~ ~~Aeroplanes~~ with an **MCTOM** maximum certificated take-off mass exceeding 5 700 kg, **or with** having an **MPSC** maximum approved passenger seating configuration of more than 9 seats ~~unless it is~~ **shall be** equipped with at least one crash axe or crowbar located ~~in the flight deck~~ **crew compartment.**
- (b) ~~If~~ ~~In the case of aeroplanes with the~~ ~~an~~ **MPSC** maximum approved passenger seating configuration is ~~of~~ more than ~~200~~ **200**, an additional crash axe or crowbar must **shall** be carried and located ~~installed~~ **installed** in or near the ~~most rearward~~ **rear** most galley area.

~~(b) — Crash axes and crowbars located in the passenger compartment must not be visible to passengers.~~ CAT.IDE.A.260 ~~OPS 1.800~~ Marking of break-in points

If areas of the aeroplane's fuselage suitable for break-in by rescue crews in an emergency are marked, such areas shall be marked as shown in Figure 1.

Figure 1: Marking of break-in points

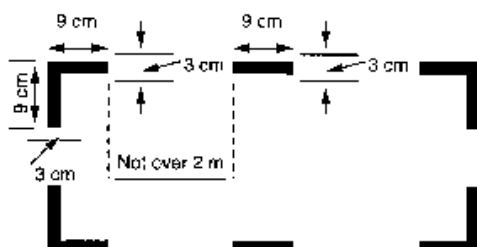

An operator shall ensure that, if designated areas of the fuselage suitable for break-in by rescue crews in emergency are marked on an aeroplane, such areas shall be marked as shown below. The colour of the markings shall be red or yellow, and if necessary they shall be outlined in white to contrast with the background. If the corner markings are more than 2 metres apart, intermediate lines 9 cm x 3 cm shall be inserted so that there is no more than 2 metres between adjacent marks.

Comment [V60]: Moved to AMC

CAT.IDE.A.265OPS-1.805 Means for emergency evacuation

- (a) An operator shall not operate an ~~a~~Aeroplanes with passenger emergency exit sill heights ÷
- (1) ~~Which are of~~ more than 1,783 metres (6 feet) above the ground **shall be equipped at each of those exits with a means to enable passengers and crew to reach the ground safely in an emergency.** ~~with the aeroplane on the ground and the landing gear extended; or~~
 - (2) ~~Which would be more than 1,83 metres (6 feet) above the ground after the collapse of, or failure to extend of, one or more legs of the landing gear and for which a Type Certificate was first applied for on or after 1 April 2000,~~
- unless it has equipment or devices available at each exit, where subparagraphs (1) or (2) apply, to enable passengers and crew to reach the ground safely in an emergency.
- (b) **Notwithstanding (a) above, s**Such equipment ~~means or devices~~**are not required** at overwing exits if the designated place on the aeroplane structure at which the escape route terminates is less than 1,783 metres (**6 ft**~~6 feet~~) from the ground with the aeroplane on the ground, the landing gear extended, and the flaps in the take off or landing position, whichever flap position is higher from the ground.
- (c) ~~In a~~Aeroplanes required to have a separate emergency exit for the flight crew and ÷
- (1) ~~F~~for which the lowest point of the emergency exit is more than 1,783 metres (6 feet) above the ground **shall** ~~with the landing gear extended; or,~~
 - (2) ~~For which a Type Certificate was first applied for on or after 1 April 2000,~~ would be more than 1,83 metres (6 ft) above the ground after the collapse of, or failure to extend of, one or more legs of the landing gear,

Formatted: N (a)

Formatted: N (a)

EU-OPS Subpart F-I | Revised rule text

~~there must be a device~~ **have a means** to assist all ~~members of the flight crew~~ **members** in descending to reach the ground safely in an emergency.

(d) The heights referred to in (a) and (c) above shall be measured:

(1) with the landing gear extended; and

(2) after the collapse of, or failure to extend of, one or more legs of the landing gear, in the case of aeroplanes with a type certificate issued after 31 March 2000.

CAT.IDE.A.270~~OPS 1.810~~ Megaphones

~~(a) An operator shall not operate an a~~ **Aeroplanes with an MPSC** maximum approved passenger seating configuration of more than 60 and carrying **at least** one passenger ~~unless it is~~ **shall be** equipped with portable battery-powered megaphones readily accessible for use by crew members during an emergency evacuation, ~~to the following scales~~ **in accordance with Table 1.**

(1) For each passenger deck: Passenger seating configuration	
61 to 99	1
100 or more	2

~~(2) For aeroplanes with more than one passenger deck, in all cases when the total passenger seating configuration is more than 60, at least 1 megaphone is required.~~

Table 1: Number of megaphones

Maximum passenger seating configuration	Number of Megaphones
61 to 99	1
100 or more	2
more than one passenger deck, in all cases when more than 60	1

CAT.IDE.A.275~~OPS 1.815~~ Emergency lighting and marking

~~(a) An operator shall not operate a passenger carrying a~~ **Aeroplanes which has with an MPSC** maximum approved passenger seating configuration of more than **nine** ~~unless it is provided~~ **shall be equipped** with an emergency lighting system having an independent power supply to facilitate the evacuation of the aeroplane.

(b) In the case of aeroplanes with an MPSC of more than 19, the ~~The~~ emergency lighting system, ~~referred to in (a) above, must~~ **shall** include:

EU-OPS Subpart F-I | Revised rule text

- (1) ~~For aeroplanes which have a maximum approved passenger seating configuration of more than 19:~~
- ~~(i) Sources of general cabin illumination;~~
 - ~~(2ii) Internal lighting in floor level emergency exit areas;~~
 - ~~and~~
 - ~~(iii) Illuminated emergency exit marking and locating signs;~~
 - ~~(4iv) For in the case of aeroplanes for which the application for the type certificate or equivalent was filed before 1 May 1972, and when flying operated by night, exterior emergency lighting at all overwing exits, and at exits where descent assist means are required;~~
 - ~~(v5) For in the case of aeroplanes for which the application for the type certificate or equivalent was filed on or after 30 May April 1972, and when flying operated by night, exterior emergency lighting at all passenger emergency exits; and~~
 - ~~(6vi) For in the case of aeroplanes for which the type certificate was first issued on or after 31 December 1957 1 January 1958, floor proximity emergency escape path marking system(s) in the passenger compartment(s).~~
- (c2) ~~For In the case of aeroplanes which with have an MPSC maximum approved passenger seating configuration of 19 or less and type certified on the basis of the Agency's airworthiness codes, the emergency lighting system, referred to in (a) above, shall include the equipment referred to in (b)(1), to (3) above.~~ are certificated to the Certification Specifications in CS-25 or CS-23:
- ~~(i) Sources of general cabin illumination;~~
 - ~~(ii) Internal lighting in emergency exit areas; and~~
 - ~~(iii) Illuminated emergency exit marking and locating signs.~~
- ~~(d) In the case of (3) For aeroplanes which with have an MPSC maximum approved passenger seating configuration of 19 or less that are not certified on the basis of the Agency's airworthiness codes are not certificated to the Certification Specifications in CS-25 or CS-23, s, the emergency lighting system, referred to in (a) above, shall include the equipment referred to in sources of general cabin illumination. (b)(1).~~
- ~~(eb) Aeroplanes with an MPSC of nine or less, An operator shall not, operated by night, operate a passenger carrying aeroplane which has a maximum approved passenger seating configuration of 9 or less unless it is provided shall be equipped with a source of general cabin illumination to facilitate the evacuation of the aeroplane. The system may use dome lights or other sources of illumination already fitted on the aeroplane and which are capable of remaining operative after the aeroplane's battery has been switched off.~~

CAT.IDE.A.280OPS-1.820 Emergency Locator Transmitter (ELT)

- (a) ~~Aeroplanes with an MPSC of more than 19 shall be~~ An operator shall not operate an aeroplane authorized to carry more than 19 passengers unless it is equipped with at least:

EU-OPS Subpart F-I | Revised rule text

- ~~(1) one automatic Emergency Locator Transmitter (ELT) or two ELTs of any type; or~~
- ~~(12) two ELTs, one of which shall be automatic, for-in the case of aeroplanes first issued with an individual certificate of airworthiness C of A after 1 July 2008; or~~
- (2) one automatic ELT or two ELTs of any type, in the case of aeroplanes first issued with an individual C of A on or before 1 July 2008.**
- (b) **Aeroplanes with an MPSC of 19 or less shall be**~~An operator shall not operate an aeroplane authorized to carry 19 passengers or less unless it is equipped with at least:~~
- ~~(1) one ELT of any type; or~~
- ~~(12) one automatic ELT, for-in the case of aeroplanes first issued with an individual certificate of airworthiness C of A after 1 July 2008; or~~
- (2) one ELT of any type, in the case of aeroplanes first issued with an individual C of A on or before 1 July 2008.**
- (c) **An ELT shall be capable of transmitting simultaneously on 121.5 MHz and 406 MHz.**~~An operator shall ensure that all ELTs carried to satisfy the above requirements operate in accordance with the relevant provisions of ICAO Annex 10, Volume III.~~

CAT.IDE.A.285 Flight over water~~OPS 1.825 Life Jackets~~

- (a) Land aeroplanes ~~. An operator shall not operate a land aeroplane:~~ **operated**~~(1) —When flying over water and at a distance of more than 50 nautical miles NM from the shore; or~~
- ~~(2) —When taking off or landing at an aerodrome where the take-off or approach path is so disposed over water that in the event of a mishap there would be a likelihood of a ditching, and seaplanes operated overwater, shall be unless it is equipped with a life-jacket for each person on board equipped with a survivor locator light, for each person on board. Each life jacket must be stowed in a position easily accessible from the seat or berth of the person for whose use it is provided. Life jackets for infants may be substituted by other approved or equivalent flotation devices for each person on board younger than 24 months, stowed in a position which that is readily accessible from the seat or berth of the person for whose use it is provided.~~**equipped with a survivor locator light.**
- (b) Each life-jacket or equivalent individual flotation device shall be equipped with a means of electric illumination for the purpose of facilitating the location of persons.**
- (cb) Seaplanes and amphibians. ~~An operator shall not operate a seaplane or an amphibian~~ **operated on over water unless it shall be** equipped with: ~~life jackets equipped with a survivor locator light, for each person on board. Each life jacket must be stowed in a position easily accessible from the seat or berth of the person for whose use it is provided. Life jackets for infants may be substituted by other approved flotation devices equipped with a survivor locator light.~~

EU-OPS Subpart F-I | Revised rule text

- (1) ~~A~~ sea anchor and other equipment necessary to facilitate mooring, anchoring or manoeuvring the aircraft on water, appropriate to its size, weight and handling characteristics; and
- (2) ~~Equipment~~ **equipment** for making the sound signals **as** prescribed in the International Regulations for ~~p~~**P**reventing ~~C~~**C**ollisions at ~~s~~**S**ea, where applicable.

OPS 1.830 Life rafts and survival ELTs for extended overwater flights

- (d) ~~Aeroplanes operated over water~~ On overwater flights, an operator shall not operate an aeroplane at a distance away from land, which is suitable for making an emergency landing, greater than that corresponding to:-

- (1) ~~(1)~~ 120 minutes at cruising speed or 400 ~~nautical miles~~ **NM**, whichever is the lesser, ~~for~~ **in the case of** aeroplanes capable of continuing the flight to an aerodrome with the critical ~~engine power unit(s)~~ **engine power unit(s)** becoming inoperative at any point along the route or planned diversions; ~~or~~ **or**
- (2) ~~(2)~~ **for all other aeroplanes**, 30 minutes at cruising speed or 100 ~~nautical miles~~ **NM**, whichever is the lesser,

~~unless the equipment specified in subparagraphs (b) and (c) below is carried.~~ **shall be equipped with:**

- ~~(1b)~~ **life-saving rafts in sufficient numbers** Sufficient life rafts to carry all persons on board, **stowed so as to facilitate their ready use in emergency, and being of sufficient size to accommodate all the survivors in the event of a loss of one raft of the largest rated capacity;** ~~Unless excess rafts of enough capacity are provided, the buoyancy and seating capacity beyond the rated capacity of the rafts must accommodate all occupants of the aeroplane in the event of a loss of one raft of the largest rated capacity. The life rafts shall be equipped with:~~
 - ~~(1)~~ **a** survivor locator light **in each life-raft**; and
 - ~~(2)~~ **Life-saving equipment including** ~~to provides the means of~~ **for** sustaining life, as appropriate ~~to~~ **for** the flight to be undertaken; and
 - ~~(c)~~ **At least two survival E**mergency **L**ocator **T**ransmitters (ELT(S)) ~~capable of transmitting on the distress frequencies prescribed in ICAO Annex 10, Volume V, Chapter 2.~~

CAT.IDE.A.305OPS 1.835 Survival equipment

- (a) ~~An operator shall not operate an~~ **Aeroplanes operated across-over** areas in which **have been designated by a State as areas where** search and rescue would be especially difficult ~~unless it is~~ **shall be** equipped with the following:
- (1a) ~~S~~ signalling equipment to make the ~~pyrotechnical~~ distress signals ~~described in ICAO Annex 2;~~
 - (2b) ~~A~~ at least one ELT (S) ~~is capable of transmitting on the distress frequencies prescribed in ICAO Annex 10, Volume V, Chapter 2;~~ and
 - (3e) ~~A~~ additional survival equipment for the route to be flown taking account of the number of persons on board.

EU-OPS Subpart F-I | Revised rule text

(b) The additional survival equipment specified in (a)(3) does not need to be carried when the aeroplane:

- (1) Remains within a distance from an area where search and rescue is not especially difficult corresponding to:
 - (i) 120 minutes at the one engine inoperative (**OEI**) cruising speed for aeroplanes capable of continuing the flight to an aerodrome with the critical power unit engine(s) becoming inoperative at any point along the route or planned diversions routes; or
 - (ii) 30 minutes at cruising speed for all other aeroplanes, or
- (2) or, (2) — remains within a distance no greater than that corresponding to 90 minutes at cruising speed from an area suitable for making an emergency landing, for aeroplanes certificated in accordance with Regulation (EC) No 1702/2003. to the Certification Specifications in CS 25 or equivalent, no greater distance than that corresponding to 90 minutes at cruising speed from an area suitable for making an emergency landing.**

OPS 1.840 Seaplanes and amphibians — Miscellaneous equipment

~~(a) An operator shall not operate a seaplane or an amphibian on water unless it is equipped with:~~

- ~~(1) A sea anchor and other equipment necessary to facilitate mooring, anchoring or manoeuvring the aircraft on water, appropriate to its size, weight and handling characteristics; and~~
- ~~(2) Equipment for making the sound signals prescribed in the International Regulations for preventing collisions at sea, where applicable.~~

Formatted: Indent: First line: 0 cm, Space Before: 6 pt, After: 6 pt

Appendix 1 to OPS 1.715 Flight data recorders — 1 — List of parameters to be recorded

Table A1 — Aeroplanes with a maximum certificated take off mass of over 5 700 kg

Note: The number in the left hand column reflect the Serial Numbers depicted in EUROCAE document ED55

No — PARAMETER

1 — TIME OR RELATIVE TIME COUNT

2 — PRESSURE ALTITUDE

3 — INDICATED AIRSPEED

4 — HEADING

5 — NORMAL ACCELERATION

6 — PITCH ATTITUDE

7 — ROLL ATTITUDE

8 — MANUAL RADIO TRANSMISSION KEYING

9 — PROPULSIVE THRUST/ POWER ON EACH ENGINE AND COCKPIT THRUST/POWER LEVER POSITION IF APPLICABLE

10 — TRAILING EDGE FLAP OR COCKPIT CONTROL SELECTION

Comment [V61]: Moved to CAT.IDE.A.285 (c)

Formatted: Indent: First line: 0 cm, Space Before: 6 pt, After: 6 pt

Formatted: Normal

EU-OPS Subpart F-I | Revised rule text

- ~~11 — LEADING EDGE FLAP OR COCKPIT CONTROL SELECTION~~
- ~~12 — THRUST REVERSE STATUS~~
- ~~13 — GROUND SPOILER POSITION AND/OR SPEED BRAKE SELECTION~~
- ~~14 — TOTAL OR OUTSIDE AIR TEMPERATURE~~
- ~~15 — AUTOPILOT, AUTOTHROTTLE AND AFCS MODE AND ENGAGEMENT STATUS~~
- ~~16 — LONGITUDINAL ACCELERATION (BODY AXIS)~~
- ~~17 — LATERAL ACCELERATION~~

~~Table A2 — Aeroplanes with a maximum certificated take-off mass of 5 700 kg or below~~

Formatted: Normal

~~Note: The number in the left hand column reflect the Serial Numbers depicted in EUROCAE document ED55~~

- ~~No — PARAMETER~~
- ~~1 — TIME OR RELATIVE TIME COUNT~~
- ~~2 — PRESSURE ALTITUDE~~
- ~~3 — INDICATED AIRSPEED~~
- ~~4 — HEADING~~
- ~~5 — NORMAL ACCELERATION~~
- ~~6 — PITCH ATTITUDE~~
- ~~7 — ROLL ATTITUDE~~
- ~~8 — MANUAL RADIO TRANSMISSION KEYING~~
- ~~9 — PROPULSIVE THRUST/ POWER ON EACH ENGINE AND COCKPIT THRUST/POWER LEVER POSITION IF APPLICABLE~~
- ~~10 — TRAILING EDGE FLAP OR COCKPIT CONTROL SELECTION~~
- ~~11 — LEADING EDGE FLAP OR COCKPIT CONTROL SELECTION~~
- ~~12 — THRUST REVERSE STATUS~~
- ~~13 — GROUND SPOILER POSITION AND/OR SPEED BRAKE SELECTION~~
- ~~14 — TOTAL OR OUTSIDE AIR TEMPERATURE.~~
- ~~15 — AUTOPILOT/AUTOTHROTTLE ENGAGEMENT STATUS~~
- ~~16 — ANGLE OF ATTACK (IF A SUITABLE SENSOR IS AVAILABLE)~~
- ~~17 — LONGITUDINAL ACCELERATION (BODY AXIS)~~

~~Table B — Additional parameters for aeroplanes with a maximum certificated take off mass of over 27 000 kg~~

~~Note: The number in the left hand column reflect the Serial Numbers depicted in EUROCAE document ED55~~

- ~~No — PARAMETER~~
- ~~18 — PRIMARY FLIGHT CONTROLS — CONTROL SURFACE POSITION AND/OR PILOT INPUT (PITCH, ROLL, YAW)~~

EU-OPS Subpart F-I | Revised rule text

- ~~19 — PITCH TRIM POSITION~~
- ~~20 — RADIO ALTITUDE~~
- ~~21 — VERTICAL BEAM DEVIATION (ILS GLIDE PATH OR MLS ELEVATION)~~
- ~~22 — HORIZONTAL BEAM DEVIATION (ILS LOCALISER OR MLS AZIMUTH)~~
- ~~23 — MARKER BEACON PASSAGE~~
- ~~24 — WARNINGS~~
- ~~25 — RESERVED (NAVIGATION RECEIVER FREQUENCY SELECTION IS RECOMMENDED)~~
- ~~26 — RESERVED (DME DISTANCE IS RECOMMENDED)~~
- ~~27 — LANDING GEAR SQUAT SWITCH STATUS OR AIR/GROUND STATUS~~
- ~~28 — GROUND PROXIMITY WARNING SYSTEM~~
- ~~29 — ANGLE OF ATTACK~~
- ~~30 — LOW PRESSURE WARNING (HYDRAULIC AND PNEUMATIC POWER)~~
- ~~31 — GROUNDSPEED~~
- ~~32 — LANDING GEAR OR GEAR SELECTOR POSITION~~

~~Table C — Aeroplanes equipped with electronic display systems~~

~~Note: The number in the centre column reflect the Serial Numbers depicted in EUROCAE document ED55 table A1.5~~

- | No | No | PARAMETER |
|---------------|---------------|---|
| 33 | 6 | SELECTED BAROMETRIC SETTING (EACH PILOT STATION) |
| 34 | 7 | SELECTED ALTITUDE |
| 35 | 8 | SELECTED SPEED |
| 36 | 9 | SELECTED MACH |
| 37 | 10 | SELECTED VERTICAL SPEED |
| 38 | 11 | SELECTED HEADING |
| 39 | 12 | SELECTED FLIGHT PATH |
| 40 | 13 | SELECTED DECISION HEIGHT |
| 41 | 14 | EFIS DISPLAY FORMAT |
| 42 | 15 | MULTI FUNCTION /ENGINE/ALERTS DISPLAY FORMAT |

~~Appendix 1 to OPS 1.720 Flight data recorders — 2 — List of parameters to be recorded~~

~~Table A — Aeroplanes with a maximum certificated take off mass of over 5 700 kg~~

- | No | PARAMETER |
|---------------|--|
| 1 | TIME OR RELATIVE TIME COUNT |
| 2 | PRESSURE ALTITUDE |
| 3 | INDICATED AIRSPEED |

Formatted: Normal

EU-OPS Subpart F-I | Revised rule text

- ~~4 — HEADING~~
 - ~~5 — NORMAL ACCELERATION~~
 - ~~6 — PITCH ATTITUDE~~
 - ~~7 — ROLL ATTITUDE~~
 - ~~8 — MANUAL RADIO TRANSMISSION KEYING UNLESS AN ALTERNATE MEANS TO SYNCHRONISE FDR AND CVR RECORDINGS IS PROVIDED~~
 - ~~9 — POWER ON EACH ENGINE~~
 - ~~10 — TRAILING EDGE FLAP OR COCKPIT CONTROL SELECTION~~
 - ~~11 — LEADING EDGE FLAP OR COCKPIT CONTROL SELECTION~~
 - ~~12 — THRUST REVERSE POSITION (FOR TURBOJET AEROPLANES ONLY)~~
 - ~~13 — GROUND SPOILER POSITION AND/OR SPEED BRAKE SELECTION~~
 - ~~14 — OUTSIDE AIR TEMPERATURE OR TOTAL AIR TEMPERATURE~~
 - ~~15a — AUTOPILOT ENGAGEMENT STATUS~~
 - ~~15b — AUTOPILOT OPERATING MODES, AUTOTHROTTLE AND AFCS SYSTEMS ENGAGEMENT STATUS AND OPERATING MODES.~~
- ~~Table B — Additional parameters for aeroplanes with a maximum certificated take-off mass over 27 000 kg~~
- ~~No — PARAMETER~~
 - ~~16 — LONGITUDINAL ACCELERATION~~
 - ~~17 — LATERAL ACCELERATION~~
 - ~~18 — PRIMARY FLIGHT CONTROLS — CONTROL SURFACE POSITION AND/OR PILOT INPUT (PITCH, ROLL AND YAW)~~
 - ~~19 — PITCH TRIM POSITION~~
 - ~~20 — RADIO ALTITUDE~~
 - ~~21 — GLIDE PATH DEVIATION~~
 - ~~22 — LOCALISER DEVIATION~~
 - ~~23 — MARKER BEACON PASSAGE~~
 - ~~24 — MASTER WARNING~~
 - ~~25 — NAV 1 AND NAV 2 FREQUENCY SELECTION~~
 - ~~26 — DME 1 AND DME 2 DISTANCE~~
 - ~~27 — LANDING GEAR SQUAT SWITCH STATUS~~
 - ~~28 — GROUND PROXIMITY WARNING SYSTEM~~
 - ~~29 — ANGLE OF ATTACK~~
 - ~~30 — HYDRAULICS, EACH SYSTEM (LOW PRESSURE)~~
 - ~~31 — NAVIGATION DATA~~
 - ~~32 — LANDING GEAR OR GEAR SELECTOR POSITION~~

EU-OPS Subpart F-I | Revised rule text

Appendix ~~1~~ to ~~OPS~~ ~~1.725~~
 Flight data recorders ~~3~~ List of parameters to be recorded

Table A ~~Aeroplanes with a maximum certificated take-off mass of over 5 700 kg~~

Formatted: Normal

No PARAMETER

~~1 TIME OR RELATIVE TIME COUNT~~

~~2 PRESSURE ALTITUDE~~

~~3 INDICATED AIRSPEED~~

~~4 HEADING~~

~~5 NORMAL ACCELERATION~~

Table B ~~Additional parameters for aeroplanes with a maximum certificated take-off mass of over 27 000 kg~~

No PARAMETER

~~6 PITCH ATTITUDE~~

~~7 ROLL ATTITUDE~~

~~8 MANUAL RADIO TRANSMISSION KEYING UNLESS AN ALTERNATE MEANS TO SYNCHRONISE THE FDR AND CVR RECORDINGS IS PROVIDED~~

~~9 POWER ON EACH ENGINE~~

~~10 TRAILING EDGE FLAP OR COCKPIT CONTROL SELECTION~~

~~11 LEADING EDGE FLAP OR COCKPIT CONTROL SELECTION~~

~~12 THRUST REVERSE POSITION (FOR TURBOJET AEROPLANES ONLY)~~

~~13 GROUND SPOILER POSITION AND/OR SPEED BRAKE SELECTION~~

~~14 OUTSIDE AIR TEMPERATURE OR TOTAL AIR TEMPERATURE~~

~~15a AUTOPILOT ENGAGEMENT STATUS~~

~~15b AUTOPILOT OPERATING MODES, AUTOTHROTTLE AND AFCS, SYSTEMS ENGAGEMENT STATUS AND OPERATING MODES.~~

~~16 LONGITUDINAL ACCELERATION~~

~~17 LATERAL ACCELERATION~~

~~18 PRIMARY FLIGHT CONTROLS — CONTROL SURFACE POSITION AND/OR PILOT INPUT (PITCH, ROLL AND YAW)~~

~~19 PITCH TRIM POSITION~~

~~20 RADIO ALTITUDE~~

~~21 GLIDE PATH DEVIATION~~

~~22 LOCALISER DEVIATION~~

~~23 MARKER BEACON PASSAGE~~

~~24 MASTER WARNING~~

~~25 NAV 1 AND NAV 2 FREQUENCY SELECTION~~

~~26 DME 1 AND DME 2 DISTANCE~~

EU-OPS Subpart F-I | Revised rule text

- 27 LANDING GEAR SQUAT SWITCH STATUS
- 28 GROUND PROXIMITY WARNING SYSTEM
- 29 ANGLE OF ATTACK
- 30 HYDRAULICS, EACH SYSTEM (LOW PRESSURE)
- 31 NAVIGATION DATA (LATITUDE, LONGITUDE, GROUND SPEED AND DRIFT ANGLE)
- 32 LANDING GEAR OR GEAR SELECTOR POSITION

Comment [V62]: Moved at AMC level

Appendix 1 to OPS 1.770 Oxygen Minimum Requirements for Supplemental Oxygen for Pressurised Aeroplanes during and following Emergency Descent

Table 1

Comment [V63]: Moved in Table 1 of CAT.IDE.315

Formatted: Normal

Formatted: Indent: First line: 0 cm, Space Before: 6 pt, After: 6 pt

(a)	(b)
SUPPLY FOR:	DURATION AND CABIN PRESSURE ALTITUDE
1. All occupants of flight deck seats on flight deck duty	Entire flight time when the cabin pressure altitude exceeds 13 000 ft and entire flight time when the cabin pressure altitude exceeds 10 000 ft but does not exceed 13 000 ft after the first 30 minutes at those altitudes, but in no case less than: (i) 30 minutes for aeroplanes certificated to fly at altitudes not exceeding 25 000 ft (Note 2) (ii) 2 hours for aeroplanes certificated to fly at altitudes more than 25 000 ft (Note 3).
2. All required cabin crew members	Entire flight time when cabin pressure altitude exceeds 13 000 ft but not less than 30 minutes (Note 2), and entire flight time when cabin pressure altitude is greater than 10 000 ft but does not exceed 13 000 ft after the first 30 minutes at these altitudes
3. 100 % of passengers (Note 5)	Entire flight time when the cabin pressure altitude exceeds 15 000 ft but in no case less than 10 minutes (Note 4).
4. 30 % of passengers (Note 5)	Entire flight time when the cabin pressure altitude exceeds 14 000 ft but does not exceed 15 000 ft
5. 10 % of passengers (Note 5).	Entire flight time when the cabin pressure altitude exceeds 10 000 ft but does not exceed 14 000 ft after the first 30 minutes at these altitudes

Note 1: The supply provided must take account of the cabin pressure altitude and descent profile for the routes concerned.

Formatted: N(notes)

EU-OPS Subpart F-I | Revised rule text

~~Note 2: The required minimum supply is that quantity of oxygen necessary for a constant rate of descent from the aeroplane's maximum certificated operating altitude to 10 000 ft in 10 minutes and followed by 20 minutes at 10 000 ft.~~

~~Note 3: The required minimum supply is that quantity of oxygen necessary for a constant rate of descent from the aeroplane's maximum certificated operating altitude to 10 000 ft in 10 minutes and followed by 110 minutes at 10 000 ft. The oxygen required in OPS 1.780 (a)(1) may be included in determining the supply required.~~

~~Note 4: The required minimum supply is that quantity of oxygen necessary for a constant rate of descent from the aeroplane's maximum certificated operating altitude to 15 000 ft in 10 minutes.~~

~~Note 5: For the purpose of this table "passengers" means passengers actually carried and includes infants.~~

Comment [V64]: Moved in AMC to CAT.IDE.235
Formatted: Indent: First line: 0 cm, Space Before: 6 pt, After: 6 pt

~~Appendix 1 to OPS 1.775 Supplemental Oxygen for non-pressurised Aeroplanes~~

Table 1

(a)	(b)
SUPPLY FOR:	DURATION AND PRESSURE ALTITUDE
1. All occupants of flight deck seats on flight deck duty	Entire flight time at pressure altitudes above 10 000 ft
2. All required cabin crew members	Entire flight time at pressure altitudes above 13 000 ft and for any period exceeding 30 minutes at pressure altitudes above 10 000 ft but not exceeding 13 000 ft.
3. 100 % of passengers (See Note)	Entire flight time at pressure altitudes above 13 000 ft.
4. 10 % of passengers (See Note)	Entire flight time after 30 minutes at pressure altitudes greater than 10 000 ft but not exceeding 13 000 ft

~~Note: For the purpose of this table "passengers" means passengers actually carried and includes infants under the age of 2.~~

Comment [V65]: Moved in Table 1 of CAT.IDE.240

OPS 1.845 General introduction

(a) An operator shall ensure that a flight does not commence unless the communication and navigation equipment required under this Subpart is:

- (1) Approved and installed in accordance with the requirements applicable to them, including the minimum performance standard and the operational and airworthiness requirements;

EU-OPS Subpart F-I | Revised rule text

- ~~(2) Installed such that the failure of any single unit required for either communication or navigation purposes, or both, will not result in the failure of another unit required for communications or navigation purposes;~~
- ~~(3) In operable condition for the kind of operation being conducted except as provided in the MEL (OPS 1.030 refers); and~~
- ~~(4) So arranged that if equipment is to be used by one flight crew member at his/her station during flight it must be readily operable from his/her station. When a single item of equipment is required to be operated by more than one flight crew member it must be installed so that the equipment is readily operable from any station at which the equipment is required to be operated.~~
- ~~(b) Communication and navigation equipment minimum performance standards are those prescribed in the applicable European Technical Standard Orders (ETSO) as listed in applicable specifications on European Technical Standard Orders (CS TSO), unless different performance standards are prescribed in the operational or airworthiness codes. Communication and navigation equipment complying with design and performance specifications other than ETSO on the date of OPS implementation may remain in service, or be installed, unless additional requirements are prescribed in this Subpart. Communication and navigation equipment which has already been approved does not need to comply with a revised ETSO or a revised specification, other than ETSO, unless a retroactive requirement is prescribed.~~

CAT.IDE.A.325 Headset

- (a) Aeroplanes shall be equipped with a headset with a boom or throat microphone or equivalent for each flight crew member on flight crew compartment duty.**
- (b) Aeroplanes operated under IFR or at night, shall be equipped with a transmit button on the manual pitch and roll control for each required flight crew member.**

CAT.IDE.A.330~~OPS 1.850~~ Radio eEquipment

- ~~(a) An operator shall not operate an **A**-aeroplanes unless it ~~is~~**shall be** equipped with radio **communication equipment** required for the kind of operation being conducted by applicable rules of the air or airspace requirements.~~
- ~~(b) Where two independent (separate and complete) radio systems are required under this Subpart, each system must have an independent antenna installation except that, where rigidly supported non-wire antennae or other antenna installations of equivalent reliability are used, only one antenna is required.~~**(eb)** The radio communication equipment **shall** provide for communications on the aeronautical emergency frequency 121.75 MHz.

Comment [V66]: Moved to AMC

CAT.IDE.A.335~~OPS 1.855~~ Audio sSelector pPanel

An operator shall not operate an **A**aeroplanes **operated** under IFR unless it ~~is~~**shall be** equipped with an audio selector panel ~~accessible to~~**operable from** each required flight crew member **station**.

CAT.IDE.A.340~~OPS 1.860~~ Radio equipment for operations under VFR over routes navigated by reference to visual landmarks

~~An operator shall not operate an~~ **Aeroplanes operated** under VFR over routes that can be navigated by reference to visual landmarks, ~~unless it is~~ **shall be** equipped with the radio communication equipment necessary under normal ~~operating~~ **radio propagation** conditions to fulfil the following:

Comment [GCI67]: In accordance with ICAO

- (a) ~~C~~ommunicate with appropriate ground stations;
- (b) ~~C~~ommunicate with appropriate air traffic control (**ATC**) facilities from any point in controlled airspace within which flights are intended; and
- (c) ~~R~~receive meteorological information.

CAT.IDE.A.345~~OPS 1.865~~ Communication and nNavigation equipment for operations under IFR, or under VFR over routes not navigated by reference to visual landmarks

(a) ~~An operator shall not operate an~~ **Aeroplanes operated** under IFR, or under VFR over routes that cannot be navigated by reference to visual landmarks, ~~unless the aeroplane is~~ **shall be** equipped with radio communication and SSR transponder and navigation equipment in accordance with the requirements of air traffic services in the area(s) of operation **applicable airspace requirements**.

(b) Radio **communication equipment shall include at least** ~~Equipment. An operator shall ensure that radio equipment comprises not less than:~~

~~(1) Two independent radio communication systems necessary under normal operating conditions to communicate with an appropriate ground station from any point on the route including diversions; and~~

~~(2) SSR transponder equipment as required for the route being flown.~~

(c) **Notwithstanding (b), aeroplanes operated f**For short haul operations in the **North Atlantic minimum navigation performance specifications (NAT MNPS)** airspace **and** not crossing the North Atlantic ~~an aeroplane may~~ **shall be** equipped with **at least** one ~~Long R~~ange ~~C~~ommunication ~~S~~ystem (~~HF-high frequency/HF-system~~), **in case** alternative communication procedures are published for the airspace concerned.

(d) **Aeroplanes shall have sufficient** navigation equipment **to ensure that, in the event of the failure of one item of equipment at any stage of the flight, the remaining equipment shall allow safe navigation in accordance with the flight plan.**

(e) **Aeroplanes operated on flights in which it is intended to land in instrument meteorological conditions (IMC), shall be equipped with radio equipment capable of receiving signals providing guidance to a point from which a visual landing can be performed. This equipment shall be capable of providing such guidance for each aerodrome at which it is intended to land in IMC and for any designated alternate aerodromes.**

~~(1) Comprises not less than:~~

EU-OPS Subpart F-I | Revised rule text

- (i) ~~One VOR receiving system, one ADF system, one DME except that an ADF system need not be installed provided that the use of the ADF is not required in any phase of the planned flight;~~
- (ii) ~~One ILS or MLS where ILS or MLS is required for approach navigation purposes;~~
- (iii) ~~One Marker Beacon receiving system where a Marker Beacon is required for approach navigation purposes;~~
- (iv) ~~An Area Navigation System when area navigation is required for the route being flown;~~
- (v) ~~An additional DME system on any route, or part thereof, where navigation is based only on DME signals;~~
- (vi) ~~An additional VOR receiving system on any route, or part thereof, where navigation is based only on VOR signals;~~
- (vii) ~~An additional ADF system on any route, or part thereof, where navigation is based only on NDB signals; or~~
- (2) ~~Complies with the Required Navigation Performance (RNP) Type for operation in the airspace concerned.~~
- (e) ~~An operator may operate an aeroplane that is not equipped with an ADF or with the navigation equipment specified in subparagraph(s) (c)(1)(vi) and/or (c)(1)(vii) above, provided that it is equipped with alternative equipment authorised, for the route being flown, by the Authority. The reliability and the accuracy of alternative equipment must allow safe navigation for the intended route.~~
- (f) ~~An operator shall ensure that VHF communication equipment, ILS Localiser and VOR receivers installed on aeroplanes to be operated in IFR are of a type that has been approved as complying with the FM immunity performance standards.~~
- (g) ~~An operator shall ensure that aeroplanes conducting ETOPS have a communication means capable of communicating with an appropriate ground station at normal and planned contingency altitudes. For ETOPS routes where voice communication facilities are available, voice communications shall be provided. For all ETOPS operations beyond 180 minutes, reliable communication technology, either voice based or data link, must be installed. Where voice communication facilities are not available and where voice communication is not possible or is of poor quality, communications using alternative systems must be ensured.~~

Comment [V68]: Moved to AMC

Comment [V69]: Moved to Part SPA

Comment [V70]: Moved to AMC

Comment [V71]: Moved to AMC

Comment [V72]: Moved to AMC

CAT.IDE.A.350 ~~OPS 1.866~~ Transponder equipment

- (a) ~~An operator~~**Aeroplanes** shall not operate an aeroplane unless it ~~is~~**be** equipped with;
- (1) ~~Aa~~ pressure altitude reporting **secondary surveillance radar** (SSR) transponder; and
- (2) any other SSR transponder capability required for the route being flown.

~~OPS 1.870~~ Additional navigation equipment for operations in MNPS airspace

- ~~(a) An operator shall not operate an aeroplane in MNPS airspace unless it is equipped with navigation equipment that complies with minimum navigation~~

Comment [GCI73]: Moved to Part SPA

~~performance specifications prescribed in ICAO Doc 7030 in the form of Regional Supplementary Procedures.~~

~~(b) The navigation equipment required by this paragraph must be visible and usable by either pilot seated at his/her duty station.~~

~~(c) For unrestricted operation in MNPS airspace an aeroplane must be equipped with two independent Long Range Navigation Systems (LRNS).~~

~~(d) For operation in MNPS airspace along notified special routes an aeroplane must be equipped with one Long Range Navigation System (LRNS), unless otherwise specified.~~

~~OPS 1.872 Equipment for operation in defined airspace with Reduced Vertical Separation Minima (RVSM)~~

Formatted: Heading 5; Sub-titles

~~(a) An operator shall ensure that aeroplanes operated in RVSM airspace are equipped with:~~

~~(1) Two independent altitude measurement systems~~

~~(2) An altitude alerting system~~

~~(3) An automatic altitude control system; and~~

~~(4) A secondary surveillance radar (SSR) transponder with altitude reporting system that can be connected to the altitude measurement system in use for altitude keeping. CAT.IDE.A.355 OPS 1.873 Electronic Navigation Data Management~~

Comment [V74]: Moved to Part SPA

~~(a) Operators shall not only use a navigation database electronic navigation products which that supports a airborne navigation application as a primary means of navigation unless the navigation database supplier holds a Type 2 Letter of Acceptance (LoA) or equivalent.~~

Comment [GC175]: Paragraph (a) is general in the intent and the corresponding AMC specify that if electronic data is used to support an application as a primary means for navigation, then a LOA is required. For any other application needed to support SPA operations it is required an approval and this cannot be in the AMC so paragraph (b) is needed to specify this at IR level.

~~(b) If the operator's supplier does not hold a Type 2 LoA or equivalent, the operator shall not use the electronic navigation data products unless the Authority has approved the operator's procedures for ensuring that the process applied and the delivered products have that meets equivalent standards of integrity that are adequate for the intended use of the data.~~

Formatted: N (a)

~~(c) An operator shall not use electronic navigation data products for other navigation applications unless the Authority has approved the operator's procedures for ensuring that the process applied and the delivered products have met standards of integrity acceptable for the intended use of the data.~~

~~(b) When the electronic navigation data products support a navigation application needed for an operation for which Part-SPA requires an approval, the operator shall demonstrate to the competent authority that~~

EU-OPS Subpart F-I | Revised rule text

the process applied and the delivered products meets standards of integrity that are adequate for the intended use of the data.

~~(dc)~~ ~~OA~~ operators shall continuously~~ely~~ monitor both the process and the products, **either directly or by monitoring the compliance of third party providers.**

~~according to the requirements of OPS 1.035.~~

~~(ed)~~ ~~AO~~ operators shall implement procedures that ensure **the** timely distribution and insertion of current and unaltered electronic navigation data to all aircraft that require it.

EU-OPS Subpart F-I | Revised rule text

Subpart D – Instrument, data, equipment

Section 1 – Aeroplanes

GM1-CAT.IDE.A.100(a) Instruments and equipment – General

APPROVED EQUIPMENT

The equipment approval in CAT.IDE.A.100 means that the equipment should have an authorisation (**e.g. European Technical Standards Order (ETSO) authorisation**) or an approval in accordance with **Regulation (EC) No 1702/2003** ~~Part 21 (e.g. European Technical Standards Order (ETSO) authorisation)~~.

GM1-CAT.IDE.A.100-(c) Instruments and equipment – General

INSTRUMENTS AND EQUIPMENT ~~WHICH~~ **THAT** DO NOT NEED TO BE APPROVED IN ACCORDANCE WITH ~~PART 21~~ **REGULATION (EC) NO 1702/2003**, BUT ~~IS~~ **ARE** CARRIED ON A FLIGHT

1. The provision of this paragraph does not exempt the item of equipment from complying with ~~Part 21~~ **Regulation (EC) No 1702/2003** if the instrument or equipment is installed in the aeroplane. In this case, the installation should be approved as required in ~~Part 21~~ **Regulation (EC) No 1702/2003** and should comply with the applicable airworthiness codes **as required under the same Regulation**.
2. The functionality of non-installed instruments and equipment required by this Part-~~OPS and that which~~ do not need an equipment approval should be checked against recognised industry standards appropriate to the intended purpose. The operator is responsible for ensuring the maintenance of these instruments and equipment.
3. The failure of additional non-installed instruments or equipment not required by **this** Part-~~OPS or the airworthiness codes~~ **by Regulation (EC) No 1702/2003** or any applicable airspace requirements should not adversely affect the airworthiness and/or the safe operation of the aeroplane. Examples are the following:
 - a. ~~In~~struments supplying additional flight information (e.g. stand-alone ~~G~~lobal ~~P~~ositioning ~~s~~ystem (GPS));
 - b. ~~Some aerial work~~ **mission dedicated** equipment (e.g. ~~some mission dedicated~~ radios, ~~wire cutters~~); **and**
 - c. ~~Non~~-installed passenger entertainment equipment.

GM1-CAT.IDE.A.100-(d) Instruments and eEquipments - General

ACCESSIBILITY AND POSITIONING OF INSTRUMENTS AND EQUIPMENT

This requirement implies that whenever a single instrument is required to be installed in an aeroplane operated in a multi-crew environment, the instrument needs to be visible from each flight crew station.

EU-OPS Subpart F-I | Revised rule text

GM1--CAT.IDE.A.110 Spare electrical fuses

FUSES

A spare electrical fuse means a replaceable fuse in the flight crew compartment, not an automatic circuit breaker, or circuit breakers in the electric compartments.

AMC1--CAT.IDE.A.120 Equipment to clear windshield

MEANS TO MAINTAIN A CLEAR PORTION OF THE WINDSHIELD DURING PRECIPITATION

The means used to maintain a clear portion of the windshield during precipitation should be windshield wipers or an equivalent.

AMC1-CAT.IDE.A.125&CAT.IDE.A.130 Day VFR operations and IFR or night operations – Flight and navigational instruments and associated equipment and CAT.IDE.A.130 IFR or night operations – Flight and navigational instruments and associated equipment

Comment [GCI76]: From AMC OPS 1.650/1.652 and AMC OPS 1.865

INTEGRATED INSTRUMENTS

1. Individual equipment requirements may be met by combinations of instruments, ~~or~~ by integrated flight systems or by a combination of parameters on electronic displays, provided that the information so available to each required pilot is not less than that required in the applicable operational requirements, and the equivalent safety of the installation has been shown during type certification approval of the aeroplane for the intended type of operation.
2. The means of measuring and indicating turn and slip, aeroplane attitude and stabilised aeroplane heading may be met by combinations of instruments or by integrated flight director systems, provided that the safeguards against total failure, inherent in the three separate instruments, are retained.

AMC2-CAT.IDE.A.125 Day VFR operations – Flight and navigational instruments and associated equipment

LOCAL FLIGHTS

For flights ~~which~~**that** do not exceed 60 minutes' duration, ~~which~~**that** take off and land at the same aerodrome, and ~~which~~**that** remain within 50 ~~nm~~**NM** of that aerodrome, an equivalent means of complying with CAT.IDE.A.125 (a)(6)**(a)**, ~~(a)(7)~~ and ~~(a)(8)~~ may be either a turn and slip indicator, or a turn co-ordinator, or both an attitude indicator and a slip indicator.

EU-OPS Subpart F-I | Revised rule text

AMC1-CAT.IDE.A.125-(a)(1)&CAT.IDE.A.130-(a)(1) Day VFR operations and IFR or night operations – Flight and navigational instruments and associated equipment and ~~CAT.IDE.A.130 (a)(1) IFR or night operations—Flight and navigational instruments and associated equipment~~

MEANS OF MEASURING AND DISPLAYING MAGNETIC DIRECTION

The means of measuring and displaying magnetic direction should be a magnetic compass or equivalent.

AMC1-CAT.IDE.A.125-(a)(2)&CAT.IDE.A.130-(a)(2) Day VFR operations and IFR or night operations – Flight and navigational instruments and associated equipment and ~~CAT.IDE.A.130 (a)(2) IFR or night operations—Flight and navigational instruments and associated equipment~~

MEANS FOR ~~OF~~ MEASURING AND DISPLAYING THE TIME

An acceptable means of compliance with ~~OPS.CAT.410(a)(2)~~ is a clock displaying hours, minutes and seconds, with a sweep-second pointer or digital presentation.

AMC1 CAT.IDE.A.125 (a)(3)&CAT.IDE.A.130(b) Day VFR operations and IFR or night operations – Flight and navigational instruments and associated equipment and ~~CAT.IDE.A.130 (b) IFR or night operations—Flight and navigational instruments and associated equipment~~

CALIBRATION OF THE MEANS FOR MEASURING AND DISPLAYING PRESSURE ALTITUDE

The instrument measuring and displaying pressure altitude should be of a sensitive type calibrated in feet (ft), with a sub-scale setting, calibrated in hectopascals/millibars, adjustable for any barometric pressure likely to be set during flight.

AMC1-CAT.IDE.A.125-(a)(4)&CAT.IDE.A.130-(a)(3) Day VFR operations and IFR or night operations – Flight and navigational instruments and associated equipment and ~~CAT.IDE.A.130 (a)(3) IFR or night operations—Flight and navigational instruments and associated equipment~~

CALIBRATION OF THE INSTRUMENT INDICATING AIR-SPEED

The instrument indicating air-speed should be calibrated in knots (kt).

AMC1-CAT.IDE.A.130-(a)(5) IFR or night operations – Flight and navigational instruments and associated equipment

SLIP INDICATOR

If only slip indication is provided, the means of measuring and displaying standby attitude should be certified according to CS 25.1303(b)(4) or equivalent.

AMC2-CAT.IDE.A.130-(b) IFR or night operations – Flight and navigational instruments and associated equipment

ALTIMETERS – IFR OR NIGHT OPERATIONS

Except for unpressurised aeroplanes operating below 10,000 feet, the altimeters of aeroplanes operating under IFR or at night should have counter drum-pointer or equivalent presentation.

AMC1-CAT.IDE.A.125-(b)(1)&CAT.IDE.A.130 (c)(1) Day VFR operations and IFR or night operations – Flight and navigational instruments and associated equipment and ~~CAT.IDE.A.130 (c)(1) IFR or night operations – Flight and navigational instruments and associated equipment~~

Comment [GC177]: From AMC OPS 1.650(i) & 1.652(i)

MEANS OF DISPLAYING OUTSIDE AIR TEMPERATURE

1. The means of displaying outside air temperature should be calibrated in degrees Celsius.
2. The means of displaying outside air temperature may be an air temperature indicator ~~which~~ **that** provides indications that are convertible to outside air temperature.

AMC1-CAT.IDE.A.125-(c)&CAT.IDE.A.130(h) Day VFR operations and IFR or night operations – Flight and navigational instruments and associated equipment and ~~CAT.IDE.A.130 (h) IFR or night operations – Flight and navigational instruments and associated equipment~~

MULTI-PILOT OPERATIONS - DUPLICATE INSTRUMENTS

Duplicate instruments include separate displays for each pilot and separate selectors or other associated equipment where appropriate.

AMC1-CAT.IDE.A.125-(d)&CAT.IDE.A.130-(d) Day VFR operations and IFR or night operations – Flight and navigational instruments and associated equipment and ~~CAT.IDE.A.130 (d) IFR or night operations – Flight and navigational instruments and associated equipment~~

MEANS OF PREVENTING MALFUNCTION DUE TO CONDENSATION OR ICING

The means of preventing malfunction due to either condensation or icing of the airspeed indicating system should be a heated pitot tube or equivalent.

AMC1-CAT.IDE.A.130-(e) IFR or night operations – Flight and navigational instruments and associated equipment

Comment [GC178]: From AMC OPS 1.652(d) & (k)(2)

MEANS OF INDICATING FAILURE OF THE AIRSPEED INDICATING SYSTEM'S MEANS OF PREVENTING MALFUNCTION DUE TO EITHER CONDENSATION OR ICING OF THE AIRSPEED INDICATING SYSTEM

A combined means of indicating failure of the ~~means of preventing malfunction due to either condensation or icing of the airspeed indicating system's~~ **means of preventing malfunction due to either condensation or icing** is acceptable provided that **it** is

EU-OPS Subpart F-I | Revised rule text

visible from each flight crew station and that there is a means to identify the failed heater in systems with two or more sensors.

AMC1-CAT.IDE.A.130-(i) IFR or night operations – Flight and navigational instruments and associated equipment

STANDBY ATTITUDE

Means of measuring and displaying standby attitude should:

1. be powered continuously during normal operation and, in the event of a total failure of the normal electrical generating system, be powered from a source independent of the normal electrical generating system;
2. be capable of being used from either pilot's station;
3. operates independently of other means of measuring and displaying attitude;
4. be operative automatically after total failure of the normal electrical generating system;
5. provide reliable operation for a minimum of 30 minutes after total failure of the normal electrical generating system, taking into account other loads on the emergency power supply and operational procedures;
6. be appropriately illuminated during all phases of operation, except for aeroplanes with an **MCTOM** maximum certified take-off mass of 5 700 kg or less, already registered in a Member State on 1 April 1995, equipped with a standby attitude indicator in the left-hand instrument panel; and
7. be associated with a means to indicate to the flight crew when operating under its dedicated power supply.

AMC1-CAT.IDE.A.130(j) IFR or night operations – Flight and navigational instruments and associated equipment

CHART HOLDER

An acceptable means of compliance with the chart holder requirement is to display a pre-composed chart on an ~~E~~electronic ~~F~~flight ~~B~~bag (EFB).

GM1-CAT.IDE.A.125 & CAT.IDE.A.130 Day VFR operations and IFR or night operations – Flight and navigational instruments and associated equipment and ~~CAT.IDE.A.130 IFR or night operations – Flight and navigational instruments and associated equipment~~

Comment [GCI79]: From IEM OPS 1.650/1.652

GENERAL

Table 1: of ~~GM1-CAT.IDE.A.125 & 130~~ Flight and navigational instruments and associated equipment

EU-OPS Subpart F-I | Revised rule text

SERIAL		FLIGHTS UNDER VFR		FLIGHTS UNDER IFR OR AT NIGHT	
		SINGLE PILOT	TWO PILOTS REQUIRED	SINGLE PILOT	TWO PILOTS REQUIRED
(a)		(b)	(c)	(d)	(e)
1	Magnetic direction	1	1	1	1
2	Time	1	1	1	1
3	Pressure altitude	1	2	2 Note (5)	2 Note (5)
4	Indicated air-speed	1	2	1	2
5	Vertical speed indicator	1	2	1	2
6	Turn and slip or turn coordinator	1 Note(1)	2 Note(1)& Note(2)	1 Note (4)	2 Note (4)
7	Attitude	1 Note(1)	2 Note(1) & Note(2)	1	2
8	Stabilised direction	1 Note(1)	2 Note(1) & Note(2)	1	2
9	Outside Air Temperature	1	1	1	1
10	Mach number indicator	See Note(3)			
11	<ul style="list-style-type: none"> airspeed icing protection 	1 Note(6)	2 Note(6)	1	2
12	<ul style="list-style-type: none"> airspeed icing protection failure indicating 			1 Note (7)	2 Note (7)
13	Static pressure source			2	2
14	Standby attitude indicator			1	1

EU-OPS Subpart F-I | Revised rule text

SERIAL	FLIGHTS UNDER VFR	FLIGHTS UNDER IFR OR AT NIGHT	
		Note(6)	Note(6)
15	Chart Holder	1	1
		Note (6)	Note (6)

- Note (1) For local flights (A to A, 50 ~~nm~~**NM** radius, not more than 60 minutes' duration) the instruments at ~~Serials (a)(6), (a)(7) and (a)(8)~~ may be replaced by either a turn and slip indicator, or a turn co-ordinator, or both an attitude indicator and a slip indicator.
- Note (2) The substitute instruments permitted by Note (1) above should be provided at each pilot's station.
- Note (3) A Mach number indicator is required for each pilot whenever compressibility limitations are not otherwise indicated by airspeed indicators.
- Note (4) For IFR or at night, a turn and slip indicator, or a slip indicator and a third (standby) attitude indicator ~~certified~~ according to CS 25.1303(b)(4) or equivalent, is required.
- Note (5) Except for unpressurised aeroplanes operating below 10 000 feet, neither three pointers, nor drum pointer altimeters satisfy the requirement.
- Note (6) Applicable only to aeroplanes with an **MCTOM** ~~maximum certified take-off mass exceeding of more than 5 700 kg, or with a maximum passenger seating configuration an MPSC of more than nine.~~
- Note (7) The pitot heater failure annunciation applies to any aeroplane issued with an individual ~~Certificate of Airworthiness C of A~~ on or after 1 April 1998. It also applies before that date when: the aeroplane has an MCTOM ~~greater of more than 57 000 kg and an maximum approved passenger seating configuration (MAPSC) greater than nine.~~

Comment [GC180]: See comment on corresponding IR.

AMC1-CAT.IDE.A.150 Terrain awareness warning system (TAWS)

EXCESSIVE DOWNWARDS GLIDE SLOPE DEVIATION WARNING FOR CLASS A TAWS~~TAWS CLASS A AND TAWS CLASS B~~

The requirement for a Class A TAWS to provide a warning to the flight crew for excessive downwards glide slope deviation should apply to all final approach glide slopes with angular vertical navigation (VNAV) guidance, whether provided by the instrument landing system (ILS), microwave landing system (MLS), satellite based augmentation system approach procedure with vertical guidance (SBAS APV (lateral precision with vertical guidance approach LPV)), ground based augmentation system (GBAS (GPS landing system, GLS) or any other systems providing similar guidance. The same requirement should not apply to systems providing vertical guidance based on barometric VNAV.

~~The minimum performance standards for TAWS Class A and TAWS Class B equipment are should be those described in the Agency's ETSO C151a.~~

AMC1-CAT.IDE.A.160 Airborne weather detecting equipment**GENERAL**

The airborne weather equipment should be an airborne weather radar, except for propeller-driven pressurised aeroplanes ~~having with an MCTOM maximum certificated take-off mass not exceeding more than 5 700 kg with and an MPSC maximum approved passenger seating configuration of not exceeding more than 9 seats~~ **nine**, for which other equipment capable of detecting thunderstorms and other potentially hazardous weather conditions, regarded as detectable with airborne weather radar equipment are also acceptable, ~~subject to approval by the Authority.~~

AMC1-CAT.IDE.A.170 Flight crew interphone system**TYPE OF FLIGHT CREW INTERPHONE**

The flight crew interphone system should not be of a handheld type.

AMC1-CAT.IDE.A.175 Crew member interphone system

Comment [GCI81]: Accommodates AMC OPS 1.690(b)(6) and IEM OPS 1.690(b)(7)

SPECIFICATIONS

The crew member interphone system should:

1. ~~Operate~~ operate independently of the public address system except for handsets, headsets, microphones, selector switches and signalling devices;
2. ~~Be~~ be readily accessible for use at required cabin crew member stations close to each separate or pair of floor level emergency exits, in the case of aeroplanes required to carry at least one cabin crew member;
3. ~~Have~~ have an alerting system incorporating aural or visual signals for use by flight and cabin crew, in the case of aeroplanes required to carry at least one cabin crew member;
4. ~~Have~~ have a means for the recipient of a call to determine whether it is a normal call or an emergency call which uses:
 - a. ~~L~~lights of different colours;
 - b. ~~c~~Codes defined by the operator (e.g. different number of rings for normal and emergency calls); **and**
 - c. ~~a~~Any other indicating signal ~~acceptable to the competent authority responsible for type certification or supplemental type certifications~~ **specified in the operations manual**;
5. ~~P~~provide two-way communication between:
 - a. the flight crew compartment and each passenger compartment, in the case of aeroplanes required to carry at least one cabin crew member;
 - b. the flight crew compartment and each galley located other than on a passenger deck level, in the case of aeroplanes required to carry at least one cabin crew member;

EU-OPS Subpart F-I | Revised rule text

- c. the flight crew compartment and each remote crew compartment and crew member station that is not on the passenger deck and is not accessible from a passenger compartment; and
 - d. ground personnel and at least two flight crew members. This interphone system for use by the ground personnel should be, where practicable, so located that the personnel using the system may avoid detection from within the aeroplane; **and**
76. **b**Be readily accessible for use from each required flight crew station in the flight crew compartment.†

AMC1.CAT.IDE.A.180 Public address system

SPECIFICATIONS

The public address system should:

1. ~~Operate~~ operate independently of the interphone systems except for handsets, headsets, microphones, selector switches and signalling devices;
2. **b**Be readily accessible for immediate use from each required flight crew station;
3. ~~h~~**h**Have, for each floor level passenger emergency exit which has an adjacent cabin crew seat, a microphone operable by the seated cabin crew member, except that one microphone may serve more than one exit, provided the proximity of exits allows unassisted verbal communication between seated cabin crew members;
4. **b**Be operable within 10 seconds by a cabin crew member at each of those stations; **and**
5. **b**Be audible at all passenger seats, toilets, cabin crew seats and work stations.†

AMC1-CAT.IDE.A.185 Cockpit voice recorder

Comment [GCI82]: Accommodates and updates content of ACJ OPS 1.700 and ACJ OPS 1.705/1.710

GENERAL

The operational performance requirements for CVRs should be those laid down in **European Organisation for Civil Aviation Equipment (EUROCAE) Document ED-112 (Minimum Operational Performance Specification for Crash Protected Airborne Recorder Systems)** dated **March 2003**.

AMC1-CAT.IDE.A.190 Flight data recorder

LIST OF PARAMETERS TO BE RECORDED FOR AEROPLANES FIRST ISSUED WITH AN INDIVIDUAL ~~CERTIFICATE OF AIRWORTHINESS~~ **C OF A** ON OR AFTER 1 JANUARY 2016

1. The ~~flight data recorder~~ **FDR** should record with reference to a timescale, the list of parameters in Table 1 and Table 2, as applicable.
2. The parameters to be recorded should meet the performance specifications (~~designated~~ ranges, sampling intervals, accuracy limits and ~~minimum~~ resolution in read-out) as defined in the relevant tables of the ~~European Organisation for Civil Aviation Equipment (EUROCAE)~~ **Document ED-112**, dated **March 2003**.

EU-OPS Subpart F-I | Revised rule text

**Table 1: of AMC1-CAT.IDE.A.190 Flight data recorderFDR – All aeroplanes
ALL AEROPLANES**

No.*	Parameter
1a	Time; or
1b	Relative time count
1c	Global nNavigation sSatellite sSystem (GNSS) time synchronisation
2	Pressure altitude
3a	Indicated air-speed; or
3b	Calibrated air-speed
4	Heading (primary flight crew reference) - when true or magnetic heading can be selected, the primary heading reference, a discrete indicating selection, should be recorded
5	Normal acceleration
6	Pitch attitude
7	Roll attitude
8	Manual radio transmission keying and Cockpit Voice Recorder (CVR)/FDR synchronisation reference.
9	Engine thrust/power
9a	Parameters required to determine propulsive thrust/power on each engine
9b	Flight crew compartment thrust/power lever position for aeroplanes with non-mechanically linked flight crew compartment - engine control
14	Total or oOutside Air-air tTemperature (OAT)
16	Longitudinal acceleration (body axis)
17	Lateral acceleration
18	Primary flight control surface and primary flight control pilot input (for multiple or split surfaces, a suitable combination of inputs is acceptable in lieu of recording each surface separately. For aeroplanes which have a flight control break-away capability that allows either pilot to operate the controls independently, record both inputs):
18a	pitch axis
18b	roll axis
18c	yaw axis
19	Pitch trim surface position
23	Marker beacon passage

EU-OPS Subpart F-I | Revised rule text

No.*	Parameter
24	Warnings - in addition to the master warning each "red" warning (including smoke warnings from other compartments) should be recorded when the warning condition cannot be determined from other parameters or from the CVR
25	Each navigation receiver frequency selection
27	Air - ground status and, if the sensor is installed, each landing gear
38	Selected barometric setting - to be recorded for the aeroplane in which the parameter is displayed electronically
44	Selected flight path (all pilot selectable modes of operation) - to be recorded for the aeroplane in which the parameter is displayed electronically
45	Selected decision height - to be recorded for the aeroplane in which the parameter is displayed electronically
75	All flight crew compartment flight control input forces (for fly-by-wire flight control systems, where control surface position is a function of the displacement of the control input device only, it is not necessary to record this parameter):
75a	Control wheel
75b	Control column
75c	Rudder pedal flight crew compartment input forces

* The number in the left hand column reflects the serial number depicted in EUROCAE ED-112.

**Table 2: of AMC1 CAT.IDE.A.190 Flight data recorderFDR -
Aeroplanes for which the information data source for the parameter is either used by aeroplane systems or is available on the instrument panel for use by the flight crew to operate the aeroplane:**

No.*	Parameter
10	Flaps: Trailing edge flap position and flight crew compartment control selection
11	Slats: Leading edge flap (slat) position and flight crew compartment control selection
12	Thrust reverse status
13	Ground spoiler and speed brake
13a	Ground spoiler position
13b	Ground spoiler selection
13c	Speed brake position
13d	Speed brake selection
15	Autopilot/autothrottle/Automatic Flight Control System (AFCS) mode and engagement status

EU-OPS Subpart F-I | Revised rule text

No.*	Parameter
20	Radio altitude. For autoland/Category 3 -III operations, each radio altimeter should be recorded. It is acceptable to arrange them so that at least one is recorded every second.
21	Vertical deviation - the approach aid in use should be recorded. For autoland/Category 3 -III operations, each system should be recorded. It is acceptable to arrange them so that at least one is recorded every second).
21a	
21b	ILS/GPS/GLS glide path
21c	MLS elevation GNSS approach path/IRNAV vertical deviation
22	Horizontal deviation - the approach aid in use should be recorded. For auto land/Category 3 -III operations, each system should be recorded. It is acceptable to arrange them so that at least one is recorded every second).
22a	ILS/GPS/GLS localiser
22b	MLS azimuth
22c	GNSS approach path/IRNAV lateral deviation
26	Distance measuring equipment (DME) 1 and 2 distances
26a	Distance to Runway Threshold (GLS)
26b	Distance to Missed Approach Point (IRNAV/IAN)
28	Ground proximity warning system (GPWS)/terrain awareness warning system (TAWS)/ ground collision avoidance system (GCAS) status:
28a	
28b	Selection of terrain display mode, including pop-up display status
28c	Terrain alerts, including cautions and warnings and advisories On/off switch position
29	Angle of attack
30	Low pressure warning (each system):
30a	Hydraulic pressure
30b	Pneumatic pressure
31	Ground speed
32	Landing gear:
32a	Landing gear

EU-OPS Subpart F-I | Revised rule text

No.*	Parameter
32b	Gear selector position
33	Navigation data:
33a	Drift angle
33b	Wind speed
33c	Wind direction
33d	Latitude
33e	Longitude
33f	GNSS augmentation in use
34	Brakes:
34a	Left and right brake pressure
34b	Left and right brake pedal position
35	Additional engine parameters (if not already recorded in parameter 9 of Table 1 of AMC1- CAT.IDE.190.AOPS.CAT.490.A and if the aeroplane is equipped with a suitable data source):
35a	Engine P pressure R ratio (EPR)
35b	N ₁
35c	Indicated vibration level
35d	N ₂
35e	Exhaust G gas T temperature (EGT)
35f	Fuel flow
35g	Fuel cut-off lever position
35h	N ₃
36	T raffic A alert and C ollision A avoidance S ystem (TCAS)/ airborne collision avoidance system (ACAS) a suitable combination of discrettes should be recorded to determine the status of the system:
36a	Combined control
36b	Vertical control
36c	Up advisory
36d	Down advisory
36e	Sensitivity level
37	Wind -shear warning
38	Selected b Barometric setting
38a	Pilot selected b Barometric setting
38b	First officer Co-pilot selected b Barometric setting

EU-OPS Subpart F-I | Revised rule text

No.*	Parameter
39	Selected altitude (A all pilot selectable modes of operation) - to be recorded for the aeroplane where the parameter is displayed electronically
40	Selected speed (A all pilot selectable modes of operation) - to be recorded for the aeroplane where the parameter is displayed electronically
41	Selected Mach (A all pilot selectable modes of operation) - to be recorded for the aeroplane where the parameter is displayed electronically
42	Selected vertical speed (A all pilot selectable modes of operation) - to be recorded for the aeroplane where the parameter is displayed electronically
43	Selected heading (A all pilot selectable modes of operation) - to be recorded for the aeroplane where the parameter is displayed electronically
44a	Course/ desired track (DSTRK)
44b	Path angle
44c	Co-ordinates of final approach path (IRNAV/IAN)
46	Electronic F light i nstrument s ystem (EFIS) display format:
46a	Pilot
46b	First Officer Co-pilot
47	Multi-function/engine/alerts display format
48	Alternating current (AC) electrical bus status - each bus
49	Direct current (DC) electrical bus status - each bus
50	Engine bleed valve position
51	Auxiliary power unit (APU) bleed valve position
52	Computer failure - critical flight and engine control system
53	Engine thrust command
54	Engine thrust target
55	Computed centre of gravity (CG)
56	Fuel quantity or fuel quantity in CG trim tank
57	Head up display in use
58	Para visual display on
59	Operational stall protection, stick shaker and pusher activation

EU-OPS Subpart F-I | Revised rule text

No.*	Parameter
60	Primary navigation system reference:
60a	GNSS
60b	Inertial Navigational System (INS)
60c	VHF omnidirectional radio range (VOR) /distance measuring equipment (DME)
60d	MLS
60e	Loran C
60f	ILS
61	Ice detection
62	Engine warning - each engine vibration
63	Engine warning - each engine over temperature
64	Engine warning - each engine oil pressure low
65	Engine warning - each engine over speed
66	Yaw trim surface position
67	Roll trim surface position
68	Yaw or sideslip angle
69	De-icing and/or anti-icing systems selection
70	Hydraulic pressure - each system
71	Loss of cabin pressure *
72	Flight crew compartment trim control input position pitch - when mechanical means for control inputs are not available, cockpit display trim positions or trim command should be recorded
73	Flight crew compartment trim control input position roll - when mechanical means for control inputs are not available, flight crew compartment display trim positions or trim command should be recorded
74	Flight crew compartment trim control input position yaw - when mechanical means for control inputs are not available, flight crew compartment display trim positions or trim command should be recorded
76	Event marker
77	Date
78	Actual navigation performance (ANP) or estimate of position error (EPE) or estimate of position uncertainty (EPU)

* The number in the left hand column reflects the serial number depicted in EUROCAE ED-112.

AMC2-CAT.IDE.A.190 Flight data recorder

LIST OF PARAMETERS TO BE RECORDED FOR AEROPLANES FIRST ISSUED WITH AN INDIVIDUAL ~~CERTIFICATE OF AIRWORTHINESS~~ **C of A** ON OR AFTER 1 APRIL 1998 AND BEFORE 1 JANUARY 2016

1. The ~~flight data recorder~~ **FDR** should record, with reference to a timescale:
 - a. the parameters listed in Table 1a **of** AMC2-CAT.IDE.A.190 or Table 1b **of** AMC2-CAT.IDE.A.190 below, as applicable;
 - b. the additional parameters listed in Table 2 ~~AMC2-CAT.IDE.A.190~~ below, for those aeroplanes with an **MCTOM** ~~maximum certificated take-off~~ exceeding 27 000 -kg;
 - c. any dedicated parameters relating to novel or unique design or operational characteristics of the aeroplane as determined by the ~~Agency~~ **competent authority**; and
 - d. the additional parameters listed in Table 3 ~~AMC2-CAT.IDE.A.190~~ below, for those aeroplanes equipped with electronic display systems.
2. When determined by the ~~Agency~~ **competent authority**, the ~~flight data recorder~~ **FDR** of aeroplanes first issued with an individual ~~Certificate of Airworthiness~~ **C of A** before 20 August 2002 and equipped with an electronic display system does not need to record those parameters listed in Table 3 **of** AMC2-CAT.IDE.A.190 below for which:
 - a. ~~the~~ the sensor is not available;
 - b. ~~the~~ The aeroplane system or equipment generating the data needs to be modified; or
 - c. ~~the~~ The signals are incompatible with the recording system;
3. The ~~flight data recorder~~ **FDR** of aeroplanes first issued with an individual ~~Certificate of Airworthiness~~ **C of A** on or after 1 April 1998 but not later than 1 April 2001, ~~are~~ **is** not required to comply with 1. above if:
 - a. ~~Compliance~~ compliance with 1. cannot be achieved without extensive modification to the aeroplane system and equipment other than the flight recording system; and
 - b. ~~the flight data recorder~~ **FDR** of the aeroplane can comply with AMC3-CAT.IDE.A.190 except that parameter 14 in Table 1 **of** AMC3-CAT.IDE.A.190 ~~of this AMC~~ need not be recorded.
5. The parameters to be recorded should meet, as far as practicable, the performance specifications (~~recording ranges, maximum recording~~ **sampling intervals, recording accuracy limits, and recording-resolution in read-out**) defined in Table 1 of AMC3-CAT.IDE.A.190;
6. For aeroplanes with novel or unique design or operational characteristics, the additional parameters should be those required in accordance with applicable ~~Ce~~ **certification S** specifications during type or supplemental certification or validation.
7. If recording capacity is available, as many as possible of the additional parameters specified in table II-A.1 of EUROCAE Document ED 112 dated March 2003 should be recorded.

EU-OPS Subpart F-I | Revised rule text

Table 1a: of AMC2-CAT.IDE.A.190 Flight data recorder FDR – Aeroplanes with an MCTOM of more than 5 700 kg

No.*	Parameter
1	Time or relative time count
2	Pressure altitude
3	Indicated airspeed
4	Heading
5	Normal acceleration
6	Pitch attitude
7	Roll attitude
8	Manual radio transmission keying
9	Propulsive thrust/ power on each engine and flight crew compartment thrust/power lever position if applicable
10	Trailing edge flap or flight crew compartment control selection
11	Leading edge flap or flight crew compartment control selection
12	Thrust reverse status
13	Ground spoiler position and/or speed brake selection
14	Total or outside air temperature
15	Autopilot, autothrottle and AFCS mode and engagement status
16	Longitudinal acceleration (bBody axis)
17	Lateral acceleration

Table 1b: of AMC2-CAT.IDE.A.190 Flight data recorder FDR – Aeroplanes with an MCTOM 5 700 kg or below

No.*	Parameter
1	Time or relative time count
2	Pressure altitude
3	Indicated airspeed
4	Heading

EU-OPS Subpart F-I | Revised rule text

No.*	Parameter
5	Normal acceleration
6	Pitch attitude
7	Roll attitude
8	Manual radio transmission keying
9	Propulsive thrust/ power on each engine and flight crew compartment thrust/power lever position if applicable
10	Trailing edge flap or flight crew compartment control selection
11	Leading edge flap or flight crew compartment control selection
12	Thrust reverse status
13	Ground spoiler position and/or speed brake selection
14	Total or outside air temperature
15	Autopilot/autothrottle engagement status
16	Longitudinal acceleration (body axis) Angle of attack (if a suitable sensor is available)
17	Angle of attack (if a suitable sensor is available) Longitudinal acceleration (Body axis)

Table 2: of ~~AMC2-CAT.IDE.A.190~~ Flight data recorderFDR - Additional parameters for aeroplanes with an MCTOM of more than 27 000 kg

No.*	Parameter
18	Primary flight controls - c Control surface position and/or pilot input (pitch, roll, yaw)
19	Pitch trim position
20	Radio altitude
21	Vertical beam deviation (ILS G glide path or MLS e Elevation)
22	Horizontal beam deviation (-ILS L ocaliser or MLS a Azimuth)
23	Marker b Beacon p Passage
24	Warnings
25	Reserved (-Navigation receiver frequency selection is recommended)
26	Reserved (DME distance is recommended)

EU-OPS Subpart F-I | Revised rule text

No.*	Parameter
27	Landing gear squat switch status or air/ground status
28	Ground Proximity Warning System
29	Angle of attack
30	Low pressure warning (hydraulic and pneumatic power)
31	Groundspeed
32	Landing gear or gear selector position

Table 3: of ~~AMC2-CAT.IDE.A.190 Flight data recorder~~FDR – Aeroplanes equipped with electronic display systems

No.	Parameter
33	Selected barometric setting (Each pilot station)
34	Selected altitude
35	Selected speed
36	Selected mach
37	Selected vertical speed
38	Selected heading
39	Selected flight path
40	Selected decision height
41	EFIS display format
42	Multi function /Engine / Alerts display format

AMC3--CAT.IDE.A.190 Flight data recorder

PERFORMANCE SPECIFICATIONS FOR THE PARAMETERS TO BE RECORDED FOR AEROPLANES FIRST ISSUED WITH AN INDIVIDUAL ~~CERTIFICATE OF AIRWORTHINESS~~ **C OF A** ON OR AFTER 1 APRIL 1998 AND BEFORE 1 JANUARY 2016

EU-OPS Subpart F-I | Revised rule text

Table 1: of AMC3-CAT.IDE.A.190 Flight data recorder FDR

No.	Parameter	Range	Sampling interval in seconds	Accuracy limits (sensor input compared to FDR readout)	Recommended resolution in readout	Remarks
1a or 1b	Time Relative Time Count	24 hours 0 to 4 095	4	± 0.125 % per hour	1 second	(a) UTC time preferred where available. (b) Counter increments every 4 seconds of system operation.
2	Pressure altitude	-1 000 ft to maximum certificated altitude of aircraft +5 000 ft	1	±100 ft to ±700 ft Refer to table Table II-A.3 of EUROCAE Document ED-112	5 ft	Should be obtained from air data computer when installed.
3	Indicated air speed	50 kt or minimum value installed pitot static system to Max V _{SO} Max V _{SO} to 1•2 V _d	1	±5 % ±3 %	1 kt (0.5 kt recommended)	Should be obtained from air data computer when installed. V _{SO} : stalling speed or minimum steady flight speed in the landing configuration V _D V _{DF} design diving speed
4	Heading	360°	1	±2°	0.5°	
5	Normal acceleration	-3 g to +6 -g	0.125	±1 % of range excluding a datum error of 5 %	0.004 g	The recording resolution may be rounded from 0.004 g to 0.01 g provided that one sample is recorded at full resolution at least every 4 seconds.
6	Pitch attitude	±75°	0.25	±2°	0.5°	
7	Roll attitude	±180°	0.5	±2°	0.5°	

EU-OPS Subpart F-I | Revised rule text

No.	Parameter	Range	Sampling interval in seconds	Accuracy limits (sensor input compared to FDR readout)	Recommended resolution in readout	Remarks
8	Manual radio transmission keying	Discrete	1	-	-	Preferably each crew member but one discrete acceptable for all transmissions provided that the replay of a recording made by any required recorder can be synchronised in time with any other required recording to within 1 second.
9a	Propulsive thrust / power on each engine	Full range	Each engine each second	$\pm 2\%$	0.2 % of full range	Sufficient parameters e.g. EPR/N, or Torque/N _p as appropriate to the particular engine must be recorded to determine power in both normal and reverse thrust. A margin for possible overspeed should be provided.
9b	Flight crew compartment thrust / power lever position	Full range	Each lever each second	$\pm 2\%$ or sufficient to determine any gated position	2 % of full range	Parameter 9b must be recorded for aeroplanes with non-mechanically linked cockpit-engine controls, otherwise recommended.
10	Trailing edge flap or flight crew compartment control selection	Full range or each discrete position	2	$\pm 3^\circ$ or as pilot's indicator and sufficient to determine each discrete position	0.5 % of full range	Flap position and cockpit control may be sampled at 4 seconds intervals so as to give a data point each 2 seconds.
11	Leading edge flap or flight crew	Full range or each discrete position	1	$\pm 3^\circ$ or as pilot's indicator and sufficient to determine each discrete position	0.5 % of full range	Left and right sides, or flap position and cockpit control may be sampled at 2 seconds intervals so as to give a data point each

EU-OPS Subpart F-I | Revised rule text

No.	Parameter	Range	Sampling interval in seconds	Accuracy limits (sensor input compared to FDR readout)	Recommended resolution in readout	Remarks
	compartment control selection					second.
12	Thrust reverser status	Turbo-jet: stowed, in transit and reverse Turbo-prop: reverse	Each reverser each second	-	-	Turbo-jet: 2 discretes enable the 3 states to be determined Turbo-prop: 1 discrete
13	Ground spoiler and/or speed brake selection	Full range or each discrete position	0.5	±2° unless higher accuracy uniquely required	0.2 % of full range	Sufficient to determine use of the cockpit selector and the activation and positions of the surfaces
14	Outside air temperatures or total air temperature	-50°C to +90°C or available sensor range	2	±2°C	0.3°C	
15	Autopilot/ Autothrottle / AFCS mode and engagement status	A suitable combination of discretes	1	-	-	Discretes should show which systems are engaged and which primary modes are controlling the flight path and speed of the aircraft.
16	Longitudinal acceleration	± 1 g	0.25	±1.5 % of maximum range excluding a datum	0.004 g	The recording resolution may be rounded from 0.004 g to 0.01 g provided that one

EU-OPS Subpart F-I | Revised rule text

No.	Parameter	Range	Sampling interval in seconds	Accuracy limits (sensor input compared to FDR readout)	Recommended resolution in readout	Remarks
	(Body axis)			error of $\pm 5\%$		sample is recorded at full resolution at least every 4 seconds.
17	Lateral acceleration	$\pm 1\text{ g}$	0.25	$\pm 1.5\%$ of maximum range excluding a datum error of $\pm 5\%$	0.004 g	The recording resolution may be rounded from 0.004 g to 0.01 g provided that one sample is recorded at full resolution at least every 4 seconds.
18	Primary flight controls, control surface positions and/or* pilot input	Full range	1	$\pm 2^\circ$ unless higher accuracy uniquely required	0.2 % of full range	*For aeroplanes that can demonstrate the capability of deriving either the control input or control movement (one from the other) for all modes of operation and flight regimes, the "or" applies. For aeroplanes with non-mechanical control systems the "and" applies.
18a	Pitch axis		0.25			Where the input controls for each pilot can be operated independently, both inputs will need to be recorded.
18b	Roll axis		0.25			
18c	Yaw axis		0.5			For multiple or split surfaces, a suitable combination of inputs is acceptable in lieu of recording each surface separately.
19	Pitch trim position	Full range	1	$\pm 3\%$ unless higher accuracy uniquely required	0.3 % of full range	Where dual surfaces are provided it is permissible to record each surface alternately.
20	Radio altitude	-20 ft to +2 500 ft	1	As installed $\pm 2\text{ ft}$ or $\pm 3\%$ whichever is greater below 500 -ft and $\pm 5\%$ above 500 -ft recommended.	1 ft below 500 -ft, 1 ft +0.5 % of full range above	For autoland/category 3-III operations, each radio altimeter should be recorded, but arranged so that at least one is recorded each second.

EU-OPS Subpart F-I | Revised rule text

No.	Parameter	Range	Sampling interval in seconds	Accuracy limits (sensor input compared to FDR readout)	Recommended resolution in readout	Remarks
					500 ft	
21	Vertical beam deviation		1	As installed ±3 % recommended	0.3 % of full range	Data from both the ILS and MLS systems need not to be recorded at the same time. The approach aid in use should be recorded.
21a	ILS Glide path	±0.22 DDM or available sensor range as installed				For autoland/ category III operations, each radio altimeter should be recorded, but arranged so that at least one is recorded each second.
21b	MLS Elevation	0.9° to 30°				
21	Vertical beam deviation		1	As installed ±3% recommended	0.3% of full range	Data from both the ILS and MLS systems need not to be recorded at the same time. The approach aid in use should be recorded.
21a	ILS Glide path	±0.22 DDM or available sensor range as installed				For autoland/category 3 operations, each radio altimeter should be recorded, but arranged so that at least one is recorded each second.
21b	MLS Elevation	0.9° to 30°				
22	Horizontal	Signal range	1	As installed	0.3 % of full	See parameter 21 remarks.

EU-OPS Subpart F-I | Revised rule text

No.	Parameter	Range	Sampling interval in seconds	Accuracy limits (sensor input compared to FDR readout)	Recommended resolution in readout	Remarks
	beam deviation			±3 % recommended	range	
22a	ILS Localizer	±0.22 DDM or available sensor range as installed				
22b	MLS Azimuth	±62°				
23	Marker beacon passage	Discrete	1	-	-	A single discrete is acceptable for all markers.
24	Warnings	Discretes	1	-	-	A discrete must be recorded for the master warning. Each "red" warning (including lavatory smoke) should be recorded when the warning condition cannot be determined from other parameters or from the cockpit voice recorder.
25	Reserved	-	-	-	-	
26	Reserved	-	-	-	-	
27	Landing gear squat switch status	Discrete(s)	1 (0.25 recommended for main gears)	-	-	Discretes should be recorded for the nose and main landing gears.

EU-OPS Subpart F-I | Revised rule text

No.	Parameter	Range	Sampling interval in seconds	Accuracy limits (sensor input compared to FDR readout)	Recommended resolution in readout	Remarks
28	Ground proximity warning system (GPWS)	Discrete	1	-	-	A suitable combination of discretes unless recorder capacity is limited in which case a single discrete for all modes is acceptable.
29	Angle of attack	As installed	0.5	As installed	0.3 % of full range	If left and right sensors are available, each may be recorded at 1 second intervals so as to give a data point each half second.
30a	Hydraulic power					
30b	Pneumatic power					
31	Groundspeed	As installed	1	Data should be obtained from the most accurate system	1 kt	Additional recommended parameters are given in table II-A.1 of EUROCAE Document ED-112
30	Low pressure warning	Discrete(s) or available sensor range	2	-	0.5 % of full range	Each essential system to be recorded
30a	Hydraulic power					

EU-OPS Subpart F-I | Revised rule text

No.	Parameter	Range	Sampling interval in seconds	Accuracy limits (sensor input compared to FDR readout)	Recommended resolution in readout	Remarks
30b	Pneumatic power					
31	Groundspeed	As installed	1	Data should be obtained from the most accurate system	1 kt	Additional recommended parameters are given in table II-A.1 of EUROCAE Document ED-112
32	Landing gear or gear selector position	Discrete(s)	4	-	-	A suitable combination of discretes should be recorded.
33	Selected barometric setting (each pilot station)	As installed	64	As installed	1 mb	Where practicable, a sampling interval of 4 seconds is recommended
33 a	Pilot					
33 b	Co-pilot					
34	Selected altitude	As installed	1	As installed	100 ft	Where capacity is limited a sampling interval of 64 seconds is permissible
34 a	Manual					

EU-OPS Subpart F-I | Revised rule text

No.	Parameter	Range	Sampling interval in seconds	Accuracy limits (sensor input compared to FDR readout)	Recommended resolution in readout	Remarks
34 b	Automatic					
35	Selected speed	As installed	1	As installed	1 kt	Where capacity is limited a sampling interval of 64 seconds is permissible
35 a	Manual					
35 b	Automatic					
36	Selected Mach	As installed	1	As installed	0.01	Where capacity is limited a sampling interval of 64 seconds is permissible
36 a	Manual					
36 b	Automatic					
37	Selected vertical speed	As installed	1	As installed	100 ft/min	Where capacity is limited a sampling interval of 64 seconds is permissible
37 a	Manual					
37	Automatic					

EU-OPS Subpart F-I | Revised rule text

No.	Parameter	Range	Sampling interval in seconds	Accuracy limits (sensor input compared to FDR readout)	Recommended resolution in readout	Remarks
b						
38	Selected heading	360 degrees	1	As installed	1 degree	Where capacity is limited a sampling interval of 64 seconds is permissible
39	Selected flight path		1	As installed		Where capacity is limited a sampling interval of 64 seconds is permissible
39 a	Course/DST RK	360 degrees				
39 b	Path Angle	As installed				
40	Selected decision height	0-500 ft	64	As installed	1 ft	
41	EFIS display format	Discrete(s)	4	-	-	Discretess should show the display system status e.g. off, normal, fail, composite, sector, plan, rose, nav aids, wxr, range, copy.
41 a	Pilot					
41 b	Co-pilot					

EU-OPS Subpart F-I | Revised rule text

No.	Parameter	Range	Sampling interval in seconds	Accuracy limits (sensor input compared to FDR readout)	Recommended resolution in readout	Remarks
42	Multifunction / Engine / Alerts display format	Discrete(s)	4	-	-	Discretes should show the display system status e.g. off, normal, fail, and the identity of display pages for emergency procedures and checklists. Information in checklists and procedures need not be recorded.

AMC4--CAT.IDE.A.190 Flight data recorder

LIST OF PARAMETERS TO BE RECORDED FOR AEROPLANES FIRST ISSUED WITH AN INDIVIDUAL CERTIFICATE OF AIRWORTHINESS **OF A** ON OR AFTER 1 JUNE 1990 UP TO AND INCLUDING 31 MARCH 1998

1. The ~~flight data recorder~~**FDR** should, with reference to a timescale, record:
 - a. the parameters listed in Table 1-~~AMC3CAT.IDE.A.190~~ below; **and**
 - b. the additional parameters listed in Table 2-~~AMC3-CAT.IDE.A.190~~ below for those aeroplanes with an **MCTOM exceeding 27 000 kg**.~~maximum certificated take-off mass exceeding 27 000 kg.~~
2. When determined by the Agency, the ~~flight data recorder~~**FDR** of aeroplanes having an **MCTOM** ~~maximum certificated take-off mass~~ of 27 000 kg or below **does** not need to record parameters 14 and 15b of Table 1-~~AMC3-CAT.IDE.A.190~~ below if any of the following conditions are met:
 - a. the sensor is not readily available;
 - b. sufficient capacity is not available in the flight recorder system; **or**
 - c. a change is required in the equipment that generates the data.
3. When determined by the Agency, the ~~flight data recorder~~**FDR** of aeroplanes having an **MCTOM** ~~maximum certificated take-off mass~~ exceeding 27 000 kg; **does** not need to record parameter 15b of Table 1-~~AMC3CAT.IDE.A.190~~ below, and parameters 23, 24, 25, 26, 27, 28, 29, 30 and 31 of Table 2 **of** ~~AMC34-CAT.IDE.A.190~~ below, if any of the following conditions are met:
 - a. the sensor is not readily available;
 - b. sufficient capacity is not available in the ~~flight data recorder~~**FDR** system;
 - c. a change is required in the equipment that generates the data; **or**
 - d. for navigational data (NAV frequency selection, DME distance, latitude, longitude, ground speed and drift) the signals are not available in digital form; and
4. When determined by the Agency, the ~~flight data recorder~~**FDR** does not need to record individual parameters that can be derived by calculation from the other recorded parameters.
5. The parameters to be recorded should meet, as far as practicable, the performance specifications (~~recording ranges, maximum recording~~**sampling intervals, recording accuracy limits, and recording resolution in read-out**) defined in **Table 1 of AMC5-CAT.IDE.A.190** ~~Appendix 1 to this AMC.~~

Table 1:- ~~of AMC4-CAT.IDE.A.190~~ Flight data recorder – Aeroplanes with an MCTOM of more than 5 700 kg

No	Parameter
1	Time or relative time count

EU-OPS Subpart F-I | Revised rule text

No	Parameter
2	Pressure altitude
3	Indicated a Airspeed
4	Heading
5	Normal a Acceleration
6	Pitch attitude
7	Roll attitude
8	Manual radio transmission keying unless an alternate means to synchronise FDR and CVR recordings is provided
9	Power on each engine
10	Trailing edge flap or flight crew compartment control selection
11	Leading edge flap or flight crew compartment control selection
12	Thrust reverse position (for turbojet aeroplanes only)
13	Ground spoiler position and/or speed brake selection
14	Outside air temperature or T total a Air T temperature
15a	Autopilot engagement status
15b	Autopilot operating modes, autothrottle and AFCS systems engagement status and operating modes.

Table 2: of ~~AMC4-CAT.IDE.A.190~~ Flight data recorder - Additional parameters for aeroplanes with an MCTOM of more than 27 000 kg

No	Parameter
16	Longitudinal acceleration
17	Lateral acceleration
18	Primary flight controls - C control surface position and/or pilot input (pitch, roll and yaw)
19	Pitch trim position
20	Radio altitude
21	Glide path deviation
22	Localiser deviation

EU-OPS Subpart F-I | Revised rule text

No	Parameter
23	Marker beacon passage
24	Master warning
25	NAV 1 and NAV 2 frequency selection
26	DME 1 and DME 2 distance
27	Landing gear squat switch status
28	Ground proximity warning system (GPWS)
29	Angle of attack
30	Hydraulics, each system (low pressure)
31	Navigation data
32	Landing gear or gear selector position

EU-OPS Subpart F-I | Revised rule text

AMC5--CAT.IDE.A.190 Flight data recorder

PERFORMANCE SPECIFICATIONS FOR THE PARAMETERS TO BE RECORDED FOR AEROPLANES FIRST ISSUED WITH AN INDIVIDUAL CERTIFICATE OF AIRWORTHINESS **OF A** ON OR AFTER 1 JUNE 1990 UP TO AND INCLUDING 31 MARCH 1998

Table 1: of AMC5 CAT.IDE.A.190- Flight data recorder

No.	Parameter	Range	Sampling interval in seconds	Accuracy limits (sensor input compared to FDR readout)	Recommended resolution in readout	Remarks
1	Time or relative time count	24 hours	4	±0.125 % per hour	1 second	Co-ordinated Universal Time (UTC) preferred where available, otherwise elapsed time
2	Pressure altitude	-1 000 ft to maximum certificated altitude of aircraft +5 000 -ft	1	±100 ft to ±700 ft	5 ft	For altitude record error see EASA ETSO-C124a
3	Indicated air-speed	50 kt to max V _{SO} Max V _{SO} to 1.2 V _d	1	±5 % ±3 %	1 kt	V _{SO} stalling speed or minimum steady flight speed in the landing configuration V _{DF} —design diving speed
4	Heading	360°	1	±2°	0.5°	
5	Normal acceleration	-3 g to +6 g	0.125 ±	0.125 ±1 % of maximum range excluding a datum error of ±5 %	0.004 g	
6	Pitch attitude	±75°	1	±2°	0.5°	
7	Roll attitude	±180°	1	±2°	0.5°	

EU-OPS Subpart F-I | Revised rule text

No.	Parameter	Range	Sampling interval in seconds	Accuracy limits (sensor input compared to FDR readout)	Recommended resolution in readout	Remarks
8	Manual radio transmission keying	Discrete	1	-	-	On-off (one discrete). An FDR/CVR time synchronisation signal complying with 4.2.1 of EUROCAE ED-55 is considered to be an acceptable alternative means of compliance
9	Power on each engine	Full range	Each engine each second	±2 %	0.2 % of full range	Sufficient parameters e.g. EPR/N _P or Torque/N _P as appropriate to the particular engine should be recorded to determine power
10	Trailing edge flap or flight crew compartment control selection	Full range or each discrete position	2	±5 % or as pilot's indicator	0.5 % of full range	
11	Leading edge flap or flight crew compartment control selection	Full range or each discrete position	2	-	0.5 % of full range	
12	Thrust reverser position	Stowed, in transit and reverse	Each reverser each second	±2 % unless higher accuracy uniquely required	-	
13	Ground spoiler and/or speed brake selection	Full range or each discrete position	1	±2°	0.2 % of full range	
14	Outside air temperatures or total	Sensor range	2	-	0.3°	

EU-OPS Subpart F-I | Revised rule text

No.	Parameter	Range	Sampling interval in seconds	Accuracy limits (sensor input compared to FDR readout)	Recommended resolution in readout	Remarks
	air temperature					
15a	Autopilot engagement status	A suitable combination of discrettes	1		-	
15b	Autopilot operating modes, auto-throttle and AFCS systems engagement status and operating modes					
16	Longitudinal acceleration	± 1 g	0.25	±1.5 % of maximum range excluding a datum error of ±5 %	0.004 g	
17	Lateral acceleration	±1 g	0.25	±1.5 % of maximum range excluding a datum error of ±5 %	0.004 g	
18	Primary flight controls, control surface positions and/or pilot input (pitch, roll, yaw)	Full range	1	±2° unless higher accuracy uniquely required	0.2 % of full range	For aeroplanes with conventional control systems 'or' applies For aeroplanes with non-mechanical control systems 'and' applies For aeroplanes with split surfaces a suitable combination of inputs is acceptable in lieu of recording each surface separately
19	Pitch trim position	Full range	1	±3 % unless higher accuracy uniquely required	0.3 % of full range	

EU-OPS Subpart F-I | Revised rule text

No.	Parameter	Range	Sampling interval in seconds	Accuracy limits (sensor input compared to FDR readout)	Recommended resolution in readout	Remarks
20	Radio altitude	-20 ft to +2 500 ft	1	± 2 ft or ± 3 % whichever is greater below 500 ft and ± 5 % above 500 ft	1 ft below 500 ft, 1 ft +5 % of full range above 500 ft	As installed. Accuracy limits are recommended
21	Glide path deviation	Signal range	1	± 3 %	0.3 % of full range	As installed. Accuracy limits are recommended
22	Localiser deviation	Signal range	1	± 3 %	0.3 % of full range	As installed. Accuracy limits are recommended
23	Marker beacon passage	Discrete	1	-	-	A single discrete is acceptable for all markers
24	Master warning	Discrete	1	-	-	
25	NAV 1 and 2 frequency selection	Full range	4	As installed	-	
26	DME 1 and 2 distance	0-200 nm NM	4	As installed	-	Recording of latitude and longitude from INS or other navigation system is a preferred alternative
27	Landing gear squat switch status	Discrete	1	-	-	
28	Ground proximity warning system (GPWS)	Discrete	1	-	-	

EU-OPS Subpart F-I | Revised rule text

No.	Parameter	Range	Sampling interval in seconds	Accuracy limits (sensor input compared to FDR readout)	Recommended resolution in readout	Remarks
29	Angle of attack	Full range	0.5	As installed	0.3 % of full range	
30	Hydraulics	Discrete(s)	2	-	-	
31	Navigation data	As installed	1	As installed	-	
32	Landing gear or gear selector position	Discrete	4	As installed	-	

* The number in the left hand column reflects the serial number depicted in EUROCAE ED-112.

AMC6--CAT.IDE.A.190 Flight data recorder

LIST OF PARAMETERS TO BE RECORDED FOR AEROPLANES FIRST ISSUED WITH AN INDIVIDUAL CERTIFICATE OF AIRWORTHINESS **C of A** BEFORE 1 JUNE 1990

1. The ~~flight data recorder~~**FDR** should, with reference to a timescale, record:
 - a. the parameters listed in Table 1 ~~AMC4-CAT.IDE.A.190~~ below;
 - b. the additional parameters 6 to 15b of Table 2 ~~AMC4CAT.IDE.A.190~~ below, for aeroplanes with an **MCTOM** ~~maximum certificated take-off mass~~ exceeding 5 700 kg but not exceeding 27 000 kg and first issued with an individual ~~Certificate of Airworthiness~~**C of A** on or after 1 January 1989, when the following conditions are met:
 - i. sufficient capacity is available on a flight recorder system;
 - ii. the sensor is readily available; and
 - iii. a change is not required in the equipment that generates the data.
 - c. the additional parameters from 6 to 15b of Table 2 ~~of AMC4-CAT.IDE.A.190~~ below, for aeroplanes with a maximum certificated take-off mass exceeding 27 000 kg that are of a type first type certificated after 30 September 1969;
 - d. the additional parameters listed in Table 2 ~~of AMC64-CAT.IDE.A.190~~ below for aeroplanes with an **MCTOM** ~~maximum certificated take-off mass~~ exceeding 27 000 kg and first issued with an individual ~~Certificate of Airworthiness~~**C of A** on or after 1 January 1987, when the following conditions are met:
 - i. sufficient capacity is available on a flight recorder system;
 - ii. the sensor is readily available; and
 - iii. a change is not required in the equipment that generates the data.
2. When determined by the Agency, the ~~flight data recorder~~**FDR** of aeroplanes with an **MCTOM** ~~maximum certificated take-off mass~~ exceeding 27 000 kg that are of a type first type certificated after 30 September 1969 does not need to record the parameters 13, 14 and 15b in Table 2 ~~AMC4CAT.IDE.A.190~~ below, when any of the following conditions are met:
 - a. sufficient capacity is not available on a flight recorder system;
 - b. the sensor is not readily available; and
 - c. a change is required in the equipment that generates the data.
3. The parameters to be recorded should meet, as far as practicable, the performance specifications (~~recording ranges, maximum recording~~**sampling intervals, recording accuracy limits, and recording-resolution in read-out**) defined in ~~Table 1 of Appendix 1 to AMC3-CAT.IDE.A.190~~**AMC5-CAT.IDE.A.190**).
4. When so determined by the Agency, the ~~flight data recorder~~**FDR** does not need to record individual parameters that can be derived by calculation from the other recorded parameters.

EU-OPS Subpart F-I | Revised rule text

**Table 1: ~~AMC6CAT.IDE.A.190~~ Flight data recorder -
Aeroplanes with an MCTOM ~~maximum certified take-off mass~~ exceeding
5 -700 Kkg**

No.	Parameter
1	Time or relative time count
2	Pressure altitude
3	Indicated Airspeed
4	Heading
5	Normal Acceleration

The number in the left hand column reflects the serial number depicted in EUROCAE ED-112.

**Table 2: ~~AMC6 CAT.IDE.A.190~~
Additional parameters for aeroplanes under conditions of AMC64--
CAT.IDE.A.190, PARAGRAPHS 1 AND 2**

No	Parameter
6	Pitch attitude
7	Roll attitude
8	Manual radio transmission keying unless an alternate means to synchronise the FDR and CVR recordings is provided
9	Power on each engine
10	Trailing edge flap or flight crew compartment control selection
11	Leading edge flap or flight crew compartment control selection
12	Thrust reverse position (for turbojet aeroplanes only)
13	Ground spoiler position and/or speed brake selection
14	Outside air temperature (OAT) or total air temperature
15a	Autopilot engagement status
15b	Autopilot operating modes, autothrottle and AFCS, systems engagement status and operating modes.
16	Longitudinal acceleration
17	Lateral acceleration

EU-OPS Subpart F-I | Revised rule text

No	Parameter
18	Primary flight controls – Control surface position and/or pilot input (pitch, roll and yaw)
19	Pitch trim position
20	Radio altitude
21	Glide path deviation
22	Localiser deviation
23	Marker beacon passage
24	Master warning
25	NAV 1 and NAV 2 frequency selection
26	DME 1 and DME 2 distance
27	Landing gear squat switch status
28	Ground proximity warning system (GPWS)
29	Angle of attack
30	Hydraulics, each system (low pressure)
31	Navigation data (latitude, longitude, ground speed and drift angle)
32	Landing gear or gear selector position

* The number in the left hand column reflects the serial number depicted in EUROCAE ED-112.

AMC1-CAT.IDE.A.195 Data link recording

GENERAL

1. The ~~aircraft~~ **aeroplane** ~~shall~~ **should** be capable of recording the messages as specified in this AMC.
- 2 As a means of compliance with CAT.IDE.A.195(a), the recorder may be:**
 - a. the CVR;**
 - b. the FDR;**
 - c. a combination recorder when CAT.IDE.A.200 is applicable; or**
 - d. a dedicated flight recorder.**
- ~~23.~~ As a means of compliance with CAT.IDE.A.195 (a)(2), the operator should enable correlation by providing information ~~which~~ **that** allows an accident investigator to understand what data ~~was~~ **were** provided to the aeroplane and, when the provider identification is contained in the message, by which provider.

EU-OPS Subpart F-I | Revised rule text

34. The timing information associated with the data link communications messages required to be recorded by CAT.IDE.A.195 (a)(3) should be capable of being determined from the airborne-based recordings. This timing information should include at least the following:
- The time each message was generated;
 - The time any message was available to be displayed by the crew;
 - The time each message was actually displayed or recalled from a queue; **and**
 - The time of each status change.
45. The message priority should be recorded when it is defined by the protocol of the data link communication message being recorded.
56. The expression 'taking into account the system architecture', in CAT.IDE.A.195(a)(3), means that the recording of the specified information may be omitted if the existing source systems involved would require a major upgrade. The following should be considered:
- The extent of the modification required;
 - The down-time period; **and**
 - Equipment software development.
67. The intention is that new designs of source systems should include this functionality and support the full recording of the required information.
78. Data link communications messages that support the applications in Table 1 of ~~AMC2 CAT.IDE.A.195~~ **below** should be recorded.
9. Further details on the recording requirements can be found in the recording requirement matrix in Appendix D.2 of EUROCAE Document ED-93 (Minimum Aviation System Performance Specification for CNS/ATM Recorder Systems, dated November 1998)

Table 1: of ~~AMC1 CAT.IDE.A.195~~ Data link recording

Item No.	Application Type	Application Description	Required Recording Content
1	Data link initiation	This includes any application used to log on to, or initiate, a data link service. In future Air Navigation System (FANS)-1/A and Air Traffic Navigation (ATN), these are ATS Facilities Notification (AFN) and Context Management (CM), respectively.	C
2	Controller/pilot communication	This includes any application used to exchange requests, clearances, instructions and reports between the flight crew and air traffic controllers on the ground. In FANS-1/A and ATN, this includes the Controller Pilot Data Link Communications (CPDLC) application. It also includes applications used for the exchange of Oceanic Clearances (OCLs) and Departure Clearances (DCLs), as	C

EU-OPS Subpart F-I | Revised rule text

Item No.	Application Type	Application Description	Required Recording Content
		well as data link delivery of taxi clearances.	
3	Addressed surveillance	This includes any surveillance application in which the ground sets up contracts for delivery of surveillance data. In FANS-1/A and ATN, this includes the automatic dependent surveillance-contract (ADS-C) application,.	C, F2
4	Flight information	This includes any application used for delivery of flight information data to specific aeroplanes. This includes for example Data Link-Automatic Terminal Information Service (D-ATIS), Data Link-Operational Terminal Information Service (D-OTIS), text digital weather information services (D-METAR or TWIP), data link flight information service (D-FIS) , Data Link-Flight Information System (D-FIS) and Notice to Airmen (electronic NOTAM) delivery.	C
5	Aircraft Broadcast surveillance (↔)	This includes elementary and enhanced surveillance systems, as well as Automatic Dependent Surveillance-Broadcast (ADS-B) output data.	M*, F2
6	AOC data	This includes any application transmitting or receiving data used for AOC purposes (in accordance with the ICAO definition of AOC). Such systems may also process AAC messages, but there is no requirement to record AAC messages	M*
7	Graphics (↔)	This includes any application receiving graphical data to be used for operational purposes (i.e. excluding applications that are receiving such things as updates to manuals).	M* F1

GM1--CAT.IDE.A.195 Data link recording

GENERAL

1. The letters and expressions in Table 1 of AMC1-CAT.IDE.A.195 have the following meaning:
 - a- C: ~~c~~Complete contents recorded
 - b- M: ~~i~~Information that enables correlation with any associated records stored —separately from the aeroplane.
 - c- *: Applications that are to be recorded only as far as is practicable, given the —architecture of the system.
 - d- F1: ~~g~~Graphics applications may be considered as AOC messages when they are part of a data link communications application service run on an individual basis by the operator itself in the framework of the operational control.

EU-OPS Subpart F-I | Revised rule text

- e- F2: ~~ww~~ Where parametric data sent by the aeroplane, such as Mode S, is reported within the message, it should be recorded unless data from the same source is recorded on the FDR.
2. The definitions of the applications type in Tables 1 of AMC1-CAT.IDE.A.195 are described in Table 1 of ~~GM1-CAT.IDE.A.195~~ **below**.

Table 1: ~~GM1-CAT.IDE.A.195~~ Definitions of applications type

Item No.	Application Type	Messages	Comments
1	CM		CM is an ATN service
2	AFN		AFN is a FANS 1/A service
3	CPDLC		All implemented up and downlink messages to be recorded
4	ADS-C	FLIPCY ADS-C reports	All contract requests and reports recorded
		Position reports	Only used within FANS 1/A. Mainly Only used in oceanic and remote areas.
5	ADS-B	Surveillance data	Information that enables correlation with any associated records stored separately from the aeroplane.
6	D-FIS		D-FIS is an ATN service. All implemented up and downlink messages to be recorded
7	TWIP	TWIP messages	Terminal weather information for pilots
8	D-ATIS	ATIS messages	Refer to EUROCAE ED-89A dated December 2003. Data Link Application System Document (DLASD) for the "ATIS" Data Link Service
9	OCL	OCL messages	Refer to EUROCAE ED-106A dated March 2004. Data Link Application System Document (DLASD) for "Oceanic Clearance" (OCL) Datalink Service
10	DCL	DCL messages	Refer to EUROCAE ED-85A dated December 2003. Data Link Application System Document (DLASD) for "Departure Clearance" Data-Link Service
11	Graphics	Weather maps & other graphics	Graphics exchanged in the framework of procedures within the operational control, as specified in Part-OR. Information that enables correlation with any associated records stored separately from the aeroplane.
12	AOC	Aeronautical operational	Messages exchanged in the framework of procedures within the operational control, as specified in Part-OR.

EU-OPS Subpart F-I | Revised rule text

Item No.	Application Type	Messages	Comments
		control messages	Information that enables correlation with any associated records stored separately from the aeroplane. Definition in ED-112.
13	Surveillance	Downlinked Aircraft Parameters (DAP) CAP, SAP	As defined in ICAO Annex 10 Volume IV (Surveillance systems and ACAS). Use definition in ED-93.

AAC	Aeronautical Administrative Communications
ADS-B	Automatic Dependent Surveillance - Broadcast
ADS-C	Automatic Dependent Surveillance – Contract
AFN	Aircraft Flight Notification
AOC	Aeronautical Operational Control
ATIS	Automatic Terminal Information Service
ATSC	Air Traffic Service Communication
CAP	Controller Access Parameters
CPDLC	Controller Pilot Data Link Communications
CM	Configuration/Context Management
D-ATIS	Data link ATIS
D-FIS	Data link Flight Information Service
D-METAR	Data link meteorological airport report
DCL	Departure Clearance
FANS	Future Air Navigation System
FLIPCY	Flight Plan Consistency
OCL	Oceanic Clearance
SAP	System Access Parameters
TWIP	Terminal Weather Information for Pilots

AMC1-CAT.IDE.A.200 Combination recorder**GENERAL**

~~(a)~~ **1.A flight data and cockpit voice** combination recorder is a flight recorder that records:

- ~~1a.~~ all voice communications and aural environment required by **CAT.IDE.A.185 regarding CVRs**~~the relevant cockpit voice recorder paragraph~~; and
- ~~2b.~~ all parameters required by **CAT.IDE.A.190 regarding FDRs**~~the relevant flight data recorder paragraph~~,

EU-OPS Subpart F-I | Revised rule text

with the same specifications required by those paragraphs.

In addition a **flight data and cockpit voice** combination recorder may record data link communication messages and related information required by **CAT.IDE.A.195**~~the relevant data link recording paragraph.~~

(b)2. When two **flight data and cockpit voice** combination recorders are installed, one should be located near the flight crew compartment, in order to minimise the risk of data loss due to a failure of the wiring that gathers data to the recorder. The other should be located at the rear section of the aeroplane, in order to minimise the risk of data loss due to recorder damage in the case of a crash.

AMC1-CAT.IDE.A.205 Seats, seat safety belts, harnesses and child restraint devices

Comment [GCI83]: From ACJ OPS 1.730(a)(3)

CHILD RESTRAINT DEVICES (CRD)

1. A CRD is considered to be acceptable if:
 - a. ~~It~~ is a 'supplementary loop belt' manufactured with the same techniques and the same materials of the approved safety belts; or
 - b. ~~It~~ complies with paragraph 2 below.
2. Provided the CRD can be installed properly on the respective aircraft seat, the following CRDs are considered "acceptable":
 - a. CRDs approved for use in aircraft by ~~a~~**the** competent authority on the basis of a technical standard and marked accordingly~~;~~
 - b. CRDs approved for use in motor vehicles according to the UN standard ECE R 44, -03 or later series of amendments; ~~or~~
 - c. CRDs approved for use in motor vehicles and aircraft according to Canadian CMVSS 213/213.1; ~~or~~
 - d. CRDs approved for use in motor vehicles and aircraft according to US FMVSS No 213 and ~~are~~ manufactured to these standards on or after February 26, 1985. US approved CRDs manufactured after this date must bear the following labels in red letters:
 - i. "THIS CHILD RESTRAINT SYSTEM CONFORMS TO ALL APPLICABLE FEDERAL MOTOR VEHICLE SAFETY STANDARDS" and
 - ii. "THIS RESTRAINT IS CERTIFIED FOR USE IN MOTOR VEHICLES AND AIRCRAFT",~~-~~
 - e. CRDs qualified for use in aircraft according to the German "Qualification Procedure for Child Restraint Systems for Use in Aircraft" (TÜV Doc.: TÜV/958-01/2001); ~~and~~
 - f. ~~D~~devices approved for use in cars, manufactured and tested to standards equivalent to those listed above. The device must be marked with an associated qualification sign, which shows the name of the qualification organisation and a specific identification number, related to the associated

EU-OPS Subpart F-I | Revised rule text

qualification project. The qualifying organisation should be a competent and independent organisation that is acceptable to the competent authority.

3. Location

- a. Forward facing CRDs may be installed on both forward and rearward facing passenger seats but only when fitted in the same direction as the passenger seat on which **they are** ~~it is~~ positioned. Rearward facing CRDs can only be installed on forward facing passenger seats. A CRD may not be installed within the radius of action of an airbag, unless it is obvious that the airbag is deactivated or it can be demonstrated that there is no negative impact from the airbag.
- b. ~~An infant-child in a restraint device~~**CRD** should be located as near to a floor level exit as feasible.
- c. ~~An infant-child in a restraint device~~**CRD** should not hinder evacuation for any passenger.
- d. ~~An infant-child in a restraint device~~**CRD** should neither be located in the row (where rows are existing) leading to an emergency exit nor located in a row immediately forward or aft of an emergency exit. A window passenger seat is the preferred location. An aisle passenger seat or a cross aisle passenger seat that forms part of the evacuation route to exits is not recommended. Other locations may be acceptable provided the access of neighbour passengers to the nearest aisle is not obstructed by the CRD.
- e. For complex motor-powered aircraft involved in commercial air transport **operations**, in general, only one CRD per row segment is recommended. More than one CRD per row segment is allowed if the **infants/children** are from the same family or travelling group provided the **infants/children** are accompanied by a responsible ~~person~~**adult** sitting next to them.
- f. A row segment is the fraction of a row separated by two aisles or by one aisle and the aircraft fuselage.

4. Installation

- a. CRDs should only be installed on a suitable aeroplane seat with the type of connecting device they are approved or qualified for. E.g., CRDs to be connected by a three point harness only (most rearward facing baby CRDs currently available) should not be attached to an aeroplane seat with a lap belt only; a CRD designed to be attached to a vehicle seat **only** by means of rigid bar lower anchorages (ISO-FIX or US equivalent)~~only~~, should only be used on aeroplane seats that are equipped with such connecting devices and should not be attached by the aeroplane seat lap belt. The method of connecting should be the one shown in the manufacturer's instructions provided with each CRD.
- b. All safety and installation instructions should be followed carefully by the responsible ~~person~~**adult** accompanying the infant/~~child~~**child**. Cabin crew should prohibit the use of any inadequately installed CRD or not qualified seat.
- c. If a forward facing CRD with a rigid backrest is to be fastened by a lap belt, the restraint device should be fastened when the backrest of the passenger seat on which it rests is in a reclined position. Thereafter, the backrest is to be

EU-OPS Subpart F-I | Revised rule text

positioned upright. This procedure ensures better tightening of the CRD on the aircraft seat if the aircraft seat is reclinable.

- d. The buckle of the adult safety belt must be easily accessible for both opening and closing, and must be in line with the seat belt halves (not canted) after tightening.
- e. Forward facing restraint devices with an integral harness must not be installed such that the adult safety belt is secured over the **infant**/child.

5. Operation

- a. Each CRD should remain secured to a passenger seat during all phases of flight, unless it is properly stowed when not in use.
- b. Where a CRD is adjustable in recline it must be in an upright position for all occasions when passenger restraint devices are required.

AMC2-CAT.IDE.A.205 Seats, seat safety belts, harnesses and child restraint devices

SAFETY HARNESS

~~Safety harness should have four anchorage points and should include shoulder straps (two anchorage points) and a seat belt (two anchorage points) which may be used independently.~~

Comment [GC184]: Definition moved to IR level and re-drafted.

- 1. A safety harness having five anchorage points is deemed to be compliant ~~to~~**with** the requirement for safety harness with four anchorage points,
- 2. A safety belt with diagonal shoulder strap (~~3~~**three** anchorage points) is deemed to be compliant with safety belt (~~2~~**two** anchorage points).

AMC3--CAT.IDE.A.205 Seats, seat safety belts, harnesses and child restraint devices

CABIN CREW SEATS

Seats for the minimum required cabin crew members should be located near required floor level emergency exits close to the emergency exits and where cabin crew members can best assist passengers in the event of an emergency evacuation. Such seats ~~shall~~ **should** be forward or rearward facing within 15° of the longitudinal axis of the aeroplane.

AMC1-CAT.IDE.A.215 Internal doors and curtains

PLACARDS' INDICATION

Placards on each internal door, or next to a curtain, that is the means of access to a passenger emergency exit, should indicate that it should be secured open during take off and landing.

AMC1--CAT.IDE.A.220 First-aid kit

Comment [GC185]: Accommodates
AMC OPS 1.745

CONTENT OF FIRST_AID KIT

1. ~~First-Aid~~ ~~aid~~ ~~kits~~ (FAKs) should be equipped with appropriate and sufficient medications and instrumentation. However, these kits may be amended by the operator according to the characteristics of the operation (scope of operation, flight duration, number and demographics of passengers etc.).
2. The following should be included in the ~~FAKs~~ **first-aid kit**:
 - a. ~~Equipment~~:
 - i. ~~B~~**b**andages (assorted sizes);
 - ii. ~~B~~**b**urns dressings (unspecified);
 - iii. ~~W~~**w**ound dressings (large and small);
 - iv. ~~A~~**a**dhesive dressings (assorted sizes);
 - v. ~~A~~**a**dhesive tape;
 - vi. ~~A~~**a**dhesive wound closures;
 - vii. ~~S~~**s**afety pins;
 - viii. ~~S~~**s**issors;
 - ix. ~~A~~**a**ntiseptic wound cleaner;
 - x. ~~D~~**d**isposable resuscitation aid;
 - xi. ~~D~~**d**isposable gloves;
 - xii. ~~T~~**t**weezers: splinter; **and**
 - xiii. ~~T~~**t**hermometers (non mercury).
 - b. ~~Medications~~:
 - i. ~~S~~**s**imple analgesic (may include liquid form);
 - ii. ~~A~~**a**ntiemetic;
 - iii. ~~N~~**n**asal decongestant;
 - iv. ~~G~~**g**astrointestinal antacid, in the case of aeroplanes carrying more than ~~nine~~**nine** passengers;
 - v. ~~A~~**a**nti-diarrhoeal medication, in the case of aeroplanes carrying more than ~~9~~**nine** passengers; **and**
 - vi. ~~A~~**a**ntihistamine.
 - c. ~~Other~~:
 - i. ~~A~~**a** list of contents in at least ~~2~~**two** languages (English and one other). This should include information on the effects and side effects of medications carried;
 - ii. ~~F~~**f**irst-aid handbook, current edition;
 - iii. ~~M~~**m**edical incident report form;
 - iv. ~~B~~**b**iohazard disposal bags; **and**

EU-OPS Subpart F-I | Revised rule text

- v. ~~E~~ground/~~A~~air visual signal code for use by survivors.
- d. An eye irrigator, whilst not required to be carried in the ~~FAK~~**first-aid kit**, should, where possible, be available for use on the ground.
- e. **For security reasons, items such as scissors and scalpels should be stored securely.**

AMC2--CAT.IDE.A.220 First-aid kit

MAINTENANCE OF FIRST AID KITS

To be maintained, first aid kits should be:

1. inspected periodically to confirm, to the extent possible, that contents are maintained in the condition necessary for their intended use; and
2. replenished at regular intervals, in accordance with instructions contained on their labels, or as circumstances warrant.

AMC1--CAT.IDE.A.225 Emergency medical kit

Comment [GCI86]: From AMC OPS 1.755

CONTENT OF EMERGENCY MEDICAL KIT

1. Emergency ~~m~~Medical ~~k~~kits (~~EMKs~~)—should be equipped with appropriate and sufficient medications and instrumentation. However, these kits should be adapted by the operator according to the characteristics of the operation (scope of operation, flight duration, number and demographics of passengers etc.).
2. The following should be included in the ~~EMK~~**emergency medical kit**:
 - a. Equipment~~±~~:
 - i. ~~S~~sphygmomanometer – non mercury;
 - ii. ~~S~~stethoscope;
 - iii. ~~S~~syringes and needles;
 - iv. IV cannulae (if IV fluids are carried in the FAK a sufficient supply of IV cannulae should be stored there as well);
 - v. Oropharyngeal airways (~~3~~**three** sizes);
 - vi. ~~T~~tourniquet;
 - vii. ~~D~~isposable gloves;
 - viii. ~~N~~eedle disposal ~~b~~Box;
 - ix. ~~O~~ne or more urinary catheter(s), appropriate for either sex, and anaesthetic gel.;
 - x. ~~B~~basic delivery kit;
 - xi. ~~B~~bag-valve masks (masks ~~2~~**two** sizes: ~~one~~**one**± for adults, ~~one~~**one**± for children);
 - xii. ~~T~~hermometer - non-mercury;
 - xiii. ~~F~~orceps;

EU-OPS Subpart F-I | Revised rule text

- xiv. ~~I~~ntubation set;
 - xv. ~~A~~spirator;
 - xvi. ~~B~~lood glucose testing equipment; **and**
 - xvii. ~~S~~scalpel.
- b. Instructions: ~~T~~he instructions should contain a list of contents (medications in trade names and generic names) in at least ~~2~~-**two** languages. This should include information on the effects and side effects of medications carried. **There should also be b**asic instructions for use of the medications in the kit **and-** ACLS Cards (summarising and depicting the current algorithm for ~~A~~advanced ~~c~~ardiac ~~H~~life ~~S~~upport).
- c. Medications:
- i. ~~C~~oronary vasodilator e.g. Glyceriltrinitrate---oral;
 - ii. ~~a~~Antispasmodic iii. Epinephrine/Adrenaline 1:1 000 (if a cardiac monitor is available);
 - iv. ~~a~~Adrenocorticoid - "injectable";
 - v. ~~m~~Major analgesic;
 - vi. ~~d~~Diuretic – injectable;
 - vii. A**ntihistamine, oral and injectable form;
 - viii. S**edative/anticonvulsant, injectable rectal and oral forms of sedative;
 - ix. M**edication for hypoglycaemia e.g. hypertonic glucose;
 - x. ~~A~~ntiemetic;
 - xi. ~~A~~tropine– injectable;
 - xii. ~~B~~ronchial dilator – injectable or inhaled form;
 - xiii. IV fluids, in appropriate quantity e.g. Sodiumchloride 0.,9 % (minimum 250 ml);
 - xiv. ~~A~~cetylsalicyl Acid (Aspirine) 300 mg in oral and / or injectable form;
 - xv. ~~A~~ntiarhythmic - if a monitoring device is carried;
 - xvi. ~~A~~ntihypertensive medication;
 - xvii. ~~B~~eta-blocker – oral.

Note:* Epinephrine/Adrenaline 1:10 000 can be a dilution of epinephrine 1:1 000

- d. The carriage of automatedexternaldefibrillators**s**hould be determined by operators on the basis of a riskassessment**t**takinginto account the particularneeds of the operation.
- e. The automated external defibrillator should be carried on the aircraft however, not necessarily in the emergency medical kit.
- f. For security reasons, items such as scissors should be stored securely.

EU-OPS Subpart F-I | Revised rule text

AMC2-CAT.IDE.A.225 Emergency medical kit

CARRYING UNDER SECURITY CONDITIONS

Where possible the emergency medical kit should be carried on the flight ~~deck~~**crew compartment**.

AMC3-CAT.IDE.A.225 Emergency medical kit

ACCESS TO EMERGENCY MEDICAL KIT

1. The commander should limit access to the emergency medical kit, taking into account the actual situation on board.
2. Drugs should be administered by medical doctors, qualified nurses, paramedics or emergency medical technicians.
3. Medical Students, student paramedics, student emergency medical technicians or nurses aids should only administer drugs if no person mentioned in 2. is on board the flight and appropriate advice has been received.
4. Oral drugs should not be denied in medical emergency situations where no medically qualified persons are on board the flight.

AMC4-CAT.IDE.A.225 Emergency medical kit

MAINTENANCE OF EMERGENCY MEDICAL KIT

In order to maintain the emergency medical kit the operator should ensure that the emergency medical kits are:

1. ~~I~~nspected periodically to confirm, to the extent possible, that the contents are maintained in the condition necessary for their intended use; and
2. ~~R~~eplenished at regular intervals, in accordance with instructions contained on their labels, or as circumstances warrant.

GM1-CAT.IDE.A.230 First aid oxygen

Comment [GC187]: From IEM OPS 1.760

GENERAL

1. First aid oxygen is intended for those passengers who, having been provided with the oxygen required under ~~CAT.IDE.A.315~~**235 or CAT.IDE.A.240**, still need to breathe undiluted oxygen when the amount of oxygen has been exhausted.
2. When calculating the amount of first-aid oxygen, ~~an~~**the** operator should take into account the fact that, following a cabin depressurisation, supplemental oxygen as calculated in accordance with Table 1 ~~of~~ **of** ~~CAT.IDE.A.315~~**235** and Table 2 ~~of~~ **of** ~~CAT.IDE.A.315~~**235** and Table 2 ~~of~~ **of** ~~CAT.IDE.A.315~~**240** should be sufficient to cope with potential effects of hypoxia for:
 - a. all passengers when the cabin altitude is above 15 000 ft; and
 - b. a proportion of the passengers carried when the cabin altitude is between 10 -000 ft and 15 000 ft.

EU-OPS Subpart F-I | Revised rule text

3. For the above reasons, the amount of first-aid oxygen should be calculated for the part of the flight after cabin depressurisation during which the cabin altitude is between 8 000 ft and 15 000 ft, when supplemental oxygen may no longer be available.
4. Moreover, following cabin depressurisation an emergency descent should be carried out to the lowest altitude compatible with the safety of the flight. In addition, in these circumstances, the aeroplane should land at the first available aerodrome at the earliest opportunity.
5. The conditions above may reduce the period of time during which the first-aid oxygen may be required and consequently may limit the amount of first-aid oxygen to be carried on board.
6. **Means may be provided to decrease the flow to not less than two litres per minute, STPD, at any altitude.**

AMC1-CAT.IDE.A.235 Supplemental oxygen – pressurised aeroplanes**GENERAL**

1. In the determination of the amount of oxygen required for the routes to be flown, it is assumed that the aeroplane will descend in accordance with the emergency procedures specified in the operations manual, without exceeding its operating limitations, to a flight altitude that will allow the flight to be completed safely (i.e. flight altitudes ensuring adequate terrain clearance, navigational accuracy, hazardous weather avoidance etc.).
2. The amount of oxygen should be determined on the basis of cabin pressure altitude, flight duration and, for pressurised aeroplanes, on the assumption that a cabin pressurisation failure will occur at the pressure altitude or point of flight that is most critical from the standpoint of oxygen need.
3. Following a cabin pressurisation failure, the cabin pressure altitude should be considered to be the same as the aeroplane pressure altitude, unless it can be demonstrated to the competent authority that no probable failure of the cabin or pressurisation system will result in a cabin pressure altitude equal to the aeroplane pressure altitude. Under these circumstances, the demonstrated maximum cabin pressure altitude may be used as a basis for determination of oxygen supply.

AMC2--CAT.IDE.A.235 Supplemental oxygen – pressurised aeroplanes**OXYGEN REQUIREMENTS FOR FLIGHT CREW COMPARTMENT SEAT OCCUPANTS AND CABIN CREW CARRIED IN ADDITION TO THE REQUIRED MINIMUM NUMBER OF CABIN CREW**

1. **For the purpose of oxygen supply, flight crew compartment seat occupants who are:**
 - a. supplied with oxygen from the flight crew source of oxygen, should be considered as flight crew members; **and**
 - b. not supplied with oxygen by the flight crew source of oxygen, should be considered as passengers.

EU-OPS Subpart F-I | Revised rule text

2. Cabin crew members carried in addition to the minimum number of cabin crew and additional crew members should be considered as passengers for the purpose of oxygen supply.

AMC1--CAT.IDE.A.235-(e) Supplemental oxygen – pressurised aeroplanes

Comment [GCI88]: From ACJ OPS 1.770(b)(2)(v)

AEROPLANES NOT CERTIFICATED TO FLY ABOVE 25 000 FT

- (1) With respect to CAT.IDE.A.315–**235** (e) the maximum altitude up to which an aeroplane can operate without a passenger oxygen system being installed and capable of providing oxygen to each cabin occupant, should be established using an emergency descent profile which takes into account the following conditions:
 - (a) 17 seconds' time delay for pilot's recognition and reaction, including mask donning, for trouble shooting and configuring the aeroplane for the emergency descent (emergency descent data/charts established by the aeroplane manufacturer and published in the **a**Aircraft **f**Flight **m**Manual (AFM), and/or the AFM should be used to ensure uniform application of the option); **and**
 - (b) **m**Maximum **o**perational **s**peed (V_{MO}) or the airspeed approved in the AFM for emergency descent, (emergency descent data/charts established by the aeroplane manufacturer and published in the AFM, and/or AFM should be used to ensure uniform application of the option), whichever is the less;
- (2) On routes where the oxygen is necessary to be carried for 10 % of the passengers for the flight time between 10 000 ft and 13 000 ft, the oxygen may be provided by:
 - (a) a plug-in or drop-out oxygen system with sufficient outlets and dispensing units uniformly distributed throughout the cabin so as to provide oxygen to each passenger at his/her own discretion when seated on his/her assigned seat; or
 - (b) portable bottles, when a cabin crew member is carried on board such flight.

GM1--CAT.IDE.A.235 Supplemental oxygen – pressurised aeroplanes

Comment [GCI89]: From IEM OPS 1.770

QUICK DONNING MASKS

A quick donning mask is a type of mask that:

1. can be placed on the face from its ready position, properly secured, sealed and supplying oxygen upon demand, with one hand and within five seconds and will thereafter remain in position, both hands being free;
2. can be donned without disturbing eye glasses and without delaying the flight crew member from proceeding with assigned emergency duties;
3. once donned, does not prevent immediate communication between the flight crew members and other crew members over the aircraft intercommunication system; and
4. does not inhibit radio communications.

AMC1-CAT.IDE.A.240 --SUPPLEMENTAL Oxygen NON-pressurised aeroplanes

AMOUNT OF SUPPLEMENTAL OXYGEN

The amount of supplemental oxygen for sustenance for a particular operation should be determined on the basis of flight altitudes and flight duration, consistent with the operating ~~procedures~~ **procedures, including emergency procedures**, established for each operation in the Operations Manual and with ~~and~~ the routes to be flown, ~~and with the emergency procedures as~~ specified in the Operations Manual.

AMC1-CAT.IDE.A.245 Crew protective breathing equipment

PROTECTIVE BREATHING EQUIPMENT (PBE)

The supply for PBE for the flight crew members may be provided by the supplemental oxygen required in CAT.IDE.A.235 or CAT.IDE.A.240.

AMC1-CAT.IDE.A.250 Hand fire extinguishers

Comment [GCI90]: From AMC OPS 1.790

NUMBER, LOCATION AND TYPE

1. The number and location of hand fire extinguishers should be such as to provide adequate availability for use, account being taken of the number and size of the passenger compartments, the need to minimise the hazard of toxic gas concentrations and the location of toilets, galleys etc.. These considerations may result in the number of fire extinguishers being greater than the minimum prescribed.
2. There should be at least one **hand** fire extinguisher installed in the flight crew compartment and this should be suitable for fighting both flammable fluid and electrical equipment fires. Additional **hand fire** extinguishers may be required for the protection of other compartments accessible to the crew in flight. Dry chemical fire extinguishers should not be used in the flight crew compartment, or in any compartment not separated by a partition from the flight crew compartment, because of the adverse effect on vision during discharge and, if conductive, interference with electrical contacts by the chemical residues.
3. Where only one hand fire extinguisher is required in the passenger compartments it should be located near the cabin crew member's station, where provided.
4. Where two or more hand fire extinguishers are required in the passenger compartments and their location is not otherwise dictated by consideration of ~~paragraph~~ CAT.IDE.A.250 (b), an extinguisher should be located near each end of the cabin with the remainder distributed throughout the cabin as evenly as is practicable.
5. Unless an extinguisher is clearly visible, its location should be indicated by a placard or sign. Appropriate symbols may also be used to supplement such a placard or sign.

AMC1-CAT.IDE.A.255 Crash axes and crowbars**STORAGE OF CRASH AXES AND CROWBARS**

Crash axes and crowbars located in the passenger compartment should be stored in a position not visible to passengers.

AMC1-CAT.IDE.A.260 Marking of break-in points

COLOUR AND CORNERS' MARKING

1. The colour of the markings should be red or yellow and, if necessary, should be outlined in white to contrast with the background.
2. If the corner markings are more than 2 m apart, intermediate lines 9 centimetres (cm) x 3 cm should be inserted so that there is no more than 2 m between adjacent markings.

AMC1-CAT.IDE.A.270 Megaphones

Comment [GCI91]: From AMC OPS 1.810

LOCATION OF MEGAPHONES

1. Where one megaphone is required, it should be readily accessible at the assigned seat of a cabin crew member or crew members other than flight crew.
2. Where two or more megaphones are required, they should be suitably distributed in the passenger ~~cabin~~ **compartment(s)** and readily accessible to crew members assigned to direct emergency evacuations.
3. ~~Notwithstanding 1 and 2, there is no requirement for~~ **This does not necessarily require** megaphones to be positioned such that they can be physically reached by a crew member when strapped in a cabin crew member's seat.

AMC1-CAT.IDE.A.280 Emergency Locator Transmitter (ELT)

ELT BATTERIES

Batteries used in the ELTs should be replaced (or recharged, if the battery is rechargeable) when the equipment has been in use for more than 1 cumulative hour, and also when 50 % of their useful life (or for rechargeable, 50 % of their useful life of charge), as established by the equipment manufacturer has expired. The new expiry date for the replacement (or recharged) battery should be legibly marked on the outside of the equipment. The battery useful life (or useful life of charge) requirements of this paragraph do not apply to batteries (such as water-activated batteries) that are essentially unaffected during probable storage intervals.

AMC2-CAT.IDE.A.280 Emergency Locator Transmitter (ELT)

Comment [GCI92]: Contains ACJ OPS 1.820

TYPES OF ELT AND GENERAL TECHNICAL SPECIFICATIONS

1. The ELT required by this provision should be one of the following:
 - a. Automatic ~~f~~Fixed (ELT(AF)). An automatically activated ELT ~~which~~ **that** is permanently attached to an aeroplane and is designed to aid **search and rescue (SAR)** teams in locating the crash site;

EU-OPS Subpart F-I | Revised rule text

- b. Automatic ~~p~~Portable (ELT(AP)). An automatically activated ELT, ~~which~~**that** is rigidly attached to an aeroplane before a crash, but is readily removable from the aeroplane after a crash. It functions as an ELT during the crash sequence. If the ELT(**AP**) does not employ an integral antenna, the aeroplane-mounted antenna may be disconnected and an auxiliary antenna (stored on the ELT case) attached to the ELT. The ELT can be tethered to a survivor or a life raft. This type of ELT is intended to aid SAR teams in locating the crash site or survivor(s);
 - c. Automatic ~~D~~Deployable (ELT(AD)). ~~An ELT which~~**that** is rigidly attached to the aeroplane before the crash and ~~which~~**that** is automatically ejected, deployed and activated by an impact, and, in some cases, also by hydrostatic sensors. Manual deployment is also provided. This type of ELT should float in water and is intended to aid SAR teams in locating the crash site; or
 - d. Survival ELT (ELT(S)). An ELT ~~which~~**that** is removable from an aeroplane, stowed so as to facilitate its ready use in an emergency, and manually activated by a survivor. An ELT(S) may be activated manually or automatically (e.g. by water activation). It should be designed to be tethered to a life raft or a survivor.
2. To minimize the possibility of damage in the event of crash impact, the automatic ELT should be rigidly fixed to the aeroplane structure, as far aft as is practicable, with its antenna and connections arranged so as to maximize the probability of the signal being transmitted after a crash.
 3. Any ELT carried should operate in accordance with the relevant provisions of ICAO Annex 10, Volume III **communications systems** and should be registered with the national agency responsible for initiating search and rescue or other nominated agency.

Comment [xy93]: From ACJ 1.820

GM1-CAT.IDE.A.280 Emergency Locator Transmitter (ELT)

TERMINOLOGY

An ELT is a generic term describing equipment which broadcasts distinctive signals on designated frequencies and, depending on application, may be activated by impact or may be manually activated.

Comment [GCI94]: From AMC OPS 1.830(b)(2)

AMC1-CAT.IDE.A.285 Flight over water

LIFE ~~SAVING~~ RAFTS AND EQUIPMENT FOR MAKING DISTRESS SIGNALS - AEROPLANES

1. The following should be readily available with each life-raft:
 - a. ~~m~~Means for maintaining buoyancy;
 - b. ~~a~~A sea anchor;
 - c. ~~l~~ife-lines and means of attaching one life-raft to another;
 - d. ~~p~~Paddles for life-rafts with a capacity of ~~6~~**six** or less;
 - e. ~~m~~Means of protecting the occupants from the elements;
 - f. ~~a~~A water--resistant torch;

EU-OPS Subpart F-I | Revised rule text

- g. ~~s~~Signalling equipment to make the pyrotechnic distress signals described in ICAO Annex 2;
 - h. 100 g of glucose tablets for each ~~4~~**four**, or fraction of ~~four~~**4**, persons which the life-raft is designed to carry;
 - i. ~~a~~At least ~~two~~**2** litres of drinkable water provided in durable containers or means of making sea water drinkable or a combination of both; and
 - j. ~~f~~First-aid equipment.
2. As far as practicable, items listed in 1. should be contained in a pack.

~~GM1-CAT.IDE.A.285 Flight over water~~~~Seaplanes includes amphibians operated as seaplanes.~~

Comment [GCI95]: Moved to definitions in Cover Regulation

~~GM2-GM1-CAT.IDE.A.285 Flight over water~~

Comment [GCI96]: From IEM OPS 1.825

SEAT CUSHIONS

Seat cushions are not considered to be flotation devices.

~~AMC1--CAT.IDE.A.305 Survival equipment~~

Comment [GCI97]: From AMC OPS 1.835(c)

ADDITIONAL SURVIVAL EQUIPMENT

1. The following additional survival equipment should be carried when required:
 - a. ~~2~~**two** litres of drinkable water for each 50, or fraction of 50, persons on board provided in durable containers;
 - b. ~~o~~One knife;
 - c. ~~f~~First-~~a~~Aid ~~e~~Equipment; **and**
 - d. ~~o~~One set of ~~a~~Air/~~g~~Ground codes;
2. In addition, when polar conditions are expected, the following should be carried:
 - a. ~~a~~A means for melting snow;
 - b. ~~one~~**±** snow shovel and ~~one~~**±** ice saw;
 - c. ~~s~~Sleeping bags for use by 1/3 of all persons on board and space blankets for the remainder or space blankets for all passengers on board; **and**
 - d. ~~±~~**one** Arctic/Polar suit for each crew member carried.
3. If any item of equipment contained in the above list is already carried on board the aeroplane in accordance with another requirement, there is no need for this to be duplicated.

GM1-CAT.IDE.A.305 Survival equipment**SIGNALLING EQUIPMENT**

The signalling equipment for making distress signals is described in ICAO Annex 2, **Rules of the Air**.

GM2-CAT.IDE.A.305 Survival equipment

Comment [GCI98]: From IEM OPS 1.835

AREAS IN WHICH SEARCH AND RESCUE WOULD BE ESPECIALLY DIFFICULT

The expression 'areas in which search and rescue would be especially difficult' should be interpreted, in this context, as meaning:

1. ~~a~~ Areas so designated by the ~~competent~~ authority responsible for managing search and rescue; or
2. ~~a~~ Areas that are largely uninhabited and where:
 - a. ~~t~~ The ~~competent authority referred to in 1.~~ authority responsible for managing search and rescue has not published any information to confirm whether search and rescue would be or would not be especially difficult; and
 - b. ~~t~~ The ~~competent~~ authority referred to in 1. does not, as a matter of policy, designate areas as being especially difficult for search and rescue.

AMC1-CAT.IDE.A.325 Headset

Comment [GCI99]: From IEM OPS 1.650(p)/1.652(s)

Comment [GCI100]: From IEM OPS 1.650(p)/1.652(s)

GENERAL

1. A headset consists of a communication device ~~which~~ **that** includes two earphones to receive and a microphone to transmit audio signals to the aeroplane's communication system. To comply with the minimum performance requirements, the earphones and microphone should match the communication system's characteristics and the flight crew compartment environment. The headset should be sufficiently adjustable to fit the pilot's head. Headset boom microphones should be of the noise cancelling type.
2. If the intention is to utilise noise cancelling earphones, the operator should ensure that the earphones do not attenuate any aural warnings or sounds necessary for alerting the flight crew on matters related to the safe operation of the aeroplane.

GM1-CAT.IDE.A.325 Headset**GENERAL**

The term 'headset' includes any aviation helmet incorporating headphones and microphone worn by a flight crew member.

AMC1-CAT.IDE.A.345 Communication and nNavigation equipment for operations under IFR, or under VFR over routes not navigated by reference to visual landmarks**TWO INDEPENDENT MEANS OF COMMUNICATION**

Whenever two independent means of communication are required, each system should have an independent antenna installation, except where rigidly supported non-wire antennae or other antenna installations of equivalent reliability are used.

AMC2-CAT.IDE.A.345 Communication and navigation equipment for operations under IFR, or under VFR over routes not navigated by reference to visual landmarks

Comment [GCI101]: Contains ACJ OPS 1.865(c)(1)(i) and ACJ OPS 1.865(e)

ACCEPTABLE NUMBER AND TYPE OF COMMUNICATION AND NAVIGATION EQUIPMENT

1. An acceptable number and type of communication and navigation equipment is:
 - a. ~~One~~ **VHF omnidirectional radio range (VOR)** receiving system, one **automatic direction finder (ADF)** system, one **distance measuring equipment (DME)**, except that an ADF system need not be installed provided that the use of ADF is not required in any phase of the planned flight;
 - b. ~~One~~ **instrument landing system (ILS)** or **microwave landing system (MLS)** where ILS or MLS is required for approach navigation purposes;
 - c. ~~One~~ **marker beacon** receiving system where a Marker Beacon is required for approach navigation purposes;
 - d. ~~Area~~ **navigation equipment** when area navigation is required for the route being flown (e.g. equipment required by Part SPA);
 - e. ~~An~~ additional DME system on any route, or part thereof, where navigation is based only on DME signals;
 - f. ~~An~~ additional VOR receiving system on any route, or part thereof, where navigation is based only on VOR signals; and
 - g. ~~An~~ additional ADF system on any route, or part thereof, where navigation is based only on **non directional beacon (NDB)** signals.
2. ~~An~~ **Aeroplanes** may be operated without the navigation equipment specified in 1.e. and 1 f. provided ~~it is~~ **they are** equipped with alternative equipment. The reliability and the accuracy of alternative equipment should allow safe navigation for the intended route.
3. ~~An~~ **The** operator should ensure that aeroplanes conducting **extended range twin-engine operations (ETOPS)** have a communication means capable of communicating with an appropriate ground station at normal and planned contingency altitudes. For ETOPS routes where voice communication facilities are available, voice communications shall be provided. For all ETOPS operations beyond 180 minutes, reliable communication technology, either voice-based or data link, should be installed. Where voice communication facilities are not available and where voice communication is not possible or is of poor quality, communications using alternative systems should be ensured.
4. To perform IFR operations without an ADF system installed, ~~an~~ **the** operator should consider the following guidelines on equipment carriage, operational procedures and training criteria.
 - a. ADF equipment may only be removed from or not installed in an aeroplane intended to be used for IFR operations when it is not essential for navigation, and provided that alternative equipment giving equivalent or enhanced navigation capability is carried. This may be accomplished by the carriage of an additional VOR receiver or a GNSS receiver approved for IFR operations.
 - b. For IFR operations without ADF, ~~the~~ operator should ensure that:

EU-OPS Subpart F-I | Revised rule text

- i. route segments that rely solely on ADF for navigation are not flown;
 - ii. ADF/NDB procedures are not flown;
 - iii. ~~that~~ the **minimum equipment list (MEL)** has been amended to take account of the non-carriage of ADF;
 - iv. ~~that~~ the **Operations Manual** does not refer to any procedures based on NDB signals for the aeroplanes concerned; and
 - v. ~~that~~ flight planning and dispatch procedures are consistent with the above mentioned criteria.
- c. The removal of ADF should be taken into account by the operator in the initial and recurrent training of flight crew.
5. VHF communication equipment, ILS ~~Localiser~~ and VOR receivers installed on aeroplanes to be operated in IFR should comply with the following FM immunity performance standards:
- a. ICAO Annex 10-, Volume I - Radio Navigation Aids, and Volume III, Part II - Voice Communications Systems; ~~and-~~
 - b. ~~a~~Acceptable equipment standards contained in EUROCAE Minimum Operational Performance Specifications, documents ED-22B for VOR receivers, ED-23B for VHF communication receivers and ED-46B for LOC receivers and the corresponding **Radio Technical Commission for Aeronautics (RTCA)** documents DO-186, DO-195 and DO-196.

AMC3-CAT.IDE.A.345 Communication and nNavigation equipment for operations under IFR, or under VFR over routes not navigated by reference to visual landmarks

FAILURE OF A SINGLE UNIT

Required communication and navigation equipment should be installed such that the failure of any single unit required for either communication or navigation purposes, or both, will not result in the failure of another unit required for communications or navigation purposes.

AMC4--CAT.IDE.A.345 Communication and nNavigation equipment for operations under IFR, or under VFR over routes not navigated by reference to visual landmarks

Comment [GC1102]: From ACJ OPS 1.865(f)

HF - EQUIPMENT ON CERTAIN MNPS ROUTES

1. An HF - system is considered to be ~~l~~ong ~~r~~ange ~~c~~ommunication ~~e~~quipment.
2. Other two--way communication systems may be used if allowed by the relevant airspace procedures.
3. In the sense of this paragraph, the term 'short haul operations' is considered operations not crossing the North Atlantic.
- 4. When using one communication system only, the **competent A**uthority may restrict the **minimum navigation performance specifications (MNPS)** approval to the use of the specific routes.

EU-OPS Subpart F-I | Revised rule text

GM1-CAT.IDE.A.345 Communication and navigation equipment for operations under IFR, or under VFR over routes not navigated by reference to visual landmarks

APPLICABLE AIRSPACE REQUIREMENTS

For aeroplanes being operated under European air traffic control, the applicable airspace requirements include the Single European Sky legislation.

AMC1-CAT.IDE.A.350 Transponder

GENERAL SSR TRANSPONDER

1. The **secondary surveillance radar (SSR)** transponder of aeroplane being operated under European air traffic control should comply with any applicable Single European Sky legislation.
2. If the Single European Sky legislation is not applicable, the SSR transponder should operate in accordance with the relevant provisions of Volume IV of ICAO Annex 10.
3. Additional SSR transponder capabilities may be required by the applicable airspace requirements.

AMC1-CAT.IDE.A.355 Electronic navigation data management

Comment [GCI103]: Contains and updates ACJ OPS 1.873

NAVIGATION DATA PRODUCTS NEEDED FOR OPERATIONS IN ACCORDANCE WITH PART-SPA

1. When ~~an~~ **the** operator of a complex motor-powered aeroplane uses a navigation database which supports an airborne navigation application as a primary means of navigation, the navigation database supplier should hold a Type 2 ~~Letter of~~ **a**Acceptance (LoA), or equivalent.
2. If this airborne navigation application is needed for an operation requiring a specific approval in accordance with OPS.SPA, the operator's procedures should be based upon the Type 2 LoA acceptance process.
3. A Type 2 LoA is issued by the Agency in accordance with the Agency's Opinion Nr. 01/2005 on The Acceptance of Navigation Database Suppliers (hereinafter referred to as the Agency's Opinion Nr. 01/2005). The definitions of navigation database, navigation database supplier, data application integrator, Type 1 LoA and Type 2 LoA can be found in the Agency's Opinion Nr. 01/2005.
4. Equivalent to a Type 2 LoA is the FAA Type 2 LoA, issued in accordance with the Federal Aviation Administration (FAA) Advisory Circular AC 20-153, and the Transport Canada Civil Aviation (TCCA) 'Acknowledgement Letter of an Aeronautical Data Process' which uses the same basis.
5. EUROCAE ED-76/Radio Technical Commission for Aeronautics (RTCA) DO-200A Standards for Processing Aeronautical Data contains guidance relating to the processes which the supplier may follow.

JAR-OPS 3 Subparts F-I | Revised rule text

Scope

- This document shows the transposition of JAR-OPS Subpart F-I into the new European OPS rules.
- It also contains the related Section 2 material of JAR-OPS 3.
- Track changes show changes to the JAR-OPS text.

JAR-OPS 3 Subparts F-I | Revised rule text

Table of Contents

Part-CAT	5
SUBPART CAIRCRAFT PERFORMANCE AND OPERATING LIMITATIONS	5
Section 1 - Helicopters.....	5
Chapter 1 - General requirements.....	5
CAT.POL.H.100 Applicability	5
CAT.POL.H.105 General	5
CAT.POL.H.110 Obstacle accountability.....	7
GM1-CAT.POL.H.110(a)(2)(i) Obstacle accountability	11
COURSE GUIDANCE	11
AMC1-CAT.POL.H.205(b)(4) Take-off.....	13
The application of TODRH.....	13
GM1-CAT.POL.H.205(b)(4) Take-off	13
THE APPLICATION OF TODRH	13
Chapter 2 - PERFORMANCE CLASS 1	17
CAT.POL.H.200 General	17
CAT.POL.H.205 Take-off	17
CAT.POL.H.210 Take-off Flight Path	18
CAT.POL.H.215 En-route – critical engine inoperative	18
CAT.POL.H.220 Landing	19
CAT.POL.H.225 Helicopter operations at a public interest site	20
Chapter 3 - PERFORMANCE CLASS 2	21
CAT.POL.H.300 General	21
CAT.POL.H.305 Operations without an assured safe forced landing capability	21
CAT.POL.H.310 Take-off	22
CAT.POL.H.315 Take-off flight path	23
CAT.POL.H.320 En-route - critical engine inoperative	23
CAT.POL.H.325 Landing	23
Chapter 4 - PERFORMANCE CLASS 3	25
CAT.POL.H.400 General	25
CAT.POL.H.405 Take-off	25
CAT.POL.H.410 En-route.....	26
CAT.POL.H.415 Landing	26

JAR-OPS 3 Subparts F-I | Revised rule text

CAT.POL.H.420 Helicopter operations over a hostile environment located outside a congested area	26
GM1-CAT.POL.400(c) General.....	28
THE TAKE-OFF AND LANDING PHASES (PERFORMANCE CLASS 3)	28
GM1-CAT.POL.420 Helicopter operations over a hostile environment located outside a congested area	29
THE INTENT OF THE APPROVAL.....	29
Part-CAT - AMC/GM	31
SUBPART CAIRCRAFT PERFORMANCE AND OPERATING LIMITATIONS	31
Section 1 - Helicopters.....	31
Chapter 1 - General requirements.....	31
AMC1-CAT.POL.H.200&CAT.POL.H.300&CAT.POL.H.400 General	31
CATEGORY A AND CATEGORY B	31
GM1-CAT.POL.H.200&CAT.POL.H.300&CAT.POL.H.400 General.....	32
CATEGORY A AND CATEGORY B	32
AMC1-CAT.POL.H.205(e) Take-off.....	32
OBSTACLE CLEARANCE IN THE BACK-UP AREA	32
AMC1-CAT.POL.H.205&CAT.POL.H.220 Take-off and landing	34
APPLICATION FOR ALTERNATIVE TAKE-OFF AND LANDING PROCEDURES	34
GM1-CAT.POL.H.205&CAT.POL.H.220 Take-off and landing	35
APPLICATION FOR ALTERNATIVE TAKE-OFF AND LANDING PROCEDURES	35
GM1-CAT.POL.H.215(b)(3) En-route - critical engine inoperative	37
FUEL JETTISON	37
GM1-CAT.POL.H.225 Helicopter operations to/from a public interest site.....	37
THE PUBLIC INTEREST SITE PHILOSOPHY	37
GM1-CAT.POL.H.225(a)(2) Helicopter operations at a Public Interest Site	40
IMPROVEMENT PROGRAM FOR PUBLIC INTEREST SITES	40
AMC1-CAT.POL.H.225(b)(2) Helicopter operations at a public interest site	41
HELICOPTER MASS LIMITATION FOR OPERATIONS AT A PUBLIC INTEREST SITE	41
GM to Section 2, Chapter 3 performance class 2	42
OPERATIONS IN PERFORMANCE CLASS 2	42
AMC1-CAT.POL.H.305(b) Helicopter operations without an assured safe forced landing capability	58
POWERPLANT RELIABILITY STATISTICS	58

JAR-OPS 3 Subparts F-I | Revised rule text

AMC2-CAT.POL.H.305(b) Helicopter operations without an assured safe forced landing capability	60
IMPLEMENTATION OF THE SET OF CONDITIONS	60
GM1-CAT.POL.H.305(b) Helicopter operations without an assured safe forced landing capability	62
USE OF FULL AUTHORITY DIGITAL ENGINE CONTROL (FADEC)	62
GM1-CAT.POL.H.310(c)&CAT.POL.H.325(c) Take-off and Landing	62
PROCEDURE FOR CONTINUED OPERATIONS TO HELIDECKS	62
GM1-CAT.POL.H.310&CAT.POL.H.325 Take-off and Landing	66
TAKE-OFF AND LANDING TECHNIQUES	66

JAR-OPS 3 Subparts F-I | Revised rule text

Part-CAT
SUBPART CF
AIRCRAFT PERFORMANCE AND OPERATING LIMITATIONS GENERAL
Section 1 - Helicopters

Chapter 1 - General requirements

JAR-OPS 3.470 CAT.POL.H.100 Applicability

- (a) **The operator shall ensure that helicopters are operated in accordance with the applicable performance class requirements.**
- (b) ~~An operator shall ensure that~~ **Helicopters shall be operated in performance class 1:**^[]
- {(1) ~~when helicopters operated~~ **ing to/from heliports aerodromes/operating sites** located in a congested hostile environment, **except when operated to/from a public interest site (PIS) in accordance with CAT.POL.H.225;**[±] or
- (2) ~~when helicopters which have~~ **having** a maximum approved passenger seating configuration (MAPSC) of more than 19, **except when operated to/from a helideck in performance class 2 under an approval in accordance with CAT.POL.H.305.**

~~are operated in accordance with JAR OPS Part 3, Subpart G (Performance Class 1); except helicopters:~~

~~with a maximum approved passenger seating configuration (MAPSC) of more than 19 and operated to/from helidecks; which may be operated in accordance with JAR OPS 3.517(a)~~

~~or~~

~~which have an operational approval in accordance with Appendix 1 to JAROPS 3.005(i)~~

- (cb) ~~Unless otherwise prescribed by sub paragraph (ab) above, an operator shall ensure that helicopters which have an MPSC maximum approved passenger seating configuration of 19 or less but more than nine are~~ **shall be** operated in accordance with JAR OPS Part 3, Subpart G or H (Performance Class 1 or 2);
- (de) ~~Unless otherwise prescribed by sub paragraph (ab) above, an operator shall ensure that helicopters which have an MPSC maximum approved passenger seating configuration of 9~~ **nine** or less, **are shall be** operated in accordance with JAR OPS Part 3, Subpart G, H or I (Performance Class 1, 2 or 3).

[Amdt. 5, 01.07.07]

JAR-OPS 3.475 CAT.POL.H.105 General

- (a) ~~An operator shall ensure that~~ **The mass of the helicopter:**
- (1) ~~a~~ **At the start of the take-off; or**
or, in the event of in-flight replanning

JAR-OPS 3 Subparts F-I | Revised rule text

(2) **in the event of in-flight re-planning**, ~~At~~ at the point from which the revised operational flight plan applies,

~~is~~ **shall not be** greater than the mass at which the **applicable** requirements of the ~~appropriate Subpart~~ **this Section** can be complied with for the flight to be undertaken, **taking into account** ~~allowing for~~ expected reductions in mass as the flight proceeds, and for such fuel jettisoning as is provided for in the **relevant** ~~particular~~ requirement.

(b) ~~An operator shall ensure that~~ The approved performance data contained in the ~~Helicopter Aircraft Flight Manual (AFM)~~ **is shall be** used to determine compliance with the requirements of **this Section** ~~appropriate Subpart~~ **Chapter**, supplemented as necessary with other data as **prescribed in the relevant requirement. The operator shall specify such other data in the operations manual** ~~inform~~ acceptable to the Authority as prescribed in the relevant Subpart. When applying the factors prescribed in **this Section** ~~appropriate Subpart~~ **Chapter**, account may be taken of any operational factors already incorporated in the ~~Helicopter Aircraft Flight Manual~~ **AFM** performance data to avoid double application of factors.

(c) When showing compliance with the requirements of **this Section** ~~appropriate Subpart~~, due account shall be taken of [the following parameters:

(1) ~~m~~ **mass** of the helicopter;

(2) **the** helicopter configuration;

(3) **the** environmental conditions, in particular:

(i) pressure-altitude, and temperature;

(ii) wind:

(A) **except as provided in (C) below**, for take-off, take-off flight path and landing requirements, accountability for wind shall be no more than 50 % of any reported steady head wind component of 5 knots or more;-

(B) ~~w~~ Where take-off and landing with a tail-wind component is permitted in the ~~AFM Helicopter Flight Manual~~, and in all cases for the take-off flight path, not less than 150 % of any reported tail-wind component shall be taken into account; -

(C) ~~w~~ Where precise wind measuring equipment enables accurate measurement of wind velocity over the point of take-off and landing, alternate wind components **in excess of 50 %** specific to a site may be **established by the operator, provided that the operator demonstrates to** ~~approved by the Authority~~ **competent authority that the proximity to the final approach and take-off area (FATO) and accuracy enhancements of the wind measuring equipment provide an equivalent level of safety-** (See ACJ OPS 3.475(c)(3)(ii));;

(4) **the** operating techniques; and

(5) **the** operation of any systems which have **an** adverse effect on performance.}

[Amdt. 5, 01.07.07]

JAR-OPS 3.477 CAT.POL.H.110 — Obstacle accountability

(See ACJ to Subpart H)

(a) For the purpose of obstacle clearance requirements, an obstacle, located beyond the FATO, in the take-off flight path, or the missed approach flight path, shall be considered if its lateral distance from the nearest point on the surface below the intended flight path is not further than **the following**:

(1) For VFR operations, ÷

(i) ~~half of the minimum FATO width, (or the equivalent term used in the Flight Manual) AFM,~~ width defined in the Helicopter Flight Manual (or, when no width is defined, $0.75 \times D$), plus $0.25 \times$ D (**where D is the largest dimension of the helicopter when the rotors are turning**), (or 3 m, whichever is greater), plus:

(i) $0.10 \times$ distance DR for VFR day operations; or

(ii) $0.15 \times$ distance DR for VFR night operations.

(2) For IFR operations ÷

(i) $1.5 \times D$ (or 30 m, whichever is greater), plus:

(i) $0.10 \times$ distance DR, for IFR operations with accurate course guidance;

(ii) $0.15 \times$ distance DR, for IFR operations with standard course guidance;
or

(iii) $0.30 \times$ distance DR for IFR operations without course guidance,

(ii) when considering the missed approach flight path, the divergence of the obstacle accountability area only applies after the end of the take-off distance available;

~~(iii) standard course guidance includes ADF and VOR guidance. Accurate course guidance include ILS, MLS or other course guidance providing an equivalent navigational accuracy.~~

Comment [T12AS1]: This is now GM1-CAT.POL.H.110 (a)(2)(i)

(3) For operations with initial take-off conducted visually and converted to IFR/**instrument meteorological conditions** -IMC at a transition point, the criteria required in (1) apply up to the transition point, **and then** the criteria required in (2) apply after the transition point. **The** ÷

(i) ~~the~~ transition point cannot be located before the end of **the take-off distance required for helicopters (TODRH)** for helicopters operating in performance **c**Class 1 **or** ~~and~~ before the **defined point after take-off (DPATO)** for helicopters operating in performance **c**Class 2.

(b) For take-off using a back-up (or a lateral transition) procedure, for the purpose of obstacle clearance requirements, an obstacle, located in the back-up (or lateral transition) area, shall be considered if its lateral distance from the nearest point on the surface below the intended flight path is not further than ÷

~~(1) half of the minimum FATO width, (or the equivalent term used in the AFM; Flight Manual) width defined in the Helicopter Flight Manual (or, when no width is defined $0.75 \times D$), plus $0.25 \times$ D (or 3 m, whichever is greater), plus $0.10 \times$ -for VFR day, or $0.15 \times$ for VFR night, of the distance travelled from the back of the FATO.~~

(see ACJ OPS 3.490(d))

JAR-OPS 3 Subparts F-I | Revised rule text

- (c) Obstacles may be disregarded if they are situated beyond:
- (1) ~~7 x r~~**Rotor radius (R)** for day operations, if it is assured that navigational accuracy can be achieved by reference to suitable visual cues during the climb;
 - (2) ~~10 X~~ R for night operations, if it is assured that navigational accuracy can be achieved by reference to suitable visual cues during the climb;
 - (3) 300 m if navigational accuracy can be achieved by appropriate navigation aids; ~~or~~**and**
 - (4) 900 m, ~~in the~~**all** other cases.]

[Amdt. 5, 01.07.07]

~~JAR OPS 3.480~~ Terminology

~~(a) Terms used in Subparts F, G, H, [and]I [] and not defined in JAR 1 have the following meaning:~~

~~(1) 'Category A' with respect to helicopters means multi engine helicopters designed with engine and system isolation features specified in [CS] 27/29 or equivalent acceptable to the [Authority] and Helicopter Flight Manual performance information based on a critical engine failure concept which assures adequate designated surface area and adequate performance capability for continued safe flight in the event of an engine failure.~~

~~(2) 'Category B' with respect to helicopters means single engine or multi engine helicopters which do not fully meet all Category A standards. Category B helicopters have no guaranteed stay up ability in the event of engine failure and unscheduled landing is assumed.~~

~~(3) Committal Point (CP). The committal point is defined as the point in the approach at which the pilot flying (PF) decides that, in the event of a power unit failure being recognised, the safest option is to continue to the deck.~~

~~(4) Congested area. In relation to a city, town or settlement, any area which is substantially used for residential, commercial or recreational purposes (See also definitions of hostile and non hostile environment).~~

~~[(5) D. The largest dimension of the helicopter when the rotors are turning.]~~

~~[(6)] Defined point after take off (DPATO). The point, within the take off and initial climb phase, before which the helicopter's ability to continue the flight safely, with the critical power unit inoperative, is not assured and a forced landing may be required.~~

~~[(7)] Defined point before landing (DPBL). The point within the approach and landing phase, after which the helicopter's ability to continue the flight safely, with the critical power unit inoperative, is not assured and a forced landing may be required.~~

~~Note: Defined points apply to helicopters operated in Performance Class 2 only.~~

~~[(8)] Distance DR. DR is the horizontal distance that the helicopter has travelled from the end of the take off distance available.~~

Comment [BVW2]: All definitions are transferred to Annex I - Definitions and its AMC, where used in the rules.

JAR-OPS 3 Subparts F-I | Revised rule text

~~[[9]] Elevated heliport. A heliport which is at least 3 m above the surrounding surface.~~

~~[[10]] Exposure time. The actual period during which the performance of the helicopter with the critical power unit inoperative in still air does not guarantee a safe forced landing or the safe continuation of the flight. (See also definition of maximum permitted exposure time).~~

~~[[11]] Helideck. A heliport located on a floating or fixed off shore structure.~~

~~[[12]] Heliport. An aerodrome or a defined area of land, water or a structure used or intended to be used wholly or in part for the arrival, departure and surface movement of helicopters.~~

~~[[13]] Hostile environment:~~

~~(i) An environment in which:~~

~~(A) A safe forced landing cannot be accomplished because the surface is inadequate; or~~

~~(B) The helicopter occupants cannot be adequately protected from the elements; or~~

~~(C) Search and rescue response/capability is not provided consistent with anticipated exposure; or~~

~~(D) There is an unacceptable risk of endangering persons or property on the ground;~~

~~(ii) In any case, the following areas shall be considered hostile:~~

~~(A) For overwater operations, the open sea areas North of 45N and South of 45S designated by the Authority of the State concerned; and~~

~~(B) Those parts of a congested area without adequate safe forced landing areas.~~

~~(See IEM OPS 3.480(a)(13))~~

~~[[14]] Landing decision point (LDP). The point used in determining landing performance from which, a power unit failure having been recognised at this point, the landing may be safely continued or a baulked landing initiated.~~

~~[[15]] Landing distance available [[LDAH]]. The length of the final approach and take off area plus any additional area declared available and suitable for helicopters to complete the landing manoeuvre from a defined height.~~

~~[[16]] Landing distance required [[LDRH]]. The horizontal distance required to land and come to a full stop from a point [15] m ([50] ft) above the landing surface.~~

~~[[17]] Maximum approved passenger seating configuration [[MAPSC]]. The maximum passenger seating capacity of an individual helicopter, excluding crew seats, used by the operator, approved by the Authority and included in the Operations Manual.~~

JAR-OPS 3 Subparts F-I | Revised rule text

~~[[18]]~~ Maximum permitted exposure time. A period, determined on the basis of the power unit failure rate recorded for the helicopter's engine type, during which the probability of a power unit failure can be discounted. (See also definition of exposure time).

~~[[19]]~~ Non hostile environment.

(i) An environment in which:

(A) A safe forced landing can be accomplished; and

(B) The helicopter occupants can be protected from the elements; and

(C) Search and rescue response/capability is provided consistent with the anticipated exposure;

(ii) In any case, those parts of a congested area with adequate safe forced landing areas shall be considered non hostile.

~~[[20]]~~ Obstacle. Obstacles include the surface of the earth, whether land or sea.

~~[[21]]~~ Performance Class 1. Performance Class 1 operations are those with performance such that, in the event of failure of the critical power unit, the helicopter is able to land within the rejected take off distance available or safely continue the flight to an appropriate landing area, depending on when the failure occur.

~~[[22]]~~ Performance Class 2. Performance Class 2 operations are those operations such that, in the event of critical power unit failure, performance is available to enable the helicopter to safely continue the flight, except when the failure occurs early during the take off manoeuvre or late in the landing manoeuvre, in which cases a forced landing may be required.

~~[[23]]~~ Performance Class 3. Performance Class 3 operations are those operations such that, in the event of a power unit failure at any time during the flight, a forced landing may be required in a multi engine helicopter but will be required in a single engine helicopter.

~~[[24]]~~ Rejected take off distance available (RTODAH). The length of the final approach and take off area declared available and suitable for helicopters operated in Performance Class 1 to complete a rejected take off.]

~~[[25]]~~ Rejected take off distance required ~~[[RTODRH]]~~. The horizontal distance required from the start of the take off to the point where the helicopter comes to a full stop following a power unit failure and rejection of the take off at the take off decision point.

~~[[26]]~~ Reported headwind component. Reported headwind component is interpreted as being that reported at the time of flight planning and may be used provided there is no significant change of unfactored wind prior to take off.

~~[[27]]~~ Rotation Point (RP). The rotation point is defined as the point at which a cyclic input is made to initiate a nose down attitude change during the take off flight path. It is the last point in the take off path from which, in the event of an engine failure being recognised, a forced landing on the deck can be achieved.

~~[[28]]~~ R. Rotor radius.

JAR-OPS 3 Subparts F-I | Revised rule text

~~[[29]] Safe forced landing. Unavoidable landing or ditching with a reasonable expectancy of no injuries to persons in the aircraft or on the surface.~~

~~[[30]] Take off decision point (TDP). The point used in determining take off performance from which, a power unit failure having been recognised at this point, either a rejected take off may be made or a take off safely continued.~~

~~[[31]] Take off distance available. ([TODAH]) The length of the final approach and take off area plus the length of helicopter clearway (if provided) declared available and suitable for helicopters to complete the take off.~~

~~[[32]] Take off distance required [(TODRH)]. The horizontal distance required from the start of the take off to the point at which VTOSS, a [selected] height [] and a positive climb gradient are achieved, following failure of the critical power unit [being recognised] at TDP, the remaining power units within approved operating limits. [The selected height is to be determined with the use of Helicopter Flight Manual data, and is to be at least 10.7 m (35 ft) above:~~

~~(i) the take off surface; or~~

~~(ii) as an alternative, a level defined by the highest obstacle in the take off distance required.]~~

~~[[33]] Take off flight path. The vertical and horizontal path, with the critical power unit inoperative, from a specified point in the take off to 1000 ft above the surface.]~~

~~[[34]] Take off mass. The take off mass of the helicopter shall be taken to be its mass, including everything and everyone carried at the commencement of the take off.~~

~~[[35]] Touchdown and lift off area (TLOF). A load bearing area on which a helicopter may touch down or lift off.~~

~~[[36]] Vy. Best rate of climb speed.~~

[]

GM1-CAT.POL.H.110-(a)(2)(i) Obstacle accountability

COURSE GUIDANCE

Standard course guidance includes automatic direction finder (ADF) and VHF omnidirectional radio range (VOR) guidance.

Accurate course guidance includes ILS, MLS or other course guidance providing an equivalent navigational accuracy.

[AC] OPS 3.475(e)(3)(ii)

Head wind component for take off and the take off flight path

See JAR OPS 3.475(e)(3)(ii)

When considering approving the use of reported wind components in excess of 50% for take off and the take off flight path the following should be considered:

JAR-OPS 3 Subparts F-I | Revised rule text

- 1— The proximity to the FATO, and accuracy enhancements, of the wind measuring equipment; and
- 2— The existence of appropriate procedures in a supplement to the Flight Manual; and
- 3— The establishment of a safety case.]

Equivalent [Amdt. 5, 01.07.07]

[ACJ] OPS 3.480(a)(1) and (a)(2)

Category A and Category B

See JAR OPS 3.480(a)(1) and (a)(2)

[See JAR OPS 3.485

See JAR OPS 3.515(a)

See JAR OPS 3.540(a)(1)]

1— Helicopters which have been certificated according to any of the following standards are considered to satisfy the Category A criteria of **CAT.POL.H.115(a)(1)** JAR OPS 3.480(a)(1). Provided that they have the necessary performance information scheduled in the Flight Manual, such helicopters are therefore eligible for Performance Class 1 or 2 operations:

- a.— Certification as Category A under JAR 27 or JAR 29;
- b.— Certification as Category A under FAR Part 29;
- c.— Certification as Group A under BCAR Section G;
- d.— Certification as Group A under BCAR 29;

2— In addition to the above, certain helicopters have been certificated under FAR Part 27 and with compliance with FAR Part 29 engine isolation requirements as specified in FAA Advisory Circular AC 27 1. These helicopters may be accepted as eligible for Performance Class 1 or 2 operations provided that compliance is established with the following additional requirements of JAR 29:

JAR 29.1027(a) — Independence of engine and rotor drive system lubrication.

JAR 29.1187(e) —

JAR 29.1195(a) & (b) — Provision of a one shot fire extinguishing system for each engine.

JAR 29.1197—

JAR 29.1199—

JAR 29.1201

JAR 29.1323(c)(1) — Ability of the airspeed indicator to consistently identify the take off ——— decision point.

Note: The requirement to fit a fire extinguishing system may be waived if the helicopters manufacturer can demonstrate equivalent safety, based on service experience for the entire fleet showing that the actual incidence of fires in the engine fire zones has been negligible.

JAR-OPS 3 Subparts F-I | Revised rule text

~~ACJ OPS 3.480(a)(1) and (a)(2) (continued)~~

~~3 The JAR OPS Part 3 performance operating rules of Subparts G, H and I were drafted in conjunction with the performance requirements of JAR 29 Issue 1 and FAR Part 29 at Amendment 29-39. For helicopters certificated under FAR Part 29 at an earlier amendment, or under BCAR Section G or BCAR 29, performance data will have been scheduled in the Helicopter Flight Manual according to these earlier requirements. This earlier scheduled data may not be fully compatible with the JAR OPS Part 3 rules. Before Performance Class 1 or 2 operations are approved, it should be established that scheduled performance data is available which is compatible with the requirements of Subparts G or H respectively.~~

~~4 Any properly certificated and appropriately equipped helicopter is considered to satisfy the Category B criteria of JAR OPS 3.480(a)(2). Such helicopters are therefore eligible for Performance Class 3 operations.~~

~~{Amdt. 5, 01.07.07}~~

~~IEM OPS 3.480(a)(1[3])~~

~~Terminology Hostile environment~~

~~See JAR OPS 3.480(a)(1[3])~~

~~Those open sea areas considered to constitute a hostile environment should be designated by an Authority in the appropriate Aeronautical Information Publication or other suitable documentation.~~

~~{Amdt. 5, 01.07.07}~~

AMC1-CAT.POL.H.205(b)(4) Take-off

THE APPLICATION OF TODRH

The selected height should be determined with the use of AFM data, and be at least 10.7 m (35 ft) above:

- 1. the take-off surface; or**
- 2. as an alternative, a level height defined by the highest obstacle in the take-off distance required.**

~~ACJ OPS 3.480(a)(32)~~ **GM1-CAT.POL.H.205-(b)(4) Take-off**

~~THE APPLICATION OF TODRH~~ **THE APPLICATION OF TODRH**

~~See JAR OPS 3.480(a)(32)~~

1. INTRODUCTION ~~DISCUSSION~~

Original definitions for helicopter performance were derived from aeroplanes; hence the definition of take-off distance owes much to operations from runways. Helicopters on the other hand can operate from runways, confined and restricted areas and rooftop heliports - **FATOs** - all bounded by obstacles. As an analogy this is equivalent to a take-off from a runway with obstacles on and surrounding it.

It can therefore be seen that unless the original definitions from aeroplanes are tailored for helicopters, the flexibility of the helicopter might be constrained by the language of operational performance.

Comment [FC03]: Transferred from AMC OPS.GEN.010(a)(63). Please see CRST to Annex I for comments and responses to this AMC.

JAR-OPS 3 Subparts F-I | Revised rule text

This ~~paper~~ **GM** concentrates on the critical term - ~~t~~Take-off ~~d~~Distance ~~r~~Required (TODRH) - and describes the ~~methods~~ to achieve compliance with it and, in particular, the alternative procedure described in ICAO Annex 6 Attachment A 4.1.1.2(b):

- a. ~~t~~The take-off distance required does not exceed the take-off distance available; or
- b. ~~a~~As an alternative, the take-off distance required may be disregarded provided that the helicopter with the critical ~~engine~~~~power-unit~~ failure at the TDP can, when continuing the take-off, clear all obstacles between the end of the take-off distance available and the point at which it becomes established in a climb at V_{TOSS} by a vertical margin of 10.7 m (35 ft) or more. An obstacle is considered to be in the path of the helicopter if its distance from the nearest point on the surface below the intended line of flight does not exceed 30 m or 1.5 times the maximum dimension of the helicopter, whichever is greater.

2. DEFINITION OF TODRH

The definition of TODRH from ~~JAR Annex I-OPS 3.480 (a)(31)~~ is as follows:

~~(31)~~Take-off distance required (TODRH)' **means** ~~—~~the horizontal distance required from the start of the take-off to the point at which ~~the~~ **take-off safety speed** (V_{TOSS}), a selected height, and a positive climb gradient are achieved, following failure of the critical ~~power-unit~~~~engine~~ being recognised at ~~the~~ TDP, the remaining ~~engine~~~~power-unit(s)~~ operating within approved operating limits.

~~The~~ **In addition AMC1-CAT.POL.H.205(b)(4) states:**

~~The~~ selected height ~~is to~~ **should** be determined with the use of ~~AFM~~~~Helicopter~~~~Flight Manual~~ data, and ~~is to~~ be at least 10.7 m (35 ft) above:

- (i) the take-off surface; or
- (ii) as an alternative, a level defined by the highest obstacle in the take-off distance required.

The original definition of TODRH was based only on the first part of this definition.

3. THE CLEAR AREA PROCEDURE (RUNWAY)

In the past, helicopters certificated in Category A would have had, at the least, a 'clear area' procedure. This procedure is analogous to an aeroplane Category A procedure and assumes a runway (either ~~metalled~~~~metaled~~ or grass) with a smooth surface suitable for an aeroplane take-off (see Figure 1).

The helicopter is assumed to accelerate down the FATO (runway) outside of the **height velocity (HV)** diagram. If the helicopter has an engine failure before TDP, it must be able to land back on the FATO (runway) without damage to helicopter or passengers; if there is a failure at or after TDP the aircraft is permitted to lose height - providing it does not descend below a specified height above the surface (usually 15 ft if the TDP is above 15 ft). Errors by the pilot are taken into consideration but the smooth surface of the FATO limits serious damage if the error margin is eroded (e.g. by a change of wind conditions).

JAR-OPS 3 Subparts F-I | Revised rule text

Figure 1 - Clear Area take-off

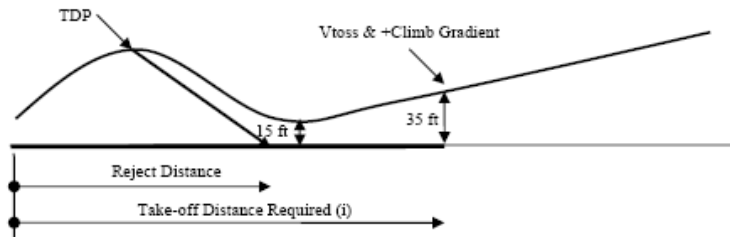

The operator only has to establish that the distances required are within the distance available (take-off distance and reject distance). The original definition of TODRH meets this case exactly.

From the end of the TODRH obstacle clearance is given by the climb gradient of the first or second climb segment meeting the requirement of ~~JAR-OPS 3.495~~**CAT.POL.H.210** (or for PC2 - ~~JAR-OPS 3.525~~**CAT.POL.H.315**). The clearance margin from obstacles in the take-off flight path takes account of the distance travelled from the end of the take-off distance required and operational conditions (IMC or VMC).

4. CATEGORY A PROCEDURES OTHER THAN CLEAR AREA

Procedures other than the clear area are treated somewhat differently. However, the short field procedure is somewhat of a hybrid as either part of the definition of TODRH can be utilised (the term 'helipad' is used in the following section to illustrate the principle only—it is not intended as a replacement for 'helipad').

4.1 Limited area, restricted area and helipad procedures (other than elevated)

The exact names of the procedure used for other than clear area are as many as there are manufacturers. However, principles for obstacle clearance are generic and the name is unimportant.

These procedures (see Figure 2 and Figure 3) are usually associated with an obstacle in the continued take-off area - usually shown as a line of trees or some other natural obstacle. As clearance above such obstacles is not readily associated with an accelerative procedure, as described in 3 above, a procedure using a vertical climb (or a steep climb in the forward, sideways or rearward direction) is utilised.

Figure 2 - Short Field take-off

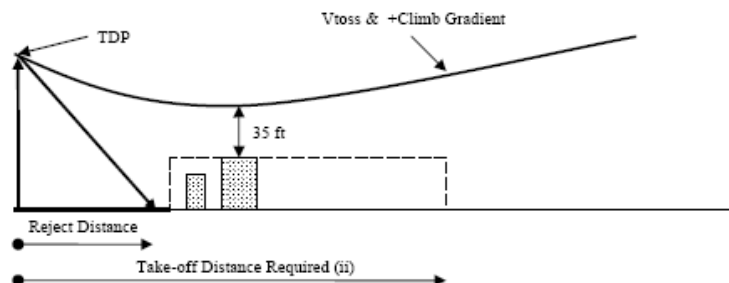

With the added complication of a TDP principally defined by height together with obstacles in the continued take off area, a drop down to within 15 ft of the take-off

JAR-OPS 3 Subparts F-I | Revised rule text

surface is not deemed appropriate and the required obstacle clearance is set to 35 –ft (usually called min-dip). The distance to the obstacle does not need to be calculated (provided it is outside the rejected distance required), as clearance above all obstacles is provided by ensuring that helicopter does not descend below the min-dip associated with a level defined by the highest obstacle in the continued take-off area.

Figure 3 - Helipad take-off

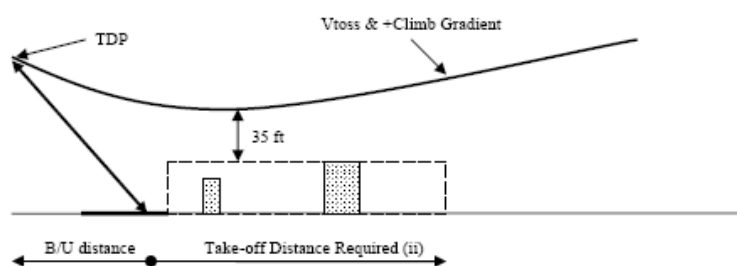

These procedures depend upon the alternative definition of TODRH.

As shown in Figure 3, the point at which $V_{toss} = V_{TOSS}$ and a positive rate of climb are met defines the TODRH. Obstacle clearance from that point is assured by meeting the requirement of **CAT.POL.H.210** ~~JAR-OPS-3.495~~ (or for PC2 - **CAT.POL.H.315** ~~JAR-OPS-3.525~~). Also shown in Figure -3 is the distance behind the helipad which is the back-up distance (B/U distance).

4.2 Elevated helipad procedures

The elevated helipad procedure (see Figure 4) is a special case of the ground level helipad procedure discussed above.

Figure 4 - Elevate Helipad take-off

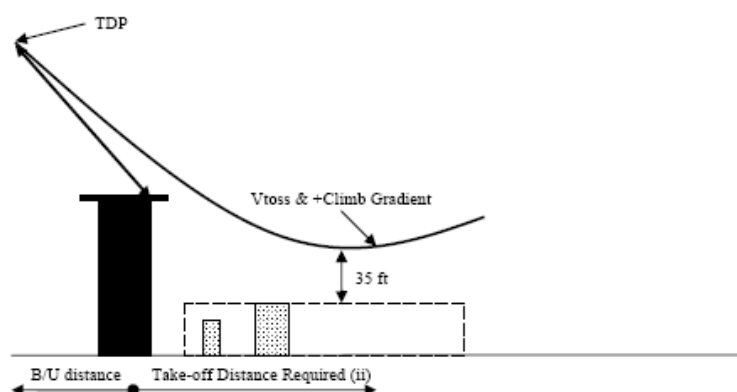

The main difference is that drop down below the level of the take-off surface is permitted. In the drop down phase, the Category A procedure ensures deck-edge clearance but, once clear of the deck-edge, the 35 ft clearance from obstacles relies upon the calculation of drop down. The alternative definition of the TODRH is applied.

Although 35 ft is used throughout the requirements ~~Note, it: 35ft~~ may be inadequate at particular elevated helipads ~~FATOs~~ which are subject to adverse airflow effects, turbulence, etc.}

JAR-OPS 3 Subparts F-I | Revised rule text

[Amdt. 5, 01.07.07]

Chapter 2 - PERFORMANCE CLASS 1**CAT.POL.H.200JAR OPS 3.485 — General**

An operator shall ensure that helicopters operated in performance class 1 are ~~shall~~ **be** certificated in Category A **or equivalent**.

[Amdt. 5, 01.07.07]

Chapter _____ 2
PERFORMANCE CLASS 1

CAT.POL.H.205JAR OPS 3.490 - Take-off —

(a) An operator shall ensure that:

(1) The take-off mass ~~does~~ **shall** not exceed the maximum take-off mass specified in the **AFM** Helicopter Flight Manual, **or approved by the competent authority** for the procedure to be used. ~~(see ACJ OPS 3.490 & 3.510).~~

Comment [T12AS4]: The inserted text replaces the second sentence.

(b) ~~The~~ take-off mass ~~is~~ **shall be** such that:

(1) it is possible to reject the take-off and land on the FATO in case of the critical **engine** power unit failure being recognised at or before the **take-off decision point (TDP)**;

(2) ~~The~~ rejected take-off distance required (**RTODRH**) does not exceed the rejected take-off distance available (**RTODAH**); and

(3) ~~The~~ take-off distance required **TODRH** does not exceed the take-off distance available (**TODAH**).

(4) **Notwithstanding (b)(3)** ~~As an alternative, the requirement in JAR OPS 3.490(a)(2)(iii) above may be disregarded provided that~~ **the TODRH may exceed the TODAH if** the helicopter, with the critical ~~power unit~~ **engine** failure recognised at TDP can, when continuing the take-off, clear all obstacles to the end of the **TODRH** ~~take-off distance required~~ by a vertical margin of not less than 10.7 m (35 ft) ~~(see ACJ OPS 3.480(a)(31));~~.

[]

(c) When showing compliance with sub-paragraph (a) **and (b)** ~~above~~, account shall be taken of the ~~appropriate parameters of~~ **CAT.POL.H.105JAR OPS 3.475(c)** at the **aerodrome/operating site** ~~heliport~~ of departure.

[]

(d) ~~That~~ part of the take-off up to and including TDP shall be conducted in sight of the surface such that a rejected take-off can be carried out.

(e) For take-off using a backup **or** ~~(lateral transition)~~ procedure, ~~the operator shall ensure that,~~ with the critical ~~power unit~~ **engine failure recognition at or before**

JAR-OPS 3 Subparts F-I | Revised rule text

~~the TDP~~^{inoperative}, all obstacles in the back-up ~~or~~ (lateral transition) area ~~are~~ **shall be** cleared by an adequate margin. ~~(see ACJ OPS 3.490(d))~~

~~{Ch. 1, 01.02.99; Amdt. 2, 01.01.02; Amdt. 5, 01.07.07}~~

CAT.POL.H.210~~JAR OPS 3.495~~ -Take-off Flight Path

- (a) ~~{An operator shall ensure that, f~~From the end of the **TODR**~~take-off distance~~ required with the critical ~~power unit~~**engine** failure recognised at the TDP:
- (1) The take-off mass ~~is~~ **shall be** such that the take-off flight path provides a vertical clearance of not less than 10.7 m (35 ft) for VFR operations, and 10.7 m (35 ft) + 0.01 DR for IFR operations, above all obstacles located in the climb path. Only obstacles as specified in **CAT.POL.H.110** ~~JAR OPS 3.477~~ have to be considered.
 - (2) Where a change of direction of more than 15° is made, adequate allowance ~~is~~ **shall be** made for the effect of bank angle on the ability to comply with the obstacle clearance requirements. This turn is not to be initiated before reaching a height of 61 m (200 ft) above the take-off surface unless ~~permitted~~ ~~as part of an approved procedure in the a~~**Aircraft f**light ~~m~~**Manual (AFM)**.
- (b) When showing compliance with ~~sub paragraph~~ (a) above, account shall be taken of the appropriate parameters of **CAT.POL.H.105**~~JAR OPS 3.475(c)~~ at the ~~aerodrome/operating site~~^{heliport} of departure.

CAT.POL.H.215 ~~JAR OPS 3.500~~ -En-route - critical engine ~~power unit~~ **inoperative**

- (a) ~~An operator shall ensure that {T}~~the en-route flight path with the critical ~~power unit~~**engine** inoperative, appropriate to the meteorological conditions expected for the flight, **shall** ~~complies~~ with either sub-paragraph ~~{(1),}~~ (2) or (3) below at all points along the route.
- ~~{(1)}~~ When it is intended that the flight will be conducted at any time out of sight of the surface, the mass of the helicopter permits a rate of climb of at least 50 -ft/minute with the critical ~~power unit~~**engine** inoperative at an altitude of at least 300 m (1 000 ft) **or** 600 m (2 000 ft) in areas of mountainous terrain, above all ~~{terrain and obstacles along the route within 9.3 km (5 NM-nm)}~~ on either side of the intended track.
- ~~{(2)}~~ When it is intended that the flight will be conducted without the surface in sight, the flight path permits the helicopter to continue flight from the cruising altitude to a height of 300 m (1 000 ft) above a landing site where a landing can be made in accordance with **CAT.POL.H.210**~~JAR OPS 3.510~~. The flight path clears vertically, by at least 300 m (1 000 ft) **or**, 600 m (2 000 ft) in areas of mountainous terrain, all terrain and obstacles along the route within 9.3 km (5 **NM-nm**) on either side of the intended track. Drift-down techniques may be used.
- (3) ~~{~~When it is intended that the flight will be conducted in **visual meteorological conditions (VMC)** with the surface in sight, the flight path permits the helicopter to continue flight from the cruising altitude to a height of 300 m (1 000 ft) above a landing site where a landing can be made in accordance with **CAT.POL.H.210**~~JAR OPS 3.510~~, without flying at any time

JAR-OPS 3 Subparts F-I | Revised rule text

below the appropriate minimum flight altitude, obstacles within 900 m on either side of the route need to be considered.

(b) When showing compliance with paragraph (a)(2) or (a)(3) ~~above, an operator shall ensure that:~~

(1) ~~The critical power unit engine is assumed to fail at the most critical point along the route;~~

~~(2) Account is taken of the effects of winds on the flight path;~~

~~(3) Fuel jettisoning is planned to take place only to an extent consistent with reaching the aerodrome/operating site heliport with the required fuel reserves and using a safe procedure; and. (See ACJ OPS 3.500(b)(3)).~~

~~(4) Fuel jettisoning is not planned below 1 000 ft above terrain.~~

~~{ }~~

~~(c) The width margins of subparagraphs (a)(1) and (a)(2) above shall be increased to 18.5 km (10 NM) if the navigational accuracy cannot be met for 95 % of the total flying time (see JAR OPS 3.240, 3.243 and 3.250).~~

~~{Ch. 1, 01.02.99; Amdt. 2, 01.01.02; Amdt. 5, 01.07.07}~~

JAR OPS 3.505 — Intentionally blank

CAT.POL.H.220 ~~JAR OPS 3.510~~ Landing

~~(a) An operator shall ensure that:~~

~~(1) The landing mass of the helicopter at the estimated time of landing does shall not exceed the maximum mass specified in the Helicopter Flight Manual AFM, or as approved by the competent authority, for the procedure to be used (see ACJ OPS 3.490 & 3.510).~~

~~(b2) In the event of the critical power unit engine failure being recognised at any point at or before the landing decision point (LDP), it is possible either to land and stop within the FATO, or to perform a balked landing and clear all obstacles in the flight path by a vertical margin of 10.7 m (35 ft) (see ACJ OPS 3.480(a)(32)). Only obstacles as specified in CAT.POL.H.110 JAR OPS 3.477 have to be considered;~~

~~(c3) In the event of the critical power unit engine failure being recognised at any point at or after the LDP, it is possible to:~~

~~(1) clear all obstacles in the approach path; and~~

~~(24) in the event of the critical power unit failure being recognised at any point at or after the LDP, it is possible to land and stop within the FATO.~~

~~(db) When showing compliance with subparagraph (a) above, (b) and (c) above, account shall be taken of the appropriate parameters of CAT.POL.H.105 JAR OPS 3.475(c) for the estimated time of landing at the destination aerodrome/operating site heliport, or any alternate if required.~~

~~(ee) That part of the landing from the LDP to touchdown, shall be conducted in sight of the surface.~~

~~{Ch. 1, 01.02.99; Amdt. 5, 01.07.07}~~

JAR-OPS 3 Subparts F-I | Revised rule text

CAT.POL.H.225 Appendix 1 to JAR-OPS 3.005(i) Helicopter operations at a public interest site

(a) Multi-turbine powered helicopter types, with a maximum passenger seating configuration (MPSC) of six or less, **operating to/from public interest sites (PIS):**

- (1) located in a **congested** hostile environment; and
- (2) which were established as **aerodrome/operating site** heliports before the 1st of July 2002,

shall have the prior approval of the competent authority issuing the AOC and the authority of the State in which it is intended to conduct such operations.

(b) Where the size of the **PIS** public interest site, or its obstacle environment, does not allow the helicopter to be operated in **p**Performance **c**Class 1, **operations may be conducted in pPerformance cClass 2 and are exempt from the requirements of :**

— ~~CAT.POL.H.310(a)(2)~~ ; and

— ~~CAT.POL.H.325(a)(2)~~ , ;

provided that:

- (1) **the operator complies with CAT.POL.H.305(b)(2) and (b)(3); and**
- (2) the helicopter mass does not exceed the maximum mass specified in the ~~Helicopter AFM Flight Manual~~ for a climb gradient of 8 % in still air at the appropriate take-off safety speed (V_{LO} ~~TOSSS~~) with the critical ~~engine power unit~~ inoperative and the remaining ~~engine power units~~ operating at an appropriate power rating.
- (c) ~~Operation—~~Site—specific procedures shall be established in the ~~o~~Operations ~~m~~Manual to minimize the period during which there would be danger to helicopter occupants and persons on the surface in the event of an ~~power unit~~ **engine** failure during take-off and landing at a **PIS** public interest site.
- (d) Part C of the ~~o~~Operations ~~m~~Manual shall contain for each ~~public interest site~~ **PIS**: a diagram, or annotated photograph, showing the main aspects; the dimensions; the non-conformance with **p**Performance **c**Class 1; the main risks; and the contingency plan should an incident occur.

JAR-OPS 3 Subparts F-I | Revised rule text

Chapter 3 - PERFORMANCE CLASS 2

~~[ACJ]OPS 3.500{(b)(3)}~~ ~~En-route critical power unit inoperative (fuel jettison)~~

See JAR-OPS 3.500{(b)(3)}.

The presence of obstacles along the en-route flight path may preclude compliance with JAR-OPS 3.500(a)(1) at the planned mass at the critical point along the route. In this case fuel jettison at the most critical point may be planned, provided that the procedures in AMC OPS 3.255 paragraph 3 are complied with.

[Amdt. 2, 01.01.02; Amdt. 5, 01.06.07]

[]

[Amdt. 2, 01.01.02; Amdt. 5, 01.07.07]

CAT.POL.H.300~~JAR-OPS 3.515~~ **General**

(a) ~~An operator shall ensure that [] h~~Helicopters operated in ~~p~~Performance ~~c~~Class 2 are ~~shall be~~ certificated in Category A ~~or equivalent~~ [see also ACJ to JAR-OPS 3.480(a)(1) and (a)(2)].

[]

[Ch. 1, 01.02.99; Amdt. 5, 01.07.07]

CAT.POL.H.305~~JAR-OPS 3.517~~ **[Operations w**Without an **a**Assured **s**Safe **f**Forced **l**Landing **c**Capability

(a) ~~An operator shall be satisfied that o~~Operations without an assured safe forced landing capability during the take-off and landing phases are ~~shall only be not~~ conducted ~~unless~~ ~~if~~ the operator has been granted the relevant approval by the Authority ~~competent authority~~ in accordance with Appendix 1 to JAR-OPS 3.517(a). (See also JAR-OPS 3.470(a)(1).)

Appendix 1 to JAR-OPS 3.517(a)

Helicopter operations [without an assured safe forced landing capability]

[(See JAR-OPS 3.517(a))]

[(See ACJ 1 to Appendix 1 to JAR-OPS 3.517(a))]

[(See ACJ 2 to Appendix 1 to JAR-OPS 3.517(a))]

(ba) **To obtain and maintain such a**Approval **the operator shall:**

- (1) **Conduct** [Following a risk assessment, an operator may be authorised to conduct operations without an assured safe forced landing capability during the take-off and landing phases, under an approval specifying:]
 - (i) ~~t~~The type of helicopter; and
 - (ii) ~~t~~The type of operations.
- (2) Such an approval will be subject to the following conditions:
 - (i) ~~[Implement the following~~A set of conditions to be implemented by the operator to obtain and maintain the approval for the helicopter type:;

JAR-OPS 3 Subparts F-I | Revised rule text

- (i) **attain and maintain the helicopter/engine modification standard defined by the manufacturer;**
 - (ii) **conduct the preventive maintenance actions recommended by the helicopter or engine manufacturer;**
 - (iii) **include take-off and landing procedures in the operations manual, where they do not already exist in the AFM;**
 - (iv) **specify training for flight crew; and**
 - (v) **provide a system for reporting to the manufacturer loss of power, engine shutdown or engine failure events.**
- (3ii) Implementation of a usage monitoring system.

{ }

{Ch. 1, 01.02.99; Amdt. 2, 01.01.02; Amdt. 5, 01.07.07}

CAT.POL.H.310~~JAR-OPS 3.520~~ **Take-off**

— [(See ACJ to Subpart H)]

— (See IEM OPS 3.520 & 3.535)

- (a) An operator shall ~~[be satisfied]~~ that:
- (1) ~~The take-off mass does~~ **shall** not exceed the maximum mass specified for a rate of climb of 150 ft/min at 300 m (1 000 ft) above the level of the **aerodrome/operating site** ~~heliport~~ with the critical ~~power unit~~ **engine** inoperative and the remaining **engine(s)** ~~power units~~ operating at an appropriate power rating.
- (b2) ~~For operations other than those specified in CAT.POL.H.305~~ ~~JAR-OPS 3.517(a)~~, the take-off ~~is~~ **shall be** conducted such that a safe forced landing can be executed until the point where safe continuation of the flight is possible ~~(see ACJ to Subpart H paragraph 6.2)~~.
- (c3) For operations in accordance with **CAT.POL.H.305** ~~JAR-OPS 3.517(a)~~ in addition to the requirements of (a) ~~(1)~~ above:
- (1) ~~t~~ **The take-off mass does** **shall** not exceed the maximum mass specified in the ~~Helicopter Flight Manual~~ **AFM** for an **all engines operative out of ground effect (AEO OGE)** hover in still air with all ~~engines~~ **power units** operating at an appropriate power rating; ~~or~~:
- (2ii) ~~f~~ **For operations to/from a helideck:**
- (iA) with a helicopter that has a maximum ~~approved~~ passenger seating configuration (MAPSC) of more than 19; ~~and/or~~
 - (iiB) ~~from 1st January 2010~~ any helicopter operated ~~to/from~~ a helideck located in a ~~noncongested~~ hostile environment, ~~as defined in JAR-OPS 3.480(13)(ii)(A)~~
- the take-off mass **shall** take into account: the procedure; deck-edge miss, and drop down appropriate to the height of the helideck - with the critical ~~power unit~~ **engine(s)** inoperative and the remaining ~~power unit~~ **engines** operating at an appropriate power rating.

JAR-OPS 3 Subparts F-I | Revised rule text

- (~~db~~) When showing compliance with ~~sub-paragraph (a) above~~, **(b) and (c) above**, account shall be taken of the appropriate parameters of **CAT.POL.H.105** ~~JAR OPS 3.475(c)~~ at the ~~helicopter~~ **point** of departure.
- (~~ec~~) ~~That~~ part of the take-off before the requirement of **CAT.POL.H.315** ~~JAR OPS 3.525~~ is met shall be conducted in sight of the surface.

{ }

{Ch. 1, 01.02.99; Amdt. 5, 01.07.07}

CAT.POL.H.315 ~~JAR OPS 3.525~~ **Take-off f** ~~Flight p~~ **Path** ~~{(See ACJ to Subpart H)}~~

- (~~a~~) ~~{An operator shall be satisfied that f~~ **From the defined point after take-off (DPATO) or, as an alternative, no later than 200 ft above the take-off surface, with the critical power unit engine inoperative the requirements of CAT.POL.H.210** ~~JAR OPS 3.495(a)(1), (a)(2) and (b) are~~ **shall be complied with** ~~met.~~

{ }

{Ch. 1, 01.02.99; Amdt. 5, 01.07.07}

CAT.POL.H.320 ~~JAR OPS 3.530~~ **En-route - c** ~~ritical engine~~ **power unit inoperative**

- (~~a~~) ~~An operator shall ensure that {~~ **The requirement of CAT.POL.H.215** ~~JAR OPS 3.500 is~~ **shall be complied with** ~~met.~~

{ }

{Ch. 1, 01.02.99; Amdt. 2, 01.01.02; Amdt. 5, 01.07.07}

CAT.POL.H.325 ~~JAR OPS 3.535~~ **Landing**

~~{(See IEM OPS 3.520 & 3.535)}~~

~~{(See ACJ to Subpart H)}~~

- (~~a~~) An operator shall ~~{be satisfied}~~ that:
- (~~1~~) ~~The landing mass at the estimated time of landing does~~ **shall** not exceed the maximum mass specified for a rate of climb of 150 ft/min at 300 m (1 000 ft) above the level of the **aerodrome/operating site** ~~helicopter~~ with the critical ~~power unit~~ **engine** inoperative and the remaining **engine(s)** ~~power units~~ operating at an appropriate power ~~{rating.}~~
- (~~b2~~) ~~{If the critical power unit engine fails at any point in the approach path:~~
- (~~1i~~) a balked landing can be carried out meeting the requirement of **CAT.POL.H.315** ~~JAR OPS 3.525~~; or
- (~~2ii~~) for operations other than **those** specified in **CAT.POL.H.305** ~~JAR OPS 3.517(a)~~ the helicopter can perform a safe-forced-landing.
- (~~c3~~) For operations in accordance with **CAT.POL.H.305** ~~JAR OPS 3.517(a)~~ in addition to the requirements of (~~a~~)(~~1~~) ~~above~~:
- (~~1i~~) ~~t~~ **The landing mass does** **shall** not exceed the maximum mass specified in the ~~Helicopter Flight Manual~~ **AFM** for an **all engines operative out of ground**

JAR-OPS 3 Subparts F-I | Revised rule text

effect (AEO OGE) hover in still air with all ~~power units~~**engines** operating at an appropriate power rating; ~~or~~

~~(2ii) f~~For operations to/from a helideck:

~~(iA)~~ with a helicopter that has an ~~maximum approved passenger seating configuration (MAPSC)~~ of more than 19; ~~and/or~~

~~(iiB)~~ from 1st January 2010 any helicopters operated to/from a helideck located in a ~~non congested hostile environment, as defined in JAR OPS 3.480(13)(ii)(A)~~

the landing mass **shall** take into account the procedure, and drop down appropriate to the height of the helideck - with the critical ~~power unit~~**engine** inoperative and the remaining ~~power unit~~**engine(s)** operating at an appropriate power rating.

~~(db)~~ When showing compliance with ~~sub paragraph (a), (b) and (c)~~ above, account shall be taken of the appropriate parameters of **CAT.POL.H.105** ~~JAR OPS 3.475 (c)~~ at the destination ~~heliport~~**aerodrome** or any alternate, if required.

~~(ee)~~ That part of the landing after which the requirement of ~~(ba)(12)(i)~~ **JAR OPS 3.525** cannot be met shall be conducted in sight of the surface.}

{Ch. 1, 01.02.99; Amdt. 2, 01.01.02; Amdt. 5, 01.07.07}

Appendix 1 to JAR OPS 3.517(a)

Helicopter operations [without an assured safe forced landing capability]

{(See JAR OPS 3.517(a))}

{(See ACJ 1 to Appendix 1 to JAR OPS 3.517(a))}

{(See ACJ 2 to Appendix 1 to JAR OPS 3.517(a))}

~~(a) Approval:~~

~~(1) [Following a risk assessment, an operator may be authorised to conduct operations without an assured safe forced landing capability during the take-off and landing phases, under an approval specifying:]~~

~~(i) The type of helicopter; and~~

~~(ii) The type of operations.~~

~~(2) Such an approval will be subject to the following conditions:~~

~~(i) [A set of conditions to be implemented by the operator to obtain and maintain the approval for the helicopter type;~~

~~(ii) Implementation of a Usage Monitoring System]~~

{ }

{Ch. 1, 01.02.99; Amdt. 5, 01.07.07}

JAR-OPS 3 Subparts F-I | Revised rule text

Chapter 4 - PERFORMANCE CLASS 3

CAT.POL.H.400 ~~JAR OPS 3.540~~ General

(a) ~~An operator shall ensure that:~~

~~(1) Helicopters operated in pPerformance cClass 3 are~~ **shall be** certified in either Category A, ~~or B~~ **or equivalent** ~~[(see also ACJ OPS 3.480(a)(1) and (a)(2))].~~

~~(b2) Operations are~~ **shall** only **be** conducted from/to those heliports and over such routes, areas and diversions contained in a non-hostile environment, **except:**

(1i) when operating in accordance with CAT.POL.H.420; or

(2ii) except ~~for the take-off and landing phase, when operating in accordance with as provided in (cb) below].~~

~~[]~~

~~(cb) Provided the operator has been granted a relevant approval by the competent authority in accordance with CAT.POL.H.305, A~~ **operations may be conducted** ~~n operator may conduct operations to/from an aerodrome/operating site~~ **heliport** located outside a congested hostile environment, without an assured safe forced landing capability ~~during the take-off and landing phases (see ACJ OPS 3.540(b)):~~

(1) during take-off, ~~before reaching V_y (speed for best rate of climb) or 200 ft above the take-off surface; or~~

(2) during landing, ~~below 200 ft above the landing surface.~~

~~provided the operator has been granted a relevant approval by the Authority in accordance with Appendix 1 to JAR OPS 3.517(a).~~

~~(de) An operator shall ensure that~~ **Operations are** ~~shall~~ not **be** conducted:

(1) out of sight of the surface;

(2) at night;

(3) when the ceiling is less than 600 ft; or

(4) when the visibility is less than 800 m.]

~~[Ch. 1, 01.02.99; Amdt. 2, 01.01.02; Amdt. 5, 01.07.07]~~

CAT.POL.H.405 ~~JAR OPS 3.545~~ Take-off

~~An operator shall ensure that:~~

(a) The take-off mass ~~does~~ **shall** not exceed the maximum take-off mass specified for a hover in ground effect with all **engines** ~~power units~~ operating at take-off power. If conditions are such that a hover in ground effect is not likely to be established, the take-off mass shall not exceed the maximum take-off mass specified for a hover out of ground effect with all **engines** ~~power units~~ operating at take-off power.

~~(fb) Except as provided in CAT.POL.H.400(b), in the event of an engine power unit failure, the helicopter is~~ **shall be** able to perform a safe forced landing, ~~except when operated in accordance with the alleviation contained in sub paragraph 3.540(fb)]~~ **[]**.

~~[Ch. 1, 01.02.99; Amdt. 5, 01.07.07]~~

JAR-OPS 3 Subparts F-I | Revised rule text

CAT.POL.H.410 ~~JAR OPS 3.550~~ — En-route

An operator shall ensure that:

- (a) The helicopter ~~is~~ **shall be** able, with all ~~power unit~~**engines** operating within the maximum continuous power conditions ~~specified~~, to continue along its intended route or to a planned diversion without flying at any point below the appropriate minimum flight altitude. ~~and~~
- (b) **Except as provided in CAT.POL.H.420**, in the event of an ~~power unit~~**engine** failure, the helicopter ~~is~~ **shall be** able to perform a safe forced landing ~~[]~~.

~~[Ch. 1, 01.02.99; Amdt. 5, 01.07.07]~~

CAT.POL.H.415 ~~JAR OPS 3.555~~ Landing

An operator shall ensure that:

- (a) The landing mass of the helicopter at the estimated time of landing ~~does~~ **shall** not exceed the maximum landing mass specified for a hover in ground effect, with all ~~power units~~**engines** operating at take-off power. If conditions are such that a hover in ground effect is not likely to be established, the landing mass shall not exceed the maximum landing mass specified for a hover out of ground effect with all ~~power units~~**engines** operating at take-off power.
- ~~(b)~~ **Except as provided in CAT.POL.H.400(b)**, in the event of an ~~power unit~~**engine** failure, the helicopter ~~is~~ **shall be** able to perform a safe forced landing, ~~except when operated in accordance with the alleviation contained in sub-paragraph 3.540(a)(2) or 3.540(b)~~ ~~[]~~.

~~[Ch. 1, 01.02.99; Amdt. 5, 01.07.07]~~

CAT.POL.H.420 Helicopter operations over a hostile environment located outside a congested area

- (a) **Turbine-powered helicopters with a maximum passenger seating configuration of six ~~6~~ or less shall only be over a non-congested hostile environment without a safe forced landing capability, if the operator:**

- (1) is not operating under a helicopter emergency medical service (HEMS) approval;**
- (2) holds an** ~~Turbine-powered helicopters operating over a hostile environment located outside a congested area where it has been substantiated that helicopter limitations, or other justifiable considerations, preclude the use of the appropriate performance criteria~~ **approval from the competent authority -and, if different, the a** ~~Authority of the State in which such operations are conducted; and~~
- (3) has demonstrated that the following :**

~~authority issuing the AOC and the Authority of the State in which it is intended to conduct such operations:~~ **precludes compliance with the appropriate performance criteria:**

- ~~(1i)~~ **in specified mountainous area(s), a multi-engined helicopter cannot meet the requirement of performance class 1 or 2 for the mission at the operational altitude; or**
- (2ii) in remote areas, where a safety assessment establishes that:**

JAR-OPS 3 Subparts F-I | Revised rule text

- (A) alternative surface transportation would not provide the same level of safety as single-engine~~d~~ helicopters; and
- (B) the low density of population and, economic circumstances do not justify the replacements of single-engine~~d~~ by multi-engine~~d~~ helicopters.

~~with a maximum passenger seating configuration (MPSC) of 6 or less.~~ **(b) Such approval will exempt from compliance with:**

- (1) CAT.POL.H.410(b),** provided that the operator complies with **CAT.POL.H.305 (b)(2) and(b)(3); and**

~~with non-pressurised helicopters at pressure altitudes above 10 000 ft without the provision of supplemental oxygen equipment capable of storing and dispensing the oxygen supplies required, provided the cabin altitude does not exceed 10 000 ft for a period in excess of 30 minutes and never exceeds 13 000 ft pressure altitude.~~ **(2) the provision for carriage of supplemental oxygen equipment for non-pressurised helicopter operations above 10 000 ft, provided the cabin altitude does not exceed 10 000 ft for a period in excess of 30 minutes and never exceeds 13 000 ft pressure altitude.**

JAR-OPS 3 Subparts F-I | Revised rule text

~~ACJ-OPS 3.540(b)~~ GM1-CAT.POL.400(cb) General

~~THE TAKE-OFF AND LANDING PHASES~~ THE TAKE-OFF AND LANDING PHASES (~~PERFORMANCE~~ PERFORMANCE CLASS CLASS 3)

See ~~JAR-OPS 3.540(b)~~

1. To understand the use of ground level exposure in ~~p~~Performance ~~c~~Class 3, it is important first to be aware of the logic behind the use of 'take-off and landing phases'; once this is clear, it is easier to appreciate the aspects and limits of the use of ground level exposure. This GM shows the derivation of the term from the ICAO definition of the 'en-route phase' and then gives practical examples of the use, and limitations on the use, of ground level exposure in ~~JAR~~CAT.POL.400(c)-OPS 3.540(b).
2. The take-off phase in ~~p~~Performance ~~c~~Class 1 and ~~p~~Performance ~~c~~Class 2 may be considered to be bounded by 'the specified point in the take-off' from which the ~~t~~Take-off ~~f~~Flight ~~p~~Path begins.
 - 2.1 In ~~p~~Performance ~~c~~Class 1 this specified point is defined as "the end of the ~~t~~Take-off ~~d~~Distance ~~r~~Required".
 - 2.2 In ~~p~~Performance ~~c~~Class 2 this specified point is defined as "DPATO or, as an alternative, no later than 200 ft above the take-off surface".
 - 2.3 There is no simple equivalent point for bounding of the landing in ~~p~~Performance ~~c~~Class 1 & 2.
3. Take-off ~~f~~Flight ~~p~~Path is not used in ~~p~~Performance ~~c~~Class 3 and, consequently, the term 'take-off and landing phases' is used to bound the limit of exposure. For the purpose of ~~p~~Performance ~~c~~Class 3, the take-off and landing phases are considered to be bounded by:
 - a. for the take-off no later than V_y (**speed for best rate of climb**) or 200 ft above the take-off surface; and
 - b. for the landing 200 ft above the landing surface.

(~~Note: in ICAO Annex 6 Part III, defines e~~En-route phase is defined as being "That part of the flight from the end of the take-off and initial climb phase to the commencement of the approach and landing phase." The use of take-off and landing phase in this text is used to distinguish the take-off from the initial climb, and the landing from the approach: they are considered to be complimentary and not contradictory.)

4. Ground level exposure – and exposure for elevated ~~FATOs or heliports~~/helidecks in a non-hostile environment – is permitted for operations under an approval in accordance with ~~Appendix 1 to CAT.POL.H.305~~JAR-OPS 3.517(a). Exposure in this case is limited to the 'take-off and landing phases'.

~~What is the practical effect of this bounding of exposure~~ **can be illustrated with the following?** Consider a couple of examples:

- a. A clearing: ~~an~~ the operator may consider a take-off/landing in a clearing when there is sufficient power, with all engines operating, to clear all obstacles in the take-off path by an adequate margin (this, in ICAO, is meant to indicate 35 ft). Thus, the clearing may be bounded by bushes, fences, wires and, in the extreme, by power lines, high trees etc. Once the obstacle has been cleared – by using a steep or a vertical climb (which itself may infringe the **height**

JAR-OPS 3 Subparts F-I | Revised rule text

velocity (HV) diagram) - the helicopter reaches V_y or 200 ft, and from that point a safe forced landing must be possible. The effect is that whilst operation to a clearing is possible, operation to a clearing in the middle of a forest is not (except when operated in accordance with ~~Appendix 1 to JAR OPS 3.005(e)~~**CAT.POL.H.420**).

- b. ~~An aerodrome/operating site heliport~~ surrounded by rocks:** the same applies when operating to a landing site that is surrounded by rocky ground. Once V_y or 200 ft has been reached, a safe forced landing must be possible.
 - c. ~~An elevated FATO or heliport/helideck~~:** when operating to an elevated **FATO or heliport/helideck** in ~~p~~Performance ~~c~~Class 3, exposure is considered to be twofold: firstly, to a deck-edge strike if the engine fails after the decision to transition has been taken; and secondly, to operations in the HV diagram due to the height of the **FATO heliport/or** helideck. Once the take-off surface has been cleared and the helicopter has reached the knee of the HV diagram, the helicopter should be capable of making a safe forced landing.
5. Operation in accordance with ~~CAT.POL.400 JAR OPS 3.540~~(b) does not permit excursions into a hostile environment per se and is specifically concerned with the absence of space to abort the take-off or landing when the take-off and landing space are limited; or when operating in the HV diagram.
 6. Specifically, the use of this exception to the requirement for a safe forced landing (during take-off or landing) does not permit semi-continuous operations over a hostile environment such as a forest or hostile sea area. ~~It can therefore be seen as a limited alleviation from JAR OPS 3.540(a)(2) which states that: "operations are only conducted to/from these heliports and over such routes, areas and diversions contained in a non-hostile environment..."~~

~~[Amdt. 5, 01.07.07]~~**GM1-CAT.POL.420 Helicopter operations over a hostile environment located outside a congested area**

THE INTENT OF THE APPROVAL

1. Introduction

The transposition of Appendix 1 to JAR-OPS 3.005(e) and the intent expressed in IEM to Appendix 1 to JAR-OPS 3.005(e) revealed some inconsistencies in the original text. These inconsistencies have caused uneven implementation throughout the JAA Member States. In order to better reflect the current state of operations, this GM is provided to explain under which circumstances such approval can be obtained by ~~an~~the operator.

2. Passenger seating configuration

The maximum passenger seating configuration of ~~six~~6 has been set to limit the increased exposure to an engine-failure to a maximum number of passengers; this is also applicable to multi-engined helicopters.

3. Specified mountainous areas

Current generation twin-engined helicopters may not always be able to meet the ~~p~~Performance ~~c~~Class 1 or 2 requirements for the mission at the operational altitude. It is in these circumstances that the operator may obtain the approval from the competent authority to operate with a turbine

JAR-OPS 3 Subparts F-I | Revised rule text

powered helicopter at these operating altitudes without an assured safe forced landing capability.

Such operations should only be conducted in mountainous areas specified by the competent authority of the state responsible for that area, as specified in CAT.POL.420.H (a)(1).

4. Remote area

An example of a remote area is an arctic settlement, where the requirement to operate with an assured safe forced landing capability might not be economically justified or proportionate.

Appendix 1 to JAR OPS 3.005(e)

~~Helicopter operations over a hostile environment located outside a congested area~~

~~See Appendix 1 to JAR OPS 3.005(e)~~

- ~~1— The subject Appendix has been produced to allow a number of existing operations to continue. It is expected that the alleviation will be used only in the following circumstances:

 - ~~1.1— Mountain Operations; where present generation multi-engine aircraft cannot meet the requirement of Performance Class 1 or 2 at altitude.~~
 - ~~1.2— Operations in Remote Areas; where existing operations are being conducted safely; and where alternative surface transportation will not provide the same level of safety as single-engine helicopters; and where, because of the low density of population, economic circumstances do not justify the replacement of single-engine by multi-engine helicopters (as in the case of remote arctic settlements).~~~~
- ~~2— The State issuing the AOC and the State in which operations will be conducted should give prior approval.~~
- ~~3— If both approvals have been given by a single it should not withhold, without justification, approval for aircraft of another State.~~
- ~~4— Such approvals should only be given after both States have considered the technical and economic justification for the operation.~~

JAR-OPS 3 Subparts F-I | Revised rule text

Part-CAT - AMC/GM

SUBPART CAIRCRAFT PERFORMANCE AND OPERATING LIMITATIONS

Section 1 - Helicopters

Chapter 1 - General requirements

AMC1-CAT.POL.H.200&CAT.POL.H.300&CAT.POL.H.400 General

CATEGORY A AND CATEGORY B

1. Helicopters which have been certified according to any of the following standards are considered to satisfy the Category A criteria. Provided that they have the necessary performance information scheduled in the AFM, such helicopters are therefore eligible for performance class 1 or 2 operations:
 - a. certification as Category A under CS-27 or CS-29;
 - b. certification as Category A under JAR-27 or JAR-29;
 - c. certification as Category A under FAR Part 29;
 - d. certification as group A under BCAR Section G; and
 - e. certification as group A under BCAR-29.
2. In addition to the above, certain helicopters have been certified under FAR Part 27 and with compliance with FAR Part 29 engine isolation requirements as specified in FAA Advisory Circular AC 27-1. These helicopters may be accepted as eligible for performance class 1 or 2 operations provided that compliance is established with the following additional requirements of CS-29:
 - a. CS 29.1027(a) Independence of engine and rotor drive system lubrication;
 - b. CS 29.1187(e);
 - c. CS 29.1195(a) & (b) Provision of a one-shot fire extinguishing system for each engine*;
 - d. CS 29.1197;
 - e. CS 29.1199;
 - f. CS 29.1201; and
 - g. CS 29.1323(c)(1) Ability of the airspeed indicator to consistently identify the take-off decision point.

* The requirement to fit a fire extinguishing system may be waived if the helicopter manufacturer can demonstrate equivalent safety, based on service experience for the entire fleet showing that the actual incidence of fires in the engine fire zones has been negligible.

JAR-OPS 3 Subparts F-I | Revised rule text

3. Any properly certified helicopter is considered to satisfy the Category B criteria.

If appropriately equipped (in accordance with CAT.IDE.H), such helicopters are therefore eligible for performance class 3 operations.

GM1-CAT.POL.H.200&CAT.POL.H.300&CAT.POL.H.400 General

CATEGORY A AND CATEGORY B

The performance operating rules of JAR-OPS 3, which were transposed into the Implementing Rules, were drafted in conjunction with the performance requirements of JAR-29 Issue 1 and FAR Part 29 at amendment 29-39. For helicopters certificated under FAR Part 29 at an earlier amendment, or under BCAR section G or BCAR-29, performance data will have been scheduled in the AFM according to these earlier requirements. This earlier scheduled data may not be fully compatible with these rules. Before performance class 1 or 2 operations are approved, it should be established that scheduled performance data is available which is compatible with the requirements of performance class 1 and 2 respectively.

~~AGJ~~**AMC1-CAT.POL.H.205OPS 3.490(ed) Take-off**

~~OBSTACLE CLEARANCE IN THE BACK-UP AREA~~**OBSTACLE CLEARANCE IN THE BACK-UP AREA**

See JAR-OPS 3.490(d)

1. The requirement in **CAT.POL.H.205**~~JAR-OPS 3.490(ed)~~ has been established in order to take into account the following factors:
 - a. ~~in the back-up;~~ the pilot has few visual cues and has to rely upon the altimeter and sight picture through the front window (if flight path guidance is not provided) to achieve an accurate rearward flight path;
 - b. ~~in the rejected take-off;~~ the pilot has to be able to manage the descent against a varying forward speed whilst still ensuring an adequate clearance from obstacles until the helicopter gets in close proximity for landing on the FATO; ~~and-~~
 - c. ~~in the continued take-off;~~ the pilot has to be able to accelerate to ~~V_{tos}~~**V_{Toss}** (**take-off safety speed for Category A helicopters**) whilst ensuring an adequate clearance from obstacles.
2. The requirements of **CAT.POL.H.205** ~~JAR-OPS 3.490(ed)~~ may be achieved by establishing that, ~~in the backup area:~~
 - a. **in the backup area** no obstacles are located within the safety zone below the rearward flight path when described in the ~~helicopter aircraft~~ flight manual (see ~~Figure -1~~); (in the absence of such data in the ~~helicopter flight manual~~ **AFM**, the operator should contact the manufacturer in order to define a safety zone); or
 - b. during the backup, the rejected take-off and the continued take-off manoeuvres, obstacle clearance ~~is has been demonstrated by a means acceptable to the competent authority.~~

Figure 1:— Rearward flight path

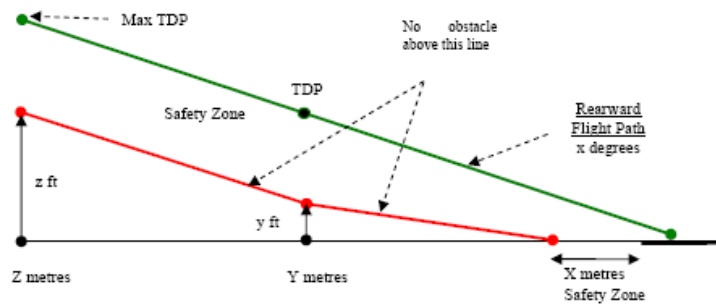

3. An obstacle, in the backup area, is considered if its lateral distance from the nearest point on the surface below the intended flight path is not further than half of the minimum FATO (or the equivalent term used in the ~~AFM Flight Manual~~ **AFM Helicopter Flight Manual**) width defined in the ~~AFM Helicopter Flight Manual~~ (or, when no width is defined 0.75 D, **where D is the largest dimension of the helicopter when the rotors are turning**), plus 0.25 times D (or 3 m, whichever is greater); plus 0.10 for VFR day, or 0.15 for VFR night, of the distance travelled from the back of the FATO- (see **F**igure 2).

Figure 2:— Obstacle accountability

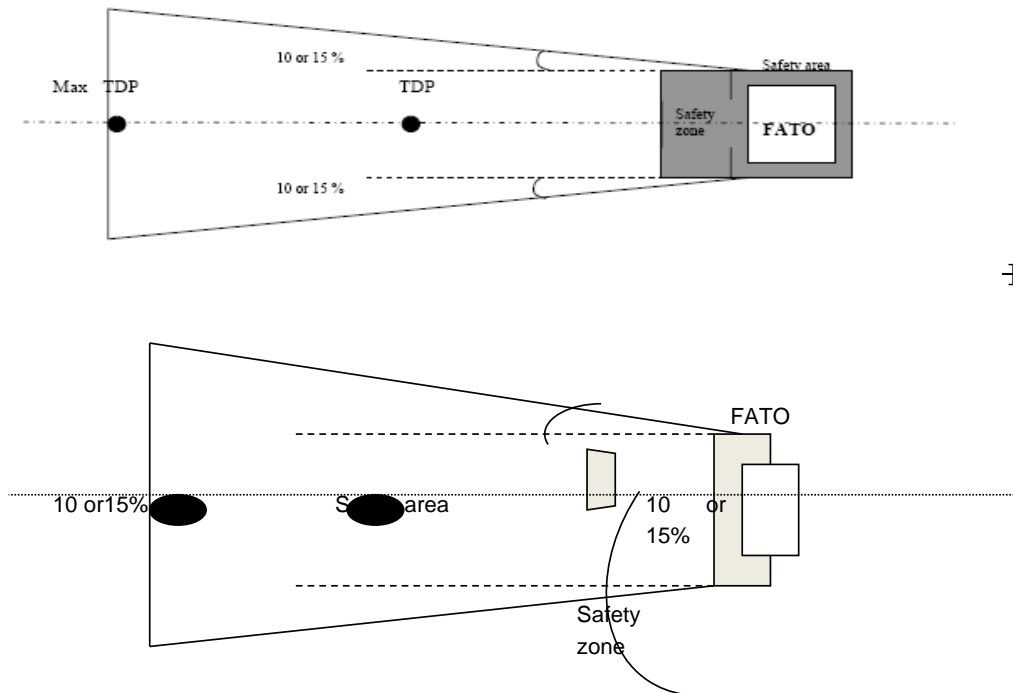

AMC1-CAT.POL.H.205&CAT.POL.H.220 Take-off and landing

APPLICATION FOR ALTERNATIVE TAKE-OFF AND LANDING PROCEDURES

Methods of Application:

An operator may apply to the Authority for a reduction in the size of the take-off surface under the following conditions:

1. **A reduction in the size of the take-off surface may be applied when the operator has demonstrated to the competent authority that compliance with the requirements of CAT.POL.H.205 JAR-OPS 3.490, 3.495 210 and 3.510 220 can be assured with:**
 - a.1 a procedure based upon an appropriate Category A take-off and landing profile scheduled in the AFM;
 - b.2 a take-off or landing mass not exceeding the mass scheduled in the AFM for a **hover out of ground effect one-engine-inoperative (HOGE OEI)** in compliance with HEC Class D performance requirements ensuring that:
 - i.2.1 following an **engine** —power unit— failure at or before TDP, there are adequate external references to ensure that the helicopter can be landed in a controlled manner; and

JAR-OPS 3 Subparts F-I | Revised rule text

- ii.2.2 following an **engine** ~~power unit~~ failure at or after the LDP there are adequate external references to ensure that the helicopter can be landed in a controlled manner.
2. An operator ~~may apply to the Authority for an upwards shift of the TDP and LDP~~ **may be applied when the operator has demonstrated to the Authority competent authority that** under the following conditions:
- Compliance with the requirements of **CAT.POL.H.205, 210 and 220** ~~JAR OPS 3.490, 3.495 and 3.510~~ can be assured with:
- a.3 a procedure based upon an appropriate Category A take-off and landing profile scheduled in the **AHFM**;
- b.4 a take-off or landing mass not exceeding the mass scheduled in the **AHFM** for a **hover-out-of-ground-effect (HOGE) OEI** ~~in compliance with HEC Class D performance requirements~~ ensuring that:
- i.4.1 following an **engine** ~~power unit~~ failure at or after TDP compliance with the obstacle clearance requirements of ~~JAR OPS~~ **CAT.POL.H.205** ~~3.490(ba)(42)(iv)~~ and **CAT.POL.H.210** ~~JAR OPS 3.495~~ can be met; and
- ii.4.2 following an **engine** ~~power unit~~ failure at or before the LDP the balked landing obstacle clearance requirements of ~~JAR OPS~~ **CAT.POL.H.220** ~~3.510(ba)(2)~~ and **CAT.POL.H.210** ~~JAR OPS 3.495~~ can be met.
3. ~~Alternatively, an operator may apply to the Authority for the use of T~~ the Category A ground level surface **area** requirement **may be applied at** ~~for a specific elevated heliport~~ **FATO** when **the operator** ~~it can be demonstrate~~ **to the competent authority** that the usable cue environment at that **aerodrome/operating site** ~~heliport~~ would permit such a reduction **in size**.}

[Amdt. 5, 01.07.07]

[ACJGM1-CAT.POL.H.205&CAT.POL.H. and OPS 3.490 & 3.510-220 Take-off and landing**APPLICATION FOR ALTERNATIVE TAKE-OFF AND LANDING PROCEDURES****Introduction** ~~Discussion~~

A manufacturer's Category A procedure defines profiles and scheduled data for take-off, climb, performance at minimum operating speed and landing, under specific environmental conditions and masses.

Associated with these profiles and conditions are minimum operating surfaces, take-off distances, climb performance and landing distances; these are provided (usually in graphic form) with the take-off and landing masses and the ~~t~~Take-off ~~d~~Decision ~~p~~Point (TDP) and ~~l~~anding ~~d~~Decision ~~p~~Point (LDP).

The landing surface and the height of the TDP are directly related to the ability of the helicopter - following an **engine** ~~power unit~~ failure before or at TDP - to reject onto the surface under forced landing conditions. The main considerations in establishing the minimum size of the landing surface are the scatter during flight testing of the reject

JAR-OPS 3 Subparts F-I | Revised rule text

manoeuvre, with the remaining engine operating within approved limits, and the required usable cue environment.

Hence, an elevated site with few visual cues - apart from the surface itself - would require a greater surface area in order that the helicopter can be accurately positioned during the reject manoeuvre within the specified area. This usually results in the stipulation of a larger surface for an elevated site than for a ground level site (where lateral cues may be present).

This could have the unfortunate side-effect that a **FATO** ~~helipad~~ which is built 3 m above the surface (and therefore elevated by definition) might be out of operational scope for some helicopters - even though there might be a rich visual cue environment where rejects are not problematical. The presence of elevated sites where ground level surface requirements might be more appropriate could be brought to the attention of the ~~Authority~~ **competent authority**.

It can be seen that the size of the surface is directly related to the requirement of the helicopter to complete a rejected take-off following ~~an engine power unit~~ failure. If the helicopter has sufficient power such that a failure before or at TDP will not lead to a requirement for rejected take-off, the need for large surfaces is removed; sufficient power for the purpose of this ~~ACJ~~ **AMEGM** is considered to be the power required for hover-out-of-ground-effect (HOGE) one-engine-inoperative (OEI).

Following an ~~an engine power unit~~ failure at or after the TDP, the continued take-off path provides OEI clearance from the take-off surface and the distance to reach a point from where climb performance in the first, and subsequent segments, is assured.

If HOGE OEI performance exists at the height of the TDP, it follows that the continued take-off profile, which has been defined for a helicopter with a mass such that a rejected take-off would be required following ~~an engine power unit~~ failure at or before TDP, would provide the same, or better, obstacle clearance and the same, or less, distance to reach a point where climb performance in the first, and subsequent segments, is assured.

If the TDP is shifted upwards, provided that the HOGE OEI performance is established at the revised TDP, it will not affect the shape of the continued take-off profile but should shift the min-dip upwards by the same amount that the revised TDP has been increased - with respect to the basic TDP.

Such assertions are concerned only with the vertical or the back-up procedures and can be regarded as achievable under the following circumstances:

- 1 When the procedure is flown, it is based upon a profile contained in the ~~A Helicopter Flight Manual (AHFM)~~ **A Helicopter Flight Manual (AHFM)** - with the exception of the necessity to perform a rejected take-off.
- ~~2 The HOGE OEI performance is specified as in AC 29-2C, MG 12 for the Human External Cargo (HEC) Class D requirements.~~
- 23** The TDP, if shifted upwards (or upwards and backward in the back-up procedure) will be the height at which the HOGE OEI performance is established.
- 34** If obstacles are permitted in the back-up area they should continue to be permitted with a revised TDP.

JAR-OPS 3 Subparts F-I | Revised rule text

GM1-CAT.POL.H.215(b)(3) En-route - critical enginepower unit inoperative

FUEL JETTISON

The presence of obstacles along the en-route flight path may preclude compliance with CAT.POL.H.215(a)(1) at the planned mass at the critical point along the route. In this case fuel jettison at the most critical point may be planned, provided that the procedures in AMC1-CAT.OP.AH.150, 'Planning criteria – helicopter' 3. are complied with.

{Amdt. 5, 01.07.07}

~~ACJGM1-CAT.POL.H.225 to Appendix 1 to JAR OPS 3.005(i) Helicopter operations to/from a public interest site~~

THE PUBLIC INTEREST SITE PHILOSOPHY

See Appendix 1 to JAR OPS 3.005(i)

1 General

The original JAA Appendix 1 to JAR-OPS 3.005(i) - containing alleviations for public interest sites - was introduced in January 2002 to address problems that had been encountered by member Member States at hospital (and lighthouse) sites due to the applicable performance requirements of JAR-OPS 3 Subparts G and H. These problems were enumerated in ACJ to Appendix 1 to JAR-OPS 3.005(d) paragraph 8, part of which is reproduced below.†

†8 Problems with hospital sites

During implementation of JAR-OPS 3, it was established that a number of States had encountered problems with the impact of performance rules where helicopters were operated for HEMS. Although States accept that progress should be made towards operations where risks associated with a critical power unit failure are eliminated, or limited by the exposure time concept, a number of landing sites exist which do not (or never can) allow operations to pPerformance cClass 1 or 2 requirements.

These sites are generally found in a congested hostile environment:

- in the grounds of hospitals; or
- on hospital buildings;

The problem of hospital sites is mainly historical and, whilst the Authority could insist that such sites not be used - or used at such a low weight that critical power unit failure performance is assured, it would seriously curtail a number of existing operations.

Even though the rule for the use of such sites in hospital grounds for HEMS operations (Appendix 1 to JAR-OPS 3.005(d) sub-paragraph (c)(2)(i)(A)) attracts alleviation until 2005, it is only partial and will still impact upon present operations.

Because such operations are performed in the public interest, it was felt that the Authority should be able to exercise its discretion so as to allow continued use of such sites provided that it is satisfied that an adequate level of safety can be maintained - notwithstanding that the site does not allow operations to pPerformance cClass 1 or 2 standards. However, it is in the interest of continuing

JAR-OPS 3 Subparts F-I | Revised rule text

improvements in safety that the alleviation of such operations be constrained to existing sites, and for a limited period.”

As stated in this ACJ and embodied in the text of the appendix, the solution was short term (until 31 December 2004). During the comment period of **JAA NPA 18**, representations were made to the JAA that the alleviation should be extended to 2009. The review committee, in not accepting this request, had in mind that this was a short-term solution to address an immediate problem, and a permanent solution should be sought.

2. Public Interest Sites after 1 January 2005

Although elimination of such sites would remove the problem, it is recognized that phasing out, or rebuilding existing hospital and lighthouse ~~sites~~ **helicopter sites**, is a long-term goal which may not be cost-effective, or even possible, in some **Member States**.

It should be noted however that **CAT.POL.H.225** ~~existing paragraph (ae) of the appendix~~ limits the problem by confining approvals to public interest sites established before 1 July 2002 (established in this context means either: built before that date; or brought into service before that date – this precise wording was used to avoid problems associated with a ground level **aerodrome/operating site** ~~helicopter~~ where no building would be required). Thus the problem of these sites is contained and reducing in severity. This date was set approximately 6 months after the intended implementation of ~~the~~ **original JAR-OPS 3** appendix.

EASA adopted the JAA philosophy that, fFrom 1st January 2005 the approval of a public interest site ~~would~~ be confined to those sites where a CAT A procedure alone cannot solve the problem. The determination of whether the helicopter can or cannot be operated in accordance with ~~Subpart G (p~~ **Performance c** ~~Class 1)~~ should be established with the helicopter at a realistic payload and fuel to complete the mission. However, in order to reduce the risk at those sites, the application of the requirements contained in **CAT.POL.H.225** ~~paragraph (be)(2) of the appendix~~ **should be applied** ~~will be required~~.

Additionally and in order to promote understanding of the problem, the text contained in **CAT.POL.H.225** ~~paragraph (ce) of the appendix~~ **had** been amended to refer to ~~Subpart G of JAR OPS 3~~ **the performance class** and not to Annex 14 as in the original appendix. Thus Part C of the ~~o~~ **Operations m** ~~Manual~~ should reflect the non-conformance ~~with~~ **with that Subpart performance class 1, as well as the site specific procedures (approach and departure paths) to minimize the danger to third parties in the event of an incident.**

The following paragraph ~~sexplains~~ **discuss** the problem and solutions.

3. The problem associated with public interest sites

There are a number of problems: some of which can be solved with the use of appropriate helicopters and procedures; and others which, because of the size of the **aerodrome/operating site** ~~helicopter~~ or the obstacle environment, cannot. They consist of:

- ~~a.~~ Helicopters that cannot meet the performance criteria required by Subpart G;
- ~~b~~a. The size of the ~~FATO~~ **surface** of the **aerodrome/operating site** ~~helicopter~~ (smaller than that required by the manufacturer's procedure);
- ~~b~~c. An obstacle environment that prevents the use of the manufacturer's procedure (obstacles in the back-up area)

JAR-OPS 3 Subparts F-I | Revised rule text

cd. An obstacle environment that does not allow recovery following an **engine power unit** failure in the critical phase of take-off (a line of buildings requiring a demanding gradient of climb) at a realistic payload and fuel to complete the mission.

~~e. A ground level heliport (exposure is not permitted);~~

~~3.1 Problems associated with a; it was recognised at the time of the adoption of the original appendix that, although the number of helicopters not meeting the absolute performance criteria of a. above were dwindling, existing HEMS and lighthouse fleets could not be replaced until 2005. (There is still a possibility that limited production will not allow the complete replacement of such limited power helicopters before the 2004 date; it is therefore suggested that Authorities should, providing an order position can be established by the operator, allow the continued use of such helicopters for a limited period, without the additional mitigation required by paragraph (d)(2) of the appendix.)~~

3.12 Problems associated with **ba.**; the inability to climb and conduct a rejected landing back to the **aerodrome/operating site**~~heliport~~ following an engine failure before the Decision Point (DP).

~~3.23~~ Problems associated with **be.**; as in **ab.**

3.34 Problems associated with **cd**; climb into an obstacle following an engine failure after DP.

~~3.5 Problems associated with e.; may be related to;~~

~~—the size of the FATO which is too small for the manufacturers' procedure;~~

~~—no room for back-up;~~

~~—an obstacle in the take off path; or~~

~~—a mixture of all three.~~

~~With the exception of case a., p~~Problems cannot be solved in the immediate future but can, when mitigated with the use of the latest generation of helicopters (operated at a weight that can allow useful payloads and endurance), minimise exposure to risk.

4. Long Term Solution

Although not offering a complete solution, it was felt that a significant increase in safety could be achieved by applying an additional performance margin to such operations. This solution ~~could also be seen as mitigation proportional to the problem and would allowed~~ the time restriction of 2004 to be removed.

The required performance level of 8 % climb gradient in the first segment, reflects ICAO Annex 14 Volume II in Table 4-3 – Dimensions and slopes of obstacle limitations surfaces for **p**Performance **c**Class 2.

The performance delta is achieved without the provision of further manufacturer's data by using existing graphs to provide the **reduced take-off mass (RTOM)**.

If ~~we examine~~ the solution in relation to the original problem **is examined**, the effects can be seen.

4.1 Solution with relation to **ba.**; although the problem still exists, the safest procedure is a dynamic take-off reducing the time taken to achieve V_{stayup} and thus allowing VFR recovery – if the failure occurs at or after V_y and 200 feet, an IFR recovery is possible.

JAR-OPS 3 Subparts F-I | Revised rule text

- 4.2 Solution with relation to ~~b~~e.; as in ~~a~~b. above.
- 4.3 Solution with relation to ~~c~~d.; once again this does not give a complete solution, however the performance delta minimises the time during which a climb over the obstacle cannot be achieved.
- ~~4.4 Solution with relation to e.; as in 4.1 to 4.3 above.]~~
- [Amdt. 3, 01.04.04]

GM1-CAT.POL.H.225[ACJ to Appendix 1 to JAR OPS 3.005(i) sub paragraph (a)(2±) Helicopter operations at a Public Interest Site

IMPROVEMENT PROGRAM FOR PUBLIC INTEREST SITES~~IMPROVEMENT PROGRAM FOR PUBLIC INTEREST SITES~~

(See Appendix 1 to JAR OPS 3.005(i) sub paragraph (a)(1))

1. General

Although it is accepted that there will be a number of public interest sites that will remain for some time, it is in the interest of safety that the numbers are reduced and eventually, as a goal, all sites eliminated. A reduction of sites can be achieved in two ways:

- a. ~~b~~By an improvement in the performance of helicopters such that HOGE OEI is possible at weights where the mission can be performed; ~~and-~~
- b. ~~b~~By the use of a site improvement program: to take out of service those sites where the exposure is greatest; or by improving sites such that the performance requirement can be met.

2. Improvement in ~~p~~Performance

The advent of more powerful modern twin-engine helicopters has put into reach the ability to achieve the aim stated in 1.a. above. ~~A number~~**Today most** of these helicopters ~~a-re, in 2003,~~ al-most at the point where HOGE OEI with mission payload is possible.~~However, although technically feasible, it is not economically justifiable to require an immediate and complete re-equipping of all HEMS fleets.~~

3. Improvement of ~~s~~Sites

Where a site could be improved by redevelopment, for example by increasing the size of the FATO, it should be done; where the problems of a site are due to the obstacle environment, a program to re-site the facility or remove the obstacle(s) should be ~~a~~undertaken as a priority.

4. Summary

As ~~was~~ stated in ~~paragraph~~ 1. above, it is in the interest of **Member** States to reduce the risk of an accident due to an engine failure on take-off or landing. This could be achieved with a combination of **the following** policies:

- a. the use ~~of~~ more appropriate helicopters; ~~or~~
- b. ~~r~~improvement by redevelopment of a site; or
- ~~r~~c. the re-siting of facilities to alternative locations.

~~Some States have already undertaken to remove or improve public interest sites by using one, or more of the above methods. For those States where a compliance program is under way, the choice of reduction by elimination or redevelopment~~

JAR-OPS 3 Subparts F-I | Revised rule text

~~should not be put on hold whilst waiting for new generation helicopters. The improvement policy should be achieved in a reasonable time horizon – and this should be an element of the compliance program.~~

The approval to operate to public interest sites could be conditional upon such improvement programs being put into place. Unless such a policy is instituted, there will be no incentive for public interest sites to be eliminated in a reasonable time horizon.}

[Amdt. 3, 01.04.04]

AMC1-CAT.POL.H.225~~[ACJ to Appendix 1 to JAR OPS 3.005(i) sub-paragraph (b)(2) Helicopter operations at a pPublic iInterest sSite~~

HELICOPTER MASS LIMITATION FOR OPERATIONS AT A PUBLIC INTEREST SITE
~~HELICOPTER MASS LIMITATION FOR OPERATIONS AT A PUBLIC INTEREST SITE~~

~~(See Appendix 1 to JAR OPS 3.005(i) sub-paragraph (d)(2))~~

1. The helicopter mass limitation at take-off or landing specified in ~~Appendix 1 to JAR OPS 3.005(i) sub-paragraph (d)(2)~~ **CAT.POL.H.225 (b)(2)** should be determined using the climb performance data from 35 ft to 200 ft at ~~V_{Toss}~~ ~~toss~~ (First segment of the take-off flight path) contained in the Category A supplement of the **AFM Helicopter Flight Manual** (or equivalent manufacturer data acceptable to the JAA according to IEM OPS 3.480(a)(1) and (a)(2)) **to the competent authority in accordance with Annex I, definitions for 'Category A with respect to helicopters' and Category B with respect to helicopters'.**
2. The first segment climb data to be considered is established for a climb at the take-off safety speed ~~V_{Toss}~~ ~~toss~~, with the landing gear extended (when the landing gear is retractable), with the critical ~~engine~~ ~~power~~ ~~unit~~ inoperative and the remaining ~~engine~~ ~~power~~ ~~units~~ operating at an appropriate power rating (the 2 min 30 sec or 2 min ~~One Engine Inoperative~~ **OEI** power rating, depending on the helicopter type certification). The appropriate ~~V_{Toss}~~ ~~toss~~, is the value specified in the Category A performance section of the ~~Helicopter Flight Manual~~ **AFM** for vertical take-off and landing procedures (VTOL or Helipad or equivalent **manufacturer terminology**).
3. The ambient conditions at the ~~public interest site~~ ~~helicopter~~ (pressure-altitude and temperature) should be taken into account.}
4. ~~The data is usually provided in charts one of the following ways:~~
 - a. Height gain in ft over a horizontal distance of 100 ft in the first segment configuration (35 ft to 200 ft, ~~V_{Toss}~~ ~~toss~~, 2 min 30 sec / 2 min OEI power rating). This chart should be entered with a height gain of 8 ft per 100 ft horizontally travelled, resulting in a mass value for every pressure-altitude/temperature combination considered.
 - b. Horizontal distance to climb from 35 ft to 200 ft in the first segment configuration (~~V_{Toss}~~ ~~toss~~, 2 min 30 sec / 2 min OEI power rating). This chart should be entered with a horizontally distance of 628 m (2 062 ft), resulting in a mass value for every pressure-altitude/temperature combination considered.
 - c. Rate of climb in the first segment configuration (35 ft to 200 ft, ~~V_{Toss}~~ ~~toss~~, 2 min 30 sec / 2 min OEI power rating). This chart can be entered with a rate of climb equal to the climb speed (~~V_{Toss}~~ ~~toss~~) value in knots (converted to ~~t~~ ~~True~~ ~~Airspeed~~) multiplied by 8.-1, resulting in a mass value for every pressure-altitude/temperature combination considered.}

JAR-OPS 3 Subparts F-I | Revised rule text

~~{ }~~

~~[Amdt. 2, 01.01.02; Amdt. 5, 01.07.07]~~

~~[ACJ to Subpart H]~~

GM to Section 2, Chapter 3 pPerformance cClass 2

OPERATIONS IN PERFORMANCE CLASS~~OPERATIONS IN PERFORMANCE CLASS 2~~

~~See Subpart H~~

1. INTRODUCTION

This **GM**~~paper~~ describes **pPerformance cClass 2** as established in ~~JAR-OPS 3, Subpart H~~**Part-CAT**. It has been produced for the purpose of:

- a. ~~explaining~~**discussing** the underlying philosophy of ~~o~~**Operations** in **pPerformance cClass 2**;
- b. showing simple ~~mean~~**st**~~hods~~ of compliance; and
- c. explaining how to determine - with examples and diagrams:
 - i.- the take-off and landing masses;
 - ii.- the length of the safe-forced-landing area;
 - iii.- distances to establish obstacle clearance; and
 - iv.- entry point(s) into **pPerformance cClass 1**.

It ~~discusses~~**explains** the derivation of **pPerformance cClass 2** from ICAO Annex 6 Part III and describes an alleviation which may be approved **in accordance with CAT.POL.H.305** following a **rRisk aAssessment**.

It ~~reproduces relevant definitions~~; examines the basic requirements; discusses the limits of operation,~~7~~ and considers the benefits of the use of **pPerformance cClass 2**.

It contains examples of **pPerformance cClass 2** in specific circumstances, and explains how these examples may be generalised to provide the operators with methods of calculating landing distances and obstacle clearance.

2. DEFINITIONS **USED IN THIS GM**

~~To assist in the reading of this paper, definitions from JAR-OPS 3, Subpart F~~**The definitions effer the following terms, used in this GM, are contained in Article 2 of the Cover Regulation or in AMC.DEF.100Annex I and its AMC.**~~have been reproduced:~~

- a. ~~d~~**Distance DR-D**~~is the horizontal distance that the helicopter has travelled from the end of the take-off distance available.~~
- b. ~~d~~**Defined point after take-off (DPATO)**~~.The point, within the take-off and initial climb phase, before which the helicopter's ability to continue the flight safely, with the critical power unit inoperative, is not assured and a forced landing may be required.~~
- c. ~~d~~**Defined point before landing (DPBL)**~~.The point within the approach and landing phase, after which the helicopter's ability to continue the flight safely, with the critical power unit inoperative, is not assured and a forced landing may be required.~~

JAR-OPS 3 Subparts F-I | Revised rule text

- d. ~~lLanding distance available (LDAH).The length of the final approach and take-off area plus any additional area declared available and suitable for helicopters to complete the landing manoeuvre from a defined height.~~
- e. ~~lLanding distance required (LDRH).The horizontal distance required to land and come to a full stop from a point 15m (50ft) above the landing surface.~~
- f. ~~pPerformance cClass 2.Performance Class 2 operations are those operations such that, in the event of critical power unit failure, performance is available to enable the helicopter to safely continue the flight, except when the failure occurs early during the take off manoeuvre or late in the landing manoeuvre, in which cases a forced landing may be required.~~
- g. ~~sSafe forced landing (SFL).Unavoidable landing or ditching with a reasonable expectancy of no injuries to persons in the aircraft or on the surface.~~
- h. ~~tTake-off distance available (TODA).The length of the final approach and take-off area plus the length of any clearway (if provided) declared available and suitable for helicopters to complete the take-off.~~

The following terms, which are not defined **Annex I**, in JAR OPS 3 Subpart F, are used in **this GME** following text:

- V_T . ~~aA~~ target speed at which to aim at the point of minimum ground clearance (min-dip) during acceleration from TDP to V_{Toss} ;
- V_{50} . ~~aA~~ target speed and height utilised to establish an **AFM Flight Manual** distance (in compliance with the requirement of CS/JAR 29.63) from which climb out is possible; **and**
- $V_{stay-up}$. ~~aA~~ colloquial term used to indicate a speed at which a descent would not result following an **engine power unit** failure. This speed is several knots lower than V_{Toss} at the equivalent take-off mass.

3. WHAT DEFINES PERFORMANCE CLASS 2

Performance ~~cClass 2~~ can be considered as ~~pPerformance cClass 3~~ take-off or landing, and ~~pPerformance cClass 1~~ climb, cruise and descent. It comprises an ~~aAll-Engine-Operating (AEO)~~ obstacle clearance regime for the take-off or landing phases, and a ~~One Engine Inoperative (OEI)~~ obstacle clearance regime for the climb, cruise, descent, approach and missed approach phases.

~~Note:~~ For the purpose of performance calculations in **JAR OPS 3 Part-CAT**, the CS/JAR 29.67 Category A climb performance criteria is used:

- a.-** 150 ft/min at 1,000 ft (at V_y);
and depending on the choice of DPATO:
- b.-** 100 ft/min up to 200 ft (at V_{Toss}),
at the appropriate power settings.

3.1 Comparison of obstacle clearance in all ~~pPerformance cClasses~~

Figure 2 shows the profiles of the three ~~pPerformance cClasses~~ - superimposed on one diagram.

Performance ~~cClass 1 (PC 1):~~ from TDP, requires OEI obstacle clearance in all phases of flight; the construction of Category A procedures, provides for a flight path to the first climb segment, a level acceleration segment to V_y (which may be

JAR-OPS 3 Subparts F-I | Revised rule text

shown concurrent with the first segment), followed by the second climb segment from V_y at 200 ft (see Figure 1).

Figure 1 - All Performance Classes (a comparison)

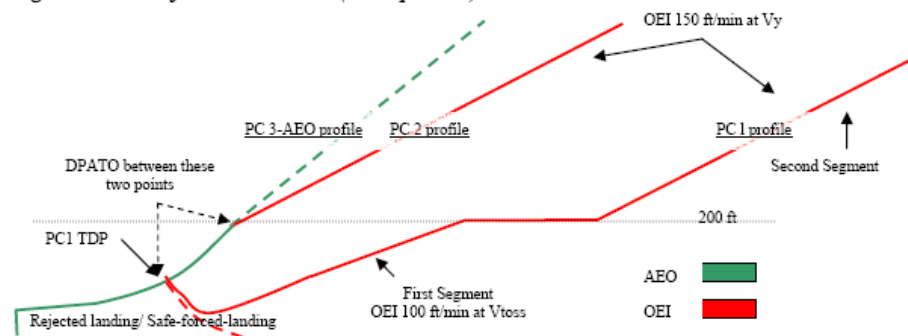

- Performance Class 2 (PC 2) requires AEO obstacle clearance to DPATO and OEI from then on. The take-off mass has the PC 1 second segment climb performance at its basis therefore, at the point where V_y at 200 ft is reached, Performance Class 1 is achieved (see also Figure 3).
- Performance Class 3 (PC 3) requires AEO obstacle clearance in all phases.

Figure 2 - Performance Class 1 distances

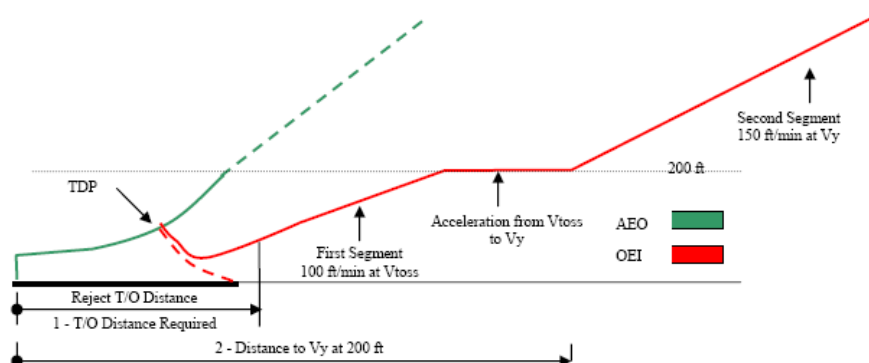

3.2 Comparison of the discontinued take-off in all Performance Classes

- PC 1 - requires a prepared surface on which a rejected landing can be undertaken (no damage); and
- PC 2 and 3 - require a safe-forced-landing surface (some damage can be tolerated but there must be a reasonable expectancy of no injuries to persons in the aircraft or third parties on the surface).

4. THE DERIVATION OF PERFORMANCE CLASS 2

Subpart H - PC 2 is primarily based on the text of ICAO Annex 6 Part III Section II and its attachments - which provide for the following:

JAR-OPS 3 Subparts F-I | Revised rule text

- a. ~~o~~Obstacle clearance before DPATO:; the helicopter shall be able, with all engines operating, to clear all obstacles by an adequate margin until it is in a position to comply with b. below;-
- b. ~~o~~Obstacle clearance after DPATO:; the helicopter shall be able, in the event of the critical ~~enginepower-unit~~ becoming inoperative at any time after reaching DPATO, to continue the take-off clearing all obstacles along the flight path by an adequate margin until it is able to comply with en-route clearances; ~~and-~~
- c. ~~e~~Engine failure before DPATO:; before the DPATO, failure of the critical ~~enginepower-unit~~ may cause the helicopter to force land; therefore a safe-forced-landing should be possible (this is analogous to the requirement for a reject in ~~p~~Performance ~~c~~Class 1 but where some damage to the helicopter can be tolerated.)

5. BENEFITS OF ~~JAR-OPS-3~~ PERFORMANCE CLASS 2

Operations in ~~p~~Performance ~~c~~Class 2 permit advantage to be taken of an ~~all-engines-operating~~ (AEO) procedure for a short period during take-off and landing - whilst retaining engine failure accountability in the climb, descent and cruise. The benefits include ~~the~~:

- a.- ~~a~~Ability to use (the reduced) distances scheduled for the AEO - thus permitting operations to take place at smaller ~~heliports-aerodromes~~ and allowing airspace requirements to be reduced;-
- b.- ~~a~~Ability to operate when the safe-forced-landing distance available is located outside the boundary of the ~~heliportaerodrome~~;-
- c.- ~~a~~Ability to operate when the take-off-distance required is located outside the boundary of the ~~heliportaerodome~~; ~~and-~~
- d.- ~~a~~Ability to use existing Category A profiles and distances when the surface conditions are not adequate for a reject but are suitable for a safe-forced-landing (for example when the ground is waterlogged).

Additionally, following a ~~r~~Risk ~~a~~Assessment when the use of exposure is ~~permitted~~ ~~approved~~ by the ~~Authority~~ ~~competent authority~~ ~~the~~:

- i.- ~~a~~Ability to operate when a safe-forced landing is not assured in the take-off phase; ~~and-~~
- ii.- ~~a~~Ability to penetrate the HV curve for short periods during take-off or landing.

6 IMPLEMENTATION OF PERFORMANCE CLASS 2 IN ~~JAR-OPS-3~~ ~~PART~~ ~~art~~-CAT

The following sections ~~explain~~ ~~discuss~~ the principles of the implementation of ~~p~~Performance ~~c~~Class 2.

6.1 Does ICAO spell it all out?

ICAO Annex 6 does not give guidance on how DPATO should be calculated nor does it require that distances be established for the take-off. However, it does require that, up to DPATO AEO, and from DPATO OEI, obstacle clearance is established (see Figure 3 and Figure 4 which are simplified versions of the diagrams contained in Annex 6 Part III, Attachment A).

~~Note:~~ (ICAO Annex 8 – Airworthiness of Aircraft (Part IV, Chapter 2.2.1.3.4) requires that an AEO distance be scheduled for all helicopters operating in

Performance Classes 2 & 3. **ICAO Annex 6** is dependent upon the scheduling of the AEO distances, required in Annex 8, to provide data for the location of DPATO.)

When showing obstacle clearance, the divergent obstacle clearance height required for IFR is - as in **Performance Class 1** - achieved by the application of the additional obstacle clearance of 0.01 **distance DR** (DR - the distance from the end of 'take-off-distance-available' - see the pictorial representation in Figure 4 and the definition in **Annex I section 2.1.1**).

As can also be seen from Figure 4, flight must be conducted in VFR until DPATO has been achieved (and deduced that if an engine failure occurs before DPATO, entry into IFR is not permitted (as the OEI climb gradient will not have been established)).

Figure 3 - Performance Class 2 Obstacle Clearance

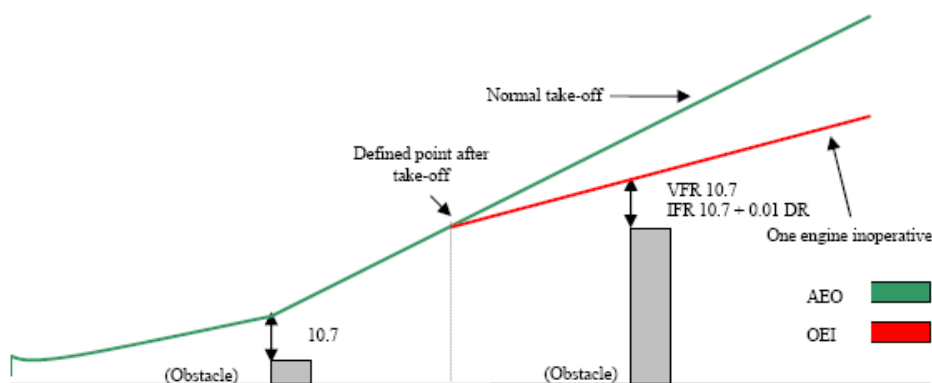
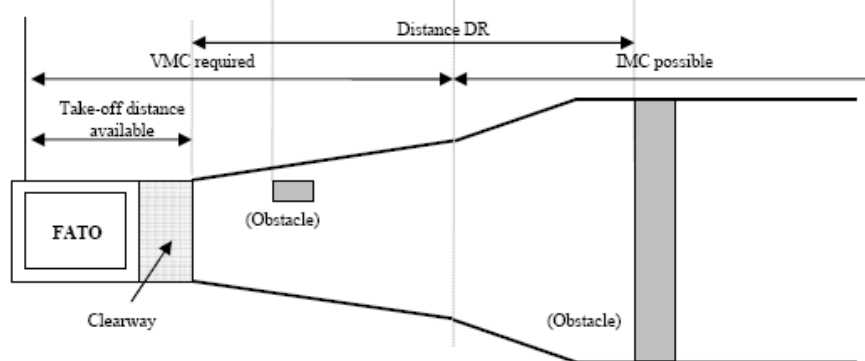

Figure 4 - Performance Class 2 Obstacle Clearance (plan view)



6.2 Function of DPATO

From the preceding paragraphs it can be seen that DPATO is germane to PC 2. It can also be seen that, in view of the many aspects of DPATO, it has, potentially, to satisfy a number of requirements which are not necessarily synchronised (nor need to be).

JAR-OPS 3 Subparts F-I | Revised rule text

It is clear that it is only possible to establish a single point for DPATO, satisfying the requirement of 4 b & 4 c above, when:

- a.- accepting the TDP of a Category A procedure; or
- b.- extending the safe-forced-landing requirement beyond required distances (if data is available to permit the calculation of the distance for a safe-forced-landing from the DPATO).

It could be argued that the essential requirement for DPATO is contained in section 4 b - OEI obstacle clearance. From careful examination of the flight path reproduced in Figure 3 above, it may be reasonably deduced that DPATO is the point at which adequate climb performance is established (examination of Category A procedures would indicate that this could be (in terms of mass, speed and height above the take-off surface) the conditions at the start of the first or second segments - or any point between.)

Note: (The diagrams in Attachment A of ICAO Annex 6, do not appear to take account of drop down - permitted under Category A procedures; similarly with helideck departures, the potential for acceleration in drop down below deck level (once the deck edge has been cleared) is also not shown. These omissions could be regarded as a simplification of the diagram, as drop down is discussed and accepted in the accompanying ICAO text.)

It may reasonably be argued that, during the take-off and before reaching an appropriate climb speed ($V_{\text{ross}}/V_{\text{y}}$ or V_{y}), V_{stayup} will already have been achieved (where V_{stayup} is the ability to continue the flight and accelerate without descent - shown in some Category A procedures as V_{T} or target speed) and where, in the event of an engine failure, no landing would be required.

It is postulated that, to practically satisfy all the requirements of sections 4 a, b and c above, **we DPATO does not need to be defined DPATO** at one synchronised point; **provisions we can be meet requirements separately** - i.e. defining the distance for a safe-forced-landing, and then establishing the OEI obstacle clearance flight path.

As the point at which the helicopter's ability to continue the flight safely, with the critical ~~power unit~~ **engine** inoperative is the critical element, it is that for which DPATO is used in this text.

Figure 5 - The three elements in a PC 2 take-off

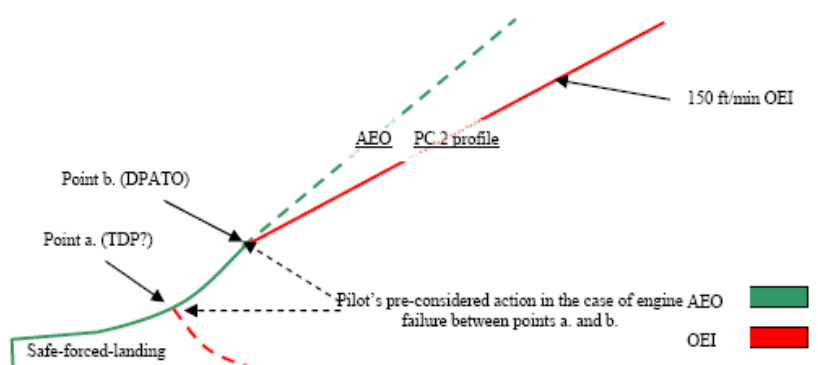

JAR-OPS 3 Subparts F-I | Revised rule text

6.2.1 The three elements from the pilot's perspective

When seen from the pilot's perspective (see Figure 5), there are three elements of the PC 2 take-off - each with associated related actions which need to be considered in the case of an engine failure:

- a. action in the event of an engine failure - up to the point where a forced-landing will be required;
- b. action in the event of an engine failure - from the point where OEI obstacle clearance is established (DPATO); **and-**
- c. pre-considered action in the event of an engine failure - in the period between a. and b.

The action of the pilot in a. and b. is deterministic i.e. it remains the same for every occasion. For pre-consideration of the action at point c.; as is likely that the planned flight path will have to be abandoned (the point at which obstacle clearance using the OEI climb gradients not yet being reached) the pilot must (before take-off) have considered his options and the associated risks, and have in mind the course of action that will be pursued in the event of an engine failure during that short period. (As it is likely that any action will involve turning manoeuvres, the effect of turns on performance must be considered.)

Take-off mass for **pPerformance cClass 2**

As previously stated, **pPerformance cClass 2** is an AEO take-off which, from DPATO, has to meet the requirement for OEI obstacle clearance in the climb and en-route phases. Take-off mass is therefore the mass that gives at least the minimum climb performance of 150 ft/min at V_y , at 1 000 ft above the take-off point, and obstacle clearance.

As can be seen in Figure 6 below, the take-off mass may have to be modified when it does not provide the required OEI clearance from obstacles in the take-off-flight path (exactly as in **pPerformance cClass 1**). This could occur when taking off from **an aerodrome/operating site** ~~heliport~~ where the flight path has to clear an obstacle such a ridge line (or line of buildings) which can neither be:

- i.- flown around using VFR and see and avoid; nor
- ii.- cleared using the minimum climb gradient given by the take-off mass (150 ft/min at 1 000 ft).

In this case, the take-off mass has to be modified (using data contained in the **AHFM**) to give an appropriate climb gradient.

Figure 6 - Performance Class 2 (enhanced climb gradient)

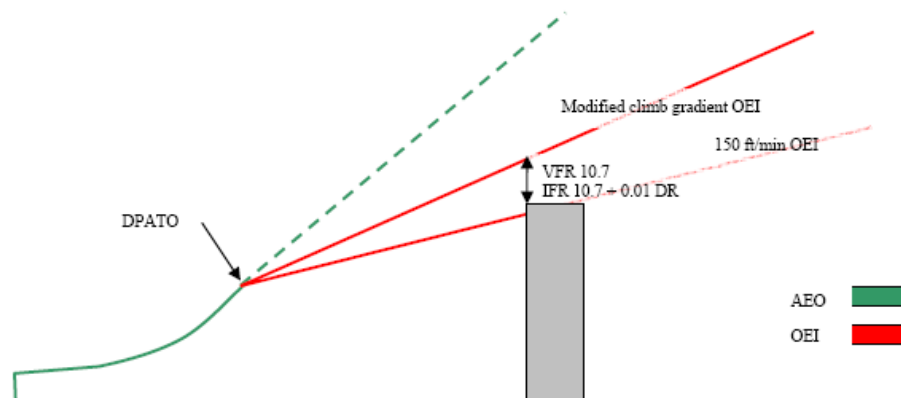

6.4 Do distances have to be calculated?

Distances do not have to be calculated if, by using pilot judgement or standard practice, it can be established that:

- a.- a safe-forced-landing is possible following an engine failure (notwithstanding that there might be obstacles in the take-off path); and
- b.- obstacles can be cleared (or avoided) - AEO in the take-off phase and OEI in the climb.

If early entry (in the sense of cloud base) into IMC is expected, an IFR departure should be planned. However, standard masses and departures can be used when described in the Operations Manual.

6.5 The use of Category A data

In Category A procedures, TDP is the point at which either a rejected landing or a safe continuation of the flight, with OEI obstacle clearance, can be performed.

For PC 2 (when using Category A data), only the safe-forced-landing (reject) distance depends on the equivalent of the TDP; if an engine fails between TDP and DPATO the pilot has to decide what action is required - it is not necessary for a safe-forced-landing distance to be established from beyond the equivalent of TDP (see Figure 5 and discussion in section 6.2.1 above).

Category A procedures based on a fixed V_{tOSS} are usually optimized either for the reduction of the rejected take-off distance, or the take-off distance. Category A procedures based on a variable V_{tOSS} allow either a reduction in required distances (low V_{tOSS}) or an improvement in OEI climb capability (high V_{tOSS}). These optimisations may be beneficial in PC 2 to satisfy the dimensions of the take-off site.

In view of the different requirements for PC 2 (from PC 1), it is perfectly acceptable for the two calculations (one to establish the safe-forced-landing distance and the other to establish DPATO) to be based upon different Category A procedures. However, if this method is used, the mass resulting from the calculation cannot be more than the mass from the more limiting of the procedures.

6.6 DPATO and obstacle clearance

If it is necessary for OEI obstacle clearance to be established in the climb, the starting point (DPATO) for the (obstacle clearance) gradient has to be established. Once DPATO is defined, the OEI obstacle clearance is relatively easy to calculate with data from the **HFMAFM**.

6.6.1 DPATO based on AEO distance

In the simplest case; if provided, the scheduled AEO to 200 ft at V_y can be used (see Figure 7).

Figure 7 - Suggested AEO locations for DPATO

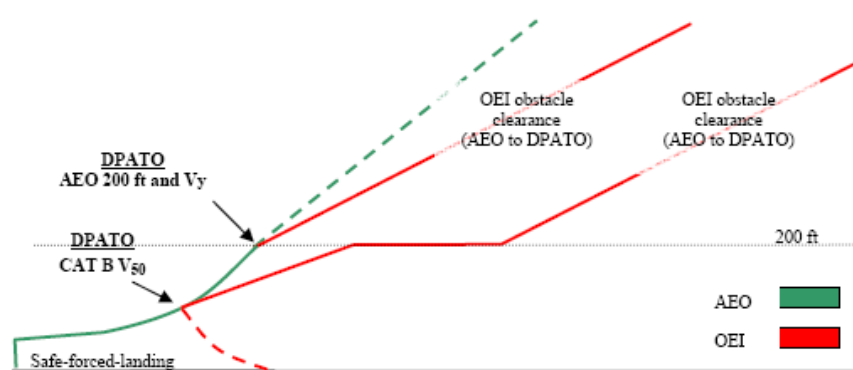

Otherwise, and if scheduled in the **HFMAFM**, the AEO distance to 50 ft (V_{50}) – determined in accordance with CS/JAR 29.63 - can be used (see Figure 7). Where this distance is used, it will be necessary to ensure that the V_{50} climb out speed is associated with a speed and mass for which OEI climb data is available so that, from V_{50} , the OEI flight path can be constructed.

6.6.2 DPATO based on Category A distances

It is not necessary for specific AEO distances to be used (although for obvious reasons it is preferable); if they are not available, a flight path (with OEI obstacle clearance) can be established using Category A distances (see Figure 8 and Figure 9) - which will then be conservative.

Figure 8 - Using Cat A data; actual and apparent position of DPATO (V_{loss} and start of first segment)

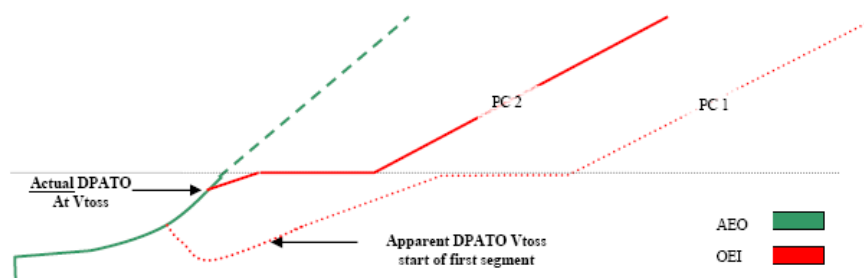

JAR-OPS 3 Subparts F-I | Revised rule text

~~Note:~~ the apparent DPATO is for planning purposes only in the case where AEO data is not available to construct the take-off flight path. The actual OEI flight path will provide better obstacle clearance than the apparent one (used to demonstrate the minimum requirement) - as seen from the firm and dashed lines in the above diagram figure.

Figure 9 - Using Cat A data; actual and apparent position of DPATO (V_y and start of second segment)

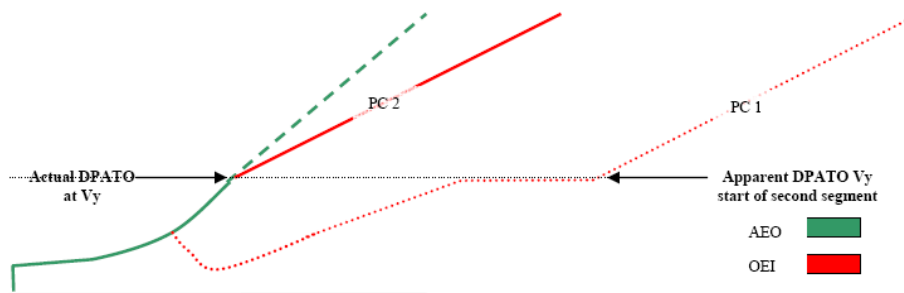

6.6.3 Use of most favourable Category A data

The use of AEO data is recommended for calculating DPATO. However, where an AEO distance is not provided in the flight manual, distance to V_y at 200 ft, from the most favourable of the Category A procedures, can be used to construct a flight path (provided it can be demonstrated that AEO distance to 200 ft at V_y is always closer to the take-off point than the CAT A OEI flight path).

In order to satisfy the requirement of **CAT.POL.H.315** ~~JAR-OPS 3-525~~, the last point from where the start of OEI obstacle clearance can be shown is at 200 ft.

6.7 The calculation of DPATO - a summary

DPATO should be defined in terms of speed and height above the take-off surface and should be selected such that ~~HFMAFM~~ **HFMAFM** data (or equivalent data) is available to establish the distance from the start of the take-off up to the DPATO (conservatively if necessary).

6.7.1 First method

DPATO is selected as the ~~HFMAFM~~ **HFMAFM** Category B take-off distance (V_{50} speed or any other take-off distance scheduled in accordance with CS/JAR 29.63) provided that within the distance the helicopter can achieve:

- a.- ~~One of the V_{Toss} values~~ (or the unique V_{Toss} value if **it** is not variable) provided in the ~~HFMAFM~~, selected so as to assure a climb capability according to Cat A criteria; or
- b.- V_y .

Compliance with **CAT.POL.H.315** ~~JAR-OPS 3-525~~ would be shown from V_{50} (or the scheduled Category B take-off distance).

6.7.2 Second method

DPATO is selected as equivalent to the TDP of a Category A clear area take-off procedure conducted in the same conditions.

JAR-OPS 3 Subparts F-I | Revised rule text

Compliance with **CAT.POL.H.315** ~~JAR-OPS 3.525~~ would be shown from the point at which $V_{\text{ross}}^{\text{stoss}}$, a height of at least 35 ft above the take-off surface and a positive climb gradient are achieved (which is the Category A clear area take-off distance).

Safe-forced-landing areas should be available from the start of the take-off, to a distance equal to the Category A "clear area" rejected take-off distance.

6.7.3 Third method

As an alternative; DPATO could be selected such that ~~Helicopter Flight Manual~~ **AFM** one engine inoperative (OEI) data is available to establish a flight path initiated with a climb at that speed. This speed should then be:

- a.- One of the $V_{\text{ross}}^{\text{stoss}}$ values (or the unique $V_{\text{ross}}^{\text{stoss}}$ value if it is not variable) provided in the ~~Helicopter Flight Manual~~ **AFM**, selected so as to assure a climb capability according to Category A criteria; or
- b.- V_y .

The height of the DPATO should be at least 35 ft and can be selected up to 200 ft. Compliance with **CAT.POL.H.315** ~~JAR-OPS 3.525~~ would be shown from the selected height.

6.8 Safe-forced-landing distance

Except as provided in 6.7.2 above, the establishment of the safe-forced-landing distance could be problematical as it is not likely that PC 2 specific data will be available in the ~~HFMAFM~~ **AFM**.

By definition, the Category A reject distance may be used when the surface is not suitable for a reject, but may be satisfactory for a safe-force-landing (for example where the surface is flooded or is covered with vegetation).

Any Category A (or other accepted) data may be used to establish the distance – however, once established it remains valid only if the Category A mass (or the mass from the accepted data) is used and the Category A (or accepted) AEO profile to the TDP is flown. In view of these constraints, the likeliest Category A procedures are the clear area or the short field (restricted area/site) procedures.

From Figure 10, it can be seen that if the Category B V_{50} procedure is used to establish DPATO, the combination of the distance to 50 ft and the Category A 'clear area' landing distance, required by CS/JAR 29.81 (the horizontal distance required to land and come to a complete stop from a point 50 ft above the landing surface), will give a good indication of the maximum safe-forced-landing distance required (see also the ~~explanation~~ **discussion** on V_{stayup} above).

Figure 10 - Category B (V_{50}) safe-forced-landing distance

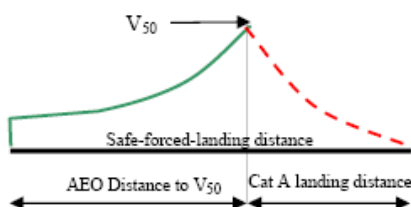

6.9 Performance cClass 2 landing

For other than PC 2 operations to elevated **FATOs** or ~~heliport~~/helidecks (see the ~~discussion~~ in section 7.4.1 below), the principles for the landing case are much

JAR-OPS 3 Subparts F-I | Revised rule text

simpler. As the performance requirement for PC 1 and PC 2 landings are virtually identical, the condition of the landing surface is the main issue.

If the engine fails at any time during the approach, the helicopter must be able either: to perform a go-around meeting the requirements of **CAT.POL.H.315**~~JAR-OPS 3.525~~; or perform a safe-forced-landing on the surface. In view of this, and if using PC 1 data, the LDP should not be lower than the corresponding TDP (particularly in the case of a variable TDP).

The landing mass will be identical to the take-off mass for the same site (with consideration for any reduction due to obstacle clearance - as shown in Figure 6 above).

In the case of a balked landing (i.e. the landing site becomes blocked or unavailable during the approach); the full requirement for take-off obstacle clearance must be met.

7. OPERATIONS IN PERFORMANCE CLASS 2 WITH EXPOSURE

~~JAR-OPS 3~~**The Implementing Rules** offers an opportunity to discount the requirement for an assured safe-forced-landing area in the take-off or landing phase - subject to an approval from the ~~Authority~~**competent authority**. The following sections deal with this option:

7.1 Limit of ~~e~~Exposure

As stated above, ~~p~~**Performance c**Class 2 has to ensure AEO obstacle clearance to DPATO and OEI obstacle clearance from that point. This does not change with the application of exposure.

It can therefore be stated that operations with exposure are concerned only with alleviation from the requirement for the provision of a safe -forced -landing.

The absolute limit of exposure is 200 ft - from which point OEI obstacle clearance must be shown.

7.2 The principle of ~~r~~Risk ~~a~~Assessment

~~ICAO Annex 6 Part III Chapter 3.1.2 (Fifth Edition July 2001) states that:~~

~~3.1.2 Performance Class 3 helicopters shall only be operated in conditions of weather and light, and over such routes and diversions therefrom, that permit a safe forced landing to be executed in the event of engine failure. The conditions of this paragraph apply also to performance Class 2 helicopters prior to the defined point after take-off and after the defined point before landing.~~

~~The ICAO Helicopter and Tilt rotor Study Group, is engaged in an ongoing process to amend Chapter 3 to take account of current practices following this process the proposed text is likely to be~~**ICAO Annex 6 Part III Chapter 3.1.2 (Sixth Edition July 2007) states that:**

—“3.1.2 In conditions where the safe continuation of flight is not ensured in the event of a critical **enginepower**—unit failure, helicopter operations shall be conducted in a manner that gives appropriate consideration for achieving a safe-forced-landing.”

Although a safe-forced-landing may no longer be the (absolute) Standard, it is considered that **r**Risk **a**Assessment is obligatory to satisfy the amended requirement for 'appropriate consideration'.

Risk **a**Assessment used in ~~JAR-OPS 3~~ for fulfillment of this proposed Standard is consistent with principles described in 'AS/NZS 4360:1999'.

JAR-OPS 3 Subparts F-I | Revised rule text

~~Note:~~ terms used in this text and defined in the AS/NZS Standard are shown in Sentence Case e.g. ~~r~~Risk ~~a~~Assessment or ~~r~~Risk ~~r~~Reduction.

7.3 The application of ~~r~~Risk ~~a~~Assessment to ~~JAR-OPS 3~~~~p~~Performance ~~c~~Class 2

Under circumstances where no risk attributable to engine failure (beyond that inherent in the safe-forced-landing) is present, operations in ~~p~~Performance ~~c~~Class 2 may be conducted in accordance with the non-alleviated requirements contained above - and a safe-forced-landing will be possible.

Under circumstances where such risk would be present i.e.: operations to an elevated ~~FATO~~~~heliport~~ (deck edge strike); or, when permitted, operations from a site where a safe-forced-landing cannot be accomplished because the surface is inadequate; or where there is penetration into the HV curve for a short period during take-off or landing (a limitation in CS/JAR 29 ~~HFMs~~~~AFMs~~), operations have to be conducted under a specific approval.

Provided such operations are ~~r~~Risk ~~a~~Assessed and can be conducted to an established safety target - they may be approved **in accordance with CAT.POL.H.305**.

7.3.1 The elements of the ~~r~~Risk ~~m~~Management

The approval process consists of an operational ~~r~~Risk ~~a~~Assessment and the application of four principles:

- a. a safety target;
- b. a helicopter reliability assessment;
- c. continuing airworthiness; and
- d. mitigating procedures.

7.3.2 The safety target

The main element of the ~~JAA~~~~r~~Risk ~~a~~Assessment when exposure was initially introduced **by the JAA** into JAR-OPS 3 (NPA OPS-8), was the assumption that turbine engines in helicopters would have failure rates of about 1:100 000 per flying hour; which would permit (against the agreed safety target of 5×10^{-8} per event) an exposure of about 9 seconds for twins during the take-off or landing event. (When choosing this target it was assumed that the majority of current well maintained turbine powered helicopters would be capable of meeting the event target - it therefore represents the ~~r~~Residual ~~r~~Risk).

~~(Note:~~ Residual ~~r~~Risk is considered to be the risk that remains when all mitigating procedures - airworthiness and operational - are applied (see sections 7.3.4 and 7.3.5 below)).

7.3.3 The reliability assessment

The ~~JAA~~reliability assessment was initiated to test the hypothesis (stated in 7.3.2 above) that the majority of turbine powered types would be able to meet the safety target. This hypothesis could only be confirmed by an examination of the manufacturers' power-loss data.

7.3.4 Mitigating procedures (airworthiness)

Mitigating procedures consist of a number of elements:

- a. the fulfilment of all manufacturers' safety modifications;
- b. a comprehensive reporting system (both failures and usage data); and

JAR-OPS 3 Subparts F-I | Revised rule text

- c. the implementation of a ~~u~~Usage ~~m~~Monitoring ~~s~~System (UMS).

Each of these elements is to ensure that engines, once shown to be sufficiently reliable to meet the safety target, will sustain such reliability (or improve upon it).

The monitoring system is felt to be particularly important as it had already been demonstrated that when such systems are in place it inculcates a more considered approach to operations. In addition the elimination of 'hot starts', prevented by the UMS, itself minimises the incidents of turbine burst failures.

7.3.5 Mitigating procedures (operations)

Operational and training procedures, to mitigate the risk - or minimise the consequences - are required of the operator. Such procedures are intended to minimise risk by ensuring that:

- a. the helicopter is operated within the exposed region for the minimum time; and
- b. simple but effective procedures are followed to minimise the consequence should an engine failure occur.

7.4 Operation with ~~e~~Exposure—~~the alleviation and the requirement~~

When operating with exposure, there is alleviation from the requirement to establish a safe-forced-landing area (which extends to landing as well as take-off); however, the requirement for obstacle clearance - AEO in the take-off and from DPATO OEI in the climb and en-route phases - remains (both for take-off and landing).

The take-off mass is obtained from the more limiting of the following:

- a.- the climb performance of 150 ft/min at 1000 ft above the take-off point; or
- b.- obstacle clearance (in accordance with 6.3 above); or
- c.- AEO hover out of ground effect (HOGE) performance at the appropriate power setting. (AEO HOGE is required to ensure acceleration when (near) vertical dynamic take-off techniques are being used. Additionally for elevated **FATO or heliports/helidecks**, it ensures a power reserve to offset ground cushion dissipation; and ensures that, during the landing manoeuvre, a stabilised HOGE is available - should it be required.)

7.4.1 Operations to elevated **FATOs or heliports/helidecks**

PC 2 operations to elevated **FATOs heliports** and helidecks are a specific case of operations with exposure. In these operations, the alleviation covers the possibility of:

- a.- a deck-edge strike if the engine fails early in the take-off or late in the landing; ~~and~~
- b.- penetration into the HV Curve during take-off and landing; and
- c.- forced landing with obstacles on the surface (hostile water conditions) below the elevated **FATO heliport** (helideck). The take-of mass is as stated above and relevant techniques are as described in ~~GM1--CAT.POL.H.3105ACJ-OPS 3-520(ca)(3)& and CAT.POL.H.3253-535(ca)(3)->~~ **GM1--CAT.POL.H.3105ACJ-OPS 3-520(ca)(3)** and **CAT.POL.H.3253-535(ca)(3)**.

Note:

It is unlikely that the DPATO will have to be calculated with operations to helidecks (due to the absence of obstacles in the take-off path).

JAR-OPS 3 Subparts F-I | Revised rule text

7.4.2 Additional requirements for operations to **h**Helidecks in a **h**Hostile **e**Environment

For a number of reasons (e.g. the deck size, and the helideck environment – including obstacles and wind vectors), it was not anticipated that operations in PC 1 would be technically feasible or economically justifiable by the projected JAA deadline of 2010 (OEI HOGE could have provided a method of compliance but this would have resulted in a severe and unwarranted restriction on payload/range).

However, due to the severe consequences of an engine failure to helicopters involved in take-off and landings to helidecks located in hostile sea areas (such as the North Sea or the North Atlantic), a policy of **r**Risk **r**Reduction is called for. As a result, enhanced **c**Class 2 take-off and landing masses together with techniques that provide a high confidence of safety due to:

- a. deck-edge avoidance; and
- b. ~~–~~drop-down that provides continued flight clear of the sea,

are seen as practical measures.

For helicopters which have a Category A elevated helideck procedure, certification is satisfied by demonstrating a procedure and adjusted masses (adjusted for wind as well as temperature and pressure) which assure a 15 ft deck edge clearance on take-off and landing. It is therefore recommended that manufacturers, when providing enhanced PC2 procedures, use the provision of this deck-edge clearance as their benchmark.

As the height of the helideck above the sea is a variable, drop down has to be calculated; once clear of the helideck, a helicopter operating in PC1 would be expected to meet the 35 ft obstacle clearance. Under circumstances other than open sea areas and with less complex environmental conditions, this would not present difficulties. As the provision of drop down takes no account of operational circumstances, standard drop down graphs for enhanced PC2 - similar to those in existence for Category A procedures - are anticipated.

Under conditions of offshore operations, calculation of drop down is not a trivial matter - the following examples indicate some of the problems which might be encountered in hostile environments:

- i.- Occasions when tide is not taken into account and the sea is running irregularly - the level of the obstacle (i.e. - the sea) is indefinable making a true calculation of drop down impossible.
- ii.- Occasions when it would not be possible - for operational reasons - for the approach and departure paths to be clear of obstacles - the 'standard' calculation of drop-down could not be applied.

Under these circumstances, practicality indicates that drop-down should be based upon the height of the deck AMSL and the 35 ft clearance should be applied.

There are however, other and more complex issues which will also affect the deck-edge clearance and drop down calculations:

- iii.- When operating to moving decks on vessels, a recommended landing or take-off profile might not be possible because the helicopter might have to hover alongside in order that the rise and fall of the ship is mentally mapped; or, on take-off re-landing in the case of an engine failure might not be an option.

JAR-OPS 3 Subparts F-I | Revised rule text

Under these circumstances, the ~~c~~Commander might adjust the profiles to address a hazard more serious or more likely than that presented by an engine failure.

It is because of these and other (unforeseen) circumstances that a prescriptive requirement is not used. However, the target remains a 15 ft deck-edge clearance and a 35 ft obstacle clearance and data should be provided such that, where practically possible, these clearances can be planned.

As accident/incident history indicates that the main hazard is collision with obstacles on the helideck due to human error, simple and reproducible take-off and landing procedures are recommended.

In view of the reasons stated above, the future requirement for PC1 ~~was~~ replaced by the new requirement that the take-off mass takes into account:

- ~~aa~~**A.** the procedure;
- ~~bb~~**B.** deck-edge miss; and
- ~~cc~~**C.** drop down appropriate to the height of the helideck.

This will require calculation of take-off mass from information produced by manufacturers reflecting these elements. It is expected that such information will be produced by performance modelling/simulation using a model validated through limited flight testing.

7.4.3 Operations to ~~h~~Helidecks for ~~h~~Helicopters with an MAPSC of more than 19

The original requirement for operations of helicopters with an MAPSC of more than 19 was PC1 (as set out in ~~CAT.POL.H.100~~JAR-OPS-3.470(~~ba~~)(2)).

However, when operating to helidecks, the problems enumerated in 7.4.2 above are equally applicable to these helicopters. In view of this, but taking into account that increased numbers are (potentially) being carried, such operations are permitted in PC2 (~~CAT.POL.H.100~~JAR-OPS-3.470(~~ba~~)(2)) but, in all helideck environments (both hostile and non-hostile), have to satisfy, the additional requirements, set out in 7.4.2 above.}

{Ch. 1, 01.02.99; Amdt. 5, 01.07.07}

{ }

{Ch. 1, 01.02.99; Amdt. 5, 01.07.07}

{ }

{Amdt. 5, 01.07.07}

{ }

{Amdt. 5, 01.07.07}

~~[ACJAMC1-1 to Appendix 1 to CAT.POL.H.305 JAR-OPS 3-517]~~ **(ba) Helicopter operations without an assured safe forced landing capability**

POWERPLANT RELIABILITY STATISTICS

1. As part of the risk assessment prior to granting an approval under ~~Appendix 1 to CAT.POL.H.305 JAR-OPS 3-517(a)~~, the operator should provide appropriate ~~powerplant engine~~ reliability statistics available for the helicopter type and the engine type.
2. Except in the case of new engines, such data should show sudden power loss from the set of in-flight shutdown (IFSD) events not exceeding 1 per 100 700 engine hours in a 5 year moving window. However, a rate in excess of this value, but not exceeding 3 per 100 700 engine hours, may be accepted by the ~~Authority~~ **competent authority** after an assessment showing an improving trend.
3. New engines should be assessed on a case-by-case basis.
4. After the initial assessment, updated statistics should be periodically reassessed; any adverse sustained trend will require an immediate evaluation to be accomplished by the operator in consultation with the ~~Authority~~ **competent authority** and the manufacturers concerned. The evaluation may result in corrective action or operational restrictions being applied.
5. The purpose of this paragraph is to provide guidance on how the in-service power plant sudden power loss rate is determined.
- 5.1. Share of roles between the helicopter and engine ~~tType cCertificate hHolders~~ (TCH):
 - a) The provision of documents establishing the in-service sudden power loss rate for the helicopter/engine installation; the interface with the operational ~~aAuthority~~ of the State of ~~dDesign~~ should be the ~~eEngine~~ TCH or the ~~hHelicopter~~ TCH depending on the way they share the corresponding analysis work.
 - b) The ~~eEngine~~ TCH should provide the ~~hHelicopter~~ TCH with a document including: the list of in-service power loss events, the applicability factor for each event (if used), and the assumptions made on the efficiency of any corrective actions implemented (if used).÷
 - c) The ~~eEngine~~ or ~~hHelicopter~~ TCH should provide the operational Authority of the State of ~~dDesign~~ or, where this ~~aAuthority~~ does not take responsibility, the operational ~~aAuthority~~ of the State of the ~~oOperator~~, with a document that details the calculation results - taking into account:
 - i. the events caused by the engine and the events caused by the engine installation;
 - ii. the applicability factor for each event (if used), the assumptions made on the efficiency of any corrective actions implemented on the engine and on the helicopter (if used); and
 - iii. the calculation of the powerplant power loss rate.÷

JAR-OPS 3 Subparts F-I | Revised rule text

5.2 Documentation

The following documentation should be updated every year.

5.2.1 The document with detailed methodology and calculation as distributed to the ~~a~~Authority of the State of ~~d~~Design.

5.2.2 A summary document with results of computation as made available on request to any operational ~~a~~Authority.

5.2.3 A ~~s~~Service ~~l~~etter establishing the eligibility for such operation and defining the corresponding required configuration as provided to the operators.

5.3- Definition of the "sudden in-service power loss"-

The sudden in-service power loss is an engine power loss:

- ~~a.~~ larger than 30 % of the take-off power; ~~and~~
- ~~b.-~~ occurring during operation; and
- ~~c.-~~ without the occurrence of an early intelligible warning to inform and give sufficient time for the pilot to take any appropriate action.

5.4- Data-base documentation.

Each power loss event should be documented, by the engine and/or helicopter TCH's, as follows:

- incident report number;
- engine type;
- engine serial number;
- helicopter serial number;
- date;
- event type (demanded IFSD, un-demanded IFSD);
- presumed cause;
- applicability factor when used ; ~~and~~
- reference and assumed efficiency of the corrective actions that will have to be applied (if any).-†

5.5- Counting methodology.

Various methodologies for counting engine power loss rate have been accepted by ~~a~~Authorities. The following is an example of one of these methodologies:

5.5.1 The events resulting from:

- ~~a.-~~ unknown causes (wreckage not found or totally destroyed, undocumented or unproven statements); ~~or~~
- ~~b.-~~ where the engine or the elements of the engine installation have not been investigated (for example when the engine has not been returned by the customer); or
- ~~c.-~~ an unsuitable or non--representative use (operation or maintenance) of the helicopter or the engine,-†

are not counted as engine in-service sudden power loss and the applicability factor is 0 %.

JAR-OPS 3 Subparts F-I | Revised rule text

5.5.2 The events caused by:

- a.- the engine or the engine installation; or
- b.- —the engine or helicopter maintenance, when the applied maintenance was compliant with the ~~m~~Maintenance ~~m~~Manuals;

are counted as engine in-service sudden power loss and the applicability factor is 100 %.

5.5.3 For the events where the engine or an element of the engine installation has been submitted to investigation which did not allow to define a presumed cause the applicability factor is 50 %.

5.6. Efficiency of corrective actions.

The corrective actions made by the engine and helicopter manufacturers on the definition or maintenance of the engine or its installation could be defined as mandatory for specific ~~JAR-OPS-3~~ operations. In this case the associated reliability improvement could be considered as mitigating factor for the event.

A factor defining the efficiency of the corrective action could be applied to the applicability factor of the concerned event.

5.7. Method of calculation of the powerplant power loss rate-

The detailed method of calculation of the powerplant power loss rate should be documented by engine or helicopter TCH and accepted by the relevant ~~a~~Authority.}

{Amdt. 5, 01.07.07}

~~[ACJAMC-2 to Appendix 1 to CAT.POL.H.305]~~ **JAR-OPS 3.517(ba) Helicopter operations without an assured safe forced landing capability**

IMPLEMENTATION OF THE SET OF CONDITIONS

To obtain an approval under ~~Appendix 1 to CAT.POL.H.305]~~ ~~JAR-OPS 3.517(a)~~, ~~an~~ ~~the~~ operator conducting operations without an assured safe forced landing capability should implement the following:

1. Attain and then maintain the helicopter/engine modification standard defined by the manufacturer that has been designated to enhance reliability during the take-off and landing phases.
2. Conduct the preventive maintenance actions recommended by the helicopter or engine manufacturer as follows:
 - 2.1 ~~e~~Engine oil spectrometric and debris analysis - as appropriate;
 - 2.2 ~~e~~Engine trend monitoring, based on available power assurance checks;
 - 2.3 ~~e~~Engine vibration analysis (plus any other vibration monitoring systems where fitted); ~~and-~~
 - 2.4 ~~o~~Oil consumption monitoring.
3. The ~~u~~Usage ~~m~~Monitoring ~~System~~ ~~system~~ should fulfil at least the following:
 - 3.1 Recording of the following data:
 - ~~d~~Date and time of recording, or a reliable means of establishing these parameters;

JAR-OPS 3 Subparts F-I | Revised rule text

- ~~a~~Amount of flight hours recorded during the day plus total flight time;
 - N₁ (gas producer RPM) cycle count;
 - N₂ (power turbine RPM) cycle count (if the engine features a free turbine);
 - ~~t~~Turbine temperature exceedance: value, duration;
 - ~~p~~Power-shaft torque exceedance: value, duration (if a torque sensor is fitted);
 - ~~e~~Engine shafts speed exceedance: value, duration.†
- 3.2 Data storage of the above parameters, if applicable, covering the maximum flight time in a day, and not less than 5 flight hours, with an appropriate sampling interval for each parameter.
- 3.3 The system should include a comprehensive self-test function with a malfunction indicator and a detection of power-off or sensor input disconnection.
- 3.4 A means should be available for downloading and analysis of the recorded parameters. Frequency of downloading should be sufficient to ensure data is not lost through over-writing.
- 3.5 The analysis of parameters gathered by the usage monitoring system, the frequency of such analysis and subsequent maintenance actions should be described in the maintenance documentation.
- 3.6 The data should be stored in an acceptable form and accessible to the ~~Authority~~**competent authority**, for at least 24 months.
- ~~4. Include take off and landing procedures in the operations manual, where they do not already exist in the Helicopter Flight Manual.~~
- ~~45. The~~**Establish** training for flight crew ~~which~~ should include the discussion, demonstration, use and practice of the techniques necessary to minimize the risks.†
- 56.** Report to the manufacturer any loss of power control, engine shutdown (precautionary or otherwise) or ~~enginepower unit~~ failure for any cause (excluding simulation of ~~enginepower unit~~ failure during training). The content of each report should provide:
- ~~d~~**D**ate and time;
 - ~~o~~**O**perator (and ~~m~~**M**aintenance organisations where relevant);
 - ~~t~~**T**ype of helicopter and description of operations;
 - ~~r~~**R**egistration and serial number of airframe;
 - ~~e~~**E**ngine type and serial number;
 - ~~p~~**P**ower unit- modification standard where relevant to failure;
 - ~~e~~**E**ngine position;
 - ~~s~~**S**ymptoms leading up to the event;-
 - ~~c~~**C**ircumstances of ~~enginepower unit~~ failure including phase of flight or ground operation;
 - ~~c~~**C**onsequences of the event;
 - ~~w~~**W**eather/environmental conditions;
 - ~~r~~**R**eason for ~~enginepower unit~~ failure – if known;

JAR-OPS 3 Subparts F-I | Revised rule text

- ~~i~~n case of an ~~i~~n ~~f~~light ~~s~~hutdown (IFSD), nature of the IFSD (~~d~~emanded/~~u~~n-demanded);
- ~~p~~rocedure applied and any comment regarding engine restart potential;
- ~~e~~ngine hours and cycles (from new and last overhaul);
- ~~a~~irframe flight hours;
- ~~r~~ectification actions applied including, if any, component changes with part number and serial number of the removed equipments; and
- ~~a~~ny other relevant information. ~~]~~

~~[Amdt. 5, 01.07.07]~~

GM1-CAT.POL.H.305(b) Helicopter operations without an assured safe forced landing capability

USE OF FULL AUTHORITY DIGITAL ENGINE CONTROL (FADEC)

Current technology increasingly allows for the recording function required in CAT.POL.H.305(b) 3.1 to be incorporated in the ~~f~~Full ~~a~~Authority ~~d~~Digital ~~e~~Engine ~~c~~ontrol (FADEC).

Where a FADEC is capable of recording some of the parameters required by paragraph 3.1 it is not intended that the recording of the ~~s~~parameters is to be duplicated.

Providing that the functions of paragraph 3 are satisfied, the FADEC may partially, or in whole, fulfill the requirement for recording and storing parameters in a usage monitoring system.

~~[ACJ OPS 3.520]~~ **GM1-CAT.POL.H.310(ca)(3) & ~~and~~ CAT.POL.H.3253-535(ca)(3) Take-off and Landing**

~~PROCEDURE FOR CONTINUED OPERATIONS TO HELIDECKS~~ **PROCEDURE FOR CONTINUED OPERATIONS TO HELIDECKS**

See JAR-OPS ~~[3.520(a)(3) and 3.535(a)(3)]~~

- 1 Factors to be considered when taking off from or landing on a helideck
 - 1.1 In order to take account of the considerable number of variables associated with the helideck environment, each take-off and landing may require a slightly different profile. Factors such as helicopter mass and centre of gravity, wind velocity, turbulence, deck size, deck elevation and orientation, obstructions, power margins, platform gas turbine exhaust plumes etc., will influence both the take-off and landing. In particular, for the landing, additional considerations such as the need for a clear go-around flight path, visibility and cloud base etc., will affect the Commander's decision on the choice of landing profile. Profiles may be modified, taking account of the relevant factors noted above and the characteristics of individual helicopter types.

JAR-OPS 3 Subparts F-I | Revised rule text

~~2 Terminology~~~~2.1 See JAR-OPS 3.480 as appropriate.~~**32 Performance**

23.1 To perform the following take-off and landing profiles, adequate all-engines-operating (AEO) hover performance at the helideck is required. In order to provide a minimum level of performance, data (derived from the ~~Flight Manual~~ **AFM** AEO out of ground effect (OGE), ~~with wind accountability~~) should be used to provide the maximum take-off or landing mass. Where a helideck is affected by downdrafts or turbulence or hot gases, or where the take-off or landing profile is obstructed, or the approach or take-off cannot be made into wind, it may be necessary to decrease this take-off or landing mass by using a suitable calculation method ~~recommended by the manufacturer~~. The helicopter mass should not exceed that required by **CAT.POL.H.310**~~JAR-OPS 3.520 (a)(1)~~ or **CAT.POL.H.325**~~JAR-OPS 3.535(a)(1)~~.

~~(Note 1: For helicopter types no longer supported by the manufacturer, data may be established by the operator, provided they are acceptable to the Authority.)~~
competent authority.)

34 Take-off profile

34.1 The take-off should be performed in a dynamic manner ensuring that the helicopter continuously moves vertically from the hover to the ~~r~~Rotation ~~p~~Point (RP) and thence into forward flight. If the manoeuvre is too dynamic then there is an increased risk of losing spatial awareness (through loss of visual cues) in the event of a rejected take-off, particularly at night.

34.2 If the transition to forward flight is too slow, the helicopter is exposed to an increased risk of contacting the deck edge in the event of an engine failure at or just after the point of cyclic input (RP).

34.3 It has been found that the climb to RP is best made between 110 % and 120 % of the power required in the hover. This power offers a rate of climb which assists with deck-edge clearance following ~~engine~~**power unit** failure at RP, whilst minimising ballooning following a failure before RP. Individual types will require selection of different values within this range.

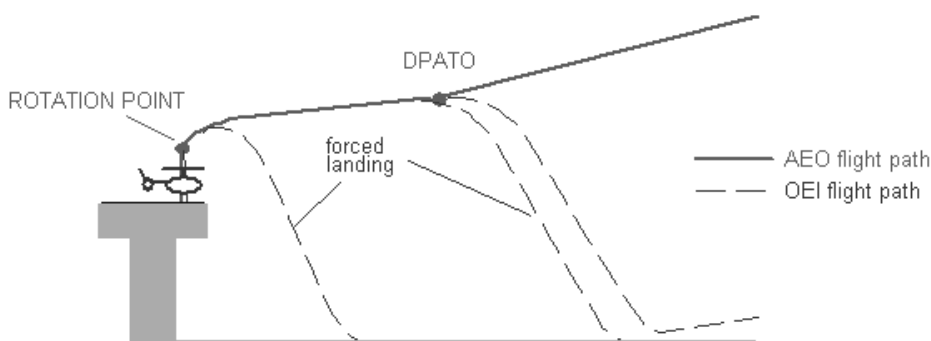

]

45 Selection of a lateral visual cue

45.1 In order to obtain the maximum performance in the event of an engine failure being recognised at or just after RP, the RP must be at its optimum value, consistent with maintaining the necessary visual cues. If an engine failure is recognised just before

JAR-OPS 3 Subparts F-I | Revised rule text

RP, the helicopter, if operating at a low mass, may 'balloon' a significant height before the reject action has any effect. It is, therefore, important that the pilot flying selects a lateral visual marker and maintains it until the RP is achieved, particularly on decks with few visual cues. In the event of a rejected take-off, the lateral marker will be a vital visual cue in assisting the pilot to carry out a successful landing.

56 Selection of the rotation point

56.1 The optimum RP should be selected to ensure that the take-off path will continue upwards and away from the deck with ~~All Engines Operating (AEO)~~, but minimising the possibility of hitting the deck edge due to the height loss in the event of an engine failure at or just after RP.

56.2 The optimum RP may vary from type to type. Lowering the RP will result in a reduced deck edge clearance in the event of an engine failure being recognised at or just after RP. Raising the RP will result in possible loss of visual cues, or a hard landing in the event of an engine failure just prior to RP.

67 Pilot reaction times

67.1 Pilot reaction time is an important factor affecting deck edge clearance in the event of an engine failure prior to or at RP. Simulation has shown that a delay of one second can result in a loss of up to 15 ft in deck edge clearance.

78 Variation of wind speed

78.1 Relative wind is an important parameter in the achieved take-off path following an engine failure; wherever practicable, take-off should be made into wind. Simulation has shown that a 10 knot wind can give an extra 5 ft deck edge clearance compared to a zero wind condition.

89 Position of the helicopter relative to the deck edge

89.1 It is important to position the helicopter as close to the deck edge (including safety nets) as possible whilst maintaining sufficient visual cues, particularly a lateral marker.

89.2 The ideal position is normally achieved when the rotor tips are positioned at the forward deck edge. This position minimises the risk of striking the deck edge following recognition of an engine failure at or just after RP. Any take-off heading which causes the helicopter to fly over obstructions below and beyond the deck edge should be avoided if possible. Therefore, the final take-off heading and position will be a compromise between the take-off path for least obstructions, relative wind, turbulence and lateral marker cue considerations.

910 Actions in the event of an engine failure at or just after RP

109.1 Once committed to the continued take-off, it is important, in the event of an engine failure, to rotate the aircraft to the optimum attitude in order to give the best chance of missing the deck edge. The optimum pitch rates and absolute pitch attitudes, should be detailed in the profile for the specific type.

101 Take-off from helidecks which have significant movement

101.1 This technique should be used when the helideck movement and any other factors, e.g. insufficient visual cues, makes a successful rejected take-off unlikely. Weight should be reduced to permit an improved one engine inoperative capability, as necessary.

110.2 The optimum take-off moment is when the helideck is level and at its highest point, e.g. horizontal on top of the swell. Collective pitch should be applied

JAR-OPS 3 Subparts F-I | Revised rule text

positively and sufficiently to make an immediate transition to climbing forward flight. Because of the lack of a hover, the take-off profile should be planned and briefed prior to lift off from the deck.

112 Standard landing profile

112.1 The approach should be commenced into wind to a point outboard of the helideck. Rotor tip clearance from the helideck edge should be maintained until the aircraft approaches this position at the requisite height (type dependent) with approximately 10 kts of ground-speed and a minimal rate of descent. The aircraft is then flown on a flight path to pass over the deck edge and into a hover over the safe landing area.

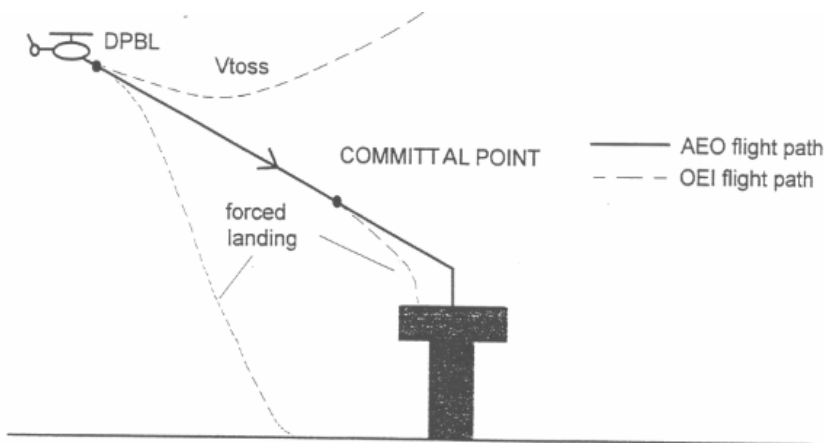

123 Offset landing profile

123.1 If the normal landing profile is impracticable due to obstructions and the prevailing wind velocity, the offset procedure may be used. This should involve flying to a hover position, approximately 90° offset from the landing point, at the appropriate height and maintaining rotor tip clearance from the deck edge. The helicopter should then be flown slowly but positively sideways and down to position in a low hover over the landing point. Normally, CP will be the point at which helicopter begins to transition over the helideck edge.

134 Training

134.1 These techniques should be covered in the training required by ~~JAR-OPS 3, Subpart N~~ **Part-60R**.

[Amdt. 2, 01.01.02; Amdt. 5, 01.07.07]

[]

[Ch. 1, 01.02.99; Amdt. 5, 01.07.07]

[]

[Ch. 1, 01.02.99; Amdt. 5, 01.07.07]

~~HEMGM1-CAT.POL.H.310& and OPS 3.520 & 3.535~~ CAT.POL.H.325 Take-off and Landing

TAKE-OFF AND LANDING TECHNIQUES

See JAR-OPS 3.520 and JAR-OPS 3.535

- 1 This ~~HEMGM~~ describes three types of operation to/from helidecks and elevated heliports ~~FATOs~~ by helicopters operating in ~~pPerformance~~ ~~cClass 2~~.
- 2 In two cases of take-off and landing, exposure time is used. During the exposure time (which is only approved for use when complying with ~~CAT.POL.H.305~~ ~~JAR-OPS 3.517(a)~~) the probability of an ~~engine-power unit~~ failure is regarded as extremely remote. If an ~~power unit failure~~ (engine failure) occurs during the exposure time a safe-forced-landing may not be possible.
- 3 Take-off - ~~nNon-hHostile~~ ~~eEnvironment~~ (without an approval to operate with an exposure time) ~~CAT.POL.H.310~~ ~~JAR-OPS 3.520(ba)(2)~~.
- 3.1 Figure 1 shows a typical take-off profile for ~~pPerformance~~ ~~cClass 2~~ operations from a helideck or an elevated ~~FATO~~ heliport in a non-hostile environment.
- 3.2 If an engine failure occurs during the climb to the rotation point, compliance with ~~CAT.POL.H.310~~ ~~3.520(ba)(2)~~ will enable a safe landing or a safe -forced -landing on the deck.
- 3.3 If an engine failure occurs between the rotation point and the DPATO, compliance with ~~CAT.POL.H.3.520~~ ~~310(ba)(2)~~ will enable a safe-forced-landing on the surface, clearing the deck edge.
- 3.4 At or after the DPATO, the OEI flight path should clear all obstacles by the margins specified in ~~CAT.POL.H.315~~ ~~JAR-OPS 3.525~~.

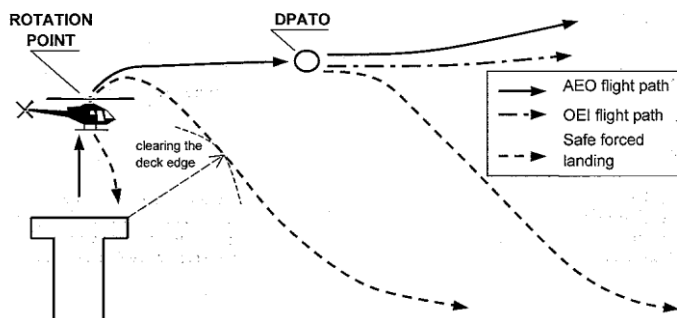

Figure 1

- 4 Take-off - ~~nNon-hHostile~~ ~~eEnvironment~~ (with exposure time) ~~CAT.POL.H.310~~ ~~JAR-OPS 3.520(ca)(3)~~
- 4.1 Figure 2 shows a typical take-off profile for ~~pPerformance~~ ~~cClass 2~~ operations from a helideck or an elevated ~~FATO~~ heliport in a non-hostile environment (with exposure time).
- 4.2 If an engine failure occurs after the exposure time and before DPATO, compliance with ~~3.520~~ ~~CAT.POL.H.310~~ ~~(ca)(3)~~ will enable a safe-forced-landing on the surface.
- 4.3 At or after the DPATO, the OEI flight path should clear all obstacles by the margins specified in ~~CAT.POL.H.315~~ ~~JAR-OPS 3.525~~.

JAR-OPS 3 Subparts F-I | Revised rule text

[Note: an engine failure outside of exposure time should result in a safe forced landing or safe continuation of the flight.]

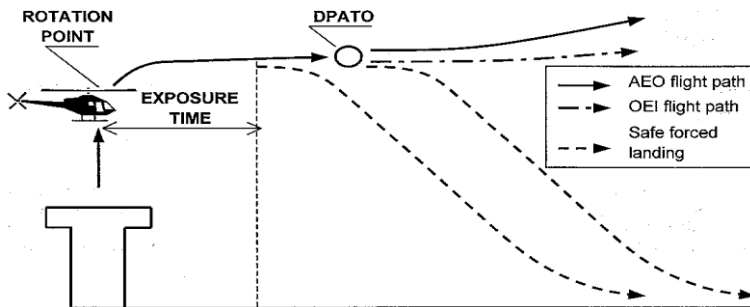

Figure 2

5 Take-off - ~~n~~Non-congested ~~h~~Hostile ~~e~~Environment (with exposure time) **CAT.POL.H.315** ~~JAR-OPS 3.520 (ca) (3)~~

5.1 Figure 3 shows a typical take off profile for ~~p~~Performance ~~c~~Class 2 operations from a helideck or an elevated ~~FATO~~heliport in a non-congested hostile environment (with exposure time).

5.2 If an engine failure occurs after the exposure time the helicopter is capable of a **safe-forced-landing or safe continuation of the flight.** ~~continuing the flight.~~

5.3 At or after the DPATO, the OEI flight path should clear all obstacles by the margins specified in **CAT.POL.H.315** ~~JAR-OPS 3.525~~.

[Note: an engine failure outside of exposure time should result in a safe forced landing or safe continuation of the flight.]

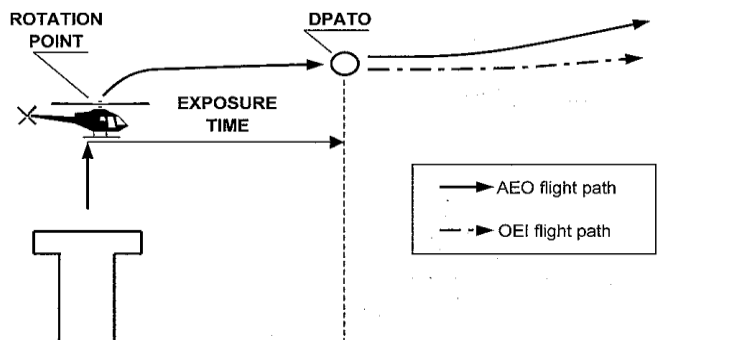

Figure 3

6. Landing - ~~n~~Non-~~h~~Hostile ~~e~~Environment (without an approval to operate with an exposure time) **CAT.POL.H.325** ~~JAR-OPS 3.535 (a) (b2)~~

6.1 Figure 4 shows a typical landing profile for ~~p~~Performance ~~c~~Class 2 operations to a helideck or an elevated ~~FATO~~heliport in a non-hostile environment.

6.2 The DPBL is defined as a "window" in terms of airspeed, rate of descent, and height above the landing surface. If an engine failure occurs before the DPBL, the pilot may elect to land or to execute a balked landing.

JAR-OPS 3 Subparts F-I | Revised rule text

- 6.3 In the event of an engine failure being recognised after the DPBL and before the committal point, compliance with ~~3.535~~**CAT.POL.H.325 (a)(b2)** will enable a safe-forced-landing on the surface.
- 6.4 In the event of an engine failure at or after the committal point, compliance with ~~3.535~~**CAT.POL.H.325 (ba)(2)** will enable a safe-forced-landing on the deck.

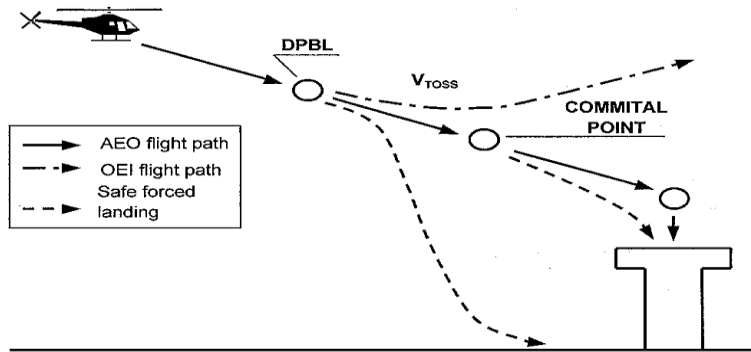

Figure 4

- 7 Landing - ~~nNon-h~~**Non-Hostile eEnvironment** (with exposure time) ~~CAT.POL.H.325~~**CAT.POL.H.325**
~~OPS 3.535 (ca)(3)~~
- 7.1 Figure 5 shows a typical landing profile for ~~pPerformance~~**Performance cClass 2** operations to a helideck or an elevated ~~helipad~~**helipad-FATO** in a non-hostile environment (with exposure time).
- 7.2 The DPBL is defined as a "window" in terms of airspeed, rate of descent, and height above the landing surface. If an engine failure occurs before the DPBL, the pilot may elect to land or to execute a bailed landing.
- 7.3 In the event of an engine failure being recognised before the exposure time compliance with ~~3.535~~**CAT.POL.H.325 (ca)(3)** will enable a safe-forced-landing on the surface.
- 7.4 In the event of an engine failure after the exposure time, compliance with ~~3.535~~**CAT.POL.H.325 (ca)(3)** will enable a safe-forced-landing on the deck.

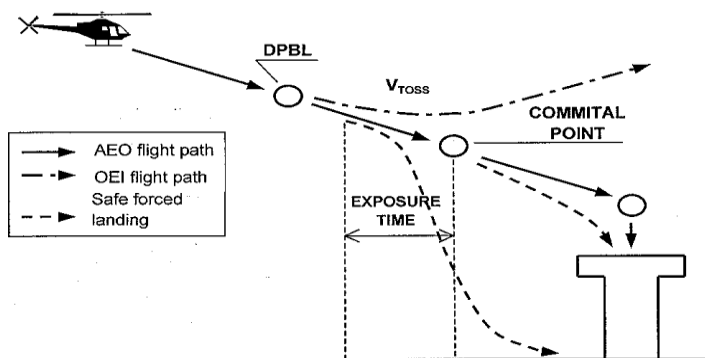

Figure 5

JAR-OPS 3 Subparts F-I | Revised rule text

8. Landing - ~~nNon-c~~**Non-c**ongested ~~h~~**Hostile** ~~e~~**Environment** (with exposure time)
CAT.POL.H.325 ~~30~~**JAR-OPS-3.535**(~~ca~~)(~~3~~)
- 8.1 Figure 6 shows a typical landing profile for ~~p~~**Performance** ~~c~~**Class 2** operations to a helideck or an elevated heliport ~~FATO~~ in a non-congested hostile environment (with exposure time).
- 8.2 In the event of an engine failure at any point during the approach and landing phase up to the start of exposure time, compliance with **CAT.POL.H.325** ~~JAR-OPS-3.535~~(~~ba~~)(4) will enable the helicopter, after clearing all obstacles under the flight path, to continue the flight.
- 8.3 In the event of an engine failure after the exposure time (**i.e. at or after the committal point**), ~~compliance with 3.535(a)(4)~~ will enable a safe-forced-landing **should be possible** on the deck.

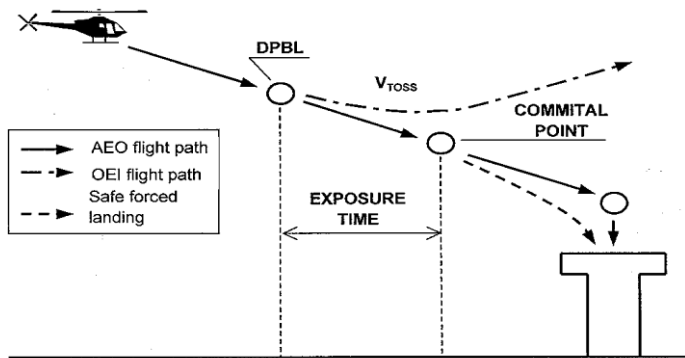

Figure 6

[Ch. 1, 01.02.99]

[]

[Amdt. 2, 01.01.02; Amdt. 5, 01.07.07]

JAR-OPS Subpart K-L | Revised rule text

Scope

This document shows the transposition of JAR-OPS Subparts K-L into the new European OPS rules.

It also contains the related Section 2 material of JAR-OPS 3.

Track changes show changes to the JAR-OPS 3 text.

JAR-OPS Subpart K-L | Revised rule text

Table of Contents

Subpart D – Instrument, data, equipment	9
Section 2 - Helicopters.....	9
CAT.IDE.H.100 Instruments and equipment – General.....	9
CAT.IDE.H.105 Minimum equipment for flight.....	10
CAT.IDE.H.110 Spare electrical fuses	10
CAT.IDE.H.115 Operating lights.....	10
CAT.IDE.H.125 Day VFR operations – flight and navigational instruments and associated equipment	11
CAT.IDE.H.130 IFR or night operations – flight and navigational instruments and associated equipment	12
CAT.IDE.H.135 Additional equipment for single pilot operation under IFR	15
CAT.IDE.H.145 Radio Altimeters	15
CAT.IDE.H.160 Airborne weather detecting equipment	16
CAT.IDE.H.165 Additional equipment for operations in icing conditions at night	16
CAT.IDE.H.170 Flight crew interphone system	16
CAT.IDE.H.175 Crew member interphone system.....	16
CAT.IDE.H.180 Public address system	17
CAT.IDE.H.185 Cockpit voice recorder	17
CAT.IDE.H.190 Flight data recorder.....	20
CAT.IDE.H.195 Data link recording.....	22
CAT.IDE.H.200 Flight data and cockpit voice combination recorder	23
CAT.IDE.H.205 Seats, seat safety belts, harnesses and child restraint devices.....	23
CAT.IDE.H.210 Fasten seat belt and no smoking signs	24
CAT.IDE.H.220 First-aid kits.....	24
CAT.IDE.H.240 Supplemental oxygen- non-pressurised helicopters	24
CAT.IDE.H.250 Hand fire extinguishers.....	25
CAT.IDE.H.260 Marking of break-in points	26
CAT.IDE.H.270 Megaphones.....	27
CAT.IDE.H.275 Emergency lighting and marking.....	27
CAT.IDE.H.280 Emergency locator transmitter (ELT)	28
CAT.IDE.H.290 Life-jackets	28
CAT.IDE.H.295 Crew survival suits.....	29

JAR-OPS Subpart K-L | Revised rule text

CAT.IDE.H.300 Life-rafts, ELT(S)and survival equipment on extended overwater flights.....	29
CAT.IDE.H.305 Survival equipment	30
CAT.IDE.H.310 Additional requirements for helicopters conducting offshore operations in a hostile sea area	30
CAT.IDE.H.315 Helicopters certificated for operating on water - miscellaneous equipment.....	31
CAT.IDE.H.320 All helicopters on flights over water - ditching	31
Subpart D – Instrument, Data, Equipment.....	37
Section 2 - Helicopters.....	37
GM1-CAT.IDE.H.100(a) Instruments and equipment – General.....	37
APPROVED EQUIPMENT	37
GM1-CAT.IDE.H.100(c) Instruments and equipment – General	37
INSTRUMENTS AND EQUIPMENT THAT DO NOT NEED TO BE APPROVED IN ACCORDANCE WITH REGULATION (EC) NO 1702/2003, BUT ARE CARRIED ON A FLIGHT.....	37
GM1-CAT.IDE.H.100(e) Instruments and equipment - General	38
POSITIONING OF INSTRUMENTS	38
GM1-CAT.IDE.H.110 Spare electrical fuses.....	38
FUSES.....	38
AMC1-CAT.IDE.H.115 Operating lights.....	38
LANDING LIGHT	38
AMC1-CAT.IDE.H.125&CAT.IDE.H.130 Day VFR operations – Flight and navigational instruments and associated equipment and	38
INTEGRATED INSTRUMENTS	38
AMC1-CAT.IDE.H.125(a)(1)&CAT.IDE.H.130(a)(1) Day VFR operations and IFR or night operations – Flight and navigational instruments and associated equipment	39
MEANS OF MEASURING AND DISPLAYING MAGNETIC DIRECTION	39
AMC1-CAT.IDE.H.125(a)(2)&CAT.IDE.H.130(a)(2) Day VFR operations and IFR or night operations – Flight and navigational instruments and associated equipment	39
MEANS FOR MEASURING AND DISPLAYING THE TIME.....	39
AMC1-CAT.IDE.H.125(a)(3)&CAT.IDE.H.130(b) Day VFR operations and IFR or night operations – Flight and navigational instruments and associated equipment	39
CALIBRATION OF THE MEANS FOR MEASURING AND DISPLAYING PRESSURE ALTITUDE	39

JAR-OPS Subpart K-L | Revised rule text

AMC-1 CAT.IDE.H.125(a)(4)&CAT.IDE.H.130(a)(3) Day VFR operations and IFR or night operations – Flight and navigational instruments and associated equipment	40
CALIBRATION OF THE INSTRUMENT INDICATING AIRSPEED.....	40
AMC1-CAT.IDE.H.125(b)(1)&CAT.IDE.H.130(c)(1) Day VFR operations and IFR or night operations – Flight and navigational instruments and associated equipment	40
OUTSIDE AIR TEMPERATURE	40
AMC1-CAT.IDE.A.125 (c)&CAT.IDE.A.130 (h) Day VFR operations – Flight and navigational instruments and associated equipment and	40
MULTI-PILOT OPERATIONS - DUPLICATE INSTRUMENTS	40
AMC1-CAT.IDE.H.125(d)(2)&CAT.IDE.H.130(a)(7) Day VFR operations and IFR or night operations – Flight and navigational instruments and associated equipment	40
MEANS OF MEASURING AND DISPLAYING DIRECTION	40
AMC1-CAT.IDE.H.125(e)&CAT.IDE.H.130(d) Day VFR operations and IFR or night operations – Flight and navigational instruments and associated equipment	40
MEANS OF PREVENTING MALFUNCTION DUE TO CONDENSATION OR ICING	41
AMC1-CAT.IDE.H.130(e) IFR or night operations – Flight and navigational instruments and associated equipment	41
MEANS OF INDICATING FAILURE OF THE MEANS OF PREVENTING MALFUNCTION DUE TO EITHER CONDENSATION OR ICING OF THE AIRSPEED INDICATING SYSTEM.....	41
AMC1-CAT.IDE.H.130(f) IFR or night operations – Flight and navigational instruments and associated equipment	41
STANDBY ATTITUDE INDICATOR	41
AMC1-CAT.IDE.H.130(i) IFR or night operations – Flight and navigational instruments and associated equipment	42
CHART HOLDER.....	42
GM1-CAT.IDE.H.125&CAT.IDE.H.130 Day VFR operations and IFR or night operations – Flight and navigational instruments and associated equipment	42
GENERAL.....	42
AMC1-CAT.IDE.H.145 Radio altimeters	43
AUDIO VOICE ALERTING DEVICE.....	43
AMC1-CAT.IDE.H.160 Airborne weather detecting equipment	44
GENERAL.....	44
AMC1-CAT.IDE.H.170 Flight crew interphone system.....	44

JAR-OPS Subpart K-L | Revised rule text

TYPE OF FLIGHT CREW INTERPHONE	44
AMC1-CAT.IDE.H.175 Crew member interphone system	44
CHARACTERISTICS SPECIFICATIONS	44
AMC1-CAT.IDE.A.180 Public address system	44
SPECIFICATIONS.....	44
AMC1-CAT.IDE.H.185 Cockpit voice recorder.....	45
GENERAL.....	45
AMC1-CAT.IDE.H.190 Flight data recorder	45
LIST OF PARAMETERS TO BE RECORDED FOR HELICOPTERS HAVING AN MCTOM OF MORE THAN 3 175 KG AND FIRST ISSUED WITH AN INDIVIDUAL C OF A ON OR AFTER 1 JANUARY 2016	45
AMC2-CAT.IDE.H.190 Flight data recorder	49
LIST OF PARAMETERS TO BE RECORDED FOR HELICOPTERS HAVING AN MCTOM OF MORE THAN 3 175 KG AND FIRST ISSUED WITH AN INDIVIDUAL C OF A ON OR AFTER 1 AUGUST 1999 AND BEFORE 1 JANUARY 2016 AND HELICOPTERS HAVING AN MCTOM OF MORE THAN 7 000 KG OR AN MPSC OF MORE THAN NINE AND FIRST ISSUED WITH AN INDIVIDUAL C OF A ON OR AFTER 1 JANUARY 1989 AND BEFORE 1 AUGUST 1999	49
AMC3-CAT.IDE.H.190 Flight data recorder	54
PERFORMANCE SPECIFICATIONS FOR THE PARAMETERS TO BE RECORDED FOR HELICOPTERS HAVING AN MCTOM OF MORE THAN 3 175 KG AND FIRST ISSUED WITH AN INDIVIDUAL C OF A ON OR AFTER 1 AUGUST 1999 AND BEFORE 1 JANUARY 2016 AND HELICOPTERS HAVING AN MCTOM OF MORE THAN 7 000 KG OR AN MPSC OF MORE THAN NINE AND FIRST ISSUED WITH AN INDIVIDUAL C OF A ON OR AFTER 1 JANUARY 1989 AND BEFORE 1 AUGUST 1999	54
AMC1-CAT.IDE.H.195 Data link recording	67
GENERAL.....	67
GM1-CAT.IDE.H.195 Data link recording	69
GENERAL.....	69
AMC1-CAT.IDE.H.200 Flight data and cockpit voice combination recorder	71
GENERAL.....	71
AMC1-CAT.IDE.H.205 Seats, seat safety belts, harnesses and child restraint devices.....	72
RESTRAIN DEVICES FOR PERSON YOUNGER THAN 24 MONTHS - CHILD RESTRAINT DEVICES (CRD).....	72
AMC2-CAT.IDE.H.205 Seats, seat safety belts, harnesses and child restraint devices	74

JAR-OPS Subpart K-L | Revised rule text

SAFETY HARNESS.....	74
AMC3-CAT.IDE.H.205 Seats, seat safety belts, harnesses and child restraint devices	74
SEATS FOR MINIMUM REQUIRED CABIN CREW SEATS	74
AMC1-CAT.IDE.H.220 First-aid kits.....	75
CONTENT OF FIRST_AID KIT.....	75
AMC2-CAT.IDE.H.220 First-aid kits.....	76
MAINTENANCE OF FIRST AID KITS	76
AMC1-CAT.IDE.H.240 Supplemental oxygen- Non-pressurised helicopters	76
AMOUNT OF SUPPLEMENTAL OXYGEN	76
AMC1-CAT.IDE.H.250 Hand fire extinguishers.....	76
NUMBER, LOCATION AND TYPE	76
AMC1-CAT.IDE.H.260 Marking of break-in points	77
COLOUR AND CORNERS' MARKING	77
AMC1-CAT.IDE.H.270 Megaphones.....	77
LOCATION OF MEGAPHONES.....	77
AMC1-CAT.IDE.H.280 Emergency locator transmitter (ELT)	78
ELT BATTERIES	78
AMC2-CAT.IDE.H.280 Emergency locator transmitter (ELT)	78
TYPES OF ELT AND GENERAL TECHNICAL SPECIFICATIONS	78
AMC3-CAT.IDE.H.280 Emergency locator transmitter (ELT)	79
ELT(S) - HELICOPTERS.....	79
GM1-CAT.IDE.H.280 Emergency locator transmitter (ELT)	79
TERMINOLOGY	79
AMC1-CAT.IDE.H.290 (a) Life-jackets.....	79
ACCESSIBILITY	79
AMC2-CAT.IDE.H.290 (c) Life-jackets	79
ELECTRIC ILLUMINATION	79
THE MEANS OF ELECTRIC ILLUMINATION SHOULD BE A SURVIVOR LOCATOR LIGHT.....	79
GM1-CAT.IDE.H.290 Life-jackets.....	79
LIFE JACKETS - ALL AIRCRAFT SEAT CUSHIONS.....	79
SEAT CUSHIONS ARE NOT CONSIDERED TO BE FLOTATION DEVICES.....	79
GM1-CAT.IDE.H.295 Crew survival suits	79
ESTIMATING SURVIVAL TIME.....	79

JAR-OPS Subpart K-L | Revised rule text

AMC1-CAT.IDE.H.300 Life-rafts, ELT(S) and survival equipment on extended overwater flights	81
LIFE-RAFTS AND EQUIPMENT FOR MAKING DISTRESS SIGNALS - HELICOPTERS	81
AMC1-CAT.IDE.H.305 Survival equipment	83
ADDITIONAL SURVIVAL EQUIPMENT	83
GM1-CAT.IDE.H.305 Survival equipment	83
SIGNALLING EQUIPMENT	83
GM2-CAT.IDE.H.305 Survival equipment	83
AREAS IN WHICH SEARCH AND RESCUE WOULD BE ESPECIALLY DIFFICULT'	83
AMC1-CAT.IDE.H.310 Additional requirements for helicopters operating to or from helidecks located in a hostile sea area	84
INSTALLATION OF THE LIFE RAFT	84
GM1-CAT.IDE.H.315 Helicopters certificated for operating on water - Miscellaneous equipment	84
INTERNATIONAL REGULATIONS FOR PREVENTING COLLISIONS AT SEA	84
AMC1-CAT.IDE.H.325 Headset.....	84
GENERAL.....	84
GM1-CAT.IDE.H.325 Headset	85
GENERAL.....	85
AMC1-CAT.IDE.H.345 Communication and navigation equipment for operations under IFR, or under VFR over routes not navigated by reference to visual landmarks.....	85
TWO INDEPENDENT MEANS OF COMMUNICATION	85
AMC2-CAT.IDE.H.345 Communication and navigation equipment for operations under IFR, or under VFR over routes not navigated by reference to visual landmarks.....	85
ACCEPTABLE NUMBER AND TYPE OF COMMUNICATION AND NAVIGATION EQUIPMENT	85
AMC3-CAT.IDE.H.345 Communication and navigation equipment for operations under IFR, or under VFR over routes not navigated by reference to visual landmarks.....	86
FAILURE OF A SINGLE UNIT	86
GM1-CAT.IDE.H.345 Communication and navigation equipment for operations under IFR, or under VFR over routes not navigated by reference to visual landmarks.....	86
APPLICABLE AIRSPACE REQUIREMENTS	86
AMC1-CAT.IDE.H.350 Transponder	86

JAR-OPS Subpart K-L | Revised rule text

SSR TRANSPONDER..... 86

JAR-OPS Subpart K-L | Revised rule text

Subpart D – Instrument, data, equipment

Section 2 - Helicopters

~~SUBPART K – INSTRUMENTS AND EQUIPMENT~~

CAT.IDE.H.100 Instruments and equipment – General~~JAR OPS 3.630 General introduction~~

~~(See IEM OPS 3.630)~~

(a) Equipment and instruments required by this Part shall be approved in accordance with Part-21, with the exception of the following:

~~(a) An operator shall ensure that a flight does not commence unless the instruments and equipment required under this Subpart are:~~

~~(1) Approved, except as specified in sub paragraph (c), and installed in accordance with the requirements applicable to them, including the minimum performance standard and the operational and airworthiness requirements; and~~

~~(2) In operable condition for the kind of operation being conducted except as provided in the MEL (JAR OPS 3.030 refers).~~

~~(b) Instruments and equipment minimum performance standards are those prescribed in the applicable Joint Technical Standard Orders (JTSO) as listed in JAR TSO, unless different performance standards are prescribed in the operational or airworthiness codes. Instruments and equipment complying with design and performance specifications other than JTSO on the date of JAR OPS implementation may remain in service, or be installed, unless additional requirements are prescribed in this Subpart. Instruments and equipment that have already been approved do not need to comply with a revised JTSO or a revised specification, other than JTSO, unless a retroactive requirement is prescribed.~~

~~(c) The following items shall not be required to have an equipment approval:~~

~~(1) spare fuses;~~

~~(2) eElectric torches referred to in JAR OPS 3.640(a)(4);~~

~~(32) aAn accurate time piece referred to in JAR OPS 3.650(b) & 3.652(b);~~

~~(43) cChart holder referred to in JAR OPS 3.652(n).~~

~~(45) fFirst-aid kits referred to in JAR OPS 3.745;~~

~~(56) mMegaphones referred to in JAR OPS 3.810;~~

~~(76) sSurvival and pyrotechnic signalling equipment referred to in JAR OPS 3.835(a) and (c); and~~

~~(87) sSea anchors and equipment for mooring, anchoring or manoeuvring amphibians on water referred to in JAR OPS 3.840.; and~~

~~(9) cChild restraint devices.~~

JAR-OPS Subpart K-L | Revised rule text

(b) Instruments and equipment not required by this Part that do not need to be approved in accordance with Regulation (EC) No 1702/2003 but are carried on a flight, shall comply with the following:

(1) The information provided by these instruments, equipment or accessories shall not be used by the flight crew to comply with Annex 1 to Regulation (EC) No 216/2008 or CAT.IDE.H.330, CAT.IDE.H.335, CAT.IDE.H.340 and CAT.IDE.H.345.

(2) The instruments and equipment shall not affect the airworthiness of the helicopter, even in the case of failures or malfunction.

(dc) If equipment is to be used by one flight crew member at his/her station during flight, it must be readily operable from his-that station. When a single item of equipment is required to be operated by more than one flight crew member it must be installed so that the equipment is readily operable from any station at which the equipment is required to be operated.

(ed) Those instruments that are used by any one-flight crew member shall be so arranged as to permit the flight crew member to see the indications readily from his/her station, with the minimum practicable deviation from the position and line of vision which-that he/she normally assumes when looking forward along the flight path. Whenever a single instrument is required in a helicopter operated by more than 1 flight crew member it must be installed so that the instrument is visible from each applicable flight crew station.

(e) All required emergency equipment shall be easily accessible for immediate use.

Comment [GC11]: New rule paragraph to avoid unsafe use in flight of non-approved instrument, data or equipment.

Comment [DDE2]: Moved to GM CAT.IDE.H.100(e)

Comment [GC13]: New rule to incorporate JAR OPS 3.030 (b).

CAT.IDE.H.105 Minimum equipment for flight

(a) A flight shall not be commenced when any of the helicopter instruments, items of equipment or functions required by this Part are inoperative, unless:

(1) the helicopter is operated in accordance with the operator minimum equipment list (MEL); or

(2) the helicopter is approved by the competent authority to be operated within the constraints of the master minimum equipment list (MMEL).

CAT.IDE.H.110 Spare electrical fuses

JAR-OPS 3.635 Intentionally blank

Helicopters shall be equipped with spare electrical fuses, of the ratings required for complete circuit protection, for replacement of those fuses that can be replaced in flight.

JAR-OPS 3.640 HelicopterCAT.IDE.H.115e Operating lights

(a) Helicopters operated by day under visual flight rules (VFR) shall be An operator shall not operate a helicopter unless it is equipped with

(a) For flight by day under VFR:

JAR-OPS Subpart K-L | Revised rule text

~~(1) an~~ anti-collision light system.;

~~÷(b)~~ **Helicopters operated by night or under instrument flight rules (IFR) shall in addition be equipped with:** ~~For flight under IFR or by night, in addition to equipment specified in subparagraph (a) above:~~

- ~~(1)~~ Lighting supplied from the helicopter's electrical system to provide adequate illumination for all instruments and equipment essential to the safe operation of the helicopter; ~~and~~
- ~~(2)~~ Lighting supplied from the helicopter's electrical system to provide illumination in all passenger compartments; ~~and~~
- ~~(3)~~ ~~a~~ An electric torch for each required crew member readily accessible to crew members when seated at their designated station; ~~and~~
- ~~(4)~~ ~~n~~ Navigation/position lights; ~~and~~
- ~~(5)~~ two landing lights of which at least one is adjustable in flight so as to illuminate the ground in front of and below the helicopter and the ground on either side of the helicopter; and
- ~~(6)~~ Lights to conform with the International ~~R~~egulations for ~~P~~reventing ~~C~~ollisions at ~~S~~ea if the helicopter is amphibious.

JAR-OPS 3.645 Intentionally blank**JAR-OPS 3.647 Equipment for operations requiring a radio communication and/or radio navigation system**

~~(See IEM OPS 3.647)~~

~~Whenever a radio communication and/or radio navigation system is required, an operator shall not conduct operations unless the helicopter is equipped with a headset with boom microphone or equivalent and a transmit button on the flight controls for each required pilot and/or crew member at his working station.~~

Comment [DDE4]: Moved to CAT.IDE.H.325

CAT.IDE.H.125 JAR-OPS 3.650 Day VFR operations – fFlight and navigational instruments and associated equipment

~~(See AMC OPS 3.650/3.652) (See [ACJ] OPS 3.650/3.652)~~

Helicopters operated by day under VFR shall be equipped with the following equipment, available at the pilot's station: ~~An operator shall not operate a helicopter by day in accordance with Visual Flight Rules (VFR) unless it is equipped with the flight and navigational instruments and associated equipment and, where applicable, under the conditions stated in the following sub-paragraphs:~~

(a) a means of measuring and displaying:

- ~~(a1)~~ A magnetic ~~[direction indicator]~~;
- ~~(b2)~~ An accurate time piece showing the time in hours, minutes, and seconds;
- ~~(e3)~~ **pressure altitude** ~~A sensitive pressure altimeter calibrated in feet with a sub-scale setting, calibrated in hectopascals/millibars, adjustable for any barometric pressure likely to be set during flight;~~

Comment [DDE5]: Moved to AMC

JAR-OPS Subpart K-L | Revised rule text

~~(d4)~~ An airspeed indicator calibrated in knots; **indicated airspeed;**

Comment [DDE6]: Moved to AMC

~~(e5)~~ A vertical speed indicator;

~~(f6)~~ A slip indicator;

(b) a means of displaying:

~~(g1)~~ A means of indicating in the flight crew compartment the outside air temperature; **and** calibrated in degrees Celsius (see AMC OPS 3.650(g) & 3.652(k)).

Comment [DDE7]: Moved to AMC

(2) when power is not adequately supplied to the required flight instruments.

~~(hc)~~ Whenever two pilots are required **for the operation, an additional** the second pilot's station shall have separate **means of displaying the following shall be available for the second pilot** instruments as follows:

(1) A sensitive pressure **altitude** altimeter calibrated in feet with a sub scale setting calibrated in hectopascals/millibars, adjustable for any barometric pressure likely to be set during flight;

Comment [DDE8]: Moved to AMC

(2) An **indicated** airspeed indicator calibrated in knots;

Comment [DDE9]: Moved to AMC

(3) A vertical speed indicator; and

(4) A slip indicator.

~~(id)~~ In addition to the flight and navigational equipment required by sub paragraphs (a) to (h) above, **h** Helicopters with a maximum certificated take-off mass (MCTOM) **of over more than** 3 175 kg or any helicopter ~~operating over water~~ out of sight of land or when the visibility is less than 1 500 m, **must be equipped with the following flight instruments; a means of measuring and displaying:**

(1) An attitude indicator; and

(2) A ~~gyroscopic direction indicator.~~

~~(j)~~ Whenever duplicate instruments are required, the requirement embraces separate displays for each pilot and separate selectors or other associated equipment where appropriate;

Comment [DDE10]: Moved to AMC

~~(k)~~ All helicopters must be equipped with means for indicating when power is not adequately supplied to the required flight instruments; and

~~(le)~~ Each airspeed indicating system must be equipped with a heated pitot tube or equivalent **A means for preventing malfunction of the airspeed indicating systems** due to either condensation or icing for helicopters with a maximum certificated take off mass (**an** MCTOM) **over of more than** 3 175 kg or having a maximum approved passenger seating configuration (**a maximum passenger seating configuration** (MAPSC)) of more than **nine**.

CAT.IDE.H.130 JAR-OPS 3.652 IFR or night operations – fFlight and navigational instruments and associated equipment

(See AMC OPS 3.650/3.652) (See [ACJ] OPS 3.650/3.652)

Helicopters operated under VFR at night or under IFR shall be equipped with the following equipment, available at the pilot's station: ~~An operator shall not operate a~~

JAR-OPS Subpart K-L | Revised rule text

helicopter in accordance with Instrument Flight Rules (IFR) or by night in accordance with Visual Flight Rules (VFR) unless it is equipped with the flight and navigational instruments and associated equipment and, where applicable, under the conditions stated in the following sub-paragraphs:

(a) **a means of measuring and displaying:**

(1) A-magnetic [direction-indicator];

(b2) An accurate time piece showing the time in hours, minutes and seconds;

~~(c3) Two sensitive pressure altimeters calibrated in feet, with sub-scale settings calibrated in hectopascals/millibars, adjustable for any barometric pressure likely to be set during flight. For single pilot night VFR operations one pressure altimeter may be substituted by a radio altimeter.~~

Comment [GCI11]: Moved to AMC

~~(d3) An airspeed-indicated **airspeeding** system with heated pitot tube or equivalent means for preventing malfunctioning due to either condensation or icing including [an annunciation] of pitot heater failure. The pitot heater failure [annunciation] requirement does not apply to those helicopters with a maximum approved passenger seating configuration (MAPSC) of 9 or less or a maximum certificated take off mass (MCTOM) of 3 175 kg or less and issued with an individual Certificate of Airworthiness prior to 1 August 1999 (see AMC OPS 3.652(d) & (m)(2)).~~

Comment [DDE12]: Moved to subparagraph (d)+(e)

(4e) A-vertical speed-indicator;

(f5) A-slip-indicator;

~~(g6) An attitude-indicator;~~

(7) **stabilised direction;**

(b) **two means of measuring and displaying pressure altitude. For single pilot night VFR operations one pressure altimeter may be substituted by a radio altimeter;**

(c) **a means of displaying:**

(1) **outside air temperature; and**

(2) **when power is not adequately supplied to the required flight instruments;**

(d) **a means of preventing malfunction of the airspeed indicating systems required in (a)(3) and (h)(2) due to either condensation or icing;**

(e) **a means of indicating and annunciating to the flight crew the failure of the means required in (d) for helicopters:**

(1) **issued with an individual Certificate of Airworthiness (of A) on or after 1 August 1999; or**

(2) **issued with an individual C of A before 1 August 1999 with an MCTOM of more than 3175 kg, and with an MPSC of more than nine;**

~~(hf) **a standby means of measuring and displaying attitude that:** A single standby attitude indicator (artificial horizon) capable of being used from either pilot's station that:~~

JAR-OPS Subpart K-L | Revised rule text

- ~~(1) Provides reliable operation for a minimum of 30 minutes or the time required to fly to a suitable alternate landing site when operating over hostile terrain or offshore, whichever is the greater, after total failure of the normal electrical generating system, taking into account other loads on the emergency power supply and operational procedures;~~
- ~~(21) Operates independently of ~~from any~~ other means of measuring and displaying attitude-indicating system;~~
- (2) is capable of being used from either pilot's station;**
- ~~(3) Is operative automatically after total failure of the normal electrical generating system; and~~
- (4) provides reliable operation for a minimum of 30 minutes or the time required to fly to a suitable alternate landing site when operating over hostile terrain or offshore, whichever is greater, after total failure of the normal electrical generating system, taking into account other loads on the emergency power supply and operational procedures;**
- ~~(54) Is appropriately illuminated during all phases of operation; and~~
- (6) is associated with a means to alert the flight crew when operating under its dedicated power supply, including when operated by emergency power;-**
- ~~(i) In complying with sub paragraph (h) above, it must be clearly evident to the flight crew when the standby attitude indicator, required by that paragraph, is being operated by emergency power. Where the standby attitude indicator has its own dedicated power supply there shall be an associated indication clearly visible when this supply is in use.~~
- ~~(j) A [gyroscopic direction indicator for VFR night and a magnetic gyroscopic direction indicator for IFR.]~~
- ~~(k) A means of indicating in the flight crew compartment the outside air temperature calibrated in degrees Celsius (see AMC OPS 3.650(g) and 3.652(k)); and~~
- ~~(tg) aAn alternate source of static pressure for the means of measuring altitude, altimeter and the airspeed and vertical speed indicators; and~~
- ~~(mh) wWhenever two pilots are required for the operation, a separate means for displaying for the second pilot's station shall have separate instruments as follows:~~
- ~~(1) A sensitive pressure altitude altimeter calibrated in feet with a sub-scale setting, calibrated in hectopascals/millibars, adjustable for any barometric pressure setting likely to be encountered during flight which may be one of the two altimeters required by sub paragraph (c) above;~~
- ~~(2) An indicated airspeed indicating system with heated pitot tube or equivalent means for preventing malfunctioning due to either condensation or icing including [an annunciation] of pitot heater failure. The pitot heater failure [annunciation] requirement does not apply to those helicopters with a maximum approved passenger seating configuration (MAPSC) of 9 or less or a maximum certificated take off mass (MCTOM) of 3 175 kg or less and issued~~

Comment [DDE13]: See subparagraph (a)(7) above and AMC

Comment [DDE14]: Refer to (c)(1) above

Comment [GCI15]: It's not additional. Two means are already required by (a).

Comment [DDE16]: Moved to AMC

JAR-OPS Subpart K-L | Revised rule text

~~with an individual Certificate of Airworthiness prior to 1 August 1999 (see AMC OPS 3.652(d) and (m)(2));~~

Comment [DDE17]: Moved to subparagraph (c) and (d)

- (3) ~~A~~ vertical speed indicator;
- (4) ~~A~~ slip indicator;
- (5) ~~An~~ attitude indicator; and
- (6) ~~A~~ [~~gyroscopic~~**stabilised** direction indicator for VFR night and a magnetic gyroscopic direction indicator for IFR;]

(~~ni~~) ~~f~~For IFR operations, a chart holder in an easily readable position ~~which~~**that** can be illuminated for night operations.

~~(o)~~ Whenever duplicate instruments are required, the requirement embraces separate displays for each pilot and separate selectors or other associated equipment where appropriate; and

Comment [DDE18]: Moved to AMC

~~(p)~~ All helicopters must be equipped with means for indicating when power is not adequately supplied to the required flight instruments.

Comment [DDE19]: Refer to (c)(2)

~~JAR-OPS 3.655~~**CAT.IDE.H.135 Additional equipment for single pilot operation under IFR**

~~(See AMC OPS 3.655)~~

An operator shall not conduct ~~Helicopters operated under IFR with a~~ single pilot IFR operations unless the helicopter ~~is~~**shall be** equipped with an autopilot with, at least, altitude hold and heading mode, ~~except for helicopters with a maximum approved passenger seating configuration (MAPSC) of 6 or less first certificated in a JAA Member State for single pilot IMC operations on or before 1 January 1979 and which are in service in a JAA Member State on 1 August 1999. Such helicopters may continue to be operated until 31 December 2004 provided the operator has been granted a relevant approval by the Authority.~~

Comment [DDE20]: Exemption elapsed

~~JAR-OPS 3.660~~**CAT.IDE.H.145 —Radio Altimeters**

(a) An operator shall not operate a ~~h~~**Helicopters** on a flights over water **shall be equipped with a radio altimeter capable of emitting an audio warning below a pre-set height and a visual warning at a height selectable by the pilot, when operating;:**

- (1) ~~when operating~~ out of sight of the land; ~~or~~
- (2) ~~when the~~ in a visibility ~~is~~**of** less than 1 500 m; ~~or~~
- (3) at night; or
- (4) at a distance from land corresponding to more than 3 minutes at normal cruising speed, ~~unless that helicopter is equipped with a radio altimeter with an audio voice warning, or other means acceptable to the Authority, operating below a preset height and a visual warning capable of operating at a height selectable by the pilot.~~

JAR-OPS Subpart K-L | Revised rule text

~~JAR OPS 3.665 Intentionally blank~~~~JAR OPS 3.670~~CAT.IDE.H.160 Airborne ~~w~~Weather Radar-detecting ~~e~~Equipment

An operator shall not operate a ~~h~~Helicopters with an maximum approved passenger seating configuration (MAPSC) of more than ~~9~~**nine and operated** under IFR or at night **shall be equipped with airborne weather equipment** when current weather reports indicate that thunderstorms or other potentially hazardous weather conditions, regarded as detectable with airborne weather ~~radar~~**detecting equipment**, may reasonably be expected along the route to be flown~~unless it is equipped with airborne weather radar equipment.~~

~~JAR OPS 3.675~~CAT.IDE.H.165~~Equipment~~ Additional equipment for operations in icing conditions at night

- (a) ~~An operator shall not operate a helicopter in expected or actual icing conditions unless it is certificated and equipped to operate in icing conditions.~~
- (ba) An operator shall not operate a ~~h~~Helicopters **operated** in expected or actual icing conditions at night ~~unless it is~~**shall be** equipped with a means to illuminate or detect the formation of ice.
- (b) ~~Any~~**The means to illuminate the formation of ice** illuminationthat is used must be of a type that ~~will~~**shall** not cause glare or reflection that would handicap crew members in the performance of their duties.

Comment [DDE21]: Deleted as it is already contained in Essential Requirements 2.a.5.

~~JAR OPS 3.680 Intentionally blank~~~~JAR OPS 3.685~~CAT.IDE.H.170 Flight crew interphone system

An operator shall not operate a ~~h~~Helicopters on which a flight crew of**operated by** more than one **flight crew member** is required ~~unless it is~~**shall be** equipped with a flight crew interphone system, including headsets and microphones, ~~not of a handheld type,~~ for use by all **flight crew** members of the flight crew.

Comment [DDE22]: Moved to AMC

~~JAR OPS 3.690~~CAT.IDE.H.175 Crew member interphone system

- (a) ~~An operator shall not operate a h~~Helicopters **shall be equipped with a crew member interphone system** when carrying a crew member other than a flight crew member. ~~unless it is equipped with a crew member interphone system.~~
- (b) ~~The crew member interphone system required by this paragraph must:~~
- (1) ~~Operate independently of the public address system except for handsets, headsets, microphones, selector switches and signalling devices;~~
 - (2) ~~Provide a means of two way communication between the flight crew compartment and each crew member station;~~
 - (3) ~~Be readily accessible for use from each of the required flight crew stations in the flight crew compartment;~~
- ~~and in addition for cabin crew members:~~

JAR-OPS Subpart K-L | Revised rule text

- ~~(4) Be readily accessible for use at required cabin crew stations close to each separate or pair of floor level emergency exits;~~
- ~~(5) Have an alerting system incorporating aural or visual signals for use by flight crew members to alert the cabin crew and for use by cabin crew members to alert the flight crew; and~~
- ~~(6) Have a means for the recipient of a call to determine whether it is a normal call or an emergency call (See AMC OPS 3.690(b)(6)).~~

Comment [DDE23]: Moved to AMC

~~JAR-OPS 3.695~~CAT.IDE.H.180 Public address system

- (a) ~~{Except as in (c) below,} an operator shall not operate a ~~h~~Helicopters with a ~~an~~ maximum approved passenger seating configuration ~~{(MAPSC)}~~ of more than 9 ~~nine~~ unless a **shall be equipped with a public address system with the exception of the following:** is installed.~~

- ~~(b) The public address system required by this paragraph must:~~

- ~~(1) Operate independently of the interphone systems except for handsets, headsets, microphones, selector switches and signalling devices;~~
- ~~(2) Be readily accessible for immediate use from each required flight crew member station;~~
- ~~(3) Be readily accessible for use from at least one cabin crew member station in the cabin, and each public address system microphone intended for cabin crew use must be positioned adjacent to a cabin crew member seat that is located near each required floor level emergency exit in the passenger compartment;~~
- ~~(4) Be capable of operation within 10 seconds by a cabin crew member at each of those stations in the compartment from which its use is accessible;~~
- ~~(5) Be audible and intelligible at all passenger seats, toilets and cabin crew seats and work stations; and~~
- ~~(6) Following a total failure of the normal electrical generating system, provide reliable operation for a minimum of 10 minutes.~~

Comment [DDE24]: Moved to AMC

- ~~{(e1) For helicopters with a maximum approved passenger seating configuration (n MAPSC) of more than 9 ~~nine~~ but **and** less than 19, the Public Address System is not required if:~~

- ~~(i) the helicopter is designed without a bulkhead between pilot and passengers; and~~
- ~~(ii) the operator is able to demonstrate that when in flight, the pilot's voice is audible and intelligible at all passengers' seats.~~

~~JAR-OPS 3.700~~CAT.IDE.H.185 Cockpit voice recorders~~-1~~

~~(See [ACJ]OPS 3.700)~~

- (a) ~~(a) —~~ **The following helicopter types shall be equipped with a cockpit voice recorder (CVR):**

- (1) all helicopters with an MCTOM of more than 7 000 kg; and**

JAR-OPS Subpart K-L | Revised rule text

(2) helicopters with an MCTOM of more than 3 175 kg and first issued with an individual C of A on or after 1 January 1987.

~~An operator shall not operate a helicopter first issued with an individual Certificate of Airworthiness, [] on or after 1 August 1999, which has a maximum certificated take-off mass (MCTOM) over 3 175 kg unless it is equipped with a cockpit voice recorder which, with reference to a time scale, records:~~

- ~~(1) Voice communications transmitted from or received by the [] crew by radio;~~
- ~~(2) The aural environment of the cockpit including, without interruption, the audio signals received from each [] crew microphone in use;~~
- ~~(3) Voice communications of [] crew members [] using the [crew members] interphone system;~~
- ~~(4) Voice or audio signals identifying navigation or approach aids introduced into a headset or speaker; and~~
- ~~(5) Voice communications of [] crew members [] using the public address system, where practicable.~~

(b) ~~The cockpit voice recorder~~**CVR** shall be capable of retaining information ~~the data~~ recorded during at least ~~the last hour of its operation except that, for those helicopters with a maximum certificated take-off mass of 7 000 kg or less, this period may be reduced to 30 minutes.~~

- (1) the preceding 2 hours for helicopters referred to in (a)(1) and (a)(2), when first issued with an individual C of A on or after 1 January 2016;**
- (2) the preceding 1 hour for helicopters referred to in (a)(1), when first issued with an individual C of A on or after 1 August 1999 and before 1 January 2016;**
- (3) the preceding 30 minutes for helicopters referred to in (a)(1), when first issued with an individual C of A before 1 August 1999; or**
- (4) the preceding 30 minutes for helicopters referred to in (a)(2), when first issued with an individual C of A before 1 January 2016.**

(c) **The CVR shall record with reference to a timescale:**

- (1) voice communications transmitted from or received on the flight crew compartment per radio;**
- (2) flight crew members' voice communications using the interphone system and the public address system, if installed;**
- (3) the aural environment of the flight crew compartment, including, where practicable, without interruption, the audio signals received from each crew microphone; and**
- (4) voice or audio signals identifying navigation or approach aids introduced into a headset or speaker.**

(ed) ~~The cockpit voice recorder~~**CVR shall** ~~must~~ start **to record** automatically ~~to record~~ prior to the helicopter moving under its own power and **shall** continue to record until the termination of the flight when the helicopter is no longer capable of moving under its own power.

JAR-OPS Subpart K-L | Revised rule text

- (e) In addition, **for helicopters referred to in (a)(2) when the individual C of A has been issued on or after 1 August 1999 and** depending on the availability of electrical power, the cockpit voice recorder **CVR shall** ~~must~~ start to record as early as possible during the cockpit checks prior to engine start ~~at the beginning of the flight until the cockpit checks immediately following engine shutdown at the end of the flight.~~
- (df) The cockpit voice recorder **CVR shall** ~~must~~ have a device to assist in locating that recorder ~~it~~ in water.

~~(e) In complying with this section, the cockpit voice recorder may be combined with the flight data recorder. [(See ACJ OPS 3.700(e))]~~

Comment [DDE25]: Addressed in CAT.IDE.H.200

~~JAR OPS 3.705 Cockpit voice recorders 2]~~

Comment [DDE26]: Included in CAT.IDE.H.185

~~(See ACJ OPS 3.705)~~

~~[(a) An operator shall not operate a helicopter which has either: a maximum certificated take off mass (MCTOM) of over 3175 kg, but not more than 7000 kg, and first issued with an individual Certificate of Airworthiness between 1 January 1987 and 31 July 1999 inclusive, or a MCTOM of over 7000 kg and first issued with an individual Certificate of Airworthiness up to and including 31 July 1999; unless these are equipped with a cockpit voice recorder which records with reference to a timescale:]~~

- ~~(1) Voice communications transmitted from or received by the crew by radio;~~
- ~~(2) The aural environment of the cockpit, including where practicable, without interruption, the audio signals received from each crew microphone in use;~~
- ~~(3) Voice communications of crew members using the crew member's interphone system;~~
- ~~(4) Voice or audio signals identifying navigation or approach aids introduced into a headset or speaker;~~
- ~~(5) Voice communications of crew members using the public address system, where practicable; and~~
- ~~(6) For a helicopter not equipped with a flight data recorder, the parameters necessary to determine main rotor speed.~~
- ~~(b) The cockpit voice recorder shall be capable of retaining information recorded during at least the last 30 minutes of its operation.~~
- ~~(c) The cockpit voice recorder must start to record prior to the helicopter moving under its own power and continue to record until the termination of the flight when the helicopter is no longer capable of moving under its own power.~~
- ~~(d) The cockpit voice recorder must have a device to assist in locating that recorder in water.~~
- ~~(e) In complying with this section, the cockpit voice recorder may be combined with the flight data recorder. See ACJ OPS 3.700(e)~~
- ~~(f) Helicopters with a maximum certificated take off mass (MCTOM) over 3 175 kg but not more than 7 000 kg operated for the purpose of HEMS on or before [31 July~~

JAR-OPS Subpart K-L | Revised rule text

~~1999], may continue to be operated for the purpose of HEMS without being equipped with a cockpit voice recorder until 31 December 2010, if acceptable to the Authority.~~

JAR-OPS 3.710 Intentionally blank

JAR-OPS 3.715CAT.IDE.H.190 Flight data recorders-1

~~[(See Appendix 1 to JAR OPS 3.715/3.720)] (See [ACJ] OPS 3.715/3.720)~~

- (a) ~~An operator shall not operate any helicopter first issued with an individual Certificate of Airworthiness [] on or after 1 August 1999 which has a maximum certificated take-off mass (MCTOM) over 3 175 kg unless it is equipped with~~ **The following helicopters shall be equipped with** a flight data recorder (FDR) that uses a digital method of recording and storing data and **for which** a method of readily retrieving that data from the storage medium is available.:
- (1) helicopters with an MCTOM of more than 3 175 kg and first issued with an individual C of A on or after 1 August 1999; and**
 - (2) helicopters with an MCTOM of more than 7 000 kg, or an MPSC of more than nine, and first issued with an individual C of A on or after 1 January 1989 and before 1 August 1999.**
- (b) ~~The flight data recorder~~**FDR shall record the parameters required to determine accurately the** ~~be capable of retaining the data recorded during at least the last 8 hours of its operation.:~~
- (1) flight path, speed, attitude, engine power, operation and configuration and be capable of retaining the data recorded during at least the preceding 10 hours, for helicopters referred to in (a)(1) and first issued with an individual C of A on or after 1 January 2016;**
 - (2) flight path, speed, attitude, engine power and operation and be capable of retaining the data recorded during at least the preceding 8 hours, for helicopters referred to in (a)(1) and first issued with an individual C of A before 1 January 2016; or**
 - (3) flight path, speed, attitude, engine power and operation and be capable of retaining the data recorded during at least the preceding 5 hours, for helicopters referred to in (a)(2).**
- (c) ~~The flight data recorder must, with reference to a timescale, record:~~
- ~~(1) [For helicopters with a maximum certificated take-off mass (MCTOM) over 3 175 kg but not over 7 000 kg] the parameters [listed in Table A of Appendix 1;]~~
 - ~~(2) For [] helicopters with a maximum certificated take-off mass over 7 000 kg, the [parameters listed in Table B of Appendix 1,] [except that, if acceptable to the Authority, parameter 19 need not be recorded, when any of the following conditions are met:~~
 - ~~(i) The sensor is not readily available,~~
 - ~~(ii) A change is required in the equipment that generates the data;]~~

JAR-OPS Subpart K-L | Revised rule text

- ~~(3) For all helicopters, the flight data recorder must record any dedicated parameters relating to novel or unique design or operational characteristics of the helicopter[; and]~~
- ~~(4) For helicopters equipped with electronic display systems, the parameters listed in Table C of Appendix 1.]~~
- ~~(dc)~~ Data ~~must~~ **shall** be obtained from [helicopter] sources which enable accurate correlation with information displayed to the flight crew.
- ~~(ed)~~ The flight data recorder ~~must~~ **FDR shall automatically** start automatically to record the data prior to the helicopter being capable of moving under its own power and ~~must~~ **shall** stop automatically after the helicopter is incapable of moving under its own power.
- ~~(fe)~~ The flight data recorder ~~must~~ **FDR shall** have a device to assist in locating that recorder ~~it~~ in water.
- ~~(g) In complying with this section, the flight data recorder may be combined with the cockpit voice recorder [(See ACJ OPS 3.700(e))].~~

Comment [DDE27]: Addressed in CAT.IDE.H.200

Comment [DDE28]: Included in CAT.IDE.H.190

JAR-OPS 3.720 Flight data recorders-2

~~[(See Appendix 1 to JAR OPS 3.715/3.720)] (See [ACJ]OPS 3.715/3.720)~~

- ~~(a) [An operator shall not operate any helicopter first issued with an individual Certificate of Airworthiness on or after 1 January 1989, up to and including 31 July 1999, which has a maximum certificated take off mass (MCTOM) over 7 000 kg or a maximum approved passenger seating configuration (MAPSC) of more than 9, unless it is equipped with a flight data recorder that uses a digital method of recording and storing data and a method of readily retrieving that data from the storage medium.]~~

~~For helicopters not equipped with a flight data recorder on or before 31 July 1999 compliance with this requirement may be delayed until 1 January 2005.]~~

- ~~(b) The flight data recorder shall be capable of retaining the data recorded during at least the last 5 hours of its operation.~~
- ~~(c) The flight data recorder must record with reference to a timescale:~~
- ~~(1) [For helicopters with a maximum certificated take off mass (MCTOM) of 7 000 kg or less and with a maximum approved passenger seating configuration (MAPSC) of more than 9 the parameters listed in Table A of Appendix 1]~~
- ~~(2) For [] helicopters with a maximum certificated take off mass (MCTOM) over 7 000 kg [the parameters listed in Table B of Appendix 1, except that, if acceptable to the Authority, parameter 19 need not be recorded, when any of the following conditions are met:~~
- ~~(i) The sensor is not readily available,~~
- ~~(ii) A change is required in the equipment that generates the data.]~~
- ~~(3) For all helicopters, the flight data recorder must record any dedicated parameters relating to novel or unique design or operational characteristics of the helicopter[; and]~~

JAR-OPS Subpart K-L | Revised rule text

~~{(4) For helicopters equipped with electronic display systems, the parameters listed in Table C of Appendix 1.~~

~~{(d) Individual parameters that can be derived by calculation from the other recorded parameters, need not be recorded if acceptable to the Authority.}~~

~~{(e)} Data must be obtained from aircraft sources which enable accurate correlation with information displayed to the flight crew.~~

~~{(f)} The flight data recorder must start automatically to record the data prior to the helicopter being capable of moving under its own power and must stop automatically after the helicopter is incapable of moving under its own power.~~

~~{(g)} The flight data recorder must have a device to assist in locating that recorder in water.~~

~~{(h)} In complying with this section, the flight data recorder may be combined with the cockpit voice recorder. [(See ACJ OPS 3.700(e)).]}~~

JAR OPS 3.725 — Intentionally blank**CAT.IDE.H.195 Data link recording**

- (a) Helicopters first issued with an individual C of A on or after 8 April 2014 that have the capability to operate data link communications and are required to be equipped with a CVR, shall record on a recorder, where applicable:**
- (1) data link communication messages related to air traffic services communications to and from the helicopter;**
 - (2) information that enables correlation to any associated records related to data link communications and stored separately from the helicopter; and**
 - (3) information on the time and priority of data link communications messages, taking into account the system's architecture.**
- (b) The recorder shall use a digital method of recording and storing data and information and a method of readily retrieving that data shall be available. The recording method shall be such as to allow the data to match the data recorded on the ground.**
- (c) The recorder shall be capable of retaining data recorded for at least the same duration as set out for CVRs in CAT.IDE.H.185.**
- (d) The recorder shall have a device to assist in locating it in water.**
- (e) The recorder shall start to record automatically prior to the helicopter moving under its own power and shall continue to record until the termination of the flight when the helicopter is no longer capable of moving under its own power.**
- (f) Depending on the availability of electrical power, the recorder shall start to record as early as possible during the cockpit checks prior to engine start at the beginning of the flight until the cockpit checks immediately following engine shutdown at the end of the flight.**

JAR-OPS Subpart K-L | Revised rule text

CAT.IDE.H.200 Flight data and cockpit voice combination recorder

Comment [GCI29]: See comment on the same IR for aeroplanes.

Compliance with CVR and FDR requirements may be achieved by the carriage of one combination recorder.

JAR-OPS 3.730CAT.IDE.H.205— Seats, seat safety belts, harnesses and child restraint devices

- (a) ~~An operator shall not operate a helicopter unless it is~~ **shall be** equipped with:
- (1) ~~a~~ **A** seat or berth for each person **on board older than 24 months** ~~who is aged two years or more;~~
 - (2) **seats for cabin crew members;**
 - (23) ~~For helicopters first issued with an individual Certificate of Airworthiness, either in a JAA member state or elsewhere up to and including 31 July 1999 a safety belt, with or without a diagonal shoulder strap, or a safety harness for use in each passenger seat for each passenger aged two years or more~~ **a seat belt for use in each passenger seat and restraining belts for each berth;**
 - (34) ~~For helicopters first issued with an individual Certificate of Airworthiness, either in a JAA member state or elsewhere on or after 1 August 1999, a safety belt, with a diagonal shoulder strap, or a safety harness for use in~~ **on** each passenger seat for each passenger ~~aged two years or more~~ **above the age of 24 months;**
 - (45) ~~a~~ **a** child restraint device (CRD) for each ~~passenger less~~ **person on board younger than 2 years of age** **24 months;**
 - (56) ~~a~~ **a** safety harness for each flight crew seat incorporating a device ~~which that~~ will automatically restrain the occupant's torso in the event of rapid deceleration **on each flight crew seat;** and
 - (67) ~~a~~ **a** safety harness **on the seats for the minimum required** ~~for each cabin crew member's seat.~~

Note: This requirement does not preclude use of passenger seats by cabin crew members carried in excess of the required cabin crew complement.

- ~~(7) Seats for cabin crew members located, where possible, near a floor level emergency exit. If the number of required cabin crew members exceeds the number of floor level emergency exits the additional cabin crew seats required shall be located such that the cabin crew member(s) may best be able to assist passengers in the event of an emergency evacuation. Such seats shall be forward or rearward facing within 15° of the longitudinal axis of the helicopter.~~
- (b) **Safety harnesses shall include two shoulder straps and a seat belt which may be used independently**
- (c) **Safety harnesses and safety belts must have a single point release.** ~~A safety belt with a diagonal shoulder strap is permitted if it is not reasonably practicable to fit the latter.~~

Comment [DDE30]: See point (2) and associated AMC

Comment [GCI31]: See comment on the corresponding rule for aeroplanes. Definition of safety harness included since it was missing from JAR-OPS. In addition, a proposal is put forward to replace 'safety harness' with 'seat belt with upper torso restrain system' for all seats to provide flexibility for different design solutions. Those design solutions would conform to an equivalent level of safety as determined by airworthiness codes. The Agency invites comments on this particular point. Further explanation is provided in the explanatory note.

Comment [DDE32]: This will be subject to an Art 14 derogation demonstrating an equivalent level of protection and justifying what is "not reasonably practicable". Further explanation is provided in the explanatory note.

JAR-OPS Subpart K-L | Revised rule text

~~JAR-OPS 3.731~~ **CAT.IDE.H.210 Fasten sSeat belt and nNo -sSmoking signs**

~~An operator shall not operate a hHelicopters~~ in which all passenger seats are not visible from the ~~commander's flight crew seat, or from the seat of the pilot to whom the conduct of the flight may be delegated,~~ unless it is **shall be** equipped with a means of indicating to all passengers and cabin crew when seat belts shall be fastened and when smoking is not allowed.

~~JAR-OPS 3.735~~ **Intentionally blank**~~JAR-OPS 3.740~~ **Intentionally blank**~~JAR-OPS 3.745~~ **CAT.IDE.H.220 First-aAid kKits**

~~(See AMC OPS 3.745)~~

- (a) ~~An operator shall not operate a hThe helicopter~~ unless it is **shall be** equipped with **at least one** first-aid kit, readily accessible for use.
- (b) ~~An operator shall ensure that fFirst-aid kits areshall be:~~
- (1) **readily accessible for use;**
 - (2) **carried in a way that prevents unauthorised access;** ~~Inspected periodically to confirm, to the extent possible, that contents are maintained in the condition necessary for their intended use; and~~
 - (23) ~~Replenished at regular intervals, in accordance with instructions contained on their labels, or as circumstances warrant~~ **kept up-to-date.**

~~JAR-OPS 3.750~~ **Intentionally blank**~~JAR-OPS 3.755~~ **Intentionally blank**~~JAR-OPS 3.760~~ **Intentionally blank**~~JAR-OPS 3.765~~ **Intentionally blank**~~JAR-OPS 3.770~~ **Intentionally blank**~~JAR-OPS 3.775~~ **CAT.IDE.H.240 Supplemental oxygen- nNon-pressurised helicopters**

~~(See Appendix 1 to JAR-OPS 3.775)~~

~~(a)~~

General

- (1) ~~An operator shall not operate a nNon-pressurised helicopters~~ **operated** at pressure altitudes above 10 000 ft **shall be equipped with** ~~unless supplemental oxygen equipment, capable of storing and dispensing the oxygen supplies required, is provided~~ **in accordance with Table 1.**

JAR-OPS Subpart K-L | Revised rule text

Table 1: Oxygen minimum requirements for non-pressurised aeroplanes

~~(2) The amount of supplemental oxygen for sustenance required for a particular operation shall be determined on the basis of flight altitudes and flight duration, consistent with the operating procedures established for each operation in the Operations Manual and with the routes to be flown, and with the emergency procedures specified in the Operations Manual.~~

Comment [DDE33]: Moved to AMC.

~~(3) A helicopter intended to be operated above 10 000 ft pressure altitude shall be provided with equipment capable of storing and dispensing the oxygen supplies required.~~

Supply for:	Duration and cabin pressure altitude
1. Occupants of flight crew compartments seats on flight crew compartment duty and crew members assisting flight crew in their duties	The entire flight time at pressure altitudes above 10 000 ft.
2. Required cabin crew members	The entire flight time at pressure altitudes above 13 -000 -ft and for any period of more than 30 minutes at pressure altitudes above 10 000 ft and not more than 13 -000 -ft.
3. Additional crew members and 100 % of passengers*	The entire flight time at pressure altitudes above 13 -000 -ft.
4. 10 % of passengers*	The entire flight time after 30 minutes at pressure altitudes greater than 10 000 ft but not more than 13 -000 ft.

* Passengers refers to passengers actually carried on board including persons younger than 24 months.~~(b) Oxygen supply requirements~~

~~(1) Flight crew members. Each member of the flight crew on duty in the cockpit shall be supplied with supplemental oxygen in accordance with Appendix 1. If all occupants of cockpit seats are supplied from the flight crew source of oxygen supply then they shall be considered as flight crew members on cockpit duty for the purpose of oxygen supply.~~

~~(2) Cabin crew members, additional crew members and passengers. Cabin crew members and passengers shall be supplied with oxygen in accordance with Appendix 1. Cabin crew members carried in addition to the minimum number of cabin crew members required, and additional crew members, shall be considered as passengers for the purpose of oxygen supply.~~

Comment [DDE34]: Included in table above

~~JAR-OPS 3.780 Intentionally blank~~

~~JAR-OPS 3.785 Intentionally blank~~

~~JAR-OPS 3.790CAT.IDE.H.250 Hand fire extinguishers~~

~~(See AMC OPS 3.790)~~

JAR-OPS Subpart K-L | Revised rule text

- (a) ~~An operator shall not operate a helicopter unless~~ **shall be equipped with at least one** hand fire extinguisher **in the flight crew compartment.** ~~are provided for use in crew, passenger and, as applicable, cargo compartments and galleys in accordance with the following:~~
 - ~~(a) The type and quantity of extinguishing agent must be suitable for the kinds of fires likely to occur in the compartment where the extinguisher is intended to be used and, for personnel compartments, must minimise the hazard of toxic gas concentration;~~
 - (b) ~~At least one hand fire extinguisher, containing Halon 1211 (bromochlorodifluoromethane, CBrClF₂), or equivalent as the extinguishing agent, must be conveniently located in the cockpit for use by the flight crew;~~
 - (eb) At least one hand fire extinguisher ~~must~~ **shall** be located in, or readily accessible for use in, each galley not located on the main passenger deck.
 - (ec) At least one ~~readily accessible~~ hand fire extinguisher ~~must~~ **shall** be available for use in each cargo compartment ~~which that~~ is accessible to crew members ~~during in flight for the purpose of fire fighting;~~ and
 - (d) **The type and quantity of extinguishing agent for the required fire extinguishers shall be suitable for the type of fire likely to occur in the compartment where the extinguisher is intended to be used and to minimise the hazard of toxic gas concentration in compartments occupied by persons.**
 - (e) ~~The~~ **A helicopter shall be equipped** ~~There must be~~ **with** at least the following number of hand fire extinguishers **in accordance with Table 1** conveniently located to provide adequate availability for use in each passenger compartment.

Comment [DDE35]: Refer to subparagraph (d)

Comment [DDE36]: Deleted. EC 1005/2009 regulation will forbid the use of Halon.

~~Table 1: of CAT.IDE.H.250~~ **Number of hand fire extinguishers**

Passenger compartment seating capacity Maximum passenger seating configuration	Minimum n Number of Hand Fire Extinguishers
7 to 30	1
31 to 60	2
61 to 200	3

~~JAR-OPS 3.795~~ **Intentionally blank**

~~JAR-OPS 3.800~~ **CAT.IDE.H.260 —Marking of break-in points**

~~An operator shall ensure that, if [] areas of the helicopter's fuselage suitable for break-in by rescue crews in an emergency are [marked] on a helicopter, such areas shall be marked as shown below~~ **in Figure 1.**

Figure 1: Marking of break-in points

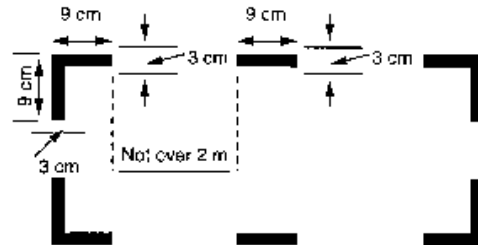

The colour of the markings shall be red or yellow, and if necessary they shall be outlined in white to contrast with the background. If the corner markings are more than 2 metres apart, intermediate lines 9 cm x 3 cm shall be inserted so that there is no more than 2 metres between adjacent marks.

Comment [DDE37]: Moved to AMC

~~JAR-OPS 3.805 Intentionally blank~~

~~JAR-OPS 3.810CAT.IDE.H.270 Megaphones~~

(See AMC OPS 3.810)

An operator shall not operate a ~~h~~Helicopters with an total maximum approved passenger seating configuration (MAPSC) of more than 19, **when carrying at least one passenger, shall be** unless it is equipped with **one** portable battery-powered megaphones readily available ~~accessible~~ for use by crew members during an emergency evacuation.

~~JAR-OPS 3.815CAT.IDE.H.275 Emergency lighting and marking~~

(a) An operator shall not operate a ~~h~~Helicopters which has ~~with~~ an maximum approved passenger seating configuration (MAPSC) of more than 19 ~~unless it is~~ **shall be** equipped with:

- (1) ~~a~~An emergency lighting system having an independent power supply to provide a source of general cabin illumination to facilitate the evacuation of the helicopter; and
- (2) ~~Illuminated~~ emergency exit marking and locating signs **visible in daylight or in the dark.**

(b) Helicopters shall be equipped with emergency exit markings visible in daylight or in the dark when operated:

- (1) in performance class 1 or 2 on a flight over water at a distance from land corresponding to more than 10 minutes' flying time at normal cruising speed; or**
- (2) in performance class 3 on a flight over water at a distance corresponding to more than 3 minutes' flying time at normal cruising speed.**

Comment [DDE38]: Transferred from 3.830(a)(4).

JAR-OPS Subpart K-L | Revised rule text

JAR-OPS 3.820CAT.IDE.H.280 Automatic Emergency Locator Transmitter (ELT)

(See IEM OPS 3.820)

- (a) An operator shall not operate a ~~The~~ helicopter unless it ~~is~~ **shall be** equipped with **at least one** an automatic Emergency Locator Transmitter (ELT) ~~[]~~.
- (b) An operator shall not operate a ~~h~~Helicopters **operating** in ~~p~~Performance ~~c~~Class 1 or 2 **used in offshore operations** on a flight over water in a hostile environment as defined in JAR OPS 3.480(a)(12)(ii)(A) **and** at a distance from land corresponding to more than 10 minutes' flying time at normal cruising speed, ~~on a flight in support of or in connection with the offshore exploitation of mineral resources (including gas), unless it is~~ **shall be** equipped with an **Automatically deployable** Deployable ~~deployable~~ Emergency Locator Transmitter (ELT (AD)).
- (c) An operator ~~[shall] ensure that [all]~~ **The** ELT ~~[s][are]~~ **shall be** capable of transmitting ~~[simultaneously on 121.5 MHz and 406 MHz, are coded in accordance with ICAO Annex 10 and are registered with the national agency responsible for initiating Search and Rescue or another nominated agency].~~

JAR-OPS 3.825CAT.IDE.H.290 Life-jackets

(See IEM OPS 3.825)

- (a) An operator shall not operate a ~~The~~ helicopter **shall be equipped with a life-jacket for each person on board or equivalent floatation device for each person on board younger than 24 months, stowed in a position that is readily accessible from the seat or berth of the person for whose use it is provided, when operated in:** ~~for any operations on water or on a flight over water:~~
- (1) **performance class 1 or 2 on a flight over water at a distance from land corresponding to more than 10 minutes' flying time at normal cruising speed;** ~~When operating in Performance Class 3 beyond autorotational distance from land; or~~
 - (2) **performance class 3 on a flight over water beyond autorotational distance from land; or** ~~When operating in Performance Class 1 or 2 at a distance from land corresponding to more than 10 minutes flying time at normal cruise speed; or~~
 - (3) ~~When operating in p~~Performance ~~c~~Class 2 or 3 when taking off or landing at ~~an~~helicopter **aerodrome or operating site** where the take-off or approach path is over water, ~~, unless it is equipped with life jackets equipped with a survivor locator light, for each person on board, stowed in an easily accessible position, with safety belt or harness fastened, from the seat or berth of the person for whose use it is provided and an individual infant flotation device, equipped with a survivor locator light, for use by each infant on board.~~
- (b) **The commander of a helicopter operated in performance class 3 shall determine the risks to survival of the occupants of the helicopter in the event of a ditching, when deciding if the life-jackets required above shall be worn by all occupants.**

JAR-OPS Subpart K-L | Revised rule text

- (c) **Each life-jacket or equivalent individual flotation device shall be equipped with a means of electric illumination for the purpose of facilitating the location of persons.**

~~JAR-OPS 3.827~~CAT.IDE.H.295 Crew sSurvival sSuits~~(See [ACJ] OPS 3.827)~~**Each helicopter crew member shall wear a survival suit when operating:**

- (a) ~~An operator shall not operate a helicopter in pPerformance cClass 1 or 2 on a flight over water in support of offshore operations, at a distance from land corresponding to more than 10 minutes' flying time at normal cruising speed from land on a flight in support of or in connection with the offshore exploitation of mineral resources (including gas), when the weather report or forecasts available to the commander indicate that the sea temperature will be less than plus 10°C during the flight, or when the estimated rescue time exceeds the {estimated} survival time unless each member of the crew is wearing a survival suit; or~~
- (b) ~~An operator shall not operate a helicopter in pPerformance cClass 3 on a flight over water beyond autorotational distance or safe forced landing distance from land, when the weather report or forecasts available to the commander indicate that the sea temperature will be less than plus 10°C during the flight, unless each member of the crew is wearing a survival suit.~~

~~JAR-OPS 3.830~~CAT.IDE.H.300 Life-rafts, and survival ELTs-ELT(S) o[n]-extended overwater flights and survival equipment on extended overwater flights~~(See AMC OPS 3.830)~~

- (a) ~~An operator shall not operate a H-helicopters operated:~~
- (1) in performance class 1 or 2** on a flight over water at a distance from land corresponding to more than 10 minutes' flying time at normal cruising speed; ~~or when operating in Performance Class 1 or 2,~~
- (2) in performance class 3 on a flight over water at a distance corresponding to more than ~~or~~ 3 minutes' flying time at normal cruising speed when operating in Performance Class 3 unless it carries shall be equipped with:-**
- ~~(1)- i~~ **In the case of a helicopter carrying less than 12 persons, a minimum of at least one life-saving raft with a rated capacity of not less than the maximum number of persons on board, stowed so as to facilitate their ready use in emergency;**
- ~~(2)- i~~ **In the case of a helicopter carrying more than 11 persons, a minimum of at least two life-rafts sufficient together to accommodate all persons capable of being carried on board. Should one life raft of the largest rated capacity be lost, the and with respective overload capacity of the remaining life raft(s) shall be sufficient to accommodate all persons on the helicopter (See AMC OPS 3.830(a)(2)), stowed so as to facilitate their ready use in emergency;**
- ~~(3)- a~~ **At least one survival Emergency Locator Transmitter (ELT (ELT(S))) for each required life raft carried (but not more than a total of 2 ELTs are**

JAR-OPS Subpart K-L | Revised rule text

required), capable of transmitting on the distress frequencies prescribed in [Appendix 1 to JAR OPS 3.830]. (See [also] AMC OPS 3.830(a)(3)); and

- (4) ~~Emergency exit illumination; and~~
- (5) ~~Life-saving equipment, including means of sustaining life, as appropriate to the flight to be undertaken.~~

~~JAR OPS 3.835~~ **CAT.IDE.H.305 Survival equipment—**

~~(See IEM OPS 3.835)~~

An operator shall not operate a ~~h~~**Helicopters operated over** in areas **which have been designated by a State as areas where** search and rescue would be especially difficult unless it ~~is~~**shall be** equipped with the following:

- (a) ~~s~~**Signalling equipment to make the pyrotechnical distress signals described in ICAO Annex 2;**
- (b) ~~a~~**At least one survival Emergency Locator Transmitter (ELT(S)) capable of transmitting on the distress frequencies prescribed in [Appendix 1 to JAR OPS 3.830] (see [also] AMC OPS 3.830(a)(3)); and**
- (c) ~~a~~**Additional survival equipment for the route to be flown taking account of the number of persons on board (see AMC OPS 3.835(e)).**

~~JAR OPS 3.837~~ **CAT.IDE.H.310 Additional requirements for helicopters operating to or from helidecks located conducting offshore operations in a hostile sea area (as defined in JAR OPS 3.480(a)(13)(ii)(A))**

~~(a) An operator shall not operate a h~~**Helicopters on a flight to or from a helideck located operated in offshore operations** in a hostile sea area, at a distance from land corresponding to more than 10 minutes' flying time at normal cruising speed ~~on a flight in support of or in connection with the offshore exploitation of mineral resources (including gas) unless;~~ **, shall comply with the following:**

- ~~(1a)~~ **(2a)** When the weather report or forecasts available to the commander indicate that the sea temperature will be less than plus 10°C during the flight, or when the estimated rescue time exceeds the calculated survival time, or the flight is planned to be conducted at night, all persons on board are wearing a survival suit ~~(see ACJ OPS 3.827).~~;
- ~~(2b)~~ **(3b)** All life-rafts carried in accordance with ~~JAR OPS 3.830~~ **CAT.IDE.H.300** are ~~are~~ **shall be** installed so as to be usable in the sea conditions in which the helicopter's ditching, flotation and trim characteristics were evaluated in order to comply with the ditching requirements for certification ~~(See IEM OPS 3.837(a)(2)).~~;
- ~~(3c)~~ **(4c)** The helicopter ~~is~~ **shall be** equipped with an emergency lighting system ~~having with~~ an independent power supply to provide a source of general cabin illumination to facilitate the evacuation of the helicopter.;
- ~~(4d)~~ **(5d)** All emergency exits, including crew emergency exits, and ~~its~~ **the** means of opening ~~them are~~ **shall be** conspicuously marked for the guidance of occupants using the exits in daylight or in the dark. Such markings ~~are~~ **shall be** designed to remain visible if the helicopter is capsized and the cabin is submerged.;

JAR-OPS Subpart K-L | Revised rule text

- (5e) All non-jettisonable doors ~~which~~ **that** are designated as ~~Ditching~~ **ditching** ~~Emergency~~ **emergency** Exits ~~exits~~ **shall** have a means of securing them in the open position so **that** they do not interfere with occupants' egress in all sea conditions up to the maximum required to be evaluated for ditching and flotation.
- (6f) All doors, windows or other openings in the passenger compartment ~~authorised by the Authority~~ **assessed** as suitable for the purpose of underwater escape, ~~are~~ **shall be** equipped so as to be operable in an emergency.
- (7g) Life-jackets ~~are~~ **shall be** worn at all times, unless the passenger or crew member is wearing an integrated survival suit that meets the combined requirement of the survival suit and life-jacket ~~which is acceptable to the Authority~~.

~~JAR-OPS 3.840~~ **CAT.IDE.H.315— Helicopters certificated for operating on water - mMiscellaneous equipment**

- (a) ~~An operator shall not operate on water a hHelicopters~~ **Helicopters** certificated for operating on water ~~unless it is~~ **shall be** equipped with:
- (1a) ~~a~~ **a** sea anchor and other equipment necessary to facilitate mooring, anchoring or manoeuvring the aircraft ~~aircraft~~ **helicopter** on water, appropriate to its size, weight and handling characteristics; and
- (2b) ~~e~~ **e**quipment for making the sound signals prescribed in the International Regulations for ~~P~~ **pre**venting ~~C~~ **ce**llisions at ~~S~~ **sea**, where applicable.

~~JAR-OPS 3.843~~ **CAT.IDE.H.320— All helicopters on flights over water - dDitching**

- (a) ~~An operator shall not operate a hHelicopters~~ **Helicopters** in Performance Class 1 or 2 on a flight over water in a hostile environment at a distance from land corresponding to more than 10 minutes flying time at normal cruise speed ~~unless that helicopter is s~~ **shall be** designed for landing on water or ~~is~~ **certificated for ditching** in accordance with ~~ditching provisions~~ **of the relevant airworthiness code when operated in performance class 1 or 2 on a flight over water in a hostile environment at a distance from land corresponding to more than 10 minutes' flying time at normal cruise speed.**
- (b) ~~An operator shall not operate a hHelicopters~~ **Helicopters** in Performance Class 1 or 2 on a flight over water in a non-hostile environment at a distance from land corresponding to more than 10 minutes flying time at normal cruise speed ~~unless that helicopter is;~~ ~~s~~ **shall be** designed for landing on water; or ~~is~~ **certificated for ditching** in accordance with ~~ditching provisions~~ **of the relevant airworthiness code**; or is fitted with emergency flotation equipment **when operated in:**
- (1) **performance class 1 or 2 on a flight over water in a non-hostile environment at a distance from land corresponding to more than 10 minutes' flying time at normal cruise speed;**
- (e2) ~~An operator shall not operate a helicopter in pPerformance cClass 2, when taking-off or landing over water,~~ **except in the case of helicopter emergency medical services (HEMS) operations, where for the purpose of minimising exposure, the landing or take-off at a HEMS operating site located in a congested environment is conducted over water; or**

JAR-OPS Subpart K-L | Revised rule text

~~unless that helicopter is; so designed for landing on water; or is certificated in accordance with ditching provisions; or is fitted with emergency floatation equipment. (See IEM OPS 3.843(c)). Except where, for the purpose of minimising exposure, the landing or take off at a HEMS operating site located in a congested environment is conducted over water unless otherwise required by the Authority.~~

(d3) ~~An operator shall not operate a helicopter in~~ Performance class 3 on a flight over water beyond safe forced landing distance from land ~~unless that helicopter is; so designed for landing on water; or is certificated in accordance with ditching provisions; or is fitted with emergency floatation equipment.~~

~~[Appendix 1 to JAR OPS 3.715/3.720 Flight data recorders — 1 and 2 — List of parameters to be recorded]~~

Comment [DDE39]: Moved to AMC

Table A — Helicopters with a maximum certificated take-off mass (MCTOM) of 7 000 kg or less

No.	Parameter
1	Time or relative time count
2	Pressure altitude
3	Indicated airspeed
4	Heading
5	Normal acceleration
6	Pitch attitude
7	Roll attitude
8	Manual radio transmission keying
9	Power on each engine (free power turbine speed and engine torque)/ cockpit power control position (if applicable)
10a	Main rotor speed
10b	Rotor brake (if installed)
11	Primary flight controls — Pilot input and control output position (if applicable)
11a	Collective pitch
11b	Longitudinal cyclic pitch
11c	Lateral cyclic pitch

JAR-OPS Subpart K-L | Revised rule text

11d	Tail rotor pedal
11e	Controllable stabilator
11f	Hydraulic selection
12	Warnings
13	Outside air temperature
14	Autopilot engagement status
15	Stability augmentation system engagement

Table B — Helicopters with a maximum certificated take off mass (MCTOM) of over 7 000 kg

No.	Parameter
1	Time or relative time count
2	Pressure altitude
3	Indicated airspeed
4	Heading
5	Normal acceleration
6	Pitch attitude
7	Roll attitude
8	Manual radio transmission keying
9	Power on each engine (free power turbine speed and engine torque)/ cockpit power control position (if applicable)
10a	Main rotor speed
10b	Rotor brake (if installed)
11	Primary flight controls — Pilot input and control output position (if applicable)
11a	Collective pitch
11b	Longitudinal cyclic pitch

JAR-OPS Subpart K-L | Revised rule text

No.	Parameter
11c	Lateral cyclic pitch
11d	Tail rotor pedal
11e	Controllable stabilator
11f	Hydraulic selection
12	Hydraulics low pressure
13	Outside air temperature.
14	AFCS mode and engagement status
15	Stability augmentation system engagement
16	Main gear box oil pressure
17	Main gear box oil temperature
18	Yaw rate or yaw acceleration
19	Indicated sling load force (if installed)
20	Longitudinal acceleration (body axis)
21	Lateral acceleration
22	Radio altitude
23	Vertical beam deviation (ILS glide path or MLS elevation)
24	Horizontal beam deviation (ILS localiser or MLS azimuth)
25	Marker beacon passage
26	Warnings
27	Reserved (Nav receiver frequency selection is recommended)
28	Reserved (DME distance is recommended)
29	Reserved (navigation data is recommended)
30	Landing gear or gear selector position

Table C – Helicopters equipped with electronic display systems

JAR-OPS Subpart K-L | Revised rule text

€	Parameter
6	Selected barometric setting (Each pilot station)
7	Selected altitude
8	Selected speed
9	Selected mach
10	Selected vertical speed
11	Selected heading
12	Selected flight path
13	Selected decision height
14	EFIS display format
15	Multi function /Engine / Alerts display format

Appendix 1 to JAR OPS 3.775 Supplemental Oxygen for non-pressurised Helicopters

Table 1

(a)	(b)
SUPPLY FOR:	DURATION AND PRESSURE ALTITUDE
1. All occupants of flight deck seats on flight deck duty	Entire flight time at pressure altitudes above 10 000 ft.
2. All required cabin crew members	Entire flight time at pressure altitudes above 13 000 ft and for any period exceeding 30 minutes at pressure altitudes above 10 000 ft but not exceeding 13 000 ft.
3. 100% of passengers (See Note)	Entire flight time at pressure altitudes above 13 000 ft.
4. 10% of passengers(See Note)	Entire flight time after 30 minutes at pressure altitudes greater than 10 000 ft but not exceeding 13 000 ft.

Note: For the purpose of this table 'passengers' means passengers actually carried and includes infants under the age of 2.

Formatted: Heading 5;Sub-titles

Comment [DDE40]: Included in CAT.IDE.H.240

JAR-OPS Subpart K-L | Revised rule text

~~[Appendix 1 to JAR OPS 3.830 Emergency Locator Transmitter (ELT(S))]~~

~~(See JAR OPS 3.380 and JAR OPS 3.835)~~

- ~~(a) All ELT(S) shall be capable of transmitting simultaneously on 121.5 MHz and 406 MHz, be coded in accordance with ICAO Annex 10 and be registered with the national agency responsible for initiating Search and Rescue, or another nominated agency.~~

Comment [DDE41]: First part moved to IR above and second part to AMC

Formatted: Heading 5;Sub-titles

JAR-OPS Subpart K-L | Revised rule text

Subpart D – Instrument, Data, Equipment

Section 2 - Helicopters

GM1-CAT.IDE.H.100-(a) Instruments and equipment – General

APPROVED EQUIPMENT

The equipment approval in **CAT.IDE.H.100** ~~OPS-GEN.400(b)~~ means that the equipment should have an authorisation (e.g. European ~~t~~Technical ~~s~~Standards ~~o~~Order (ETSO) authorisation) or an approval in accordance with **Regulation (EC) No 1702/2003** ~~Part-21~~.

GM-1-CAT.IDE.H.100-(c) Instruments and equipment – General

INSTRUMENTS AND EQUIPMENT ~~WHICH~~ **THAT** DO NOT NEED TO BE APPROVED IN ACCORDANCE WITH **REGULATION (EC) NO 1702/2003** ~~PART-21~~, BUT ~~IS~~ **ARE** CARRIED ON A FLIGHT

1. The provision of this paragraph does not exempt the item of equipment from complying with **Regulation (EC) No 1702/2003** ~~Part-21~~ if the instrument or equipment is installed in the ~~aircraft~~ **helicopter**. In this case, the installation should be approved as required in **Regulation (EC) No 1702/2003** ~~Part-21~~ and should comply with the applicable airworthiness codes **as required under that Regulation**.
2. The functionality of non-installed instruments and equipment required by ~~Part-OPS-CAT~~ **this Part** ~~which~~ **that** do not need an equipment approval should be checked against recognised industry standards appropriated for the intended purpose. The operator is responsible for ensuring the maintenance of these instruments and equipment.
3. The failure of additional non-installed instruments or equipment not required by ~~Part-OPS~~ **this Part** or the airworthiness codes **as required under Regulation (EC) No 1702/2003** or any applicable airspace requirements should not adversely affect the airworthiness and/or the safe operation of the aircraft. Examples are the following:
 - a. ~~i~~nstruments supplying additional flight information (e.g. stand-alone Global Positioning System (GPS));
 - b. ~~Some aerial work~~ **mission dedicated** equipment (e.g. ~~some mission dedicated~~ radios, ~~wire cutters~~); **and**
 - c. ~~n~~Non-installed passenger entertainment equipment.

~~GM2-OPS-GEN.400(c) Instruments and equipments – General~~

~~LIST OF NON-APPROVED EQUIPMENT~~

~~The following items are typical examples of equipment which do not need an equipment approval:~~

- ~~1. Electric torch;~~
- ~~2. Accurate time piece;~~

JAR-OPS Subpart K-L | Revised rule text

- ~~3. Child restraint devices~~
- ~~4. Chart holder;~~
- ~~5. First aid kits;~~
- ~~6. Megaphones;~~
- ~~7. Survival and signalling equipment;~~
- ~~8. Sea anchors and equipment for mooring. GM OPS.GEN.400(e) Instruments and equipments - General~~

GM1-CAT.IDE.H.100(e) Instruments and Equipments - General~~ACCESSIBILITY AND POSITIONING OF INSTRUMENTS AND EQUIPMENT~~

This requirement implies that whenever a single instrument is required in a ~~aircraft~~ **helicopter** operated in a multi-crew environment, the instrument needs to be visible from each flight crew station.

GM1-CAT.IDE.H.110 Spare electrical fuses

FUSES

A spare electrical fuse means a replaceable fuse in the ~~cockpit~~ **flight crew compartment**, not an automatic circuit breaker, or circuit breakers in the electric compartments.

~~GM CAT.IDE.H.205 Operating lights~~~~NAVIGATION LIGHTS~~

~~Specifications for navigation lights are contained in Appendix 1 to International Civil Aviation Organization (ICAO) Annex 6, Part II.~~

AMC1-CAT.IDE.H.115 Operating lights

LANDING LIGHT

The landing light should be trainable, at least in the vertical plane.

~~**AMC-AMC1-CAT.IDE.H.125&CAT.IDE.H.130 Day VFR operations – Flight and navigational instruments and associated equipment and CAT.IDE.H.130 IFR or night operations – Flight and navigational instruments and associated equipment**~~

INTEGRATED INSTRUMENTS

1. Individual equipment requirements may be met by combinations of instruments or by integrated flight systems or by a combination of parameters on electronic displays, provided that the information so available to each required pilot is not less than the required in the applicable operational requirements, and the equivalent safety of the installation has been shown during type certification approval of the aircraft for the intended type of operation.

Comment [GC142]: From AMC OPS 3.650/3.652

JAR-OPS Subpart K-L | Revised rule text

2. The means of measuring and indicating ~~turn-and-slip, aircraft~~ **helicopter** attitude and stabilised ~~aircraft~~ **helicopter** heading may be met by combinations of instruments or by integrated flight director systems, provided that the safeguards against total failure, inherent in the three separate instruments, are retained.

AMC1-CAT.IDE.H.125-(a)(1)-&CAT.IDE.H.130-(a)(1) Day VFR operations and IFR or night operations – Flight and navigational instruments and associated equipment and CAT.IDE.H.130 (a)(1) IFR or night operations — Flight and navigational instruments and associated equipment

MEANS OF MEASURING AND DISPLAYING MAGNETIC DIRECTION

The means of measuring and displaying magnetic direction should be a magnetic compass **or equivalent**.

AMC1-CAT.IDE.H.125-(a)(2)-&CAT.IDE.H.130-(a)(2) Day VFR operations and IFR or night operations – Flight and navigational instruments and associated equipment and CAT.IDE.H.130 (a)(2) IFR or night operations — Flight and navigational instruments and associated equipment

MEANS FOR MEASURING AND DISPLAYING THE TIME

1. ~~For other than complex motor-powered aircraft not involved in commercial operations, a means of measuring and displaying the time in hours, minutes and seconds may be a wrist watch capable of the same functions.~~
2. ~~For complex motor-powered aircraft, an~~ An acceptable means of compliance with OPS.GEN.410 CAT.IDE.H.215(a)(2) and CAT.IDE.H.220(a)(2) ~~should be considered to be~~ is a clock displaying hours, minutes and seconds, with a sweep-second pointer or digital presentation.

AMC1-CAT.IDE.H.125-(a)(3)-&CAT.IDE.H.130(b) Day VFR operations and IFR or night operations – Flight and navigational instruments and associated equipment and CAT.IDE.H.130 (b) IFR or night operations — Flight and navigational instruments and associated equipment

CALIBRATION OF THE MEANS FOR MEASURING AND DISPLAYING PRESSURE ALTITUDE

1. ~~The instrument measuring and displaying pressure altitude should be~~ **of a sensitive type** calibrated in feet (ft), with a sub-scale setting, calibrated in hectopascals/millibars, adjustable for any barometric pressure likely to be set during flight.

JAR-OPS Subpart K-L | Revised rule text

AMC-1 CAT.IDE.H.125-(a)(4)&CAT.IDE.H.130(a)(3) Day VFR operations and IFR or night operations – Flight and navigational instruments and associated equipment and ~~CAT.IDE.H.130 (a)(3) IFR or night operations – Flight and navigational instruments and associated equipment~~CALIBRATION OF THE INSTRUMENT INDICATING AIR—SPEED—~~SAILPLANES, AEROPLANES AND HELICOPTERS~~

The instrument indicating air-speed should be calibrated in knots (kt).~~In the case of sailplanes with a maximum certificated take off mass below 2 000 kg and aeroplanes other than complex motor powered aeroplanes or helicopters with a maximum certificated take off mass below 2 000 kg, calibration in kilometres (km) per hour or in miles per hours (MPH) is acceptable.~~

Comment [GCI43]: From AMC OPS 3.650(g) & 3.652(k)

AMC1-CAT.IDE.H.125-(b)(1) & CAT.IDE.H.130-(c)(1) Day VFR operations and IFR or night operations – Flight and navigational instruments and associated equipment and ~~CAT.IDE.H.130 (c)(1) IFR or night operations – Flight and navigational instruments and associated equipment~~

OUTSIDE AIR TEMPERATURE

1. The means of displaying outside air temperature should be calibrated in degrees Celsius.
2. The means of displaying outside air temperature may be an air temperature indicator ~~which~~ **that** provides indications that are convertible to outside air temperature.

AMC1-CAT.IDE.A.125 (c)&CAT.IDE.A.130 (h) Day VFR operations – Flight and navigational instruments and associated equipment and ~~CAT.IDE.A.130 (h) IFR or night operations – Flight and navigational instruments and associated equipment~~

MULTI-PILOT OPERATIONS - DUPLICATE INSTRUMENTS

Duplicate instruments **should** include separate displays for each pilot and separate selectors or other associated equipment where appropriate.

AMC1-CAT.IDE.H.125-(d)(2)-&CAT.IDE.H.130(a)(7) Day VFR operations and IFR or night operations – Flight and navigational instruments and associated equipment and ~~CAT.IDE.H.130 (a)(7) IFR or night operations – Flight and navigational instruments and associated equipment~~

MEANS OF MEASURING AND DISPLAYING DIRECTION

~~heading~~Direction should be measured and displayed for **visual flight rules** VFR flights by a stabilised gyroscopic direction indicator, ~~whereas~~ for **instrument flight rules** IFR flights, ~~–~~this should be achieved through a magnetic stabilised gyroscopic direction indicator.

AMC1-CAT.IDE.H.125-(e)-&CAT.IDE.H.130(d) Day VFR operations and IFR or night operations – Flight and navigational instruments and associated

JAR-OPS Subpart K-L | Revised rule text

equipment and ~~CAT.IDE.H.130 (d) IFR or night operations~~ — Flight and navigational instruments and associated equipment

MEANS OF PREVENTING MALFUNCTION DUE TO CONDENSATION OR ICING

The means of preventing malfunction due to either condensation or icing of the airspeed indicating system should be a heated pitot tube or equivalent.

Comment [GCI44]: From AMC OPS 3.652(d) & (m)(2)

AMC1-CAT.IDE.H.130-(e) IFR or night operations – Flight and navigational instruments and associated equipment

~~MEANS OF INDICATING PITOT HEATER FAILURE~~ **OF THE MEANS OF PREVENTING MALFUNCTION DUE TO EITHER CONDENSATION OR ICING OF THE AIRSPEED INDICATING SYSTEM**

A combined means of indicating **failure of the means of preventing malfunction due to either condensation or icing of the airspeed indicating system** ~~pitot heater failure~~ is acceptable provided that is visible from each flight crew station and that there **it** is a means to identify the failed heater in systems with two or more sensors.

AMC1-CAT.IDE.H.130-(f) IFR or night operations – Flight and navigational instruments and associated equipment

~~STANDBY ATTITUDE ALTITUDE INDICATOR~~

1. —The means of measuring and displaying standby attitude should:

- 12.** be powered continuously during normal operation and, in the event of a total failure of the normal electrical generating system, be powered from a source independent of the normal electrical generating system;
- 23.** be **capable of being used from either pilot's station;**
- 34.** operates independently of ~~any other attitude indicating system~~ **other means of measuring and displaying attitude;**
- 45.** be operative ~~continue to operate~~ automatically after total failure of the normal electrical generating system;
- 56.** provide reliable operation for a minimum of 30 minutes or the time required to fly to a suitable alternate landing site, when operating over hostile terrain, or offshore, whichever is ~~the~~ greater, after total failure of the normal electrical generating system, taking into account other loads on the emergency power supply and operational procedures;
- 67.** be appropriately illuminated during all phases of operation; and
- 87.** be associated with a means to indicate to the flight crew when operating under its dedicated power supply.

JAR-OPS Subpart K-L | Revised rule text

AMC1-CAT.IDE.H.130-(i) IFR or night operations – Flight and navigational instruments and associated equipment

CHART HOLDER

An acceptable means of compliance with the chart holder requirement ~~would be~~ to display a pre-composed chart on an ~~e~~Electronic ~~f~~Flight ~~b~~Bag (EFB).

~~GM1-CAT.IDE.H.125&CAT.IDE.H.130 Day VFR operations and IFR or night operations – Flight and navigational instruments and associated equipment and CAT.IDE.H.130 IFR or night operations – Flight and navigational instruments and associated equipment~~

Comment [GCI45]: Table from ACJ OPS 3.650/3.652

GENERAL

~~Table 1: H-GM-OPS-CAT.410 & 415 – Helicopters~~ Flight and navigational instruments and associated equipment

SERIAL		FLIGHTS UNDER VFR		FLIGHTS UNDER IFR OR AT NIGHT	
		SINGLE PILOT	TWO PILOTS REQUIRED	SINGLE PILOT	TWO PILOTS REQUIRED
INSTRUMENT		(b)	(c)	(e)	(f)
1	Magnetic direction compass	1	1	1	1
2	Accurate time piece	1	1	1	1
3	Sensitive Pressure altitude altimeter	1	2	2 Note (1)	2
4	Indicated Air-speed indicator	1	2	1	2
5	Vertical speed indicator	1	2	1	2
6	Slip indicator	1	2	1	2
7	Attitude indicator	1 Note (2)	2 Note(2)	1	2
8	Stabilised Gyroscopic direction indicator	1 Note (2)	2 Note(2)	1	2
9	Outside air temperature OAT indicator	1	1	1	1

JAR-OPS Subpart K-L | Revised rule text

SERIAL		FLIGHTS UNDER VFR		FLIGHTS UNDER IFR OR AT NIGHT	
10	Airspeed Heated pitot system icing protection	1 Note (3)	2 Note (3)	1	2
11	Airspeed Pitot heat failure indicator icing protection Pitot indicating			1 Note (4)	2 Note (4)
12	Static pressure source			2	2
13	Standby attitude indicator			1 Note (5)	1 Note (5)
14	Chart Holder			1 Note (6)	1 Note (6)

Note(1) For single pilot night operation under VFR, one means of measuring and displaying sensitive pressure altimeter altitude may be substituted by a means of measuring and displaying radio altimeter altitude.

Note (2) Applicable only to helicopters with a maximum certified take-off mass ~~exceeding of more than~~ **3 175 kg**; or helicopters operated over water when out of sight of land or when the visibility is less than 1 500 m.

Note(3) Applicable only to helicopters with an **MCTOM** ~~maximum certified take-off mass exceeding of more than~~ **3 175 kg**, or with a ~~maximum passenger seating configuration~~ **an MPSC** of more than 9.

Note(4) The pitot heater failure annunciation applies to any helicopter issued with an individual ~~Certificate of Airworthiness~~ **C of A** on or after 1 August 1999. It also applies before that date when: the helicopter has a MCTOM ~~greater of more than~~ **3 175 kg** and a ~~maximum approved passenger seating configuration (MAPSC)~~ **greater of more than** ~~than~~ **nine**.

Note (5) For helicopters with an ~~maximum certified take-off mass (MCTOM) exceeding of more than~~ **3 175 kg**, CS-29 1303(g) may require either a gyroscopic rate-of-turn indicator combined with a slip-skid indicator (turn and bank indicator) or a standby attitude indicator satisfying the requirements. ~~(However~~ **In any case**, the original type certification standard should be referred to determine the exact requirement.)

Note (6) Applicable only to helicopters operating under IFR.

AMC1-CAT.IDE.H.145 Radio altimeters**AUDIO VOICE ALERTING DEVICE**

The audio warning required in ~~OPS.CAT.H.418~~ **CAT.IDE.H.145** should be a voice warning.

*JAR-OPS Subpart K-L | Revised rule text***AMC1-CAT.IDE.H.160 Airborne weather detecting equipment**

GENERAL

The airborne weather detecting equipment should be an airborne weather radar.

AMC1-CAT.IDE.H.170 Flight crew interphone system

TYPE OF FLIGHT CREW INTERPHONE

The flight crew interphone system should not be of a handheld type.

AMC1-CAT.IDE.H.175 Crew member interphone system

Comment [GCI46]: From AMC OPS 3.690(b)(6)

CHARACTERISTICS SPECIFICATIONS

The crew member interphone system should:

1. ~~o~~ Operate independently of the public address system except for handsets, headsets, microphones, selector switches and signalling devices;
2. **be readily accessible for use at required cabin crew stations close to each separate or pair of floor level emergency exits;**
3. **have an alerting system incorporating aural or visual signals for use by flight and cabin crew;**
5. ~~Have an alerting system incorporating aural or visual signals for use by flight crew members to alert the cabin crew and for use by cabin crew members to alert the flight crew;~~
6. **Have a means for the recipient of a call to determine whether it is a normal call or an emergency call as following which uses:**
 - a. ~~I~~ights of different colours;
 - b. ~~c~~odes defined by the operator (e.g. different number of rings for normal and emergency calls);
 - c. ~~a~~ny other indicating signal acceptable to the competent authority responsible for type certification or supplemental type certification **in the operations manual;**
5. **provide a means of two-way communication between the flight crew compartment and each crew member station;; and**
6. **be readily accessible for use from each required flight crew stations in the flight crew compartment.**

AMC1-CAT.IDE.A.180 Public address system

CHARACTERISTICS SPECIFICATIONS

The public address system should:

1. ~~o~~ Operate independently of the interphone systems except for handsets, headsets, microphones, selector switches and signalling devices;

JAR-OPS Subpart K-L | Revised rule text

2. ~~bBe~~ readily accessible for immediate use from each required from each required flight crew station;
3. ~~hHave~~, for each floor level passenger emergency exit which has an adjacent cabin crew seat, a microphone operable by the seated cabin crew member, except that one microphone may serve more than one exit, provided the proximity of exits allows unassisted verbal communication between seated cabin crew members;
4. ~~bBe~~ operable within 10 seconds by a cabin crew member at each of those stations;
5. ~~bBe~~ audible at all passenger seats, toilets, cabin crew seats and work stations; **and**
6. ~~In the case of helicopters,~~ following a total failure of the normal electrical generating system, provide reliable operation for a minimum of 10 minutes.

AMC1-CAT.IDE.H.185 Cockpit voice recorder

GENERAL

1. ~~The CVR should, with reference to a timescale, record:~~
 - a. ~~flight crew members' two way voice communications by radio, interphone system and public address system, if installed;~~
 - b. ~~the aural environment of the cockpit, including, where practicable, without interruption, the microphone audio signals; and~~
 - c. ~~voice or audio signals identifying navigation or approach aids introduced into a headset or speaker.~~
 2. ~~The operational performance requirements for CVRs should be those laid down in EUROCAE Documents ED56 or ED56A (Minimum Operational Performance Requirements For Cockpit Voice Recorder Systems) dated February 1988 and December 1993 respectively.~~
- 2-The operational performance requirements for **cockpit voice recorders** CVRs should be those laid down in EUROCAE Document ED-112 (Minimum Operational Performance Specification for Crash Protected Airborne Recorder Systems) dated **March** 2003.

AMC1-CAT.IDE.H.190 Flight data recorder

LIST OF PARAMETERS TO BE RECORDED FOR HELICOPTERS HAVING AN MCTOM EXCEEDING **OF MORE THAN 3 175 KG** AND FIRST ISSUED WITH AN INDIVIDUAL CERTIFICATE OF AIRWORTHINESS **OF A** ON OR AFTER 1 JANUARY 2016~~2010~~

1. The **flight data recorder (FDR)** should, with reference to a timescale, record:
 - a. the parameters listed in Table 1 ~~of AMC1-CAT.IDE.H.190~~ **below**;
 - b. the additional parameters listed in Table 2 ~~below of AMC1CAT.IDE.H.190,~~ when the information data source for the parameter is used by helicopter systems or is available on the instrument panel for use by the flight crew to operate the helicopter; and
 - c. any dedicated parameters related to novel or unique design or operational characteristics of the helicopter as determined by the Agency.

JAR-OPS Subpart K-L | Revised rule text

2. The FDR parameters should meet, as far as practicable, the performance specifications (designated ranges, sampling intervals, accuracy limits and minimum resolution in read-out) defined in ~~The FDR should meet the operational performance requirements and specifications of EUROCAE Document ED-112 (Minimum Operational Performance Specification for Crash Protected Airborne Recorder Systems) dated March 2003 and Attachment B of ICAO Annex 6, Part III.~~
3. FDR systems for which ~~the~~ **some** recorded parameters do not meet the performance specifications of EUROCAE Document ED-112 (i.e. range, sampling intervals, accuracy limits and recommended resolution readout) could be acceptable to the Agency.

Table 1: of AMC1-CAT.IDE.H.190 FDR – All helicopters

No.*	Parameter
1	Time or relative time count
2	Pressure altitude
3	Indicated air-speed
4	Heading
5	Normal acceleration
6	Pitch attitude
7	Roll attitude
8	Manual radio transmission keying CVR/FDR synchronisation reference
9	Power on each engine
9a	Free power turbine speed (N _F)
9b	Engine torque
9c	Engine gas generator speed (N _G)
9d	Cockpit power control position
9e	Other parameters to enable engine power to be determined
10a	Main rotor speed
10b	Rotor brake (if installed)
11	Primary flight controls – Pilot input and/or control output position (if applicable)
11a	Collective pitch
11b	Longitudinal cyclic pitch
11c	Lateral cyclic pitch

JAR-OPS Subpart K-L | Revised rule text

No.*	Parameter
11d	Tail rotor pedal
11e	Controllable stabilator (if applicable)
11f	Hydraulic selection
12	Hydraulics low pressure (each system should be recorded.)
13	Outside air temperature
18	Yaw rate or yaw acceleration
20	Longitudinal acceleration (body axis)
21	Lateral acceleration
25	Marker beacon passage
26	Warnings - a discrete should be recorded for the master warning, gearbox low oil pressure and sas failure. other 'red' warnings should be recorded where the warning condition cannot be determined from other parameters or from the cockpit voice recorder.
27	Each navigation receiver frequency selection
37	Engine control modes

* The number in the left hand column reflects the serial numbers depicted in EUROCAE ED-112

Table 2: of AMC1-CAT.IDE.H.190

Helicopters for which the information data source for the parameter is either used by helicopter systems or is available on the instrument panel for use by the flight crew to operate the helicopter

No.*	Parameter
14	AFCS mode and engagement status
15	Stability augmentation system engagement (each system should be recorded)
16	Main gear box oil pressure
17	Gear box oil temperature
17a	Main gear box oil temperature
17b	Intermediate gear box oil temperature
17c	Tail rotor gear box oil temperature
19	Indicated sling load force (if signals readily available)
22	Radio altitude

JAR-OPS Subpart K-L | Revised rule text

No.*	Parameter
23	Vertical deviation - the approach aid in use should be recorded.
23a	ILS glide path
23b	MLS elevation
23c	GNSS approach path
24	Horizontal deviation - the approach aid in use should be recorded.
24a	ILS localiser
24b	MLS azimuth
24c	GNSS approach path
28	DME 1 & 2 distances
29	Navigation data
29a	Drift angle
29b	Wind speed
29c	Wind direction
29d	Latitude
29e	Longitude
29f	Ground speed
30	Landing gear or gear selector position
31	Engine exhaust gas temperature (T ₄)
32	Turbine Inlet Temperature (TIT/ITT)
33	Fuel contents
34	Altitude rate (vertical speed) - only necessary when available from cockpit instruments
35	Ice detection
36	Helicopter Health and Usage Monitor System (HUMS) - only when information from the HUMS is used by the crew or aircraft system
36a	Engine data
36b	Chip detector
36c	Track timing
36d	Exceedance discretises
36e	Broadband average engine vibration
38	Selected barometric setting - to be recorded for helicopters where the parameter is displayed

JAR-OPS Subpart K-L | Revised rule text

No.*	Parameter
	electronically
38a	Pilot
38b	First officer Co-pilot
39	Selected altitude (all pilot selectable modes of operation) - to be recorded for the helicopters where the parameter is displayed electronically
40	Selected speed (all pilot selectable modes of operation) - to be recorded for the helicopters where the parameter is displayed electronically
41	Selected Mach (all pilot selectable modes of operation) - to be recorded for the helicopters where the parameter is displayed electronically Not used (selected mach)
42	Selected vertical speed (all pilot selectable modes of operation) - to be recorded for the helicopters where the parameter is displayed electronically
43	Selected heading (all pilot selectable modes of operation) - to be recorded for the helicopters where the parameter is displayed electronically
44	Selected flight path (all pilot selectable modes of operation) - to be recorded for the helicopters where the parameter is displayed electronically
45	Selected decision height (all pilot selectable modes of operation) - to be recorded for the helicopters where the parameter is displayed electronically
46	EFIS display format
47	Multi-function/engine/alerts display format
48	event marker

* The number in the left hand column reflects the serial numbers depicted in EUROCAE ED-112

AMC2--CAT.IDE.H.190 Flight data recorder

LIST OF PARAMETERS TO BE RECORDED FOR HELICOPTERS HAVING AN MCTOM ~~EXCEEDING OF MORE THAN 3 175 KG AND FIRST ISSUED WITH AN INDIVIDUAL CERTIFICATE OF AIRWORTHINESS~~ **SC OF A ON OR AFTER 1 AUGUST 1999 AND BEFORE 1 JANUARY 2016** ~~AFTER 31 JULY 1999~~ AND HELICOPTERS HAVING AN MCTOM ~~EXCEEDING OF MORE THAN 7 000 KG OR AN MPSC MAXIMUM APPROVED PASSENGER SEATING CONFIGURATION OF MORE THAN 9~~ **NINE** AND FIRST ISSUED WITH AN INDIVIDUAL CERTIFICATE OF AIRWORTHINESS **SC OF A ON OR AFTER 1 JANUARY 1989 AND BEFORE 1 AUGUST 1999** ~~AFTER 31 DECEMBER 1988~~

1. The ~~flight data recorder~~ **FDR** should, with reference to a timescale, record:
 - a. for helicopters with ~~a~~ **An MCTOM maximum certified take-off mass** between 3 175 kg and 7 000 kg the parameters listed in Table 1 ~~of AMC2-CAT.IDE.H.190~~ below;

JAR-OPS Subpart K-L | Revised rule text

- b. for helicopters with an **MCTOM** ~~maximum certificated take-off mass exceeding~~ **of more than** 7 000 kg the parameters listed in Table 2 ~~AMC2CAT.IDE.H.190~~ below;
 - c. ~~any dedicated parameters relating to novel or unique design or operational characteristics of the helicopter; and~~
 - dc. **for helicopters equipped with electronic display systems**, the **additional** parameters listed in Table 3 ~~AMC2CAT.IDE.H.190~~ below, **and** ~~for helicopters equipped with electronic display systems.~~
 - d. **any dedicated parameters relating to novel or unique design or operational characteristics of the helicopter.**
2. When determined by **the Agency**, the ~~flight data recorder~~ **FDR** of helicopters with a maximum certificated take-off mass ~~exceeding~~ **of more than** 7 000 kg does not need to record parameter 19 of Table 2 ~~CAT.IDE.H.190~~ below, if any of the following conditions are met:
 - a. ~~t~~The sensor is not available; ~~and~~or
 - b. ~~a~~A change is required in the equipment that generates the data.
 3. Individual parameters that can be derived by calculation from the other recorded parameters, need not to be recorded, if agreed by the ~~Agency~~ **competent authority**.
 4. The parameters should meet, as far as practicable, the performance specifications (~~designated~~ ranges, sampling intervals, accuracy limits and ~~minimum~~ resolution in read-out) defined in **AMC3-CAT.IDE.H.190**. ~~the relevant tables of EUROCAE Minimum Operational Performance Specification for Flight Data Recorder Systems, Document ED 55 dated May 1990. The remarks columns of those tables are acceptable means of compliance to the parameter specifications.~~
 5. ~~Table 1 AMC2 CAT.IDE.H.270 refers to EUROCAE document ED 55 Table A1 4, Table 2 AMC2 CAT.IDE.H.270 refers to ED 55 Table A1 2 and Table 3 AMC2 CAT.IDE.H.270 refers to ED 55 Table A1 5 parameters 6 to 15.~~
 5. If recording capacity is available, as many of the additional parameters **as possible** ~~specified in~~ **specified in table II-A.2 of EUROCAE Document ED 112 dated March 2003** ~~Table A1.5 of Document ED 55 dated May 1990 as possible~~ should be recorded.
 6. For the purpose of this AMC a sensor is considered "readily available" when it is already available or can be easily incorporated.
 8. ~~The term 'where practicable' used in the remarks column of Table 3 means that account should be taken of the following:~~
 - a. ~~If the sensor is already available or can be easily incorporated;~~
 - b. ~~Sufficient capacity is available in the flight recorder system;~~
 - c. ~~For navigational data (nav frequency selection, DME distance, latitude, longitude, groundspeed and drift) the signals are available in digital form;~~
 - d. ~~The extent of modification required;~~
 - e. ~~The down time period;~~

JAR-OPS Subpart K-L | Revised rule text

f. ~~Equipment software development.~~**Table 1: ~~of AMC2-CAT.IDE.H.190~~****Helicopters with an MCTOM ~~maximum certificated take-off mass of 7 000 kg or less~~**

No.	Parameter
1	Time or relative time count
2	Pressure altitude
3	Indicated airspeed
4	Heading
5	Normal acceleration
6	Pitch attitude
7	Roll attitude
8	Manual radio transmission keying
9	Power on each engine (free power turbine speed and engine torque)/cockpit power control position (if applicable)
10a	Main rotor speed
10b	Rotor brake (if installed)
11	Primary flight controls - Pilot input and control output position (if applicable)
11a	Collective pitch
11b	Longitudinal cyclic pitch
11c	Lateral cyclic pitch
11d	Tail rotor pedal
11e	Controllable stabilator
11f	Hydraulic selection
12	Warnings
13	Outside air temperature
14	Autopilot engagement status
15	Stability augmentation system engagement
26	Warnings

Comment [GCI47]: renumbered for consistency with table 2 of AMC 2

JAR-OPS Subpart K-L | Revised rule text

Table 2: of ~~AMC2-CAT.IDE.H.190~~**Helicopters with an MCTOM ~~maximum certified take-off mass of exceeding~~ more than 7 000 kg**

No.	Parameter
1	Time or relative time count
2	Pressure altitude
3	Indicated airspeed
4	Heading
5	Normal acceleration
6	Pitch attitude
7	Roll attitude
8	Manual radio transmission keying
9	Power on each engine (free power turbine speed and engine torque)/cockpit power control position (if applicable)
10a	Main rotor speed
10b	Rotor brake (if installed)
11	Primary flight controls - Pilot input and control output position (if applicable)
11a	Collective pitch
11b	Longitudinal cyclic pitch
11c	Lateral cyclic pitch
11d	Tail rotor pedal
11e	Controllable stabilator
11f	Hydraulic selection
12	Hydraulics low pressure
13	Outside air temperature
14	AFCS mode and engagement status
15	Stability augmentation system engagement
16	Main gear box oil pressure
17	Main gear box oil temperature

JAR-OPS Subpart K-L | Revised rule text

No.	Parameter
18	Yaw rate or yaw acceleration
19	Indicated sling load force (if installed)
20	Longitudinal acceleration (body axis)
21	Lateral acceleration
22	Radio altitude
23	Vertical beam deviation (ILS glide path or MLS elevation)
24	Horizontal beam deviation (ILS localiser or MLS azimuth)
25	Marker beacon passage
26	Warnings
27	Reserved (Nav receiver frequency selection is recommended)
28	Reserved (DME distance is recommended)
29	Reserved (navigation data is recommended)
30	Landing gear or gear selector position

**Table 3: ~~of AMC2-CAT.IDE.H.190~~
Helicopters equipped with electronic display systems**

No.	Parameter
6 38	Selected barometric setting (Each pilot station)
7 39	Selected altitude
8 40	Selected speed
9 41	Selected mach
10 42	Selected vertical speed
11 43	Selected heading
12 44	Selected flight path
13 45	Selected decision height
14 46	EFIS display format

JAR-OPS Subpart K-L | Revised rule text

1547 | Multi function /Engine / Alerts display format

AMC3--CAT.IDE.H.190 Flight dData rRecorder

PERFORMANCE SPECIFICATIONS FOR THE PARAMETERS TO BE RECORDED FOR HELICOPTERS HAVING AN MCTOM OF MORE THAN 3 175 KG AND FIRST ISSUED WITH AN INDIVIDUAL ~~CERTIFICATE OF AIRWORTHINESS~~ **SC OF A ON OR AFTER 1 AUGUST 1999 AND BEFORE 1 JANUARY 2016** AND HELICOPTERS HAVING AN MCTOM OF MORE THAN 7 000 KG OR A ~~MAXIMUM PASSENGER SEATING CONFIGURATION~~ **AN MPSC OF MORE THAN 9--NINE** AND FIRST ISSUED WITH AN INDIVIDUAL ~~CERTIFICATE OF AIRWORTHINESS~~ **SC OF A ON OR AFTER 1 JANUARY 1989 AND BEFORE 1 AUGUST 1999**

JAR-OPS Subpart K-L | Revised rule text

**Table 1: of ~~AMC3-CAT.IDE.H.190~~
Helicopters with an MCTOM ~~maximum certified take-off mass~~ of 7 000 kg or less**

No.	Parameter	Range	Sampling interval in seconds	Accuracy Limits (sensor input compared to FDR read out)	Minimum Resolution in read out	Remarks
1	Time or relative time count					
1a or	Time	24 hours	4	± 0.125 % per hour	1 second	(a) UTC time preferred where available.
1b	Relative Time Count	0 to 4 095	4	± 0.125 % per hour		(b) Counter increments every 4 seconds of system operation.
2	Pressure altitude	-1 000 ft to 20 000 ft	1	±100 ft to ±700 ft Refer to table II.A-2 of EUROCAE Document ED-112	25 ft	
3	Indicated airspeed	As the installed measuring system	1	± 5 % or ± 10 kt, whichever is greater	1 kt	
4	Heading	360 °	1	± 5°	1 °	
5	Normal acceleration	- 3 g to + 6 g	0.125	± 0.2 g in addition to a maximum offset of ± 0.3 g	0.01 g	The resolution may be rounded from 0.01 g to 0.05 g, provided that one sample is recorded at full resolution at least every 4 seconds.
6	Pitch attitude	100 % of usable range	0.5	± 2 degrees	0.8 degree	

Comment [GCI48]: Added for consistency with table 1 of AMC 2

JAR-OPS Subpart K-L | Revised rule text

No.	Parameter	Range	Sampling interval in seconds	Accuracy Limits (sensor input compared to FDR read out)	Minimum Resolution in read out	Remarks
7	Roll attitude	± 60 ° or 100 % of usable range from installed system if greater	0.5	± 2 degrees	0.8 degree	.
8	Manual radio transmission keying	Discrete(s)	1	-	-	Preferably each crew member but one discrete acceptable for all transmissions.
9	Power on each engine	Full range	Each engine each second	± 5 %	1 % of full range	Sufficient parameters e.g. Power Turbine Speed and Engine Torque should be recorded to enable engine power to be determined. A margin for possible overspeed should be provided. Data may be obtained from cockpit indicators used for aircraft certification. Parameter 9c is required for helicopters with non mechanically linked cockpit-engine controls
9a	Power Turbine Speed	Maximum range				
9b	Engine Torque	Maximum range				
9c	Cockpit Power Control position	Full range or each discrete position	Each control each second	±2 % or sufficient to determine any gated position	2 % of full range	
10	Rotor					
10a	Main rotor speed	Maximum range	1	± 5 %	1 % of full range	
10b	Rotor brake	Discrete	1	-		Where available
11	Primary flight controls - Pilot input and/or* control output position	Full Range				* For helicopters that can demonstrate the capability of deriving either the control input

JAR-OPS Subpart K-L | Revised rule text

No.	Parameter	Range	Sampling interval in seconds	Accuracy Limits (sensor input compared to FDR read out)	Minimum Resolution in read out	Remarks
11a	Collective pitch		0.5	± 3 %	1 % of full range	or control movement (one from the other) for all modes of operation and flight regimes, the 'or' applies. For helicopters with non-mechanical control systems the 'and' applies. Where the input controls for each pilot can be operated independently, both inputs will need to be recorded.
11b	Longitudinal cyclic pitch		0.5			
11c	Lateral cyclic pitch		0.5			
11d	Tail rotor pedal		0.5			
11e	Controllable stabilator		0.5			
11f	Hydraulic selection	Discretes	1	-	-	
12	Warnings	Discrete(s)	±	-	-	A discrete shall be recorded for the master warning, low hydraulic pressure (each system) gearbox low oil pressure and SAS fault status. Other 'red' warnings should be recorded where the warning condition cannot be determined from other parameters or from the cockpit voice recorder.
13 12	Outside air temperature	Available range from installed system	2	± 2°C	0.3°C	
14 13	Autopilot engagement	Discrete(s)	1			Where practicable, discretes

JAR-OPS Subpart K-L | Revised rule text

No.	Parameter	Range	Sampling interval in seconds	Accuracy Limits (sensor input compared to FDR read out)	Minimum Resolution in read out	Remarks
	status					should show which primary modes are controlling the flight path of the helicopter
15	Stability augmentation system engagement	Discrete(s)	1			
15	Warnings	Discrete(s)	1	-	-	<p>A discrete shall be recorded for the master warning, low hydraulic pressure (each system) gearbox low oil pressure and SAS fault status.</p> <p>Other 'red' warnings should be recorded where the warning condition cannot be determined from other parameters or from the cockpit voice recorder.</p>

Table 2 of ~~AMC3 CAT.IDE.H.190~~Helicopters with an MCTOM ~~maximum certified take-off mass of over~~ more than 7 000 kg

N°	Parameter	Range	Sampling interval in seconds	Accuracy Limits (sensor input compared to FDR read out)	Minimum Resolution in read out	Remarks
1	Time or relative time count					

Comment [GCI49]: Added for consistency with table 2 of AMC 2

JAR-OPS Subpart K-L | Revised rule text

N°	Parameter	Range	Sampling interval in seconds	Accuracy Limits (sensor input compared to FDR read out)	Minimum Resolution in read out	Remarks
1a or	Time	24 hours	4	± 0.125 % per hour	1 second	(a) UTC time preferred where available.
1b	Relative Time Count	0 to 4095	4	± 0.125 % per hour		(b) Counter increments every 4 seconds of system operation.
2	Pressure Altitude	-1 000 ft to maximum certificated altitude of aircraft +5 000 ft	1	± 100 ft to ± 700 ft Refer to table II-A.3 EUROCAE Document ED-112	5 ft	Should be obtained from the air data computer when installed.
3	Indicated Airspeed	As the installed measuring system	1	± 3 %	1 kt	Should be obtained from the air data computer when installed.
4	Heading	360 degrees	1	± 2 degrees	0.5 degree	
5	Normal Acceleration	-3 g to +6 g	0.125	± 1 % of range excluding a datum error of 5 %	0.004 g	The recording resolution may be rounded from 0.004 g to 0.01 g provided that one sample is recorded at full resolution at least every 4 seconds.
6	Pitch Attitude	± 75 degrees	0.5	± 2 degrees	0.5 degree	
7	Roll Attitude	± 180 degrees	0.5	± 2 degrees	0.5 degree	.

JAR-OPS Subpart K-L | Revised rule text

N°	Parameter	Range	Sampling interval in seconds	Accuracy Limits (sensor input compared to FDR read out)	Minimum Resolution in read out	Remarks
8	Manual Radio Transmission Keying and CVR/FDR synchronization reference	Discrete(s)	1	-	-	Preferably each crew member but one discrete acceptable for all transmissions provided that the replay of a recording made by any required recorder can be synchronised in time with any other required recording to within 1 second.
9	Power on each engine	Full range	Each engine each second	± 2 %	0.2 % of full range	Sufficient parameters e.g. Power Turbine Speed and engine torque should be recorded to enable engine power to be determined. A margin for possible overspeed should be provided.
9a	Free Power Turbine Speed (NF)	0-130 %				
9b	Engine Torque	Full range				
9c	Cockpit Power Control position	Full range or each discrete position	Each control each second	± 2 % or sufficient to determine any gated position	2 % of full range	Parameter 9c is required for helicopters with non mechanically linked cockpit-engine controls
10	Rotor				0.3 % of full range	
10a	Main rotor speed	50 to 130 %	0.5	2 %		
10b	Rotor brake	Discrete	1			Where available
11	Primary Flight Controls - Pilot input and/or* control output position					* For helicopters that can demonstrate the capability of deriving either the control input or control movement (one from the other) for all modes of operation and flight regimes, the 'or' applies. For helicopters with non-
11a	Collective pitch	Full range	0.5	± 3 % unless higher accuracy is uniquely required	0.5 % of operating range	
11b	Longitudinal cyclic pitch		0.5			

JAR-OPS Subpart K-L | Revised rule text

N°	Parameter	Range	Sampling interval in seconds	Accuracy Limits (sensor input compared to FDR read out)	Minimum Resolution in read out	Remarks
11c	Lateral cyclic pitch		0.5			mechanical control systems the 'and' applies. Where the input controls for each pilot can be operated independently, both inputs will need to be recorded.
11d	Tail rotor pedal		0.5			
11e	Controllable stabilator		0.5			
11f	Hydraulic selection	Discrete(s)	1	-	-	
12	Hydraulics low pressure	Discrete(s)	1	-	-	Each essential system should be recorded.
13	Outside Air Temperature	-50° to +90°C or available sensor range	2	± 2°C	0.3°C	
14	AFCS mode and engagement status	A suitable combination of discretes	1	-	-	Discretes should show which systems are engaged and which primary modes are controlling the flight path of the helicopter
15	Stability augmentation system engagement	Discrete	1	-	-	
16	Main gearbox oil pressure	As installed	1	As installed	6.895 kN/m ² (1 psi)	
17	Main gearbox oil temperature	As installed	2	As installed	1°C	
18	Yaw rate	± 400 degrees/second	0.25	± 1 %	2 degrees per second	An equivalent yaw acceleration is an acceptable alternative.

JAR-OPS Subpart K-L | Revised rule text

N°	Parameter	Range	Sampling interval in seconds	Accuracy Limits (sensor input compared to FDR read out)	Minimum Resolution in read out	Remarks
19	Indicated sling load force	0 to 200 % of maximum certified load	0.5	± 3 % of maximum certified load	0.5 % for maximum certified load	With reasonable practicability if sling load indicator is installed.
20	Longitudinal Acceleration (body axis)	± 1 g	0.25	±1.5 % of range excluding a datum error of ±5 %	0.004 g	See comment to parameter 5.
21	Lateral Acceleration	± 1 g	0.25	±1.5 % of range excluding a datum error of ±5 %	0.004 g	See comment to parameter 5.
22	Radio Altitude	-20 ft to +2 500 ft	1	As installed. ± 2 ft or ± 3 % whichever is greater below 500 ft and ± 5 % above 500 ft recommended	1 ft below 500 -ft, 1 ft + 0.5 % of full range above 500 ft	
23	Vertical beam deviation		1	As installed ± 3 % recommended	0.3 % of full range	Data from both the ILS and MLS systems need not to be recorded at the same time. The approach aid in use should be recorded.
23a	ILS Glide Path	± 0.22 DDM or available sensor range as installed				
23b	MLS Elevation	+0.9 to +30 degrees				

JAR-OPS Subpart K-L | Revised rule text

N°	Parameter	Range	Sampling interval in seconds	Accuracy Limits (sensor input compared to FDR read out)	Minimum Resolution in read out	Remarks
24	Horizontal beam deviation		1	As installed. ± 3 % recommended	0.3 % of full range	See comment to parameter 23
24a	ILS Localizer	± 0.22 DDM or available sensor range as installed				
24b	MLS Azimuth	± 62 degrees				
25	Marker beacon passage	Discrete	1	-	-	One discrete is acceptable for all markers.
26	Warnings	Discretes	1	-	-	A discrete shall be recorded for the master warning, gearbox low oil pressure and SAS failure. Other 'red' warnings should be recorded where the warning condition cannot be determined from other parameters or from the cockpit voice recorder.
27	Reserved					
28	Reserved					
29	Reserved					
30	Landing gear or gear selector position	Discrete(s)	4	-	-	Where installed.

JAR-OPS Subpart K-L | Revised rule text

Table 3: of AMC3-CAT.IDE.H.190-**Helicopters equipped with electronic display systems**

N°	Parameter	Range	Sampling interval in seconds	Accuracy Limits (sensor input compared to FDR read out)	Minimum Resolution in read out	Remarks
638	Selected barometric setting (Each pilot station)	As installed	64	As installed	1mb	Where practicable, a sampling interval of 4 seconds is recommended
6a38 a	Pilot					
6b38 b	First Officer Co-pilot					
739	Selected altitude	As installed	1	As installed	100 ft	Where capacity is limited a sampling interval of 64 seconds is permissible
7a39 a	Manual					
7b39 b	Automatic					
840	Selected Speed	As installed	1	As installed	1 kt	Where capacity is limited a sampling interval of 64 seconds is permissible
8a40 a	Manual					
8b40 b	Automatic					

JAR-OPS Subpart K-L | Revised rule text

N°	Parameter	Range	Sampling interval in seconds	Accuracy Limits (sensor input compared to FDR read out)	Minimum Resolution in read out	Remarks
9 41	Selected Mach	As installed	1	As installed	0.01	Where capacity is limited a sampling interval of 64 seconds is permissible
9a 41 a	Manual					
9b 41 b	Automatic					
10 42	Selected Vertical Speed	As installed	1	As installed	100 ft /min	Where capacity is limited a sampling interval of 64 seconds is permissible
10a 4 2a	Manual					
10b 4 2b	Automatic					
11 43	Selected heading	360 degrees	1	As installed	100 ft /min	Where capacity is limited a sampling interval of 64 seconds is permissible
12 44	Selected flight path		1	As installed		
12a 4 4a	Course/DSTRK				1 degree	
12b 4 4b	Path Angle				0.1 degree	
13 45	Selected decision height	0-500 ft	64	As installed	1ft	

JAR-OPS Subpart K-L | Revised rule text

N°	Parameter	Range	Sampling interval in seconds	Accuracy Limits (sensor input compared to FDR read out)	Minimum Resolution in read out	Remarks
1446	EFIS display format	Discrete(s)	4	-	-	Discretess should show the display system status e.g. normal, fail, composite, sector, plan,, rose, nav aids, wxr, range, copy
14a4 6a	Pilot					
14b4 6b	First Officer Co-pilot					
1547	Multi function /Engine / Alerts display format	Discrete(s)	4	-	-	Discretess should show the display system status e.g. normal, fail, and the identity of the display pages for the emergency procedures and checklists. Information in checklists and procedures need not be recorded.

JAR-OPS Subpart K-L | Revised rule text

The term 'where practicable' used in the remarks column of Table 3 means that account should be taken of the following:

- a. If the sensor is already available or can be easily incorporated;**
- b. Sufficient capacity is available in the flight recorder system;**
- c. For navigational data (nav frequency selection, DME distance, latitude, longitude, groundspeed and drift) the signals are available in digital form;**
- d. The extent of modification required;**
- e. The down-time period; and**
- f. Equipment software development.**

AMC1-CAT.IDE.H.195 Data link recording

GENERAL

1. ~~Depending on the date of type certification,~~The aircraft **helicopter** shall be capable of recording the messages as specified in this AMC.
2. **As a means of compliance with CAT.IDE.H.195, the recorder on which the data-link messages are recorded may be:**
 - a. the CVR;**
 - b. the FDR;**
 - c. a combination recorder when CAT.IDE.H.200 is applicable; or**
 - d. a dedicated flight recorder.**
23. As a means of compliance with CAT.IDE.H.195 (a)(2), the operator should enable correlation by providing information that allows an accident investigator to understand what data were provided to the aircraft **helicopter** and, **when the provider identification is contained in the message**, by which provider.
34. The timing information associated with the data link communications messages required to be recorded by CAT.IDE.H.195 (a)(3) should be capable of being determined from the airborne-based recordings. This timing information should include at least the following:
 - ~~t~~The time each message was generated;
 - ~~t~~The time any message was available to be displayed by the crew;
 - ~~t~~The time each message was actually displayed or recalled from a queue; and
 - ~~t~~The time of each status change.
45. The message priority should be recorded when it is defined by the protocol of the data link communication message being recorded.
56. The expression 'taking into account the system architecture', in CAT.IDE.H.195 (a)(3), means that the recording of the specified information may be omitted if the existing source systems involved would require a major upgrade. The following should be considered:
 - ~~t~~The extent of the modification required;

JAR-OPS Subpart K-L | Revised rule text

- b. ~~t~~The down-time period; **and**
- c. ~~e~~Equipment software development.

~~6.7.~~ The intention is that new designs of source systems should include this functionality and support the full recording of the required information.

~~7.~~ The applications to be recorded should meet the performance specifications defined in the relevant tables of part IV CNS/ATM recorder systems of EUROCAE ED-112.

~~8.~~ Depending on the availability of electrical power, the flight recorder should start to record as early as possible during the cockpit checks prior to engine start at the beginning of the flight until the cockpit checks immediately following engine shutdown at the end of the flight.

~~78.~~ For aeroplanes and helicopters first issued with a type certificate after 31 December 2009, ~~D~~data link communications messages that support the applications in Table 1 of ~~AMC2-CAT.IDE.500.A~~ should be recorded.

9. Further details on the recording requirements can be found in the recording requirement matrix in Appendix D.2 of EUROCAE Document ED-93 (Minimum Aviation System Performance Specification for CNS/ATM Recorder Systems, dated November 1998)

Table 1: ~~of AMC1-CAT.IDE.500.A~~ Applications

Item No.	Application Type	Application Description	Required Recording Content
1	Data link initiation	This includes any application used to log on to, or initiate, a data link service. In Future Air Navigation System (FANS)-1/A and Air Traffic Navigation (ATN), these are ATS Facilities Notification (AFN) and Context Management (CM), respectively.	C
2	Controller/pilot communication	This includes any application used to exchange requests, clearances, instructions and reports between the flight crew and air traffic controllers. In FANS-1/A and ATN, this includes the Controller pilot data link communications (CPDLC) application. CPDLC includes the exchange of Oceanic Clearances (OCLs) and Departure Clearances (DCLs), .	C
3	Addressed Surveillance	This includes any surveillance application in which the ground sets up contracts for delivery of surveillance data. In FANS-1/A and ATN, this includes the automatic dependent surveillance-contract (ADS-C) application, .	C, F2

JAR-OPS Subpart K-L | Revised rule text

Item No.	Application Type	Application Description	Required Recording Content
4	Flight information	This includes any application used for delivery of flight information data to specific aeroplanes. This includes for example Data Link-Automatic Terminal Information Service (D-ATIS), Data Link-Operational Terminal Information Service (D-OTIS), digital weather information services (D-METAR or TWIP), data link flight information service (D-FIS) and Notice to Airmen (D-NOTAM) delivery.	C
5	Aircraft Broadcast surveillance	This includes elementary and enhanced surveillance systems, as well as Automatic Dependent Surveillance-Broadcast (ADS-B) output data.	M*, F2
6	AOC data	This includes any application transmitting or receiving data used for AOC purposes (in accordance with the ICAO definition of AOC). Such systems may also process AAC messages, but there is no requirement to record AAC messages	M*
7	Graphics (↕)	This includes any application receiving graphical data to be used for operational purposes (i.e. excluding applications that are receiving such things as updates to manuals).	M*

~~2. For aeroplanes and helicopters first issued with a type certificate before 1 January 2010, data link communications messages that support the applications in Table 2 of AMC2 OPS.GEN.500 should be recorded.~~

~~Table 2 of AMC2 OPS.GEN.500~~ GM1-CAT.IDE.H.195 Data link recording

GENERAL

- The letters and expressions in Table 1 ~~and 2~~ of AMC1-CAT.IDE.H.195 have the following meaning:
 - ~~a~~-C: Complete contents recorded
 - ~~b~~-M: Information that enables correlation with any associated records stored separately from the helicopter.
 - ~~c~~*: Applications that are to be recorded only as far as is practicable, given the architecture of the system.
 - ~~d~~-F1: Graphics applications may be considered as AOC ~~messages~~ **data** when they are part of a data link communications application service run on an individual basis by the operator itself in the framework of the operational control.
 - ~~e~~-F2: Where parametric data sent by the helicopter, such as Mode S, is reported within the message, it should be recorded unless data from the same source is recorded on the FDR.

JAR-OPS Subpart K-L | Revised rule text

2. The definitions of the applications type in Table 1 and 2 of AMC1--CAT.IDE.H.195 are described in Table 1 of GM1-CAT.IDE.H.195 below.

Table 1: of GM1-CAT.IDE.H.195 Descriptions of the applications type

Item No.	Application Type	Messages	Comments
1	CM		CM is an ATN service
2	AFN		AFN is a FANS 1/A service
3	CPDLC		All implemented up and downlink messages to be recorded
4	ADS-C	ADS-C reports	All contract requests and reports recorded
		Position reports	Only used within FANS 1/A. Only used in oceanic and remote areas.
5	ADS-B	Surveillance data	Information that enables correlation with any associated records stored separately from the helicopter.
6	D-FIS		D-FIS is an ATN service. All implemented up and downlink messages to be recorded
7	TWIP	TWIP messages	Terminal weather information for pilots
8	D-ATIS	ATIS messages	Refer to EUROCAE ED-89A dated December 2003. Data Link Application System Document (DLASD) for the "ATIS" Data Link Service
9	OCL	OCL messages	Refer to EUROCAE ED-106A dated March 2004. Data Link Application System Document (DLASD) for "Oceanic Clearance" Datalink Service
10	DCL	DCL messages	Refer to EUROCAE ED-85A dated December 2003. Data Link Application System Document (DLASD) for "Departure Clearance" Data-link Service
11	Graphics	Weather maps & other graphics	Graphics exchanged in the framework of procedures within the operational control, as specified in Part-OR. Information that enables correlation with any associated records stored separately from the aeroplane.
12	AOC	Aeronautical operational control messages	Messages exchanged in the framework of procedures within the operational control, as specified in Part-OR. Information that enables correlation with any associated records stored separately from the helicopter. Definition in ED-112.

JAR-OPS Subpart K-L | Revised rule text

Item No.	Application Type	Messages	Comments
13	Surveillance	Downlinked Aircraft Parameters (DAP)	As defined in ICAO Annex 10 Volume IV (Surveillance systems and ACAS).

AAC	Aeronautical Administrative Communications
ADS-B	Automatic Dependent Surveillance - Broadcast
ADS-C	Automatic Dependent Surveillance - Contract
AFN	Aircraft Flight Notification
AOC	Aeronautical Operational Control
ATIS	Automatic Terminal Information Service
ATSC	Air Traffic Service Communication
CAP	Controller Access Parameters
CPDLC	Controller Pilot Data Link Communications
CM	Configuration/Context Management
D-ATIS	Data link ATIS
D-FIS	Data link Flight Information Service
DCL	Departure Clearance
FANS	Future Air Navigation System
FLIPCY	Flight Plan Consistency
OCL	Oceanic Clearance
SAP	System Access Parameters
TWIP	Terminal Weather Information for Pilots

AMC1-CAT.IDE.H.200 Flight data and cockpit voice combination recorder

Comment [GC150]: Same changes made for aeroplanes.

GENERAL

1. A **flight data and cockpit voice** combination recorder is a flight recorder that records:
 - a. all voice communications and the aural environment required by **CAT.IDE.IH.185 regarding CVRs** ~~the relevant cockpit voice recorder paragraphs applicable CVR-AMC;~~ and
 - b. all parameters and specifications required by **CAT.IDE.H.190 regarding FDRs** ~~the relevant flight data recorder paragraph, applicable FDR-AMC.~~

with the same specifications required by those paragraphs.

JAR-OPS Subpart K-L | Revised rule text

2. In addition a **flight data and cockpit voice** combination recorder may record data link communication messages and related information required by ~~the relevant data link recording paragraph~~ **CAT.IDE.H.195**.
- ~~2. When two combination recorders are installed, one should be located near the cockpit, in order to minimise the risk of data loss due to a failure of the wiring that gathers data to the recorder. The other should be located at the rear section of the aeroplane, in order to minimise the risk of data loss due to recorder damage in the case of a crash.~~
- ~~3. For aeroplanes, compliance with CVR and FDR requirements may be achieved by:

 - a. ~~one combination recorder, if the aeroplane should be equipped with either a CVR or an FDR;~~
 - b. ~~one combination recorder, if an aeroplane with a maximum certificated take-off mass of 5 700 kg or less should be equipped with both a CVR and an FDR; or~~
 - c. ~~two combination recorders, if an aeroplane with a maximum certificated take-off mass of more than 5 700 kg should be equipped with both a CVR and an FDR.~~~~

AMC1--CAT.IDE.H.205 Seats, seat safety belts, harnesses and child restraint devices

RESTRAIN DEVICES FOR PERSON YOUNGER THAN 24 MONTHS - CHILD RESTRAINT DEVICES (CRD)

1. A child restraint device (CRD) is considered to be acceptable if:
 - a. ~~It~~ is a 'supplementary loop belt' manufactured with the same techniques and the same materials of the approved safety belts; or
 - b. ~~It~~ complies with paragraph 2 below.
2. Provided the CRD can be installed properly on the respective ~~aircraft~~ **helicopter** seat, the following CRDs are considered "acceptable":
 - a. CRDs approved for use in aircraft by a competent authority on the basis of a technical standard and marked accordingly;-
 - b. CRDs approved for use in motor vehicles according to the UN standard ECE R 44, -03 or later series of amendments; ~~or~~
 - c. CRDs approved for use in motor vehicles and aircraft according to Canadian CMVSS 213/213.1; ~~or~~
 - d. CRDs approved for use in motor vehicles and aircraft according to US FMVSS No 213 and are manufactured to these standards on or after February 26, 1985. US approved CRDs manufactured after this date must bear the following labels in red letters:
 - i. "THIS CHILD RESTRAINT SYSTEM CONFORMS TO ALL APPLICABLE FEDERAL MOTOR VEHICLE SAFETY STANDARDS"; and
 - ii. "THIS RESTRAINT IS CERTIFIED FOR USE IN MOTOR VEHICLES AND AIRCRAFT";-;

JAR-OPS Subpart K-L | Revised rule text

- e. CRDs qualified for use in aircraft according to the German "Qualification Procedure for Child Restraint Systems for Use in Aircraft" (TÜV Doc.: TÜV/958-01/2001); ~~and-~~
- f. ~~Devices~~ devices approved for use in cars, manufactured and tested to standards equivalent to those listed above. The device must be marked with an associated qualification sign, which shows the name of the qualification organisation and a specific identification number, related to the associated qualification project. The qualifying organisation should be a competent and independent organisation that is acceptable to the competent authority.

3. Location

- a. Forward facing CRDs may be installed on both forward and rearward facing passenger seats but only when fitted in the same direction as the passenger seat on which **they are** ~~it is~~ positioned. Rearward facing CRDs can only be installed on forward facing passenger seats. A CRD may not be installed within the radius of action of an airbag, unless it is obvious that the airbag is deactivated or it can be demonstrated that there is no negative impact from the airbag.
- b. **An infant or** child in a ~~CRD restraint device~~ should be located as near to a floor level exit as feasible.
- c. **An infant or** child in a ~~CRD restraint device~~ should not hinder evacuation for any passenger.
- d. ~~For complex motor powered aircraft involved in commercial air transport, a~~**An infant or** child in a ~~CRD restraint device~~ should neither be located in the row (where rows are existing) leading to an emergency exit nor located in a row immediately forward or aft of an emergency exit. A window passenger seat is the preferred location. An aisle passenger seat or a cross aisle passenger seat **that forms part of the evacuation route to exits** is not recommended. Other locations may be acceptable provided the access of neighbour passengers to the nearest aisle is not obstructed by the CRD.
- e. ~~For complex motor powered aircraft involved in commercial air transport, i~~**In** general, only one CRD per row segment is recommended. More than one CRD per row segment is allowed if the **infants/children** are from the same family or travelling group provided the **infants/children** are accompanied by a responsible ~~person~~**adult** sitting next to them. A row segment is the fraction of a row separated by two aisles or by one aisle and the ~~aircraft~~**helicopter** fuselage.

4. Installation

- a. CRDs should only be installed on a suitable aircraft seat with the type of connecting device they are approved or qualified for. E.g., CRDs to be connected by a three point harness only (most rearward facing baby CRDs currently available) should not be attached to an aircraft seat with a lap belt only, a CRD designed to be attached to a vehicle seat by means of rigid bar lower anchorages (ISO-FIX or US equivalent) only, should only be used on aircraft seats that are equipped with such connecting devices and should not be attached by the aircraft seat lap belt. The method of connecting should be the one shown in the manufacturer's instructions provided with each CRD.

JAR-OPS Subpart K-L | Revised rule text

- b. All safety and installation instructions must be followed carefully by the responsible person accompanying the infant. For aircraft involved in commercial air transport, cabin crew should prohibit the use of any inadequately installed CRD or not qualified seat.
 - c. If a forward facing CRD with a rigid backrest is to be fastened by a lap belt, the restraint device should be fastened when the backrest of the passenger seat on which it rests is in a reclined position. Thereafter, the backrest is to be positioned upright. This procedure ensures better tightening of the CRD on the aircraft seat if the aircraft seat is reclinable.
 - d. The buckle of the adult safety belt must be easily accessible for both opening and closing, and must be in line with the seat belt halves (not canted) after tightening.
 - e. Forward facing restraint devices with an integral harness must not be installed such that the adult safety belt is secured over the child.
5. Operation
- a. Each CRD should remain secured to a passenger seat during all phases of flight, unless it is properly stowed when not in use.
 - b. Where a CRD is adjustable in recline it must be in an upright position for all occasions when passenger restraint devices are required.

AMC2--CAT.IDE.H.205 Seats, seat safety belts, harnesses and child restraint devices

SAFETY HARNESS

- ~~1. Safety harness should have four anchorage points and should include shoulder straps (two anchorage points) and a seat belt (two anchorage points) which may be used independently.~~
2. A safety harness having five anchorage points is deemed to be compliant to the requirement for safety harness with four anchorage points.
3. **A safety belt with diagonal should strap (three anchorage points) is** , deemed to be compliant with ~~safety belt with diagonal shoulder strap (3 anchorage points), deemed to be compliant with safety belt (2~~**two** anchorage points).

Comment [GC151]: Definition moved to IR level and re-drafted as done for Aeroplanes.

AMC3--CAT.IDE.H.205 Seats, seat safety belts,- harnesses and child restraint devicesSEATS FOR MINIMUM REQUIRED CABIN **CREW SEATS**

1. Seats for ~~the minimum required cabin crew members~~ should be located, **where possible, near required floor level emergency exits. If the number of required cabin crew members exceeds the number of floor level emergency exits the additional cabin crew seats should be located such that the cabin crew member(s) may best be able to assist passengers in the event of an emergency evacuation.**

~~near required floor level emergency exits close to the emergency exits and where cabin crew members can best assist passengers in the event of an emergency evacuation.~~

JAR-OPS Subpart K-L | Revised rule text

2. **Seats for cabin crew member(s) should be forward or rearward facing within 15° of the longitudinal axis of the helicopter.**

AMC2-AMC1-CAT.IDE.H.220 First-aid kits

Comment [GC152]: From AMC OPS 3.745

CONTENT OF FIRST_AID KIT

1. First-aid kits (FAKs) should be equipped with appropriate and sufficient medications and instrumentation. However, these kits ~~should be~~ **may be amended** by the operator according to the characteristics of the operation (scope of operation, flight duration, number and demographics of passengers etc.).
2. The following should be included in the ~~FAKs~~ **first-aid kits**:
 - a. Equipment:
 - i. Bandages (assorted sizes);
 - ii. ~~b~~ Burns dressings (unspecified);
 - iii. ~~w~~ Wound dressings (large and small);
 - iv. ~~a~~ Adhesive dressings (assorted sizes);
 - v. ~~a~~ Adhesive tape;
 - vi. ~~a~~ Adhesive wound closures;
 - vii. ~~s~~ Safety pins;
 - viii. ~~s~~ Scissors;
 - ix. ~~a~~ Antiseptic wound cleaner;
 - x. ~~d~~ Disposable resuscitation aid;
 - xi. ~~d~~ Disposable gloves;
 - xii. ~~i~~ Tweezers: splinter; **and**
 - xiii. ~~t~~ Thermometers (non mercury).
 - b. Medications:
 - i. Simple analgesic (may include liquid form);
 - ii. ~~a~~ Antiemetic;
 - iii. ~~n~~ Nasal decongestant;
 - iv. ~~g~~ Gastrointestinal antacid, in the case of helicopters carrying more than 9 passengers;
 - v. ~~a~~ Anti-diarrhoeal medication in the case of helicopters carrying more than ~~9~~ **nine** passengers; **and**
 - vi. ~~Bronchial dilator spray~~ **antihistamine.**
 - c. Other:
 - i. A list of contents in at least 2 languages (English and one other). This should include information on the effects and side effects of medications carried;
 - ii. ~~f~~ First-aid handbook;

JAR-OPS Subpart K-L | Revised rule text

- iii. ~~m~~Medical incident report form;
 - iv. ~~b~~Biohazard disposal bags; **and**
 - v. ~~g~~Ground/~~a~~Air visual signal code for use by survivors.
- d. An eye irrigator, whilst not required to be carried in the ~~FA~~**first-aid kit**, should, where possible, be available for use on the ground.
 - e. For security reasons, items such as scissors **and scalpels** should be stored securely.

~~AMC3-AMC2-CAT.IDE.H.220~~ First-aid kits

MAINTENANCE OF FIRST AID KITS

To be maintained first aid kits should be:

1. inspected periodically to confirm, to the extent possible, that contents are maintained in the condition necessary for their intended use; and
2. replenished at regular intervals, in accordance with instructions contained on their labels, or as circumstances warrant.

AMC1-CAT.IDE.H.240 Supplemental oxygen- Non-pressurised helicopters**AMOUNT OF SUPPLEMENTAL OXYGEN**

The amount of supplemental oxygen for sustenance for a particular operation should be determined on the basis of flight altitudes and flight duration, consistent with the operating procedures, including emergency, procedures, established for each operation and the routes to be flown as specified in the operations manual.:

AMC1-CAT.IDE.H.250 Hand fire extinguishers

Comment [GC153]: From AMC OPS 3.790

HAND FIRE EXTINGUISHERS—NUMBER, LOCATION AND TYPE

1. The number and location of hand fire extinguishers should be such as to provide adequate availability for use, account being taken of the number and size of the passenger compartments, the need to minimise the hazard of toxic gas concentrations and the location of toilets, galleys etc. These considerations may result in the number of fire extinguishers being greater than the minimum prescribed.
2. There should be at least one **hand fire** extinguisher installed in the ~~cockpit~~**flight crew compartment** and this should be suitable for fighting both flammable fluid and electrical equipment fires. Additional **hand fire** extinguishers may be required for the protection of other compartments accessible to the crew in flight. Dry chemical fire extinguishers should not be used in the ~~cockpit~~**flight crew compartment**, or in any compartment not separated by a partition from the ~~cockpit~~**flight crew compartment**, because of the adverse effect on vision during discharge and, if conductive, interference with electrical contacts by the chemical residues.

JAR-OPS Subpart K-L | Revised rule text

3. Where only one hand fire extinguisher is required in the passenger compartments it should be located near the cabin crew member's station, where provided.
4. Where two or more hand fire extinguishers are required in the passenger compartments and their location is not otherwise dictated by consideration of paragraph ~~OPS.CAT.405(a)~~ **CAT.IDE.H.330250 (b)**, an extinguisher should be located near each end of the cabin with the remainder distributed throughout the cabin as evenly as is practicable.
5. Unless an extinguisher is clearly visible, its location should be indicated by a placard or sign. Appropriate symbols may also be used to supplement such a placard or sign.
6. The fire extinguishers located in the cockpit should contain Halon 1211 (bromochlorodifluoro-methane, CBrClF₂) or an equivalent extinguishing agent.
7. For aeroplanes with a maximum approved passenger seating configuration between 31 and 60, one of the required fire extinguishers located in the passenger compartment should contain Halon 1211 (bromochlorodi-fluoromethane, CBrClF₂) or an equivalent extinguishing agent.
8. For aeroplanes with a maximum approved passenger seating configuration of more than 61, at least two of the fire extinguishers located in the passenger compartment should contain Halon 1211 (bromochlorodi-fluoromethane, CBrClF₂) or an equivalent extinguishing agent.

AMC1-CAT.IDE.H.260 Marking of break-in points

COLOUR AND CORNERS' MARKING

1. The colour of the markings should be red or yellow and, if necessary, should be outlined in white to contrast with the background.
2. If the corner markings are more than 2 m apart, intermediate lines 9 ~~cm centimetres (cm)~~ x 3 cm should be inserted so that there is no more than 2 m between adjacent markings.

AMC1-CAT.IDE.H.270 Megaphones

Comment [GCI54]: From AMC OPS 3.810

LOCATION OF MEGAPHONES

1. ~~Where one megaphone is required, it~~ **The megaphone** should be readily accessible at the assigned seat of a cabin crew member or crew members other than flight crew.
2. ~~2. — Where two or more megaphones are required, they should be suitably distributed in the passenger cabin(s) and readily accessible to crew members assigned to direct emergency evacuations.~~
3. ~~Notwithstanding 1 and 2, t~~This does not necessarily require megaphones to be positioned such that they can be physically reached by a crew member when strapped in a cabin crew member's seat.

JAR-OPS Subpart K-L | Revised rule text

AMC1-CAT.IDE.H.280 Emergency Locator Transmitter (ELT)~~ELT BATTERIES—MOTOR-POWERED AIRCRAFT~~

Batteries used in the ELTs should be replaced (or recharged, if the battery is rechargeable) when the equipment has been in use for more than **one±** cumulative hour, and also when 50 % of their useful life (or for rechargeable, 50 % of their useful life of charge), as established by the equipment manufacturer has expired. The new expiry date for the replacement (or recharged) battery should be legibly marked on the outside of the equipment. The battery useful life (or useful life of charge) requirements of this paragraph do not apply to batteries (such as water-activated batteries) that are essentially unaffected during probable storage intervals.

Comment [GC155]: From IEM OPS 3.820

AMC2-CAT.IDE.H.280 Emergency Locator Transmitter (ELT)~~GENERAL—TYPES OF ELT AND GENERAL TECHNICAL SPECIFICATIONS~~

1. The ELT required by this provision should be one of the following:
 - a. Automatic Fixed (ELT(AF)). An automatically activated ELT ~~which—that~~ is permanently attached to an ~~aircraft~~ **helicopter** and is designed to aid **search and rescue (SAR)** teams in locating the crash site;
 - b. Automatic Portable (ELT(AP)). An automatically activated ELT, which is rigidly attached to a ~~aircraft~~ **helicopter** before a crash, but is readily removable from the ~~aircraft~~ **helicopter** after a crash. It functions as an ELT during the crash sequence. If the ELT does not employ an integral antenna, the ~~aircraft~~ **helicopter**-mounted antenna may be disconnected and an auxiliary antenna (stored on the ELT case) attached to the ELT. The ELT can be tethered to a survivor or a life raft. This type of ELT is intended to aid SAR teams in locating the crash site or survivor(s);
 - c. Automatic Deployable (ELT(AD)). An ELT ~~which—that~~ is rigidly attached to the ~~aircraft~~ **helicopter** before the crash and ~~which—that~~ is automatically ejected, deployed and activated by an impact, and, in some cases, also by hydrostatic sensors. Manual deployment is also provided. This type of ELT should float in water and is intended to aid SAR teams in locating the crash site; or
 - d. Survival ELT (ELT(S)). An ELT ~~which—that~~ is removable from an ~~aircraft~~ **helicopter**, stowed so as to facilitate its ready use in an emergency, and manually activated by a survivor. An ELT(S) may be activated manually or automatically (e.g. by water activation). It should be designed to be tethered to a life raft or a survivor.
2. To minimize the possibility of damage in the event of crash impact, the automatic ELT should be rigidly fixed to the ~~aircraft~~ **helicopter** structure, as far aft as is practicable, with its antenna and connections arranged so as to maximize the probability of the signal being transmitted after a crash.
3. Any ELT carried should operate in accordance with the relevant provisions of ICAO Annex 10, Volume III **Communications Systems** and should be registered with the national agency responsible for initiating search and rescue or other nominated agency.
4. ELTs should be able to transmit on 121.5 Megah**Hertz** (MHz) and 406 MHz.

Comment [GC156]: From AMC OPS 3.830(a)(3)

*JAR-OPS Subpart K-L | Revised rule text***AMC3-CAT.IDE.H.280 Emergency Locator Transmitter (ELT)**

ELT(S) - HELICOPTERS

An ELT(AP) may be used to replace one required ELT(S) provided that it meets the ELT(S) requirements. A water-activated ELT(S) is not an ELT(AP).

Comment [GC157]: From ACJ OPS 1.820

GM1-CAT.IDE.H.360-280 Emergency Locator Transmitter (ELT)

TERMINOLOGY

An ~~e~~Emergency Locator Transmitter (ELT) is a generic term describing equipment which broadcasts distinctive signals on designated frequencies and, depending on application, may be activated by impact or may be manually activated.

AMC1-CAT.IDE.H.290 (a) Life-jackets~~LIFE JACKETS~~ — HELICOPTERS **ACCESSIBILITY**

The life jacket should be accessible from the seat or berth of the person for whose use it is provided, with a safety belt or harness fastened.

AMC2--CAT.IDE.H.290 (c) Life--jackets~~LIFE JACKETS~~ **ELECTRIC ILLUMINATION**

THE MEANS OF ELECTRIC ILLUMINATION SHOULD BE A SURVIVOR LOCATOR LIGHT.

Comment [GC158]: From IEM OPS 3.825

GM1-CAT.IDE.H.290 Life--jacketsLIFE JACKETS - ALL AIRCRAFT **SEAT CUSHIONS**

SEAT CUSHIONS ARE NOT CONSIDERED TO BE FLOTATION DEVICES.

Comment [GC159]: From ACJ OPS 3.827

GM1--CAT.IDE.H.295 Crew survival suits

ESTIMATING SURVIVAL TIME

1. Introduction

- a. A person accidentally immersed in cold seas (typically offshore Northern Europe) will have a better chance of survival if he/**she** is wearing an effective survival suit in addition to a life-jacket. By wearing the survival suit, he/she can slow down the rate which his/her body temperature falls and, consequently, protect himself/herself from the greater risk of drowning brought about by incapacitation due to hypothermia.
- b. The complete survival suit system – suit, life-jacket and clothes worn under the suit – should be able to keep the wearer alive long enough for the rescue services to find and recover him/her. In practice the limit is about ~~3~~**three** hours. If a group of persons in the water cannot be rescued within this time they are likely to have become so scattered and separated that location will be extremely difficult, especially in the rough water typical of Northern European

JAR-OPS Subpart K-L | Revised rule text

sea areas. If it is expected that in water protection could be required for periods greater than ~~3~~**three** hours, improvements should, rather, be sought in the search and rescue procedures than in the immersion suit protection.

2. Survival times

- a. The aim should be to ensure that a person in the water can survive long enough to be rescued, i.e. the survival time must be greater than the likely rescue time. The factors affecting both times are shown in Figure 1 of GM CAT.IDE.H.295. The figure emphasises that survival time is influenced by many factors, physical and human. Some of the factors are relevant to survival in cold water and some are relevant in water at any temperature.

Figure 1: ~~of GM CAT.IDE.H.295~~ — The survival equation

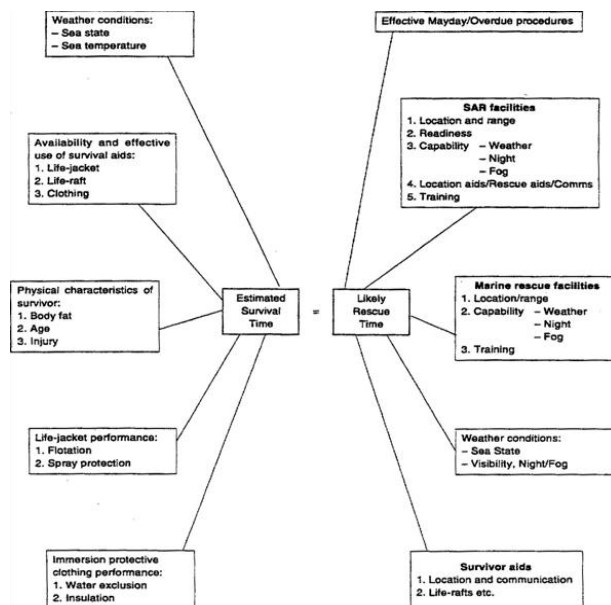

- b. Broad estimates of likely survival times for the thin individual offshore are given in Table 1 ~~of GM CAT.IDE.H.295~~**below**. As survival time is significantly affected by the prevailing weather conditions at the time of immersion, the Beaufort wind scale has been used as an indicator of these surface conditions.

Table 1: ~~of GM CAT.IDE.H.295~~ — Timescale within which the most vulnerable individuals are likely to succumb to the prevailing conditions.

Clothing assembly	Beaufort wind force	Times within which the most vulnerable individuals are likely to drown	
		(water temp 5°C)	(water temp 13°C)
Working clothes	0 – 2	Within ¾ hour	Within 1 ¼ hours

JAR-OPS Subpart K-L | Revised rule text

Clothing assembly	Beaufort wind force	Times within which the most vulnerable individuals are likely to drown	
		(water temp 5°C)	(water temp 13°C)
(no immersion suit)	3 - 4	Within ½ hour	Within ½ hour
	5 and above	Significantly less than ½ hour	Significantly less than ½ hour
Immersion suit worn over working clothes (with leakage inside suit)	0 -2	May well exceed 3 hours	May well exceed 3 hours
	3 - 4	Within 2 ¾ hours	May well exceed 3 hours
	5 and above	Significantly less than 2 ¾ hours. May well exceed 1 hour	May well exceed 3 hours

- c. Consideration should also be given to escaping from the helicopter itself should it submerge or invert in the water. In this case escape time is limited to the length of time the occupants can hold their breath. The breath holding time can be greatly reduced by the effect of cold shock. Cold shock is caused by the sudden drop in skin temperature on immersion, and is characterised by a gasp reflex and uncontrolled breathing. The urge to breathe rapidly becomes overwhelming and, if still submerged, the individual will inhale water resulting in drowning. Delaying the onset of cold shock by wearing an immersion suit will extend the available escape time from a submerged helicopter.
- d. The effects of water leakage and hydrostatic compression on the insulation quality of clothing are well recognised. In a nominally dry system the insulation is provided by still air trapped within the clothing fibres and between the layers of suit and clothes. It has been observed that many systems lose some of their insulative capacity either because the clothes under the 'waterproof' survival suit get wet to some extent or because of hydrostatic compression of the whole assembly. As a result of water leakage and compression, survival times will be shortened. The wearing of warm clothing under the suit is recommended.
- e. Whatever type of survival suit and other clothing is provided, it should not be forgotten that significant heat loss can occur from the head.

Comment [GC160]: From AMC OPS 3.830(a)(2)

AMC1--CAT.IDE.H.300 Life-rafts, ELT(S) and survival equipment on extended overwater flights~~Life-rafts and survival ELT(S)~~

~~LIFE--SAVING--RAFTS AND EQUIPMENT FOR MAKING DISTRESS SIGNALS - HELICOPTERS~~

- 1. ~~Life saving rafts in sufficient numbers to carry all persons on board should be:~~
 - a. ~~in the case of a helicopter carrying less than 12 persons, a minimum of one life raft with a rated capacity of not less than the maximum number of persons on board; and~~

JAR-OPS Subpart K-L | Revised rule text

~~b. in the case of a helicopter carrying more than 11 persons, a minimum of two life rafts sufficient together to accommodate all persons capable of being carried on board. Should one life raft of the largest rated capacity be lost, the overload capacity of the remaining life raft(s) should be sufficient to accommodate all persons on the helicopter.~~

1. Each required life-saving-raft should conform to the following specifications:
 - a. be of an approved design and stowed so as to facilitate their ready use in an emergency;
 - b. be radar conspicuous to standard airborne radar equipment;
 - c. when carrying more than one life-raft on board, at least 50 % should be able to be deployed by the crew while seated at their normal station, where necessary by remote control; **and**
 - d. life-rafts ~~which~~ **that** are not deployable by remote control or by the crew should be of such weight as to permit handling by one person. 40 kg should be considered a maximum weight.
2. Each required life-raft should contain at least the following:
 - a. ~~One~~ approved survivor locator light;
 - b. ~~One~~ approved visual signalling device;
 - c. ~~One~~ canopy (for use as a sail, sunshade or rain catcher) or other mean to protect occupants from the elements;
 - d. ~~One~~ radar reflector;
 - e. ~~One~~ 20 m retaining line designed to hold the life-raft near the helicopter but to release it if the helicopter becomes totally submerged;
 - f. ~~One~~ sea anchor;
 - g. ~~One~~ survival kit, appropriately equipped for the route to be flown, which should contain at least the following:
 - i. ~~One~~ life-raft repair kit;
 - ii. ~~One~~ bailing bucket;
 - iii. ~~One~~ signalling mirror;
 - iv. ~~One~~ police whistle;
 - v. ~~One~~ buoyant raft knife;
 - vi. ~~One~~ supplementary means of inflation;
 - vii. ~~s~~Sea sickness tablets;
 - viii. ~~One~~ first-aid kit;
 - ix. ~~One~~ portable means of illumination;
 - x. **500 ml** ~~One half litre~~ of pure water and one sea water desalting kit; **and**
 - xi. ~~One~~ comprehensive illustrated survival booklet in an appropriate language.

JAR-OPS Subpart K-L | Revised rule text

4. ~~The equipment for making distress signal should be at least one survival Emergency Locator Transmitter (ELT(S)) for each life raft carried (but not more than a total of 2 ELTs are required), capable of performing in accordance with AMC2 OPS.GEN.430.~~

AMC1-CAT.IDE.H.305 Survival equipment

Comment [GCI61]: From AMC OPS 3.835(c)

ADDITIONAL SURVIVAL EQUIPMENT~~W~~

1. The following additional survival equipment should be carried when required:
 - a. 500 ml of water for each 4, or fraction of 4, persons on board;
 - b. ~~o~~One knife;
 - c. ~~f~~First-~~a~~Aid ~~e~~Equipment; **and**
 - d. ~~o~~One set of ~~a~~Air/~~g~~Ground codes.~~;~~
2. In addition, when polar conditions are expected, the following should be carried:
 - a. ~~a~~A means for melting snow;
 - b. ~~one~~± snow shovel and 1 ice saw;
 - c. ~~s~~Sleeping bags for use by 1/3 of all persons on board and space blankets for the remainder or space blankets for all passengers on board; **and**
 - d. ~~one~~± Arctic/Polar suit for each crew member carried.
3. If any item of equipment contained in the above list is already carried on board the ~~aircraft~~ **helicopter** in accordance with another requirement, there is no need for this to be duplicated.

GM1-CAT.IDE.H.305 Survival equipment

SIGNALLING EQUIPMENT

The signalling equipment for making distress signals is described in ICAO Annex 2, **Rules of the Air**:-

GM2-CAT.IDE.H.305 Survival equipment

Comment [GCI62]: From IEM OPS 3.835

AREAS IN WHICH SEARCH AND RESCUE WOULD BE ESPECIALLY DIFFICULT'

The expression 'areas in which search and rescue would be especially difficult' should be interpreted, in this context, as meaning:

1. ~~a~~Areas so designated by the ~~competent~~ authority responsible for managing search and rescue; or
2. ~~a~~Areas that are largely uninhabited and where:
 - a. ~~t~~The ~~competent~~ authority responsible for managing search and rescue has not published any information to confirm whether search and rescue would be or would not be especially difficult; and
 - b. ~~t~~The ~~competent~~ authority referred to in 1. does not, as a matter of policy, designate areas as being especially difficult for search and rescue.

JAR-OPS Subpart K-L | Revised rule text

AMC1-CAT.IDE.H.310 Additional requirements for helicopters operating to or from helidecks located in a hostile sea area

Comment [GC163]: From IEM OPS 3.837(a)(2)

INSTALLATION OF THE LIFE RAFT ~~SO AS TO BE USABLE IN THE SEA CONDITIONS~~

1. Projections on the exterior surface of the helicopter, ~~which~~ **that** are located in a zone delineated by boundaries ~~which~~ **that** are 1.22 m (4 ft) above and 0.61 m (2 ft) below the established static water line could cause damage to a deployed life-raft. Examples of projections which need to be considered are aerials, overboard vents, unprotected split-pin tails, guttering and any projection sharper than a three dimensional right angled corner.
2. While the boundaries specified in ~~paragraph~~ 1. are intended as a guide, the total area ~~which~~ **that** should be considered should also take into account the likely behaviour of the life--raft after deployment in all sea states up to the maximum in which the helicopter is capable of remaining upright.
3. Wherever a modification or alteration is made to a helicopter within the boundaries specified, the need to prevent the modification or alteration from causing damage to a deployed life--raft should be taken into account in the design.
4. Particular care should also be taken during routine maintenance to ensure that additional hazards are not introduced by, for example, leaving inspection panels with sharp corners proud of the surrounding fuselage surface, or allowing door sills to deteriorate to a point where sharp edges become a hazard.
5. The same considerations apply in respect of emergency flotation equipment.

GM1-CAT.IDE.H.315 Helicopters certificated for operating on water - Miscellaneous equipment

INTERNATIONAL REGULATIONS FOR PREVENTING COLLISIONS AT SEA - HELICOPTERS

International Regulations for Preventing Collisions at Sea are those ~~which~~ **that** were published by the International Maritime Organization (IMO) in 1972.

AMC1-CAT.IDE.H.325 Headset

Comment [GC164]: From JAR.OPS 3.647

GENERAL

1. A headset consists of a communication device ~~which~~ **that** includes two earphones to receive and a microphone to transmit audio signals to the ~~aircraft's~~ **helicopter's** communication system. To comply with the minimum performance requirements, the earphones and microphone should match the communication system's characteristics and the cockpit environment. The headset should be adequately adjustable in order to fit the pilot's head. Headset boom microphones should be of the noise cancelling type.
2. If the intention is to utilise noise cancelling earphones, the operator should ensure that the earphones do not attenuate any aural warnings or sounds necessary for alerting the flight crew on matters related to the safe operation of the ~~helicopter~~ **aircraft**.

*JAR-OPS Subpart K-L | Revised rule text***GM1-CAT.IDE.H.325 Headset**

GENERAL

The term 'headset' includes any aviation helmet incorporating headphones and microphone worn by a flight crew member.

AMC1-CAT.IDE.H.345 Communication and nNavigation equipment for operations under IFR, or under VFR over routes not navigated by reference to visual landmarks

TWO INDEPENDENT **MEANS OF COMMUNICATION**~~MEANS~~

Whenever two independent means of communication are required, each system should have an independent antenna installation, **except where** ~~Whenever~~ rigidly supported non-wire antennae or other antenna installations of equivalent reliability are used, ~~only one antenna may be required.~~

AMC2-CAT.IDE.H.345 Communication and nNavigation equipment for operations under IFR, or under VFR over routes not navigated by reference to visual landmarks

ACCEPTABLE NUMBER AND TYPE OF COMMUNICATION AND NAVIGATION EQUIPMENT~~FOR HELICOPTERS~~

1. ~~Helicopters should be equipped with~~An acceptable number and type of communication and navigation equipment is:
 - a. ~~Two~~ **VHF omnidirectional radio range (VOR)** receiving systems on any route, or part thereof, where navigation is based only on VOR signals;
 - b. ~~Two~~ **automatic direction finder (ADF)** systems on any route, or part thereof, where navigation is based only on **non directional beacon (NDB)** signals; ~~and-~~
 - c. ~~a~~Area ~~n~~Navigation equipment when area navigation is required for the route being flown (e.g. equipment required by **SPA.PBN and SPA.MNPS**).
2. ~~The~~A helicopter may be operated without the navigation equipment specified in 1.a. and 1.b. above provided it is equipped with alternative equipment. The reliability and the accuracy of alternative equipment should allow safe navigation for the intended route.
3. VHF communication equipment, **instrument landing system (ILS)** ~~localiser~~ and VOR receivers installed on helicopters to be operated under IFR should comply with the following ~~FM~~ immunity performance standards:
 - a. ICAO Annex 10 , Volume I - Radio Navigation Aids, and Volume III, Part II - Voice Communications Systems; ~~and-~~
 - b. ~~a~~Acceptable equipment standards contained in EUROCAE Minimum Operational Performance Specifications, documents ED-22B for VOR receivers, ED-23B for VHF communication receivers and ED-46B for LOC receivers and the corresponding **Radio Technical Commission for Aeronautics (RTCA)** documents DO-186, DO-195 and DO-196.

Comment [GC165]: From ACJ OPS 3.865(e)

JAR-OPS Subpart K-L | Revised rule text

AMC3-CAT.IDE.H.345 Communication and nNavigation equipment for operations under IFR, or under VFR over routes not navigated by reference to visual landmarks

FAILURE OF A SINGLE UNIT

Required communication and navigation equipment should be installed such that the failure of any single unit required for either communication or navigation purposes, or both, will not result in the failure of another unit required for communications or navigation purposes.

~~When compliance with CAT.IDE.H.520 requires more than one communication or navigation equipment unit to be provided, each should be independent of the other(s), to the extent that a failure in any one will not result in failure of any other.~~

GM1-CAT.IDE.H.345 Communication and nNavigation equipment for operations under IFR, or under VFR over routes not navigated by reference to visual landmarks

APPLICABLE AIRSPACE REQUIREMENTS

For aircraft ~~and~~ **helicopters** being operated under European air traffic control, the applicable airspace requirements include the Single European Sky legislation. .

AMC1-CAT.IDE.H.350 Transponder

~~GENERAL~~ **SSR TRANSPONDER**

1. The **secondary surveillance radar (SSR)** transponder of aircraft being operated under European air traffic control should comply with any applicable Single European Sky legislation.
2. If the Single European Sky legislation is not applicable, the SSR transponder should operate in accordance with the relevant provisions of Volume IV of ICAO Annex 10.
3. Additional SSR transponder capabilities may be required by the applicable airspace requirements.