

European Aviation Safety Agency

DECISION NO. 2003/12/RM

OF THE EXECUTIVE DIRECTOR OF THE AGENCY

of 5 November 2003

on general acceptable means of compliance for airworthiness of products, parts and appliances (« AMC-20 »)

THE EXECUTIVE DIRECTOR OF THE EUROPEAN AVIATION SAFETY AGENCY,

Having regard to Regulation (EC) No 1592/2002 of the European Parliament and of the Council of 15 July 2002 on common rules in the field of civil aviation and establishing a European Aviation Safety Agency¹ (hereinafter referred to as the “Basic Regulation”), and in particular Articles 13 and 14 thereof,

Having regard to the Commission Regulation (EC) No 1702/2003 of 24 September 2003² laying down implementing rules for the airworthiness and environmental certification of aircraft and related products, parts and appliances, as well as for the certification of design and production organisations, in particular 21A.16A of Part 21 thereof;

Whereas :

- (1) The Agency shall issue certification specifications, including airworthiness codes and acceptable means of compliance, as well as guidance material to be used in the certification process.
- (2) The Agency has, pursuant to Article 43 of the Basic Regulation, consulted widely interested parties on the matters which are subject to this Decision and following that consultation provided a written response to the comments received,

HAS DECIDED AS FOLLOWS:

¹ OJ L 240, 7.09.2002, p. 1.

² OJ L 243, 27.09.2003, p. 6.

Article 1

The general acceptable means of compliance for airworthiness of products, parts and appliances are those laid down in the Annex to this Decision.

Article 2

This Decision shall enter into force on 5 November 2003. It shall be published in the *Official Publication of the Agency*.

Done at Brussels, 5 November 2003.

For the European Aviation Safety Agency,

Patrick GOUDOU

Executive Director

**General
Acceptable Means of
Compliance for
Airworthiness of Products,
Parts and Appliances**

AMC-20

CONTENTS

AMC-20

GENERAL ACCEPTABLE MEANS OF COMPLIANCE FOR AIRWORTHINESS OF PRODUCTS, PARTS AND APPLIANCES

AMC 20-115B	RECOGNITION OF EUROCAE ED-12B / RTCA DO-178B
AMC 20-128A	DESIGN CONSIDERATIONS FOR MINIMIZING HAZARDS CAUSED BY UNCONTAINED TURBINE ENGINE AND AUXILIARY POWER UNIT ROTOR FAILURE Appendix 1
AMC 20-1	CERTIFICATION OF AIRCRAFT PROPULSION SYSTEMS EQUIPPED WITH ELECTRONIC CONTROLS
AMC 20-2	CERTIFICATION OF ESSENTIAL APU EQUIPPED WITH ELECTRONIC CONTROLS
AMC 20-3	Reserved
AMC 20-4	AIRWORTHINESS APPROVAL AND OPERATIONAL CRITERIA FOR THE USE OF NAVIGATION SYSTEMS IN EUROPEAN AIRSPACE DESIGNATED FOR BASIC RNAV OPERATIONS
AMC 20-5	AIRWORTHINESS APPROVAL AND OPERATIONAL CRITERIA FOR THE USE OF THE NAVSTAR GLOBAL POSITIONING SYSTEM (GPS)
AMC 20-6	EXTENDED RANGE OPERATION WITH TWO-ENGINE AEROPLANES ETOPS CERTIFICATION AND OPERATION
AMC 20-7	Reserved
AMC 20-8	OCCURRENCE REPORTING

INTENTIONALLY LEFT BLANK

AMC 20-115B
Recognition of Eurocae ED-12B / RTCA DO-178B

1 PURPOSE

This acceptable means of compliance calls attention to the European Organisation for Civil Aviation Equipment (EUROCAE) document ED-12B, "Software Consideration in Airborne Systems and Equipment Certification", issued December 1992. It discusses how the document may be applied to certification programmes administered by the European Aviation Safety Agency .

2 RELATED DOCUMENTS

2.1 EUROCAE document ED-12B is technically equivalent to RTCA Inc. document DO-178B. A reference to one document, at the same revision level, may be interpreted to mean either document.

2.2 This AMC is based on FAA AC 20-115B, dated 11 January 1993.

3 RELATED CERTIFICATION SPECIFICATIONS (CSs)

Part 21, CS-22, CS-23, CS-25, CS-27, CS-29, CS-AWO, CS-E, CS-P, CS-APU, CS-TSO and CS-VLA. Existing references to ED-12/DO-178 and ED-12A/DO-178A in the above CSs will be amended, at the next opportunity, to take into account the principles spelt out in paragraph 6. below.

4 BACKGROUND

4.1 EUROCAE document ED-12B was developed to establish software considerations for developers, installers and users when the aircraft equipment design is implemented using software-based techniques. Current and future avionics designs will make extensive use of this technology. The EUROCAE document provides guidelines for establishing software levels, software life cycle planning, development, verification, configuration management and quality assurance disciplines to be used in software-based systems.

4.2 The document specifies the information to be made available and/or delivered to the Agency. Guidance is provided also for dealing with software developed to earlier standards, tool qualification and alternative methods which may be used.

5 USE OF EUROCAE ED-12B PROCEDURES

An applicant for EASA certification for any software-based equipment or system may use the considerations outlined in EUROCAE document ED-12B, as a means, but not the only means to secure approval. The Agency may publish acceptable means of compliance for specific CSs, stating the required relationship between the criticality of the software-based systems and the software levels as defined in EUROCAE document ED-12B. Such acceptable means of compliance will take precedence over the application of EUROCAE document ED-12B.

6 USE OF PREVIOUS VERSIONS

ED-12/DO-178 and ED-12A/DO-178A will continue to be accepted for systems and equipment where these have been accepted as the basis for approval or certification.

7 AVAILABILITY OF EUROCAE DOCUMENT ED-12B

Copies may be purchased from EUROCAE, 17 rue Hamelin, 75783 PARIS Cedex 16, France, (Fax : 33 1 4505 7230).

INTENTIONALLY LEFT BLANK

AMC 20–128A

Design Considerations for Minimizing Hazards Caused by Uncontained Turbine Engine and Auxiliary Power Unit Rotor Failure

1 *PURPOSE.* This acceptable means of compliance (AMC) sets forth a method of compliance with the requirements of CS 23.901(f), 23.903(b)(1), 25.903(d)(1) and 25A903(d)(1) of the EASA Certification Specifications (CS) pertaining to design precautions taken to minimise the hazards to an aeroplane in the event of uncontained engine or auxiliary power unit (APU) rotor failures. The guidance provided within this AMC is harmonised with that of the Federal Aviation Administration (FAA) and is intended to provide a method of compliance that has been found acceptable. As with all AMC material, it is not mandatory and does not constitute a regulation.

2 *RESERVED*

3 *APPLICABILITY.* This AMC applies to CS–23 and CS–25 aeroplanes.

4 *RELATED DOCUMENTS.* Paragraphs 23.903, and 25.903 of the CS and other paragraphs relating to uncontained engine failures.

a. *Related Joint Aviation Requirements.* Sections which prescribe requirements for the design, substantiation and certification relating to uncontained engine debris include:

§ 23.863, 25.863	Flammable fluid fire protection
§ 25.365	Pressurised compartment loads
§ 25.571	Damage-tolerance and fatigue evaluation of structure
§ 25.963	Fuel tanks: general
§ 25.1189	Shut-off means
§ 25.1461	Equipment containing high energy rotors
CS–APU	Auxiliary Power Units

NOTE: The provisions of § 25.1461 have occasionally been used in the approval of APU installations regardless of protection from high energy rotor disintegration. However, the more specific requirements of CS 25.903(d)(1) and associated guidance described within this AMC take precedence over the requirements of CS 25.1461.

b. *Other Documents*

ISO 2685:1992 Aircraft – Environmental conditions and test procedures for airborne equipment – Resistance to fire in designated fire zones

AC 20–135 Powerplant Installation and Propulsion System Component Fire Protection Test Methods, Standards, and Criteria.

AMC 20-128A

c. *Society of Automotive Engineers (SAE) Documents.*

AIR1537	Report on Aircraft Engine Containment, October, 1977.
AIR4003	Uncontained Turbine Rotor Events Data Period 1976 through 1983.
AIR4770	Uncontained Turbine Rotor Events Data Period 1984 (Draft) through 1989.

These documents can be obtained from the Society of Automotive Engineers, Inc., 400 Commonwealth Drive, Warrendale, Pennsylvania, 15096.

5 *BACKGROUND.* Although turbine engine and APU manufacturers are making efforts to reduce the probability of uncontained rotor failures, service experience shows that uncontained compressor and turbine rotor failures continue to occur. Turbine engine failures have resulted in high velocity fragment penetration of adjacent structures, fuel tanks, fuselage, system components and other engines on the aeroplane. While APU uncontained rotor failures do occur, and to date the impact damage to the aeroplane has been minimal, some rotor failures do produce fragments that should be considered. Since it is unlikely that uncontained rotor failures can be completely eliminated, CS-23 and CS-25 require that aeroplane design precautions be taken to minimise the hazard from such events.

a. *Uncontained gas turbine engine rotor failure* statistics are presented in the Society of Automotive Engineers (SAE) reports covering time periods and number of uncontained events listed in the table shown below. The following statistics summarise 28 years of service experience for fixed wing aeroplanes and do not include data for rotorcraft and APUs:

Report No.	Period	No. of Events		
		Total	Category 3	Category 4
AIR1537	1962-75	275	44	5
AIR4003	1976-83	237	27	3
AIR4770 (Draft)	1984-89	164	22	7
TOTAL		676	93	15

The total of 676 uncontained events includes 93 events classified in Category 3 and 15 events classified in Category 4 damage to the aeroplane. Category 3 damage is defined as significant aeroplane damage with the aeroplane capable of continuing flight and making a safe landing. Category 4 damage is defined as severe aeroplane damage involving a crash landing, critical injuries, fatalities or hull loss.

During this 28 year period there were 1,089.6 million engine operating hours on commercial transports. The events were caused by a wide variety of influences classed as environmental (bird ingestion, corrosion/erosion, foreign object damage (FOD)), manufacturing and material defects, mechanical, and human factors (maintenance and overhaul, inspection error and operational procedures).

b. *Uncontained APU rotor failure statistics* covering 1962 through 1993 indicate that there have been several uncontained failures in at least 250 million hours of operation on transport category aeroplanes. No Category 3 or 4 events were reported and all failures occurred during ground operation. These events were caused by a wide variety of influences such as corrosion, ingestion of de-icing fluid, manufacturing and material defects, mechanical, and human factors (maintenance and overhaul, inspection error and operational procedures).

c. *The statistics in the SAE studies indicate* the existence of many different causes of failures not readily apparent or predictable by failure analysis methods. Because of the variety of causes of uncontained rotor failures, it is difficult to anticipate all possible causes of failure and to provide protection to all areas. However, design considerations outlined in this AMC provide guidelines for achieving the desired objective of minimising the hazard to an aeroplane from uncontained rotor failures. These guidelines, therefore, assume a rotor failure will occur and that analysis of the effects of this failure is necessary. These guidelines are based on service experience and tests but are not necessarily the only means available to the designer.

6 TERMINOLOGY.

a. *Rotor.* Rotor means the rotating components of the engine and APU that analysis, test, and/or experience has shown can be released during uncontained failure. The engine or APU manufacturer should define those components that constitute the rotor for each engine and APU type design. Typically rotors have included, as a minimum, discs, hubs, drums, seals, impellers, blades and spacers.

b. *Blade.* The airfoil sections (excluding platform and root) of the fan, compressor and turbine.

c. *Uncontained Failure.* For the purpose of aeroplane evaluations in accordance with this AMC, uncontained failure of a turbine engine is any failure which results in the escape of rotor fragments from the engine or APU that could result in a hazard. Rotor failures which are of concern are those where released fragments have sufficient energy to create a hazard to the aeroplane.

d. *Critical Component.* A critical component is any component whose failure would contribute to or cause a failure condition which would prevent the continued safe flight and landing of the aeroplane. These components should be considered on an individual basis and in relation to other components which could be damaged by the same fragment or by other fragments from the same uncontained event.

e. *Continued Safe Flight and Landing.* Continued safe flight and landing means that the aeroplane is capable of continued controlled flight and landing, possibly using emergency procedures and without exceptional pilot skill or strength, with conditions of considerably increased flightcrew workload and degraded flight characteristics of the aeroplane.

f. *Fragment Spread Angle.* The fragment spread angle is the angle measured, fore and aft from the centre of the plane of rotation of an individual rotor stage, initiating at the engine or APU shaft centreline (see Figure 1).

INTENTIONALLY LEFT BLANK

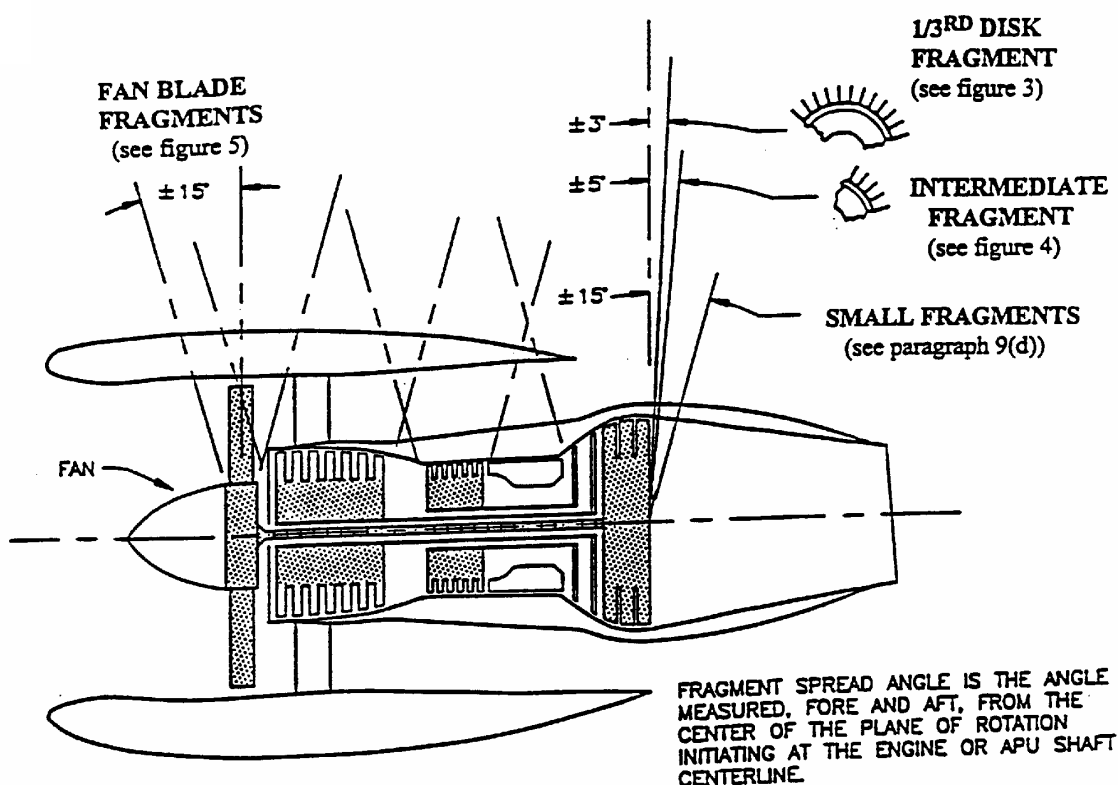

FIGURE 1 – ESTIMATED PATH OF FRAGMENTS

g. *Impact Area.* The impact area is that area of the aeroplane likely to be impacted by uncontained fragments generated during a rotor failure (see Paragraph 9).

h. *Engine and APU Failure Model.* A model describing the size, mass, spread angle, energy level and number of engine or APU rotor fragments to be considered when analysing the aeroplane design is presented in Paragraph 9.

7 *DESIGN CONSIDERATIONS.* Practical design precautions should be used to minimise the damage that can be caused by uncontained engine and APU rotor fragments. The most effective methods for minimising the hazards from uncontained rotor fragments include location of critical components outside the fragment impact areas or separation, isolation, redundancy, and shielding of critical aeroplane components and/or systems. The following design considerations are recommended:

a. *Consider the location of the engine and APU rotors* relative to critical components, systems or areas of the aeroplane such as:

- (1) Any other engine(s) or an APU that provides an essential function;
- (2) Pressurised sections of the fuselage and other primary structure of the fuselage, wings and empennage;
- (3) Pilot compartment areas;
- (4) Fuel system components, piping and tanks;

- (5) Control systems, such as primary and secondary flight controls, electrical power cables, wiring, hydraulic systems, engine control systems, flammable fluid shut-off valves, and the associated actuation wiring or cables;
- (6) Any fire extinguisher system of a cargo compartment, an APU, or another engine including electrical wiring and fire extinguishing agent plumbing to these systems;
- (7) Engine air inlet attachments and effects of engine case deformations caused by fan blade debris resulting in attachment failures;
- (8) Instrumentation essential for continued safe flight and landing;
- (9) Thrust reverser systems where inadvertent deployment could be catastrophic; and
- (10) Oxygen systems for high altitude aeroplanes, where these are critical due to descent time.

b. *Location of Critical Systems and Components.* Critical aeroplane flight and engine control cables, wiring, flammable fluid carrying components and lines (including vent lines), hydraulic fluid lines and components, and pneumatic ducts should be located to minimise hazards caused by uncontained rotors and fan blade debris. The following design practices should be considered:

- (1) Locate, if possible, critical components or systems outside the likely debris impact areas.
- (2) Duplicate and separate critical components or systems, or provide suitable protection if located in debris impact areas.
- (3) Protection of critical systems and components can be provided by using airframe structure or supplemental shielding.

These methods have been effective in mitigating the hazards from both single and multiple small fragments within the $\pm 15^\circ$ impact area. Separation of multiplied critical systems and components by at least a distance equal to the 1/2 blade fragment dimension has been accepted for showing minimisation from a single high energy small fragment when at least one of the related multiplied critical components is shielded by significant structure such as aluminium lower wing skins, pylons, aluminium skin of the cabin pressure vessel, or equivalent structures.

Multiplied critical systems and components positioned behind less significant structures should be separated by at least a distance equal to the 1/2 blade fragment dimension, and at least one of the multiplied critical systems should be:

- (i) Located such that equivalent protection is provided by other inherent structures such as pneumatic ducting, interiors, bulkheads, stringers, or
 - (ii) Protected by an additional shield such that the airframe structure and shield material provide equivalent shielding.
- (4) Locate fluid shut-offs and actuation means so that flammable fluid can be isolated in the event of damage to the system.
 - (5) Minimise the flammable fluid spillage which could contact an ignition source.
 - (6) For airframe structural elements, provide redundant designs or crack stoppers to limit the subsequent tearing which could be caused by uncontained rotor fragments.
 - (7) Locate fuel tanks and other flammable fluid systems and route lines (including vent lines) behind aeroplane structure to reduce the hazards from spilled fuel or from tank penetrations. Fuel tank

AMC 20-128A

explosion-suppression materials, protective shields or deflectors on the fluid lines, have been used to minimise the damage and hazards.

c. *External Shields and Deflectors.* When shields, deflection devices or aeroplane structure are proposed to be used to protect critical systems or components, the adequacy of the protection, including mounting points to the airframe structure, should be shown by testing or validated analyses supported by test data, using the fragment energies supplied by the engine or APU manufacturer or those defined in Paragraph 9. For protection against engine small fragments, as defined in Paragraph 9, no quantitative validation as defined in Paragraph 10 is required if equivalency to the penetration resistant structures listed (e.g. pressure cabin skins, etc.) is shown.

8 *ACCEPTED DESIGN PRECAUTIONS.* Design practices currently in use by the aviation industry that have been shown to reduce the overall risk, by effectively eliminating certain specific risks and reducing the remaining specific risks to a minimum level, are described within this paragraph of the AMC. Aeroplane designs submitted for evaluation by the regulatory authorities will be evaluated against these proven design practices.

a. *Uncontrolled Fire.*

(1) *Fire Extinguishing Systems.* The engine/APU fire extinguishing systems currently in use rely on a fire zone with a fixed compartment air volume and a known air exchange rate to extinguish a fire. The effectiveness of this type of system along with firewall integrity may therefore be compromised for the torn/ruptured compartment of the failed engine/APU. Protection of the aeroplane following this type of failure relies on the function of the fire warning system and subsequent fire switch activation to isolate the engine/APU from airframe flammable fluid (fuel and hydraulic fluid) and external ignition sources (pneumatic and electrical). Fire extinguishing protection of such a compromised system may not be effective due to the extent of damage. Continued function of any other engine, APU or cargo compartment fire warning and extinguisher system, including electrical wiring and fire extinguishing agent plumbing, should be considered as described in Paragraph 7.

(2) *Flammable Fluid Shut-off Valve.* As discussed above, shut-off of flammable fluid supply to the engine may be the only effective means to extinguish a fire following an uncontained failure, therefore the engine isolation/flammable fluid shut-off function should be assured following an uncontained rotor failure. Flammable fluid shut-off valves should be located outside the uncontained rotor impact area. Shut-off actuation controls that need to be routed through the impact area should be redundant and appropriately separated in relation to the one-third disc maximum dimension.

(3) *Fire Protection of Critical Functions.* Flammable fluid shut-off and other critical controls should be located so that a fire (caused by an uncontained rotor event) will not prevent actuation of the shut-off function or loss of critical aeroplane functions. If shut-off or other critical controls are located where a fire is possible following an uncontained rotor failure (e.g. in compartments adjacent to fuel tanks) then these items should meet the applicable fire protection guidelines such as ISO 2685:1992 or AC 20-135.

(4) *Fuel Tanks.* If fuel tanks are located in impact areas, the following precautions should be implemented:

(i) Protection from the effects of fuel leakage should be provided for any fuel tanks located above an engine or APU and within the one-third disc and intermediate fragment impact areas. Dry bays or shielding are acceptable means. The dry bay should be sized based on analysis of possible fragment trajectories through the fuel tank wall and the subsequent fuel leakage from the damaged fuel tank so that fuel will not migrate to an engine, APU or other ignition source during either – flight or ground operation. A minimum drip clearance distance of 10 inches (254 mm) from potential ignition sources of the engine nacelle, for static conditions, has been acceptable (see Figure 2).

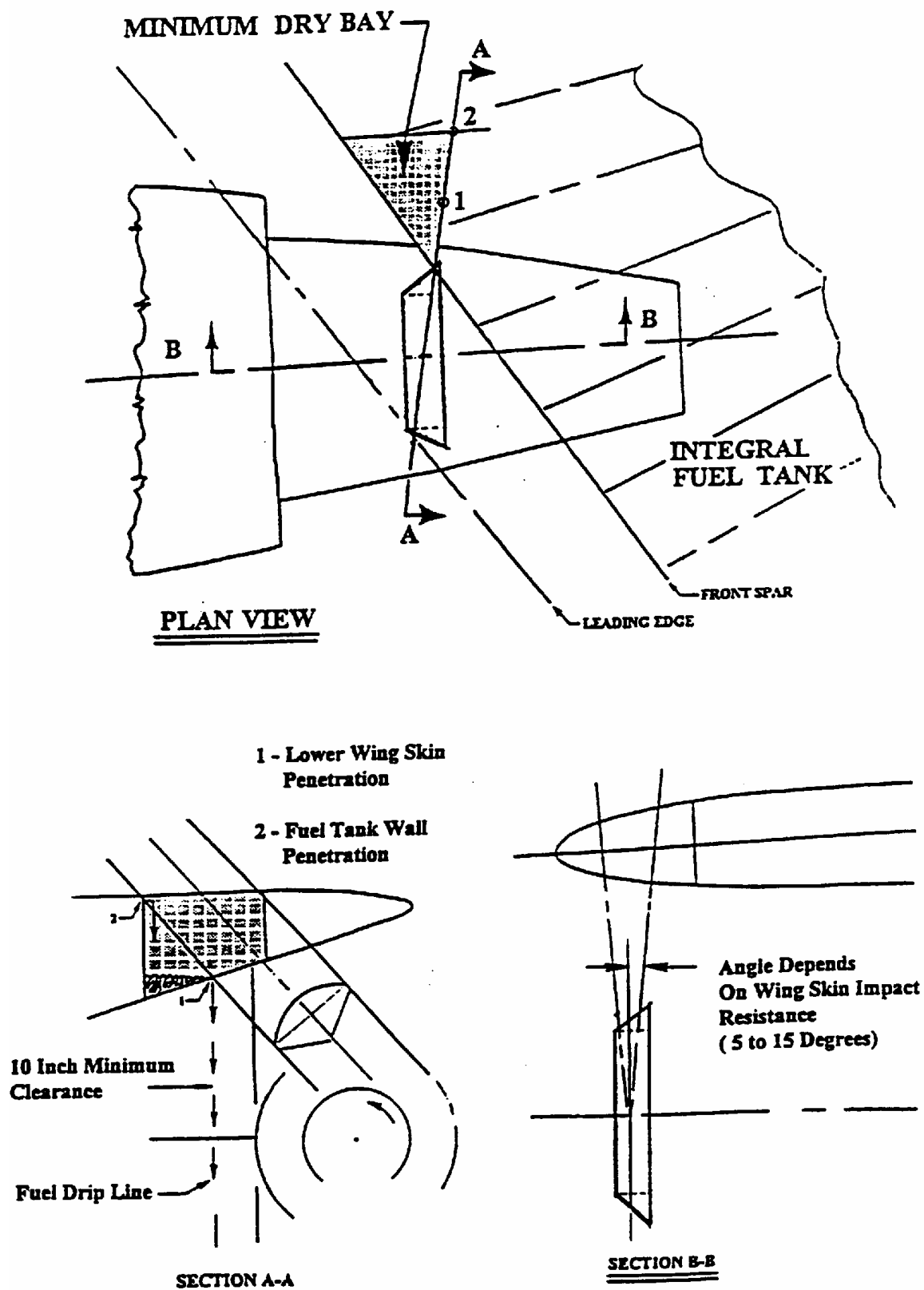

FIGURE 2 - DRY BAY SIZING DETERMINATION EXAMPLE

AMC 20-128A

(ii) Fuel tank penetration leak paths should be determined and evaluated for hazards during flight and ground phases of operation. If fuel spills into the airstream away from the aeroplane no additional protection is needed. Additional protection should be considered if fuel could spill, drain or migrate into areas housing ignition sources, such as engine or APU inlets or wheel wells. Damage to adjacent systems, wiring etc., should be evaluated regarding the potential that an uncontained fragment will create both an ignition source and fuel source. Wheel brakes may be considered as an ignition source during take-off and initial climb. Protection of the wheel wells may be provided by airflow discharging from gaps or openings, preventing entry of fuel, a ventilation rate precluding a combustible mixture or other provisions indicated in CS 23.863 and CS 25.863.

(iii) Areas of the aeroplane where flammable fluid migration is possible that are not drained and vented and have ignition sources or potential ignition sources should be provided with a means of fire detection and suppression and be explosion vented or equivalently protected.

b. *Loss of Thrust.*

(1) *Fuel Reserves.* The fuel reserves should be isolatable such that damage from a disc fragment will not result in loss of fuel required to complete the flight or a safe diversion. The effects of fuel loss, and the resultant shift of centre of gravity or lateral imbalance on aeroplane controllability should also be considered.

(2) *Engine Controls.* Engine control cables and/or wiring for the remaining powerplants that pass through the impact area should be separated by a distance equal to the maximum dimension of a one-third disc fragment or the maximum extent possible.

(3) *Other Engine Damage.* Protection of any other engines from some fragments should be provided by locating critical components, such as engine accessories essential for proper engine operation (e.g., high pressure fuel lines, engine controls and wiring, etc.), in areas where inherent shielding is provided by the fuselage, engine or nacelle (including thrust reverser) structure (see Paragraph 7).

c. *Loss of Aeroplane Control*

(1) *Flight Controls.* Elements of the flight control system should be adequately separated or protected so that the release of a single one-third disc fragment will not cause loss of control of the aeroplane in any axis. Where primary flight controls have duplicated (or multiplicated) elements, these elements should be located to prevent all elements in any axis being lost as a result of the single one-third disc fragment. Credit for maintaining control of the aeroplane by the use of trim controls or other means may be obtained, providing evidence shows that these means will enable the pilot to retain control.

(2) *Emergency Power.* Loss of electrical power to critical functions following an uncontained rotor event should be minimised. The determination of electrical system criticality is dependent upon aeroplane operations. For example, aeroplanes approved for Extended Twin Engine Operations (ETOPS) that rely on alternate power sources such as hydraulic motor generators or APUs may be configured with the electrical wiring separated to the maximum extent possible within the one-third disc impact zone.

(3) *Hydraulic Supply.* Any essential hydraulic system supply that is routed within an impact area should have means to isolate the hydraulic supply required to maintain control of the aeroplane. The single one-third disc should not result in loss of all essential hydraulic systems or loss of all flight controls in any axis of the aeroplane.

(4) *Thrust reverser systems.* The effect of an uncontained rotor failure on inadvertent in-flight deployment of each thrust reverser and possible loss of aeroplane control shall be considered. The impact area for components located on the failed engine may be different from the impact area defined in Paragraph 6. If uncontained failure could cause thrust reverser deployment, the engine

manufacturer should be consulted to establish the failure model to be considered. One acceptable method of minimisation is to locate reverser restraints such that not all restraints can be made ineffective by the fragments of a single rotor.

d. *Passenger and Crew Incapacitation.*

(1) *Pilot Compartment.* The pilot compartment of large aeroplanes should not be located within the $\pm 15^\circ$ spread angle of any engine rotor stage or APU rotor stage that has not been qualified as contained, unless adequate shielding, deflectors or equivalent protection is provided for the rotor stage in accordance with Paragraph 7c. Due to design constraints inherent in smaller CS-23 aeroplanes, it is not considered practical to locate the pilot compartment outside the $\pm 15^\circ$ spread angle. Therefore for other aeroplanes (such as new CS-23 commuter category aeroplanes) the pilot compartment area should not be located within the $\pm 5^\circ$ spread angle of any engine rotor stage or APU rotor stage unless adequate shielding, deflectors, or equivalent protection is provided for the rotor stage in accordance with Paragraph 7c of this AMC, except for the following:

(i) For derivative CS-23 category aeroplanes where the engine location has been previously established, the engine location in relation to the pilot compartment need not be changed.

(ii) For non-commuter CS-23 category aeroplanes, satisfactory service experience relative to rotor integrity and containment in similar engine installations may be considered in assessing the acceptability of installing engines in line with the pilot compartment.

(iii) For non-commuter new CS-23 category aeroplanes, where due to size and/or design considerations the $\pm 5^\circ$ spread angle cannot be adhered to, the pilot compartment/engine location should be analysed and accepted in accordance with Paragraphs 9 and 10.

(2) *Pressure Vessel.* For aeroplanes that are certificated for operation above 41,000 feet, the engines should be located such that the pressure cabin cannot be affected by an uncontained one-third or intermediate disc fragment. Alternatively, it may be shown that rapid decompression due to the maximum hole size caused by fragments within the $\pm 15^\circ$ zone and the associated cabin pressure decay rate will allow an emergency descent without incapacitation of the flightcrew or passengers. A pilot reaction time of 17 seconds for initiation of the emergency descent has been accepted. Where the pressure cabin could be affected by a one-third disc or intermediate fragments, design precautions should be taken to preclude incapacitation of crew and passengers. Examples of design precautions that have been previously accepted are:

(i) Provisions for a second pressure or bleed down bulkhead outside the impact area of a one-third or intermediate disc fragment.

(ii) The affected compartment in between the primary and secondary bulkhead was made inaccessible, by operating limitations, above the minimum altitude where incapacitation could occur due to the above hole size.

(iii) Air supply ducts running through this compartment were provided with non-return valves to prevent pressure cabin leakage through damaged ducts.

NOTE: If a bleed down bulkhead is used it should be shown that the rate of pressure decay and minimum achieved cabin pressure would not incapacitate the crew, and the rate of pressure decay would not preclude a safe emergency descent.

e. *Structural Integrity.* Installation of tear straps and shear ties within the uncontained fan blade and engine rotor debris zone to prevent catastrophic structural damage has been utilised to address this threat.

9. *ENGINE AND APU FAILURE MODEL.* The safety analysis recommended in Paragraph 10 should be made using the following engine and APU failure model, unless for the particular engine/APU type concerned, relevant service experience, design data, test results or other evidence justify the use of a different model.

a. *Single One-Third Disc fragment.* It should be assumed that the one-third disc fragment has the maximum dimension corresponding to one-third of the disc with one-third blade height and a fragment spread angle of $\pm 3^\circ$. Where energy considerations are relevant, the mass should be assumed to be one-third of the bladed disc mass and its energy, the translational energy (i.e., neglecting rotational energy) of the sector travelling at the speed of its c.g. location as defined in Figure 3.

b. *Intermediate Fragment.* It should be assumed that the intermediate fragment has a maximum dimension corresponding to one-third of the bladed disc radius and a fragment spread angle of $\pm 5^\circ$. Where energy considerations are relevant, the mass should be assumed to be 1/30 of the bladed disc mass and its energy the transitional energy (i.e. neglecting rotational energy) of the piece travelling at rim speed (see Figure 4).

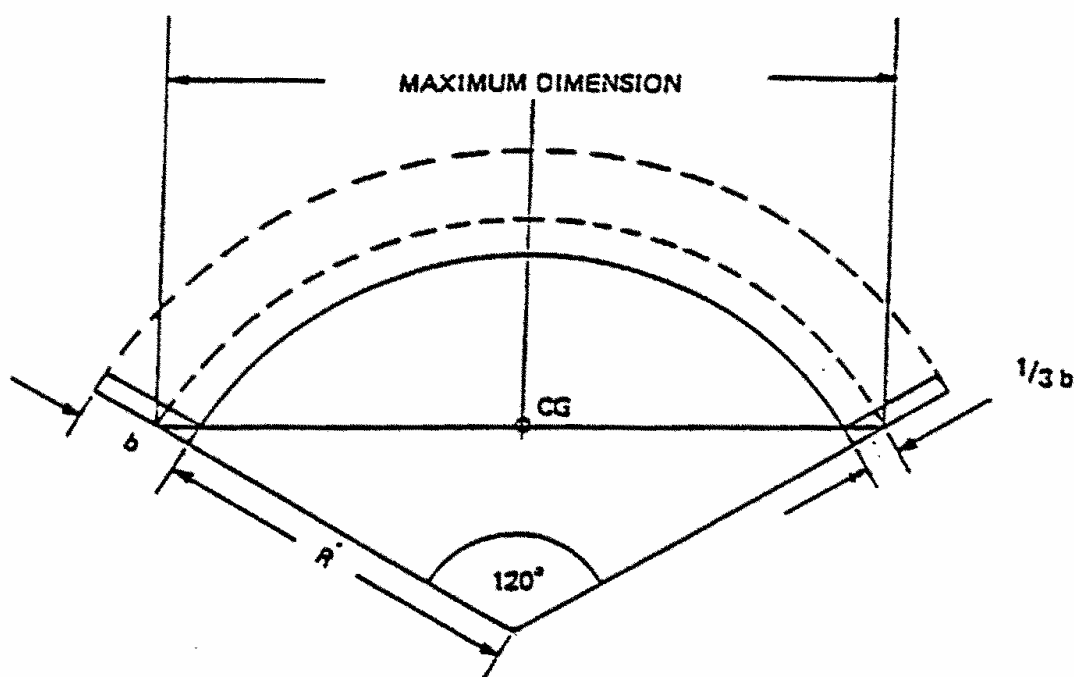

Where R = disc radius
 b = blade length

The CG is taken to lie on the maximum dimension as shown.

FIGURE 3 – SINGLE ONE-THIRD ROTOR FRAGMENT

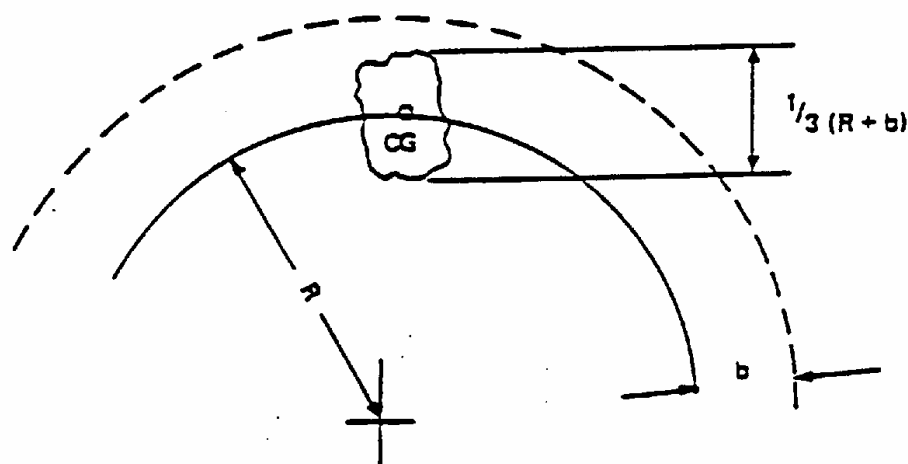

Where R = disc radius
 b = blade length

Maximum dimension = $\frac{1}{3} (R + b)$

Mass assumed to be $\frac{1}{30}$ th of bladed disc

CG is taken to lie on the disc rim

FIGURE 4 – INTERMEDIATE FRAGMENT

c. *Alternative Engine Failure Model.* For the purpose of the analysis, as an alternative to the engine failure model of Paragraphs 9a and b, the use of a single one-third piece of disc having a fragment spread angle $\pm 5^\circ$ would be acceptable, provided the objectives of Paragraph 10c are satisfied.

d. *Small Fragments.* It should be assumed that small fragments (shrapnel) range in size up to a maximum dimension corresponding to the tip half of the blade airfoil (with exception of fan blades) and a fragment spread angle of $\pm 15^\circ$. Service history has shown that aluminium lower wing skins, pylons, and pressure cabin skin and equivalent structures typically resist penetration from all but one of the most energetic of these fragments. The effects of multiple small fragments should also be considered. Penetration of less significant structures such as fairings, empennage, control surfaces and unpressurised unpressurized skin has typically occurred at the rate of $2\frac{1}{2}$ percent of the number of blades of the failed rotor stage. Refer to paragraph 7b and 7c for methods of minimisation of the hazards. Where the applicant wishes to show compliance by considering the energy required for penetration of structure (or shielding) the engine manufacturer should be consulted for guidance as to the size and energy of small fragments within the impact area.

For APUs, where energy considerations are relevant, it should be assumed that the mass will correspond to the above fragment dimensions and that it has a translational energy level of one percent of the total rotational energy of the original rotor stage.

e. *Fan Blade Fragment.* It should be assumed that the fan blade fragment has a maximum dimension corresponding to the blade tip with one-third the blade airfoil height and a fragment spread angle of $\pm 15^\circ$. Where energy considerations are relevant the mass should be assumed to be corresponding to the one-third of the airfoil including any part span shroud and the transitional energy (neglecting rotational energy) of the fragment travelling at the speed of its c.g. location as defined in

Figure 5. As an alternative, the engine manufacturer may be consulted for guidance as to the size and energy of the fragment.

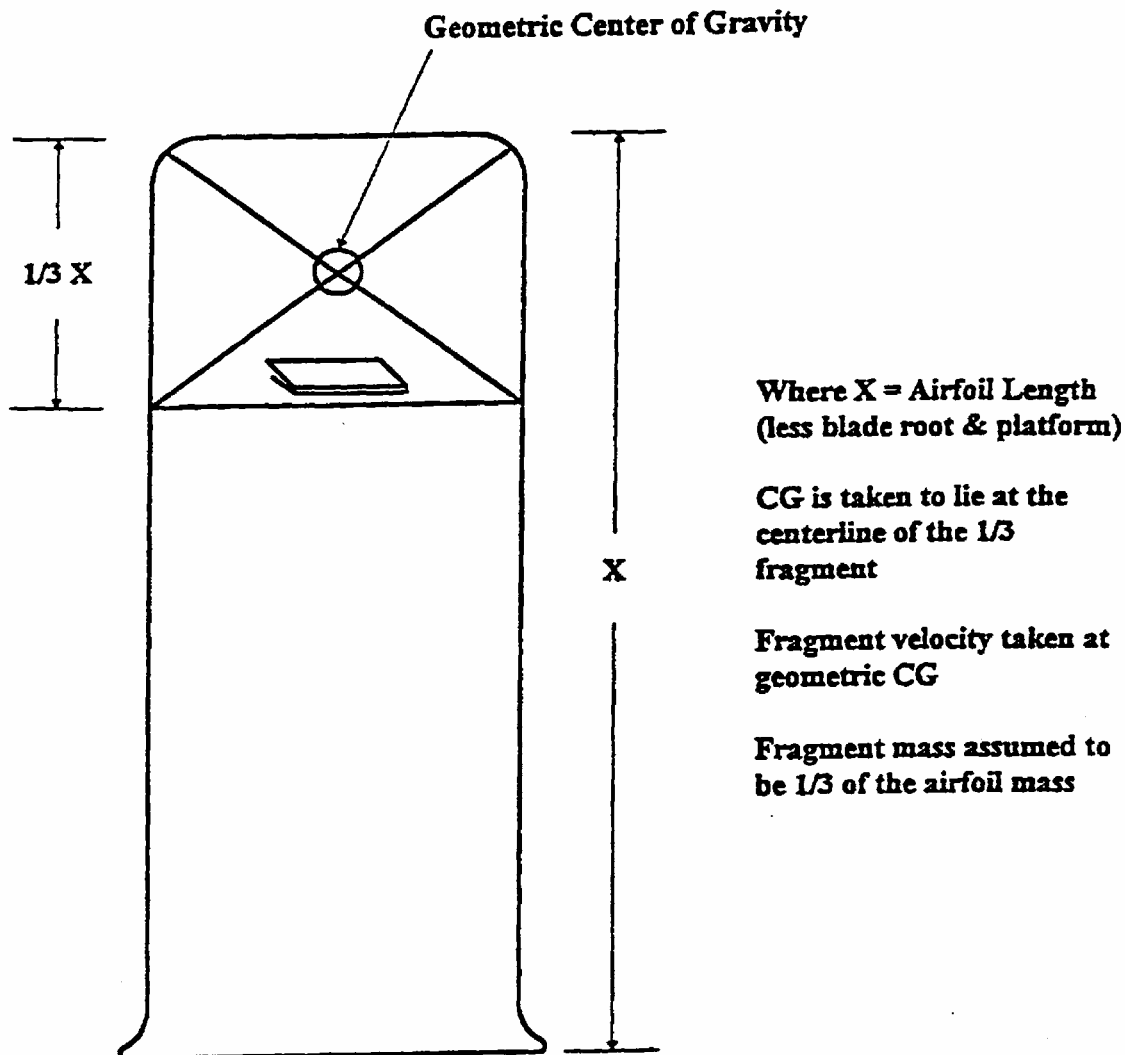

FIGURE 5 – FAN BLADE FRAGMENT DEFINITION

f. *Critical Engine Speed.* Where energy considerations are relevant, the uncontained rotor event should be assumed to occur at the engine or APU shaft red line speed.

g. *APU Failure Model.* For all APU's, the installer also needs to address any hazard to the aeroplane associated with APU debris (up to and including a complete rotor where applicable) exiting the tailpipe. Paragraphs 9g(1) or (2) below or applicable service history provided by the APU manufacturer may be used to define the size, mass, and energy of debris exiting that tailpipe. The APU rotor failure model applicable for a particular APU installation is dependent upon the provisions of CS-APU that were utilised for receiving approval:

(1) For APU's where rotor integrity has been demonstrated in accordance with CS-APU, i.e. without specific containment testing, Paragraphs 9a, b, and d, or Paragraphs 9c and 9d apply.

(2) For APU rotor stages qualified as contained in accordance with CS-APU, historical data shows that in-service uncontained failures have occurred. These failure modes have included bi-hub, overspeed, and fragments missing the containment ring which are not addressed by the CS-APU containment test. In order to address these hazards, the installer should use the APU small fragment definition of Paragraph 9d or substantiated in-service data supplied by the APU manufacturer.

10 SAFETY ANALYSIS.

The numerical assessment requested in Paragraph 10c(3) is derived from methods previously prescribed in ACJ No. 2 to CS 25.903(d)(1). The hazard ratios provided are based upon evaluation of various configurations of large aeroplanes, made over a period of time, incorporating practical methods of minimising the hazard to the aeroplane from uncontained engine debris.

a. *Analysis.* An analysis should be made using the engine/APU model defined in Paragraph 9 to determine the critical areas of the aeroplane likely to be damaged by rotor debris and to evaluate the consequences of an uncontained failure. This analysis should be conducted in relation to all normal phases of flight, or portions thereof.

NOTE: APPENDIX 1 provides additional guidance for completion of the numerical analysis requested by this paragraph.

(1) A delay of at least 15 seconds should be assumed before start of the emergency engine shut down. The extent of the delay is dependent upon circumstances resulting from the uncontained failure including increased flightcrew workload stemming from multiplicity of warnings which require analysis by the flightcrew.

(2) Some degradation of the flight characteristics of the aeroplane or operation of a system is permissible, provided the aeroplane is capable of continued safe flight and landing. Account should be taken of the behaviour of the aeroplane under asymmetrical engine thrust or power conditions together with any possible damage to the flight control system, and of the predicted aeroplane recovery manoeuvre.

(3) When considering how or whether to mitigate any potential hazard identified by the model, credit may be given to flight phase, service experience, or other data, as noted in Paragraph 7.

b. *Drawings.* Drawings should be provided to define the uncontained rotor impact threat relative to the areas of design consideration defined in Paragraphs 7a(1) through (10) showing the trajectory paths of engine and APU debris relative to critical areas. The analysis should include at least the following:

(1) Damage to primary structure including the pressure cabin, engine/APU mountings and airframe surfaces.

NOTE: Any structural damage resulting from uncontained rotor debris should be considered catastrophic unless the residual strength and flutter criteria of ACJ 25.571(a) subparagraph 2.7.2 can be met without failure of any part of the structure essential for completion of the flight. In addition, the pressurised compartment loads of CS 25.365(e)(1) and (g) must be met.

(2) Damage to any other engines (the consequences of subsequent uncontained debris from the other engine(s), need not be considered).

(3) Damage to services and equipment essential for safe flight and landing (including indicating and monitoring systems), particularly control systems for flight, engine power, engine fuel supply and shut-off means and fire indication and extinguishing systems.

(4) Pilot incapacitation, (see also paragraph 8 d(1)).

AMC 20-128A

- (5) Penetration of the fuel system, where this could result in the release of fuel into personnel compartments or an engine compartment or other regions of the aeroplane where this could lead to a fire or explosion.
- (6) Damage to the fuel system, especially tanks, resulting in the release of a large quantity of fuel.
- (7) Penetration and distortion of firewalls and cowling permitting a spread of fire.
- (8) Damage to or inadvertent movement of aerodynamic surfaces (e.g.. flaps, slats, stabilisers, ailerons, spoilers, thrust reversers, elevators, rudders, strakes, winglets, etc.) and the resultant effect on safe flight and landing.

c. *Safety Analysis Objectives.* It is considered that the objective of minimising hazards will have been met if:

- (1) The practical design considerations and precautions of Paragraphs 7 and 8 have been taken;
- (2) The safety analysis has been completed using the engine/APU model defined in Paragraph 9;
- (3) For CS-25 large aeroplanes and CS-23 commuter category aeroplanes, the following hazard ratio guidelines have been achieved:
 - (i) **Single One-Third Disc Fragment.** There is not more than a 1 in 20 chance of catastrophe resulting from the release of a single one-third disc fragment as defined in Paragraph 9a.
 - (ii) **Intermediate Fragment.** There is not more than a 1 in 40 chance of catastrophe resulting from the release of a piece of debris as defined in Paragraph 9b.
 - (iii) **Multiple Disc Fragments.** (Only applicable to any duplicated or multiplicated system when all of the system channels contributing to its functions have some part which is within a distance equal to the diameter of the largest bladed rotor, measured from the engine centreline). There is not more than 1 in 10 chance of catastrophe resulting from the release in three random directions of three one-third fragments of a disc each having a uniform probability of ejection over the 360° (assuming an angular spread of $\pm 3^\circ$ relative to the plane of the disc) causing coincidental damage to systems which are duplicated or multiplicated.

NOTE: Where dissimilar systems can be used to carry out the same function (e.g. elevator control and pitch trim), they should be regarded as duplicated (or multiplicated) systems for the purpose of this subparagraph provided control can be maintained.

The numerical assessments described above may be used to judge the relative values of minimisation. The degree of minimisation that is feasible may vary depending upon aeroplane size and configuration and this variation may prevent the specific hazard ratio from being achieved. These levels are design goals and should not be treated as absolute targets. It is possible that any one of these levels may not be practical to achieve.

- (4) For newly designed non-commuter CS-23 aeroplanes the chance of catastrophe is not more than twice that of Paragraph 10(c)(3)(i), (ii) and (iii) for each of these fragment types.
- (5) A numerical risk assessment is not requested for the single fan blade fragment, small fragments, and APU and engine rotor stages which are qualified as contained.

d. *APU Analysis* For APU's that are located where no hazardous consequences would result from an uncontained failure, a limited qualitative assessment showing the relative location of critical systems/components and APU impact areas is all that is needed. If critical systems/components are located within the impact area, more extensive analysis is needed. For APUs which have demonstrated rotor integrity only, the failure model outlined in Paragraph 9g(1) should be considered

as a basis for this safety assessment. For APU rotor stages qualified as contained per CS-APU, the aeroplane safety analysis may be limited to an assessment of the effects of the failure model outlined in Paragraph 9g(2).

e. *Specific Risk* The aeroplane risk levels specified in Paragraph 10c, resulting from the release of rotor fragments, are the mean values obtained by averaging those for all rotors on all engines of the aeroplane, assuming a typical flight. Individual rotors or engines need not meet these risk levels nor need these risk levels be met for each phase of flight if either:

- (1) No rotor stage shows a higher level of risk averaged throughout the flight greater than twice those stated in Paragraph 10c.

NOTE: The purpose of this Paragraph is to ensure that a fault which results in repeated failures of any particular rotor stage design, would have only a limited effect on aeroplane safety.

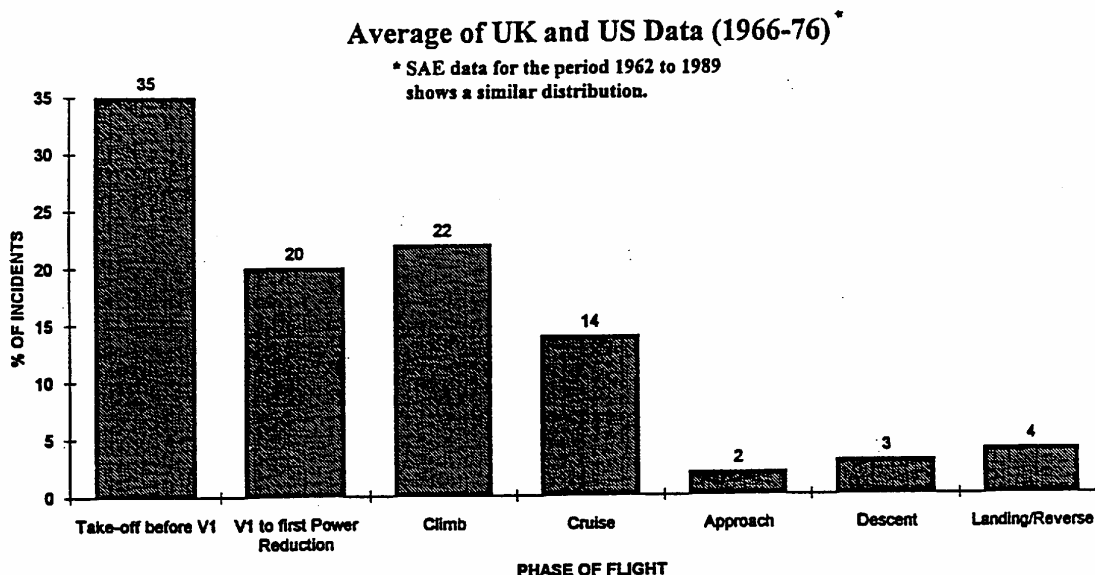

FIGURE 6 – ALL NON-CONTAINMENTS BY PHASE OF FLIGHT

(2) Where failures would be catastrophic in particular portions of flight, allowance is made for this on the basis of conservative assumptions as to the proportion of failures likely to occur in these phases. A greater level of risk could be accepted if the exposure exists only during a particular phase of flight e.g., during take-off. The proportional risk of engine failure during the particular phases of flight is given in SAE Papers referenced in Paragraph 4d. See also data contained in the CAA paper "Engine Non-Containments – The CAA View", which includes Figure 6. This paper is published in NASA Report CP-2017, "An Assessment of Technology for Turbo-jet Engine Rotor Failures", dated August 1977.

AMC 20-128A

INTENTIONALLY LEFT BLANK

APPENDIX 1

AMC 20-128A USER'S MANUAL

RISK ANALYSIS METHODOLOGY
for UNCONTAINED ENGINE/APU FAILURE

INDEX

1.0	GENERAL
2.0	SCOPE
3.0	FUNDAMENTAL COMPONENTS OF A SAFETY AND RISK ANALYSIS
4.0	ASSUMPTIONS
5.0	PLOTTING
6.0	METHODOLOGY – PROBABILITY ASSESSMENT
7.0	RESULTS ASSESSMENT

FIGURE 1	EXAMPLE – HAZARD TREE
FIGURE 2	EXAMPLE – SYSTEM LOADING MATRIX
FIGURE 3	TRI-SECTOR ROTOR BURST
FIGURE 4	TYPICAL LAYOUT OF SYSTEMS IN ROTOR PLANE
FIGURE 5	TRAJECTORY RANGE PLOTTING
FIGURE 6	TYPICAL TRAJECTORY PLOTTING
FIGURE 7	DEFINITION – THREAT WINDOW
FIGURE 8	SAMPLE ROTOR STAGE PLOTTING CHART

1.0 GENERAL

1.1 The design of aeroplane and engine systems and the location of the engines relative to critical systems and structure have a significant impact on survivability of the aeroplane following an uncontained engine failure. CS 23.903(b)(1) and 25.903(d)(1) of the EASA Certification Specifications (CS) require that design precautions be taken to minimise the hazard to the aeroplane due to uncontained failures of engine or auxiliary power unit (APU). AMC 20-128A provides guidance for demonstrating compliance with these requirements.

1.2 As a part of this compliance demonstration, it is necessary to quantitatively assess the risk of a catastrophic failure in the event of an uncontained engine failure. This User's Manual describes an acceptable method for this purpose.

1.3 The objective of the risk analysis is to measure the remaining risk after prudent and practical design considerations have been taken. Since each aeroplane would have unique features which must be considered when applying the methods described in this manual, there should be some flexibility in the methods and procedures.

1.4 It is a preferred approach to use these methods throughout the development of an aeroplane design to identify problem areas at an early stage when appropriate design changes are least disruptive. It is also advisable to involve the European Aviation Safety Agency (EASA) in this process at an early stage when appropriate interpretation of the methodology and documentation requirements can be established.

1.5 It should be noted that although the risk analysis produces quantitative results, subjective assessments are inherent in the methods of the analysis regarding the criticality of specific types of

AMC-20-128A Appendix 1

aeroplane component failures. Assumptions for such assessments should be documented along with the numerical results.

1.6 Aeroplane manufacturers have each developed their own method of assessing the effects of rotor failure, as there are many ways to get to the same result. This User's Manual identifies all the elements that should be contained in an analysis, so that it can be interpreted by a person not familiar with such a process.

1.7 The intent of this manual therefore is to aid in establishing how an analysis is prepared, without precluding any technological advances or existing proprietary processes.

1.8 AMC 20-128A makes allowance for the broad configuration of the aeroplane as such damage to the structure due to rotor failure generally allows for little flexibility in design. System lay-out within a rotor burst zone, however, can be optimized.

1.9 Damage to structure, which may involve stress analysis, generally can be analyzed separately, and later coordinated with simultaneous system effects.

1.10 For an analysis of the effects on systems due to a rotor failure the aeroplane must be evaluated as a whole; and a risk analysis must specifically highlight all critical cases identified which have any potential to result in a catastrophe.

1.11 Such an analysis can then be used to establish that reasonable precautions have been taken to minimise the hazards, and that the remaining hazards are an acceptable risk.

1.12 A safety and a risk analysis are interdependent, as the risk analysis must be based on the safety analysis.

The safety analysis therefore is the starting point that identifies potential hazardous or catastrophic effects from a rotor failure and is the basic tool to minimise the hazard in accordance with the guidelines of AMC 20-128A.

1.13 The risk analysis subsequently assesses and quantifies the residual risk to the aeroplane.

2.0 SCOPE

The following describes the scope of analyses required to assess the aeroplane risk levels against the criteria set forth in Paragraph 10 of AMC 20-128A.

2.1 Safety

Analysis is required to identify the critical hazards that may be numerically analyzed (hazards remaining after all practical design precautions have been taken).

Functional criticality will vary by aeroplane and may vary by flight phase.

Thorough understanding of each aeroplane structure and system functions is required to establish the criticality relative to each fragment trajectory path of the theoretical failure.

Assistance from experts within each discipline is typically required to assure accuracy of the analysis in such areas as effects of fuel tank penetration on leakage paths and ignition hazards, thrust level control (for loss of thrust assessment), structural capabilities (for fuselage impact assessment), aeroplane controllability (for control cables impact assessment), and fuel asymmetry.

2.2 Risk

For each remaining critical hazard, the following assessments may be prepared using the engine/APU failure models as defined in Paragraph 9 of AMC 20-128A:

- a. Flight mean risk for single 1/3 disc fragment.
- b. Flight mean risk for single intermediate fragment.
- c. Flight mean risk for alternate model (when used as an alternate to the 1/3 disc fragment and intermediate fragment).
- d. Multiple 1/3 disc fragments for duplicated or multiplicated systems.
- e. Specific risk for single 1/3 disc fragment and single intermediate fragment.
- f. Specific risk for any single disc fragment that may result in catastrophic structural damage.

The risk level criteria for each failure model are defined in Paragraph 10 of AMC 20-128A.

3.0 FUNDAMENTAL COMPONENTS OF A SAFETY AND RISK ANALYSIS

3.1 The logical steps for a complete analysis are:

- a. Establish at the design definition the functional hazards that can arise from the combined or concurrent failures of individual systems, including multiplicated systems and critical structure.
- b. Establish a Functional Hazard Tree (see Figure 1), or a System Matrix (see Figure 2) that identifies all system interdependencies and failure combinations that must be avoided (if possible) when locating equipment in the rotor burst impact area.

In theory, if this is carried out to the maximum, no critical system hazards other than opposite engine or fuel line hits would exist.

- c. Establish the fragment trajectories and trajectory ranges both for translational and spread risk angles for each damage. Plot these on a chart or graph, and identify the trajectory ranges that could result in hazardous combinations (threats) as per the above system matrix or functional hazard analysis.
- d. Apply risk factors, such as phase of flight or other, to these threats, and calculate the risk for each threat for each rotor stage.
- e. Tabulate, summarize and average all cases.

3.2 In accordance with AMC 20-128A the risk to the aeroplane due to uncontained rotor failure is assessed to the effects, once such a failure has occurred.

The probability of occurrence of rotor failure, as analyzed with the probability methods of AMC 25.1309 (i.e. probability as a function of critical uncontained rotor failure rate and exposure time), does not apply.

3.3 The total risk level to the aeroplane, as identified by the risk analysis, is the mean value obtained by averaging the values of all rotor stages of all engines of the aeroplane, expressed as Flight Mean Risk.

AMC-20-128A Appendix 1

4.0 ASSUMPTIONS

4.1 The following conservative assumptions, in addition to those in Paragraphs 10(a) (1), (2) and (3) of AMC 20-128A, have been made in some previous analyses. However, each aeroplane design may have unique characteristics and therefore a unique basis for the safety assessment leading to the possibility of different assumptions. All assumptions should be substantiated within the analysis:

a. The 1/3 disc fragment as modeled in Paragraph 9(a) of the AMC 20-128A travels along a trajectory path that is tangential to the sector centroid locus, in the direction of rotor rotation (Refer to Figure 3).

The sector fragment rotates about its centroid without tumbling and sweeps a path equal to twice the greatest radius that can be struck from the sector centroid that intersects its periphery.

The fragment is considered to possess infinite energy, and therefore to be capable of severing lines, wiring, cables and unprotected structure in its path, and to be undeflected from its original trajectory unless deflection shields are fitted. However, protective shielding or an engine being impacted may be assumed to have sufficient mass to stop even the most energetic fragment.

b. The probability of release of debris within the maximum spread angle is uniformly distributed over all directions.

c. The effects of severed electrical wiring are dependent on the configuration of the affected system. In general, severed wiring is assumed to not receive inadvertent positive voltage for any significant duration.

d. Control cables that are struck by a fragment disconnect.

e. Hydraulically actuated, cable driven control surfaces, which do not have designated "fail to" settings, tend to fail to null when control cables are severed. Subsequent surface float is progressive and predictable.

f. Systems components are considered unserviceable if their envelope has been touched. In case of an engine being impacted, the nacelle structure may be regarded as engine envelope, unless damage is not likely to be hazardous.

g. Uncontained events involving in-flight penetration of fuel tanks will not result in fuel tank explosion.

h. Unpowered flight and off-airport landings, including ditching, may be assumed to be not catastrophic to the extent validated by accident statistics or other accepted factors.

i. Damage to structure essential for completion of flight is catastrophic (Ref. AMC 20-128A, Paragraph 10.b(1)).

j. The flight begins when engine power is advanced for takeoff and ends after landing when turning off the runway.

5.0 PLOTTING

5.1 Cross-section and plan view layouts of the aeroplane systems in the ranges of the rotor burst impact areas should be prepared, either as drawings, or as computer models

These layouts should plot the precise location of the critical system components, including fuel and hydraulic lines, flight control cables, electric wiring harnesses and junction boxes, pneumatic and environmental system ducting, fire extinguishing; critical structure, etc.

5.2 For every rotor stage a plane is developed. Each of these planes contains a view of all the system components respective outer envelopes, which is then used to generate a cross-section. See Figure 4.

5.3 Models or drawings representing the various engine rotor stages and their fore and aft deviation are then generated.

5.4 The various trajectory paths generated for each engine rotor stage are then superimposed on the cross-section layouts of the station planes that are in the range of that potential rotor burst in order to study the effects (see Figure 5). Thus separate plots are generated for each engine rotor stage or rotor group.

To reduce the amount of an analysis the engine rotor stages may also be considered as groups, as applicable for the engine type, using the largest rotor stage diameter of the group.

5.5 These trajectory paths may be generated as follows and as shown in Figure 6:

- a. Two tangent lines T1 are drawn between the locus of the centroid and the target envelope.
- b. At the tangent line touch points, lines N1 and N2 normal to the tangent lines, are drawn with the length equal to the radius of the fragment swept path (as also shown in Figure 1).
- c. Tangent lines T2 are drawn between the terminal point of the normal lines and the locus of the centroid. The angle between these two tangent lines is the translational risk angle.

5.6 The entry and exit angles are then calculated.

5.7 The initial angle of intersection and the final angle of intersection are recorded, and the trajectories in between are considered to be the range of trajectories in which this particular part would be impacted by a rotor sector, and destroyed (i.e. the impact area).

The intersections thus recorded are then entered on charts in tabular form so that the simultaneous effects can be studied. Refer to Figure 8.

Thus it will be seen that the total systems' effects can be determined and the worst cases identified.

5.9 If a potentially serious multiple system damage case is identified, then a more detailed analysis of the trajectory range will be carried out by breaking the failure case down into the specific fore-aft spread angle, using the individual rotor stage width instead of combined groups, if applicable.

6.0 *METHODOLOGY – PROBABILITY ASSESSMENT*

6.1 Those rotor burst cases that have some potential of causing a catastrophe are evaluated in the analysis in an attempt to quantify an actual probability of a catastrophe, which will, in all cases, depend on the following factors:

- a. The location of the engine that is the origin of the fragment, and its direction of rotation.
- b. The location of critical systems and critical structure.
- c. The rotor stage and the fragment model.
- d. The translational trajectory of the rotor fragment,
- e. The specific spread angle range of the fragment.

AMC-20-128A Appendix 1

- f. The specific phase of the flight at which the failure occurs.
- g. The specific risk factor associated with any particular loss of function.

6.2 *Engine Location*

The analysis should address the effects on systems during one flight after a single rotor burst has occurred, with a probability of 1.0. As the cause may be any one of the engines, the risk from each engine is later averaged for the number of engines.

The analysis trajectory charts will then clearly show that certain system damage is unique to rotor fragments from a particular engine due to the direction of rotation, or, that for similar system damage the trajectory range varies considerably between engines.

A risk summary should table each engine case separately with the engine location included.

6.3 *Rotor Element*

The probability of rotor failure is assumed to be 1.0 for each of all rotor stages. For the analysis the individual risk(s) from each rotor stage of the engine should be assessed and tabled.

6.4 *Translational Risk Angle*

The number of degrees of included arc (out of 360) at which a fragment intersects the component/structure being analyzed. Refer to Figure 6 and Figure 7.

6.5 *Trajectory Probability (P)*

The probability of a liberated rotor fragment leaving the engine case is equal over 360°, thus the probability P of that fragment hitting a system component is the identified Translational Risk Angle ϕ in degrees °, divided by 360, i.e.

$$P = \phi/360$$

or,

$$\frac{\phi_1 - \phi_2}{360}$$

6.6 *Spread Angle*

If the failure model of the analysis assumes a (fore and aft) spread of $\pm 5^\circ$, then the spread angle is a total of 10° . If a critical component can only be hit at a limited position within that spread, then the exposure of that critical component can then be factored according to the longitudinal position within the spread angle, e.g.:

$$\frac{\psi_2 - \psi_1}{\text{spread angle}}$$

If a component can only be hit at the extreme forward range of $+4^\circ$ to $+5^\circ$, then the factor is .1 (for one degree out of 10).

6.7 *Threat Window*

The definition of a typical threat window is shown in Figure 7.

6.8 *Phase of Flight*

Certain types of system damage may be catastrophic only during a specific portion of the flight profile, such as a strike on the opposite engine during take-off after V_1 (i.e. a probability of 1.0), while with altitude a straight-ahead landing may be possible under certain favourable conditions (e.g. a probability of less than 1.0). The specific case can then be factored accordingly.

6.8.1 The most likely time for an uncontained rotor failure to occur is during take-off, when the engine is under highest stress. Using the industry accepted standards for the percentage of engine failures occurring within each flight phase, the following probabilities are assumed:

Take-off before V_1	35%
V_1 to first power reduction	20%
Climb	22%
Cruise	14%
Descent	3%
Approach	2%
Landing/Reverse	4%

6.8.2 The flight phase failure distribution above is used in the calculations of catastrophic risk for all cases where this risk varies with flight phase.

$$D_p = \frac{P \text{ flight phase } \%}{100}$$

6.9 *Other Risk Factors*

Risks such as fire, loss of pressurization, etc., are individually assessed for each case where applicable, using conservative engineering judgment. This may lead to a probability of catastrophe (i.e., risk factor) smaller than 1.0.

6.9.1 The above probabilities and factors are used in conjunction with the critical trajectory range defined to produce a probability of the specific event occurring from any random rotor burst.

This value is then factored by the "risk" factor assessed for the case, to derive a calculated probability of catastrophe for each specific case.

Typical conditional probability values for total loss of thrust causing catastrophic consequences are:

Phase	D_p		Risk
T.O.– V_1 to first power reduction	0.20	–	1.0
Climb	0.22	–	0.4
Cruise	0.14	–	0.2
Descent	0.03	–	0.4
Approach	0.02	–	0.4

6.10 All individual case probabilities are then tabled and summarised.

6.11 The flight mean values are obtained by averaging those for all discs or rotor stages on all engines across a nominal flight profile.

The following process may be used to calculate the flight mean value for each Failure Model:

- a. Establish from the table in Figure 8 the threat windows where, due to combination of individual damages, a catastrophic risk exists.

AMC-20-128A Appendix 1

- b. For each stage case calculate the risk for all Critical Hazards
- c. For each stage case apply all risk factors, and , if applicable, factor for Flight Phase-Failure distribution
- d. For each engine, average all stages over the total number of engine stages
- e. For each aeroplane, average all engines over the number of engines.

7.0 RESULTS ASSESSMENT

7.1 An applicant may show compliance with CS 23.903(b)(1) and CS 25.903(d)(1) using guidelines set forth in AMC 20-128A. The criteria contained in the AMC may be used to show that:

- a. Practical design precautions have been taken to minimise the damage that can be caused by uncontained engine debris, and
- b. Acceptable risk levels, as specified in AMC 20-128A, Paragraph 10, have been achieved for each critical Failure Model.

7.2 The summary of the applicable risk level criteria is shown in Table 1 below.

Table 1 Summary of Acceptable Risk Level Criteria

Requirement	Criteria
Average 1/3 Disc Fragment	1 in 20
Average Intermediate Fragment	1 in 40
Average Alternate Model	1 in 20 @ ± 5 degree Spread Angle
Multiple Disc Fragments	1 in 10
Any single fragment (except for structural damage)	2 x corresponding <u>average</u> criterion

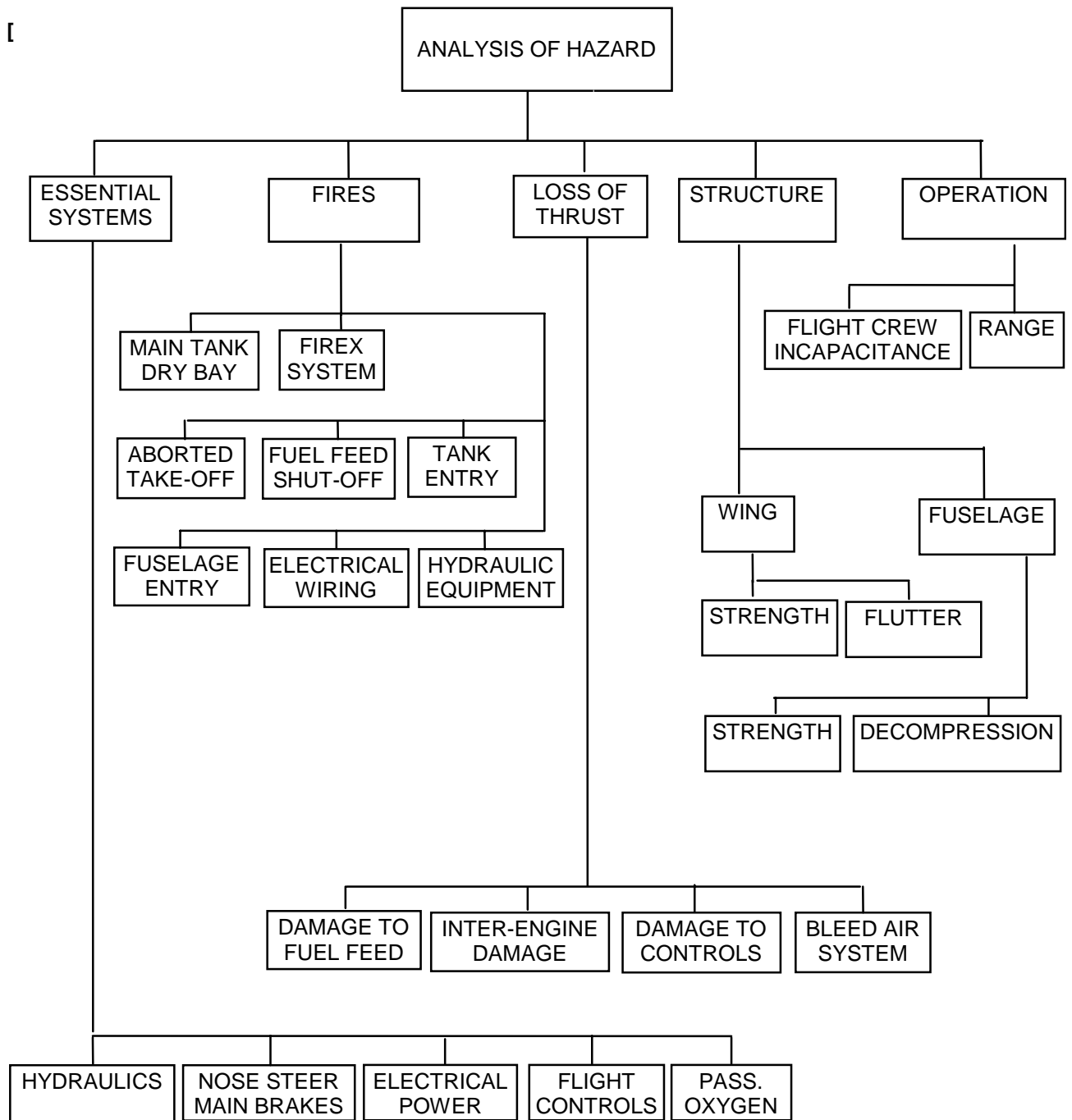

EXAMPLE – HAZARD TREE

FIGURE 1

AMC-20-128A Appendix 1

LOC	COMPONENT	DAMAGE TO	SYSTEM LOADED	DETAIL
LEFT	AILERON	CABLES/SURFACE	HYDRAULIC POWER	#1 & #3
RIGHT	AILERON	CABLES/SURFACE	HYDRAULIC POWER	#2 & #3
LEFT	SPOILER - OUTBD MULTI-FUNCTION	CONTROL/SURFACE	HYDRAULIC POWER	#1
RIGHT	SPOILER - OUTBD MULTI-FUNCTION	CONTROL/SURFACE	HYDRAULIC POWER	#1
LEFT	FLAP-OUTBD	TRACK/SURFACE	ELECTRICAL POWER	AC BUS1 AC ESS
RIGHT	FLAP-OUTBD	TRACK/SURFACE	ELECTRICAL POWER	AC BUS1 AC ESS
LEFT	RUDDER	CABLE	HYDRAULIC POWER	#1,#2
RIGHT	RUDDER	CABLE	HYDRAULIC POWER	#1,#2
LEFT	ELEVATOR	CABLES Note 1	HYDRAULIC POWER	#1 & #3
RIGHT	ELEVATOR	CABLES Note 1	HYDRAULIC POWER	#2 & #3
CHAN1	PITCH TRIM	CONTROL/POWER Note 2	ELECTRICAL POWER	AC BUS1 DC BUS1
CHAN2	PITCH TRIM	CONTROL/POWER Note 2	ELECTRICAL POWER	AC ESS DC ESS

FLIGHT CONTROLS – SYSTEM LOADING

Note 1:

Same fragment path must not sever:
ON-SIDE cables + OFF-SIDE hydraulic system + HYDRAULIC PWR #3

e.g.: Left elevator cable and HYDRAULIC PWR #2 and #3
or,

Right elevator cable and HYDRAULIC PWR # 1 and # 3

Note 2:

- Same fragment path must not sever:
- Both CHAN1 and CHAN2 circuits
 - ON-SIDE control circuit + OFF-SIDE power circuit
 - OFF-SIDE control circuit + ON-SIDE power circuit

EXAMPLE – SYSTEM LOADING MATRIX

FIGURE 2

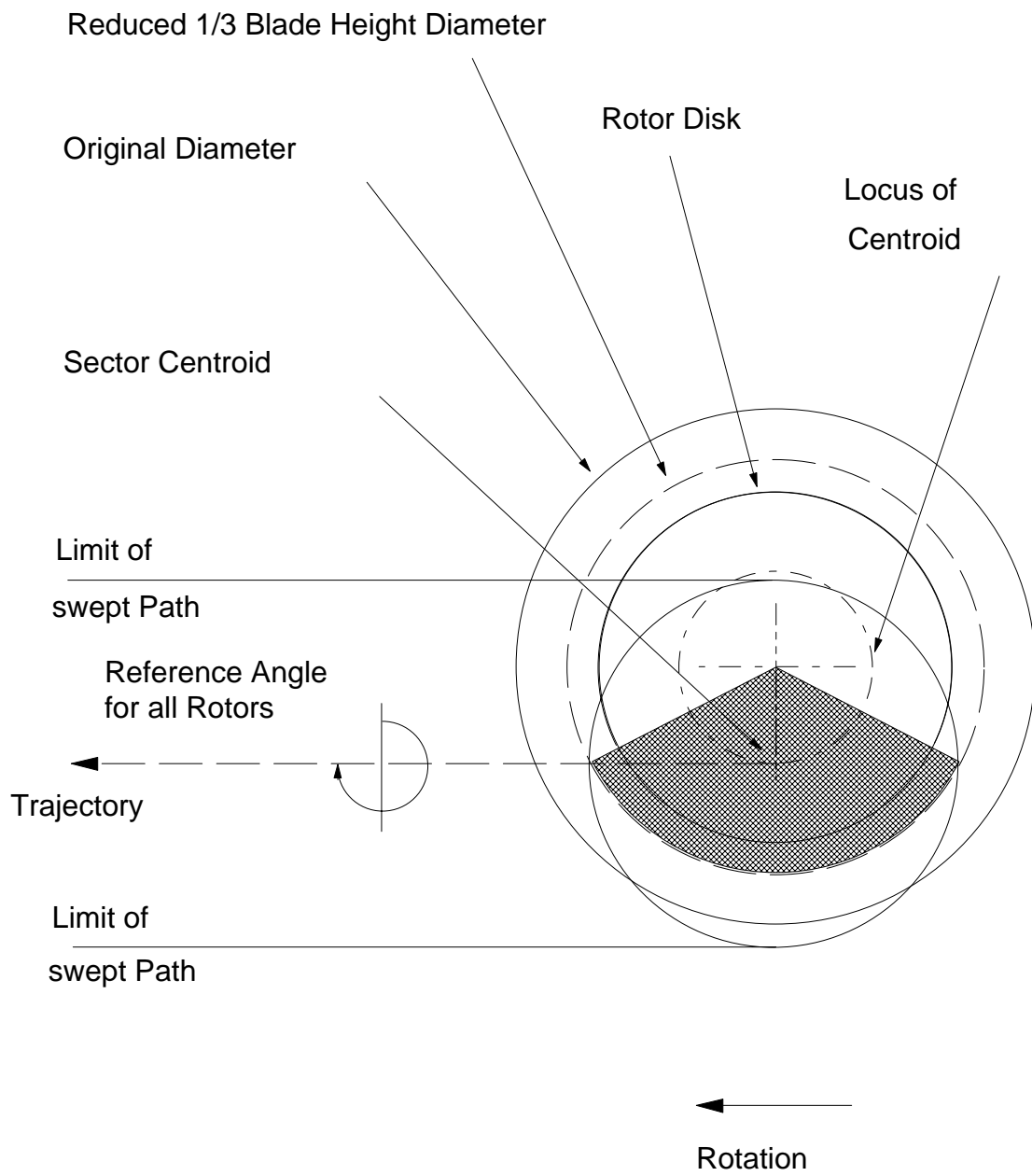

TRI-SECTOR ROTOR BURST

FIGURE 3

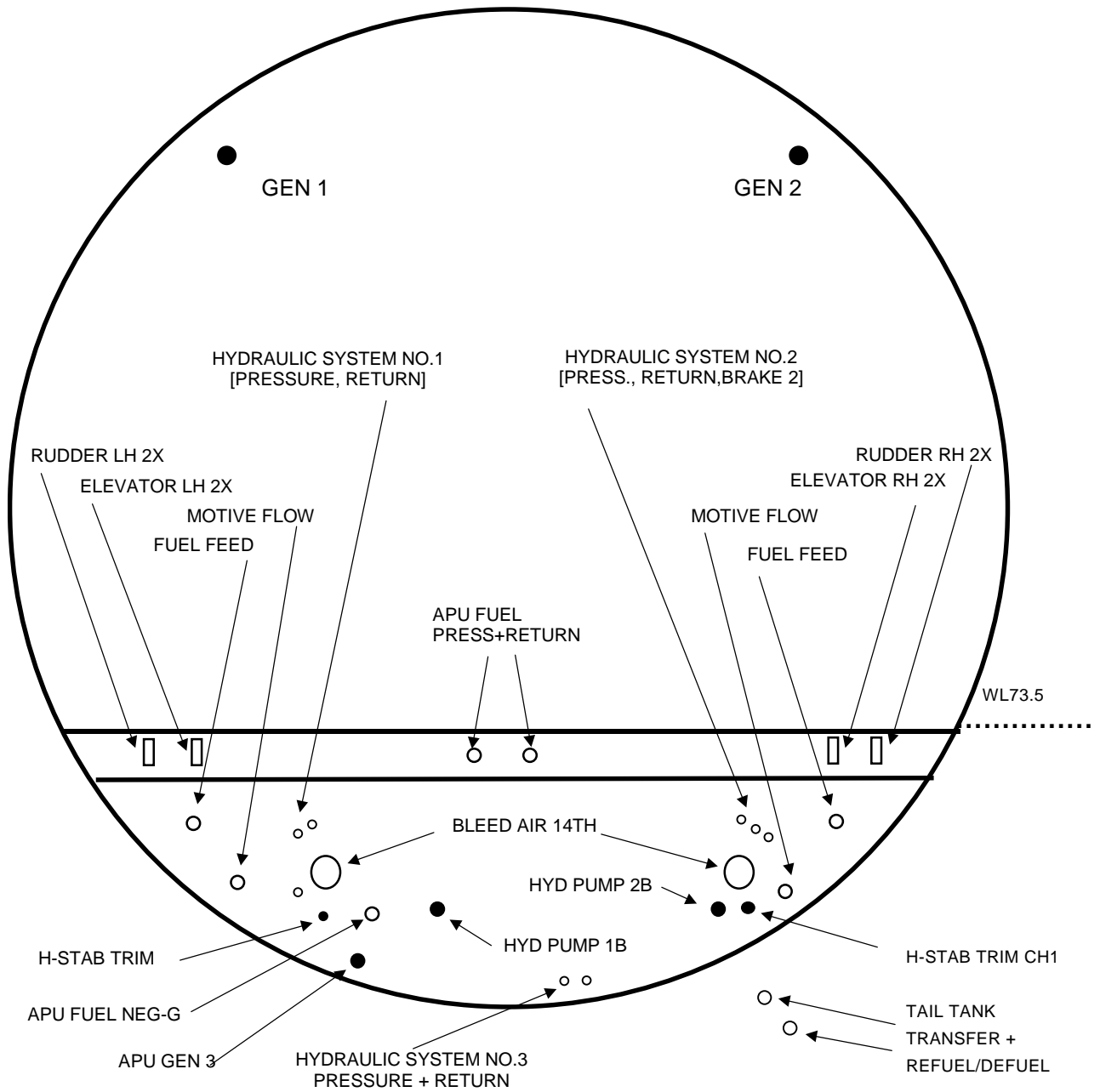

TYPICAL LAYOUT OF SYSTEMS IN ROTOR PLANE

FIGURE 4

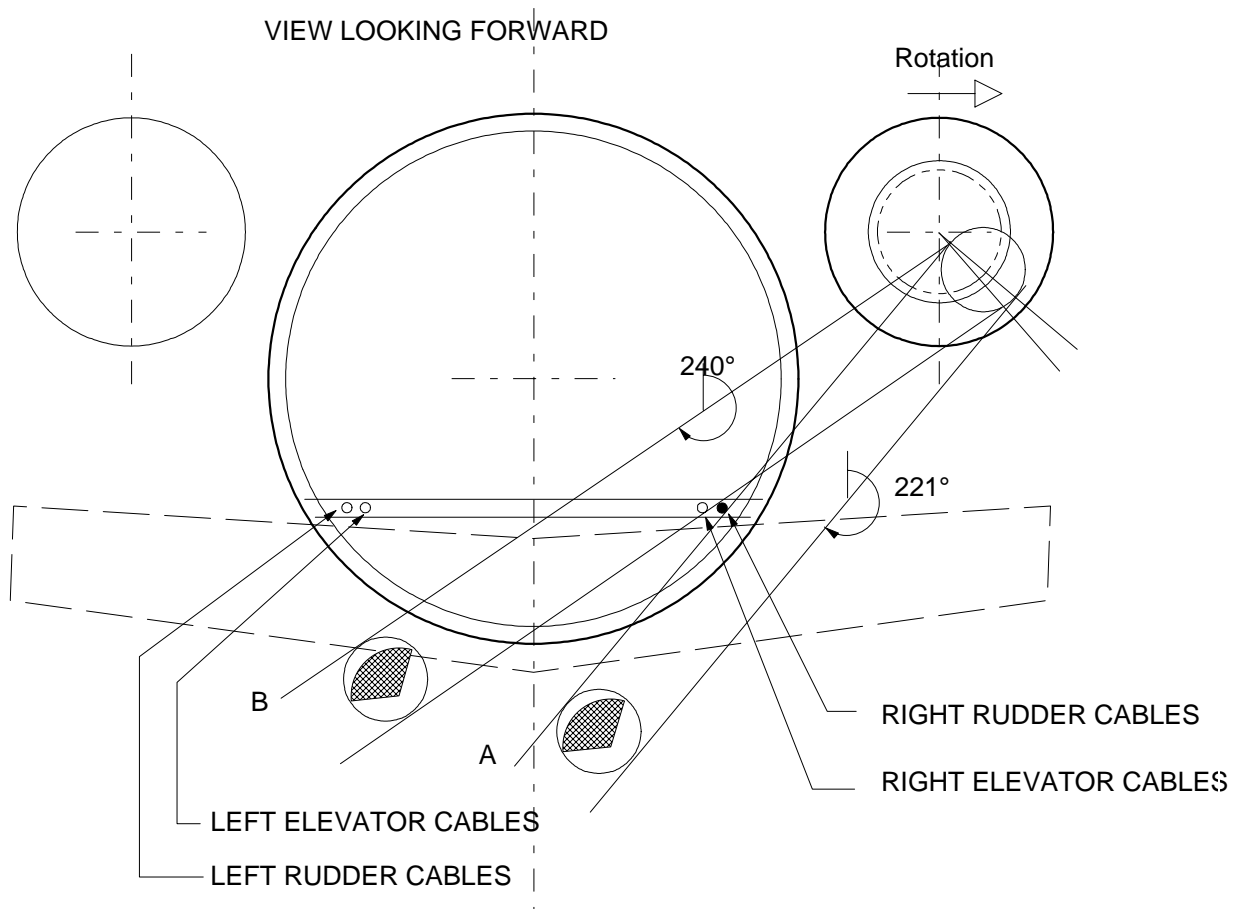

EXAMPLE:
 The right rudder cables are cut by a 1/3 fan fragment from the right engine at all trajectory angles between 221° and 240°. Trajectory range A - B is therefore 19°

TRAJECTORY RANGE PLOTTING

FIGURE 5

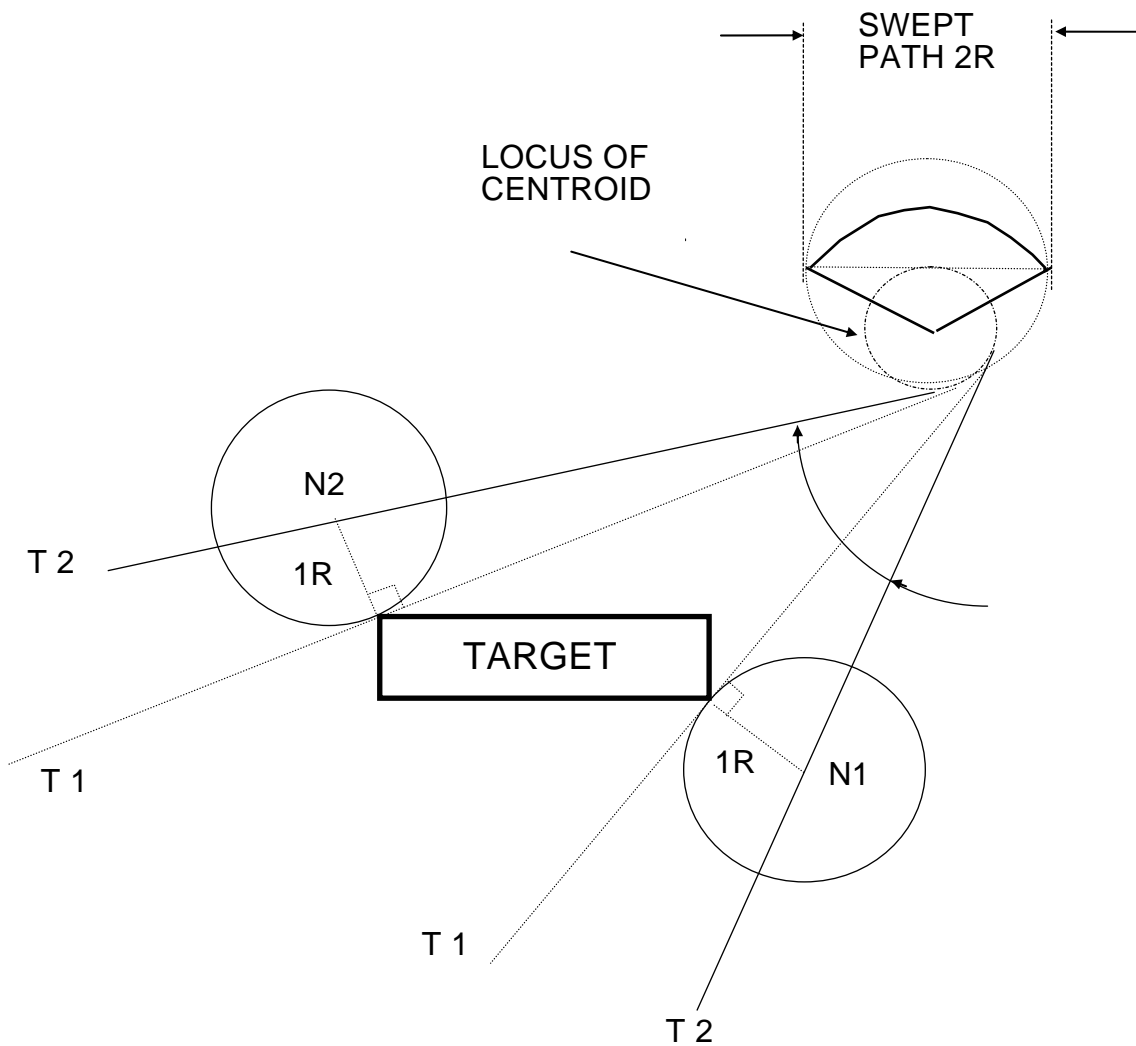

TYPICAL TRAJECTORY PLOTTING

FIGURE 6

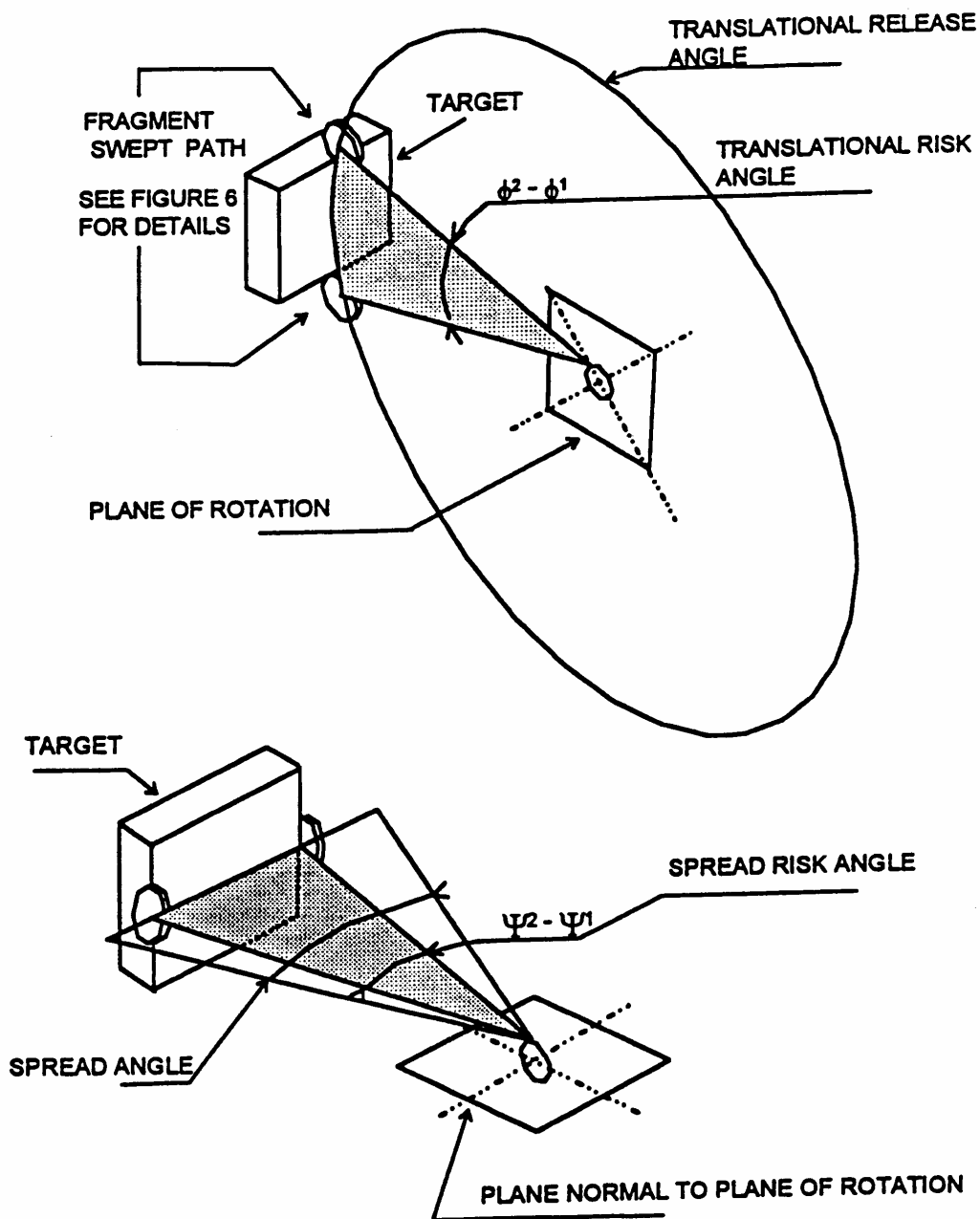

DEFINITION - THREAT WINDOW

FIGURE 7

ENGINE ROTOR FAILURE - SYSTEM EFFECTS

H.P. TURBINE 1

ENGINE: RIGHT
 COMPONENT: In.
 SIZE:

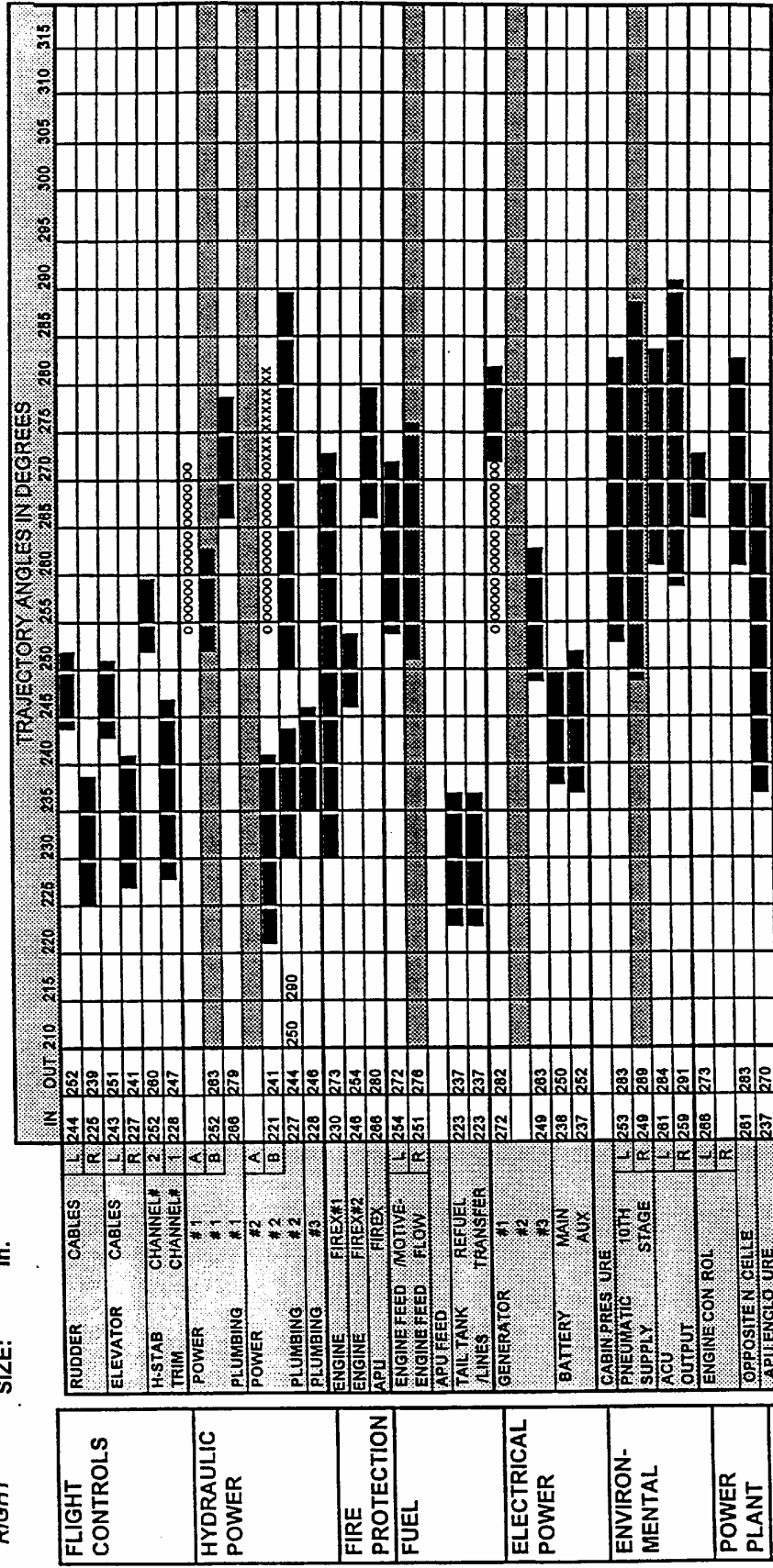

LEGEND: = DIRECT HIT OOOOO = OPPOSITE ENGINE FUEL LINE XXXXX = OPPOSITE GENERATOR FFFFF = APU FUEL LINE

FIGURE 8 - SAMPLE ROTOR STAGE PLOTTING CHART

AMC 20-1

Certification of Aircraft Propulsion Systems Equipped with Electronic Controls

See 2 below for cross references

1 GENERAL

The existing regulations for Engine, Propeller and aircraft certification may require special interpretation for Engines/Propellers equipped with electronic control systems. Because of the nature of this technology it has been found necessary to prepare acceptable means of compliance specifically addressing the certification of these control systems.

Like any acceptable means of compliance, the content of this document is not mandatory. It is issued for guidance purposes and to outline a method of compliance with the airworthiness code. In lieu of following this method, an alternative method may be followed, provided that this is agreed by the Agency as an acceptable method of compliance with the airworthiness code. This document addresses the compliance tasks relating to both the Engine/Propeller and the aircraft certification.

2 REFERENCE SPECIFICATIONS

2.1 Engine and Propeller Certification

Turbine Engines for Aeroplanes and Rotorcraft -

CS-E

Book 1, Section A, paragraphs E20, E30, E40, E50, E60, E90, E110, E140 & E150, E190

Section D, paragraphs E500, E510, E130

Section E, as appropriate.

Propellers -

CS-P, Paragraph P70

2.2 Aircraft Certification

Aeroplane: CS-25

Paragraphs, 25.33, 581, 631, 899, 901, 903, 905, 933, 937, 939, 961, 994, 995, 1103(d), 1143 (except (d)), 1149, 1153, 1155, 1163, 1181, 1183, 1189, 1301, 1305, 1307(c), 1309, 1337, 1351(b)(d), 1353(a)(b), 1355(c), 1357, 1431, 1461, 1521(a), 1527.

Rotorcraft: Equivalent specifications.

3 SCOPE

This acceptable means of compliance provides guidance for electronic (analogue and digital) Engine and Propeller control systems, on the interpretation and means of compliance with the relevant Engine, Propeller and aircraft certification requirements.

It gives guidance on the precautions to be taken for the use of electronic technology for Engine/Propeller control, protection and monitoring, and, where applicable, for integration of functions specific to the aircraft.

Precautions have to be adapted to the criticality of the functions. These precautions may be affected by -

Degree of authority of the system,

Phase of flight,

Availability of back-up system.

This document also discusses the division of compliance tasks between the Engine, Propeller and aircraft certifications.

AMC-20-1

It does not cover APU control systems.

4 PRECAUTIONS

4.1 *General*

The introduction of electronic technology can entail the following:

- a. A greater dependence of the Engine/Propeller on the aircraft owing to the use of electrical power and/or data supplied from the aircraft.
- b. Risk of significant failures common to more than one Engine/Propeller of the aircraft which might, for example, occur as a result of -
 - i. Insufficient protection from electromagnetic disturbance (lightning, internal or external radiation effects),
 - ii. Insufficient integrity of the aircraft electrical power supply,
 - iii. Insufficient integrity of data supplied from the aircraft,
 - iv. Hidden design faults or discrepancies contained within the design of the propulsion system control software, or
 - v. Omissions or errors in the system specification.

Special design and integration precautions must therefore be taken to minimise these risks.

4.2 *Objective*

The introduction of electronic control systems should provide for the aircraft at least the equivalent safety, and the related reliability level, as achieved by Engine/Propellers equipped with hydromechanical control and protection systems.

This objective, when defined for the aircraft/Engine for a specific application, will be agreed with the Agency.

4.3 *Precautions Relating to Engine/Propeller Control, Protection and Monitoring*

The software associated with Engine/Propeller control, protection and monitoring functions must have a quality level and architecture appropriate to their criticality (see also paragraph 4.5.1).

The design of the system relating to the control, protection and monitoring functions must be such as to satisfy the requirements of CS-E 50(c).

4.4 *Precautions Relating to Engine/Propeller Independence From the Aircraft*

4.4.1 *Precautions relating to electrical power supply and data from the aircraft*

When considering the objectives of paragraph 4.2, due consideration must be given to the reliability of electrical power and data supplied to the electronic controls and peripheral components. Therefore the potential adverse effects on Engine/Propeller operation of any loss of electrical power supply from the aircraft or failure of data coming from the aircraft must be assessed during the Engine/Propeller certification.

The use of either the aircraft electrical power network or electrical power sources specific to the Engine/Propeller, or the combination of both may meet the objectives. Defects of aircraft input data may be overcome by other data references specific to each Engine/Propeller.

4.4.2 *Local events*

- a. In designing an electronic control system to meet the objectives of paragraph 4.2, special consideration needs to be given to local events.

Examples of local events include fluid leaks, mechanical disruptions, electrical problems, fires or overheat conditions. An overheat condition results when the temperature of the electronic control unit

is greater than the maximum safe design operating temperature declared during the Engine/Propeller certification. This situation can increase the failure rate of the electronic control system.

b. Whatever the local event, the behaviour of the electronic control system must not cause a hazard to the aircraft. This will require consideration of effects such as the control of the thrust reverser deployment, the overspeed of the Engine, transients effects or inadvertent Propeller pitch change under any flight condition.

When the demonstration that there is no hazard to the aircraft is based on the assumption that there exists another function to afford the necessary protection, it must be shown that this function is not rendered inoperative by the same local event (including destruction of wires, ducts, power supplies).

c. Specific design features or analysis methods may be used to show compliance with respect to hazardous effects. Where this is not possible, for example due to the variability or the complexity of the failure sequence, then testing may be required. These tests must be agreed with the Agency.

4.5 *Precautions Relating to Failure Modes Common to More Than One Engine/Propeller*

4.5.1 *System design*

For digital systems, any residual errors not activated during the software development and certification process could cause a failure common to more than one Engine/Propeller. RTCA DO178B (or the equivalent EUROCAE ED 12B) constitutes an acceptable means of compliance for software development and certification. It should be noted however that the DO178A states in paragraph 3.3 -

'It is appreciated that, with the current state of knowledge, the software disciplines described in this document may not, in themselves, be sufficient to ensure that the overall system safety and reliability targets have been achieved. This is particularly true for certain critical systems, such as full authority fly-by-wire systems, In such cases it is accepted that other measures, usually within the system, in addition to a high level of software discipline may be necessary to achieve these safety objectives and demonstrate that they have been met.

It is outside the scope of this document to suggest or specify these measures, but in accepting that they may be necessary, it is also the intention to encourage the development of software techniques which could support meeting the overall system safety objectives.'

4.5.2 *Environmental effects*

Special attention should be given to any condition which could affect more than one Engine/Propeller control system. For example, incorrect operation under hot ambient conditions.

4.5.3 *Lightning and other electromagnetic effects*

Electronic control systems are sensitive to lightning and other electromagnetic interference. Moreover, these conditions can be common to more than one Engine/Propeller. The system design must incorporate sufficient protection in order to ensure the functional integrity of the control system when subjected to designated levels of electric or electromagnetic inductions, including external radiation effects.

The validated protection levels for the Engine/Propeller electronic control systems must be detailed during the Engine/Propeller certification in an approved document. For the aircraft certification, it must be substantiated that these levels are adequate.

4.5.4 *Aircraft electrical power supply*

If the aircraft electrical system supplies power to the Engine/Propeller control system at any time, the power supply quality, including transients or failures, must not lead to a situation identified during the Engine certification, which is considered during the aircraft certification to be a hazard to the aircraft.

4.5.5 *Data exchanged with the aircraft*

a. Aircraft must be protected from unacceptable effects of faults due to a single cause, simultaneously affecting more than one Engine/Propeller. In particular, the following cases should be considered:

AMC-20-1

- i. Erroneous data received from the aircraft by the Engine/Propeller control system if the data source is common to more than one Engine/Propeller (e.g. air data sources, autothrottle synchronising), and
 - ii. Control system operating faults propagating via data links between Engine/Propellers (e.g. maintenance recording, common bus, cross-talk, autofeathering, automatic reserve power system).
- b. Any precautions needed may be taken either through the aircraft system architecture or by logic internal to the electronic control system.

4.6 *Other Functions Integrated into the Electronic Control System*

If functions other than those directly associated with the control of the Engine/Propeller, such as thrust reverser control or automatic starting, are integrated into the electronic control system, the Engine/Propeller certification should take into account the applicable aircraft requirements.

5 INTER-RELATION BETWEEN ENGINE/PROPELLER AND AIRCRAFT CERTIFICATION

5.1 *Objective*

To satisfy the CS aircraft requirements, such as CS 25.901, CS 25.903 and CS 25.1309, an analysis of the consequences of failures of the system on the aircraft has to be made. It should be ensured that the software levels and safety and reliability objectives for the electronic control system are consistent with these requirements.

5.2 *Interface Definition*

- a. The interface has to be identified for the hardware and software aspects between the Engine, Propeller and the aircraft systems in the appropriate documents.
- b. The Engine/Propeller/aircraft documents should cover in particular -
 - i. The software quality level (per function if necessary),
 - ii. The reliability objectives for -
 - Engine shut-down in flight,
 - Loss of Engine/Propeller control or significant change in thrust,
 - Transmission of faulty parameters,
 - iii. The degree of protection against lightning or other electromagnetic effects (e.g. level of induced voltages that can be supported at the interfaces),
 - iv. Engine, Propeller and aircraft interface data and characteristics, and
 - v. Aircraft power supply and characteristics (if relevant).

5.3 *Distribution of Compliance Demonstration*

The certification of the aircraft propulsion system equipped with electronic controls may be shared between the Engine, Propeller and aircraft certification. The distribution between the different certification activities must be identified and agreed with the Agency and/or the appropriate Engine and aircraft Authorities (an example is given in paragraph 6).

Appropriate evidence provided for Engine/Propeller certification should be used for aircraft certification. For example, the quality of any aircraft function software and aircraft/Engine/Propeller interface logic already demonstrated for Engine/Propeller certification should need no additional substantiation for aircraft certification.

Aircraft certification must deal with the specific precautions taken in respect of the physical and functional interfaces with the Engine/Propeller.

6. TABLE

An example of distribution between Engine and aircraft certification. (When necessary, a similar approach should be taken for Propeller applications).

TASK	SUBSTANTIATION UNDER CS-E	SUBSTANTIATION UNDER CS-25	
		with engine data	with aircraft data
ENGINE CONTROL AND PROTECTION	<ul style="list-style-type: none"> - Safety objective - Software level 	<ul style="list-style-type: none"> - Consideration of common mode effects (including software) - Reliability - Software level 	
MONITORING	<ul style="list-style-type: none"> - Independence of control and monitoring parameters 	<ul style="list-style-type: none"> - Monitoring parameter reliability 	<ul style="list-style-type: none"> - Indication system reliability - Independence engine/ engine
AIRCRAFT DATA	<ul style="list-style-type: none"> - Protection of engine from aircraft data failures - Software level 		<ul style="list-style-type: none"> - Aircraft data reliability - Independence engine/ engine
THRUST REVERSER CONTROL/ MONITORING	<ul style="list-style-type: none"> - Software level 	<ul style="list-style-type: none"> - System reliability - Architecture - Consideration of common mode effects(including software) 	<ul style="list-style-type: none"> - Safety objectives
CONTROL SYSTEM ELECTRICAL SUPPLY			<ul style="list-style-type: none"> - Reliability of quality of aircraft supply, if used - Independence engine/ engine
ENVIRONMENTAL CONDITIONS	<ul style="list-style-type: none"> - Equipment protection 	<ul style="list-style-type: none"> - Declared capability 	<ul style="list-style-type: none"> - Aircraft design
LIGHTNING AND OTHER ELECTROMAGNETIC EFFECTS			<ul style="list-style-type: none"> - Aircraft wiring protection
FIRE PROTECTION	<ul style="list-style-type: none"> - Equipment protection 	<ul style="list-style-type: none"> - Declared capability 	<ul style="list-style-type: none"> - Aircraft design

INTENTIONALLY LEFT BLANK

AMC 20-2
Certification of Essential APU Equipped with Electronic Controls

1. GENERAL

The existing regulations for APU and aircraft certification may require special interpretation for essential APU equipped with electronic control systems. Because of the nature of this technology it has been found necessary to prepare acceptable means of compliance specifically addressing the certification of these control systems.

Like any acceptable means of compliance, the content of this document is not mandatory. It is issued for guidance purposes, and to outline a method of compliance with the airworthiness code. In lieu of following this method, an alternative method may be followed, provided that this is agreed by the Agency as an acceptable method of compliance with the airworthiness code.

This document discusses the compliance tasks relating to both the APU and the aircraft certification.

2 REFERENCE SPECIFICATIONS

2.1 *APU Certification*

CS-APU

Book 1, paragraph 2(c)

Book 1, Section A, paragraphs 10(b), 20, 80, 90, 210, 220, 280 and 530

Book 2, Section A, AMC CS-APU 20

2.2 *Aircraft Certification*

Aeroplane: CS-25

Paragraphs 581, 899, 1301, 1307(c), 1309, 1351(b)(d), 1353(a)(b), 1355(c), 1357, 1431, 1461, 1524, 1527

A9011, A903, A939, A1141, A1181, A1183, A1189, A1305, A1337, A1521, A1527, B903, B1163

3 SCOPE

This acceptable means of compliance provides guidance for electronic (analogue and digital) essential APU control systems, on the interpretation and means of compliance with the relevant APU and aircraft certification requirements.

It gives guidance on the precautions to be taken for the use of electronic technology for APU control, protection and monitoring and, where applicable, for integration of functions specific to the aircraft.

Precautions have to be adapted to the criticality of the functions. These precautions may be affected by -

Degree of authority of the system,

Phase of flight,

Availability of back-up system.

This document also discusses the division of compliance tasks between the APU and aircraft certification.

4 PRECAUTIONS

4.1 *General*

The introduction of electronic technology can entail the following:

- (a) A greater dependence of the APU on the aircraft owing to the use of electrical power and/or data supplied from the aircraft,

AMC-20-2

- (b) Risk of significant failures which might, for example, occur as a result of -
- (i) Insufficient protection from electromagnetic disturbance (lightning, internal or external radiation effects),
 - (ii) Insufficient integrity of the aircraft electrical power supply,
 - (iii) Insufficient integrity of data supplied from the aircraft,
 - (iv) Hidden design faults or discrepancies contained within the design of the APU control software, or
 - (v) Omissions or errors in the system specification.

Special design and integration precautions must therefore be taken to minimise these risks.

4.2 *Objective*

The introduction of electronic control systems should provide for the aircraft at least the equivalent safety, and the related reliability level, as achieved by essential APU equipped with hydromechanical control and protection systems.

This objective, when defined during the aircraft/APU certification for a specific application, will be agreed with the Agency.

4.3 *Precautions relating to APU control, protection and monitoring*

The software associated with APU control, protection and monitoring functions must have a quality level and architecture appropriate to their criticality (see paragraph 4.2).

For digital systems, any residual errors not activated during the software development and certification process could cause an unacceptable failure. (RTCA DO178A (or the equivalent EUROCAE ED 12A) constitutes an acceptable means of compliance for software development and certification. The APU software should be at least level 2 according to this document. In some specific cases, level 1 may be more appropriate.

It should be noted, however, that the DO178A states in section 3.3 -

"It is appreciated that, with the current state of knowledge, the software disciplines described in this document may not, in themselves, be sufficient to ensure that the overall system safety and reliability targets have been achieved. This is particularly true for certain critical systems, such as fully authority fly-by-wire systems. In such cases it is accepted that other measures, usually within the system, in addition to a high level of software discipline may be necessary to achieve these safety objectives and demonstrate that they have been met.

It is outside the scope of this document to suggest or specify these measures, but in accepting that they may be necessary, it is also the intention to encourage the development of software techniques which could support meeting the overall system safety objectives."

4.4 *Precautions relating to APU independence from the aircraft*

4.4.1 *Precautions relating to electrical power supply and data from the aircraft*

When considering the objectives of paragraph 4.2, due consideration must be given to the reliability of electrical power and data supplied to the electronic controls and peripheral components. Therefore the potential adverse effects on APU operation of any loss of electrical power supply from the aircraft or failure of data coming from the aircraft must be assessed during the APU certification.

(a) Electrical power

The use of either the aircraft electrical power network or electrical power sources specific to the APU, or the combination of both, may meet the objectives.

If the aircraft electrical system supplies power to the APU control system at any time, the power supply quality, including transients or failures, must not lead to a situation identified during the APU certification which is considered during the aircraft certification to be a hazard to the aircraft.

(b) Data

The following cases should be considered:

- (i) Erroneous data received from the aircraft by the APU control system, and
- (ii) Control system operating faults propagating via data links.

In certain cases, defects of aircraft input data may be overcome by other data references specific to the APU in order to meet the objectives.

4.4.2 *Local Events*

(a) In designing an electronic control system to meet the objectives of paragraph 4.2, special consideration needs to be given to local events.

Examples of local events include fluid leaks, mechanical disruptions, electrical problems, fires or overheat conditions. An overheat condition results when the temperature of the electronic control unit is greater than the maximum safe design operating temperature declared during the APU certification. This situation can increase the failure rate of the electronic control system.

(b) Whatever the local event, the behaviour of the electronic control system must not cause a hazard to the aircraft. This will require consideration of effects such as the overspeed of the APU.

When the demonstration that there is no hazard to the aircraft is based on the assumption that there exists another function to afford the necessary protection, it must be shown that this function is not rendered inoperative by the same local event (including destruction of wires, ducts, power supplies).

(c) Specific design features or analysis methods may be used to show compliance with respect to hazardous effects. Where this is not possible, for example due to the variability or the complexity of the failure sequence, then testing may be required. These tests must be agreed with the Agency.

4.4.3 *Lightning and other electromagnetic effects*

Electronic control systems are sensitive to lightning and other electromagnetic interference. The system design must incorporate sufficient protection in order to ensure the functional integrity of the control system when subjected to designated levels of electric or electromagnetic inductions, including external radiation effects.

The validated protection levels for the APU electronic control system must be detailed during the APU certification in an approved document. For aircraft certification, it must be substantiated that these levels are adequate.

4.5 *Other functions integrated into the electronic control system*

If functions other than those directly associated with the control of the APU are integrated into the electronic control system, the APU certification should take into account the applicable aircraft requirements.

5 INTER-RELATION BETWEEN APU AND AIRCRAFT CERTIFICATION

5.1 *Objective*

To satisfy the CS aircraft requirements, such as CS 25A901, CS 25A903 and CS 25.1309, an analysis of the consequences of failures of the system on the aircraft has to be made. It should be ensured that the software levels and safety and reliability objectives for the electronic control system are consistent with these requirements.

5.2 *Interface definition*

The interface has to be identified for the hardware and software aspects between the APU and aircraft systems in the appropriate documents.

The APU documents should cover in particular -

- (a) The software quality level (per function if necessary),

AMC-20-2

- (b) The reliability objectives for -
APU shut-down in flight,
Loss of APU control or significant change in performance,
Transmission of faulty parameters,
- (c) The degree of protection against lightning or other electromagnetic effects (e.g. level of induced voltages that can be supported at the interfaces),
- (d) APU and aircraft interface data and characteristics, and
- (e) Aircraft power supply and characteristics (if relevant).

5.3 *Distribution of compliance demonstrations*

The certification of the APU equipped with electronic controls and of the aircraft may be shared between the APU certification and aircraft certification. The distribution between the APU certification and the aircraft certification must be identified and agreed with the Agency and/or the appropriate APU and aircraft Authorities (an example is given in appendix).

Appropriate evidence provided for APU certification should be used for aircraft certification. For example, the quality of any aircraft function software and aircraft/APU interface logic already demonstrated for APU certification should need no additional substantiation for aircraft certification.

Aircraft certification must deal with the specific precautions taken in respect of the physical and functional interfaces with the APU.

APPENDIX

An example of tasks distribution between APU and aircraft certification

FUNCTIONS OR INSTALLATION CONDITIONS	SUBSTANTIATION UNDER CS-APU	SUBSTANTIATION UNDER CS-25	
APU CONTROL AND PROTECTION	<ul style="list-style-type: none"> - Safety objective - Software level 	<ul style="list-style-type: none"> - Reliability - Software level 	
MONITORING	<ul style="list-style-type: none"> - Independence of control and monitoring parameters 	<ul style="list-style-type: none"> - Monitoring parameter reliability 	<ul style="list-style-type: none"> - Indication system reliability
AIRCRAFT DATA	<ul style="list-style-type: none"> - Protection of APU from aircraft data failures - Software level 		<ul style="list-style-type: none"> - Aircraft data reliability
CONTROL SYSTEM ELECTRICAL SUPPLY			<ul style="list-style-type: none"> - Reliability and quality of aircraft supply if used
ENVIRONMENTAL CONDITIONS, LIGHTNING AND OTHER ELECTRO-MAGNETIC EFFECTS	<ul style="list-style-type: none"> - Equipment protection 	<ul style="list-style-type: none"> - Declared capability 	<ul style="list-style-type: none"> - Aircraft design - Aircraft wiring protection

INTENTIONALLY LEFT BLANK

AMC 20-4
Airworthiness Approval and Operational Criteria For the Use of Navigation Systems in European Airspace Designated For Basic RNAV Operations

This AMC presents Acceptable means of Compliance relative to the implementation of Basic RNAV operations within European designated Airspace, from January 1998. This AMC has been co-ordinated with EUROCONTROL.

1 PURPOSE

This document provides acceptable means of compliance for airworthiness approval and operational criteria for the use of navigation systems in European airspace designated for Basic RNAV operations. The document establishes an acceptable means, but not the only means, that can be used in the airworthiness approval process, and provides guidelines for operators where GPS stand-alone equipment is used as the means for Basic RNAV operations. The document is in accordance with the April 1990 directive issued by the Transport Ministers of ECAC member states and with regard to the Basic RNAV operations as defined within the EUROCONTROL Standard 003-93 Edition 1 and satisfies the intent of ICAO Doc. 9613-AN/937 Manual on Required Navigation Performance (RNP) First Edition - 1994. It is consistent also with Regional Supplementary Procedures contained within ICAO Doc 7030.

2 SCOPE

This document provides guidance related to navigation systems intended to be used for Basic RNAV operations and considers existing airworthiness approval standards as providing acceptable means of compliance. The content is limited to general certification considerations including navigation performance, integrity, functional requirements and system limitations.

Compliance with the guidance in this Leaflet does not constitute an operational authorisation/approval to conduct Basic RNAV operations. Aircraft operators should apply to their Authority for such an authorisation/approval.

ICAO RNP-4 criteria are outside the scope of this AMC, but it is expected that navigation systems based on position updating from traditional radio aids and approved for Basic RNAV operations in accordance with this AMC will have an RNP-4 capability.

Related specifications

CS/FAR 25.1301, 25.1307, 25.1309, 25.1321, 25.1322, 25.1431

CS/FAR 23.1301, 23.1309, 23.1311, 23.1321, 23.1322, 23.1431

CS/FAR 27.1301, 27.1309, 27.1321, 27.1322

CS/FAR 29.1301, 29.1309, 29.1321, 29.1322, 29.1431

operating requirements

ATC Documents

EUROCONTROL Standard Document 003-93 Edition 1

ICAO Doc. 9613-AN/937 - Manual on Required Navigation Performance (RNP) First Edition - 1994

Related navigation documents

EASA Acceptable means of Compliance

AMC 25-11 Electronic Display Systems

AMC 20-5 Acceptable Means of Compliance for Airworthiness Approval and Operational Criteria for the use of the NAVSTAR Global Positioning System (GPS)

AMC-20-4

FAA Advisory Circulars

AC 20-121 A	Airworthiness Approval of LORAN C for use in the U.S. National Airspace System
AC 20-130()	Airworthiness Approval of Multi-sensor Navigation Systems for use in the U.S. National Airspace System
AC 20-138	Airworthiness Approval of NAVSTAR Global Positioning System (GPS) for use as a VFR and IFR Supplemental Navigation System
AC 25-4	Inertial Navigation Systems (INS)
AC 25-15	Approval of FMS in Transport Category Airplanes
AC 90-45 A	Approval of Area Navigation Systems for use in the U S. National Airspace System

ETSOs

ETSO-C115b	Airborne Area Navigation Equipment Using Multi Sensor Inputs
ETSO-C129a	Airborne Supplemental Navigation Equipment Using the Global Positioning System (GPS)
ETSO-C145	Airborne Navigation Sensors Using the Global Positioning System (GPS) Augmented by the Wide Area Augmentation System (WAAS).
ETSO-C146	Stand-Alone Airborne Navigation Equipment Using the Global Positioning System (GPS) Augmented by the Wide Area Augmentation System (WAAS)

EUROCAE/RTCA documents

ED-27	Minimum Operational Performance Requirements (MOPR) for Airborne Area Navigation Systems, based on VOR and DME as sensors
ED-28	Minimum Performance Specification (MPS) for Airborne Area Navigation Computing Equipment based on VOR and DME as sensors
ED-39	MOPR for Airborne Area Navigation Systems, based on two DME as sensors
ED-40	MPS for Airborne Computing Equipment for Area Navigation System using two DME as sensors.
ED-58	Minimum Operational Performance Specification (MOPS) for Area Navigation Equipment using Multi-Sensor Inputs
ED-72()	MOPS for Airborne GPS Receiving Equipment
DO-180()	Minimum Operational Performance Standards (MOPS) for Airborne Area Navigation Equipment Using a Single Collocated VOR/DME Sensor Input
DO-187	MOPS for Airborne Area Navigation Equipment Using Multi Sensor Inputs
DO-200	Preparation, Verification and Distribution of User-Selectable Navigation Data Bases
DO-201	User Recommendations for Aeronautical Information Services
DO-208	MOPS for Airborne Supplemental Navigation Equipment Using Global Positioning System (GPS)

3 SYSTEMS CAPABILITY

Area navigation (RNAV) is a method which permits aircraft navigation along any desired flight path within the coverage of either station referenced navigation aids or within the limits of the capability of self-contained aids, or a combination of both methods.

In general terms, RNAV equipment operates by automatically determining aircraft position from one, or a combination, of the following together with the means to establish and follow a desired path:

VOR/DME
 DME/DME
 INS* or IRS
 LORAN C*
 GPS*

Equipment marked with an asterisk *, is subject to the limitations contained in paragraph 4.4.2.

4 AIRWORTHINESS APPROVAL

4.1 Criteria For Basic RNAV System

4.1.1 Accuracy

The navigation performance of aircraft approved for Basic RNAV operations within European airspace requires a track keeping accuracy equal to or better than +/- 5 NM for 95% of the flight time. This value includes signal source error, airborne receiver error, display system error and flight technical error.

This navigation performance assumes the necessary coverage provided by satellite or ground based navigation aids is available for the intended route to be flown.

4.1.2 Availability and Integrity

Acceptable means of compliance for assessment of the effects associated with the loss of navigation function or erroneous display of related information is given in AMC 25-11 paragraph 4 a (3)(viii).

The minimum level of availability and integrity required for Basic RNAV systems for use in designated European airspace can be met by a single installed system comprising one or more sensors, RNAV computer, control display unit and navigation display(s) (e.g. ND, HSI or CDI) provided that the system is monitored by the flight crew and that in the event of a system failure the aircraft retains the capability to navigate relative to ground based navigation aids (e.g. VOR, DME and NDB).

4.2 Functional Criteria

4.2.1 Required Functions

The following system functions are the minimum required to conduct Basic RNAV operations.

- (a) Continuous indication of aircraft position relative to track to be displayed to the pilot flying on a navigation display situated in his primary field of view
 In addition where the minimum flight crew is two pilots, indication of aircraft position relative to track to be displayed to the pilot not flying on a navigation display situated in his primary field of view
- (b) Display of distance and bearing to the active (To) waypoint
- (c) Display of ground speed or time to the active (To) waypoint
- (d) Storage of waypoints; minimum of 4
- (e) Appropriate failure indication of the RNAV system, including the sensors.

4.2.2 Recommended Functions

In addition to the requirements of paragraph 4.2.1, the following system functions and equipment characteristics are recommended:

- (a) Autopilot and/or Flight Director coupling
- (b) Present position in terms of latitude and longitude

AMC-20-4

- (c) "Direct To" function
- (d) Indication of navigation accuracy (e.g. quality factor)
- (e) Automatic channel selection of radio navigation aids
- (f) Navigation data base
- (g) Automatic leg sequencing and associated turn anticipation

4.3 Aircraft Flight Manual - MMEL (Master Minimum Equipment List)

The basis for certification should be stated in the Aircraft Flight Manual (AFM), together with any RNAV system limitations. The AFM may also provide the appropriate RNAV system operating and abnormal procedures applicable to the equipment installed, including, where applicable, reference to required modes and systems configuration necessary to support an RNP capability.

The (Master) Minimum Equipment List MMEL/MEL should identify the minimum equipment necessary to satisfy the Basic RNAV criteria defined in paragraphs 4.1 and 4.2.

4.4. Basic RNAV Systems - Acceptable Means Of Compliance

4.4.1 Acceptable Means of Compliance

Navigation systems which are installed on aircraft in accordance with the advisory material contained within FAA AC 90-45A, AC 20-130(), AC 20-138 or AC 25-15, are acceptable for Basic RNAV operations. Where reference is made in the AFM to either the above advisory material or the specific levels of available navigation performance (RNP), no further compliance statements will be required.

Compliance may be based also on the lateral navigation standards defined in ETSO-C115b, ETSO-C129a, ED-27/28, ED-39/40, DO-187/ED-58 or DO-180(). However, qualification of the equipment to these standards, in itself, is not considered as sufficient for the airworthiness approval.

4.4.2 Limitations on the Use of Navigation Systems

The following navigation systems, although offering an RNAV capability, have limitations for their use in Basic RNAV operations.

4.4.2.1 INS

INS without a function for automatic radio updating of aircraft position and approved in accordance with AC 25-4, when complying with the functional criteria of paragraph 4.2.1, may be used only for a maximum of 2 hours from the last alignment/position update performed on the ground. Consideration may be given to specific INS configurations (e.g. triple mix) where either equipment or aircraft manufacturer's data, justifies extended use from the last on-ground position update.

INS with automatic radio updating of aircraft position, including those systems where manual selection of radio channels is performed in accordance with flight crew procedures, should be approved in accordance with AC 90-45A or equivalent material.

4.4.2.2 LORAN C

No EASA advisory material currently exists for operational or airworthiness approval of LORAN C system within European airspace. Where LORAN C coverage within European Airspace permits use on certain Basic RNAV routes, AC 20-121A may be adopted as a compliance basis.

4.4.2.3 GPS

The use of GPS to perform Basic RNAV operations is limited to equipment approved to ETSO-C129a, ETSO-C 145, or ETSO-C 146 and which include the minimum system functions specified in paragraph 4.2.1. Integrity should be provided by Receiver Autonomous Integrity Monitoring (RAIM) or an equivalent means within a multi-sensor navigation system. The equipment should be approved in accordance with the AMC 20-5. In addition, GPS stand-alone equipment should include the following functions:

- (a) Pseudorange step detection
- (b) Health word checking.

These two additional functions are required to be implemented in accordance with ETSO-C129a criteria.

Traditional navigation equipment (e.g. VOR, DME and ADF) will need to be installed and be serviceable, so as to provide an alternative means of navigation.

Note: Where GPS stand-alone equipment provides the only RNAV capability installed onboard the aircraft, this equipment, on its own, may be incompatible with a future airspace infrastructure such as Precision RNAV routes, terminal procedures, and where implementation of an augmented satellite navigation system will allow, the decommissioning of traditional ground based radio navigation aids.

5 OPERATIONAL CRITERIA FOR USE OF GPS STAND-ALONE EQUIPMENT

5.1 General Criteria

GPS stand-alone equipment approved in accordance with the guidance provided in this Leaflet, may be used for the purposes of conducting Basic RNAV operations, subject to the operational limitations contained herein. Such equipment should be operated in accordance with procedures acceptable to the Authority. The flight crew should receive appropriate training for use of the GPS stand-alone equipment for the normal and abnormal operating procedures detailed in paragraphs 5.2 and 5.3.

5.2 Normal Procedures

The procedures for the use of navigational equipment on Basic RNAV routes should include the following:

(a) During the pre-flight planning phase, given a GPS constellation of 23 satellites or less (22 or less for GPS stand-alone equipment that incorporate pressure altitude aiding), the availability of GPS integrity (RAIM) should be confirmed for the intended flight (route and time). This should be obtained from a prediction program either ground-based, or provided as an equipment function (see Annex 1), or from an alternative method that is acceptable to the Authority.

Dispatch should not be made in the event of predicted continuous loss of RAIM of more than 5 minutes for any part of the intended flight.

(b) Where a navigation data base is installed, the data base validity (current AIRAC cycle) should be checked before the flight;

(c) Traditional navigation equipment (e.g. VOR, DME and ADF) should be selected to available aids so as to allow immediate cross-checking or reversion in the event of loss of GPS navigation capability.

5.3 Abnormal Procedures in the event of loss of GPS navigation capability

The operating procedures should identify the flight crew actions required in the event of the GPS stand-alone equipment indicating a loss of the integrity monitoring detection (RAIM) function or exceedance of integrity alarm limit (erroneous position). The operating procedures should include the following:

(a) In the event of loss of the RAIM detection function, the GPS stand-alone equipment may continue to be used for navigation. The flight crew should attempt to cross-check the aircraft position, where possible with VOR, DME and NDB information, to confirm an acceptable level of navigation performance. Otherwise, the flight crew should revert to an alternative means of navigation.

(b) In the event of exceedance of the alarm limit, the flight crew should revert to an alternative means of navigation.

ANNEX 1

GPS Integrity Monitoring (RAIM) Prediction Program

Where a GPS Integrity Monitoring (RAIM) Prediction Program is used as a means of compliance with paragraph 5.2(a) of this document, it should meet the following criteria:

1. The program should provide prediction of availability of the integrity monitoring (RAIM) function of the GPS equipment, suitable for conducting Basic RNAV operations in designated European airspace.
2. The prediction program software should be developed in accordance with at least RTCA DO 178B/EUROCAE 12B, level D guidelines.
3. The program should use either a RAIM algorithm identical to that used in the airborne equipment, or an algorithm based on assumptions for RAIM prediction that give a more conservative result.
4. The program should calculate RAIM availability based on a satellite mask angle of not less than 5 degrees, except where use of a lower mask angle has been demonstrated to be acceptable to the Authority.
5. The program should have the capability to manually designate GPS satellites which have been notified as being out of service for the intended flight.
6. The program should allow the user to select:
 - a) the intended route and declared alternates;
 - b) the time and duration of the intended flight.

**AMC 20-5
Airworthiness Approval and Operational Criteria for the use of the Navstar Global Positioning System (GPS)**

1 PURPOSE

This AMC establishes an acceptable means, but not the only means that can be used for airworthiness approval and provides guidelines for operators in the use of the NAVSTAR Global Positioning System (GPS).

2 RELATED MATERIAL

<u>Document-ID</u>	<u>Title of Document</u>
EUROCAE ED 72A	Minimum Operational Performance Specification for Airborne GPS Receiving Equipment used for Supplemental Means of Navigation
ETSO-C115b/ FAA TSO-C115 ()	Airborne Area Navigation Equipment using Multi-sensor Inputs
ETSO-C129a/FAA TSO-C129()	Airborne Supplemental Navigation Equipment using the Global Positioning System (GPS)
ETSO-C145	Airborne Navigation Sensors Using the Global Positioning System (GPS) Augmented by the Wide Area Augmentation System (WAAS).
ETSO-C146	Stand-Alone Airborne Navigation Equipment Using the Global Positioning System (GPS) Augmented by the Wide Area Augmentation System (WAAS)
RTCA DO 208	Minimum Operational Performance Standards for Airborne Supplemental Navigation Equipment using Global Positioning System (GPS)
FAA AC 20-138	Airworthiness Approval of Global Positioning System (GPS) Navigation Equipment for use as a VFR and IFR Supplemental Navigation System (formerly FAA Notice 8110-47).
FAA AC 20-130A	Airworthiness Approval of Navigation or Flight Management Systems Integrating Multiple Navigation Sensors (formerly FAA Notice 8110-48).
FAA AC 90-94	Guidelines for using GPS Equipment for IFR En-route and Terminal Area Operations and for Non-precision Instrument Approaches in the US National Airspace System
FAA Notice 8110.60	GPS as Primary Means of Navigation for Oceanic/Remote Operations
DOT/FAA/AAR-95/3	FAA Aircraft Certification Human Factors and Operations Checklist for Stand Alone GPS Receivers (TSO C129 Class A)
FAA Order 8400.10	HBAT 95-09, Guidelines for Operational Approval of Global Positioning System (GPS) to Provide the Primary Means of Class II Navigation in Oceanic and Remote Areas of Operation

3 BACKGROUND

3.1 The declaration of Full Operational Capability (FOC) for the NAVSTAR GPS constellation, by the United States Department of Defense (DOD) and Department of Transportation (DOT) gives the civil aviation community the opportunity to use the navigation information provided by the constellation.

3.2 Acceptable Means of Compliance for the use of GPS, will assist in the future development of satellite based systems. The aim is to create a Global Navigation Satellite System (GNSS) under civilian control. In the transition to the GNSS, and in order to obtain early benefits, it will be necessary to augment the present military controlled systems - GPS and GLONASS - for example with a combination of geostationary satellites, ground based integrity monitors, civilian funded satellites in conjunction with airborne integrity monitoring techniques such as Receiver Autonomous Integrity Monitoring (RAIM). Other techniques whereby the navigation system determines the integrity of the

AMC-20-5

GPS navigation signals by using other installed aircraft sensor inputs such as INS, DME or other appropriate sensors may be accepted.

Note: Full Operational Capability for GLONASS the Russian navigation system has been declared since 05.02.1996.

3.3 Wherever possible, EASA AMC on the use of GPS will follow that authorised by the FAA. However, some differences will be inevitable due to differences in the organisation of national airspace and the datum used to determine position on the earth's surface.

3.4 It is assumed that the State's bodies responsible for ATM and aerodromes, will take the necessary steps to authorise/publish the use of GPS.

3.5 In the context of this AMC the use of the term „approach“ means „non-precision approach“.

4 TERMINOLOGY

GPS Class A () equipment Equipment incorporating both the GPS sensor and navigation capability. This equipment incorporates RAIM as defined by FAA TSO-C129().

GPS Class B () equipment Equipment consisting of a GPS sensor that provides data to an integrated navigation system e.g. flight management navigation system, multi-sensor navigation system, (FAA TSO-C129()).

GPS Class C () equipment Equipment consisting of a GPS sensor that provides data to an integrated navigation system (e.g. flight management navigation system, multi-sensor navigation system) which provides enhanced guidance to an autopilot or flight director in order to reduce the flight technical error (FAA TSO-C129()).

Receiver Autonomous Integrity Monitoring (RAIM) A technique whereby a GPS receiver processor determines the integrity of the GPS navigation signals using only GPS signals or GPS signals augmented with altitude. This determination is achieved by a consistency check among redundant pseudorange measurements. At least one satellite in addition to those required for navigation should be in view for the receiver to perform the RAIM function (FAA AC 20-138, AC 90-94).

Stand-Alone GPS Navigation System Stand-alone GPS equipment is equipment that is not combined with other navigation sensors or navigation systems such as DME, Loran-C, Inertial. Stand-alone GPS equipment can, however, include other augmentation features such as altimetry smoothing, clock coasting. (FAA AC 20-138).

5 AIRWORTHINESS APPROVAL

The following airworthiness criterion is applicable to the installation of GPS equipment intended for IFR operation, certified according to CS-23, -25, -27 and -29 or the corresponding FAR or national requirements on any aircraft registered in a member state.

5.1 General

This AMC uses FAA Advisory Circulars AC 20-130A and AC 20-138 as the basis for airworthiness approval of GPS.

For certifications granted prior to the issue of these AC's, the corresponding FAA Notices are recognised as being equivalent. The feasibility of this course of action has already been shown: the two Notices have been used within Europe to approve aircraft installations. This AMC is intended to prevent the proliferation of installations of systems non-compliant with the current Advisory Circulars (based for example on the former FAA interim policy dated July 20th 1992).

For multi-sensor navigation systems using GPS inputs, qualified prior to the publication of FAA TSO-C129, where the intent of the TSO may be demonstrated, authorisation for the use of the equipment for the purposes described in this interim guidance may be granted.

The FAA AC's are to be used as Interpretative Material to show compliance with the applicable CS, on each application e.g. 25.1301 and 25.1309.

In the AC's, where reference is made to FAA rules and approval procedures, national or EASA equivalent material should be substituted as appropriate.

5.2 Airworthiness Criteria

The following FAA AC's are to be used as the basis for approval of the GPS equipment installation:

- AC 20-130A for multi-sensor navigation systems using GPS inputs
- AC 20-138 for stand-alone GPS equipment.

In addition to AC 20-138 stand-alone GPS equipment will need to be approved to FAA TSO-C129.

For all classes of equipment, integrity should be provided either by Receiver Autonomous Integrity Monitoring (RAIM) or an equivalent method, e.g. by comparison within a multi-sensor navigation system with other approved sensors. The following Table summarises the Classes and sub class definitions. The types of equipment are specified in FAA TSO C-129(). Refer to section 4 of this AMC for the definition of Class A, B or C.

Class	Stand Alone	Multi Sensor	RAIM	RAIM Equiv.	En Route	Terminal	Non- Precision Approach
A1	X		X		X	X	X
A2	X		X		X	X	
B1		X	X		X	X	X
B2		X	X		X	X	
B3		X		X	X	X	X
B4		X		X	X	X	
C1		X	X		X	X	X
C2		X	X		X	X	
C3		X		X	X	X	X
C4		X		X	X	X	

5.3 Additional Criteria for all GPS installations

In showing compliance with the FAA AC material when verifying GPS accuracy by flight test evaluations, position information should be referenced in WGS-84 coordinates.

5.4 Additional Criteria for Stand-alone GPS equipment only.

The following points need to be taken into consideration as part of the airworthiness approval:

- (a) For IFR operations, Class A equipment, is required to be approved to either:
 - (i) FAA TSO-C129a or
 - (ii) FAA TSO-C129 and the additional paragraphs (a).(3),(xv).5 and (a).(6) of TSO C-129a.
- (b) Where other navigation sources, apart from the stand-alone GPS equipment, provide display and/or guidance to a Flight Director/Autopilot, means should be provided for:
 - a navigation source selector as the only means of selection;
 - clear annunciation of the selected navigation source;
 - display guidance information appropriate to the selected and navigation source; and
 - guidance information to a Flight Director/Autopilot appropriate to the selected and navigation source.

Annunciations for Flight Director, Autopilot and navigation source should be consistent, and compatible with the original design philosophy of the cockpit.
- (c) Loss of navigation capability should be indicated to the flight crew.

AMC-20-5

- (d) If altitude input is used, loss of altitude information should be indicated by the GPS equipment.
- (e) Installation configuration features provided by the GPS equipment which affect airworthiness or operational approval, such as
 - external CDI selection;
 - external CDI calibration;
 - entering of GPS antenna height above ground;
 - serial Input/Output port configuration;
 - reference datum

should not be selectable by the pilot. Instructions on how to configure the GPS equipment for the particular installation should be listed in the appropriate manual.

- (f) Controls, displays, operating characteristics and pilot interface to GPS equipment should be assessed in relation to flight crew workload, particularly in the approach environment.

The FAA checklist concerning the pilot system interface characteristics (ref. DOT/FAA/AAR-95/3) or an equivalent checklist should be applied for GPS approval.

6 OPERATIONAL CRITERIA

This AMC describes acceptable operational criteria for oceanic, en-route, terminal and approach operations, subject to the limitations given below. The operational criteria assumes that the corresponding installation/airworthiness approval has been granted.

Operations of GPS equipment should be in accordance with the AFM or AFM supplement. The (Master) Minimum Equipment List (MMEL/MEL) should identify the minimum equipment necessary to satisfy operations using GPS.

Compliance with the guidance material of this AMC, by itself, is not sufficient to meet the airworthiness or operational criteria specified for Precision RNAV (P-RNAV) operations (See A&GM Section 1, Part 3, TGL 10).

The use of GPS for vertical navigation should not be authorised.

6.1 Use of GPS for Oceanic, En-route and Terminal areas

The following table summarises the operational conditions for the use of GPS for IFR oceanic, domestic en-route and terminal area operations.

OCEANIC/REMOTE	EN-ROUTE	TERMINAL
Refer to chapter 7 for specific operational criteria.	Traditional IFR approved navigation equipment will need to be available to continue the flight when integrity* is lost. * Integrity may be provided by RAIM or equivalent See Note 1	Traditional IFR approved navigation equipment will need to be available to continue the flight when integrity* is lost. * Integrity may be provided by RAIM or equivalent See Notes 1, 2 and 3

Notes:

- (1) When applying these conditions, they mean
 - a) The ground based aids on the route to be flown or ground based aids for RNAV-Routes are operational, and

- b) Aircraft equipment, other than GPS, suitable for the route to be flown, is serviceable
- (2) The SID/STAR will need to be selectable from the navigation data base. The coding of the data base will need to support the officially published SID/STAR.
 - Caution: Some navigation data bases may not contain all required flight path parameters to ensure compliance with the published procedure.
- (3) When flying SID/STARs,
 - a) the procedure established by the State of the aerodrome has to be authorised/published by that State for the use of GPS.
 - b) the state of operator/registry (as applicable) has to approve the operator for such operations.

6.2 Use of GPS Equipment for Non-precision Approaches

In addition to the paragraph 6.1, GPS-based navigation equipment can be used to fly any part of instrument non-precision approaches provided each of the following conditions are met and checked, as required during pre-flight planning.:

- (a) The State of operator/registry (as applicable) has authorised the use of multi-sensor equipment using GPS as one sensor or GPS Class A1 equipment for this purpose;
- (b) the State of the aerodrome has authorised/published an approach for use with GPS;
- (c) the published approach procedure is referenced to WGS-84 co-ordinates;
- (d) the navigation database contains current information on the non-precision approach to be flown (actual AIRAC cycle);
- (e) the approach to be flown is retrievable from the database and defines the location of all navigation aids and all waypoints required for the approach;
- (f) the information stored in the data base is presented to the crew in the order shown on the published non-precision approach plate;
- (g) the navigation data base waypoints showing the non-precision approach cannot be changed by the flight crew;
- (h) the appropriate airborne equipment required for the route to be flown from the destination to any required alternate airport and for an approach at this airport, is installed in the aircraft and is operational. Also, the associated ground-based nav aids are operational.
- (i) The approach is selectable from the navigation data base. The coding of the data base will need to support the officially published approach.

Caution: Some navigation data bases may not contain all required flight path parameters to ensure compliance with the published procedure.

6.2.1 'Overlay' Approaches

An overlay approach is one which allows pilots to use GPS equipment to fly existing non-precision instrument approach procedures. For the purpose of this document, this is restricted to overlay of approaches based on VOR, VOR/DME or VORTAC, NDB, NDB/DME and RNAV.

In addition to paragraphs 6.2 above, compliance with the published procedure will need to be checked against raw data from ground based nav aids, if

- (a) the integrity monitoring function (RAIM or equivalent) is not available or
- (b) for Class A1 equipment approved prior to this AMC the requirements of paragraph 5.4(a) are not satisfied.

The ground-based nav aids and the associated airborne equipment required for the published approach procedure, will need to be operational.

AMC-20-5

6.2.2 GPS Stand-Alone Approaches

A GPS stand-alone approach refers to a non-precision approach procedure based solely on GPS without reference to conventional ground nav aids.

In addition to paragraphs 6.2 above, each of the following conditions apply:

- (a) the integrity monitoring function (RAIM or equivalent) is available,
- (b) Class A1 equipment complies with the requirements of paragraph 5.4(a) of this AMC;
- (c) the published approach procedure is identified as a GPS approach (e.g.: GPS RWY 27;
- (d) during the pre-flight planning stage for an IFR flight:
 - (i) where a destination alternate is required, a non-GPS based approach procedure is available at the alternate;
 - (ii) where a destination alternate is not required, at least one non-GPS based approach procedure is available at the destination aerodrome;
 - (ii) predictive RAIM or an equivalent prediction tool is used, and the monitoring capability (RAIM or equivalent) is available at the destination aerodrome at the expected time of arrival.
- (e) where a take off and/or en-route alternate is required, at least one non-GPS based approach procedure is available at the alternate(s).
- (f) a missed approach procedure is available based on traditional navigation.

7 CRITERIA FOR USE OF GPS IN OCEANIC/REMOTE OPERATIONS

EASA recognises that this operation is a specific application for the use of GPS

FAA Notice 8110.60, titled „GPS as a Primary Means of Navigation for Oceanic/Remote Operations“ proposes interim guidance for approving the installation of GPS equipment to be used for oceanic/remote operations. The notice contains criteria for the GPS equipment in addition to that required for FAA TSO-C129() approval, including capability to automatically detect and exclude a GPS satellite failure by means of a fault detection and exclusion (FDE) algorithm. Guidance is included for the detection of a failure which causes a pseudorange step function and for monitoring the use of GPS navigation data. A prediction program to support operational departure restrictions, is defined.

Where GPS is to be used for oceanic/remote operations as an approved Long Range Navigation System (LRNS), then it should be installed in compliance with FAA Notice 8110.60.

For operations in airspace where an aircraft is required to be equipped with two independent LRNS (i.e. dual control display unit, dual GPS antenna, dual power sources, dual GPS sensors, etc.), such as in North Atlantic Minimum Navigation Performance Specification (MNPS) Airspace, both GPS installations should be approved in accordance with FAA Notice 8110.60.

Compliance with the guidance in this notice does not constitute an operational approval. Operators should apply to their Authority for this approval.

APPENDIX A

A.1 Description of GPS

1.1 The Navstar Global Positioning System (GPS) of the United States Department of Defence (DOD) is a satellite based radio navigation system. Today, twenty-four satellites are in various orbits approximately 11,000 nautical miles above the surface of the earth. Each satellite broadcasts a timing signal and data message. A portion of the data message gives a GPS receiver the orbital details of each satellite. The receiver measures the time taken for the signal to arrive from the satellites in view and from this information computes a position and velocity.

1.2 Three satellites are needed to determine a two dimensional position, and four for a three dimensional position. The elevation and geometry of each satellite relative to the receiver should satisfy certain criteria before the designed system accuracy can be achieved. Accuracy in predictable horizontal positions of 100 meters or better should be available on 95% of time and 300 meters or better on 99.99% of time.

1.3 The figures quoted for accuracy are based on the assumption that the position given is referenced to the World Geodetic System 1984 (WGS 84) Datum. This datum relates position on the earth's surface or in space to a mathematically defined ellipsoid that approximates the complex shape of the Earth. The point of origin of the WGS 84 Datum is the Earth's centre of mass. This allows position information to be derived for the world from one reference. ICAO adopted WGS 84 as a world standard, to be in use by 1998.

1.4 Currently, position information throughout the world is derived from local or regional datums; for example, European Datum 1950 and Nouvelle Triangulation de France (NTF) 1970. These datums use different ellipsoids that approximate the shape of the Earth over a selected area, but are not valid on a global scale. Conversion between datums is possible, but inherent inaccuracies present in National datums can result in large residual errors.

1.5 Consequently, a given position today could be referenced to one of many datums and that position may be significantly displaced from the co-ordinates of the same position when measured against WGS 84. Differences of several hundred meters are not uncommon. With the accuracy provided by today's ground based navigation aids - other than precision approach aids - these discrepancies in position between datums become important when flying a non-precision approach. The introduction of position information provided by satellites for more precise navigation changes this situation, but only when all positions world-wide are based on one datum can the full potential of satellite navigation be realised. Until this stage is reached it is necessary to place some restrictions on the airborne use of the Navstar GPS constellation.

A.2 Limitations of the GPS Constellation and Equipment

2.1 Currently, this AMC is consistent with the use of GPS as authorised by the FAA in most areas, but certain differences in the characteristics of different airspace leads to differences in application.

2.2 Even with FOC, when flying under IFR, the system will not provide the continuity, availability and integrity needed for a Sole Means Air Navigation System. Continuity and availability can be forecast, but determining the integrity of the signals requires other means.

2.3 Most existing ground based navigation aids are flight calibrated and can signal an alarm if erroneous signals are being radiated. For example, VOR signal characteristics are monitored and where the set tolerances are not met the VOR automatically stops transmitting. The GPS constellation is monitored from the ground and it may take some considerable time before users become aware of a malfunction within the system. Several possibilities for providing signal integrity equivalent to that obtained from conventional navigation aids are under consideration, but it will be some years before these possibilities are realised. At present, two methods exist within airborne equipment to provide the integrity of navigation when using GPS signals: Receiver Autonomous Integrity Monitoring (RAIM) and that given by an integrated navigation system where other sensors are used in addition to GPS.

2.4 In airborne equipment incorporating both the GPS sensor and navigation capability, determination of a 3D position requires four satellites with adequate elevation and suitable geometry. An additional satellite is needed to perform the RAIM function. A sixth satellite is required to isolate a faulty satellite and to remove it from the navigation solution (FDE function). Where a GPS receiver

AMC-20-5

uses barometric altitude or clock aiding as an augmentation to RAIM, the number of satellites needed for the receiver to perform the RAIM function may be reduced by one, given appropriate geometry. Not all GPS receivers possess RAIM, but in stand-alone GPS equipment this function is essential for airborne use when flying under IFR.

2.5 In airborne equipment where a GPS sensor provides data to an integrated navigation system, e.g. FMS or a multi-sensor navigation system, either the GPS sensor is required to provide RAIM, or the multi-sensor navigation system should possess a level of integrity equivalent to that provided by RAIM. This level of integrity is required when flying under IFR.

2.6 The availability of six satellites is less than 100%. Consequently, the RAIM function (including FDE) may be interrupted. However, predictive RAIM may be used to predict such interruptions and higher availability figures may be achieved by multi-sensor systems using certain equivalent integrity techniques.

2.7 Without proper airborne integrity monitoring implementations, potential for unannounced failures may exist.

2.8 At this time, the only GPS NOTAM system available is provided by US Government services.

A.3 The Future

3.1 At present, GPS and GLONASS are the only satellite-based system capable of giving a usable service to aviation. It is anticipated that GLONASS, the Russian Global Navigation Satellite System, will provide the same service as GPS, in the future. Combinations of GPS and GLONASS plus other civil satellites and ground augmentation facilities are possible components for a civil Global Navigation Satellite System (GNSS).

3.2 This AMC will be extended to the use of GLONASS as soon as applicable.

3.3 ICAO has established working groups to develop the principles governing the operation of GNSS. Many technical and institutional issues require resolution before GPS can be used without any restrictions. When GNSS as defined by ICAO becomes available (e.g. GPS augmented by other orbiting satellites, geostationary satellites, ground reference stations and differential techniques, either as individual items or in combination), additional applications will be defined.

AMC 20-6

Extended Range Operation with Two-Engine Aeroplanes ETOPS Certification and Operation

1 PURPOSE

This AMC states an acceptable means but not the only means for obtaining approval for two-engine aeroplanes to operate over a route that contains a point further than one hour flying time at the approved one-engine inoperative cruise speed (under standard conditions in still air) from an adequate aerodrome. This AMC allows a continuous curve of diversion time versus propulsion system reliability, however steps of diversion time may be necessary for practical reasons (e.g., 90 minutes, 120 minutes, etc.). Operational requirements may also be related to diversion time.

The content of the AMC will be related to diversion time as follows:

- a. by having three sets of design criteria for 75 minutes or less, more than 75 but less than 90 minutes or above 90 minutes, except that diversion time may be a parameter for the assessment of certain systems;
- b. by applying the same set of criteria for maintenance;
- c. by having three sets of operational criteria: greater than 60 but less than or equal to 90 minutes: greater than 90 minutes but less than or equal to 120 minutes: greater than 120 minutes up to a maximum of 180 minutes.

Accelerated ETOPS.

Operational Approval

Factors to allow reduction or substitution of operator's in-service experience when applying for Accelerated ETOPS, are contained in Appendix 7 of this AMC. Each application will be dealt with by the Authority on a case by case basis and will be based on a specific approved plan. (see Appendix 7)

Type Design Approval (TDA)

- i. 180 minutes ETOPS Approval is considered feasible at the introduction to service of an airframe/engine combination, as long as the Agency is totally satisfied that all aspects of the Approval Plan (CRI) have been completed. The Agency must be satisfied that an approval plan achieves an equivalent level of safety to that intended in that AMC.
- ii. Any deficiency in compliance with the Approved Plan can result in some lesser approval than that sought.
- iii. Operators and Manufacturers will be required to respond to any incident or occurrence in the most expeditious manner. A serious single event or series of related events could result in immediate revocation of ETOPS approval. Any isolated problem not justifying immediate withdrawal of approval, must be included in a Certification Authority approved plan within 30 days.

2 RELATED CERTIFICATION SPECIFICATIONS

CS 25.901, 25.903, 25.1309, 25.1351 d, CS 25 Subpart J, CS-E 510, CS-E 515, CS-E 520, operational requirements.

3 RESERVED

4 TERMINOLOGY

a. *Aerodrome*

- (1) Adequate. For the purpose of this AMC, an adequate aerodrome is an aerodrome, which the operator and the Authority consider to be adequate, having regard to the performance requirements applicable at the expected landing weight or mass. In particular, it should be anticipated that at the expected time of use:

CS-20-6

(i) The aerodrome will be available, and equipped with necessary ancillary services, such as ATC, sufficient lighting, communications, weather reporting, nav aids and emergency services. Rescue and Fire Fighting Services (RFFS) equivalent to ICAO category 4 (for RFFS not located on the aerodrome; capable of meeting the aeroplane with 30 minutes notice) or the relevant aeroplane category if lower, is acceptable for planning purposes only, when being considered as an ETOPS en-route alternate; and

(ii) At least one letdown aid (ground radar would so qualify) will be available for an instrument approach.

(2) Suitable. For the purpose of this AMC a suitable aerodrome is an adequate aerodrome with weather reports, or forecasts, or any combination thereof, indicating that the weather conditions are at or above operating minima and the field condition reports indicate that a safe landing can be accomplished at the time of the intended operation (see Appendix 3).

b. *Auxiliary Power Unit (APU)*

A gas turbine engine intended for use as a power source for driving generators, hydraulic pumps and other aeroplane accessories and equipment and/or to provide compressed air for aeroplane pneumatic systems.

c. *ETOPS Configuration, Maintenance and Procedures (CMP) Standard*

The particular aeroplane configuration minimum requirements including any special inspection, hardware life limits, Master Minimum Equipment List (MMEL) constraints, and maintenance practices found necessary by the Authority to establish the suitability of an airframe-engine combination for extended range operation.

d. *Engine*

The basic engine assembly as supplied by the engine manufacturer.

e. *Extended Range Operations*

For the purpose of this AMC, extended range operations are those flights conducted over a route that contains a point further than one hour flying time at the approved one-engine-inoperative cruise speed (under standard conditions in still air) from an adequate aerodrome.

f. *Extended Range Entry Point*

The extended range entry point is the point on the aeroplane's outbound route which is one hour flying time at the approved one-engine-inoperative cruise speed (under standard conditions in still air) from an adequate aerodrome.

g. *Maintenance Personnel*

Mechanics, Licensed Ground Engineers, Maintenance Support Personnel.

h. *In-flight Shutdown (IFSD)*

When an engine ceases to function in flight and is shutdown, whether self-induced, crew initiated or caused by some other external influence (i.e., In Flight Shutdown (IFSD) for all causes; for example: due to flameout, internal failure, crew-initiated shutoff, foreign object ingestion, icing, inability to obtain and/or control desired thrust).

i. *ETOPS significant system*

(1) A system for which the fail-safe redundancy characteristics are directly linked to the number of engines, e.g., hydraulic system, pneumatic system, electrical system.

(2) A system that may affect the proper functioning of the engines to the extent that it could result in an in-flight shutdown or uncommanded loss of thrust, e.g., fuel system, thrust reverser or engine control or indicating system, engine fire detection system.

(3) A system which contributes significantly to the safety of flight and a diversion with one engine inoperative, such as back-up systems used in case of additional failure during the diversion. These include back-up or emergency generator, APU or systems essential for maintaining the ability to cope with prolonged operation at single engine altitudes, such as anti-icing systems.

(4) A system for which certain failure conditions may reduce the safety of a diversion, e.g. navigation, communication, equipment cooling, time limited cargo fire suppression, oxygen system.

A system includes all elements of equipment necessary for the control and performance of a particular major function. It includes both the equipment specifically provided for the function in question and other basic equipment such as that necessary to supply power for the equipment operation.

(i) Airframe System. Any system on the aeroplane that is not a part of the propulsion system.

(ii) Propulsion System. The aeroplane propulsion system includes: each component that is necessary for propulsion; components that affect the control of the major propulsion units; and components that affect the safe operation of the major propulsion units.

j. *Approved One-Engine-Inoperative Cruise Speed*

(1) The approved one-engine-inoperative cruise speed for the intended area of operation must be a speed, within the certificated limits of the aeroplane, selected by the operator and approved by the authority.

(2) The operator must use this speed in

(i) establishing the outer limit of the area of operation and any dispatch limitation

(ii) calculation of single engine fuel requirements under paragraph 10.d.(4) Fuel and Oil Supply of this AMC and

(iii) establishing the level off altitude (net performance) data. This level off altitude (net performance) must clear any obstacle en route by margins as specified in the operational requirements.

(3) As permitted under paragraph 10.f.(3) of this AMC, based on evaluation of the actual situation, the pilot in command has the authority to deviate from the planned one-engine-inoperative cruise speed.

5 DISCUSSION

To be eligible for extended range operations, the specified airframe-engine combination should have been certificated to the airworthiness standards of Large Aeroplanes and should be evaluated considering the concepts in paragraph 7, evaluated considering the type design considerations in paragraph 8 and Appendix 2, evaluated considering in-service experience for ETOPS type design discussed in paragraph 9 or Approval Plan (CRI) for Accelerated ETOPS Type Design Approval and evaluated considering the continuing airworthiness and operational concepts outlined in paragraph 10.

6 APPLICABILITY AND GRANDFATHER CLAUSES

Applicability and grandfather clauses will be found, when appropriate, in the operational requirements.

7 CONCEPTS

Although it is self-evident that the overall safety of an extended range operation cannot be better than that provided by the reliability of the propulsion systems, some of the factors related to extended range operation are not necessarily obvious.

For example, cargo compartment fire suppression/containment capability could be a significant factor, or operational/maintenance practices may invalidate certain determinations made during the aeroplane type design certification or the probability of system failures could be a more significant problem than the probability of propulsion system failures. Although propulsion system reliability is a critical factor, it is not the only factor which should be seriously considered in evaluating extended range operation. Any decision relating to extended range operation with two-engine aeroplanes should

CS-20-6

also consider the probability of occurrence of any conditions which would reduce the capability of the aeroplane or the ability of the crew to cope with adverse operating conditions.

The following is provided to define the concepts for evaluating extended range operation with two-engine aeroplanes. This approach ensures that two-engine aeroplanes are consistent with the level of safety required for current extended range operation with three and four-engine turbine powered aeroplanes without unnecessarily restricting operation.

a. *Airframe Systems*

A number of airframe systems have an effect on the safety of extended range operation; therefore, the type design certification of the aeroplane should be reviewed to ensure that the design of these systems are acceptable for the safe conduct of the intended operation.

b. *Propulsion Systems*

In order to maintain a level of safety consistent with the overall safety level achieved by modern aeroplanes, it is necessary for two-engine aeroplanes used in extended range operation to have an acceptably low risk of significant loss of power/thrust for all design and operation related causes (see Appendix 1).

c. *Maintenance and Reliability Programme Definition*

Since the quality of maintenance and reliability programmes can have an appreciable effect on the reliability of the propulsion system and the airframe systems required for extended range operation, an assessment should be made of the proposed maintenance and reliability programme's ability to maintain a satisfactory level of propulsion and airframe system reliability for the particular airframe-engine combination.

d. *Maintenance and Reliability Programme Implementation*

Following a determination that the airframe systems and propulsion systems are designed to be suitable for extended range operation, an in-depth review of the applicant's training programmes, operations and maintenance and reliability programmes should be accomplished to show ability to achieve and maintain an acceptable level of systems reliability to safely conduct these operations.

e. *Human Factors*

System failures or malfunctions occurring during extended range operation could affect flight crew workload and procedures. Since the demands on the flight crew may increase, an assessment should be made to ensure that more than average piloting skills or crew co-ordination are not required.

f. *Approval Basis*

Each applicant (manufacturer or operator as appropriate) for extended range Approval should show that the particular airframe-engine combination is sufficiently reliable. Systems required for extended range operation should be shown by the manufacturer to be designed to a fail-safe criteria and should be shown by the operator to be continuously maintained and operated at levels of reliability appropriate for the intended operation.

(1) *Type Design ETOPS Approval*

(i) The process which will normally lead to the type design ETOPS Approval can be divided into two steps:

(A) Eligibility for ETOPS: The applicant should show that the design features of the particular airframe-engine combination are suitable for the intended operations (see paragraph 8).

(B) Capability for ETOPS: The applicant should show that the particular airframe-engine combination, having been recognised eligible for ETOPS, can achieve a sufficiently high level of reliability in service so that safe extended range operation may be conducted. The achievement of the required level of propulsion system reliability is determined in accordance with Appendix 1 (see

paragraph 9). The reliability of the airframe systems is determined in accordance with Appendix 2 (see paragraph 8).

(ii) Evidence that the type design of the aeroplane is approved for extended range operation is normally reflected by a statement in the Authority approved Aeroplane Flight Manual (AFM) and Type Certificate Data sheet which references the CMP standard requirements for extended range operations.

(2) *In-service experience*

It is also necessary for each operator desiring approval for extended range operation to show that it has obtained sufficient maintenance and operations experience with that particular airframe-engine combination to conduct safely these operations (see paragraph 10.a).

(3) *Operations Approval*

The type design approval does not reflect a continuing airworthiness or operational approval to conduct extended range operations. Therefore, before approval, each operator should demonstrate the ability to maintain and operate the aeroplane so as to achieve the necessary reliability and to train its personnel to achieve the competence in extended operation. The operational approval to conduct an extended range operation is made by amendment to the operator certificate issued by the appropriate Authority (see paragraph 10) which includes requisite items provided in the AFM.

(4) *Continuing Airworthiness*

The type design ETOPS Approval holder and the Agency should periodically review the in-service reliability of the airframe-engine combination. Further to these reviews and every time that an urgent problem makes it necessary, the Agency may require that the type design CMP standard be revised to achieve and maintain the desired level of reliability and, therefore safety of the extended range operation. The CMP standard in effect prior to revision will no longer be considered suitable for continued extended range operation. The CMP standard and its revisions, may require priority actions to be implemented before the next ETOPS flight and other actions to be implemented according to a schedule accepted by the Agency.

Note: See also Appendix 1 paragraph e Continuing Airworthiness for Aircraft Systems. Periodically means in this context typically two years. This means that reviews are conducted every 24 months.

8 TYPE DESIGN APPROVAL CONSIDERATION FOR ELIGIBILITY

When a two-engine type design aeroplane is intended to be used in extended range operations, a determination should be made that the design features are suitable for the intended operation. In some cases modifications to systems may be necessary to achieve the desired reliability. The essential airframe systems and the propulsion system for the particular airframe-engine combination should be shown to be designed to fail-safe criteria and through service experience it must be determined that it can achieve a level of reliability suitable for the intended operation.

a. *Request for Approval*

An aeroplane manufacturer or other civil airworthiness Authorities, requesting a determination that a particular airframe-engine combination is a suitable type design for extended range operation, should apply to the Certification Authority. The Certification Authority will then initiate an assessment of the airframe-engine combination in accordance with paragraphs 8, 9 and Appendix 1 & 2 of this AMC.

b. *Criteria*

The applicant should conduct an evaluation of failures and failure combinations based on engineering and operational consideration as well as acceptable fail-safe methodology. The analysis should consider effects of operations with a single engine, including allowance for additional stress that could result from failure of the first propulsion system. Unless it can be shown that equivalent safety levels are provided or the effects of failure are minor, failure and reliability analysis should be used as guidance in verifying that the proper level of fail-safe design has been provided. The following criteria are applicable to the extended range operation of aeroplanes with two engines:

CS-20-6

- (1) Airframe systems should be shown to comply with CS 25.1309.
- (2) The propulsion systems should be shown to comply with CS 25.901.
 - (i) Engineering and operational judgement applied in accordance with the guidance outlined in paragraph 9 and Appendix 1 should be used to show that the propulsion system can achieve the desired level of reliability.
 - (ii) Contained engine failure, cascading failures, consequential damage or failure of remaining systems or equipment should be assessed in accordance with CS 25.901.
 - (iii) It should be shown during type design evaluation that adequate engine limit margins exist (i.e., rotor speed, exhaust gas temperatures) for conducting extended duration single-engine operation during the diversion at all approved power levels and in all expected environmental conditions. The assessment should account for the effects of additional engine loading demands (e.g., anti-icing, electrical, etc.) which may be necessary during the single-engine flight phase associated with the diversion (see Appendix 4).

Note: Adequate, as referred to in first line of 8.b.(2)(iii), means that engine limits margins after allowing for the effects of additional loading demands associated with single-engine flight will not exceed the approved engine limits at a particular power setting.

- (3) The safety impact of an uncontained engine failure should be assessed in accordance with CS 25.903, CS-E 510 and CS-E 520.

- (4) The APU installation, if required for extended range operations, should meet the applicable CS 25 provisions (Subpart J, APU) and any additional requirements necessary to demonstrate its ability to perform the intended function as specified by the Authority following a review of the applicant's data. If a certain extended range operation may necessitate in-flight start and run of the APU, it must be substantiated that the APU has adequate capability and reliability for that operation.

- (5) Extended duration, single-engine operations should not require exceptional piloting skills and/or crew co-ordination. Considering the degradation of the performance of the aeroplane type with an engine inoperative, the increased flight crew workload, and the malfunction of remaining systems and equipment, the impact on flight crew procedures should be minimised.

Consideration should also be given to the effects of continued flight with an engine and/or airframe system inoperative on the flight crew's and passengers' physiological needs (e.g., cabin temperature control).

- (6) It should be demonstrated for extended duration single-engine operation, that the remaining power (electrical, hydraulic, pneumatic) will continue to be available at levels necessary to permit continued safe flight and landing, and to provide those services necessary for the overall safety of the passengers and crew.

Unless it can be shown that cabin pressure can be maintained on single-engine operation at the altitude necessary for continued flight to a suitable aerodrome, oxygen should be available to sustain the passengers and crew for the maximum diversion time.

- (7) In the event of any single failure, or any combination of failures not shown to be Extremely Improbable, it should be shown that electrical power is provided for essential flight instruments, warning systems, avionics, communications, navigation, required route or destination guidance equipment, supportive systems and/or hardware and any other equipment deemed necessary for extended range operation to continue safe flight and landing at a suitable aerodrome. Information provided to the flight crew should be of sufficient accuracy for the intended operation.

Functions to be provided may differ between aeroplanes and should be agreed with the Authority/Agency. These should normally include:

- (i) attitude information;
- (ii) adequate radio communication and intercommunication capability;

- (iii) adequate navigation capability (including weather radar);
- (iv) adequate cockpit and instrument lighting, Emergency lighting and landing lights;
- (v) sufficient captain and first officer instruments, provided cross-reading has been evaluated;
- (vi) heading, airspeed and altitude including appropriate pitot/static heating;
- (vii) adequate flight controls including auto-pilot;
- (viii) adequate engine controls, and restart capability with critical type fuel (from the stand-point of flame out and restart capability) and with the aeroplane initially at the maximum relight altitude;
- (ix) adequate fuel supply system capability including such fuel boost and fuel transfer functions that may be necessary;
- (x) adequate engine instrumentation;
- (xi) such warning, cautions, and indications as are required for continued safe flight and landing;
- (xii) fire protection (cargo, APU and engines);
- (xiii) adequate ice protection including windshield de-icing;
- (xiv) adequate control of cockpit and cabin environment including heating and pressurisation; and,
- (xv) ATC Transponder.

Note: For 90 minutes or less ETOPS operations, the functions to be provided must satisfy the requirements of CS 25.1351(d)(2) as interpreted by AMC 25.1351(d)(4) and (5).

(8) Three or more reliable and independent electrical power sources should be available. As a minimum, following failure of any two sources, the remaining source should be capable of powering the items specified in paragraph 8.b.(7). If one or more of the required electrical power sources are provided by an APU, hydraulic system, or ram air turbine, the following criteria apply as appropriate:

- (i) The APU, when installed, should meet the criteria in paragraph 8.b.(4).
- (ii) The hydraulic power source should be reliable. To achieve this reliability, it may be necessary to provide two or more independent energy sources (e.g., bleed air from two or more pneumatic sources).
- (iii) The Ram Air Turbine (RAT) should be demonstrated to be sufficiently reliable in deployment and use. The RAT should not require engine dependent power for deployment.

Note: For 75 minutes or less ETOPS operations, if one of the required electrical power sources is provided by batteries, the following criteria apply:

The electrical power and distribution system including the standby or alternate power system, should comply with the requirements of CS 25.1351 and associated AMC's. Where the alternate power source provided to comply with CS 25.1351(d) is time limited (e.g. batteries), such a power source should have a capability to enable the items required by the verifying authority in paragraph 8.b.(7) to be powered for the maximum certificated diversion time in still air conditions, plus an allowance for holding, approach and landing, and the likely prevailing weather conditions for the planned routes ,(e.g. an allowance for headwinds).

CS-20-6

(9) It should be shown that adequate status monitoring information and procedures on all critical systems are available for the flight crew to make pre-flight, in-flight go/no-go and diversion decisions.

(10) Extended range operations are not permitted with time-related cargo fire limitations less than the approved maximum diversion time in still air conditions (plus an allowance for 15 minutes holding an approach and landing, and the likely prevailing weather conditions for the planned route, e.g. allowance for headwinds) determined by considering other relevant failures, such as an engine inoperative, and combinations of failures not shown to be Extremely Improbable.

(11) Airframe and propulsion ice protection should be shown to provide adequate capability (aeroplane controllability, etc.) for the intended operation. This should account for prolonged exposure to lower altitudes associated with the single engine diversion, cruise, holding, approach and landing.

(12) *Solutions to achieve required reliability*

The permanent solution to a problem should be, as far as possible, a hardware/design solution. However, if scheduled maintenance, replacement, and/or inspection are utilised to obtain type design approval for extended range operation, and therefore are required in the CMP standard document, this type of solution should normally be temporary and the specific maintenance information should be easily retrievable and clearly referenced and identified in an appropriate maintenance document.

c. *Analysis of Failure Effects and Reliability*

(1) *General*

The analysis and demonstration of airframe and propulsion system failure effects and reliability provided by the applicant as required by paragraph 8.b. should be based on in-service experience as required by paragraph 9, and the expected longest diversion time for extended range routes likely to be flown with the aeroplane. If it is necessary in certain failure scenarios to consider less time due to time limited systems, the latter will be established as the maximum diversion time.

(2) *Propulsion systems*

(i) An assessment of the propulsion system's reliability for particular airframe-engine combinations should be made in accordance with paragraph 9 and Appendix 1.

(ii) The analysis should consider:

(A) Effects of operation with a single-propulsion system (i.e., high-power demands including extended use of MCT and bleed requirements, etc.) and include possible damage that could result from failure of the first propulsion system.

(B) Effects of the availability and management of fuel for propulsion system operation (i.e., cross-feed valve failures, fuel mismanagement, ability to detect and isolate leaks, etc.).

(C) Effects of other failures, external conditions, maintenance and crew errors, that could jeopardise the operation of the remaining propulsion system, should be examined.

(D) Effect of inadvertent thrust reverser deployment, if not shown to be Extremely Improbable (includes design and maintenance).

(3) *Hydraulic Power and Flight Control*

An analysis should be carried out taking into account the criteria detailed in paragraph 8.b.(6).

Consideration of these systems may be combined, since many commercial aeroplanes have full hydraulically powered controls. For aeroplanes with all flight controls being hydraulically powered, evaluation of hydraulic system redundancy should show that single failures or failure combinations, not shown to be Extremely Improbable, do not preclude continued safe flight and landing at a suitable aerodrome. As part of this evaluation, the loss of any two hydraulic systems and any engine should be assumed to occur unless it is established during failure evaluation that there are no sources of damage or the location of the damage sources are such that this failure condition will not occur.

Note: For 75 minutes or less ETOPS approval, additional analysis to show compliance with paragraph 8.b will not be required for airframe systems, where for basic (non ETOPS) Type Design Approval (TDA), compliance with CS 25.1309, or its equivalent, has already been shown.

(4) *Services Provided by Electrical Power*

An analysis should show that the criteria detailed in paragraphs 8.b.(6), (7) and (8) are satisfied taking into account the exposure times established in paragraph 8.c.(1).

Note: For 75 minutes or less ETOPS approval, additional analysis to show compliance with paragraph 8.b will not be required for airframe systems, where for basic (non ETOPS) Type Design Approval (TDA), compliance with CS 25.1309, or its equivalent, has already been shown.

(5) *Equipment Cooling*

An analysis should establish that the equipment (including avionics) necessary for extended range operation has the ability to operate acceptably following failure modes in the cooling system not shown to be Extremely Improbable. Adequate indication of the proper functioning of the cooling system should be demonstrated to ensure system operation prior to dispatch and during flight.

Note: For 75 minutes or less ETOPS approval, additional analysis to show compliance with paragraph 8.b will not be required for airframe systems, where for basic (non ETOPS) Type Design Approval (TDA), compliance with CS 25.1309, or its equivalent, has already been shown.

(6) *Cargo Compartment*

It should be shown that the cargo compartment design and fire protection system capability (where applicable) is consistent with the following:

(i) Design

The cargo compartment fire protection system integrity and reliability should be suitable for the intended operation considering fire detection sensors, liner materials, etc.

(ii) Fire Protection

An analysis or tests should be conducted to show, considering approved maximum diversion in still air (including an allowance for 15-minute holding and/or approach and land), that the ability of the system to suppress or extinguish fires is adequate to ensure safe flight and landing at a suitable aerodrome.

(7) Reserved

(8) *Cabin Pressurisation*

A review of fail-safe and redundancy features should show that the loss of cabin pressure is Improbable under single-engine operating conditions. Authority/Agency approved aeroplane performance data should be available to verify the ability to continue safe flight and landing after loss of pressure and subsequent operation at a lower altitude (see also paragraph 8.b.(6)).

(9) *Cockpit and Cabin Environment*

The analysis should show that an adequate cockpit and cabin environment is preserved following all combinations of propulsion and electrical system failures which are not shown to be Extremely Improbable.

Note: For 75 minutes or less ETOPS approval, additional analysis to show compliance with paragraph 8.b will not be required for airframe systems, where for basic (non ETOPS) Type Design Approval (TDA), compliance with CS 25.1309, or its equivalent, has already been shown.

d. *Assessment of Failure Conditions*

In assessing the fail-safe features and effects of failure conditions, account should be taken of:

(1) The variations in the performance of the system, the probability of the failure(s), the complexity of the crew action.

CS-20-6

(2) Factors alleviating or aggravating the direct effects of the initial failure condition, including consequential or related conditions existing within the aeroplane which may affect the ability of the crew to deal with direct effects, such as the presence of smoke, aeroplane accelerations, interruption of air-to-ground communication, cabin pressurisation problems, etc.

(3) A flight test should be conducted to validate expected aeroplane flying qualities and performance considering propulsion system failure, electrical power losses, etc. The adequacy of remaining aeroplane systems and performance and flight crew ability to deal with the emergency, considering remaining flight deck information, will be assessed in all phases of flight and anticipated operating conditions. Depending on the scope, content, and review by the Agency of the manufacturer's data base, this flight test could also be used as a means for approving the basic aerodynamic and engine performance data used to establish the aeroplane performance identified in paragraph 10.d.(6).

e. *Authority Aeroplane Assessment Report*

The assessment of the reliability of propulsion and airframe systems for a particular airframe-engine combination will be contained in an Authority - approved Aeroplane Assessment Report. This report will be approved by the Certification Authority after review and concurrence by the Authority responsible for Operations. In the case of a subsequent Certification Authority, the report may incorporate partly or totally the report established by the original Authority.

Following approval of the report, the propulsion and airframe system recommendations will be included in an Authority-approved document that establishes the CMP standard requirements for the candidate aeroplane. This document will then be referenced in the Operation Specification and the Aeroplane Flight Manual.

f. *ETOPS Type Design Approval*

Upon satisfactory completion of the aeroplane evaluation through an engineering inspection and test programme consistent with the type certification procedures of the Agency and sufficient in-service experience data. (see Appendix 1 & 2)

(1) The type design approval will be reflected in the approved AFM or supplement, and Type Certification Data Sheet or Supplemental Type Certificate which contain directly or by reference the following pertinent information, as applicable:

- (i) special limitations (if necessary), including any limitations associated with a maximum diversion time established in accordance with paragraph 8.c.(1);
- (ii) additional markings or placards (if required);
- (iii) revision to the performance section in accordance with paragraph 10.d.(6);
- (iv) the airborne equipment, installation, and flight crew procedures required for extended range operations;
- (v) description or reference to a document containing the approved aeroplane configuration CMP standard;
- (vi) a statement to the effect that:

"The type design reliability and performance of this airframe-engine combination has been evaluated in accordance with AMC 20-6 and found suitable for (state maximum diversion time) extended range operations with the incorporation of the approved aeroplane configuration CMP standard. This finding does not constitute approval to conduct extended range operations".

g. *Type Design Change Process*

(1) The Agency will include the consideration of extended range operation in its normal monitoring and design change approval functions.

(2) The Propulsion System Reliability Assessment Board (PSRAB) will periodically check that the propulsion system reliability requirements for extended range operation (see Appendix 1) are achieved or maintained.

Note: Periodically means in this context two years.

(3) Any significant problems which adversely affect extended range operation will be corrected. Modifications or maintenance actions to achieve or maintain the reliability objective of extended range operations for the airframe-engine combination will be incorporated into the design CMP standard document. The Agency/Authority will co-ordinate this action with the affected manufacturer and operator.

(4) The Airworthiness Directive process may be utilised as necessary to implement a CMP standard change.

h. Continued Airworthiness

The type design CMP standard which establishes the suitability of an aeroplane for extended range operation defines the minimum standard for the operation.

Additional modifications or maintenance actions generated by an operator or manufacturer to enhance or maintain the continued airworthiness of the aeroplane must be made through the normal approval process.

The operator or manufacturer (as appropriate) should thoroughly evaluate such changes to ensure that they do not adversely affect reliability or conflict with requirements for extended range approval.

9 IN-SERVICE EXPERIENCE FOR ETOPS TYPE DESIGN APPROVAL

In establishing the suitability of a type design in accordance with paragraph 8 of this AMC and as a pre-requisite to obtaining any operational approval in accordance with the criteria of paragraph 10 of this AMC, it should be shown that an acceptable level of propulsion system and airframe systems reliability can be or has been achieved in service by the world fleet for the particular airframe-engine combination.

For this purpose, prior to the type design approval, paragraph 8, it should be shown that the world fleet of the particular airframe-engine combination for which approval is sought can achieve or has achieved, as determined by the Agency (see Appendix 1), an acceptable and reasonably stable level of single propulsion system in-flight shutdown (IFSD) rate and airframe system reliability. Engineering and operational judgement applied in accordance with the guidance outlined in Appendix 1 will then be used to determine that the IFSD rate objective for all independent causes can be or has been achieved. This assessment is an integral part of the determination in paragraph 8.b.(2) for type design approval. This determination of propulsion system reliability is derived from a world fleet data base containing, in accordance with requirements of Appendix 1, all in-flight shutdown events, all significant engine reliability problems, design and test data and available data on cases of significant loss of thrust, including those where the propulsion system failed or the engine was throttled back or shut down by the pilot. This determination will take due account of the approved maximum diversion time, proposed rectification of all identified propulsion and ETOPS significant systems problems, as well as events where in-flight starting capability may be degraded.

10 OPERATIONAL APPROVAL CONSIDERATIONS

Three sets of criteria are to be used:

- Operational approval criteria for extended range operations with a maximum diversion time of 90 minutes or less to an en-route alternate (at the approved one-engine-inoperative cruise speed under standard conditions in still air). Paragraphs 10.a. to 10.i. and Appendix 5 apply.
- Operational approval for extended range operations with a maximum diversion time above 90 minutes up to 120 minutes to an en-route alternate (at the approved one-engine-inoperative cruise speed under standard conditions in still air). Paragraph 10.a. to 10.i. applies.
- Operational approval for extended range operations with a maximum diversion time above 120 minutes up to 180 minutes to an en-route alternate (at the approved one-engine-inoperative cruise speed under standard conditions in still air). Paragraph 10j applies in addition to 10.a. to 10.i.

Purposes of Appendices:

CS-20-6

Appendices 3, 4 and 5 provide additional and expanded explanations on the requirements for en-route alternates and maintenance requirements respectively.

a. *Requesting Approval*

Any operator requesting approval for extended range operations with two-engine aeroplanes (after the satisfaction of the considerations in paragraphs 8 and 9) should submit the requests, with the required supporting data, to the Authority at least 3 months prior to the proposed start of extended range operation with the specific airframe-engine combination.

(1) *In-service Experience for Operational Approval*

Each operator requesting Approval will be required to have appropriate experience. A summary must be provided to the Authority, indicating the operator's capability to maintain and operate the specific airframe-engine combination for the intended extended range operation. This summary should include experience with the engine type or related engine types, experience with the aeroplane systems or related aeroplane systems, or experience with the particular airframe-engine combination on non-extended range routes. Approval would be based on a review of this information.

Note 1: Additional information regarding Reduction of Operator's in-service experience is contained in Appendix 7.

Note 2: The operator's authorised maximum diversion time may be progressively increased by the Authority as the operator gains experience on the particular airframe-engine combination. Not less than 12 consecutive months experience will normally be required before authorisation of 120 minutes maximum diversion time, unless the operator can show compensating factors. The factors to consider may include calendar time, total number of flights, operator's diversion events, record of the airframe-engine combination with other operators, quality of operator's programmes and route structure. However, the operator will still need, in the latter case, to demonstrate his capability to maintain and operate the new airframe-engine combination at a similar level of reliability.

(2) In considering an application from an operator to conduct extended range operations, an assessment should be made of the operator's overall safety record, past performance, flight crew training and experience, and maintenance programme. The data provided with the request should substantiate the operator's ability and competence to safely conduct and support these operations and should include the means used to satisfy the considerations outlined in this paragraph. (Any reliability assessment obtained, either through analysis or service experience, should be used as guidance in support of operational judgements regarding the suitability of the intended operation.)

b. *Assessment of the Operator's Propulsion System Reliability*

Following the accumulation of adequate operating experience by the world fleet of the specified airframe-engine combination and the establishment of an IFSD rate objective in accordance with Appendix 1 for use in ensuring the propulsion system reliability necessary for extended range operations, an assessment should be made of the applicant's ability to achieve and maintain this level of propulsion system reliability.

This assessment should include trend comparisons of the operator's data with other operators as well as the world fleet average values, and the application of a qualitative judgement that considers all of the relevant factors. The operator's past record of propulsion system reliability with related types of power units should also be reviewed, as well as its record of achieved systems reliability with the airframe-engine combination for which authorisation is sought to conduct extended range operations.

Note: Where statistical assessment alone may not be applicable, e.g., when the fleet size is small, the applicant's experience will be reviewed on a case-by-case basis.

c. *Engineering Modifications and Maintenance Programme Considerations*

Although these considerations are normally part of the operator's continuing airworthiness programme, the maintenance and reliability programme may need to be supplemented in consideration of the special requirements of extended range operation (Appendix 4). The following items, as part of the

operator's programme will be reviewed to ensure that they are adequate for extended range operations:

(1) *Engineering Modifications*

The operator should provide to the Authority all titles and numbers of all modifications, additions, and changes which were made in order to substantiate the incorporation of the CMP standard in the aeroplanes used in extended range operation.

(2) *Maintenance Procedures*

Following Approval of the changes in the maintenance and training procedures, substantial changes to maintenance and training procedures, practices, or limitations established to qualify for extended range operations should be submitted to the Authority at least two months before such changes may be adopted.

(3) *Reliability Reporting*

The reliability reporting programme as supplemented and approved, should be implemented prior to and continued after approval of extended range operation. Data from this process should result in a suitable summary of problem events, reliability trends and corrective actions and be provided regularly to the Authority and to the relevant airframe and engine manufacturers. Appendix 4 contains additional information concerning propulsion and airframe system reliability monitoring and reporting.

(4) *Implementation*

Approved modifications and inspections which would maintain the reliability objective for the propulsion and airframe systems as a consequence of Airworthiness Directive (AD) actions and/or revised CMP standards should be promptly implemented.

Note: In principle, the CMP does not repeat Airworthiness Directives. An operator thus needs to ensure compliance with both the ADs applicable in its country and the CMP standards when operating ETOPS.

Other recommendations made by the engine and airframe manufacturers should also be considered for prompt implementation. This would apply to both installed and spare parts.

The ETOPS operational approval of each ETOPS operator will require it to keep its ETOPS fleets in conformity with the current CMP standards, taking into account implementation delays (see paragraph 7.f.(4)).

(5) *Control Process*

Procedures and a centralised control process should be established which would preclude an aeroplane being released for extended range operation after propulsion system shutdown or primary airframe system failure on a previous flight, or significant adverse trends in system performance, without appropriate corrective action having been taken. Confirmation of such action as being appropriate, in some cases, may require the successful completion of one or more non-revenue or non-ETOPS revenue flights (as appropriate) prior to being released on an extended range operation.

(6) *Programmes*

The maintenance programme used, will ensure that the airframe and propulsion systems will continue to be maintained at the level of performance and reliability necessary for extended range operation, including such programmes as engine condition monitoring and engine oil consumption monitoring.

d. *Flight Preparation and In-flight Considerations*

(1) *General*

The flight release considerations specified in this paragraph are in addition to, or amplify, the operational requirements and specifically apply to extended range operations. Although many of the considerations in this AMC are currently incorporated into approved programmes for other aeroplanes or route structures, the unique nature of extended range operations with two-engine aeroplanes necessitates a re-examination of these operations to ensure that the Approved programmes are adequate for this purpose.

CS-20-6

(2) *Minimum Equipment List (MEL)*

System redundancy levels appropriate to extended range operations should be reflected in the Master Minimum Equipment List (MMEL). An operator's MEL may be more restrictive than the MMEL considering the kind of extended range operation proposed and equipment and service problems unique to the operator. Systems considered to have a fundamental influence on flight safety may include, but are not limited to, the following:

- (i) electrical, including battery;
- (ii) hydraulic;
- (iii) pneumatic;
- (iv) flight instrumentation;
- (v) fuel;
- (vi) flight control;
- (vii) ice protection;
- (viii) engine start and ignition;
- (ix) propulsion system instruments;
- (x) navigation and communications;
- (xi) auxiliary power-unit;
- (xii) air conditioning and pressurisation;
- (xiii) cargo fire suppression;
- (xiv) engine fire protection;
- (xv) emergency equipment; and
- (xvi) any other equipment necessary for extended range operations.

(3) *Communication and Navigation Facilities*

An aeroplane should not be released on an extended range operation unless:

- (i) Communications facilities are available to provide under normal conditions of propagation at the appropriate one-engine-inoperative cruise altitudes, reliable two-way voice communications between the aeroplane and the appropriate air traffic control unit over the planned route of flight and the routes to any suitable alternate to be used in the event of diversion.
- (ii) Non-visual ground navigation aids are available and located so as to provide, taking account of the navigation equipment installed in the aeroplane, the navigation accuracy necessary for the planned route and altitude of flight, and the routes to any alternate and altitudes to be used in the event of an engine shutdown; and
- (iii) Visual and non-visual aids are available at the specified alternates for the anticipated types of approaches and operating minima.

(4) *Fuel and Oil Supply*

(i) General

An aeroplane should not be released on an extended range operation unless it carries sufficient fuel and oil to meet the operational requirements and any additional fuel that may be determined in accordance with paragraph 10.d.(4)(ii). In computing fuel requirements, at least the following should be considered as applicable:

- (A) Current forecast winds and meteorological conditions along the expected flight path at the appropriate one-engine-inoperative cruise altitude and throughout the approach and landing;

- (B) Any necessary operation of ice protection systems and performance loss due to ice accretion on the unprotected surfaces of the aeroplane;
- (C) Any necessary operation of Auxiliary Power Unit (APU);
- (D) Loss of aeroplane pressurisation and air conditioning; consideration should be given to flying at an altitude meeting oxygen requirements in the event of loss of pressurisation;
- (E) An approach followed by a missed approach and a subsequent approach and landing;
- (F) Navigational accuracy necessary; and
- (G) Any known Air Traffic Control (ATC) constraints.

Note: APU oil consumption should also be considered as necessary.

(ii) Critical Fuel Reserves

In establishing the critical fuel reserves, the applicant is to determine the fuel necessary to fly to the most critical point and execute a diversion to a suitable alternate under the conditions outlined in paragraph 10.d.(4)(iii), the 'Critical Fuel Scenario'. These critical fuel reserves should be compared to the normal applicable operational rule requirements for the flight. If it is determined by this comparison that the fuel to complete the critical fuel scenario exceeds the fuel that would be on board at the most critical point, as determined by applicable operational rule requirements, additional fuel should be included to the extent necessary to safely complete the critical fuel scenario. In consideration of the items listed in paragraph 10.d.(4)(i), the critical fuel scenario should allow for a contingency figure of 5 per cent added to the calculated fuel burn from the critical point to allow for errors in wind forecasts, a 5 per cent penalty in fuel mileage **, any Configuration Deviation List items, both airframe and engine anti-icing; and account for ice accumulation on unprotected surfaces if icing conditions are likely to be encountered during the diversion. If the APU is a required power source, then its fuel consumption should be accounted for during the appropriate phase(s) of flight.

(** or operator's demonstrated value for in-service deterioration in cruise fuel mileage)

(iii) Critical Fuel Scenario

The following describes a scenario for a diversion at the most critical point. The applicant should confirm the scenario to be used when calculating the critical fuel reserve necessary. It is operationally the most critical when considering both time and aeroplane configuration (e.g., two-engine versus one-engine at 3048 m (10 000 feet) non-standard aeroplane configuration not shown to be Extremely Improbable, paragraph 8.c.(2)(ii)(D)):

- (A) At the critical point, consider simultaneous failure of one propulsion system and the pressurisation system (critical point based on time to a suitable alternate at the approved one-engine-inoperative cruise speed).
- (B) Immediate descent to and continued cruise at 3048 m (10 000 feet) at the relevant one-engine-inoperative cruise speed or continued cruise above 3048 m (10 000 feet) if the aeroplane is equipped with sufficient supplemental oxygen in accordance with the operational requirements.
- (C) Upon approaching the ETOPS en-route alternate, descent to 457 m (1 500 feet) above destination, hold for 15 minutes, initiate an approach followed by a missed approach and then execute a normal approach and landing.

(5) Alternate Aerodromes

An aeroplane should not depart on an extended range operation unless the required take-off, destination and alternate aerodromes, including suitable en-route alternate aerodromes, to be used in the event of propulsion system failure or aeroplane system failure(s) which require a diversion, are listed in the cockpit documentation (e.g. computerised flight plan). Suitable en-route alternates should also be identified and listed in operational flight plan for all cases where the planned route of flight contains a point more than one hour flying time at the one-engine-inoperative speed from an adequate aerodrome. Since these suitable en-route alternates serve a different purpose than the destination alternate aerodrome and would normally be used only in the event of an engine failure or the loss of primary aeroplane systems, an aerodrome should not be listed as a suitable en-route alternate unless:

CS-20-6

(i) The landing distances required as specified in the AFM for the altitude of the aerodrome, for the runway expected to be used, taking into account wind conditions, runway surface conditions, and aeroplane handling characteristics, permit the aeroplane to be stopped within the landing distance available as declared by the aerodrome authorities and computed in accordance with the operational requirements.

(ii) The aerodrome services and facilities are adequate to permit the conduct of an instrument approach procedure to the runway expected to be used while complying with the applicable aerodrome operating minima.

(iii) The latest available forecast weather conditions for a period commencing one hour before the established earliest time of landing and ending one hour after the established latest time of landing at that aerodrome, equals or exceeds the authorised weather minima for en-route alternate aerodromes in Appendix 3. In addition, for the same period, the forecast crosswind component, including gusts, for the landing runway expected to be used should not exceed the maximum permitted crosswind for single engine landing taking into account the runway condition (dry, wet or contaminated).

(iv) During the course of the flight, the flight crew are to continue to remain informed of any significant changes in conditions at designated en-route alternates. Prior to proceeding beyond the extended range entry point, the forecast weather for the time periods established in paragraph 10.d.(5)(iii), aeroplane status, fuel remaining, runway surface conditions, landing distances and aerodrome services and facilities at designated en-route alternates should be evaluated. If any conditions are identified (such as weather forecast below landing minima) which would preclude safe approach and landing, then the pilot should take an appropriate course of action.

(v) In addition, the operator's programme should provide flight crews with information on adequate aerodromes appropriate to the route to be flown which are not forecast to meet Appendix 3 en-route alternate weather minima. Aerodrome facility information and other appropriate planning data concerning these aerodromes should be provided to flight crews for use when executing a diversion.

Note: The alternate aerodromes should be chosen in order to make it possible for the aeroplane to reach the alternate while complying with the requirements, especially with regard to performance (flight over obstacles) and/or oxygen considerations.

(6) *Aeroplane Performance Data*

No aeroplane should be released on an extended range flight unless the operator's Operations Manual contains sufficient data to support the critical fuel reserve and area of operations calculation. The following data should be based on Agency/Authority-approved information (see paragraph 8.d.(3)) provided or referenced in the Aeroplane Flight Manual (AFM).

(i) Detailed one-engine-inoperative performance data including fuel flow for standard and non-standard atmospheric conditions and as a function of airspeed and power setting, where appropriate, covering:

- (A) driftdown (includes net performance);
- (B) cruise altitude coverage including 3048 m (10 000 feet);
- (C) holding;
- (D) altitude capability (includes net performance); and
- (E) missed approach.

(ii) Detailed all-engine-operating performance data, including nominal fuel flow data, for standard and non-standard atmospheric conditions and as a function of airspeed and power setting, where appropriate, covering:

- (A) Cruise (altitude coverage including 3048 m (10 000 feet)); and
- (B) Holding.

(iii) Details of any other conditions relevant to extended range operation which can cause significant deterioration of performance, such as ice accumulation on the unprotected surfaces of the aeroplane, Ram Air Turbine (RAT) deployment, thrust reverser deployment, etc.

(iv) The altitudes, airspeeds, thrust settings, and fuel flow used in establishing the ETOPS area of operations for each airframe-engine combination must be used in showing the corresponding terrain and obstruction clearances in accordance with the operational requirements.

e. *Flight Crew Training, Evaluation, and Operating Manuals*

(1) Adequacy of Flight Crew Training and Operating Manuals

The Authority will review in-service experience of significant aeroplane systems. The review will include system reliability levels and individual event circumstances, including crew actions taken in response to equipment failures or unavailabilities. The aviation industry should provide information for and participate in these reviews. The Authority will use the information resulting from these reviews to modify or update flight crew training programmes, operating manuals and checklists, as necessary.

(2) Flight Crew Training and Evaluation Programme

The operator's training programme in respect to extended range operations should provide training for flight crew members followed by subsequent evaluations and proficiency checks as well as refresher training in the following areas:

- (i) Introduction to ETOPS regulations
- (ii) Routes and aerodromes intended to be used in the ETOPS area of operations
- (iii) Performance:
 - (A) Flight planning, including all contingencies.
 - (B) Flight performance progress monitoring.
- (iv) Procedures:
 - (A) Diversion Procedures and Diversion 'Decision making'. Special initial and recurrent training to prepare flight crews to evaluate probable propulsion and airframe systems failures should be conducted. The goal of this training should be to establish crew competency in dealing with the most probable operating contingencies.
 - (B) Use of appropriate navigation and communication systems, including appropriate flight management devices.
 - (C) The flight crew should be provided with detailed initial and recurrent training which emphasises abnormal and emergency procedures to be followed in the event of foreseeable failures for each area of operation, including:
 - (1) Procedures for single and multiple failures in flight that would precipitate go/no-go and diversion decisions. If standby sources of electrical power significantly degrade cockpit instrumentation to the pilots, then approved training which simulates approach with the standby generator as the sole power source should be conducted during initial and recurrent training.
 - (2) Operational restrictions associated with these failures including any applicable Minimum Equipment List (MEL) considerations.
 - (3) Procedures for air start of the propulsion systems, including the APU, if required.
 - (4) Crew incapacitation
 - (D) Use of emergency equipment including protective breathing and ditching equipment.
 - (E) Procedures to be followed in the event that there is a change in conditions at designated en-route alternates which would preclude safe approach and landing.
 - (F) Understanding and effective use of approved additional or modified equipment required for extended range operations.
 - (G) Fuel Management

Flight crew should be trained on the fuel management procedures to be followed during the en-route portion of the flight. These procedures should provide for an independent cross-check of fuel quantity

CS-20-6

indicators. For example fuel flows could be used to calculate fuel burned and compared to indicated fuel remaining.

(H) Operators should develop and incorporate annual ETOPS refresher training programmes for flight crew qualified for ETOPS operations.

(3) *ETOPS Check Programme*

The objective of the ETOPS check programme should be to ensure standardised flight crew practices and procedures and also to emphasise the special nature of ETOPS operations. Only pilots with a demonstrated understanding of the unique requirements of ETOPS should be designated as check pilots for ETOPS.

f. *Operational Limitations*

(1) *Area of Operation*

(i) An operator may be authorised to conduct extended range operations within an area where the diversion time, at any point along the proposed route of flight to an adequate aerodrome, is up to a maximum of 180 minutes in still air at the approved one-engine-inoperative cruise speed. Appendices 1 and 4 provide criteria for such operations.

(ii) In the case of operations cleared up to 120 minutes maximum diversion time, small increases in the diversion time for specific routes may be approved as needed, if it can be shown that the resulting routing will provide an enhancement of overall safety.

Such increases:

(A) Will require the Authority to assess overall type design including time limited systems, demonstrated reliability;

and

(B) to establish an appropriate MEL related to the diversion time required;

and

(C) Will not be more than 15 per cent of the original maximum diversion time approved in accordance with paragraph 10.f.

The area which meets the considerations in paragraph 8.f.(1)(i) may be approved for extended range operations with two-engine aeroplanes and should be specified in the operator certificate issued by the appropriate Authority.

(2) *Flight Release Limitation*

The flight release limitation should specify the maximum diversion time from a suitable aerodrome for which an operator can conduct a particular extended range operation. The maximum diversion time at the approved one-engine-inoperative cruise speed (under standard conditions in still air) should not be any greater than the value established by paragraph 10.f.(1)(i).

(i) *Use of Maximum Diversion Time*

The procedures established by the operator should ensure that extended range operation is limited to flight plan routes where the approved maximum diversion time to suitable aerodromes can be met under standard conditions in still air. Operators should provide for:

(A) Company procedures to state that upon occurrence of an in-flight shutdown of an engine, the pilot should promptly initiate diversion to fly to and land at the nearest aerodrome, in terms of time, determined to be suitable by the flight crew.

(B) A practice to be established such that in the event of a single or multiple primary system failure, the pilot will initiate the diversion procedure to fly to and land at the nearest aerodrome in terms of time, determined to be suitable by the flight crew, unless it has been justified that no substantial degradation of safety results from continuation of the planned flight.

(3) Contingency procedures should not be interpreted in any way which prejudices the final authority and responsibility of the pilot in command for the safe operation of the aeroplane.

g. *ETOPS Operational Approval Issued by the Appropriate Authority*

(1) An operator's two-engine aeroplane should not be operated on an extended range flight unless authorised by the operator certificate issued by the appropriate Authority (both maintenance and operations).

(2) The operator certificate issued by the appropriate Authority for extended range operations should specifically include provisions covering at least the following:

(i) Definition of the particular airframe-engine combinations, including the current approved CMP standard required for extended range operation as normally identified in the AFM (Paragraph 8.f.);

(ii) authorised area of operation;

(iii) minimum altitudes to be flown along planned and diversionary routes;

(iv) the maximum diversion time, at the approved one-engine-inoperative cruise speed (under standard conditions in still air), that at any point on the route the aeroplane may be from a suitable aerodrome for landing;

(v) aerodromes nominated for use, including alternates, and associated instrument approaches and operating minima;

(vi) the approved maintenance and reliability programme (Appendix 4) for extended range operation including those items specified in the type design approved CMP standard;

(vii) identification of those aeroplanes designated for extended range operation by make and model as well as serial number and registration;

(viii) aeroplane performance reference.

h. *Validation of Operator ETOPS Maintenance and Operations Capability*

(1) The operator should demonstrate that it has the competence and capability to conduct safely and support adequately the intended operation.

(2) Prior to being granted ETOPS operational approval, the operator should demonstrate that the ETOPS maintenance checks, servicing, and programmes called for in Appendix 4 are being properly conducted at representative departure and destination aerodromes.

(3) The operator should also demonstrate that ETOPS flight release practices, policies, and procedures are established for operations to and from representative departure and destination aerodromes.

(4) The operator should also demonstrate to the Authority, using the specified airframe-engine combination or preferably by use of an approved simulator, that he has the competence and capability to safely conduct and adequately support the intended operation. The following emergency conditions should be demonstrated during the validation flight unless successful demonstration of these conditions have previously been carried out in an approved simulator:

(i) total loss of thrust of one engine, (simulated, in the aeroplane, by setting zero thrust on the simulated failed engine);

(ii) total loss of normal generated electrical power;

(iii) any other condition considered to be equivalent in airworthiness, crew work-load or performance risk.

i. *Extended Range Operations Approval*

Following a type design approval for extended range operations in accordance with paragraph 8 and satisfactory application of the criteria in paragraphs 9 and 10 and prior to the issuance by the appropriate Authority of the ETOPS approval, the operator's application and supporting data should be forwarded to the appropriate Authority for review and concurrence. Following the review and

CS-20-6

concurrency by the appropriate Authority, the operational validation flight should be conducted in accordance with any additional guidance specified in the review and concurrence. When the operational validation flight has been evaluated and found acceptable, an applicant may be authorised to conduct extended range operation with the specified airframe-engine combination. Approval to conduct ETOPS is made by the issuance of the operator certificate by the appropriate Authority containing appropriate limitations.

j. *Criteria for Operations above 120 minutes and up to 180 minutes*

Each operator requesting Approval to conduct extended range operations beyond 120 minutes should have approximately 12 consecutive months of operational in-service experience with the specified ETOPS configured airframe-engine combination in the conduct of 120 minute operations. The amount of service experience may be increased or decreased after a review of operator's experience taking into account all factors including the number of sectors. Prior to approval, the operator's capability to conduct operations and implement effective ETOPS programmes in accordance with the criteria detailed in paragraph 10 will be examined. The record of the operator in conducting its 120 minute programme will be considered when granting Approvals beyond 120 minutes diversion time. These operators should also demonstrate the additional capabilities discussed in this paragraph. Approval will be given on a case-by-case basis for an increase to their area of operation beyond 120 minutes. The area of operation will be defined by a maximum diversion time of 180 minutes to an adequate aerodrome at approved one-engine-inoperative cruise speed (under standard conditions in still air). The release limitation will be a maximum diversion time of 180 minutes to a suitable aerodrome at the approved one-engine-inoperative speed (under standard conditions in still air).

(1) *Release Considerations*

(i) Minimum Equipment List (MEL)

The MEL should reflect adequate levels of primary system redundancy to support 180 minutes (still air) operations. The systems listed in paragraph 10.d.(2)(i) through (xvi) should be considered.

(ii) Weather

An operator should substantiate that the weather information system which it utilises can be relied upon to forecast terminal and en-route weather with a reasonable degree of accuracy and reliability in the proposed area of operation.

(iii) Fuel

The critical fuel scenario should also consider fuel required for all-engine-operations at 3048 m (10 000 feet) or above 3048 m (10 000 feet) if the aeroplane is equipped with sufficient supplemental oxygen.

(2) *Flight Planning*

The effects of wind and temperature at the one-engine-inoperative cruise altitude should be accounted for in the calculation of equal-time point. In addition, the operator's programme should provide flight crews with information on adequate aerodromes appropriate to the route to be flown which are not forecast to meet Appendix 3 en-route alternate weather minima. Aerodrome facility information and other appropriate planning data concerning these aerodromes should be provided to flight crews for use when executing a diversion.

(i) Crew Training and Evaluation

If standby sources of electrical power significantly degrade cockpit instrumentation to the pilots, then approved training, that simulates an instrument approach with the standby generator as the sole power source, should be conducted during initial and recurrent training.

(ii) Contingency Procedures

Flight crews should be provided with detailed initial and recurrent training, that emphasises established contingency procedures, for each area of operation intended to be used.

(iii) Diversion Decision Making

Special initial and recurrent training to prepare flight crews to evaluate probable propulsion and airframe systems failures should be conducted. The goal of this training should be to establish crew competency in dealing with the most probable operating contingencies.

Note: Although already required for maximum diversion time between 60 and 120 minutes under standard conditions in still air, the requirements of paragraph 10.j.(2) are emphasised for maximum diversion time beyond 120 minutes.

(iv) Specific instruction should be included in the company operational procedures so that paragraph 10.d.(5)(iv) is applied, with the additional proviso that an alternate should be selected that is within 180 minutes maximum diversion time, at the approved one-engine-inoperative speed (under standard conditions in still air).

(3) *Equipment*

(i) VHF/HF, Data Link where available

Operators should consider enhancements to their operational control system as soon as they become feasible.

(ii) Automated System Monitoring

The provision of automated aeroplane system status monitoring should be considered in order to enhance the flight crew's ability to make timely diversion decisions.

11 CONTINUING SURVEILLANCE

The fleet average In Flight Shut Down (IFSD) rate for the specified airframe-engine combination will continue to be monitored in accordance with Appendices 1 and 4. As with all other operations, the appropriate Authority should also monitor all aspects of the extended range operations that it has authorised to ensure that the levels of reliability achieved in extended range operations remain at the necessary levels as provided in Appendix 1, and that the operation continues to be conducted safely. In the event that an acceptable level of reliability is not maintained, if significant adverse trends exist, or if significant deficiencies are detected in the type design or the conduct of the ETOPS operation, then the appropriate Authority should initiate a special evaluation, impose operational restrictions, if necessary, and stipulate corrective action for the operator to adopt in order to resolve the problems in a timely manner. The appropriate Authority should alert the Certification Authority when a special evaluation is initiated and provide for their participation.

CS-20-6

INTENTIONALLY LEFT BLANK

APPENDIX 1 - PROPULSION SYSTEM RELIABILITY ASSESSMENT

ASSESSMENT PROCESS

To establish whether a particular airframe-engine combination has satisfied the propulsion systems reliability requirements for extended range operation, an assessment will be made by the Agency, using all pertinent propulsion system data. To accomplish the assessment, the Agency will need world fleet data, and data from various sources (the operator, the engine manufacturer and the aeroplane manufacturer) which should be extensive enough and of sufficient maturity to enable the Agency to assess with a high level of confidence, using engineering and operational judgement and standard statistical methods where appropriate, that the risk of total power loss from independent causes is sufficiently low. The Agency will state whether or not the current propulsion system reliability of a particular airframe-engine combination satisfies the relevant criteria. Included in the statement, if the operation is approved, will be the engine build standard, propulsion system configuration, operating condition and limitations required to qualify the propulsion system as suitable for extended range operation.

If an approved engine CMP is maintained by the responsible engine Authority and is duly referenced on the engine Type Certificate Data Sheet, then this must be made available to the Authority conducting the aeroplane propulsion system reliability assessment. Such a CMP must be produced taking into account all the requirements of paragraphs 8 and 9 and should be incorporated or referenced in the aeroplane CMP.

a. *Service Experience*

When considering the acceptability of a propulsion system for extended range operation, maturity should be assessed not only in terms of total fleet hours but also take account of fleet leader time over a calendar time but, also to the extent to which test data and design experience can be used as an alternative.

There are two extremes in the ETOPS process with respect to maturity; one is the demonstration of stable reliability by the accumulation of service experience and the other is by an agreed design and test program between the manufacturers and authorities. The extent to which a propulsion system is a derivative of previous ETOPS-rated systems is also a factor of the level of maturity.

There is justification for the view that modern propulsion systems achieve a stable reliability level by 100 000 hours for new types and 50 000 hours for derivatives. 3 000 to 4 000 hours is considered to be the necessary time in service for a specific unit to indicate problem areas.

Normally, the service experience will be:

(1) For new propulsion systems: 100 000 hours and 12 months service. Where experience on another aeroplane is applicable, a significant portion of the 100 000 hours should normally be obtained on the candidate aeroplane.

On a case-by-case basis, relevant test and design experience, and maximum diversion time requested, could be taken into account when arriving at the in-service experience required.

(2) For derivative propulsion systems: 50 000 hours and 12 months service. These values may vary according to the degree of commonality. To this end in determining the derivative status of a propulsion system, consideration should be given to technical criteria referring to the commonality with previous ETOPS-rated engines. Prime areas of concern include:

- (i) Turbomachinery
- (ii) Controls and accessories and control logic
- (iii) Configuration hardware (piping, cables etc.)
- (iv) Aircraft to engine interfaces and interaction
- (A) Fire
- (B) Thrust reverser
- (C) Avionics

CS-20-6

(D) etc.

The extent to which the in-service experience might be reduced would depend upon the degree of commonality with previous ETOPS-rated engines using the above criteria, and would be decided on a case-by-case basis.

Also on a case-by-case basis, relevant test and design experience and maximum diversion time requested, could be taken into account when arriving at the in-service experience required.

Thus, the required experience to demonstrate propulsion system reliability should be determined by

- (i) The extent to which previous service experience of common ETOPS-rated propulsion systems can be considered.
- (ii) To what extent compensating factors such as design similarity and test evidence can be used.
- (iii) The two preceding considerations would then determine the amount of service experience needed for a particular propulsion system proposed for ETOPS.

These considerations would be made on a case-by-case basis and would need to provide a demonstrated level of propulsion system reliability in terms of in flight shut down IFSD rate of the order of 0.05 per 1 000 hours, as is necessary also for new propulsion systems.

b. *Data Required for the Assessment*

(1) A list of all engine shutdown events, both ground and inflight, for all causes (excluding normal training events) including flameout. The list should provide the following for each event:

- (i) date;
- (ii) airline;
- (iii) aeroplane and engine identification (model and serial number);
- (iv) power-unit configuration and modification history;
- (v) engine position;
- (vi) symptoms leading up to the event, phase of flight or ground operation;
- (vii) weather/environmental conditions and reason for shutdown and any comment regarding engine restart potential.

(2) All occurrences where the intended thrust level was not achieved, or where crew action was taken to reduce thrust below the normal level, for whatever reason:

- (3) Unscheduled engine removals/shop visit rates;
- (4) Total engine hours and aeroplane cycles;
- (5) All events should be considered to determine their effects on ETOPS operations;
- (6) Additional data as required.
- (7) The Agency will also consider relevant design and test data.

c. *Risk Management and Risk Model*

Propulsion systems approved for extended range operation must be sufficiently reliable to assure that defined safety targets are achieved.

A review of information for modern fixed wing jet powered aircraft shows that the rate of fatal accidents for all causes is in the order of 0.3×10^{-6} per flying hour. The reliability of aeroplane types approved for extended range operation should be such that they achieve at least as good an accident record as equivalent technology equipment. The overall target of 0.3×10^{-6} per flying hour has therefore been chosen as the all-causes safety target.

When considering safety targets, an accepted practice is to allocate appropriate portions of the total to the various potential contributing factors. By applying this practice to the overall target of 0.3×10^{-6} per flying hour, in the proportions previously considered appropriate, the probability of a catastrophic

accident due to complete loss of thrust from independent causes must be no worse than 0.3×10^{-8} per flying hour.

Propulsion system related accidents may result from independent cause events but, based on historical evidence, result primarily from events such as uncontained engine failure events, common cause events, engine failure plus crew error events, human error related events and other. The majority of these factors are not specifically exclusive to ETOPS.

Using an expression developed by ICAO, (ref. AN-WP/5593 dated 15/2/84) for the calculation of engine in-flight shutdown rate, together with the above safety objective and accident statistics, a relationship between target engine in-flight shutdown rate for all independent causes and maximum diversion time has been derived. This is shown in Figure 1.

In order that type design approval may be granted for extended operation range, it will be necessary to satisfy the Agency that after application of the corrective actions identified during the engineering assessment (see Appendix 1, paragraph 1.d.), the target engine in-flight shutdown rates will be achieved. This will provide assurance that the probability objective for loss of all thrust due to independent causes will be met.

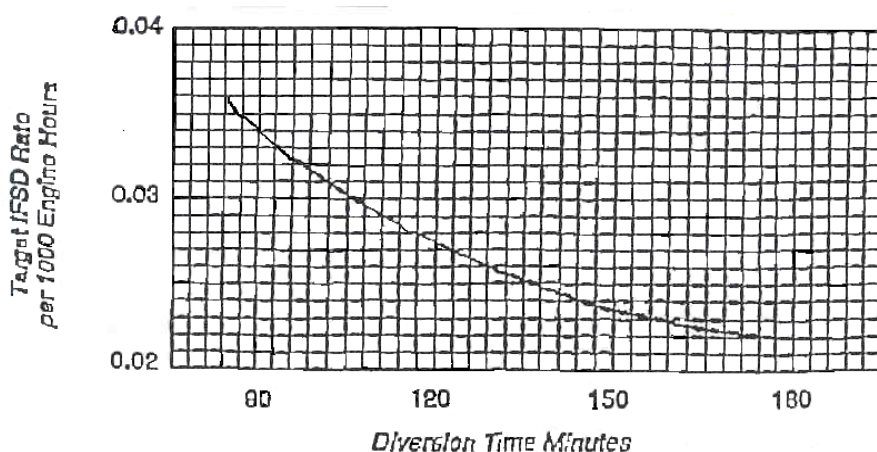

Figure 1: Target IFSD Rate versus Diversion Time

d. *Engineering Assessment*

(1) There are maintenance programmes, engine on-wing health monitoring programmes, and the promptness and completeness in incorporating engine service bulletins, etc., that influence an operator's ability to maintain a level of reliability. The data and information required will form a basis from which a world-fleet engine shutdown rate will be established for use in determining whether a particular airframe-engine combination complies with criteria for extended range operation.

(2) An analysis will be made on a case-by-case basis, of all significant failures, defects and malfunctions experienced in service (or during testing) for the particular airframe-engine combination. Significant failures are principally those causing or resulting in in-flight shutdown or flameout of the engine(s), but may also include unusual ground failures and/or unscheduled removal of engines. In making the assessment, consideration will be given to the following:

- (i) The type of propulsion system, previous experience, whether the power-unit is new or a derivative of an existing model, and the operating thrust level to be used after one engine shutdown.
- (ii) The trends in the cumulative twelve month rolling average, updated quarterly, of in-flight shutdown rates versus propulsion system flight hours and cycles.
- (iii) The demonstrated effect of corrective modifications, maintenance, etc. on the possible future reliability of the propulsion system.
- (iv) Maintenance actions recommended and performance and their effect on propulsion system and APU failure rates.

CS-20-6

(v) The accumulation of operational experience which covers the range of environmental conditions likely to be encountered.

(vi) Intended maximum flight duration, and maximum diversion in the ETOPS segment, used in the extended range operation under consideration.

(3) Engineering judgement will be used in the analysis of paragraph 1.d.(2) such that the potential improvement in reliability, following the introduction of corrective actions identified during the analysis, can be quantified.

(4) The resultant predicted reliability level and the criteria developed in accordance with paragraph 1.c will together be used to determine the maximum diversion time for which the particular airframe-engine combination qualifies.

(5) The type design standard for type approval of the airframe-engine combination for extended range operations will include all modifications and maintenance actions for which full or partial credit is taken in paragraph 1.d.(3) and other such actions required by the Agency to enhance reliability. The schedule for incorporation of type design standard items should normally be established in the Configuration Maintenance Procedures (CMP) for example in terms of calendar time, hours or cycles.

(6) When a foreign manufacturer's and/or operator's data are evaluated, the respective foreign Airworthiness Authority will be offered the opportunity to participate in the assessment.

(7) Propulsion System Reliability Assessment Board (PSRAB) Findings. Once an assessment has been completed and the PSRAB has documented its findings, the Agency will declare whether or not the particular combination satisfies the relevant considerations of this AMC. Items recommended to qualify the propulsion system, such as maintenance requirements and limitations will be included in the Assessment Report (paragraph 8.e.).

(8) In order to establish that the predicted propulsion system reliability level is achieved, and subsequently maintained, the aircraft manufacturer should submit to the Agency an assessment of the reliability of the propulsion system on a quarterly basis. The assessment should concentrate on the ETOPS configured fleet and should include ETOPS related events from the non-configured fleet of the subject airframe-engine combination, and from other combinations utilising a related engine model.

e. *Continuing Airworthiness*

The Agency will periodically review its original findings. In addition, the Agency document containing the CMP standard will be revised as necessary.

The periodic meetings of the ETOPS Reliability Tracking Board prescribed in this AMC are normally frequent at the start of the assessment of a new product, the periodicity is adjusted by the Agency upon accumulation of substantial service experience if there is evidence that the reliability of the product is sufficiently stable. The periodic meetings of the board are discontinued once an ETOPS product or family of products has been declared mature by the Agency.

(1) *Mature ETOPS products*

A family of ETOPS products with a high degree of similarity is considered as mature once:

(i) The product family has accumulated at least 250 000 flight hours for an aircraft family or 500 000 operating hours for an engine family;

(ii) The product family has accumulated service experience covering a comprehensive spectrum of operating conditions (e.g. cold, hot, humid,..);

(iii) Each ETOPS approved model or variant in the family has achieved the reliability objectives for ETOPS and has remained stable at or below the objectives fleet-wide for at least two years;

New models or significant design changes may not be considered mature until they have individually satisfied the condition of paragraph (i) here-before.

The Reliability Tracking Board Chairman and the Project Certification Manager make the determination of when a product or a product family is considered mature.

(2) *Surveillance of mature ETOPS products*

The Manufacturer of an ETOPS product which the Agency has found mature should institute a process to monitor the reliability of the product in accordance with the objectives defined in Appendix 1 and 2 of this AMC. In case of occurrence of an event or a series of events or a statistical trend that implies a deviation of the reliability of the ETOPS fleet or a portion of the ETOPS fleet (e.g. one model or a range of serial numbers) above the limits specified for ETOPS in this AMC, the Manufacturer must:

- (i) Inform the Agency and define a means to restore the reliability through a Minor Revision of the CMP, with a compliance schedule to be agreed with the Agency if the situation has no immediate safety impact;
- (ii) Inform the Agency and propose an ad-hoc follow-up by the Agency until the concern has been alleviated or confirmed if the situation requires further assessment;
- (iii) Inform the Agency and propose the necessary corrective action(s) to be mandated by the Agency through an AD if a direct safety concern exists.

In the absence of a specific event or trend requiring action, the Manufacturer must provide the Agency with the basic statistical indicators prescribed in Appendix 1 and 2 of this AMC on a yearly basis.

(3) *Design Organisation Approval*

Manufacturers of products approved for ETOPS must hold a Design Organisation Approval (DOA) conforming to IR 21. Their approved Design Organisation Manual (DOM) must contain appropriate organisation and procedures covering the tasks and responsibilities of this AMC.

Foreign manufacturers not approved as JAA-DOA must present an equivalent organisation and procedures that satisfies the intent of this paragraph. FAA DER system is considered acceptable.

(4) *Minor Revision of the ETOPS CMP Document*

A Minor Revision of the ETOPS CMP document is one that contains only editorial adjustments, configurations, maintenance and procedures equivalent to those already approved by the Agency or new reliability improvements which have no immediate impact on the safety of ETOPS flights and are introduced as a means to control the continued compliance with the reliability objectives of ETOPS.

Minor revisions of the ETOPS CMP Document may be approved by designated personnel of the Manufacturer under the provisions of its approved DOM.

Foreign manufacturers not approved as JAA-DOA who operate under the FAA DER system may use their DER to approve Minor Revisions of the CMP.

CS-20-6

INTENTIONALLY LEFT BLANK

APPENDIX 2 - AIRCRAFT SYSTEMS RELIABILITY ASSESSMENT

ASSESSMENT PROCESS

The intent of this Appendix is to provide additional clarification to paragraphs 8b, 8c,(1) and 7.f.(4). Airframe systems are required to show compliance with CS 25.1309. To establish whether a particular airframe-engine combination has satisfied the reliability requirements concerning the aircraft systems for extended range operations an assessment will be made by the Agency, using all pertinent systems data provided by the applicant. To accomplish this assessment the Agency will need world fleet data, and data from various sources (the operators, the equipment manufacturers, and the aeroplane manufacturer). This data should be extensive enough and of sufficient maturity to enable the Agency to assess with a high level of confidence, that the risk of systems failures during a normal ETOPS flight or a diversion, is sufficiently low in direct relationship with the consequence of such failure conditions, under the operational environment of ETOPS missions.

The Agency will declare whether or not the current system reliability of a particular airframe-engine combination satisfies the relevant criteria.

Included in the declaration will be the airframe build standard, systems configuration, operating conditions and limitations required to qualify the ETOPS significant systems as suitable for extended range operations.

a. *ETOPS Significant Systems*

(1) An ETOPS significant system is:

(i) A system for which the fail-safe redundancy characteristics are directly linked to the number of engines, e.g. hydraulic system, pneumatic system, electrical system.

(ii) A system that may affect the proper functioning of the engines to the extent that it could result in an inflight shutdown or uncommanded loss of thrust, e.g. fuel system, thrust reverser or engine control or indicating system, engine fire detection system.

(iii) A system which contributes significantly to the safety of flight and a diversion with one engine inoperative, such as back-up systems used in case of additional failure during the diversion. These include back-up or emergency generator, APU or systems essential for maintaining the ability to cope with prolonged operation at single engine altitudes, such as anti-icing systems.

(iv) A system for which certain failure conditions may reduce the safety of a diversion, e.g. navigation, communication, equipment cooling, time limited cargo fire suppression, oxygen system.

(2) The list of ETOPS significant systems should be agreed with the Agency.

b. *Reliability Assessment for Systems*

The reliability assessment for systems must determine which systems are significant to ETOPS and assure that the reliability of such systems is sufficient in direct relationship with the consequences of their potential malfunctions during ETOPS missions.

The assessment also requires a review of the Systems Safety Assessment (SSA) established in compliance with AMC 25.1309-1 and specific ETOPS requirements in this AMC (e.g., loss of cabin pressurisation during Single Engine Operation), to take into account the particular conditions and requirements applicable to ETOPS missions.

In order to achieve the level of confidence intended for ETOPS, the analytical assessment in the SSA must be confirmed by statistical data from a sufficient data base of directly applicable service experience and by an engineering assessment of the service experience of the airframe systems under review.

Statistical indicators (MTBF/MTBUR) and engineering judgement applied to the individual events must be used to evaluate the maturity and the reliability of all ETOPS significant systems.

CS-20-6

c. *Analytical Assessment*

The SSA conducted in accordance with CS 25.1309 of all ETOPS significant systems must be reviewed as follows:

(1) Conduct a (supplemental) Functional Hazard Assessment (FHA) considering the ETOPS missions. In determining the effect of a failure condition during an ETOPS mission, the following should also be reviewed:

- (i) Crew workload over a prolonged period of time
- (ii) Operating conditions at single engine altitude
- (iii) Lesser crew familiarity with the procedures and conditions to fly to and land at diversion airfields.

(2) Introduce any additional failure scenario/objectives necessary to comply with this AMC.

(3) Consider maximum ETOPS flight duration and maximum ETOPS diversion time for all probability calculations. (The probability calculations for those systems that cannot affect the proper functioning of the engines or systems where fail safe/redundancy is not affected by the number of engines, but which could cause a diversion or contribute to the safety of a diversion, may be based on average fleet risk mission time for ETOPS operated aircraft, assuming a maximum diversion time.

(Note - not average risk mission time for whole fleet.)

(4) Consider effects of prolonged time and single engine altitude in terms of continued operation of remaining systems following failures.

(5) Specific ETOPS maintenance tasks and/or intervals or specific ETOPS flight procedures necessary to attain the safety objectives must be included in the appropriate approved document (e.g. CMP document, MMEL).

d. *Service Experience/Systems Safety Assessment (SSA)*

When considering the acceptability of airframe systems for extended range operations, maturity should be assessed in terms of the maturity of the technology being used and the maturity of the particular design under review.

In performing the SSA's particular account will be taken of the following:

(1) For equipment identical or close to equipment used on other aircraft, the SSA failure rates will be validated by in-service experience.

The amount of service experience (either direct or related) must be indicated for each equipment of an ETOPS significant system.

Where related service experience is used to validate failure modes and rates, an analysis must be produced to show the validity of the service experience.

In particular, if the same equipment is used on a different aircraft type, it must be shown that there is no difference in operating conditions (vibrations, pressure, temperature) or that these differences do not adversely affect the failure modes and rates.

If service experience on similar equipment on other aircraft is claimed to be applicable an analysis must be produced substantiating the reliability figures used on the quantitative analysis. This substantiation analysis should include details of the differences between the similar and new equipment, details of the service experience of the similar equipment and details of any "lessons learnt" modifications introduced and included in the new equipment.

For certain equipment, (e.g., IDGs, TRUs, bleeds, emergency generator) this analysis may have to be backed up by tests. This must be agreed with the Agency.

(2) For new or substantially modified equipment, account will be taken in the SSA for the lack of validation of the failure rates by service experience.

A study should be conducted to determine the sensitivity of the assumed SSA failure condition probabilities to the failure rates of that equipment.

Should a failure case probability be sensitive to this equipment failure rate and close to the required safety objective, particular provision precautions may be applied (e.g. temporary despatch restrictions, inspections, maintenance procedures, crew procedures ...) to account for the uncertainty until the failure rate has been appropriately validated by service experience.

(3) In order to confirm that the predicted system reliability level is achieved and maintained, the aircraft manufacturer should monitor the reliability of airframe (ETOPS significant) systems after entry into service. The manufacturer should submit a report to the Agency initially on a quarterly basis (for the first year of operation) and thereafter on a periodic basis and for a time to be agreed with the Agency (see 7.f.(4) and 8.g.(3)). The monitoring task should include ETOPS significant events from both the ETOPS and non-ETOPS fleet of the subject family of airframes. This additional reliability monitoring is required only for those systems that could effect the proper functioning of the engines or systems where the fail-safe/redundancy is affected by the number of engines and back-up systems used in the case of additional failure during the diversion.

Note: See also Appendix 1 paragraph e Continuing Airworthiness for aircraft systems.

CS-20-6

INTENTIONALLY LEFT BLANK

APPENDIX 3 - SUITABLE EN-ROUTE ALTERNATE AERODROMES

1 GENERAL

a. One of the distinguishing features of two-engine extended range operations is the concept of a suitable en-route alternate aerodrome being available to which an aeroplane can divert after a single failure or failure combinations which require a diversion. Whereas most two-engine aeroplanes operate in an environment where there is usually a choice of diversion aerodromes available, the extended range aeroplane may have only one alternate within a range dictated by the endurance of a particular airframe system (e.g., cargo fire suppressant), or by the approved maximum diversion time for that route.

b. It is, therefore, important that any aerodrome designated as an en-route alternate has the capabilities, services and facilities to support safely that particular aeroplane, and that the weather conditions at the time of arrival provide a high assurance that adequate visual references are available upon arrival at decision height (DH) or minimum descent altitude (MDA), and that the surface conditions are within acceptable limits to permit the approach and landing to be completed safely with one propulsion system and/or airframe systems inoperative.

c. As well as satisfying the ICAO Annex 6 requirements in relation to crew qualification for operations on such routes, operators should show that these facilities and services specified are available for the proposed operations.

2 SUITABLE AERODROME SELECTION

For an aerodrome to be suitable for the purpose of this AMC, it should have the capabilities, services, a minimum of ICAO category 4, or the relevant aeroplane category if lower, Rescue and Fire Fighting Services (RFFS) and facilities necessary to designate it as an adequate aerodrome, (for RFFS not located on the aerodrome; capability of meeting the aeroplane within 30 minutes notice) and have weather and field conditions at the time of that particular operation which provide a high assurance that an approach and landing can be safely completed with one propulsion system and/or airframe systems inoperative, in the event that a diversion to the en-route alternate becomes necessary. Due to the natural variability of weather conditions with time, as well as the need to determine the suitability of a particular en-route aerodrome prior to departure, the en-route alternate weather minima for planning purposes are generally higher than the weather minima necessary to initiate an instrument approach. This is necessary to assure that the instrument approach can be conducted safely if the flight has to divert to the alternate aerodrome. Additionally, since the visual reference necessary to safely complete an approach and landing is determined, among other things, by the accuracy with which the aeroplane can be controlled along the approach path by reference to instrument aids, as well as by the tasks the pilot is required to accomplish to manoeuvre the aeroplane so as to complete the landing, the weather minima for non-precision approaches are generally higher than for precision approaches.

3 STANDARD EN-ROUTE ALTERNATE AERODROME PRE-DEPARTURE WEATHER MINIMA

The following are established for flight planning and release purposes with two-engine aeroplanes in extended range operations.

A particular aerodrome may be considered a suitable aerodrome for flight planning and release purposes for extended range operation if it meets the criteria of paragraph 3 of this Appendix and has one of the following combinations of instrument approach capabilities and en-route alternate aerodrome weather minima at the time of the particular operation. An operator should include in his Operations Manual either Table 1 or Table 2, but not a combination of both, for use in determining the operating minima at the planned en-route alternate aerodrome.

CS-20-6

Table 1 Planning minima - ETOPS

Approach Facility Configuration	Alternate Airfield Ceiling	Weather Minima Visibility/RVR
For aerodromes with at least one operational navigation facility, providing a precision or non-precision runway approach procedure or a circling manoeuvre from an instrument approach procedure	A ceiling derived by adding 122 m (400 feet) to the authorised DH, MDH (DA/MDA) or circling minima	A visibility derived by adding 1 500 meters to the authorised landing minima.
The weather minima below apply at aerodromes which are equipped with precision or non-precision approaches on at least two separate runways (two separate landing surfaces)		
For aerodromes with at least two operational navigation facilities providing a precision or non-precision runway approach procedure to separate suitable runways	A ceiling derived by adding 61 m (200 feet) to the higher of the authorised DH/MDH (DA/MDA) for the approaches	A visibility derived by adding 800 meters to the higher of the two authorised landing minima

Table 2 Planning minima – ETOPS

Type of Approach	Planning Minima (RVR visibility required & ceiling if applicable)		
	Aerodrome with		
	at least 2 separate approach procedures based on 2 separate aids serving 2 separate runways	at least 2 separate approach procedures based on 2 separate aids serving 1 runway	or at least 1 approach procedure based on 1 aid serving 1 runway
Precision Approach Cat II, III (ILS, MLS)	Precision Approach Cat I Minima	Non-Precision Approach Minima	
Precision Approach Cat I (ILS, MLS)	Non-Precision Approach Minima	Circling minima or, if not available, non-precision approach minima plus 200 ft / 1 000 m	
Non-Precision Approach	The lower of non-precision approach minima plus 200 ft / 1 000 m or circling minima	The higher of circling minima or non-precision approach minima plus 200 ft / 1 000 m	
Circling Approach	Circling minima		

4 EN-ROUTE ALTERNATE AERODROME PRE-DEPARTURE WEATHER MINIMA TAKING ADVANTAGE OF ADVANCED LANDING SYSTEMS

It is recognised that the development of advanced landing systems may lead to certified capability for planned single engine Category II and/or Category III approach and landings.

Before advantage of any such capability can be used in the pre-flight selection of an en-route alternate aerodrome the appropriate Authority must be satisfied that the operator has demonstrated that when an ETOPS aircraft has encountered any failure condition in the airframe and/or propulsion system that would result in a diversion to an en-route alternate aerodrome, subsequent failures during the diversion, that would result in the loss of the capability to safely conduct and complete the Category II/III approach and landing are Improbable. The certificated capability of the airframe-engine combination should be evaluated considering the approved maximum diversion time.

Approval of the planned use of these advanced systems to nominate en-route alternate aerodromes will be on a case-by-case basis and will use the table of paragraph 4 of this Appendix.

5 EN-ROUTE ALTERNATE SUITABILITY IN FLIGHT

See paragraphs 10.d.(5)(iv) and 10.j.(2)(iv).

CS-20-6

INTENTIONALLY LEFT BLANK

APPENDIX 4 - ETOPS MAINTENANCE REQUIREMENTS

1 GENERAL

The maintenance programme should contain the standards, guidance and direction necessary to support the intended operations. Maintenance personnel and other personnel involved should be made aware of the special nature of ETOPS and have the knowledge, skills and ability to accomplish the requirements of the programme.

2 ETOPS MAINTENANCE PROGRAMME

The basic maintenance programme for the aeroplane being considered for ETOPS is the continuous airworthiness maintenance schedule currently approved for that operator, for the make and model airframe-engine combination. This schedule should be reviewed to ensure that it provides an adequate basis for development of ETOPS maintenance requirements. These should include maintenance procedures to preclude identical action being applied to multiple similar elements in any ETOPS significant system (e.g., fuel control change on both engines).

- a. ETOPS related tasks should be identified on the operator's routine work forms and related instructions.
- b. ETOPS related procedures, such as involvement of centralised maintenance control, should be clearly defined in the operator's programme.
- c. An ETOPS service check should be developed to verify that the status of the aeroplane and certain critical items are acceptable. This check should be accomplished by an authorised and trained person prior to an ETOPS flight. Such a person may be a member of the flight crew.
- d. Log books should be reviewed and documented, as appropriate, to ensure proper MEL procedures, deferred items and maintenance checks, and that system verification procedures have been properly performed.

3 ETOPS MANUAL

The operator should develop a manual for use by personnel involved in ETOPS. This manual need not include, but should at least reference, the maintenance programme and other requirements described by this Appendix, and clearly indicate where they are located in the operator's manual system.

All ETOPS requirements, including supportive programmes, procedures, duties, and responsibilities, should be identified and be subject to revision control. This manual should be submitted to the Authority 30 days before implementation of ETOPS flights.

Alternatively, the operator may include this information in existing manuals used by personnel involved in ETOPS.

4 OIL CONSUMPTION PROGRAMME

The operator's oil consumption programme should reflect the manufacturer's recommendations and be sensitive to oil consumption trends. It should consider the amount of oil added at the departing ETOPS stations with reference to the running average consumption; i.e., the monitoring must be continuous up to, and including, oil added at the ETOPS departure station. If oil analysis is meaningful to this make and model, it should be included in the programme. If the APU is required for ETOPS operation, it should be added to the oil consumption programme.

5 ENGINE CONDITION MONITORING

This programme should describe the parameters to be monitored, method of data collection and corrective action process. The programme should reflect manufacturer's instructions and industry practice. This monitoring will be used to detect deterioration at an early stage to allow for corrective action before safe operation is affected. The programme should ensure that engine limit margins are maintained so that a prolonged single-engine diversion may be conducted without exceeding approved engine limits (i.e., rotor speeds, exhaust gas temperature) at all approved power levels and expected environmental conditions. Engine margins preserved through this programme should account for the

CS-20-6

effects of additional engine loading demands (e.g., anti-icing, electrical, etc.) which may be required during the single-engine flight phase associated with the diversion.

6 VERIFICATION PROGRAMME AFTER MAINTENANCE

The operator should develop a verification programme or procedures should be established to ensure corrective action following an engine shutdown, primary system failure or adverse trends or any prescribed events which require a verification flight or other action and establish means to assure their accomplishment. A clear description of who must initiate verification actions and the section or group responsible for the determination of what action is necessary should be identified in the programme. Primary systems or conditions requiring verification actions should be described in the operator's ETOPS manual.

7 RELIABILITY PROGRAMME

An ETOPS reliability programme should be developed or the existing reliability programme supplemented. This programme should be designed with early identification and prevention of ETOPS related problems as the primary goal. The programme should be event-orientated and incorporate reporting procedures for significant events detrimental to ETOPS flights. This information should be readily available for use by the operator and Authority to help establish that the reliability level is adequate, and to assess the operator's competence and capability to safely continue ETOPS. The Authority should be notified within 96 hours of events reportable through this programme.

a. In addition to the items required to be reported by other regulations, the following items should be included:

- (i) in-flight shutdowns;
- (ii) diversion or turnback;
- (iii) uncommanded power changes or surges;
- (iv) inability to control the engine or obtain desired power; and
- (v) problems with systems critical to ETOPS.

b. The report should identify the following:

- (i) aeroplane identification;
- (ii) engine identification (make and serial number);
- (iii) total time, cycles and time since last shop visit;
- (iv) for systems, time since overhaul or last inspection of the defective unit;
- (v) phase of flight; and
- (vi) corrective action.

8 PROPULSION SYSTEM MONITORING

The operator's assessment of propulsion systems reliability for the extended range fleet should be made available to the Authority (with the supporting data) on at least a monthly basis, to ensure that the approved maintenance programme continues to maintain a level of reliability necessary for extended range operation.

The assessment should include, as a minimum, engine hours flown in the period, in flight shut-down rate for all causes and engine removal rate, both on a 12 month moving average basis. Where the combined extended range fleet is part of a larger fleet of the same airframe-engine combination, data from the operator's total fleet will be acceptable. However, the reporting requirements of paragraph 7 of this Appendix must still be observed for the extended range fleet.

Any adverse sustained trend would require an immediate evaluation to be accomplished by the operator in consultation with the Authority. The evaluation may result in corrective action or operational restrictions being applied.

Note: Where statistical assessment alone may not be applicable, e.g., when the fleet size is small, the operator's performance will be reviewed on a case-by-case basis.

9 MAINTENANCE TRAINING

The Maintenance training should focus on the special nature of ETOPS. This programme should be included in the normal maintenance training. The goal of this programme is to ensure that all personnel involved in ETOPS are provided with the necessary training so that the ETOPS maintenance tasks are properly accomplished and to emphasise the special nature of ETOPS maintenance requirements. Qualified maintenance personnel are those that have completed the operator's extended range training programme and have satisfactorily performed extended range tasks under supervision, within the framework of the operator's approved procedures for Personnel Authorisation.

10 ETOPS PARTS CONTROL

The operator should develop a parts control programme with support from the manufacturer, that ensures the proper parts and configuration are maintained for ETOPS. The programme includes verification that parts placed on an ETOPS aeroplane during parts borrowing or pooling arrangements, as well as those parts used after repair or overhaul, maintain the necessary ETOPS configuration for that aeroplane.

INTENTIONALLY LEFT BLANK

APPENDIX 5 - 90 MINUTES OR LESS ETOPS OPERATIONAL PROGRAM CRITERIA

(Note: 180 min provisions are included in the main text)

1. GENERAL

Paragraphs 10.a. through 10.i. of this AMC detail the criteria for operational approval of extended range operations with a maximum diversion time between 60 and 120 minutes to an en route alternate (at approved single-engine inoperative cruise speed). This appendix serves the function of differentiating the criteria for approval of operations up to 90 minutes diversion time.

2. 90 - MINUTE OPERATION

Since 1976, two-engine aeroplane operations up to 90 minutes diversion time (two engine speed) were approved over Africa, the Indian Ocean, the Bay of Bengal and the North Atlantic using ICAO recommendations of the time and the applicable operational rule. The aeroplanes performing these missions were not designed to meet all the design and reliability criteria now in Paragraphs 8, 9 and Appendix 1&2 of this AMC and were not subjected to the operational approval criteria detailed in Paragraph 10, Appendices 3, 4 and 7 of this AMC. However, these operations have proven to be safe and successful due to the short duration of the concerned ETOPS sectors, the short diversion time, the favourable operating characteristics of the route and the built-in reliability of the initial product. This experience, along with the ETOPS operational experience gathered since 1985, has led to the development of the 90 minute criteria detailed below. This criteria bridges the gap between the 60 min, non-ETOPS, requirements and the current requirements defined in this AMC. It defines specifically what needs to be accomplished in order to obtain an operational approval with a maximum diversion time of 90 minutes or less.

3. CRITERIA FOR APPROVAL TO OPERATE UP TO 90 MINUTES**a. Type Design**

Compliance must be shown to all applicable paragraphs. Where relevant, specific 90 min, or less, criteria is denoted directly in the text of paragraphs 8 and Appendix 1.

b. Operational Approval

Consideration may be given to the approval of extended range operations up to 90-minutes for operators with minimal or no in-service experience with the airframe-engine combination. This determination considers such factors as the proposed area of operations, the operator's demonstrated ability to successfully introduce aeroplanes into operations, the quality of the proposed maintenance and operations programs.

(1) Maintenance

Maintenance programs should be instituted which follow the guidance in Appendix 4.

(2) Operations

(i) Operation programs should be instituted which follow the guidance in paragraphs 10.d., 10.e. and 10.f. and Appendix 3.

(ii) Minimum Equipment List (MEL): Provision of the JAA Master Minimum Equipment List (MMEL), including 90 minute or less "Extended Range" provisos.

CS-20-6

INTENTIONALLY LEFT BLANK

APPENDIX 6 - NOT USED

INTENTIONALLY LEFT BLANK

CS-20-6

INTENTIONALLY LEFT BLANK

APPENDIX 7 - REDUCTION OF OPERATOR'S IN-SERVICE EXPERIENCE REQUIREMENT PRIOR TO THE GRANTING OF AN ETOPS OPERATIONAL APPROVAL ('ACCELERATED ETOPS OPERATIONAL APPROVAL')**A General**

The purpose of this appendix is to establish the factors which the Authority may consider in exercising its authority to allow reduction or substitution of operator's in-service experience requirement in granting ETOPS Operational Approval.

Paragraph 7 of this AMC states that "...the concepts for evaluating extended range operations with two-engine aeroplanes....ensures that two-engine aeroplanes are consistent with the level of safety required for current extended range operations with three and four-engine turbine powered aeroplanes without unnecessarily restricting operation".

It is apparent that the excellent propulsion related safety record of two-engine aeroplanes has not only been maintained, but potentially enhanced, by the process related provisions associated with ETOPS Type Design and Operational Approvals. Further, currently available data shows that these process related benefits are achievable without extensive in-service experience. Therefore, reduction or elimination of in-service experience requirements may be possible when the operator shows to the Authority that adequate and validated ETOPS processes are in place.

The Accelerated ETOPS Operational Approval Programme with reduced in-service experience does not imply that any reduction of existing levels of safety should be tolerated but rather acknowledges that an operator may be able to satisfy the objectives of this AMC by a variety of means of demonstrating that operator's capability.

This Appendix permits an operator to start ETOPS operations when the operator has established that those processes necessary for successful ETOPS operations are in place and are considered to be reliable. This may be achieved by thorough documentation of processes, demonstration on another aeroplane/validation (as described in Paragraph G of this Appendix) or a combination of these.

B Background

When ETOPS requirements were first released in 1985 ETOPS was a new concept, requiring extensive in-service verification of capability to assure the concept was a logical approach. At the time, the Authorities recognised that a reduction in the in-service requirements or substitution of in-service experience, on another aeroplane, would be possible.

The ETOPS concept has been successfully applied for close to a decade; ETOPS is now widely employed. The number of ETOPS operators has increased dramatically, and in the North Atlantic US airlines have more twin operations than the number of operations accomplished by three and four engine aeroplanes. ETOPS is now well established.

Under the AMC, an operator is generally required to operate an airframe-engine combination for one (1) year, before being eligible for 120 minute ETOPS; and another one (1) year, at 120 minute ETOPS, before being granted 180 minute ETOPS approval. For example, an operator who currently has 180 minute ETOPS approval on one type of airframe-engine or who is currently operating that route with an older generation three or four engine aeroplane could be required to wait for up to two (2) years for such an approval. Such a requirement creates undue economic burden on operators and may not contribute to safety. Data indicates that compliance with processes has resulted in successful ETOPS operation at earlier than the standard time provided for in the AMC.

ETOPS operational data indicates that twins have maintained a high degree of reliability due to heightened awareness of specific maintenance, engineering and flight operation process related requirements. Compliance with ETOPS processes is crucial in assuring high levels of reliability of twins. Data shows that previous experience on an airframe-engine combination prior to operating ETOPS, does not necessarily make a significant difference in the safety of such operations. Commitment to establishment of reliable ETOPS processes has been found to be a much more significant factor. Such commitment, by operators, to ETOPS processes has, from the outset, resulted in operation of twins at a mature level of reliability.

CS-20-6

ETOPS experience of the past decade shows that a firm commitment by the operator to establish proven ETOPS processes prior to the start of actual ETOPS operations and to maintain that commitment throughout the life of the programme is paramount to ensuring safe and reliable ETOPS operations.

C Terminology

Process:

A process is a series of steps or activities that are accomplished, in a consistent manner, to ensure that a desired result is attained on an ongoing basis. Paragraph D documents ETOPS processes that should be in place to ensure a successful Accelerated ETOPS programme.

Proven Process:

A process is considered to be 'proven' when the following elements are developed and implemented:

- (1) Definition and documentation of process elements
- (2) Definition of process related roles and responsibilities
- (3) Procedure for validation of process elements
 - Indications of process stability/reliability
 - Parameters to validate process and monitor (measure) success
 - Duration of necessary evaluation to validate process
- (4) Procedure for follow-up in-service monitoring to assure process remains reliable/stable.

Methods of process validation are provided in paragraph G.

D ETOPS Processes

The two-engine airframe-engine combination for which the operator is seeking Accelerated ETOPS Operational Approval must be ETOPS Type Design approved prior to commencing ETOPS. The operator seeking Accelerated ETOPS Operational Approval must demonstrate to the Authority that it has an ETOPS programme in place that addresses the process elements identified in this paragraph

The following are the ETOPS process elements:

- (1) Aeroplane/engine compliance to Type Design Build Standard (CMP)
- (2) Compliance with the Maintenance Requirements as defined in Paragraph 10 and Appendix 4 of this AMC:

Fully developed Maintenance Programme (Appendix 4, paragraph 2) which includes a tracking and control programme.

ETOPS manual (Appendix 4, paragraph 3) in place.

A proven Oil Consumption Monitoring Programme. (Appendix 4, paragraph 4)

A proven Engine Condition Monitoring and Reporting system. (Appendix 4, paragraph 5)

A proven Plan for Resolution of Aeroplane Discrepancies. (Appendix 4, paragraph 6)

A proven ETOPS Reliability Programme. (Appendix 4, paragraph 7)

Propulsion system monitoring programme (Appendix 4, paragraph 8) in place. The operator should establish a programme that results in a high degree of confidence that the propulsion system reliability appropriate to the ETOPS diversion time would be maintained.

Training and qualifications programme in place for ETOPS maintenance personnel. (Appendix 4, paragraph 9).

Established ETOPS parts control programme (Appendix 4, paragraph 10)

- (3) Compliance with the Flight Operations Programme as defined in Paragraph 10 of this AMC.

Proven flight planning and dispatch programmes appropriate to ETOPS.

Availability of meteorological information and MEL appropriate to ETOPS.

Initial and recurrent training and checking programme in place for ETOPS flight operations personnel.

Flight crew and dispatch personnel familiarity assured with the ETOPS routes to be flown; in particular the requirements for, and selection of, en-route alternates.

(4) Documentation of the following elements:

Technology new to the operator and significant difference in primary and secondary power (engines, electrical, hydraulic and pneumatic) systems between the aeroplanes currently operated and the two-engine aeroplane for which the operator is seeking Accelerated ETOPS Operational Approval.

The plan to train the flight and maintenance personnel to the differences identified in 1 above.

The plan to use proven or manufacturer validated Training and Maintenance and Operations Manual procedures relevant to ETOPS for the two-engine aeroplane for which the operator is seeking Accelerated ETOPS Operational Approval.

Changes to any previously proven or manufacturer validated Training, Maintenance or Operations Manual procedures described above. Depending on the nature of any changes, the operator may be required to provide a plan for validating such changes.

The validation plan for any additional operator unique training and procedures relevant to ETOPS, if any.

Details of any ETOPS programme support from the airframe manufacturer, engine manufacturer, other operators or any other outside agency.

The control procedures when maintenance or flight dispatch support is provided by an outside party as described above.

E Application

Paragraph 10a of this AMC requires that requests for extended range operations be submitted at least 3 months prior to the start of extended range operations. Normally, the operator should submit an 'Accelerated ETOPS Operational Approval Plan' to the Authority six (6) months before the proposed start of extended range operations. This additional time will permit the Authority to review the documented plans and assure adequate ETOPS processes are in place.

The operator's application for Accelerated ETOPS should:

Define proposed routes and the ETOPS diversion time necessary to support those routes.

Define processes and related resources being allocated to initiate and sustain ETOPS operations in a manner which demonstrates commitment by management and all personnel involved in ETOPS maintenance and operational support.

Identify, where required, the plan for establishing compliance with the build standard required for Type Design Approval, e.g. CMP (Configuration, Maintenance and Procedures Document) compliance.

Document plan for compliance with requirements in Paragraph D.

5. Define Review Gates. A Review Gate is a milestone tracking plan to allow for the orderly tracking and documentation of specific requirements of this Appendix. Each Review Gate should be defined in terms of the tasks to be satisfactorily accomplished in order for it to be successfully passed. Items for which the Authority visibility is required or the Authority approval is sought should be included in the Review Gates. Normally, the Review Gate process will start six (6) months before the proposed start of extended range operations and should continue at least six (6) months after the start of extended range operations. Assure that the proven processes comply with the provisions of Paragraph C of this Appendix.

F Operational Approvals

Operational approvals which are granted with reduced in-service experience should be limited to those areas agreed by the Authority at approval of the Accelerated ETOPS Operational Approval Plan. When an operator wishes to add new areas to the approved list, Authority concurrence is required.

CS-20-6

Operators will be eligible for ETOPS Operational Approval up to the Type Design Approval limit, provided the operator complies with all the requirements in Paragraph D.

G Process Validation.

Paragraph D identifies those process elements that are needed to be proven prior to the start of Accelerated ETOPS. For a process to be considered proven, the process must first be defined. Typically this will include a flow chart showing elements of the process. Roles and responsibilities of the personnel who will be managing this process should be defined including any training requirement. The operator should demonstrate that the process is in place and functions as intended. The operator may accomplish this by thorough documentation and analysis, or by demonstrating on an aeroplane that the process works and consistently provides the intended results. The operator should also show that the feedback loop exists to illustrate need for revision of the process, if required, based on in-service experience.

Normally the choice to use, or not to use, demonstration on an aeroplane as a means of validating the process should be left up to the operator. With sufficient preparation and dedication of resources such validation may not be necessary to assure processes should produce acceptable results. However, in any case where the proposed plan to prove the processes is determined by the Authority to be inadequate or the plan does not produce acceptable results, validation of the process in an aeroplane may be required.

If any operator is currently operating ETOPS with a different airframe and/or engine combination it may be able to document that it has proven ETOPS processes in place and only minimal further validation may be necessary. It will, however, be necessary to demonstrate that means are in place to assure equivalent results will occur on the aeroplane being proposed for Accelerated ETOPS Operational Approval.

The following elements which, while not required, may be useful or beneficial in justifying a reduction in the requirements of ETOPS processes:

Experience with other airframes and/or engines.

2. Previous ETOPS experience.
3. Experience with long range, overwater operations with two, three or four engine aeroplanes.

Any experience gained by flight crews, maintenance personnel and flight dispatch personnel while working with other ETOPS approved operators.

Process validation may be done in the airframe-engine combination which will be used in Accelerated ETOPS operation or in a different aeroplane type than that for which approval is being sought, including those with three and four engines.

A process may be validated by first demonstrating the process produces acceptable results on a different aeroplane type or airframe-engine combination. It should then be necessary to demonstrate that means are in place to assure equivalent results should occur on the aeroplane being proposed for Accelerated ETOPS Operational Approval.

Any validation programme should address the following:

The operator should show that it has considered the impact of the ETOPS validation programme with regard to safety of flight operations. The operator should state in its application any policy guidance to personnel involved in the ETOPS process validation programme. Such guidance should clearly state that ETOPS process validation exercises should not be allowed to adversely impact the safety of actual operations especially during periods of abnormal, emergency, or high cockpit workload operations. It should emphasise that during periods of abnormal or emergency operation or high cockpit workload ETOPS process validation exercises may be terminated.

The validation scenario should be of sufficient frequency and operational exposure to validate maintenance and operational support systems not validated by other means.

A means must be established to monitor and report performance with respect to accomplishment of tasks associated with ETOPS process elements. Any recommended changes to ETOPS maintenance and operational process elements should be defined.

Prior to the start of the process validation programme, the following information should be submitted to the Authority:

- Validation periods, including start dates and proposed completion dates.
- Definition of aeroplane to be used in the validation. List should include registration numbers, manufacturer and serial number and model of the airframe and engines.
- Description of the areas of operation (if relevant to validation objectives) proposed for validation and actual operations.
- Definition of designated ETOPS validation routes. The routes should be of duration required to ensure necessary process validation occurs.

Process validation reporting. The operator should compile results of ETOPS process validation. The operator should:

- Document how each element of the ETOPS process was utilised during the validation.
- Document any shortcomings with the process elements and measures in place to correct such shortcomings.
- Document any changes to ETOPS processes which were required after an in-flight shut down (IFSD), unscheduled engine removals, or any other significant operational events.
- Provide periodic Process Validation reports to the Authority. This may be addressed during Review Gates.

INTENTIONALLY LEFT BLANK

AMC 20-8 Occurrence Reporting

1. INTENT

This AMC is interpretative material and provides guidance in order to determine which occurrences should be reported to the Agency, national authorities and to other organisations, and it provides guidance on the timescale for submission of such reports.

It also describes the objective of the overall occurrence reporting system including internal and external functions

2. APPLICABILITY

(a) This AMC only applies to occurrence reporting by persons/organisations regulated by Regulation (EC) No 1592/2002 of the European Parliament and of the Council. It does not address reporting by aerodrome organisations, air navigation service providers and authorities themselves.

(b) In most cases the obligation to report is on the holders of a certificate or approval, which in most cases are organisations, but in some cases can be a single person. In addition some reporting requirements are directed to persons. However, in order not to complicate the text, only the term 'organisation' is used.

(c) The AMC also does not apply to dangerous goods reporting. The definition of reportable dangerous goods occurrences is different from the other occurrences and the reporting system is also separate. This subject is covered in specific operating requirements and guidance and ICAO Documents namely:

- (i) ICAO Annex 18, The safe Transport of Dangerous Goods by Air, Chapter 12
- (ii) ICAO Doc 9284-AN/905, Technical Instructions for the Safe Transport of Dangerous Goods by Air

3. OBJECTIVE OF OCCURRENCE REPORTING

(a) The occurrence reporting system is an essential part of the overall monitoring function. The objective of the occurrence reporting, collection, investigation and analysis systems described in the operating rules, and the airworthiness rules is to use the reported information to contribute to the improvement of aviation safety, and not to attribute blame, impose fines or take other enforcement actions.

(b) The detailed objectives of the occurrence reporting systems are:

(i) To enable an assessment of the safety implications of each occurrence to be made, including previous similar occurrences, so that any necessary action can be initiated. This includes determining what and why it had occurred and what might prevent a similar occurrence in the future.

(ii) To ensure that knowledge of occurrences is disseminated so that other persons and organisations may learn from them.

(c) The occurrence reporting system is complementary to the normal day to day procedures and 'control' systems and is not intended to duplicate or supersede any of them. The occurrence reporting system is a tool to identify those occasions where routine procedures have failed.

AMC 20-8

d) Occurrences should remain in the database when judged reportable by the person submitting the report as the significance of such reports may only become obvious at a later date.

4. REPORTING TO THE AGENCY AND NATIONAL AUTHORITIES

(a) Requirements

(i) As detailed in the operating rules, occurrences defined as an incident, malfunction, defect, technical defect or exceedence of technical limitations that endangers or could endanger the safe operation of the aircraft must be reported to the national authority.

(ii) The products and part and appliances design rules prescribe that occurrences defined as a failure, malfunction, defect or other occurrence which has resulted in or may result in an unsafe condition must be reported to the Agency.

(iii) According to the product and part and appliances production rules occurrences defined as a deviation which could lead to an unsafe condition must be reported to the Agency and the national authority.

(iv) The maintenance rules stipulate that occurrences defined as any condition of the aircraft or aircraft component that has resulted or may result in an unsafe condition that could seriously hazard the aircraft must be reported to the national authority.

(v) Reporting does not remove the reporter's or organisation's responsibility to commence corrective actions to prevent similar occurrences in the future. Known and planned preventive actions should be included within the report.

(b) Paragraph 10.g. of this AMC provides guidance as to what should be reported by an organisation to the authority. The list of criteria provided may be used as guidance for establishing which occurrences shall be reported by which organisation. For example, the organisation responsible for the design will not need to report certain operational occurrences that it has been made aware of, if the continuing airworthiness of the product is not involved.

5. NOTIFICATION OF ACCIDENTS AND SERIOUS INCIDENTS

In addition to the requirement to notify the appropriate accident investigating authorities directly of any accident or serious incident, operators should also report to the national authority in charge of supervising the reporting organisation

6. REPORTING TIME

(a) The period of 72 hours is normally understood to start from when the occurrence took place or from the time when the reporter determined that there was, or could have been, a potentially hazardous or unsafe condition.

(b) For many occurrences there is no evaluation needed; it must be reported. However, there will be occasions when, as part of a Flight Safety and Accident Prevention programme or Quality Programme, a previously non-reportable occurrence is determined to be reportable

(c) Within the overall limit of 72 hours for the submission of a report, the degree of urgency should be determined by the level of hazard judged to have resulted from the occurrence:

(i) Where an occurrence is judged to have resulted in an immediate and particularly significant hazard the Agency and/or national authority expects to be advised immediately, and by the fastest possible means (e.g. telephone, fax, telex, e-mail) of whatever details are available at that time. This initial notification should then be followed up by a report within 72 hours.

- (ii) Where the occurrence is judged to have resulted in a less immediate and less significant hazard, report submission may be delayed up to the maximum of 72 hours in order to provide more details or more reliable information.

7. CONTENT OF REPORTS

(a) Notwithstanding other required reporting means as promulgated in national requirements (e.g. AIRPROX reporting), reports may be transmitted in any form considered acceptable to the Agency and/or national authority. The amount of information in the report should be commensurate with the severity of the occurrence. Each report should at least contain the following elements, as applicable to each organisation:

- (i) Organisation name
- (ii) Approval reference (if relevant)
- (iii) Information necessary to identify the aircraft or part affected.
- (iv) Date and time if relevant
- (v) A written summary of the occurrence
- (vi) Any other specific information required

(b) For any occurrence involving a system or component, which is monitored or protected by a warning and/or protection system (for example: fire detection/extinguishing) the occurrence report should always state whether such system(s) functioned properly.

8. NOTIFICATION TO OTHER AGENCIES

For approved operations organisations, in addition to reporting occurrences to the national authority, the following agencies should also be notified in specific cases:

- (a) Reports relating to 'security incidents' should also be notified to the appropriate local security agency
- (b) Reports relating to air traffic, aerodrome occurrences or bird strikes should also be notified to the appropriate air navigation , aerodrome or ground agency
- (c) Requirements for reporting and assessment of safety occurrences in ATM within the ECAC Region are harmonised within EUROCONTROL document ESARR 2.

9. REPORTING BETWEEN ORGANISATIONS

(a) Requirements exist that address the reporting of data relating to unsafe or unairworthy conditions. These reporting lines are:

- (i) Production Organisation to the organisation responsible for the design;
- (ii) Maintenance organisation to the organisation responsible for the design;
- (iii) Maintenance organisation to operator;
- (iv) Operator to organisation responsible for the design;
- (v) Production organisation to production organisation.

(b) The 'Organisation responsible for the design' is a general term, which can be any one or a combination of the following organisations

AMC 20-8

- (i) Holder of Type Certificate (TC) of an Aircraft, Engine or Propeller;
 - (ii) Holder of a Supplemental Type Certificate (STC) on an Aircraft, Engine or Propeller;
 - (iii) Holder of a European Technical Standard Order (ETSO) Authorisation; or
 - (iv) Holder of a European Part Approval (EPA)
- (c) If it can be determined that the occurrence has an impact on or is related to an aircraft component which is covered by a separate design approval (TC, STC, ETSO or EPA), then the holders of such approval/authorisation should be informed. If an occurrence happens on a component which is covered by an TC, STC, ETSO or EPA (e.g. during maintenance), then only that TC, STC, ETSO Authorisation or EPA holder needs to be informed.
- (d) The form and timescale for reports to be exchanged between organisations is left for individual organisations to determine. What is important is that a relationship exists between the organisations to ensure that there is an exchange of information relating to occurrences.
- (e) Paragraph 10.g. of this AMC provides guidance as to what should be reported by an organisation to the authority. The list of criteria provided may be used as guidance for establishing which occurrences shall be reported to which organisation. For example, certain operational occurrences will not need to be reported by an operator to the design or production organisation.

10. REPORTABLE OCCURRENCES

(a) *General.* There are different reporting requirements for operators (and/or commanders), maintenance organisations, design organisations and production organisations. Moreover, as explained in paragraph 4. and 9. above, there are not only requirements for reporting to the Agency and national authority, but also for reporting to other (private) entities. The criteria for all these different reporting lines are not the same. For example the authority will not receive the same kind of reports from a design organisation as from an operator. This is a reflection of the different perspectives of the organisations based on their activities.

Figure 1 presents a simplified scheme of all reporting lines.

Figure 1

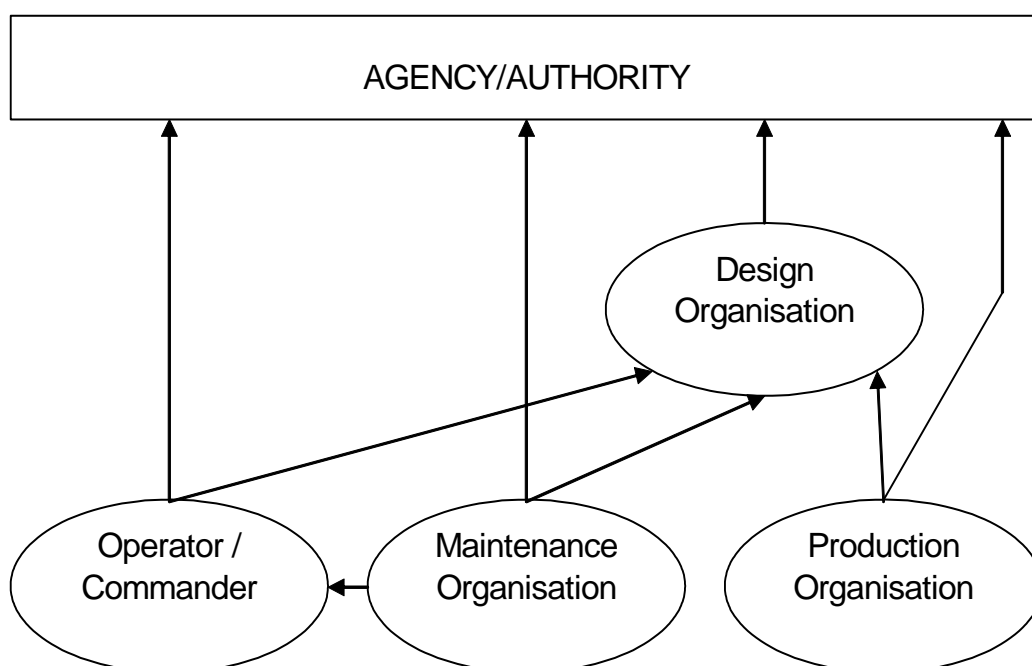

(b) *Operations and Maintenance.* The list of examples of reportable occurrences offered below under g. is established from the perspective of primary sources of occurrence information in the operational area (operators and maintenance organisations) to provide guidance for those persons developing criteria for individual organisations on what they need to report to the Agency and/or national authority. The list is neither definitive nor exhaustive and judgement by the reporter of the degree of hazard or potential hazard involved is essential.

(c) *Design.* The list of examples will not be used by design organisations directly for the purpose of determining when a report has to be made to the authority, but it can serve as guidance for the establishment of the system for collecting data. After receipt of reports from the primary sources of information, designers will normally perform some kind of analysis to determine whether an occurrence has resulted or may result in an unsafe condition and a report to the authority should be made. An analysis method for determining when an unsafe condition exists in relation to continuing airworthiness is detailed in the AMC's regarding the issuance of Airworthiness Directives.

(d) *Production.* The list of examples is not applicable to the reporting obligation of production organisations. Their primary concern is to inform the design organisation of deviations. Only in cases where an analysis in conjunction with that design organisation shows that the deviation could lead to an unsafe condition, should a report be made to the Agency and/or national authority (see also c. above).

(e) *Customised list.* Each approval, certificate, authorisation other than those mentioned in sub paragraph c and d above, should develop a customised list adapted to its aircraft, operation or product. The list of reportable occurrences applicable to an organisation is usually published within the organisation's expositions/handbooks/manuals

(f) *Internal reporting.* The perception of safety is central to occurrence reporting. It is for each organisation to determine what is safe and what is unsafe and to develop its reporting system on that basis. The organisation should establish an internal reporting system whereby reports are centrally collected and reviewed to establish which reports meet the criteria for occurrence reporting to the Agency and/or national authority and other organisations, as required.

(g) *List of examples of reportable occurrences*

The following is a generic list. Not all examples are applicable to each reporting organisation. Therefore each organisation should define and agree with the Agency and/or national authority a specific list of reportable occurrences or a list of more generic criteria, tailored to its activity and scope of work (see also 10.e above). In establishing that customised list, the organisation should take into account the following considerations:

Reportable occurrences are those where the safety of operation was or could have been endangered or which could have led to an unsafe condition. If in the view of the reporter an occurrence did not hazard the safety of the operation but if repeated in different but likely circumstances would create a hazard, then a report should be made. What is judged to be reportable on one class of product, part or appliance may not be so on another and the absence or presence of a single factor, human or technical, can transform an occurrence into a serious incident or accident.

Specific operational approvals, e.g. RVSM, ETOPS, RNAV, or a design or maintenance programme, may have specific reporting requirements for failures or malfunctions associated with that approval or programme.

A lot of the qualifying adjectives like 'significant' have been deleted from the list. In stead it is expected that all examples are qualified by the reporter using the general criteria that are applicable in his field, and specified in the requirement. (e.g. for operators: 'hazards or could have hazarded the operation')

AMC 20-8

CONTENTS:

I. AIRCRAFT FLIGHT OPERATIONS

II. AIRCRAFT TECHNICAL

III. AIRCRAFT MAINTENANCE AND REPAIR

IV AIR NAVIGATION SERVICES, FACILITIES AND GROUND SERVICES

I. AIRCRAFT FLIGHT OPERATIONS

A. Operation of the Aircraft

- (1) (a) Risk of collision with an aircraft, terrain or other object or an unsafe situation when avoidance action would have been appropriate.
 - (b) An avoidance manoeuvre required to avoid a collision with an aircraft, terrain or other object.
 - (c) An avoidance manoeuvre to avoid other unsafe situations.
- (2) Take-off or landing incidents, including precautionary or forced landings. Incidents such as under-shooting, overrunning or running off the side of runways. Take-offs, rejected take-offs, landings or attempted landings on a closed, occupied or incorrect runway. Runway incursions.
- (3) Inability to achieve predicted performance during take-off or initial climb.
- (4) Critically low fuel quantity or inability to transfer fuel or use total quantity of usable fuel.
- (5) Loss of control (including partial or temporary loss of control) from any cause.
- (6) Occurrences close to or above V_1 resulting from or producing a hazardous or potentially hazardous situation (e.g. rejected take-off, tail strike, engine power loss etc.).
- (7) Go-around producing a hazardous or potentially hazardous situation.
- (8) Unintentional significant deviation from airspeed, intended track or altitude. (more than 91 m (300 ft)) from any cause.
- (9) Descent below decision height/altitude or minimum descent height/altitude without the required visual reference.
- (10) Loss of position awareness relative to actual position or to other aircraft.
- (11) Breakdown in communication between flight crew (CRM) or between Flight crew and other parties (cabin crew, ATC, engineering).
- (12) Heavy landing - a landing deemed to require a 'heavy landing check'.
- (13) Exceedance of fuel imbalance limits.
- (14) Incorrect setting of an SSR code or of an altimeter subscale.
- (15) Incorrect programming of, or erroneous entries into, equipment used for navigation or performance calculations, or use of incorrect data.
- (16) Incorrect receipt or interpretation of radiotelephony messages.
- (17) Fuel system malfunctions or defects, which had an effect on fuel supply and/or distribution.
- (18) Aircraft unintentionally departing a paved surface.

AMC 20-8

- (19) Collision between an aircraft and any other aircraft, vehicle or other ground object.
- (20) Inadvertent and/or incorrect operation of any controls.
- (21) Inability to achieve the intended aircraft configuration for any flight phase (e.g. landing gear and doors, flaps, stabilisers, slats etc).
- (22) A hazard or potential hazard which arises as a consequence of any deliberate simulation of failure conditions for training, system checks or training purposes.
- (23) Abnormal vibration.
- (24) Operation of any primary warning system associated with manoeuvring of the aircraft e.g. configuration warning, stall warning (stick shake), over speed warning etc. unless:
 - (a) the crew conclusively established that the indication was false. Provided that the false warning did not result in difficulty or hazard arising from the crew response to the warning; or
 - (b) operated for training or test purposes.
- (25) GPWS/TAWS 'warning' when:
 - (a) the aircraft comes into closer proximity to the ground than had been planned or anticipated; or
 - (b) the warning is experienced in IMC or at night and is established as having been triggered by a high rate of descent (Mode 1); or
 - (c) the warning results from failure to select landing gear or land flap by the appropriate point on the approach (Mode 4); or
 - (d) any difficulty or hazard arises or might have arisen as a result of crew response to the 'warning' e.g. possible reduced separation from other traffic. This could include warning of any Mode or Type i.e. genuine, nuisance or false.
- (26) GPWS/TAWS 'alert' when any difficulty or hazard arises or might have arisen as a result of crew response to the 'alert'.
- (27) ACAS RAs.
- (28) Jet or prop blast incidents resulting in significant damage or serious injury.

B. Emergencies

- (1) Fire, explosion, smoke or toxic or noxious fumes, even though fires were extinguished.
- (2) The use of any non-standard procedure by the flight or cabin crew to deal with an emergency when:
 - (a) the procedure exists but is not used; or
 - (b) a procedure does not exist; or

- (c) the procedure exists but is incomplete or inappropriate; or
 - (d) the procedure is incorrect; or
 - (e) the incorrect procedure is used.
- (3) Inadequacy of any procedures designed to be used in an emergency, including when being used for maintenance, training or test purposes.
 - (4) An event leading to an emergency evacuation.
 - (5) Depressurisation.
 - (6) The use of any emergency equipment or prescribed emergency procedures in order to deal with a situation.
 - (7) An event leading to the declaration of an emergency ('Mayday' or 'Pan').
 - (8) Failure of any emergency system or equipment, including all exit doors and lighting, to perform satisfactorily, including when being used for maintenance, training or test purposes.
 - (9) Events requiring any emergency use of oxygen by any crew member.

C. Crew Incapacitation

- (1) Incapacitation of any member of the flight crew, including that which occurs prior to departure if it is considered that it could have resulted in incapacitation after take-off.
- (2) Incapacitation of any member of the cabin crew which renders them unable to perform essential emergency duties.

D. Injury

- (1) Occurrences, which have or could have led to significant injury to passengers or crew but which are not considered reportable as an accident.

E. Meteorology

- (1) A lightning strike which resulted in damage to the aircraft or loss or malfunction of any essential service.
- (2) A hail strike which resulted in damage to the aircraft or loss or malfunction of any essential service.
- (3) Severe turbulence encounter – an encounter resulting in injury to occupants or deemed to require a 'turbulence check' of the aircraft.
- (4) A windshear encounter.

AMC 20-8

- (5) Icing encounter resulting in handling difficulties, damage to the aircraft or loss or malfunction of any essential service.

F. Security

- (1) Unlawful interference with the aircraft including a bomb threat or hijack.
- (2) Difficulty in controlling intoxicated, violent or unruly passengers.
- (3) Discovery of a stowaway.

G. Other Occurrences

- (1) Repetitive instances of a specific type of occurrence which in isolation would not be considered 'reportable' but which due to the frequency at which they arise, form a potential hazard.
- (2) A bird strike which resulted in damage to the aircraft or loss or malfunction of any essential service.
- (3) Wake turbulence encounters.
- (4) Any other occurrence of any type considered to have endangered or which might have endangered the aircraft or its occupants on board the aircraft or on the ground.

II. AIRCRAFT TECHNICAL

A. Structural

Not all structural failures need to be reported. Engineering judgement is required to decide whether a failure is serious enough to be reported. The following examples can be taken into consideration:

- (1) Damage to a Principal Structural Element that has not been qualified as damage tolerant (life limited element). Principal Structural Elements are those which contribute significantly to carrying flight, ground, and pressurisation loads, and whose failure could result in a catastrophic failure of the aircraft. Typical examples of such elements are listed for large aeroplanes in AC/AMC 25.571(a) "damage tolerance and fatigue evaluation of structure", and in the equivalent AMC material for rotorcraft.
- (2) Defect or damage exceeding admissible damages to a Principal Structural Element that has been qualified as damage tolerant.
- (3) Damage to or defect exceeding allowed tolerances of a structural element which failure could reduce the structural stiffness to such an extent that the required flutter, divergence or control reversal margins are no longer achieved.

- (4) Damage to or defect of a structural element, which could result in the liberation of items of mass that may injure occupants of the aircraft.
- (5) Damage to or defect of a structural element, which could jeopardise proper operation of systems. See paragraph II.B. below.
- (6) Loss of any part of the aircraft structure in flight.

B. Systems

The following generic criteria applicable to all systems are proposed:

- (1) Loss, significant malfunction or defect of any system, subsystem or set of equipment when standard operating procedures, drills etc. could not be satisfactorily accomplished.
- (2) Inability of the crew to control the system, e.g.:
 - (a) uncommanded actions;
 - (b) incorrect and or incomplete response, including limitation of movement or stiffness;
 - (c) runaway;
 - (d) mechanical disconnection or failure.
- (3) Failure or malfunction of the exclusive function(s) of the system (one system could integrate several functions).
- (4) Interference within or between systems.
- (5) Failure or malfunction of the protection device or emergency system associated with the system.
- (6) Loss of redundancy of the system.
- (7) Any occurrence resulting from unforeseen behaviour of a system.
- (8) For aircraft types with single main systems, subsystems or sets of equipment: Loss, significant malfunction or defect in any main system, subsystem or set of equipment.
- (9) For aircraft types with multiple independent main systems, subsystems or sets of equipment: The loss, significant malfunction or defect of more than one main system, subsystem or set of equipment
- (10) Operation of any primary warning system associated with aircraft systems or equipment unless the crew conclusively established that the indication was false provided that the false warning did not result in difficulty or hazard arising from the crew response to the warning.
- (11) Leakage of hydraulic fluids, fuel, oil or other fluids which resulted in a fire hazard or possible hazardous contamination of aircraft structure, systems or equipment, or risk to occupants.

AMC 20-8

- (12) Malfunction or defect of any indication system when this results in the possibility of misleading indications to the crew.
- (13) Any failure, malfunction or defect if it occurs at a critical phase of flight and relevant to the operation of that system.
- (14) Occurrences of significant shortfall of the actual performances compared to the approved performance which resulted in a hazardous situation (taking into account the accuracy of the performance calculation method) including braking action, fuel consumption etc.
- (15) Asymmetry of flight controls; e.g. flaps, slats, spoilers etc.

Annex 1 to this AMC gives a list of examples of reportable occurrences resulting from the application of these generic criteria to specific systems

C. Propulsion (including Engines, Propellers and Rotor Systems) and APUs

- (1) Flameout, shutdown or malfunction of any engine.
- (2) Overspeed or inability to control the speed of any high speed rotating component (for example: Auxiliary power unit, air starter, air cycle machine, air turbine motor, propeller or rotor).
- (3) Failure or malfunction of any part of an engine or powerplant resulting in any one or more of the following:
 - (a) non containment of components/debris;
 - (b) uncontrolled internal or external fire, or hot gas breakout;
 - (c) thrust in a different direction from that demanded by the pilot;
 - (d) thrust reversing system failing to operate or operating inadvertently;
 - (e) inability to control power, thrust or rpm;
 - (f) failure of the engine mount structure;
 - (g) partial or complete loss of a major part of the powerplant;
 - (h) Dense visible fumes or concentrations of toxic products sufficient to incapacitate crew or passengers;
 - (i) inability, by use of normal procedures, to shutdown an engine;
 - (j) inability to restart a serviceable engine.
- (4) An uncommanded thrust/power loss, change or oscillation which is classified as a loss of thrust or power control (LOTTC) as defined in AMC 20-1:
 - (a) for a single engine aircraft; or
 - (b) where it is considered excessive for the application, or

- (c) where this could affect more than one engine in a multi-engine aircraft, particularly in the case of a twin engine aircraft; or
- (d) for a multi engine aircraft where the same, or similar, engine type is used in an application where the event would be considered hazardous or critical.
- (5) Any defect in a life controlled part causing retirement before completion of its full life.
- (6) Defects of common origin which could cause an in flight shut down rate so high that there is the possibility of more than one engine being shut down on the same flight.
- (7) An engine limiter or control device failing to operate when required or operating inadvertently.
- (8) exceedance of engine parameters.
- (9) FOD resulting in damage.

Propellers and -transmission

- (10) Failure or malfunction of any part of a propeller or powerplant resulting in any one or more of the following:
 - (a) an overspeed of the propeller;
 - (b) the development of excessive drag;
 - (c) a thrust in the opposite direction to that commanded by the pilot;
 - (d) a release of the propeller or any major portion of the propeller;
 - (e) a failure that results in excessive unbalance;
 - (f) the unintended movement of the propeller blades below the established minimum in-flight low-pitch position;
 - (g) an inability to feather the propeller;
 - (h) an inability to command a change in propeller pitch;
 - (i) an uncommanded change in pitch;
 - (j) an uncontrollable torque or speed fluctuation;
 - (k) The release of low energy parts.

Rotors and -transmission

- (11) Damage or defect of main rotor gearbox / attachment which could lead to in flight separation of the rotor assembly, and /or malfunctions of the rotor control.
- (12) Damage to tail rotor, transmission and equivalent systems.

APUs

- (13) Shut down or failure when the APU is required to be available by operational requirements, e.g. ETOPS, MEL.
- (14) Inability to shut down the APU.
- (15) Overspeed.
- (16) Inability to start the APU when needed for operational reasons.

D. Human Factors

- (1) Any incident where any feature or inadequacy of the aircraft design could have led to an error of use that could contribute to a hazardous or catastrophic effect.

E. Other Occurrences

- (1) Any incident where any feature or inadequacy of the aircraft design could have led to an error of use that could contribute to a hazardous or catastrophic effect.
- (2) An occurrence not normally considered as reportable (for example, furnishing and cabin equipment, water systems), where the circumstances resulted in endangering of the aircraft or its occupants.
- (3) A fire, explosion, smoke or toxic or noxious fumes.
- (4) Any other event which could hazard the aircraft, or affect the safety of the occupants of the aircraft, or people or property in the vicinity of the aircraft or on the ground.
- (5) Failure or defect of passenger address system resulting in loss or inaudible passenger address system.
- (6) Loss of pilots seat control during flight.

III. AIRCRAFT MAINTENANCE AND REPAIR

- A. Incorrect assembly of parts or components of the aircraft found during an inspection or test procedure not intended for that specific purpose.
- B. Hot bleed air leak resulting in structural damage.
- C. Any defect in a life controlled part causing retirement before completion of its full life.
- D. Any damage or deterioration (i.e. fractures, cracks, corrosion, delamination, disbonding etc) resulting from any cause (such as flutter, loss of stiffness or structural failure) to:

- (1) primary structure or a principal structural element (as defined in the manufacturers' Repair Manual) where such damage or deterioration exceeds allowable limits specified in the Repair Manual and requires a repair or complete or partial replacement of the element;
 - (2) secondary structure which consequently has or may have endangered the aircraft;
 - (3) the engine, propeller or rotorcraft rotor system.
- E. Any failure, malfunction or defect of any system or equipment, or damage or deterioration found as a result of compliance with an Airworthiness Directive or other mandatory instruction issued by a Regulatory Authority, when:
- (1) it is detected for the first time by the reporting organisation implementing compliance;
 - (2) on any subsequent compliance where it exceeds the permissible limits quoted in the instruction and/or published repair/rectification procedures are not available.
- F. Failure of any emergency system or equipment, including all exit doors and lighting, to perform satisfactorily, including when being used for maintenance or test purposes.
- G. Non compliance or significant errors in compliance with required maintenance procedures.
- H. Products, parts, appliances and materials of unknown or suspect origin.
- I. Misleading, incorrect or insufficient maintenance data or procedures that could lead to maintenance errors.
- J. Failure, malfunction or defect of ground equipment used for test or checking of aircraft systems and equipment when the required routine inspection and test procedures did not clearly identify the problem when this results in a hazardous situation.

IV. AIR NAVIGATION SERVICES, FACILITIES AND GROUND SERVICES

A. Air Navigation Services

- (1) Provision of significantly incorrect, inadequate or misleading information from any ground sources, e.g. Air Traffic Control (ATC), Automatic Terminal Information Service (ATIS), Meteorological Services, navigation databases, maps, charts, manuals, etc.
- (2) Provision of less than prescribed terrain clearance.
- (3) Provision of incorrect pressure reference data (i.e. altimeter setting).
- (4) Incorrect transmission, receipt or interpretation of significant messages when this results in a hazardous situation.
- (5) Separation minima infringement.
- (6) Unauthorised penetration of airspace.

AMC 20-8

- (7) Unlawful radio communication transmission.
- (8) Failure of ANS ground or satellite facilities.
- (9) Major ATC/ Air Traffic Management (ATM) failure or significant deterioration of aerodrome infrastructure.
- (10) Aerodrome movement areas obstructed by aircraft, vehicles, animals or foreign objects, resulting in a hazardous or potentially hazardous situation.
- (11) Errors or inadequacies in marking of obstructions or hazards on aerodrome movement areas resulting in a hazardous situation.
- (12) Failure, significant malfunction or unavailability of airfield lighting.

B. Aerodrome and Aerodrome Facilities

- (1) Significant spillage during fuelling operations.
- (2) Loading of incorrect fuel quantities likely to have a significant effect on aircraft endurance, performance, balance or structural strength.
- (3) unsatisfactory ground de-icing / anti-icing

C. Passenger Handling, Baggage and Cargo

- (1) Significant contamination of aircraft structure, or systems and equipment arising from the carriage of baggage or cargo.
- (2) Incorrect loading of passengers, baggage or cargo, likely to have a significant effect on aircraft mass and/or balance.
- (3) Incorrect stowage of baggage or cargo (including hand baggage) likely in any way to hazard the aircraft, its equipment or occupants or to impede emergency evacuation.
- (4) Inadequate stowage of cargo containers or other substantial items of cargo.
- (5) Dangerous goods incidents reporting: see operating rules.

D. Aircraft Ground Handling and Servicing

- (1) Failure, malfunction or defect of ground equipment used for test or checking of aircraft systems and equipment when the required routine inspection and test procedures did not clearly identify the problem when this results in a hazardous situation.
- (2) Non compliance or significant errors in compliance with required servicing procedures.
- (3) Loading of contaminated or incorrect type of fuel or other essential fluids (including oxygen and potable water).

Reportable occurrences to specific systems

The following subparagraphs give examples of reportable occurrences resulting from the application of the generic criteria to specific systems listed in paragraph 10.g. II.B of this AMC.

1. Air conditioning/ventilation
 - (a) complete loss of avionics cooling
 - (b) depressurisation
2. Autoflight system
 - (a) failure of the autoflight system to achieve the intended operation while engaged
 - (b) significant reported crew difficulty to control the aircraft linked to autoflight system functioning
 - (c) failure of any autoflight system disconnect device
 - (d) Uncommanded autoflight mode change
3. Communications
 - (a) failure or defect of passenger address system resulting in loss or inaudible passenger address
 - (b) total loss of communication in flight
4. Electrical system
 - (a) loss of one electrical system distribution system (AC or DC)
 - (b) total loss or loss or more than one electrical generation system
 - (c) failure of the back up (emergency) electrical generating system
5. Cockpit/Cabin/Cargo
 - (a) pilot seat control loss during flight
 - (b) failure of any emergency system or equipment, including emergency evacuation signalling system , all exit doors , emergency lighting, etc
 - (c) loss of retention capability of the cargo loading system
6. Fire protection system
 - (a) fire warnings, except those immediately confirmed as false
 - (b) undetected failure or defect of fire/smoke detection/protection system, which could lead to loss or reduced fire detection/protection
 - (c) absence of warning in case of actual fire or smoke

Annex 1 to AMC 20-8

7. Flight controls
 - (a) Asymmetry of flaps, slats, spoilers etc.
 - (b) limitation of movement, stiffness or poor or delayed response in the operation of primary flight control systems or their associated tab and lock systems
 - (c) flight control surface run away
 - (d) flight control surface vibration felt by the crew
 - (e) mechanical flight control disconnection or failure
 - (f) significant interference with normal control of the aircraft or degradation of flying qualities
8. Fuel system
 - (a) fuel quantity indicating system malfunction resulting in total loss or erroneous indicated fuel quantity on board
 - (b) leakage of fuel which resulted in major loss, fire hazard , significant contamination
 - (c) malfunction or defects of the fuel jettisoning system which resulted in inadvertent loss of significant quantity, fire hazard, hazardous contamination of aircraft equipment or inability to jettison fuel
 - (d) fuel system malfunctions or defects which had a significant effect on fuel supply and/or distribution
 - (e) inability to transfer or use total quantity of usable fuel
9. Hydraulics
 - (a) loss of one hydraulic system (ETOPS only)
 - (b) failure of the isolation system to operate
 - (c) loss of more than one hydraulic circuits
 - (d) failure of the back up hydraulic system
 - (e) inadvertent Ram Air Turbine extension
10. Ice detection/protection system
 - (a) undetected loss or reduced performance of the anti-ice/de-ice system
 - (b) loss of more than one of the probe heating systems
 - (c) inability to obtain symmetrical wing de icing
 - (d) abnormal ice accumulation leading to significant effects on performance or handling qualities
 - (e) crew vision significantly affected

11. Indicating/warning/recording systems

- (a) malfunction or defect of any indicating system when the possibility of significant misleading indications to the crew could result in an inappropriate crew action on an essential system
- (b) loss of a red warning function on a system
- (c) for glass cockpits: loss or malfunction of more than one display unit or computer involved in the display/warning function

12. Landing gear system /brakes/tyres

- (a) brake fire
- (b) significant loss of braking action
- (c) unsymmetrical braking leading to significant path deviation
- (d) failure of the L/G free fall extension system (including during scheduled tests)
- (e) unwanted gear or gear doors extension/retraction
- (f) multiple tyres burst

13. Navigation systems (including precision approaches system) and air data systems

- (a) total loss or multiple navigation equipment failures
- (b) total failure or multiple air data system equipment failures
- (c) significant misleading indication
- (d) Significant navigation errors attributed to incorrect data or a database coding error
- (e) Unexpected deviations in lateral or vertical path not caused by pilot input.
- (f) Problems with ground navigational facilities leading to significant navigation errors not associated with transitions from inertial navigation mode to radio navigation mode.

14. Oxygen

- (a) for pressurised aircraft: loss of oxygen supply in the cockpit
- (b) loss of oxygen supply to a significant number of passengers (more than 10%), including when found during maintenance or training or test purposes

15. Bleed air system

- (a) hot bleed air leak resulting in fire warning or structural damage
- (b) loss of all bleed air systems
- (c) failure of bleed air leak detection system

INTENTIONALLY LEFT BLANK