

European Union Aviation Safety Agency

**Certification Specifications,
Acceptable Means of Compliance
and Guidance Material
for
Small Rotorcraft**

CS-27

Amendment 9
17 December 2021¹

¹ For the date of entry into force of Amendment 9, please refer to Decision 2021/016/R at the [Official Publication](#) of EASA.

CONTENTS (general layout)**CS-27****SMALL ROTORCRAFT****BOOK 1 – CERTIFICATION SPECIFICATIONS**

- SUBPART A – GENERAL
 - SUBPART B – FLIGHT
 - SUBPART C – STRENGTH REQUIREMENTS
 - SUBPART D – DESIGN AND CONSTRUCTION
 - SUBPART E – POWERPLANT
 - SUBPART F – EQUIPMENT
 - SUBPART G – OPERATING LIMITATIONS AND INFORMATION
- APPENDICES: A, B, C and D

BOOK 2 – ACCEPTABLE MEANS OF COMPLIANCE (AMC) and GUIDANCE MATERIAL (GM):

AMC AND GM

CS-27**PREAMBLE****CS-27 Amendment 9***Effective: See Decision 2021/016/R*

The following is a list of paragraphs affected by this amendment.

BOOK 1Subpart A

- Appendix C Amended (NPA 2021-01)

Subpart D

- CS 27.631 Created (NPA 2021-02)

Subpart F

- CS 27.1305 Amended (NPA 2021-01)
- CS 27.1337 Amended (NPA 2021-01)

BOOK 2

- AMC1 27.631 Created (NPA 2021-02)
- AMC1 27.1337(e) Created (NPA 2021-01)
- GM1 27.1337(e) Created (NPA 2021-01)

CS-27 Amendment 8*Effective: See Decision 2021/010/R*

The following is a list of paragraphs affected by this amendment.

BOOK 1Subpart F

- CS 27.1302 Created (NPA 2019-11)

BOOK 2

- AMC 27.1302 Created (NPA 2019-11)

CS-27

- AMC 27.1302 Appendix 1 Created (NPA 2019-11)
- GM1 27.1302 Created (NPA 2019-11)
- GM2 27.1302 Created (NPA 2019-11)

CS-27 Amendment 7 *Effective: See Decision 2020/006/R*

The following is a list of paragraphs affected by this Amendment.

Book 1Subpart F

- CS 27.1319 Created (NPA 2019-01)

Appendices

- CS-27 Appendix A Amended (NPA 2019/01)

Book 2

- AMC 27.1319 Created (NPA 2019-01)

CS-27 Amendment 6 *Effective: See Decision 2018/015/R*

The following is a list of paragraphs affected by this Amendment.

Book 2

- AMC 27 General Amended (Article 15 consultation with the ABs)
- AMC 27.45 Created (Article 15 consultation with the ABs)
- AMC 27.865 Amended (Article 15 consultation with the ABs)
- AMC No 1 to CS 27.865 Amended (Article 15 consultation with the ABs)
- AMC No 2 to CS 27.865 Amended (Article 15 consultation with the ABs)
- AMC No 3 to CS 27.865 Amended (Article 15 consultation with the ABs)
- AMC MG 1 Created (Article 15 consultation with the ABs)
- AMC MG 6 Amended (Article 15 consultation with the ABs)
- AMC MG 16 Created (Article 15 consultation with the ABs)
- AMC MG 17 Created (Article 15 consultation with the ABs)
- AMC MG 21 Created (Article 15 consultation with the ABs)
- AMC MG 23 Created (Article 15 consultation with the ABs)

CS-27

- AMC 27.1587(b)(3) Created (NPA 2016-01)

CS-27 Amendment 4 Effective: See Decision 2016/024/R

The following is a list of paragraphs affected by this Amendment.

Book 1Subpart A

- CS 27.1 Amended (editorial change)

Subpart D

- CS 27.610 Amended (NPA 2014-16)

Subpart F

- CS 27.1309 Amended (NPA 2014-16)
- CS 27.1316 Created (NPA 2014-16)
- CS 27.1317 Created (NPA 2014-16)

Subpart G

- CS 27.1501 Amended (NPA 2011-17)
- CS 27.1593 Created (NPA 2011-17)

Appendices

- CS-27 Appendix C Amended (NPA 2013-04)
- CS-27 Appendix D Created (NPA 2014-16)

Book 2

- AMC 27 General Amended (NPA 2013-04)
- AMC No 1 to CS 27.351 Created (NPA 2013-21)
- AMC No 2 to CS 27.351 Renamed and amended (NPA 2013-21)
- AMC 27.1593 Created (NPA 2011-17)
- AMC MG5 Created Agricultural Dispensing Equipment Installation (NPA 2013-04)
- AMC MG6 Emergency Medical Service (EMS) systems installations including: Interior arrangements, equipment, Helicopter Terrain Awareness and Warning System (HTAWS), Radio Altimeter, and Flight Data Monitoring System (NPA 2013-04)

CS-27**CS-27 Amendment 3****Effective: 18/12/2012**

The following is a list of paragraphs affected by this Amendment.

Book 1Subpart A

- CS 27.2 Amended (editorial change)

Subpart C

- CS 27.547 Amended (editorial change)
- CS 27.549 Amended (editorial change)
- CS 27.573 Created (NPA 2010-04)

Subpart D

- CS 27.865 Amended (editorial change)

Subpart F

- CS 27.1401 Amended (editorial change)

Subpart G

- CS 27.1521 Amended (editorial change)

Appendices

- CS-27 Appendix A Amended (NPA 2010-04)

CS-27 Amendment 2**Effective: 17/11/2008**

The following is a list of paragraphs affected by this Amendment.

Book 1Subpart F

- CS 27.1305 Amended (NPA 2007-17)

Appendices

- CS-27 Appendix A Amended (NPA 2007-17)
- CS-27 Appendix C Amended (NPA 2007-17)

Book 2

- AMC 27 General Amended (NPA 2007-17)
- AMC 27.351 Created (NPA 2007-17)
- AMC 27.602 Deleted (NPA 2007-17)
- AMC 27.865 Created (NPA 2007-17)
- AMC 27.1305(t) and (u) Deleted (NPA 2007-17)
- AMC MG4 Created (NPA 2007-17)

CS-27 Amendment 1**Effective: 30/11/2007**

The following is a list of paragraphs affected by this Amendment.

Book 1Subpart B

- CS 27.25 Amended (NPA 11/2006)
- CS 27.49 Created by renaming CS 27.73 (NPA 11/2006)
- CS 27.51 Amended (NPA 11/2006)
- CS 27.73 Deleted and moved to CS 27.49 (NPA 11/2006)
- CS 27.75 Amended (NPA 11/2006)
- CS 27.79 Amended (NPA 11/2006)
- CS 27.143 Amended (NPA 11/2006)
- CS 27.173 Amended (NPA 11/2006)
- CS 27.175 Amended (NPA 11/2006)
- CS 27.177 Amended (NPA 11/2006)

Subpart E

- CS 27.903 Amended (NPA 11/2006)

Subpart G

- CS 27.1587 Amended (NPA 11/2006)

Appendices

- CS-27 Appendix B Amended (NPA 11/2006)

CS-27 BOOK 1

CS-27

Book 1

Certification Specifications

Small Rotorcraft

CS-27 BOOK 1**SUBPART A – GENERAL****CS 27.1 Applicability**

(a) These Certification Specifications are applicable to small rotorcraft with maximum weights of 3 175 kg (7 000 lbs) or less and nine or less passenger seats.

(b) reserved

(c) Multi-engine rotorcraft may be type certificated as Category A provided the requirements referenced in Appendix C are met.

[Amdt 27/4]

CS 27.2 Special Retroactive Requirements

(a) reserved

(b) For rotorcraft with a certification basis established prior to 1 May 2001

(1) The maximum passenger seat capacity may be increased to eight or nine provided compliance is shown with all the airworthiness requirements in effect from the initial issue of CS-27.

INTENTIONALLY LEFT BLANK

(2) The maximum weight may be increased to greater than 2 722 kg (6 000 lbs) provided -

(i) The number of passenger seats is not increased above the maximum number previously certificated; or

(ii) Compliance is shown with all of the airworthiness requirements in effect from the initial issue of CS-27.

[Amdt 27/3]

CS-27 BOOK 1

SUBPART B – FLIGHT

GENERAL

CS 27.21 Proof of compliance

Each requirement of this Subpart must be met at each appropriate combination of weight and centre of gravity within the range of loading conditions for which certification is requested. This must be shown:

(a) By tests upon a rotorcraft of the type for which certification is requested or by calculations based on, and equal in accuracy to, the results of testing; and

(b) By systematic investigation of each required combination of weight and centre of gravity if compliance cannot be reasonably inferred from combinations investigated.

CS 27.25 Weight limits

(a) *Maximum weight.* The maximum weight, the highest weight at which compliance with each applicable requirement of this CS-27 is shown, must be established so that it is:

- (1) Not more than:
 - (i) The highest weight selected by the applicant;
 - (ii) The design maximum weight, the highest weight at which compliance with each applicable structural loading condition of this CS-27 is shown;
 - (iii) The highest weight at which compliance with each applicable flight requirement of this CS-27 is shown; or
 - (iv) The highest weight, as a function of altitude and temperature, in which the provisions of CS 27.79 and/or CS 27.143(c)(1) are demonstrated if the operating conditions (altitude and temperature) prescribed by those requirements can not be met; and

(2) Not less than the sum of:

- (i) The empty weight determined under CS 27.29;
- (ii) The weight of usable fuel appropriate to the intended operation with full payload;

(iii) The weight of full oil capacity; and

(iv) For each seat, an occupant weight of 77 kg (170 lbs) or any lower weight for which certification is requested.

(b) *Minimum weight.* The minimum weight, the lowest weight at which compliance with each applicable requirement of this CS-27 is shown, must be established so that it is:

(1) Not more than the sum of:

(i) The empty weight determined under CS 27.29; and

(ii) The weight of the minimum crew necessary to operate the rotorcraft, assuming for each crew member a weight no more than 77 kg (170 lbs), or any lower weight selected by the applicant or included in the loading instructions; and

(2) Not less than:

(i) The lowest weight selected by the applicant;

(ii) The design minimum weight, the lowest weight at which compliance with each applicable structural loading condition of this CS-27 is shown; or

(iii) The lowest weight at which compliance with each applicable flight requirement of this CS-27 is shown.

(c) *Total weight with jettisonable external load.* A total weight for the rotorcraft with a jettisonable external load attached that is greater than the maximum weight established under sub-paragraph (a) may be established for any rotorcraft-load combination if:

(1) The rotorcraft-load combination does not include human external cargo,

(2) Structural component approval for external load operations under either CS 27.865, or under equivalent operational standards is obtained,

(3) The portion of the total weight that is greater than the maximum weight established under sub-paragraph (a) is made up only of the weight of all or part of the jettisonable external load,

(4) Structural components of the rotorcraft are shown to comply with the applicable structural requirements of this CS-27 under the increased loads and stresses caused by the

CS-27 BOOK 1

weight increase over that established under sub-paragraph (a), and

(5) Operation of the rotorcraft at a total weight greater than the maximum certificated weight established under sub-paragraph (a) is limited by appropriate operating limitations under CS 27.865 (a) and (d).

[Amdt. No.: 27/1]

CS 27.27 Centre of gravity limits

The extreme forward and aft centres of gravity and, where critical, the extreme lateral centres of gravity must be established for each weight established under CS 27.25. Such an extreme may not lie beyond:

- (a) The extremes selected by the applicant;
- (b) The extremes within which the structure is proven; or
- (c) The extremes within which compliance with the applicable flight requirements is shown.

CS 27.29 Empty weight and corresponding centre of gravity

(a) The empty weight and corresponding centre of gravity must be determined by weighing the rotorcraft without the crew and payload but with:

- (1) Fixed ballast;
- (2) Unusable fuel; and
- (3) Full operating fluids, including:
 - (i) Oil;
 - (ii) Hydraulic fluid; and
 - (iii) Other fluids required for normal operation of rotorcraft systems, except water intended for injection in the engines.

(b) The condition of the rotorcraft at the time of determining empty weight must be one that is well defined and can be easily repeated, particularly with respect to the weights of fuel, oil, coolant, and installed equipment.

CS 27.31 Removable ballast

Removable ballast may be used in showing compliance with the flight requirements of this Subpart.

CS 27.33 Main rotor speed and pitch limits

(a) *Main rotor speed limits.* A range of main rotor speeds must be established that:

(1) With power-on, provides adequate margin to accommodate the variations in rotor speed occurring in any appropriate manoeuvre, and is consistent with the kind of governor or synchroniser used; and

(2) With power-off, allows each appropriate autorotative manoeuvre to be performed throughout the ranges of airspeed and weight for which certification is requested.

(b) *Normal main rotor high pitch limits (power-on).* For rotorcraft, except helicopters required to have a main rotor low speed warning under sub-paragraph (e). It must be shown, with power-on and without exceeding approved engine maximum limitations, that main rotor speeds substantially less than the minimum approved main rotor speed will not occur under any sustained flight condition. This must be met by:

- (1) Appropriate setting of the main rotor high pitch stop;
- (2) Inherent rotorcraft characteristics that make unsafe low main rotor speeds unlikely; or
- (3) Adequate means to warn the pilot of unsafe main rotor speeds.

(c) *Normal main rotor low pitch limits (power-off).* It must be shown, with power-off, that:

- (1) The normal main rotor low pitch limit provides sufficient rotor speed, in any autorotative condition, under the most critical combinations of weight and airspeed; and
- (2) It is possible to prevent overspeeding of the rotor without exceptional piloting skill.

(d) *Emergency high pitch.* If the main rotor high pitch stop is set to meet sub-paragraph (b)(1), and if that stop cannot be exceeded inadvertently, additional pitch may be made available for emergency use.

(e) *Main rotor low speed warning for helicopters.* For each single engine helicopter, and each multi-engine helicopter that does not have an approved device that automatically increases power on the operating engines when one engine fails, there must be a main rotor low speed warning which meets the following requirements:

- (1) The warning must be furnished to the pilot in all flight conditions, including power-on and power-off flight, when the speed of a main rotor approaches a value that can jeopardise safe flight.

CS-27 BOOK 1

(2) The warning may be furnished either through the inherent aerodynamic qualities of the helicopter or by a device.

(3) The warning must be clear and distinct under all conditions, and must be clearly distinguishable from all other warnings. A visual device that requires the attention of the crew within the cockpit is not acceptable by itself.

(4) If a warning device is used, the device must automatically de-activate and reset when the low-speed condition is corrected. If the device has an audible warning, it must also be equipped with a means for the pilot to manually silence the audible warning before the low-speed condition is corrected.

PERFORMANCE**CS 27.45 General**

(a) Unless otherwise prescribed, the performance requirements of this Subpart must be met for still air and a standard atmosphere.

(b) The performance must correspond to the engine power available under the particular ambient atmospheric conditions, the particular flight condition, and the relative humidity specified in sub-paragraphs (d) or (e), as appropriate.

(c) The available power must correspond to engine power, not exceeding the approved power, less:

(1) Installation losses; and

(2) The power absorbed by the accessories and services appropriate to the particular ambient atmospheric conditions and the particular flight condition.

(d) For reciprocating engine-powered rotorcraft, the performance, as affected by engine power, must be based on a relative humidity of 80% in a standard atmosphere.

(e) For turbine engine-powered rotorcraft, the performance, as affected by engine power, must be based on a relative humidity of:

(1) 80%, at and below standard temperature; and

(2) 34%, at and above standard temperature plus 28°C (50°F) between these two temperatures, the relative humidity must vary linearly.

(f) For turbine engine-powered rotorcraft, a means must be provided to permit the pilot to determine prior to take-off that each engine is capable of developing the power necessary to achieve the applicable rotorcraft performance prescribed in this Subpart.

CS 27.49 Performance at minimum operating speed

(a) For helicopters:

(1) The hovering ceiling must be determined over the ranges of weight, altitude, and temperature for which certification is requested, with:

(i) Take-off power; and

(ii) The landing gear extended; and

(iii) The helicopter in ground effect at a height consistent with normal take-off procedures; and

(2) The hovering ceiling determined in sub-paragraph (a)(1) of this paragraph must be at least:

(i) For reciprocating engine-powered helicopters, 1219 m (4 000 ft) at maximum weight with a standard atmosphere; or

(ii) For turbine engine-powered helicopters, 762 m (2 500 ft) pressure altitude at maximum weight at a temperature of standard +22°C (+40°F).

(3) The out-of-ground effect hovering performance must be determined over the ranges of weight, altitude, and temperature for which certification is requested, using take-off power.

(b) For rotorcraft other than helicopters, the steady rate of climb at the minimum operating speed must be determined, over the ranges of weight, altitude, and temperature for which certification is requested, with:

(1) Take-off power; and

(2) The landing gear extended.

[Amdt. No.: 27/1]

CS 27.51 Take-off

The take-off, with take-off power and rpm at the most critical center of gravity, and with weight from the maximum weight at sea-level to the weight for which take-off certification is requested for each altitude covered by this paragraph:

CS-27 BOOK 1

(a) May not require exceptional piloting skill or exceptionally favourable conditions throughout the ranges of altitude from standard sea-level conditions to the maximum altitude for which take-off and landing certification is requested, and

(b) Must be made in such a manner that a landing can be made safely at any point along the flight path if an engine fails. This must be demonstrated up to the maximum altitude for which take-off and landing certification is requested or 2134m (7,000 ft) density altitude, whichever is less.

[Amdt. No.: 27/1]

CS 27.65 Climb: all-engines-operating

(a) For rotorcraft other than helicopters:

(1) The steady rate of climb, at V_Y must be determined:

(i) With maximum continuous power on each engine;

(ii) With the landing gear retracted; and

(iii) For the weights, altitudes, and temperatures for which certification is requested; and

(2) The climb gradient, at the rate of climb determined in accordance with sub-paragraph (a)(1), must be either:

(i) At least 1:10 if the horizontal distance required to take off and climb over a 15 m (50 ft) obstacle is determined for each weight, altitude, and temperature within the range for which certification is requested; or

(ii) At least 1:6 under standard sea-level conditions.

(b) Each helicopter must meet the following requirements:

(1) V_Y must be determined:

(i) For standard sea-level conditions;

(ii) At maximum weight; and

(iii) With maximum continuous power on each engine.

(2) The steady rate of climb must be determined:

(i) At the climb speed selected by the applicant at or below V_{NE} ;

(ii) Within the range from sea-level up to the maximum altitude for which certification is requested;

(iii) For the weights and temperatures that correspond to the altitude range set forth in sub-paragraph (b)(2)(ii) and for which certification is requested; and

(iv) With maximum continuous power on each engine.

CS 27.67 Climb: one-engine-inoperative

For multi-engine helicopters, the steady rate of climb (or descent), at V_Y (or at the speed for minimum rate of descent), must be determined with:

(a) Maximum weight;

(b) The critical engine inoperative and the remaining engines at either:

(1) Maximum continuous power and, for helicopters for which certification for the use of 30-minute one engine inoperative (OEI) power is requested, at 30-minute OEI power; or

(2) Continuous OEI power for helicopters for which certification for the use of continuous OEI power is requested.

CS 27.71 Glide performance

For single-engine helicopters and multi-engine helicopters that do not meet the category A engine isolation requirements of CS-27, the minimum rate of descent airspeed and the best angle-of-glide airspeed must be determined in autorotation at:

(a) Maximum weight; and

(b) Rotor speed(s) selected by the applicant.

CS 27.75 Landing

(a) The rotorcraft must be able to be landed with no excessive vertical acceleration, no tendency to bounce, nose over, ground loop, porpoise, or water loop, and without exceptional piloting skill or exceptionally favourable conditions, with:

(1) Approach or autorotation speeds appropriate to the type of rotorcraft and selected by the applicant;

(2) The approach and landing made with:
(i) Power off, for single-engine rotorcraft and entered from steady state autorotation; or

CS-27 BOOK 1

(ii) One-engine inoperative (OEI) for multi-engine rotorcraft with each operating engine within approved operating limitations, and entered from an established OEI approach.;

(b) Multi-engine rotorcraft must be able to be landed safely after complete power failure under normal operating conditions.

[Amdt. No.: 27/1]

CS 27.79 Limiting height-speed envelope

(a) If there is any combination of height and forward speed, including hover, under which a safe landing cannot be made under the applicable power failure condition in sub-paragraph (b), a limiting height-speed envelope must be established, including all pertinent information, for that condition, throughout the ranges of:

(1) Altitude, from standard sea-level conditions to the maximum altitude capability of the rotorcraft, or 2134 m (7 000 ft) density altitude, whichever is less; and

(2) Weight from the maximum weight at sea-level to the weight selected by the applicant for each altitude covered by sub-paragraph (a)(1) of this paragraph. For helicopters, the weight at altitudes above sea-level may not be less than the maximum weight or the highest weight allowing hovering out of ground effect whichever is lower.

(b) The applicable power failure conditions are:

(1) For single-engine helicopters, full autorotation;

(2) For multi-engine helicopters, OEI, where engine isolation features ensure continued operation of the remaining engines, and the remaining engine(s) within approved limits and at the minimum installed specification power available for the most critical combination of approved ambient temperature and pressure altitude resulting in 2134m (7000 ft) density altitude or the maximum altitude capability of the helicopter, whichever is less; and

(3) For other rotorcraft, conditions appropriate to the type.

[Amdt. No.: 27/1]

FLIGHT CHARACTERISTICS**CS 27.141 General**

The rotorcraft must:

(a) Except as specifically required in the applicable paragraph, meet the flight characteristics requirements of this Subpart:

(1) At the altitudes and temperatures expected in operation;

(2) Under any critical loading condition within the range of weights and centres of gravity for which certification is requested;

(3) For power-on operations, under any condition of speed, power, and rotor rpm for which certification is requested; and

(4) For power-off operations, under any condition of speed and rotor rpm for which certification is requested that is attainable with the controls rigged in accordance with the approved rigging instructions and tolerances;

(b) Be able to maintain any required flight condition and make a smooth transition from any flight condition to any other flight condition without exceptional piloting skill, alertness, or strength, and without danger of exceeding the limit load factor under any operating condition probable for the type, including:

(1) Sudden failure of one engine, for multi-engine rotorcraft meeting category A engine isolation requirements of CS-29;

(2) Sudden, complete power failure for other rotorcraft; and

(3) Sudden, complete control system failures specified in CS 27.695; and

(c) Have any additional characteristic required for night or instrument operation, if certification for those kinds of operation is requested. Requirements for helicopter instrument flight are contained in appendix B.

CS 27.143 Controllability and manoeuvrability

(a) The rotorcraft must be safely controllable and manoeuvrable:

(1) During steady flight; and

(2) During any manoeuvre appropriate to the type, including:

(i) Take-off;

(ii) Climb;

(iii) Level flight;

CS-27 BOOK 1

- (iv) Turning flight;
 - (v) Autorotation;
 - (vi) Landing (power-on and power-off); and
 - (vii) Recovery to power-on flight from a bailed autorotative approach.
- (b) The margin of cyclic control must allow satisfactory roll and pitch control at V_{NE} with:
- (1) Critical weight;
 - (2) Critical centre of gravity;
 - (3) Critical rotor rpm; and
 - (4) Power off, except for helicopters demonstrating compliance with sub-paragraph (f), and power on.
- (c) Wind velocities from zero to at least 31 km/h (17 knots), from all azimuths, must be established in which the rotorcraft can be operated without loss of control on or near the ground in any manoeuvre appropriate to the type, such as crosswind take-offs, sideward flight and rearward flight:
- (1) With altitude, from standard sea-level conditions to the maximum take-off and landing altitude capability of the rotorcraft or 2134m (7000 ft) density altitude, whichever is less; with:
 - (i) Critical weight;
 - (ii) Critical centre of gravity; and
 - (iii) Critical rotor rpm.
 - (2) For take-off and landing altitudes above 2134m (7000 ft) density altitude with:
 - (i) Weight selected by the applicant;
 - (ii) Critical centre of gravity; and
 - (iii) Critical rotor rpm.
- (d) Wind velocities from zero to at least 31 km/h (17 knots), from all azimuths, must be established in which the rotorcraft can be operated without loss of control out-of-ground effect, with:
- (1) Weight selected by the applicant;
 - (2) Critical centre of gravity;
 - (3) Rotor rpm selected by the applicant; and
 - (4) Altitude, from standard sea-level conditions to the maximum take-off and landing altitude capability of the rotorcraft.
- (e) The rotorcraft, after

(1) failure of one engine in the case of multi-engine rotorcraft that meet Category A engine isolation requirements, or

(2) complete engine failure in the case of other rotorcraft, must be controllable over the range of speeds and altitudes for which certification is requested when such power failure occurs with maximum continuous power and critical weight. No corrective action time delay for any condition following power failure may be less than:

(i) For the cruise condition, one second, or normal pilot reaction time (whichever is greater); and

(ii) For any other condition, normal pilot reaction time.

(f) For helicopters for which a V_{NE} (power-off) is established under CS 27.1505 (c), compliance must be demonstrated with the following requirements with critical weight, critical centre of gravity, and critical rotor rpm:

(1) The helicopter must be safely slowed to V_{NE} (power-off), without exceptional pilot skill, after the last operating engine is made inoperative at power-on V_{NE} ;

(2) At a speed of 1.1 V_{NE} (power-off), the margin of cyclic control must allow satisfactory roll and pitch control with power off.

[Amdt. No.: 27/1]

CS 27.151 Flight controls

(a) Longitudinal, lateral, directional, and collective controls may not exhibit excessive breakout force, friction or preload.

(b) Control system forces and free play may not inhibit a smooth, direct rotorcraft response to control system input.

CS 27.161 Trim control

The trim control:

(a) Must trim any steady longitudinal, lateral, and collective control forces to zero in level flight at any appropriate speed; and

(b) May not introduce any undesirable discontinuities in control force gradients.

CS 27.171 Stability: general

CS-27 BOOK 1

The rotorcraft must be able to be flown, without undue pilot fatigue or strain, in any normal manoeuvre for a period of time as long as that expected in normal operation. At least three landings and take-offs must be made during this demonstration.

CS 27.173 Static longitudinal stability

(a) The longitudinal control must be designed so that a rearward movement of the control is necessary to obtain an airspeed less than the trim speed, and a forward movement of the control is necessary to obtain an airspeed more than the trim speed.

(b) Throughout the full range of altitude for which certification is requested, with the throttle and collective pitch held constant during the manoeuvres specified in CS 27.175(a) through (d), the slope of the control position versus airspeed curve must be positive. However, in limited flight conditions or modes of operation determined by the Agency to be acceptable, the slope of the control position versus airspeed curve may be neutral or negative if the rotorcraft possesses flight characteristics that allow the pilot to maintain airspeed within ± 9 km/h (± 5 knots) of the desired trim airspeed without exceptional piloting skill or alertness.

[Amdt. No.: 27/1]

CS 27.175 Demonstration of static longitudinal stability

(a) *Climb*. Static longitudinal stability must be shown in the climb condition at speeds from $V_Y - 19$ km/h (10 knots) to $V_Y + 19$ km/h (10 knots), with:

- (1) Critical weight;
- (2) Critical centre of gravity;
- (3) Maximum continuous power;
- (4) The landing gear retracted; and
- (5) The rotorcraft trimmed at V_Y .

(b) *Cruise*. Static longitudinal stability must be shown in the cruise condition at speeds from $0.8 V_{NE} - 19$ km/h (10 knots) to $0.8 V_{NE} + 19$ km/h (10 knots) or, if V_H is less than $0.8 V_{NE}$, from $V_H - 19$ km/h (10 knots) to $V_H + 19$ km/h (10 knots), with:

- (1) Critical weight;
- (2) Critical centre of gravity;
- (3) Power for level flight at $0.8 V_{NE}$ or V_H , whichever is less;
- (4) The landing gear retracted; and

(5) The rotorcraft trimmed at $0.8 V_{NE}$ or V_H , whichever is less.

(c) V_{NE} . Static longitudinal stability must be shown at speeds from $V_{NE} - 28$ km/h (20 knots) to V_{NE} with:

- (1) Critical weight;
- (2) Critical centre of gravity;
- (3) Power required for level flight at $V_{NE} - 19$ km/h (10 knots) or maximum continuous power, whichever is less;
- (4) The landing gear retracted; and
- (5) The rotorcraft trimmed at $V_{NE} - 19$ km/h (10 knots).

(d) *Autorotation*. Static longitudinal stability must be shown in autorotation at:

(1) Airspeeds from the minimum rate of descent airspeed $- 19$ km/h (10 knots) to the minimum rate of descent airspeed $+ 19$ km/h (10 knots), with:

- (i) Critical weight;
- (ii) Critical centre of gravity;
- (iii) The landing gear extended; and
- (iv) The rotorcraft trimmed at the minimum rate of descent airspeed.

(2) Airspeeds from the best angle-of-glide airspeed $- 19$ km/h (10 knots) to the best angle-of-glide airspeed $+ 19$ km/h (10 knots), with:

- (i) Critical weight;
- (ii) Critical centre of gravity;
- (iii) The landing gear retracted; and
- (iv) The rotorcraft trimmed at the best angle-of-glide airspeed.

[Amdt. No.: 27/1]

CS 27.177 Static directional stability

(a) The directional controls must operate in such a manner that the sense and direction of motion of the rotorcraft following control displacement are in the direction of the pedal motion with throttle and collective controls held constant at the trim conditions specified in CS 27.175 (a), (b), and (c). Sideslip angles must increase with steadily increasing directional control deflection for sideslip angles up to the lesser of:

- (1) ± 25 degrees from trim at a speed of 28 km/h (15 knots) less than the speed for minimum

CS-27 BOOK 1

rate of descent varying linearly to ± 10 degrees from trim at V_{NE} ;

(2) The steady-state sideslip angles established by CS 27.351;

(3) A sideslip angle selected by the applicant which corresponds to a sideforce of at least 0.1g; or,

(4) The sideslip angle attained by maximum directional control input.

(b) Sufficient cues must accompany the sideslip to alert the pilot when approaching sideslip limits.

(c) During the manoeuvre specified in subparagraph (a) of this paragraph, the sideslip angle versus directional control position curve may have a negative slope within a small range of angles around trim, provided the desired heading can be maintained without exceptional piloting skill or alertness.

[Amdt. No.: 27/1]

GROUND AND WATER HANDLING CHARACTERISTICS

CS 27.231 General

The rotorcraft must have satisfactory ground and water handling characteristics, including freedom from uncontrollable tendencies in any condition expected in operation.

CS 27.235 Taxying condition

The rotorcraft must be designed to withstand the loads that would occur when the rotorcraft is taxied over the roughest ground that may reasonably be expected in normal operation.

CS 27.239 Spray characteristics

If certification for water operation is requested, no spray characteristics during taxying, take-off, or landing may obscure the vision of the pilot or damage the rotors, propellers, or other parts of the rotorcraft.

CS 27.241 Ground resonance

The rotorcraft may have no dangerous tendency to oscillate on the ground with the rotor turning.

MISCELLANEOUS FLIGHT REQUIREMENTS

CS 27.251 Vibration

Each part of the rotorcraft must be free from excessive vibration under each appropriate speed and power condition.

CS-27 BOOK 1**SUBPART C – STRENGTH****GENERAL****CS 27.301 Loads**

(a) Strength requirements are specified in terms of limit loads (the maximum loads to be expected in service) and ultimate loads (limit loads multiplied by prescribed factors of safety). Unless otherwise provided, prescribed loads are limit loads.

(b) Unless otherwise provided, the specified air, ground, and water loads must be placed in equilibrium with inertia forces, considering each item of mass in the rotorcraft. These loads must be distributed to closely approximate or conservatively represent actual conditions.

(c) If deflections under load would significantly change the distribution of external or internal loads, this redistribution must be taken into account.

CS 27.303 Factor of safety

Unless otherwise provided, a factor of safety of 1.5 must be used. This factor applies to external and inertia loads unless its application to the resulting internal stresses is more conservative.

CS 27.305 Strength and deformation

(a) The structure must be able to support limit loads without detrimental or permanent deformation. At any load up to limit loads, the deformation may not interfere with safe operation.

(b) The structure must be able to support ultimate loads without failure. This must be shown by:

- (1) Applying ultimate loads to the structure in a static test for at least 3 seconds; or
- (2) Dynamic tests simulating actual load application.

CS 27.307 Proof of structure

(a) Compliance with the strength and deformation requirements of this Subpart must be shown for each critical loading condition accounting for the environment to which the structure will be exposed in operation. Structural analysis (static or fatigue) may be used only if the structure conforms to those structures for which experience has shown this method to be reliable. In other cases, substantiating load tests must be made.

(b) Proof of compliance with the strength requirements of this Subpart must include:

- (1) Dynamic and endurance tests of rotors, rotor drives, and rotor controls;
- (2) Limit load tests of the control system, including control surfaces;
- (3) Operation tests of the control system;
- (4) Flight stress measurement tests;
- (5) Landing gear drop tests; and
- (6) Any additional tests required for new or unusual design features.

CS 27.309 Design limitations

The following values and limitations must be established to show compliance with the structural requirements of this Subpart:

- (a) The design maximum weight.
- (b) The main rotor rpm ranges power on and power off.
- (c) The maximum forward speeds for each main rotor rpm within the ranges determined in subparagraph (b).
- (d) The maximum rearward and sideward flight speeds.
- (e) The centre of gravity limits corresponding to the limitations determined under subparagraphs (b), (c), and (d).
- (f) The rotational speed ratios between each powerplant and each connected rotating component.
- (g) The positive and negative limit manoeuvring load factors.

FLIGHT LOADS**CS 27.321 General**

(a) The flight load factor must be assumed to act normal to the longitudinal axis of the rotorcraft, and to be equal in magnitude and opposite in direction to the rotorcraft inertia load factor at the centre of gravity.

(b) Compliance with the flight load requirements of this Subpart must be shown:

CS-27 BOOK 1

(1) At each weight from the design minimum weight to the design maximum weight; and

(2) With any practical distribution of disposable load within the operating limitations in the Rotorcraft Flight Manual.

CS 27.337 Limit manoeuvring load factor

The rotorcraft must be designed for:

(a) A limit manoeuvring load factor ranging from a positive limit of 3.5 to a negative limit of – 1.0; or

(b) Any positive limit manoeuvring load factor not less than 2.0 and any negative limit manoeuvring load factor of not less than – 0.5 for which:

(1) The probability of being exceeded is shown by analysis and flight tests to be extremely remote; and

(2) The selected values are appropriate to each weight condition between the design maximum and design minimum weights.

CS 27.339 Resultant limit manoeuvring loads

The loads resulting from the application of limit manoeuvring load factors are assumed to act at the centre of each rotor hub and at each auxiliary lifting surface, and to act in directions, and with distributions of load among the rotors and auxiliary lifting surfaces, so as to represent each critical manoeuvring condition, including power-on and power-off flight with the maximum design rotor tip speed ratio. The rotor tip speed ratio is the ratio of the rotorcraft flight velocity component in the plane of the rotor disc to the rotational tip speed of the rotor blades, and is expressed as follows:

$$\mu = \frac{V \cos a}{\Omega R}$$

where:

V = The airspeed along the flight path;

a = The angle between the projection, in the plane of symmetry, of the axis of no feathering and a line perpendicular to the flight path (positive when the axis is pointing aft);

Ω = The angular velocity of rotor; and

R = The rotor radius.

CS 27.341 Gust loads

The rotorcraft must be designed to withstand, at each critical airspeed including hovering, the loads resulting from a vertical gust of 9.1 m/s (30 ft/s).

CS 27.351 Yawing conditions

(a) Each rotorcraft must be designed for the loads resulting from the manoeuvres specified in subparagraphs (b) and (c) with:

(1) Unbalanced aerodynamic moments about the centre of gravity which the aircraft reacts to in a rational or conservative manner considering the principal masses furnishing the reacting inertia forces; and

(2) Maximum main rotor speed.

(b) To produce the load required in subparagraph (a), in unaccelerated flight with zero yaw, at forward speeds from zero up to $0.6 V_{NE}$:

(1) Displace the cockpit directional control suddenly to the maximum deflection limited by the control stops or by the maximum pilot force specified in CS 27.397 (a);

(2) Attain a resulting sideslip angle or 90° , whichever is less; and

(3) Return the directional control suddenly to neutral.

(c) To produce the load required in subparagraph (a), in unaccelerated flight with zero yaw, at forward speeds from $0.6 V_{NE}$ up to V_{NE} or V_H , whichever is less:

(1) Displace the cockpit directional control suddenly to the maximum deflection limited by the control stops or by the maximum pilot force specified in CS 27.397 (a);

(2) Attain a resulting sideslip angle or 15° , whichever is less, at the lesser speed of V_{NE} or V_H ;

(3) Vary the sideslip angles of subparagraphs (b)(2) and (c)(2) directly with speed; and

(4) Return the directional control suddenly to neutral.

CS 27.361 Engine torque

(a) For turbine engines, the limit torque may not be less than the highest of:

(1) The mean torque for maximum continuous power multiplied by 1.25;

CS-27 BOOK 1

- (2) The torque required by CS 27.923;
- (3) The torque required by CS 27.927; or
- (4) The torque imposed by sudden engine stoppage due to malfunction or structural failure (such as compressor jamming).

(b) For reciprocating engines, the limit torque may not be less than the mean torque for maximum continuous power multiplied by:

- (1) 1.33, for engines with five or more cylinders; and
- (2) Two, three, and four, for engines with four, three, and two cylinders, respectively.

CONTROL SURFACE AND SYSTEM LOADS**CS 27.391 General**

Each auxiliary rotor, each fixed or movable stabilising or control surface, and each system operating any flight control must meet the requirements of CS 27.395, 27.397, 27.399, 27.411 and 27.427.

CS 27.395 Control system

(a) The part of each control system from the pilot's controls to the control stops must be designed to withstand pilot forces of not less than –

- (1) The forces specified in CS 27.397; or
- (2) If the system prevents the pilot from applying the limit pilot forces to the system, the maximum forces that the system allows the pilot to apply, but not less than 0.60 times the forces specified in CS 27.397.

(b) Each primary control system including its supporting structure, must be designed as follows:

- (1) The system must withstand loads resulting from the limit pilot forces prescribed in CS 27.397.
- (2) Notwithstanding sub-paragraph (b)(3), when power-operated actuator controls or power boost controls are used, the system must also withstand the loads resulting from the force output of each normally energised power device, including any single power boost or actuator system failure.

(3) If the system design or the normal operating loads are such that a part of the system cannot react to the limit forces prescribed in CS 27.397, that part of the system must be designed to withstand the maximum loads that can be

obtained in normal operation. The minimum design loads must, in any case, provide a rugged system for service use, including consideration of fatigue, jamming, ground gusts, control inertia and friction loads. In the absence of rational analysis, the design loads resulting from 0.60 of the specified limit pilot forces are acceptable minimum design loads.

(4) If operational loads may be exceeded through jamming, ground gusts, control inertia, or friction, the system must withstand the limit pilot forces specified in CS 27.397, without yielding.

CS 27.397 Limit pilot forces and torques

(a) Except as provided in sub-paragraph (b) the limit pilot forces are as follows:

- (1) For foot controls, 578 N (130 lbs).
- (2) For stick controls, 445 N (100 lbs) fore and aft, and 298 N (67 lbs) laterally.

(b) For flap, tab, stabiliser, rotor brake, and landing gear operating controls, the following apply:

- (1) Crank, wheel, and lever controls, $(25.4 + R) \times 2.919$ N, where R = radius in millimetres
- $$\left(\left[\frac{1+R}{3} \right] \times 50 \text{ lbs, where R =}$$

radius in inches), but not less than 222 N (50 lbs) nor more than 445 N (100 lbs) for hand-operated controls or 578 N (130 lbs) for foot-operated controls, applied at any angle within 20° of the plane of motion of the control.

- (2) Twist controls, $356 \times R$ Newton-millimetres, where R = radius in millimetres (80 x R inch-pounds where R = radius in inches).

CS 27.399 Dual control system

Each dual primary flight control system must be designed to withstand the loads that result when pilot forces of 0.75 times those obtained under CS 27.395 are applied –

- (a) In opposition; and
- (b) In the same direction.

CS 27.411 Ground clearance: tail rotor guard

(a) It must be impossible for the tail rotor to contact the landing surface during a normal landing.

(b) If a tail rotor guard is required to show compliance with sub-paragraph (a):

CS-27 BOOK 1

(1) Suitable design loads must be established for the guard; and

(2) The guard and its supporting structure must be designed to withstand those loads.

CS 27.427 Unsymmetrical loads

(a) Horizontal tail surfaces and their supporting structure must be designed for unsymmetrical loads arising from yawing and rotor wake effects in combination with the prescribed flight conditions.

(b) To meet the design criteria of sub-paragraph (a), in the absence of more rational data, both of the following must be met:

(1) 100% of the maximum loading from the symmetrical flight conditions acts on the surface on one side of the plane of symmetry and no loading acts on the other side.

(2) 50% of the maximum loading from the symmetrical flight conditions acts on the surface on each side of the plane of symmetry but in opposite directions.

(c) For empennage arrangements where the horizontal tail surfaces are supported by the vertical tail surfaces, the vertical tail surfaces and supporting structure must be designed for the combined vertical and horizontal surface loads resulting from each prescribed flight condition, considered separately. The flight conditions must be selected so the maximum design loads are obtained on each surface. In the absence of more rational data, the unsymmetrical horizontal tail surface loading distributions described in this paragraph must be assumed.

GROUND LOADS**CS 27.471 General**

(a) *Loads and equilibrium.* For limit ground loads –

(1) The limit ground loads obtained in the landing conditions in this Subpart must be considered to be external loads that would occur in the rotorcraft structure if it were acting as a rigid body; and

(2) In each specified landing condition, the external loads must be placed in equilibrium with linear and angular inertia loads in a rational or conservative manner.

(b) *Critical centres of gravity.* The critical centres of gravity within the range for which certification is requested must be selected so that the maximum design loads are obtained in each landing gear element.

CS 27.473 Ground loading conditions and assumptions

(a) For specified landing conditions, a design maximum weight must be used that is not less than the maximum weight. A rotor lift may be assumed to act through the centre of gravity throughout the landing impact. This lift may not exceed two-thirds of the design maximum weight.

(b) Unless otherwise prescribed, for each specified landing condition, the rotorcraft must be designed for a limit load factor of not less than the limit inertia load factor substantiated under CS 27.725.

CS 27.475 Tyres and shock absorbers

Unless otherwise prescribed, for each specified landing condition, the tyres must be assumed to be in their static position and the shock absorbers to be in their most critical position.

CS 27.477 Landing gear arrangement

Paragraphs CS 27.235, 27.479 to 27.485, and CS 27.493 apply to landing gear with two wheels aft, and one or more wheels forward, of the centre of gravity.

CS 27.479 Level landing conditions

(a) *Attitudes.* Under each of the loading conditions prescribed in sub-paragraph (b), the rotorcraft is assumed to be in each of the following level landing attitudes:

(1) An attitude in which all wheels contact the ground simultaneously.

(2) An attitude in which the aft wheels contact the ground with the forward wheels just clear of the ground.

(b) *Loading conditions.* The rotorcraft must be designed for the following landing loading conditions:

(1) Vertical loads applied under CS 27.471.

(2) The loads resulting from a combination of the loads applied under sub-paragraph (b)(1) with drag loads at each wheel of not less than 25% of the vertical load at that wheel.

CS-27 BOOK 1

(3) If there are two wheels forward, a distribution of the loads applied to those wheels under sub-paragraphs (b)(1) and (2) in a ratio of 40:60.

(c) *Pitching moments.* Pitching moments are assumed to be resisted by:

(1) In the case of the attitude in sub-paragraph (a)(1), the forward landing gear, and

(2) In the case of the attitude in sub-paragraph (a)(2), the angular inertia forces.

CS 27.481 Tail-down landing conditions

(a) The rotorcraft is assumed to be in the maximum nose-up attitude allowing ground clearance by each part of the rotorcraft.

(b) In this attitude, ground loads are assumed to act perpendicular to the ground.

CS 27.483 One-wheel landing conditions

For the one-wheel landing condition, the rotorcraft is assumed to be in the level attitude and to contact the ground on one aft wheel. In this attitude:

(a) The vertical load must be the same as that obtained on that side under CS 27.479(b)(1); and

(b) The unbalanced external loads must be reacted by rotorcraft inertia.

CS 27.485 Lateral drift landing conditions

(a) The rotorcraft is assumed to be in the level landing attitude, with:

(1) Side loads combined with one-half of the maximum ground reactions obtained in the level landing conditions of CS 27.479 (b) (1); and

(2) The loads obtained under sub-paragraph (a)(1) applied:

(i) At the ground contact point; or

(ii) For full-swivelling gear, at the centre of the axle.

(b) The rotorcraft must be designed to withstand, at ground contact –

(1) When only the aft wheels contact the ground, side loads of 0.8 times the vertical reaction acting inward on one side, and 0,6 times the vertical reaction acting outward on the other side, all combined with the vertical loads specified in sub-paragraph (a) ; and

(2) When all wheels contact the ground simultaneously:

(i) For the aft wheels, the side loads specified in sub-paragraph (b)(1); and

(ii) For the forward wheels, a side load of 0.8 times the vertical reaction combined with the vertical load specified in sub-paragraph (a).

CS 27.493 Braked roll conditions

Under braked roll conditions with the shock absorbers in their static positions:

(a) The limit vertical load must be based on a load factor of at least:

(1) 1.33, for the attitude specified in CS 27.479 (a)(1); and

(2) 1.0 for the attitude specified in CS 27.479 (a)(2); and

(b) The structure must be designed to withstand at the ground contact point of each wheel with brakes, a drag load at least the lesser of:

(1) The vertical load multiplied by a coefficient of friction of 0.8; and

(2) The maximum value based on limiting brake torque.

CS 27.497 Ground loading conditions: landing gear with tail wheels

(a) *General.* Rotorcraft with landing gear with two wheels forward, and one wheel aft, of the centre of gravity must be designed for loading conditions as prescribed in this paragraph.

(b) *Level landing attitude with only the forward wheels contacting the ground.* In this attitude:

(1) The vertical loads must be applied under CS 27.471 to 27.475;

(2) The vertical load at each axle must be combined with a drag load at that axle of not less than 25% of that vertical load; and

(3) Unbalanced pitching moments are assumed to be resisted by angular inertia forces.

(c) *Level landing attitude with all wheels contacting the ground simultaneously.* In this attitude, the rotorcraft must be designed for landing loading conditions as prescribed in sub-paragraph (b) .

CS-27 BOOK 1

(d) *Maximum nose-up attitude with only the rear wheel contacting the ground.* The attitude for this condition must be the maximum nose-up attitude expected in normal operation, including autorotative landings. In this attitude:

(1) The appropriate ground loads specified in sub-paragraphs (b)(1) and (2) must be determined and applied, using a rational method to account for the moment arm between the rear wheel ground reaction and the rotorcraft centre of gravity; or

(2) The probability of landing with initial contact on the rear wheel must be shown to be extremely remote.

(e) *Level landing attitude with only one forward wheel contacting the ground.* In this attitude, the rotorcraft must be designed for ground loads as specified in sub-paragraphs (b) (1) and (3).

(f) *Side loads in the level landing attitude.* In the attitudes specified in sub-paragraphs (b) and (c) the following apply:

(1) The side loads must be combined at each wheel with one-half of the maximum vertical ground reactions obtained for that wheel under sub-paragraphs (b) and (c). In this condition the side loads must be:

(i) For the forward wheels, 0.8 times the vertical reaction (on one side) acting inward, and 0.6 times the vertical reaction (on the other side) acting outward; and

(ii) For the rear wheel, 0.8 times the vertical reaction.

(2) The loads specified in sub-paragraph (f)(1) must be applied:

(i) At the ground contact point with the wheel in the trailing position (for non-full swivelling landing gear or for full-swivelling landing gear with a lock, steering device, or shimmy damper to keep the wheel in the trailing position); or

(ii) At the centre of the axle (for full swivelling landing gear without a lock, steering device, or shimmy damper).

(g) *Braked roll conditions in the level landing attitude.* In the attitudes specified in sub-paragraphs (b) and (c), and with shock absorbers in their static positions, the rotorcraft must be designed for braked roll loads as follows:

(1) The limit vertical load must be based on a limit vertical load factor of not less than:

(i) 1.0 for the attitude specified in sub-paragraph (b); and

(ii) 1.33, for the attitude specified in sub-paragraph (c).

(2) For each wheel with brakes, a drag load must be applied, at the ground contact point, of not less than the lesser of:

(i) 0.8 times the vertical load; and

(ii) The maximum based on limiting brake torque.

(h) *Rear wheel turning loads in the static ground attitude.* In the static ground attitude, and with the shock absorbers and tyres in their static positions, the rotorcraft must be designed for rear wheel turning loads as follows:

(1) A vertical ground reaction equal to the static load on the rear wheel must be combined with an equal side load.

(2) The load specified in sub-paragraph (h)(1) must be applied to the rear landing gear:

(i) Through the axle, if there is a swivel (the rear wheel being assumed to be swivelled 90° to the longitudinal axis of the rotorcraft); or

(ii) At the ground contact point, if there is a lock, steering device or shimmy damper (the rear wheel being assumed to be in the trailing position).

(i) *Taxying condition.* The rotorcraft and its landing gear must be designed for loads that would occur when the rotorcraft is taxied over the roughest ground that may reasonably be expected in normal operation.

CS 27.501 Ground loading conditions: landing gear with skids

(a) *General.* Rotorcraft with landing gear with skids must be designed for the loading conditions specified in this paragraph. In showing compliance with this paragraph, the following apply:

(1) The design maximum weight, centre of gravity, and load factor must be determined under CS 27.471 to 27.475.

(2) Structural yielding of elastic spring members under limit loads is acceptable.

(3) Design ultimate loads for elastic spring members need not exceed those obtained in a drop test of the gear with:

(i) A drop height of 1.5 times that specified in CS 27.725; and

CS-27 BOOK 1

(ii) An assumed rotor lift of not more than 1.5 times that used in the limit drop tests prescribed in CS 27.725.

(4) Compliance with sub-paragraphs (b) to (e) must be shown with:

(i) The gear in its most critically deflected position for the landing condition being considered; and

(ii) The ground reactions rationally distributed along the bottom of the skid tube.

(b) *Vertical reactions in the level landing attitude.* In the level attitude, and with the rotorcraft contacting the ground along the bottom of both skids, the vertical reactions must be applied as prescribed in sub-paragraph (a).

(c) *Drag reactions in the level landing attitude.* In the level attitude, and with the rotorcraft contacting the ground along the bottom of both skids, the following apply:

(1) The vertical reactions must be combined with horizontal drag reactions of 50% of the vertical reaction applied at the ground.

(2) The resultant ground loads must equal the vertical load specified in sub-paragraph (b).

(d) *Side loads in the level landing attitude.* In the level attitude, and with the rotorcraft contacting the ground along the bottom of both skids, the following apply:

(1) The vertical ground reaction must be:

(i) Equal to the vertical loads obtained in the condition specified in sub-paragraph (b); and

(ii) Divided equally among the skids.

(2) The vertical ground reactions must be combined with a horizontal sideload of 25% of their value.

(3) The total sideload must be applied equally between the skids and along the length of the skids.

(4) The unbalanced moments are assumed to be resisted by angular inertia.

(5) The skid gear must be investigated for:

(i) Inward acting sideloads; and

(ii) Outward acting sideloads.

(e) *One-skid landing loads in the level attitude.* In the level attitude, and with the rotorcraft contacting the ground along the bottom of one skid only, the following apply:

(1) The vertical load on the ground contact side must be the same as that obtained on that side in the condition specified in sub-paragraph (b).

(2) The unbalanced moments are assumed to be resisted by angular inertia.

(f) *Special conditions.* In addition to the conditions specified in sub-paragraphs (b) and (c), the rotorcraft must be designed for the following ground reactions:

(1) A ground reaction load acting up and aft at an angle of 45° to the longitudinal axis of the rotorcraft. This load must be:

(i) Equal to 1.33 times the maximum weight;

(ii) Distributed symmetrically among the skids;

(iii) Concentrated at the forward end of the straight part of the skid tube; and

(iv) Applied only to the forward end of the skid tube and its attachment to the rotorcraft.

(2) With the rotorcraft in the level landing attitude, a vertical ground reaction load equal to one-half of the vertical load determined in sub-paragraph (b). This load must be –

(i) Applied only to the skid tube and its attachment to the rotorcraft; and

(ii) Distributed equally over 33.3% of the length between the skid tube attachments and centrally located midway between the skid tube attachments.

CS 27.505 Ski landing conditions

If certification for ski operation is requested, the rotorcraft, with skis, must be designed to withstand the following loading conditions (where P is the maximum static weight on each ski with the rotorcraft at design maximum weight, and n is the limit load factor determined under CS 27.473(b)).

(a) Up-load conditions in which:

(1) A vertical load of Pn and a horizontal load of Pn/4 are simultaneously applied at the pedestal bearings; and

CS-27 BOOK 1

(2) A vertical load of 1.33 P is applied at the pedestal bearings.

(b) A side-load condition in which a side load of 0.35 P_n is applied at the pedestal bearings in a horizontal plane perpendicular to the centreline of the rotorcraft.

(c) A torque-load condition in which a torque load of 1.33 P (in foot pounds) is applied to the ski about the vertical axis through the centreline of the pedestal bearings.

WATER LOADS**CS 27.521 Float landing conditions**

If certification for float operation is requested, the rotorcraft, with floats, must be designed to withstand the following loading conditions (where the limit load factor is determined under CS 27.473 (b) or assumed to be equal to that determined for wheel landing gear):

(a) Up-load conditions in which:

(1) A load is applied so that, with the rotorcraft in the static level attitude, the resultant water reaction passes vertically through the centre of gravity; and

(2) The vertical load prescribed in sub-paragraph (a)(1) is applied simultaneously with an aft component of 0.25 times the vertical component.

(b) A side-load condition in which:

(1) A vertical load of 0.75 times the total vertical load specified in sub-paragraph (a)(1) is divided equally among the floats; and

(2) For each float, the load share determined under sub-paragraph (b)(1), combined with a total sload of 0.25 times the total vertical load specified in sub-paragraph (b)(1), is applied to the float only.

MAIN COMPONENT REQUIREMENTS**CS 27.547 Main rotor structure**

(a) Each main rotor assembly (including rotor hubs and blades) must be designed as prescribed in this paragraph.

(b) The main rotor structure must be designed to withstand the following loads prescribed in CS 27.337 to 27.341:

(1) Critical flight loads.

(2) Limit loads occurring under normal conditions of autorotation. For this condition, the rotor rpm must be selected to include the effects of altitude.

(c) The main rotor structure must be designed to withstand loads simulating:

(1) For the rotor blades, hubs, and flapping hinges, the impact force of each blade against its stop during ground operation; and

(2) Any other critical condition expected in normal operation.

(d) The main rotor structure must be designed to withstand the limit torque at any rotational speed, including zero. In addition:

(1) The limit torque need not be greater than the torque defined by a torque limiting device (where provided), and may not be less than the greater of:

(i) The maximum torque likely to be transmitted to the rotor structure in either direction; and

(ii) The limit engine torque specified in CS 27.361.

(2) The limit torque must be distributed to the rotor blades in a rational manner.

[Amdt No: 27/3]

CS 27.549 Fuselage, landing gear, and rotor pylon structures

(a) Each fuselage, landing gear, and rotor pylon structure must be designed as prescribed in this paragraph. Resultant rotor forces may be represented as a single force applied at the rotor hub attachment point.

(b) Each structure must be designed to withstand:

(1) The critical loads prescribed in CS 27.337 to 27.341;

(2) The applicable ground loads prescribed in CS 27.235, 27.471 to 27.485, CS 27.493, 27.497, 27.501, 27.505, and 27.521; and

(3) The loads prescribed in CS 27.547 (c)(2) and (d).

(c) Auxiliary rotor thrust, and the balancing air and inertia loads occurring under accelerated flight conditions, must be considered.

CS-27 BOOK 1

(d) Each engine mount and adjacent fuselage structure must be designed to withstand the loads occurring under accelerated flight and landing conditions, including engine torque.

[Amdt No: 27/3]

EMERGENCY LANDING CONDITIONS**CS 27.561 General**

(a) The rotorcraft, although it may be damaged in emergency landing conditions on land or water, must be designed as prescribed in this paragraph to protect the occupants under those conditions.

(b) The structure must be designed to give each occupant every reasonable chance of escaping serious injury in a crash landing when:

(1) Proper use is made of seats, belts, and other safety design provisions;

(2) The wheels are retracted (where applicable); and

(3) Each occupant and each item of mass inside the cabin that could injure an occupant is restrained when subjected to the following ultimate inertial load factors relative to the surrounding structure:

(i) Upward – 4 g

(ii) Forward – 16 g

(iii) Sideward – 8 g

(iv) Downward – 20 g, after the intended displacement of the seat device

(v) Rearward – 1.5 g

(c) The supporting structure must be designed to restrain, under any ultimate inertial load up to those specified in this paragraph, any item of mass above and/or behind the crew and passenger compartment that could injure an occupant if it came loose in an emergency landing. Items of mass to be considered include, but are not limited to, rotors, transmissions, and engines. The items of mass must be restrained for the following ultimate inertial load factors:

(1) Upward – 1.5 g

(2) Forward – 12 g

(3) Sideward – 6 g

(4) Downward – 12 g

(5) Rearward – 1.5 g

(d) Any fuselage structure in the area of internal fuel tanks below the passenger floor level must be designed to resist the following ultimate inertial factors and loads and to protect the fuel tanks from rupture when those loads are applied to that area:

(1) Upward – 1.5 g

(2) Forward – 4.0 g

(3) Sideward – 2.0 g

(4) Downward – 4.0 g

CS 27.562 Emergency landing dynamic conditions

(a) The rotorcraft, although it may be damaged in an emergency crash landing, must be designed to reasonably protect each occupant when:

(1) The occupant properly uses the seats, safety belts, and shoulder harnesses provided in the design; and

(2) The occupant is exposed to the loads resulting from the conditions prescribed in this paragraph.

(b) Each seat type design or other seating device approved for crew or passenger occupancy during take-off and landing must successfully complete dynamic tests or be demonstrated by rational analysis based on dynamic tests of a similar type seat in accordance with the following criteria. The tests must be conducted with an occupant, simulated by a 77 kg (170-pound) anthropomorphic test dummy (ATD), sitting in the normal upright position.

(1) A change in downward velocity of not less than 9.1 m/s (30 ft/s) when the seat or other seating device is oriented in its nominal position with respect to the rotorcraft's reference system, the rotorcraft's longitudinal axis is canted upward 60° with respect to the impact velocity vector, and the rotorcraft's lateral axis is perpendicular to a vertical plane containing the impact velocity vector and the rotorcraft's longitudinal axis. Peak floor deceleration must occur in not more than 0.031 seconds after impact and must reach a minimum of 30 g.

(2) A change in forward velocity of not less than 12.8 m/s (42 ft/s) when the seat or other seating device is oriented in its nominal position with respect to the rotorcraft's reference system, the rotorcraft's longitudinal axis is yawed 10° either right or left of the impact velocity vector

CS-27 BOOK 1

(whichever would cause the greatest load on the shoulder harness), the rotorcraft's lateral axis is contained in a horizontal plane containing the impact velocity vector, and the rotorcraft's vertical axis is perpendicular to a horizontal plane containing the impact velocity vector. Peak floor deceleration must occur in not more than 0.071 seconds after impact and must reach a minimum of 18.4 g.

(3) Where floor rails or floor or sidewall attachment devices are used to attach the seating devices to the airframe structure for the conditions of this paragraph, the rails or devices must be misaligned with respect to each other by at least 10° vertically (i.e. pitch out of parallel) and by at least a 10° lateral roll, with the directions optional, to account for possible floor warp.

(c) Compliance with the following must be shown:

(1) The seating device system must remain intact although it may experience separation intended as part of its design.

(2) The attachment between the seating device and the airframe structure must remain intact, although the structure may have exceeded its limit load.

(3) The ATD's shoulder harness strap or straps must remain on or in the immediate vicinity of the ATD's shoulder during the impact.

(4) The safety belt must remain on the ATD's pelvis during the impact.

(5) The ATD's head either does not contact any portion of the crew or passenger compartment, or if contact is made, the head impact does not exceed a head injury criteria (HIC) of 1000 as determined by this equation.

$$HIC = (t_2 - t_1) \left[\frac{1}{t_2 - t_1} \int_{t_1}^{t_2} a(t) dt \right]^{2.5}$$

Where: $a(t)$ is the resultant acceleration at the centre of gravity of the head form expressed as a multiple of g (the acceleration of gravity) and $t_2 - t_1$ is the time duration, in seconds, of major head impact, not to exceed 0.05 seconds.

(6) Loads in individual upper torso harness straps must not exceed 7784 N (1750 lbs). If dual straps are used for retaining the upper torso, the total harness strap loads must not exceed 8896 N (2000 lbs).

(7) The maximum compressive load measured between the pelvis and the lumbar column of the ATD must not exceed 6674 N (1500 lbs).

(d) An alternate approach that achieves an equivalent or greater level of occupant protection, as required by this paragraph, must be substantiated on a rational basis.

CS 27.563 Structural ditching and emergency flotation provisions

If certification with ditching provisions or if certification with emergency flotation provisions is requested by the applicant, structural strength must meet the requirements of this CS. If certification with ditching provisions is requested by the applicant, the requirements of CS 27.801(f) must also be met. The loading conditions apply to all parts of the rotorcraft, unless otherwise stated by this CS and CS 27.802(b).

(a) *Landing conditions.* The conditions considered must be those resulting from an emergency landing into the most severe sea conditions for which certification is requested by the applicant, at a forward ground speed not less than 15.4 m/s (30 knots), and a vertical speed not less than 1.5 m/s (5 ft/s), in likely pitch, roll and yaw attitudes. Rotor lift may be assumed to act through the centre of gravity during water entry. This lift may not exceed two-thirds of the design maximum weight.

(b) *Loads:*

(1) *Floats fixed or intended to be deployed before initial water contact.* The loads to be considered are those resulting from the rotorcraft entering the water, in the conditions defined in (a), and in accordance with flight manual procedures. In addition, each float, and its support and attaching structure, must be designed for the loads developed by a fully immersed float unless it can be shown that full immersion is unlikely. If full immersion is unlikely, the highest likely float buoyancy load must be applied. Appropriate air loads shall be used in substantiation of the floats and their attachment to the rotorcraft. For this purpose, the design airspeed for limit load is the maximum operating airspeed limit with fixed or deployed floats multiplied by 1.11.

In the case of approval with ditching provisions, water entry with deployable floats in the unintended stowed position must also be accounted for. It must be established that in such a case, damage to the un-deployed floats, attachments or surrounding structure, that would

CS-27 BOOK 1

prevent proper deployment and functioning of the floats, will not occur.

(2) *Floats intended to be deployed after initial water contact.* The loads to be considered are those resulting from the rotorcraft entering the water, in the conditions defined in (a), and in accordance with flight manual procedures. In addition, each float and its support and attaching structure must be designed for combined vertical and drag loads. The vertical load must be that developed by a fully immersed float, unless it can be shown that full immersion is unlikely. If full immersion is unlikely, the highest likely float buoyancy load must be applied. The drag load must be determined assuming a relative speed of 10.3 m/s (20 knots) between the rotorcraft and the water.

[Amdt No: 27/5]

FATIGUE EVALUATION

CS 27.571 Fatigue evaluation of flight structure

(a) *General.* Each portion of the flight structure (the flight structure includes rotors, rotor drive systems between the engines and the rotor hubs, controls, fuselage, landing gear, and their related primary attachments) the failure of which could be catastrophic, must be identified and must be evaluated under sub-paragraph (b), (c), (d), or (e). The following apply to each fatigue evaluation:

(1) The procedure for the evaluation must be approved.

(2) The locations of probable failure must be determined.

(3) In-flight measurement must be included in determining the following:

(i) Loads or stresses in all critical conditions throughout the range of limitations in CS 27.309, except that manoeuvring load factors need not exceed the maximum values expected in operation.

(ii) The effect of altitude upon these loads or stresses.

(4) The loading spectra must be as severe as those expected in operation including, but not limited to, external cargo operations, if applicable, and ground-air-ground cycles. The loading spectra must be based on loads or stresses determined under sub-paragraph (a)(3).

(b) *Fatigue tolerance evaluation.* It must be shown that the fatigue tolerance of the structure ensures that the probability of catastrophic fatigue failure is extremely remote without establishing replacement times, inspection intervals or other procedures under paragraph A27.4 of appendix A.

(c) *Replacement time evaluation.* It must be shown that the probability of catastrophic fatigue failure is extremely remote within a replacement time furnished under paragraph A27.4 of appendix A.

(d) *Fail-safe evaluation.* The following apply to fail-safe evaluation:

(1) It must be shown that all partial failures will become readily detectable under inspection procedures furnished under paragraph A27.4 of appendix A.

(2) The interval between the time when any partial failure becomes readily detectable under sub-paragraph (d)(1), and the time when any such failure is expected to reduce the remaining strength of the structure to limit or maximum attainable loads (whichever is less), must be determined.

(3) It must be shown that the interval determined under sub-paragraph (d)(2) is long enough, in relation to the inspection intervals and related procedures furnished under paragraph A27.4 of appendix A, to provide a probability of detection great enough to ensure that the probability of catastrophic failure is extremely remote.

(e) *Combination of replacement time and fail-safe evaluations.* A component may be evaluated under a combination of sub-paragraphs (c) and (d). For such component it must be shown that the probability of catastrophic failure is extremely remote with an approved combination of replacement time, inspection intervals, and related procedures furnished under paragraph A27.4 of appendix A.

CS 27.573 Damage tolerance and fatigue evaluation of composite structures

(a) Composite rotorcraft structure must be evaluated under the damage tolerance requirements of sub-paragraph (d) unless the applicant establishes that a damage tolerance evaluation is impractical within the limits of geometry, inspectability, and good design practice. In such a case, the composite rotorcraft structure must undergo a fatigue evaluation in accordance with sub-paragraph (e).

(b) Reserved

CS-27 BOOK 1

(c) Reserved

(d) Damage Tolerance Evaluation:

(1) Damage tolerance evaluations of composite structures must show that Catastrophic Failure due to static and fatigue loads is avoided throughout the operational life or prescribed inspection intervals of the rotorcraft.

(2) The damage tolerance evaluation must include PSEs of the airframe, main and tail rotor drive systems, main and tail rotor blades and hubs, rotor controls, fixed and movable control surfaces, engine and transmission mountings, landing gear, and any other detail design points or parts whose failure or detachment could prevent continued safe flight and landing.

(3) Each damage tolerance evaluation must include:

(i) The identification of the structure being evaluated;

(ii) A determination of the structural loads or stresses for all critical conditions throughout the range of limits in CS 27.309 (including altitude effects), supported by in-flight and ground measurements, except that manoeuvring load factors need not exceed the maximum values expected in service;

(iii) The loading spectra as severe as those expected in service based on loads or stresses determined under sub-paragraph (d)(3)(ii), including external load operations, if applicable, and other operations including high torque events;

(iv) A Threat Assessment for all structure being evaluated that specifies the locations, types, and sizes of damage, considering fatigue, environmental effects, intrinsic and discrete flaws, and impact or other accidental damage (including the discrete source of the accidental damage) that may occur during manufacture or operation;

(v) An assessment of the residual strength and fatigue characteristics of all structure being evaluated that supports the replacement times and inspection intervals established under sub-paragraph (d)(4); and

(vi) allowances for the detrimental effects of material, fabrication techniques, and process variability.

(4) Replacement times, inspections, or other procedures must be established to require

the repair or replacement of damaged parts to prevent Catastrophic Failure. These replacement times, inspections, or other procedures must be included in the Airworthiness Limitations Section of the Instructions for Continued Airworthiness required by CS 27.1529.

(i) Replacement times must be determined by tests, or by analysis supported by tests to show that throughout its life the structure is able to withstand the repeated loads of variable magnitude expected in-service. In establishing these replacement times, the following items must be considered:

(A) Damage identified in the Threat Assessment required by sub-paragraph (d)(3)(iv);

(B) Maximum acceptable manufacturing defects and in-service damage (i.e., those that do not lower the residual strength below ultimate design loads and those that can be repaired to restore ultimate strength); and

(C) Ultimate load strength capability after applying repeated loads.

(ii) Inspection intervals must be established to reveal any damage identified in the Threat Assessment required by sub-paragraph (d)(3)(iv) that may occur from fatigue or other in-service causes before such damage has grown to the extent that the component cannot sustain the required residual strength capability. In establishing these inspection intervals, the following items must be considered:

(A) The growth rate, including no-growth, of the damage under the repeated loads expected in-service determined by tests or analysis supported by tests; and

(B) The required residual strength for the assumed damage established after considering the damage type, inspection interval, detectability of damage, and the techniques adopted for damage detection. The minimum required residual strength is limit load.

(5) The effects of damage on stiffness, dynamic behaviour, loads and functional performance must be taken into account when

CS-27 BOOK 1

substantiating the maximum assumed damage size and inspection interval.

(e) Fatigue Evaluation:

If an applicant establishes that the damage tolerance evaluation described in sub-paragraph

(d) is impractical within the limits of geometry, inspectability, or good design practice, the applicant must do a fatigue evaluation of the particular composite rotorcraft structure and:

(1) Identify structure considered in the fatigue evaluation;

(2) Identify the types of damage considered in the fatigue evaluation;

(3) Establish supplemental procedures to minimise the risk of Catastrophic Failure associated with damage identified in sub-paragraph (e)(2); and

(4) Include these supplemental procedures in the Airworthiness Limitations section of the Instructions for Continued Airworthiness required by CS 27.1529.

CS-27 BOOK 1**SUBPART D — DESIGN AND CONSTRUCTION****GENERAL****CS 27.601 Design**

(a) The rotorcraft may have no design features or details that experience has shown to be hazardous or unreliable.

(b) The suitability of each questionable design detail and part must be established by tests.

CS 27.602 Critical parts

(a) Critical part - A critical part is a part, the failure of which could have a catastrophic effect upon the rotorcraft, and for which critical characteristics have been identified which must be controlled to ensure the required level of integrity.

(b) If the type design includes critical parts, a critical parts list shall be established. Procedures shall be established to define the critical design characteristics, identify processes that affect those characteristics, and identify the design change and process change controls necessary for showing compliance with the quality assurance requirements of Part-21.

CS 27.603 Materials

The suitability and durability of materials used for parts, the failure of which could adversely affect safety, must:

(a) Be established on the basis of experience or tests;

(b) Meet approved specifications that ensure their having the strength and other properties assumed in the design data; and

(c) Take into account the effects of environmental conditions, such as temperature and humidity, expected in service.

CS 27.605 Fabrication methods

(a) The methods of fabrication used must produce consistently sound structures. If a fabrication process (such as gluing, spot welding, or heat-treating) requires close control to reach this objective, the process must be performed according to an approved process specification.

(b) Each new aircraft fabrication method must be substantiated by a test program.

CS 27.607 Fasteners

(a) Each removable bolt, screw, nut, pin, or other fastener whose loss could jeopardise the safe operation of the rotorcraft must incorporate two separate locking devices. The fastener and its locking devices may not be adversely affected by the environmental conditions associated with the particular installation.

(b) No self-locking nut may be used on any bolt subject to rotation in operation unless a non-friction locking device is used in addition to the self-locking device.

CS 27.609 Protection of structure

Each part of the structure must:

(a) Be suitably protected against deterioration or loss of strength in service due to any cause, including:

- (1) Weathering;
- (2) Corrosion; and
- (3) Abrasion; and

(b) Have provisions for ventilation and drainage where necessary to prevent the accumulation of corrosive, flammable, or noxious fluids.

CS 27.610 Lightning and static electricity protection

(a) The rotorcraft must be protected against catastrophic effects from lightning.

(b) For metallic components, compliance with sub-paragraph (a) may be shown by:

- (1) Electrically bonding the components properly to the airframe; or
- (2) Designing the components so that a strike will not endanger the rotorcraft.

(c) For non-metallic components, compliance with sub-paragraph (a) may be shown by:

- (1) Designing the components to minimise the effect of a strike; or
- (2) Incorporating acceptable means of diverting the resulting electrical current so as not to endanger the rotorcraft.

(d) The electrical bonding and protection against lightning and static electricity must:

- (1) Minimise the accumulation of electrostatic charge;

CS-27 BOOK 1

(2) Minimise the risk of electric shock to crew, passengers, and service and maintenance personnel using normal precautions;

(3) Provide an electrical return path, under both normal and fault conditions, on rotorcraft having grounded electrical systems; and

(4) Reduce to an acceptable level the effects of static electricity on the functioning of essential electrical and electronic equipment.

[Amdt No: 27/4]

CS 27.611 Inspection provisions

There must be means to allow the close examination of each part that requires:

- (a) Recurring inspection;
- (b) Adjustment for proper alignment and functioning; or
- (c) Lubrication.

CS 27.613 Material strength properties and design values

(a) Material strength properties must be based on enough tests of material meeting specifications to establish design values on a statistical basis.

(b) Design values must be chosen to minimise the probability of structural failure due to material variability. Except as provided in sub-paragraphs (d) and (e), compliance with this paragraph must be shown by selecting design values that assure material strength with the following probability:

(1) Where applied loads are eventually distributed through a single member within an assembly, the failure of which would result in loss of structural integrity of the component, 99% probability with 95% confidence; and

(2) For redundant structure, those in which the failure of individual elements would result in applied loads being safely distributed to other load carrying members, 90% probability with 95% confidence.

(c) The strength, detail design, and fabrication of the structure must minimise the probability of disastrous fatigue failure, particularly at points of stress concentration.

(d) Material specifications must be those contained in documents accepted by the Agency.

(e) Other design values may be used if a selection of the material is made in which a specimen of each individual item is tested before use

and it is determined that the actual strength properties of that particular item will equal or exceed those used in design.

CS 27.619 Special factors

(a) The special factors prescribed in CS 27.621 to 27.625 apply to each part of the structure whose strength is:

- (1) Uncertain;
- (2) Likely to deteriorate in service before normal replacement; or
- (3) Subject to appreciable variability due to:
 - (i) Uncertainties in manufacturing processes; or
 - (ii) Uncertainties in inspection methods.

(b) For each part to which CS 27.621 to 27.625 apply, the factor of safety prescribed in CS 27.303 must be multiplied by a special factor equal to:

- (1) The applicable special factors prescribed in CS 27.621 to 27.625; or
- (2) Any other factor great enough to ensure that the probability of the part being understrength because of the uncertainties specified in sub-paragraph (a) is extremely remote.

CS 27.621 Casting factors

(a) *General.* The factors, tests, and inspections specified in sub-paragraphs (b) and (c) must be applied in addition to those necessary to establish foundry quality control. The inspections must meet approved specifications. Sub-paragraphs (c) and (d) apply to structural castings except castings that are pressure tested as parts of hydraulic or other fluid systems and do not support structural loads.

(b) *Bearing stresses and surfaces.* The casting factors specified in sub-paragraphs (c) and (d):

- (1) Need not exceed 1.25 with respect to bearing stresses regardless of the method of inspection used; and
- (2) Need not be used with respect to the bearing surfaces of a part whose bearing factor is larger than the applicable casting factor.

(c) *Critical castings.* For each casting whose failure would preclude continued safe flight and landing of the rotorcraft or result in serious injury to any occupant, the following apply:

CS-27 BOOK 1

- (1) Each critical casting must –
 - (i) Have a casting factor of not less than 1.25; and
 - (ii) Receive 100% inspection by visual, radiographic, and magnetic particle (for ferromagnetic materials) or penetrant (for non-ferromagnetic materials) inspection methods or approved equivalent inspection methods.

(2) For each critical casting with a casting factor less than 1.50, three sample castings must be static tested and shown to meet –

- (i) The strength requirements of CS 27.305 at an ultimate load corresponding to a casting factor of 1.25; and
- (ii) The deformation requirements of CS 27.305 at a load of 1.15 times the limit load.

(d) *Non-critical castings.* For each casting other than those specified in sub-paragraph (c), the following apply:

(1) Except as provided in sub-paragraphs (d)(2) and (3), the casting factors and corresponding inspections must meet the following table:

| Casting factor | Inspection |
|--------------------------------|--|
| 2.0 or greater..... | 100% visual |
| Less than 2.0 greater than 1.5 | 100% visual and magnetic particle (ferromagnetic materials), penetrant (non-ferromagnetic materials), or approved equivalent inspection methods. |
| 1.25 through 1.50..... | 100% visual, and magnetic particle (ferromagnetic materials), penetrant non-ferromagnetic materials), and radiographic or approved equivalent inspection methods |

(2) The percentage of castings inspected by nonvisual methods may be reduced below that specified in sub-paragraph (d)(1) when an approved quality control procedure is established.

(3) For castings procured to a specification that guarantees the mechanical properties of the material in the casting and provides for demonstration of these properties by test of coupons cut from the castings on a sampling basis:

- (i) A casting factor of 1.0 may be used; and

- (ii) The castings must be inspected as provided in sub-paragraph (d)(1) for casting factors of 1.25 to 1.50 and tested under sub-paragraph (c)(2).

CS 27.623 Bearing factors

(a) Except as provided in sub-paragraph (b), each part that has clearance (free fit), and that is subject to pounding or vibration, must have a bearing factor large enough to provide for the effects of normal relative motion.

(b) No bearing factor need be used on a part for which any larger special factor is prescribed.

CS 27.625 Fitting factors

For each fitting (part or terminal used to join one structural member to another) the following apply:

(a) For each fitting whose strength is not proven by limit and ultimate load tests in which actual stress conditions are simulated in the fitting and surrounding structures, a fitting factor of at least 1.15 must be applied to each part of:

- (1) The fitting;
- (2) The means of attachment; and
- (3) The bearing on the joined members.

(b) No fitting factor need be used:

- (1) For joints made under approved practices and based on comprehensive test data (such as continuous joints in metal plating, welded joints, and scarf joints in wood); and
- (2) With respect to any bearing surface for which a larger special factor is used.

(c) For each integral fitting, the part must be treated as a fitting up to the point at which the paragraph properties become typical of the member.

(d) Each seat, berth, litter, safety belt, and harness attachment to the structure must be shown by analysis, tests, or both, to be able to withstand the inertia forces prescribed in CS 27.561(b)(3) multiplied by a fitting factor of 1.33.

CS 27.629 Flutter

Each aerodynamic surface of the rotorcraft must be free from flutter under each appropriate speed and power condition.

CS-27 BOOK 1**CS 27.631 Bird strike**

(See AMC1 27.631)

Rotorcraft with six or more passenger seats must be designed to ensure a safe landing after a strike upon the windshield by a 1.0-kg (2.2-lb) bird when the velocity of the rotorcraft relative to the bird along the flight path of the rotorcraft is equal to V_{NE} or V_H 'True Airspeed' (TAS), whichever is less, at altitudes up to 2 438 m (8 000 ft). The applicant must demonstrate compliance through tests, or analysis based on tests that are carried out on sufficiently representative structures of similar design.

[Amdt No: 27/9]

ROTORS**CS 27.653 Pressure venting and drainage of rotor blades**

(a) For each rotor blade:

(1) There must be means for venting the internal pressure of the blade;

(2) Drainage holes must be provided for the blade; and

(3) The blade must be designed to prevent water from becoming trapped in it.

(b) Sub-paragraphs (a)(1) and (2) do not apply to sealed rotor blades capable of withstanding the maximum pressure differentials expected in service.

CS 27.659 Mass balance

(a) The rotors and blades must be mass balanced as necessary to –

(1) Prevent excessive vibration; and

(2) Prevent flutter at any speed up to the maximum forward speed.

(b) The structural integrity of the mass balance installation must be substantiated.

CS 27.661 Rotor blade clearance

There must be enough clearance between the rotor blades and other parts of the structure to prevent the blades from striking any part of the structure during any operating condition.

CS 27.663 Ground resonance prevention means

(a) The reliability of the means for preventing ground resonance must be shown either by analysis and tests, or reliable service experience, or by showing through analysis or tests that malfunction or failure of a single means will not cause ground resonance.

(b) The probable range of variations, during service, of the damping action of the ground resonance prevention means must be established and must be investigated during the test required by CS 27.241.

CONTROL SYSTEMS**CS 27.671 General**

(a) Each control and control system must operate with the ease, smoothness, and positiveness appropriate to its function.

(b) Each element of each flight control system must be designed, or distinctively and permanently marked, to minimise the probability of any incorrect assembly that could result in the malfunction of the system.

CS 27.672 Stability augmentation, automatic, and power-operated systems

If the functioning of stability augmentation or other automatic or power-operated systems is necessary to show compliance with the flight characteristics requirements of this CS-27, such systems must comply with CS 27.671 and the following:

(a) A warning which is clearly distinguishable to the pilot under expected flight conditions without requiring the pilot's attention must be provided for any failure in the stability augmentation system or in any other automatic or power-operated system which could result in an unsafe condition if the pilot is unaware of the failure. Warning systems must not activate the control systems.

(b) The design of the stability augmentation system or of any other automatic or power-operated system must allow initial counteraction of failures without requiring exceptional pilot skill or strength by overriding the failure by movement of the flight controls in the normal sense and deactivating the failed system.

CS-27 BOOK 1

(c) It must be shown that after any single failure of the stability augmentation system or any other automatic or power-operated system:

(1) The rotorcraft is safely controllable when the failure or malfunction occurs at any speed or altitude within the approved operating limitations;

(2) The controllability and manoeuvrability requirements of this CS-27 are met within a practical operational flight envelope (for example, speed, altitude, normal acceleration, and rotorcraft configurations) which is described in the Rotorcraft Flight Manual; and

(3) The trim and stability characteristics are not impaired below a level needed to permit continued safe flight and landing.

CS 27.673 Primary flight control

Primary flight controls are those used by the pilot for immediate control of pitch, roll, yaw, and vertical motion of the rotorcraft.

CS 27.674 Interconnected controls

Each primary flight control system must provide for safe flight and landing and operate independently after a malfunction, failure, or jam of any auxiliary interconnected control.

CS 27.675 Stops

(a) Each control system must have stops that positively limit the range of motion of the pilot's controls.

(b) Each stop must be located in the system so that the range of travel of its control is not appreciably affected by:

- (1) Wear;
- (2) Slackness; or
- (3) Take-up adjustments.

(c) Each stop must be able to withstand the loads corresponding to the design conditions for the system.

(d) For each main rotor blade:

(1) Stops that are appropriate to the blade design must be provided to limit travel of the blade about its hinge points; and

(2) There must be means to keep the blade from hitting the droop stops during any

operation other than starting and stopping the rotor.

CS 27.679 Control system locks

If there is a device to lock the control system with the rotorcraft on the ground or water, there must be means to:

- (a) Give unmistakable warning to the pilot when the lock is engaged; and
- (b) Prevent the lock from engaging in flight.

CS 27.681 Limit load static tests

(a) Compliance with the limit load requirements of this CS-27 must be shown by tests in which:

- (1) The direction of the test loads produces the most severe loading in the control system; and
- (2) Each fitting, pulley, and bracket used in attaching the system to the main structure is included.

(b) Compliance must be shown (by analyses or individual load tests) with the special factor requirements for control system joints subject to angular motion.

CS 27.683 Operation tests

It must be shown by operation tests that, when the controls are operated from the pilot compartment with the control system loaded to correspond with loads specified for the system, the system is free from:

- (a) Jamming;
- (b) Excessive friction; and
- (c) Excessive deflection.

CS 27.685 Control system details

(a) Each detail of each control system must be designed to prevent jamming, chafing, and interference from cargo, passengers, loose objects or the freezing of moisture.

(b) There must be means in the cockpit to prevent the entry of foreign objects into places where they would jam the system.

(c) There must be means to prevent the slapping of cables or tubes against other parts.

(d) Cable systems must be designed as follows:

CS-27 BOOK 1

(1) Cables, cable fittings, turnbuckles, splices and pulleys must be of an acceptable kind.

(2) The design of the cable systems must prevent any hazardous change in cable tension throughout the range of travel under any operating conditions and temperature variations.

(3) No cable smaller than 2.4 mm (3/32 inch) diameter may be used in any primary control system.

(4) Pulley kinds and sizes must correspond to the cables with which they are used.

(5) Pulleys must have close fitting guards to prevent the cables from being displaced or fouled.

(6) Pulleys must lie close enough to the plane passing through the cable to prevent the cable from rubbing against the pulley flange.

(7) No fairlead may cause a change in cable direction of more than 3°.

(8) No clevis pin subject to load or motion and retained only by cotter pins may be used in the control system.

(9) Turnbuckles attached to parts having angular motion must be installed to prevent binding throughout the range of travel.

(10) There must be means for visual inspection at each fairlead, pulley, terminal and turnbuckle.

(e) Control system joints subject to angular motion must incorporate the following special factors with respect to the ultimate bearing strength of the softest material used as a bearing:

(1) 3.33 for push-pull systems other than ball and roller bearing systems.

(2) 2.0 for cable systems.

(f) For control system joints, the manufacturer's static, non-Brinell rating of ball and roller bearings must not be exceeded.

CS 27.687 Spring devices

(a) Each control system spring device where failure could cause flutter or other unsafe characteristics must be reliable.

(b) Compliance with sub-paragraph (a) must be shown by tests simulating service conditions.

CS 27.691 Autorotation control mechanism

Each main rotor blade pitch control mechanism must allow rapid entry into autorotation after power failure.

CS 27.695 Power boost and power-operated control system

(a) If a power boost or power-operated control system is used, an alternate system must be immediately available that allows continued safe flight and landing in the event of:

(1) Any single failure in the power portion of the system; or

(2) The failure of all engines.

(b) Each alternate system may be a duplicate power portion or a manually operated mechanical system. The power portion includes the power source (such as hydraulic pumps), and such items as valves, lines, and actuators.

(c) The failure of mechanical parts (such as piston rods and links), and the jamming of power cylinders, must be considered unless they are extremely improbable.

LANDING GEAR**CS 27.723 Shock absorption tests**

The landing inertia load factor and the reserve energy absorption capacity of the landing gear must be substantiated by the tests prescribed in CS 27.725 and 27.727, respectively. These tests must be conducted on the complete rotorcraft or on units consisting of wheel, tyre, and shock absorber in their proper relation.

CS 27.725 Limit drop test

The limit drop test must be conducted as follows:

(a) The drop height must be –

(1) 0.33 m (13 inches) from the lowest point of the landing gear to the ground; or

(2) Any lesser height, not less than 0.20 m (8 in), resulting in a drop contact velocity equal to the greatest probable sinking speed likely to occur at ground contact in normal power-off landings.

(b) If considered, the rotor lift specified in CS 27.473(a) must be introduced into the drop test by

CS-27 BOOK 1

appropriate energy absorbing devices or by the use of an effective mass.

(c) Each landing gear unit must be tested in the attitude simulating the landing condition that is most critical from the standpoint of the energy to be absorbed by it.

(d) When an effective mass is used in showing compliance with sub-paragraph (b) the following formula may be used instead of more rational computations:

$$W_e = W \frac{h + (1-L)d}{h + d}; \text{ and } n = n_j \frac{W_e}{W} + L$$

where:

W_e = the effective weight to be used in the drop test .

$W=W_M$ for main gear units , equal to the static reaction on the particular unit with the rotorcraft in the most critical attitude. A rational method may be used in computing a main gear static reaction, taking into consideration the moment arm between the main wheel reaction and the rotorcraft centre of gravity.

$W=W_N$ for nose gear units , equal to the vertical component of the static reaction that would exist at the nose wheel, assuming that the mass of the rotorcraft acts at the centre of gravity and exerts a force of 1.0 g downward and 0.25 g forward.

$W=W_T$ for tailwheel units equal to whichever of the following is critical:

(1) The static weight on the tailwheel with the rotorcraft resting on all wheels; or

(2) The vertical component of the ground reaction that would occur at the tailwheel, assuming that the mass of the rotorcraft acts at the centre of gravity and exerts a force of 1 g downward with the rotorcraft in the maximum nose-up attitude considered in the nose-up landing conditions.

h = specified free drop height .

L = ratio of assumed rotor lift to the rotorcraft weight.

d = deflection under impact of the tyre (at the proper inflation pressure) plus the vertical component of the axle travel relative to the drop mass.

n = limit inertia load factor.

n_j = the load factor developed, during impact, on the mass used in the drop test (i.e., the

acceleration dv/dt in g recorded in the drop test plus 1.0).

CS 27.727 Reserve energy absorption drop test

The reserve energy absorption drop test must be conducted as follows:

(a) The drop height must be 1.5 times that specified in CS 27.725(a).

(b) Rotor lift, where considered in a manner similar to that prescribed in CS 27.725(b), may not exceed 1.5 times the lift allowed under that paragraph.

(c) The landing gear must withstand this test without collapsing. Collapse of the landing gear occurs when a member of the nose, tail, or main gear will not support the rotorcraft in the proper attitude or allows the rotorcraft structure, other than the landing gear and external accessories, to impact the landing surface.

CS 27.729 Retracting mechanism

For rotorcraft with retractable landing gear, the following apply:

(a) *Loads.* The landing gear, retracting mechanism, wheel-well doors, and supporting structure must be designed for –

(1) The loads occurring in any manoeuvring condition with the gear retracted;

(2) The combined friction, inertia, and air loads occurring during retraction and extension at any airspeed up to the design maximum landing gear operating speed; and

(3) The flight loads, including those in yawed flight, occurring with the gear extended at any airspeed up to the design maximum landing gear extended speed.

(b) *Landing gear lock.* A positive means must be provided to keep the gear extended.

(c) *Emergency operation.* When other than manual power is used to operate the gear, emergency means must be provided for extending the gear in the event of –

(1) Any reasonably probable failure in the normal retraction system; or

(2) The failure of any single source of hydraulic, electric, or equivalent energy.

CS-27 BOOK 1

(d) *Operation tests.* The proper functioning of the retracting mechanism must be shown by operation tests.

(e) *Position indicator.* There must be a means to indicate to the pilot when the gear is secured in the extreme positions.

(f) *Control.* The location and the operation of the retraction control must meet the requirements of CS 27.777 and 27.779.

(g) *Landing gear warning.* An aural or equally effective landing gear warning device must be provided that functions continuously when the rotorcraft is in a normal landing mode and the landing gear is not fully extended and locked. A manual shut-off capability must be provided for the warning device and the warning system must automatically reset when the rotorcraft is no longer in the landing mode.

CS 27.731 Wheels

(a) Each landing gear wheel must be approved.

(b) The maximum static load rating of each wheel may not be less than the corresponding static ground reaction with:

- (1) Maximum weight; and
- (2) Critical centre of gravity.

(c) The maximum limit load rating of each wheel must equal or exceed the maximum radial limit load determined under the applicable ground load requirements of this CS-27.

CS 27.733 Tyres

(a) Each landing gear wheel must have a tyre:

- (1) That is a proper fit on the rim of the wheel; and
- (2) Of the proper rating.

(b) The maximum static load rating of each tyre must equal or exceed the static ground reaction obtained at its wheel, assuming:

- (1) The design maximum weight; and
- (2) The most unfavourable centre of gravity.

(c) Each tyre installed on a retractable landing gear system must, at the maximum size of the tyre type expected in service, have a clearance to surrounding structure and systems that is adequate to prevent contact between the tyre and any part of the structure or systems.

CS 27.735 Brakes

For rotorcraft with wheel-type landing gear, a braking device must be installed that is:

- (a) Controllable by the pilot;
- (b) Usable during power-off landings; and
- (c) Adequate to:
 - (1) Counteract any normal unbalanced torque when starting or stopping the rotor; and
 - (2) Hold the rotorcraft parked on a 10° slope on a dry, smooth pavement.

CS 27.737 Skis

The maximum limit load rating of each ski must equal or exceed the maximum limit load determined under the applicable ground load requirements of this CS-27.

FLOATS AND HULLS**CS 27.751 Main float buoyancy**

(a) For main floats, the buoyancy necessary to support the maximum weight of the rotorcraft in fresh water must be exceeded by:

- (1) 50%, for single floats; and
- (2) 60%, for multiple floats.

(b) Each main float must have enough watertight compartments so that, with any single main float compartment flooded, the main floats will provide a margin of positive stability great enough to minimise the probability of capsizing.

CS 27.753 Main float design

(a) *Bag floats.* Each bag float must be designed to withstand:

- (1) The maximum pressure differential that might be developed at the maximum altitude for which certification with that float is requested; and
- (2) The vertical loads prescribed in CS 27.521(a), distributed along the length of the bag over three-quarters of its projected area.

(b) *Rigid floats.* Each rigid float must be able to withstand the vertical, horizontal, and side loads prescribed in CS 27.521. These loads may be distributed along the length of the float.

CS-27 BOOK 1**CS 27.755 Hulls**

For each rotorcraft, with a hull and auxiliary floats, that is to be approved for both taking off from and landing on water, the hull and auxiliary floats must have enough watertight compartments so that, with any single compartment flooded, the buoyancy of the hull and auxiliary floats (and wheel tyres if used) provides a margin of positive stability great enough to minimise the probability of capsizing.

**PERSONNEL AND CARGO
ACCOMMODATIONS**

CS 27.771 Pilot compartment

For each pilot compartment:

(a) The compartment and its equipment must allow each pilot to perform his duties without unreasonable concentration or fatigue;

(b) If there is provision for a second pilot, the rotorcraft must be controllable with equal safety from either pilot seat; and

(c) The vibration and noise characteristics of cockpit appurtenances may not interfere with safe operation.

CS 27.773 Pilot compartment view

(a) Each pilot compartment must be free from glare and reflections that could interfere with the pilot's view, and designed so that:

(1) Each pilot's view is sufficiently extensive, clear, and undistorted for safe operation; and

(2) Each pilot is protected from the elements so that moderate rain conditions do not unduly impair his view of the flight path in normal flight and while landing.

(b) If certification for night operation is requested, compliance with sub-paragraph (a) must be shown in night flight tests.

CS 27.775 Windshields and windows

Windshields and windows must be made of material that will not break into dangerous fragments.

CS 27.777 Cockpit controls

Cockpit controls must be:

(a) Located to provide convenient operation and to prevent confusion and inadvertent operation; and

(b) Located and arranged with respect to the pilots' seats so that there is full and unrestricted movement of each control without interference from the cockpit structure or the pilot's clothing when pilots from 1.57 m (5 ft 2 inches) to 1.83 m (6 ft) in height are seated.

CS 27.779 Motion and effect of cockpit controls

Cockpit controls must be designed so that they operate in accordance with the following movements and actuation:

(a) Flight controls, including the collective pitch control, must operate with a sense of motion which corresponds to the effect on the rotorcraft.

(b) Twist-grip engine power controls must be designed so that, for left-hand operation, the motion of the pilot's hand is clockwise to increase power when the hand is viewed from the edge containing the index finger. Other engine power controls, excluding the collective control, must operate with a forward motion to increase power.

(c) Normal landing gear controls must operate downward to extend the landing gear.

CS 27.783 Doors

(a) Each closed cabin must have at least one adequate and easily accessible external door.

(b) Each external door must be located where persons using it will not be endangered by the rotors, propellers, engine intakes and exhausts when appropriate operating procedures are used. If opening procedures are required, they must be the marked inside, on or adjacent to the door opening device.

(c) If certification with ditching provisions is requested by the applicant, any non-jettisonable doors intended for use after a ditching must have means to enable them to be secured in the open position and remain secure for emergency egress in all sea conditions for which ditching capability is requested by the applicant.

[Amdt No: 27/5]

CS-27 BOOK 1

CS 27.785 Seats, berths, safety belts, and harnesses

(a) Each seat, safety belt, harness, and adjacent part of the rotorcraft at each station designated for occupancy during take-off and landing must be free of potentially injurious objects, sharp edges, protuberances, and hard surfaces and must be designed so that a person making proper use of these facilities will not suffer serious injury in an emergency landing as a result of the static inertial load factors specified in CS 27.561(b) and dynamic conditions specified in CS 27.562.

(b) Each occupant must be protected from serious head injury by a safety belt plus a shoulder harness that will prevent the head from contacting any injurious object except as provided for in CS 27.562(c)(5). A shoulder harness (upper torso restraint), in combination with the safety belt, constitutes a torso restraint system as described in ETSO-C114.

(c) Each occupant's seat must have a combined safety belt and shoulder harness with a single-point release. Each pilot's combined safety belt and shoulder harness must allow each pilot when seated with safety belt and shoulder harness fastened, to perform all functions necessary for flight operations. There must be a means to secure belts and harnesses when not in use, to prevent interference with the operation of the rotorcraft and with rapid egress in an emergency.

(d) If seat backs do not have a firm handhold, there must be hand grips or rails along each aisle to enable the occupants to steady themselves while using the aisle in moderately rough air.

(e) Each projecting object that could injure persons seated or moving about in the rotorcraft in normal flight must be padded.

(f) Each seat and its supporting structure must be designed for an occupant weight of at least 77 kg (170 lbs) considering the maximum load factors, inertial forces, and reactions between the occupant, seat, and safety belt or harness corresponding with the applicable flight and ground-load conditions, including the emergency landing conditions of CS 27.561(b). In addition:

(1) Each pilot seat must be designed for the reactions resulting from the application of the pilot forces prescribed in CS 27.397; and

(2) The inertial forces prescribed in CS 27.561(b) must be multiplied by a factor of 1.33 in determining the strength of the attachment of:

(i) Each seat to the structure; and

(ii) Each safety belt or harness to the seat or structure.

(g) When the safety belt and shoulder harness are combined, the rated strength of the safety belt and shoulder harness may not be less than that corresponding to the inertial forces specified in CS 27.561(b), considering the occupant weight of at least 77 kg (170 lbs), considering the dimensional characteristics of the restraint system installation, and using a distribution of at least a 60% load to the safety belt and at least a 40% load to the shoulder harness. If the safety belt is capable of being used without the shoulder harness, the inertial forces specified must be met by the safety belt alone.

(h) When a headrest is used, the headrest and its supporting structure must be designed to resist the inertia forces specified in CS 27.561, with a 1.33 fitting factor and a head weight of at least 5.9 kg (13 lbs).

(i) Each seating device system includes the device such as the seat, the cushions, the occupant restraint system, and attachment devices.

(j) Each seating device system may use design features such as crushing or separation of certain parts of the seats to reduce occupant loads for the emergency landing dynamic conditions of CS 27.562; otherwise, the system must remain intact and must not interfere with rapid evacuation of the rotorcraft.

(k) For the purposes of this paragraph, a litter is defined as a device designed to carry a non-ambulatory person, primarily in a recumbent position, into and on the rotorcraft. Each berth or litter must be designed to withstand the load reaction of an occupant weight of at least 77 kg (170 lbs) when the occupant is subjected to the forward inertial factors specified in CS 27.561(b). A berth or litter installed within 15° or less of the longitudinal axis of the rotorcraft must be provided with a padded end-board, cloth diaphragm, or equivalent means that can withstand the forward load reaction. A berth or litter oriented greater than 15° with the longitudinal axis of the rotorcraft must be equipped with appropriate restraints, such as straps or safety belts, to withstand the forward load reaction. In addition –

(1) The berth or litter must have a restraint system and must not have corners or other protuberances likely to cause serious injury to a person occupying it during emergency landing conditions; and

(2) The berth or litter attachment and the occupant restraint system attachments to the structure must be designed to withstand the critical loads resulting from flight and ground load conditions and from the conditions

CS-27 BOOK 1

prescribed in CS 27.561(b). The fitting factor required by CS 27.625(d) shall be applied.

CS 27.787 Cargo and baggage compartments

(a) Each cargo and baggage compartment must be designed for its placarded maximum weight of contents and for the critical load distributions at the appropriate maximum load factors corresponding to the specified flight and ground load conditions, except the emergency landing conditions of CS 27.561.

(b) There must be means to prevent the contents of any compartment from becoming a hazard by shifting under the loads specified in sub-paragraph (a).

(c) Under the emergency landing conditions of CS 27.561, cargo and baggage compartments must:

(1) Be positioned so that if the contents break loose they are unlikely to cause injury to the occupants or restrict any of the escape facilities provided for use after an emergency landing; or

(2) Have sufficient strength to withstand the conditions specified in CS 27.561 including the means of restraint, and their attachments, required by sub-paragraph (b). Sufficient strength must be provided for the maximum authorised weight of cargo and baggage at the critical loading distribution.

(d) If cargo compartment lamps are installed, each lamp must be installed so as to prevent contact between lamp bulb and cargo.

CS 27.801 Ditching

(a) If certification with ditching provisions is requested by the applicant, the rotorcraft must meet the requirements of this CS and CS 27.563, CS 27.783(c), CS 27.805(c), CS 27.807(d), CS 27.1411, CS 27.1415, CS 27.1470, CS 27.1555(d) and CS 27.1561.

(b) Each practicable design measure, compatible with the general characteristics of the rotorcraft, must be taken to minimise the probability that when ditching, the behaviour of the rotorcraft would cause immediate injury to the occupants or would make it impossible for them to escape.

(c) An emergency flotation system that is stowed in a deflated condition during normal flight must:

(1) be designed such that the effects of a water impact (i.e. crash) on the emergency flotation system are minimised;

(2) have a means of automatic deployment following water entry.

(d) The probable behaviour of the rotorcraft during ditching water entry must be shown to exhibit no unsafe characteristics.

(e) The rotorcraft must be shown to resist capsize in the sea conditions selected by the applicant. The probability of capsizing in a 5-minute exposure to the sea conditions must be substantiated to be less than or equal to 3.0 % with a fully serviceable emergency flotation system and 30.0 % with the critical float compartment failed, with 95 % confidence.

Allowances must be made for probable structural damage and leakage.

(f) Unless the effects of the collapse of external doors and windows are accounted for in the investigation of the probable behaviour of the rotorcraft during ditching (as prescribed in (d) and (e)), the external doors and windows must be designed to withstand the probable maximum local pressures.

[Amdt No: 27/5]

CS 27.802 Emergency Flotation

If operating rules allow, and only certification for emergency flotation equipment is requested by the applicant, the rotorcraft must be designed as follows:

(a) The rotorcraft must be equipped with an approved emergency flotation system.

(b) The flotation units of the emergency flotation system, and their attachments to the rotorcraft, must comply with CS 27.563.

(c) The rotorcraft must be shown to resist capsize in the sea conditions selected by the applicant. The probability of capsizing in a 5-minute exposure to the sea conditions must be demonstrated to be less than or equal to 10.0 % with a fully serviceable emergency flotation system, with 95 % confidence. No demonstration of capsize resistance is required for the case of the critical float compartment having failed.

Allowances must be made for probable structural damage and leakage.

[Amdt No: 27/5]

CS-27 BOOK 1**CS 27.805 Flight crew emergency exits**

(a) For rotorcraft with passenger emergency exits that are not convenient to the flight crew, there must be flight crew emergency exits, on both sides of the rotorcraft or as a top hatch, in the flight crew area.

(b) Each flight crew emergency exit must be of sufficient size and must be located so as to allow rapid evacuation of the flight crew and must be marked so as to be readily located and operated even in darkness. This must be shown by test.

(c) *Underwater emergency exits for flight crew.* If certification with ditching provisions is requested by the applicant, none of the flight crew emergency exits required by (a) and (b) may be obstructed by water or flotation devices after an emergency landing on water and each exit must be shown by test, demonstration, or analysis to provide for rapid escape with the rotorcraft in the upright floating position or capsized. Each operational device (pull tab(s), operating handle, 'push here' decal, etc.) must be marked with black and yellow stripes and must be shown to be accessible for the range of flight crew heights as required by CS 27.777(b) and for both the case of an un-deformed seat and a seat with any deformation resulting from the test conditions required by CS 27.562. Flight crew emergency exits must be reasonably protected from becoming jammed as a result of fuselage deformation. The markings required by (b) must remain visible if the rotorcraft is capsized and the cabin is submerged.

[Amdt No: 27/5]

CS 27.807 Passenger emergency exits

(a) *Number and location.*

(1) There must be at least one emergency exit on each side of the cabin readily accessible to each passenger. One of these exits must be usable in any probable attitude that may result from a crash;

(2) Doors intended for normal use may also serve as emergency exits, provided that they meet the requirements of this CS; and

(3) If emergency flotation devices are installed, there must be an emergency exit accessible to each passenger on each side of the cabin that is shown by test, demonstration, or analysis to open without interference from flotation devices, whether stowed or deployed, and with the rotorcraft floating either upright or capsized.

(b) *Type and operation.* Each emergency exit prescribed by (a) or (d) must:

(1) Consist of a moveable window or panel, or additional external door, providing an unobstructed opening that will admit a 0.48 m by 0.66 m (19 inch by 26 inch) ellipse;

(2) Have simple and obvious methods of opening, from the inside and from the outside, which do not require exceptional effort;

(3) Be arranged and marked so as to be readily located and operated even in darkness; and

(4) Be reasonably protected from becoming jammed as a result of fuselage deformation.

(c) *Tests.* The proper functioning of each emergency exit must be shown by test.

(d) *Underwater emergency exits for passengers.* If certification with ditching provisions is requested by the applicant, underwater emergency exits must be provided in accordance with the following requirements and must be proven by test, demonstration, or analysis to provide for rapid escape with the rotorcraft in the upright floating position or capsized:

(1) One underwater emergency exit, meeting the size requirements of (b) above, must be installed in each side of the rotorcraft for each unit (or part of a unit) of four passenger seats. However, the seat-to-exit ratio may be increased for underwater emergency exits large enough to permit the simultaneous egress of two passengers side by side. Passenger seats must be located in relation to the underwater emergency exits in a way to best facilitate escape with the rotorcraft capsized and the cabin flooded.

(2) Underwater emergency exits, including their means of operation, markings, lighting and accessibility, must be designed for use in a flooded and capsized cabin.

(3) Each underwater emergency exit must be provided with a suitable handhold, or handholds adjacently located inside the cabin, to assist occupants in locating and operating the exit, as well as in egressing through the underwater emergency exit.

(4) The markings required by sub-paragraph (b)(3) must be designed to remain visible if the rotorcraft is capsized and the cabin is submerged.

(5) Each operational marking (pull tab(s), operating handle, 'push here' decal, etc.) must be marked with black and yellow stripes.

[Amdt No: 27/5]

CS-27 BOOK 1**CS 27.831 Ventilation**

(a) The ventilating system for the pilot and passenger compartments must be designed to prevent the presence of excessive quantities of fuel fumes and carbon monoxide.

(b) The concentration of carbon monoxide may not exceed one part in 20 000 parts of air during forward flight or hovering in still air. If the concentration exceeds this value under other conditions, there must be suitable operating restrictions.

CS 27.833 Heaters

Each combustion heater must be approved.

FIRE PROTECTION**CS 27.853 Compartment interiors**

For each compartment to be used by the crew or passengers:

(a) The materials must be at least flame resistant;

(b) (Reserved)

(c) If smoking is to be prohibited, there must be a placard so stating, and if smoking is to be allowed:

(1) There must be an adequate number of self-contained, removable ashtrays; and

(2) Where the crew compartment is separated from the passenger compartment, there must be at least one illuminated sign (using either letters or symbols) notifying all passengers when smoking is prohibited. Signs which notify when smoking is prohibited must:

(i) When illuminated, be legible to each passenger seated in the passenger cabin under all probable lighting conditions; and

(ii) Be so constructed that the crew can turn the illumination on and off.

CS 27.855 Cargo and baggage compartments

(a) Each cargo and baggage compartment must be constructed of, or lined with, materials that are at least:

(1) Flame resistant, in the case of compartments that are readily accessible to a crew member in flight; and

(2) Fire resistant, in the case of other compartments.

(b) No compartment may contain any controls, wiring, lines, equipment, or accessories whose damage or failure would affect safe operation, unless those items are protected so that:

(1) They cannot be damaged by the movement of cargo in the compartment; and

(2) Their breakage or failure will not create a fire hazard.

CS 27.859 Heating systems

(a) *General.* For each heating system that involves the passage of cabin air over, or close to, the exhaust manifold, there must be means to prevent carbon monoxide from entering any cabin or pilot compartment.

(b) *Heat exchangers.* Each heat exchanger must be:

(1) Of suitable materials;

(2) Adequately cooled under all conditions; and

(3) Easily disassembled for inspection.

(c) *Combustion heater fire protection.* Except for heaters which incorporate designs to prevent hazards in the event of fuel leakage in the heater fuel system, fire within the ventilating air passage, or any other heater malfunction, each heater zone must incorporate the fire protection features of the applicable requirements of CS 27.1183, 27.1185, 27.1189, 27.1191, and be provided with –

(1) Approved, quick-acting fire detectors in numbers and locations ensuring prompt detection of fire in the heater region.

(2) Fire extinguisher systems that provide at least one adequate discharge to all areas of the heater region.

(3) Complete drainage of each part of each zone to minimise the hazards resulting from failure or malfunction of any component containing flammable fluids. The drainage means must be:

(i) Effective under conditions expected to prevail when drainage is needed; and

(ii) Arranged so that no discharged fluid will cause an additional fire hazard.

CS-27 BOOK 1

(4) Ventilation, arranged so that no discharged vapours will cause an additional fire hazard.

(d) *Ventilating air ducts.* Each ventilating air duct passing through any heater region must be fireproof.

(1) Unless isolation is provided by fire-proof valves or by equally effective means, the ventilating air duct downstream of each heater must be fireproof for a distance great enough to ensure that any fire originating in the heater can be contained in the duct.

(2) Each part of any ventilating duct passing through any region having a flammable fluid system must be so constructed or isolated from that system that the malfunctioning of any component of that system cannot introduce flammable fluids or vapours into the ventilating airstream.

(e) *Combustion air ducts.* Each combustion air duct must be fireproof for a distance great enough to prevent damage from backfiring or reverse flame propagation.

(1) No combustion air duct may connect with the ventilating airstream unless flames from back-fires or reverse burning cannot enter the ventilating airstream under any operating condition, including reverse flow or malfunction of the heater or its associated components.

(2) No combustion air duct may restrict the prompt relief of any backfire that, if so restricted, could cause heater failure.

(f) *Heater control.* General. There must be means to prevent the hazardous accumulation of water or ice on or in any heater control component, control system tubing, or safety control.

(g) *Heater safety controls.* For each combustion heater, safety control means must be provided as follows:

(1) Means independent of the components provided for the normal continuous control of air temperature, airflow, and fuel flow must be provided for each heater to automatically shut off the ignition and fuel supply of that heater at a point remote from that heater when any of the following occurs:

(i) The heat exchanger temperature exceeds safe limits.

(ii) The ventilating air temperature exceeds safe limits.

(iii) The combustion airflow becomes inadequate for safe operation.

(iv) The ventilating airflow becomes inadequate for safe operation.

(2) The means of complying with sub-paragraph (g)(1) for any individual heater must:

(i) Be independent of components serving any other heater, the heat output of which is essential for safe operation; and

(ii) Keep the heater off until restarted by the crew.

(3) There must be means to warn the crew when any heater, the heat output of which is essential for safe operation, has been shut off by the automatic means prescribed in sub-paragraph (g)(1).

(h) *Air intakes.* Each combustion and heat-ventilating air intake must be located so that no flammable fluids or vapours can enter the heater system:

(1) During normal operation; or

(2) As a result of the malfunction of any other component.

(i) *Heater exhaust.* Each heater exhaust system must meet the requirements of CS 27.1121 and 27.1123.

(1) Each exhaust shroud must be sealed so that no flammable fluids or hazardous quantities of vapours can reach the exhaust system through joints.

(2) No exhaust system may restrict the prompt relief of any backfire that, if so restricted, could cause heater failure.

(j) *Heater fuel systems.* Each heater fuel system must meet the powerplant fuel system requirements affecting safe heater operation. Each heater fuel system component in the ventilating airstream must be protected by shrouds so that no leakage from those components can enter the ventilating airstream.

(k) *Drains.* There must be means for safe drainage of any fuel that might accumulate in the combustion chamber or the heat exchanger.

(1) Each part of any drain that operates at high temperatures must be protected in the same manner as heater exhausts.

(2) Each drain must be protected against hazardous ice accumulation under any operating condition.

CS-27 BOOK 1**CS 27.861 Fire protection of structure, controls, and other parts**

Each part of the structure, controls, rotor mechanism, and other parts essential to a controlled landing that would be affected by powerplant fires must be fireproof or protected so they can perform their essential functions for at least 5 minutes under any foreseeable powerplant fire conditions.

CS 27.863 Flammable fluid fire protection

(a) In each area where flammable fluids or vapours might escape by leakage of a fluid system, there must be means to minimise the probability of ignition of the fluids and vapours, and the resultant hazards if ignition does occur.

(b) Compliance with sub-paragraph (a) must be shown by analysis or tests, and the following factors must be considered:

(1) Possible sources and paths of fluid leakage, and means of detecting leakage.

(2) Flammability characteristics of fluids, including effects of any combustible or absorbing materials.

(3) Possible ignition sources, including electrical faults, over-heating of equipment, and malfunctioning of protective devices.

(4) Means available for controlling or extinguishing a fire, such as stopping flow of fluids, shutting down equipment, fireproof containment, or use of extinguishing agents.

(5) Ability of rotorcraft components that are critical to safety of flight to withstand fire and heat.

(c) If action by the flight crew is required to prevent or counteract a fluid fire (e.g. equipment shutdown or actuation of a fire extinguisher) quick acting means must be provided to alert the crew.

(d) Each area where flammable fluids or vapours might escape by leakage of a fluid system must be identified and defined.

EXTERNAL LOADS**CS 27.865 External loads**

(a) It must be shown by analysis, test, or both, that the rotorcraft external-load attaching means for rotorcraft-load combinations to be used for non-human external cargo applications can withstand a limit static load equal to 2.5, or some lower load

factor approved under CS 27.337 through 27.341, multiplied by the maximum external load for which authorisation is requested. It must be shown by analysis, test, or both that the rotorcraft external-load attaching means and any complex personnel-carrying device system for rotorcraft-load combinations to be used for human external cargo applications can withstand a limit static load equal to 3.5 or some lower load factor, not less than 2.5, approved under CS 27.337 through 27.341, multiplied by the maximum external load for which authorisation is requested. The load for any rotorcraft-load combination class, for any external cargo type, must be applied in the vertical direction. For jettisonable rotorcraft-load combinations, for any applicable external cargo type, the load must also be applied in any direction making the maximum angle with the vertical that can be achieved in service but not less than 30°. However, the 30° angle may be reduced to a lesser angle if:

(1) An operating limitation is established limiting external load operations to those angles for which compliance with this paragraph has been shown; or

(2) It is shown that the lesser angle can not be exceeded in service.

(b) The external-load attaching means, for jettisonable rotorcraft-load combinations, must include a quick-release system (QRS) to enable the pilot to release the external load quickly during flight. The QRS must consist of a primary quick-release subsystem and a backup quick-release subsystem that are isolated from one another. The QRS, and the means by which it is controlled, must comply with the following:

(1) A control for the primary quick-release subsystem must be installed either on one of the pilot's primary controls or in an equivalently accessible location and must be designed and located so that it may be operated by either the pilot or a crew member without hazardously limiting the ability to control the rotorcraft during an emergency situation.

(2) A control for the backup quick-release subsystem, readily accessible to either the pilot or another crew member, must be provided.

(3) Both the primary and backup quick-release subsystems must:

(i) Be reliable, durable, and function properly with all external loads up to and including the maximum external limit load for which authorisation is requested.

(ii) Be protected against electromagnetic interference (EMI) from

CS-27 BOOK 1

external and internal sources and against lightning to prevent inadvertent load release.

(A) The minimum level of protection required for jettisonable rotorcraft-load combinations used for non-human external cargo is a radio frequency field strength of 20 volts per metre.

(B) The minimum level of protection required for jettisonable rotorcraft-load combinations used for human external cargo is a radio frequency field strength of 200 volts per metre.

(iii) Be protected against any failure that could be induced by a failure mode of any other electrical or mechanical rotorcraft system.

(c) For rotorcraft-load combinations to be used for human external cargo applications, the rotorcraft must:

(1) For jettisonable external loads, have a QRS that meets the requirements of subparagraph (b) and that:

(i) Provides a dual actuation device for the primary quick-release subsystem, and

(ii) Provides a separate dual actuation device for the backup quick-release subsystem.

(2) Enable the safe utilisation of complex personnel-carrying device systems to transport occupants external to the helicopter or to restrain occupants inside the cabin. A personnel-carrying device system is considered complex if:

(i) it does not meet a European Norm (EN) standard under Directive 89/686/EEC¹ or Regulation (EU) 2016/425², as applicable, or subsequent revision;

(ii) it is designed to restrain more than a single person (e.g. a hoist or cargo hook operator, photographer, etc.) inside the cabin, or to restrain more than two persons outside the cabin; or

(iii) it is a rigid structure such as a cage, a platform or a basket.

Complex personnel-carrying device systems shall be reliable and have the structural capability and personnel safety features essential for external occupant safety through compliance with the specific requirements of CS 27.865, CS 27.571 and other relevant requirements of CS-27 for the proposed operating envelope.

(3) Have placards and markings at all appropriate locations that clearly state the essential system operating instructions and, for complex personnel-carrying device systems, ingress and egress instructions.

(4) Have equipment to allow direct intercommunication among required crew members and external occupants.

(5) Have the appropriate limitations and procedures incorporated in the flight manual for conducting human external cargo operations.

(6) For human external cargo applications requiring use of Category A rotorcraft, have one-engine-inoperative hover performance data and procedures in the flight manual for the weights, altitudes, and temperatures for which external load approval is requested.

(d) The critically configured jettisonable external loads must be shown by a combination of analysis, ground tests, and flight tests to be both transportable and releasable throughout the approved operational envelope without hazard to the rotorcraft during normal flight conditions. In addition, these external loads must be shown to be releasable without hazard to the rotorcraft during emergency flight conditions.

(e) A placard or marking must be installed next to the external-load attaching means stating the maximum authorised external load as demonstrated under CS 27.25 and this paragraph.

(f) The fatigue evaluation of CS 27.571 does not apply to rotorcraft-load combinations to be used for non-human external cargo except for the failure of critical structural elements that would result in a hazard to the rotorcraft. For rotorcraft-load combinations to be used for human external cargo, the fatigue evaluation of CS 27.571 applies to the entire quick-release and complex personnel-carrying device structural systems and their attachments.

[Amdt No: 27/3]

[Amdt No: 27/5]

¹ Council Directive 89/686/EEC of 21 December 1989 on the approximation of the laws of the Member States relating to personal protective equipment (OJ L 399, 30.12.1989, p. 18).

² Regulation (EU) 2016/425 of the European Parliament and of the Council of 9 March 2016 on personal protective equipment and repealing Council Directive 89/686/EEC (OJ L 81, 31.3.2016, p. 51).

CS-27 BOOK 1

MISCELLANEOUS

CS 27.871 Levelling marks

There must be reference marks for levelling the rotorcraft on the ground.

CS 27.873 Ballast provisions

Ballast provisions must be designed and constructed to prevent inadvertent shifting of ballast in flight.

CS-27 BOOK 1

SUBPART E – POWERPLANT

GENERAL

CS 27.901 Installation

(a) For the purpose of this CS-27, the powerplant installation includes each part of the rotorcraft (other than the main and auxiliary rotor structures) that:

- (1) Is necessary for propulsion;
- (2) Affects the control of the major propulsive units; or
- (3) Affects the safety of the major propulsive units between normal inspections or overhauls.

(b) For each powerplant installation:

- (1) Each component of the installation must be constructed, arranged, and installed to ensure its continued safe operation between normal inspections or overhauls for the range of temperature and altitude for which approval is requested;
- (2) Accessibility must be provided to allow any inspection and maintenance necessary for continued airworthiness;
- (3) Electrical interconnections must be provided to prevent differences of potential between major components of the installation and the rest of the rotorcraft;
- (4) Axial and radial expansion of turbine engines may not affect the safety of the installation; and
- (5) Design precautions must be taken to minimise the possibility of incorrect assembly of components and equipment essential to safe operation of the rotorcraft, except where operation with the incorrect assembly can be shown to be extremely improbable.

(c) The installation must comply with:

- (1) The installation instructions provided under CS-E; and
- (2) The applicable provisions of this Subpart.

CS 27.903 Engines

(a) (Reserved)

(b) *Engine or drive system cooling fan blade protection.*

(1) If an engine or rotor drive system cooling fan is installed, there must be means to protect the rotorcraft and allow a safe landing if a fan blade fails. This must be shown by showing that:

(i) The fan blades are contained in case of failure;

(ii) Each fan is located so that a failure will not jeopardise safety; or

(iii) Each fan blade can withstand an ultimate load of 1.5 times the centrifugal force resulting from operation limited by the following:

(A) For fans driven directly by the engine:

(1) The terminal engine rpm under uncontrolled conditions; or

(2) An overspeed limiting device.

(B) For fans driven by the rotor drive system the maximum rotor drive system rotational speed to be expected in service, including transients.

(2) Unless a fatigue evaluation under CS 27.571 is conducted, it must be shown that cooling fan blades are not operating at resonant conditions within the operating limits of the rotorcraft.

(c) *Turbine engine installation.* For turbine engine installations, the powerplant systems associated with engine control devices, systems, and instrumentation must be designed to give reasonable assurance that those engine operating limitations that adversely affect turbine rotor structural integrity will not be exceeded in service.

(d) *Restart capability:* A means to restart any engine in flight must be provided.

(1) Except for the in-flight shutdown of all engines, engine restart capability must be demonstrated throughout a flight envelope for the rotorcraft.

CS-27 BOOK 1

(2) Following the in-flight shutdown of all engines, in-flight engine restart capability must be provided.

[Amdt. No.: 27/1]

CS 27.907 Engine vibration

(a) Each engine must be installed to prevent the harmful vibration of any part of the engine or rotorcraft.

(b) The addition of the rotor and the rotor drive system to the engine may not subject the principal rotating parts of the engine to excessive vibration stresses. This must be shown by a vibration investigation.

(c) No part of the rotor drive system may be subjected to excessive vibration stresses.

ROTOR DRIVE SYSTEM**CS 27.917 Design**

(a) Each rotor drive system must incorporate a unit for each engine to automatically disengage that engine from the main and auxiliary rotors if that engine fails.

(b) Each rotor drive system must be arranged so that each rotor necessary for control in autorotation will continue to be driven by the main rotors after disengagement of the engine from the main and auxiliary rotors.

(c) If a torque limiting device is used in the rotor drive system, it must be located so as to allow continued control of the rotorcraft when the device is operating.

(d) The rotor drive system includes any part necessary to transmit power from the engines to the rotor hubs. This includes gear boxes, shafting, universal joints, couplings, rotor brake assemblies, clutches, supporting bearings for shafting, any attendant accessory pads or drives, and any cooling fans that are a part of, attached to, or mounted on the rotor drive system.

CS 27.921 Rotor brake

If there is a means to control the rotation of the rotor drive system independently of the engine, any limitations on the use of that means must be

specified, and the control for that means must be guarded to prevent inadvertent operation.

CS 27.923 Rotor drive system and control mechanism tests

(a) Each part tested as prescribed in this paragraph must be in a serviceable condition at the end of the tests. No intervening disassembly which might affect test results may be conducted.

(b) Each rotor drive system and control mechanism must be tested for not less than 100 hours. The test must be conducted on the rotorcraft, and the torque must be absorbed by the rotors to be installed, except that other ground or flight test facilities with other appropriate methods of torque absorption may be used if the conditions of support and vibration closely simulate the conditions that would exist during a test on the rotorcraft.

(c) A 60-hour part of the test prescribed in sub-paragraph (b) must be run at not less than maximum continuous torque and the maximum speed for use with maximum continuous torque. In this test, the main rotor controls must be set in the position that will give maximum longitudinal cyclic pitch change to simulate forward flight. The auxiliary rotor controls must be in the position for normal operation under the conditions of the test.

(d) A 30-hour or, for rotorcraft for which the use of either 30-minute OEI power or continuous OEI power is requested, a 25-hour part of the test prescribed in sub-paragraph (b) must be run at not less than 75% of maximum continuous torque and the minimum speed for use with 75% of maximum continuous torque. The main and auxiliary rotor controls must be in the position for normal operation under the conditions of the test.

(e) A 10-hour part of the test prescribed in sub-paragraph (b) must be run at not less than take-off torque and the maximum speed for use with take-off torque. The main and auxiliary rotor controls must be in the normal position for vertical ascent.

(1) For multi-engine rotorcraft for which the use of 2½ minute OEI power is requested, 12 runs during the 10-hour test must be conducted as follows:

(i) Each run must consist of at least one period of 2½ minutes with take-off torque and the maximum speed for use with take-off torque on all engines.

(ii) Each run must consist of at least one period for each engine in

CS-27 BOOK 1

sequence, during which that engine simulates a power failure and the remaining engines are run at 2½-minute OEI torque and the maximum speed for use with 2½-minute OEI torque for 2½ minutes.

(2) For multi-engine turbine-powered rotorcraft for which the use of 30-second and 2-minute OEI power is requested, 10 runs must be conducted as follows:

(i) Immediately following a take-off run of at least 5 minutes, each power source must simulate a failure, in turn, and apply the maximum torque and the maximum speed for use with 30-second OEI power to the remaining affected drive system power inputs for not less than 30 seconds, followed by application of the maximum torque and the maximum speed for use with 2-minute OEI power for not less than 2 minutes. At least one run sequence must be conducted from a simulated 'flight idle' condition. When conducted on a bench test, the test sequence must be conducted following stabilisation at take-off power.

(ii) For the purpose of this paragraph, an affected power input includes all parts of the rotor drive system which can be adversely affected by the application of higher or asymmetric torque and speed prescribed by the test.

(iii) This test may be conducted on a representative bench test facility when engine limitations either preclude repeated use of this power or would result in premature engine removal during the test. The loads, the vibration frequency, and the methods of application to the affected rotor drive system components must be representative of rotorcraft conditions. Test components must be those used to show compliance with the remainder of this paragraph.

(f) The parts of the test prescribed in sub-paragraphs (c) and (d) must be conducted in intervals of not less than 30 minutes and may be accomplished either on the ground or in flight. The part of the test prescribed in sub-paragraph (e) must be conducted in intervals of not less than 5 minutes.

(g) At intervals of not more than five hours during the tests prescribed in sub-paragraphs (c), (d), and (e), the engine must be stopped rapidly enough to allow the engine and rotor drive to be automatically disengaged from the rotors.

(h) Under the operating conditions specified in sub-paragraph (c), 500 complete cycles of lateral control, 500 complete cycles of longitudinal control of the main rotors, and 500 complete cycles of control of each auxiliary rotor must be accomplished. A 'complete cycle' involves movement of the controls from the neutral position, through both extreme positions, and back to the neutral position, except that control movements need not produce loads or flapping motions exceeding the maximum loads or motions encountered in flight. The cycling may be accomplished during the testing prescribed in sub-paragraph (c).

(i) At least 200 start-up clutch engagements must be accomplished:

(1) So that the shaft on the driven side of the clutch is accelerated; and

(2) Using a speed and method selected by the applicant.

(j) For multi-engine rotorcraft for which the use of 30-minute OEI power is requested, five runs must be made at 30-minute OEI torque and the maximum speed for use with 30-minute OEI torque, in which each engine, in sequence, is made inoperative and the remaining engine(s) is run for a 30-minute period.

(k) For multi-engine rotorcraft for which the use of continuous OEI power is requested, five runs must be made at continuous OEI torque and the maximum speed for use with continuous OEI torque, in which each engine, in sequence, is made inoperative and the remaining engine(s) is run for a 1-hour period.

CS 27.927 Additional tests

(a) Any additional dynamic, endurance, and operational tests, and vibratory investigations necessary to determine that the rotor drive mechanism is safe, must be performed.

(b) If turbine engine torque output to the transmission can exceed the highest engine or transmission torque rating limit, and that output is not directly controlled by the pilot under normal operating conditions (such as where the primary engine power control is accomplished through the flight control), the following test must be made:

(1) Under conditions associated with all engines operating, make 200 applications, for 10 seconds each, of torque that is at least equal to the lesser of:

(i) The maximum torque used in meeting CS 27.923 plus 10%; or

CS-27 BOOK 1

(ii) The maximum attainable torque output of the engines, assuming that torque limiting devices, if any, function properly.

(2) For multi-engine rotorcraft under conditions associated with each engine in turn becoming inoperative, apply to the remaining transmission torque inputs, the maximum torque attainable under probable operating conditions, assuming that torque limiting devices, if any, function properly. Each transmission input must be tested at this maximum torque for at least 15 minutes.

(3) The tests prescribed in this paragraph must be conducted on the rotorcraft at the maximum rotational speed intended for the power condition of the test and the torque must be absorbed by the rotors to be installed, except that other ground or flight test facilities with other appropriate methods of torque absorption may be used if the conditions of support and vibration closely simulate the conditions that would exist during a test on the rotorcraft.

(c) It must be shown by tests that the rotor drive system is capable of operating under autorotative conditions for 15 minutes after the loss of pressure in the rotor drive primary oil system.

CS 27.931 Shafting critical speed

(a) The critical speeds of any shafting must be determined by demonstration except that analytical methods may be used if reliable methods of analysis are available for the particular design.

(b) If any critical speed lies within, or close to, the operating ranges for idling, power on, and autorotative conditions, the stresses occurring at that speed must be within safe limits. This must be shown by tests.

(c) If analytical methods are used and show that no critical speed lies within the permissible operating ranges, the margins between the calculated critical speeds and the limits of the allowable operating ranges must be adequate to allow for possible variations between the computed and actual values.

CS 27.935 Shafting joints

Each universal joint, slip joint, and other shafting joints whose lubrication is necessary for operation must have provision for lubrication.

CS 27.939 Turbine engine operating characteristics

(a) Turbine engine operating characteristics must be investigated in flight to determine that no adverse characteristics (such as stall, surge, or flameout) are present, to a hazardous degree, during normal and emergency operation within the range of operating limitations of the rotorcraft and of the engine.

(b) The turbine engine air inlet system may not, as a result of airflow distortion during normal operation, cause vibration harmful to the engine.

(c) For governor-controlled engines, it must be shown that there exists no hazardous torsional instability of the drive system associated with critical combinations of power, rotational speed, and control displacement.

FUEL SYSTEM**CS 27.951 General**

(a) Each fuel system must be constructed and arranged to ensure a flow of fuel at a rate and pressure established for proper engine functioning under any likely operating condition, including the manoeuvres for which certification is requested.

(b) Each fuel system must be arranged so that:

(1) No fuel pump can draw fuel from more than one tank at a time; or

(2) There are means to prevent introducing air into the system.

(c) Each fuel system for a turbine engine must be capable of sustained operation throughout its flow and pressure range with fuel initially saturated with water at 27°C (80°F) and having 0.198 cc of free water per litre (0.75 cc per US gallon) added and cooled to the most critical condition for icing likely to be encountered in operation.

CS 27.952 Fuel system crash resistance

Unless other means acceptable to the Agency are employed to minimise the hazard of fuel fires to occupants following an otherwise survivable impact (crash landing), the fuel systems must incorporate the design features of this paragraph. These systems must be shown to be capable of sustaining the static and dynamic deceleration loads of this paragraph, considered as ultimate loads acting

CS-27 BOOK 1

alone, measured at the system component's centre of gravity without structural damage to system components, fuel tanks, or their attachments that would leak fuel to an ignition source.

(a) *Drop test requirements.* Each tank, or the most critical tank, must be drop-tested as follows:

- (1) The drop height must be at least 15.2 m (50 ft).
- (2) The drop impact surface must be non-deforming.
- (3) The tank must be filled with water to 80% of the normal, full capacity.
- (4) The tank must be enclosed in a surrounding structure representative of the installation unless it can be established that the surrounding structure is free of projections or other design features likely to contribute to rupture of the tank.
- (5) The tank must drop freely and impact in a horizontal position $\pm 10^\circ$.
- (6) After the drop test there must be no leakage.

(b) *Fuel tank load factors.* Except for fuel tanks located so that tank rupture with fuel release to either significant ignition sources, such as engines, heaters, and auxiliary power units, or occupants is extremely remote, each fuel tank must be designed and installed to retain its contents under the following ultimate inertial load factors, acting alone.

- (1) For fuel tanks in the cabin:
 - (i) Upward – 4 g.
 - (ii) Forward – 16 g.
 - (iii) Sideward – 8 g.
 - (iv) Downward – 20 g.
- (2) For fuel tanks located above or behind the crew or passenger compartment that, if loosened, could injure an occupant in an emergency landing:
 - (i) Upward – 1.5 g.
 - (ii) Forward – 8 g.
 - (iii) Sideward – 2 g.
 - (iv) Downward – 4 g.
- (3) For fuel tanks in other areas:
 - (i) Upward – 1.5 g.
 - (ii) Forward – 4 g.
 - (iii) Sideward – 2 g.

(iv) Downward – 4 g.

(c) *Fuel line self-sealing breakaway couplings.* Self-sealing breakaway couplings must be installed unless hazardous relative motion of fuel system components to each other or to local rotorcraft structure is demonstrated to be extremely improbable or unless other means are provided. The couplings or equivalent devices must be installed at all fuel tank-to-fuel line connections, tank-to-tank interconnects, and at other points in the fuel system where local structural deformation could lead to release of fuel.

(1) The design and construction of self-sealing breakaway couplings must incorporate the following design features:

(i) The load necessary to separate a breakaway coupling must be between 25 and 50% of the minimum ultimate failure load (ultimate strength) of the weakest component in the fluid-carrying line. The separation load must in no case be less than 1334 N (300 lb), regardless of the size of the fluid line.

(ii) A breakaway coupling must separate whenever its ultimate load (as defined in sub-paragraph (c)(1)(i)) is applied in the failure modes most likely to occur.

(iii) All breakaway couplings must incorporate design provisions to visually ascertain that the coupling is locked together (leak-free) and is open during normal installation and service.

(iv) All breakaway couplings must incorporate design provisions to prevent uncoupling or unintended closing due to operational shocks, vibrations, or accelerations.

(v) No breakaway coupling design may allow the release of fuel once the coupling has performed its intended function.

(2) All individual breakaway couplings, coupling fuel feed systems, or equivalent means must be designed, tested, installed and maintained so that inadvertent fuel shut-off in flight is improbable in accordance with CS 27.955(a) and must comply with the fatigue evaluation requirements of CS 27.571 without leaking.

(3) Alternate, equivalent means to the use of breakaway couplings must not create a survivable impact-induced load on the fuel line

CS-27 BOOK 1

to which it is installed greater than 25 to 50% of the ultimate load (strength) of the weakest component of the line and must comply with the fatigue requirements of CS 27.571 without leaking.

(d) *Frangible or deformable structural attachments.* Unless hazardous relative motion of fuel tanks and fuel system components to local rotorcraft structure is demonstrated to be extremely improbable in an otherwise survivable impact, frangible or locally deformable attachments of fuel tanks and fuel system components to local rotorcraft structure must be used. The attachment of fuel tanks and fuel system components to local rotorcraft structure, whether frangible or locally deformable, must be designed such that its separation or relative local deformation will occur without rupture or local tear-out of the fuel tank and fuel system components that will cause fuel leakage. The ultimate strength of frangible or deformable attachments must be as follows:

(1) The load required to separate a frangible attachment from its support structure, or to deform a locally deformable attachment relative to its support structure, must be between 25 and 50% of the minimum ultimate load (ultimate strength) of the weakest component in the attached system. In no case may the load be less than 1330 N (300 lbs).

(2) A frangible or locally deformable attachment must separate or locally deform as intended whenever its ultimate load (as defined in sub-paragraph (d) (1)) is applied in the modes most likely to occur.

(3) All frangible or locally deformable attachments must comply with the fatigue requirements of CS 27.571.

(e) *Separation of fuel and ignition sources.* To provide maximum crash resistance, fuel must be located as far as practicable from all occupiable areas and from all potential ignition sources.

(f) *Other basic mechanical design criteria.* Fuel tanks, fuel lines, electrical wires, and electrical devices must be designed, constructed and installed, as far as practicable, to be crash resistant.

(g) *Rigid or semi-rigid fuel tanks.* Rigid or semi-rigid fuel tank or bladder walls must be impact and tear resistant.

CS 27.953 Fuel system independence

(a) Each fuel system for multi-engine rotorcraft must allow fuel to be supplied to each

engine through a system independent of those parts of each system supplying fuel to other engines. However, separate fuel tanks need not be provided for each engine.

(b) If a single fuel tank is used on a multi-engine rotorcraft, the following must be provided:

(1) Independent tank outlets for each engine, each incorporating a shut-off valve at the tank. This shut-off valve may also serve as the firewall shut-off valve required by CS 27.995 if the line between the valve and the engine compartment does not contain a hazardous amount of fuel that can drain into the engine compartment.

(2) At least two vents arranged to minimise the probability of both vents becoming obstructed simultaneously.

(3) Filler caps designed to minimise the probability of incorrect installation or in-flight loss.

(4) A fuel system in which those parts of the system from each tank outlet to any engine are independent of each part of each system supplying fuel to other engines.

CS 27.954 Fuel system lightning protection

The fuel system must be designed and arranged to prevent the ignition of fuel vapour within the system by:

(a) Direct lightning strikes to areas having a high probability of stroke attachment;

(b) Swept lightning strokes to areas where swept strokes are highly probable; or

(c) Corona and streamering at fuel vent outlets.

CS 27.955 Fuel flow

(a) *General.* The fuel system for each engine must be shown to provide the engine with at least 100% of the fuel required under each operating and manoeuvring condition to be approved for the rotorcraft including, as applicable, the fuel required to operate the engine(s) under the test conditions required by CS 27.927. Unless equivalent methods are used, compliance must be shown by test during which the following provisions are met except that combinations of conditions which are shown to be improbable need not be considered:

(1) The fuel pressure, corrected for critical accelerations, must be within the limits

CS-27 BOOK 1

specified by the engine type certificate data sheet.

(2) The fuel level in the tank may not exceed that established as unusable fuel supply for the tank under CS 27.959, plus the minimum additional fuel necessary to conduct the test.

(3) The fuel head between the tank outlet and the engine inlet must be critical with respect to rotorcraft flight attitudes.

(4) The critical fuel pump (for pump-fed systems) is installed to produce (by actual or simulated failure) the critical restriction to fuel flow to be expected from pump failure.

(5) Critical values of engine rotation speed, electrical power, or other sources of fuel pump motive power must be applied.

(6) Critical values of fuel properties which adversely affect fuel flow must be applied.

(7) The fuel filter required by CS 27.997 must be blocked to the degree necessary to simulate the accumulation of fuel contamination required to activate the indicator required by CS 27.1305(q).

(b) *Fuel transfer systems.* If normal operation of the fuel system requires fuel to be transferred to an engine feed tank, the transfer must occur automatically via a system which has been shown to maintain the fuel level in the engine feed tank within acceptable limits during flight or surface operation of the rotorcraft.

(c) *Multiple fuel tanks.* If an engine can be supplied with fuel from more than one tank, the fuel systems must, in addition to having appropriate manual switching capability, be designed to prevent interruption of fuel flow to that engine, without attention by the flightcrew, when any tank supplying fuel to that engine is depleted of usable fuel during normal operation, and any other tank that normally supplies fuel to the engine alone contains usable fuel.

CS 27.959 Unusable fuel supply

The unusable fuel supply for each tank must be established as not less than the quantity at which the first evidence of malfunction occurs under the most adverse fuel feed condition occurring under any intended operations and flight manoeuvres involving that tank.

CS 27.961 Fuel system hot weather operation

Each suction lift fuel system and other fuel systems with features conducive to vapour formation must be shown by test to operate satisfactorily (within certification limits) when using fuel at a temperature of 43°C (110°F) under critical operating conditions including, if applicable, the engine operating conditions defined by CS 27.927 (b)(1) and (b)(2).

CS 27.963 Fuel tanks: general

(a) Each fuel tank must be able to withstand, without failure, the vibration, inertia, fluid, and structural loads to which it may be subjected in operation.

(b) Each fuel tank of 38 litres (8.3 Imperial gallons/10 US gallons) or greater capacity must have internal baffles, or must have external support to resist surging.

(c) Each fuel tank must be separated from the engine compartment by a firewall. At least one-half inch of clear airspace must be provided between the tank and the firewall.

(d) Spaces adjacent to the surfaces of fuel tanks must be ventilated so that fumes cannot accumulate in the tank compartment in case of leakage. If two or more tanks have interconnected outlets, they must be considered as one tank, and the airspaces in those tanks must be interconnected to prevent the flow of fuel from one tank to another as a result of a difference in pressure between those airspaces.

(e) The maximum exposed surface temperature of any component in the fuel tank must be less, by a safe margin, than the lowest expected auto-ignition temperature of the fuel or fuel vapour in the tank. Compliance with this requirement must be shown under all operating conditions and under all failure or malfunction conditions of all components inside the tank.

(f) Each fuel tank installed in personnel compartments must be isolated by fume-proof and fuel-proof enclosures that are drained and vented to the exterior of the rotorcraft. The design and construction of the enclosures must provide necessary protection for the tank, must be crash resistant during a survivable impact in accordance with CS 27.952 and must be adequate to withstand loads and abrasions to be expected in personnel compartments.

CS-27 BOOK 1

(g) Each flexible fuel tank bladder or liner must be approved or shown to be suitable for the particular application and must be puncture resistant. Puncture resistance must be shown by meeting the ETSO-C80, paragraph 16.0, requirements using a minimum puncture force of 1646 N (370 lbs).

(h) Each integral fuel tank must have provisions for inspection and repair of its interior.

CS 27.965 Fuel tank tests

(a) Each fuel tank must be able to withstand the applicable pressure tests in this paragraph without failure or leakage. If practicable, test pressures may be applied in a manner simulating the pressure distribution in service.

(b) Each conventional metal tank, non-metallic tank with walls that are not supported by the rotorcraft structure, and integral tank must be subjected to a pressure of 24 kPa (3.5 psi) unless the pressure developed during maximum limit acceleration or emergency deceleration with a full tank exceeds this value, in which case a hydrostatic head, or equivalent test, must be applied to duplicate the acceleration loads as far as possible. However, the pressure need not exceed 24 kPa (3.5 psi) on surfaces not exposed to the acceleration loading.

(c) Each non-metallic tank with walls supported by the rotorcraft structure must be subjected to the following tests:

(1) A pressure test of at least 14 kPa (2.0 psi). This test may be conducted on the tank alone in conjunction with the test specified in sub-paragraph (c)(2).

(2) A pressure test, with the tank mounted in the rotorcraft structure, equal to the load developed by the reaction of the contents, with the tank full, during maximum limit acceleration or emergency deceleration. However, the pressure need not exceed 14 kPa (2.0 psi) on surfaces not exposed to the acceleration loading.

(d) Each tank with large unsupported or unstiffened flat areas, or with other features whose failure or deformation could cause leakage, must be subjected to the following test or its equivalent:

(1) Each complete tank assembly and its support must be vibration tested while mounted to simulate the actual installation.

(2) The tank assembly must be vibrated for 25 hours while two-thirds full of any suitable

fluid. The amplitude of vibration may not be less than 0.8 mm (1/32 inch), unless otherwise substantiated.

(3) The test frequency of vibration must be as follows:

(i) If no frequency of vibration resulting from any rpm within the normal operating range of engine or rotor system speeds is critical, the test frequency of vibration, in number of cycles per minute must, unless a frequency based on a more rational calculation is used, be the number obtained by averaging the maximum and minimum power-on engine speeds (rpm) for reciprocating engine-powered rotorcraft or 2000 rpm for turbine engine-powered rotorcraft.

(ii) If only one frequency of vibration resulting from any rpm within the normal operating range of engine or rotor system speeds is critical, that frequency of vibration must be the test frequency.

(iii) If more than one frequency of vibration resulting from any rpm within the normal operating range of engine or rotor system speeds is critical, the most critical of these frequencies must be the test frequency.

(4) Under sub-paragraphs (d)(3)(ii) and (iii), the time of test must be adjusted to accomplish the same number of vibration cycles as would be accomplished in 25 hours at the frequency specified in sub-paragraph (d)(3)(i).

(5) During the test, the tank assembly must be rocked at the rate of 16 to 20 complete cycles per minute through an angle of 15° on both sides of the horizontal (30° total), about the most critical axis, for 25 hours. If motion about more than one axis is likely to be critical, the tank must be rocked about each critical axis for 12½ hours.

CS 27.967 Fuel tank installation

(a) Each fuel tank must be supported so that tank loads are not concentrated on unsupported tank surfaces. In addition:

(1) There must be pads, if necessary, to prevent chafing between each tank and its supports;

(2) The padding must be non-absorbent or treated to prevent the absorption of fuel;

CS-27 BOOK 1

(3) If flexible tank liners are used, they must be supported so that it is not necessary for them to withstand fluid loads; and

(4) Each interior surface of tank compartments must be smooth and free of projections that could cause wear of the liner unless:

(i) There are means for protection of the liner at those points; or

(ii) The construction of the liner itself provides such protection.

(b) Any spaces adjacent to tank surfaces must be adequately ventilated to avoid accumulation of fuel or fumes in those spaces due to minor leakage. If the tank is in a sealed compartment, ventilation may be limited to drain holes that prevent clogging and excessive pressure resulting from altitude changes. If flexible tank liners are installed, the venting arrangement for the spaces between the liner and its container must maintain the proper relationship to tank vent pressures for any expected flight condition.

(c) The location of each tank must meet the requirements of CS 27.1185 (a) and (c).

(d) No rotorcraft skin immediately adjacent to a major air outlet from the engine compartment may act as the wall of the integral tank.

CS 27.969 Fuel tank expansion space

Each fuel tank or each group of fuel tanks with interconnected vent systems must have an expansion space of not less than 2% of the tank capacity. It must be impossible to fill the fuel tank expansion space inadvertently with the rotorcraft in the normal ground attitude.

CS 27.971 Fuel tank sump

(a) Each fuel tank must have a drainable sump with an effective capacity in any ground attitude to be expected in service of 0.25% of the tank capacity or 0.24 litres (0.05 Imperial gallons/one sixteenth US gallon), whichever is greater, unless:

(1) The fuel system has a sediment bowl or chamber that is accessible for pre-flight drainage and has a minimum capacity of 30 ml (1 ounce) for every 76 litres (16.7 Imperial gallons/20 US gallons) of fuel tank capacity; and

(2) Each fuel tank drain is located so that in any ground attitude to be expected in service, water will drain from all parts of the tank to the sediment bowl or chamber.

(b) Each sump, sediment bowl, and sediment chamber drain required by the paragraph must comply with the drain provisions of CS 27.999 (b).

CS 27.973 Fuel tank filler connection

(a) Each fuel tank filler connection must prevent the entrance of fuel into any part of the rotorcraft other than the tank itself during normal operations and must be crash resistant during a survivable impact in accordance with CS 27.952 (c). In addition:

(1) Each filler must be marked as prescribed in CS 27.1557 (c)(1);

(2) Each recessed filler connection that can retain any appreciable quantity of fuel must have a drain that discharges clear of the entire rotorcraft; and

(3) Each filler cap must provide a fuel-tight seal under the fluid pressure expected in normal operation and in a survivable impact.

(b) Each filler cap or filler cap cover must warn when the cap is not fully locked or seated on the filler connection.

CS 27.975 Fuel tank vents

(a) Each fuel tank must be vented from the top part of the expansion space so that venting is effective under all normal flight conditions. Each vent must minimise the probability of stoppage by dirt or ice.

(b) The venting system must be designed to minimise spillage of fuel through the vents to an ignition source in the event of a rollover during landing, ground operation, or a survivable impact.

CS 27.977 Fuel tank outlet

(a) There must be a fuel strainer for the fuel tank outlet or for the booster pump. This strainer must:

(1) For reciprocating engine-powered rotorcraft have 3 to 6 meshes per cm (8 to 16 meshes per inch); and

CS-27 BOOK 1

(2) For turbine engine-powered rotorcraft, prevent the passage of any object that could restrict fuel flow or damage any fuel system component.

(b) The clear area of each fuel tank outlet strainer must be at least 5 times the area of the outlet line.

(c) The diameter of each strainer must be at least that of the fuel tank outlet.

(d) Each finger strainer must be accessible for inspection and cleaning.

FUEL SYSTEM COMPONENTS**CS 27.991 Fuel pumps**

Compliance with CS 27.955 may not be jeopardised by failure of:

(a) Any one pump except pumps that are approved and installed as parts of a type certificated engine; or

(b) Any component required for pump operation except, for engine driven pumps, the engine served by that pump.

CS 27.993 Fuel system lines and fittings

(a) Each fuel line must be installed and supported to prevent excessive vibration and to withstand loads due to fuel pressure and accelerated flight conditions.

(b) Each fuel line connected to components of the rotorcraft between which relative motion could exist must have provisions for flexibility.

(c) Flexible hose must be approved.

(d) Each flexible connection in fuel lines that may be under pressure or subjected to axial loading must use flexible hose assemblies.

(e) No flexible hose that might be adversely affected by high temperatures may be used where excessive temperatures will exist during operation or after engine shutdown.

CS 27.995 Fuel valves

(a) There must be a positive, quick-acting valve to shut-off fuel to each engine individually.

(b) The control for this valve must be within easy reach of appropriate crew members.

(c) Where there is more than one source of fuel supply there must be means for independent feeding from each source.

(d) No shut-off valve may be on the engine side of any firewall.

CS 27.997 Fuel strainer or filter

There must be a fuel strainer or filter between the fuel tank outlet and the inlet of the first fuel system component which is susceptible to fuel contamination, including but not limited to the fuel metering device or an engine positive displacement pump, whichever is nearer the fuel tank outlet. This fuel strainer or filter must:

(a) Be accessible for draining and cleaning and must incorporate a screen or element which is easily removable;

(b) Have a sediment trap and drain except that it need not have a drain if the strainer or filter is easily removable for drain purposes;

(c) Be mounted so that its weight is not supported by the connecting lines or by the inlet or outlet connections of the strainer or filter itself, unless adequate strength margins under all loading conditions are provided in the lines and connections; and

(d) Provide a means to remove from the fuel any contaminant which would jeopardise the flow of fuel through rotorcraft or engine fuel system components required for proper rotorcraft fuel system or engine fuel system operation.

CS 27.999 Fuel system drains

(a) There must be at least one accessible drain at the lowest point in each fuel system to completely drain the system with the rotorcraft in any ground attitude to be expected in service.

(b) Each drain required by sub-paragraph (a) must:

(1) Discharge clear of all parts of the rotorcraft;

(2) Have manual or automatic means to assure positive closure in the off position; and

(3) Have a drain valve:

CS-27 BOOK 1

(i) That is readily accessible and which can be easily opened and closed; and

(ii) That is either located or protected to prevent fuel spillage in the event of a landing with landing gear retracted.

OIL SYSTEM**CS 27.1011 Engines: general**

(a) Each engine must have an independent oil system that can supply it with an appropriate quantity of oil at a temperature not above that safe for continuous operation.

(b) The usable oil capacity of each system may not be less than the product of the endurance of the rotorcraft under critical operating conditions and the maximum oil consumption of the engine under the same conditions, plus a suitable margin to ensure adequate circulation and cooling. Instead of a rational analysis of endurance and consumption, a usable oil capacity of 3.8 litres (0.83 Imperial gallon /1 US gallon) for each 151 litres (33.3 Imperial gallons/40 US gallons) of usable fuel may be used.

(c) The oil cooling provisions for each engine must be able to maintain the oil inlet temperature to that engine at or below the maximum established value. This must be shown by flight tests.

CS 27.1013 Oil tanks

Each oil tank must be designed and installed so that:

(a) It can withstand, without failure, each vibration, inertia, fluid, and structural load expected in operation;

(b) (Reserved)

(c) Where used with a reciprocating engine, it has an expansion space of not less than the greater of 10% of the tank capacity or 1.9 litre (0.42 Imperial gallon/0.5 US gallon), and where used with a turbine engine, it has an expansion space of not less than 10% of the tank capacity.

(d) It is impossible to fill the tank expansion space inadvertently with the rotorcraft in the normal ground attitude;

(e) Adequate venting is provided; and

(f) There are means in the filler opening to prevent oil overflow from entering the oil tank compartment.

CS 27.1015 Oil tank tests

Each oil tank must be designed and installed so that it can withstand, without leakage, an internal pressure of 34 kPa (5 psi), except that each pressurised oil tank used with a turbine engine must be designed and installed so that it can withstand, without leakage, an internal pressure of 34 kPa (5 psi), plus the maximum operating pressure of the tank.

CS 27.1017 Oil lines and fittings

(a) Each oil line must be supported to prevent excessive vibration.

(b) Each oil line connected to components of the rotorcraft between which relative motion could exist must have provisions for flexibility.

(c) Flexible hose must be approved.

(d) Each oil line must have an inside diameter of not less than the inside diameter of the engine inlet or outlet. No line may have splices between connections.

CS 27.1019 Oil strainer or filter

(a) Each turbine engine installation must incorporate an oil strainer or filter through which all of the engine oil flows and which meets the following requirements:

(1) Each oil strainer or filter that has a bypass must be constructed and installed so that oil will flow at the normal rate through the rest of the system with the strainer or filter completely blocked.

(2) The oil strainer or filter must have the capacity (with respect to operating limitations established for the engine) to ensure that engine oil system functioning is not impaired when the oil is contaminated to a degree (with respect to particle size and density) that is greater than that established for the engine under CS-E.

(3) The oil strainer or filter, unless it is installed at an oil tank outlet, must incorporate a means to indicate contamination before it

CS-27 BOOK 1

reaches the capacity established in accordance with sub-paragraph (a)(2).

(4) The bypass of a strainer or filter must be constructed and installed so that the release of collected contaminants is minimised by appropriate location of the bypass to ensure that collected contaminants are not in the bypass flow path.

(5) An oil strainer or filter that has no bypass, except one that is installed at an oil tank outlet, must have a means to connect it to the warning system required in CS 27.1305(r).

(b) Each oil strainer or filter in a powerplant installation using reciprocating engines must be constructed and installed so that oil will flow at the normal rate through the rest of the system with the strainer or filter element completely blocked.

CS 27.1021 Oil system drains

A drain (or drains) must be provided to allow safe drainage of the oil system. Each drain must:

- (a) Be accessible; and
- (b) Have manual or automatic means for positive locking in the closed position.

CS 27.1027 Transmissions and gearboxes: general

(a) The lubrication system for components of the rotor drive system that require continuous lubrication must be sufficiently independent of the lubrication systems of the engine(s) to ensure lubrication during autorotation.

(b) Pressure lubrication systems for transmissions and gear-boxes must comply with the engine oil system requirements of CS 27.1013 (except sub-paragraph (c)), CS 27.1015, 27.1017, 27.1021, and 27.1337 (d).

(c) Each pressure lubrication system must have an oil strainer or filter through which all of the lubricant flows and must:

(1) Be designed to remove from the lubricant any contaminant which may damage transmission and drive system components or impede the flow of lubricant to a hazardous degree;

(2) Be equipped with a means to indicate collection of contaminants on the filter

or strainer at or before opening of the bypass required by sub-paragraph (c)(3); and

(3) Be equipped with a bypass constructed and installed so that:

(i) The lubricant will flow at the normal rate through the rest of the system with the strainer or filter completely blocked; and

(ii) The release of collected contaminants is minimised by appropriate location of the bypass to ensure that collected contaminants are not in the bypass flow path.

(d) For each lubricant tank or sump outlet supplying lubrication to rotor drive systems and rotor drive system components, a screen must be provided to prevent entrance into the lubrication system of any object that might obstruct the flow of lubricant from the outlet to the filter required by sub-paragraph (c). The requirements of sub-paragraph (c) do not apply to screens installed at lubricant tank or sump outlets.

(e) Splash-type lubrication systems for rotor drive system gearboxes must comply with CS 27.1021 and 27.1337 (d).

COOLING**CS 27.1041 General**

(a) Each powerplant cooling system must be able to maintain the temperatures of powerplant components within the limits established for these components under critical surface (ground or water) and flight operating conditions for which certification is required and after normal shutdown. Powerplant components to be considered include but may not be limited to engines, rotor drive system components, auxiliary power units, and the cooling or lubricating fluids used with these components.

(b) Compliance with sub-paragraph (a) must be shown in tests conducted under the conditions prescribed in that paragraph.

CS 27.1043 Cooling tests

(a) *General.* For the tests prescribed in CS 27.1041 (b), the following apply:

CS-27 BOOK 1

(1) If the tests are conducted under conditions deviating from the maximum ambient atmospheric temperature specified in sub-paragraph (b), the recorded powerplant temperatures must be corrected under sub-paragraphs (c) and (d) unless a more rational correction method is applicable.

(2) No corrected temperature determined under sub-paragraph (a)(1) may exceed established limits.

(3) For reciprocating engines, the fuel used during the cooling tests must be of the minimum grade approved for the engines, and the mixture settings must be those normally used in the flight stages for which the cooling tests are conducted.

(4) The test procedures must be as prescribed in CS 27.1045.

(b) *Maximum ambient atmospheric temperature.* A maximum ambient atmospheric temperature corresponding to sea-level conditions of at least 38°C (100°F) must be established. The assumed temperature lapse rate is 1.98°C (3.6°F) per 305 m (1000 ft) of altitude above sea-level until a temperature of -56.5°C (-69.7°F) is reached, above which altitude the temperature is considered constant at -56.5°C (-69.7°F). However, for winterization installations, the applicant may select a maximum ambient atmospheric temperature corresponding to sea-level conditions of less than 38°C (100°F).

(c) *Correction factor (except cylinder barrels).* Unless a more rational correction applies, temperatures of engine fluids and powerplant components (except cylinder barrels) for which temperature limits are established, must be corrected by adding to them the difference between the maximum ambient atmospheric temperature and the temperature of the ambient air at the time of the first occurrence of the maximum component or fluid temperature recorded during the cooling test.

(d) *Correction factor for cylinder barrel temperatures.* Cylinder barrel temperatures must be corrected by adding to them 0.7 times the difference between the maximum ambient atmospheric temperature and the temperature of the ambient air at the time of the first occurrence of the maximum cylinder barrel temperature recorded during the cooling test.

CS 27.1045 Cooling test procedures

(a) *General.* For each stage of flight, the cooling tests must be conducted with the rotorcraft:

(1) In the configuration most critical for cooling; and

(2) Under the conditions most critical for cooling.

(b) *Temperature stabilisation.* For the purpose of the cooling tests, a temperature is 'stabilised' when its rate of change is less than 1°C (2°F) per minute. The following component and engine fluid temperature stabilisation rules apply:

(1) For each rotorcraft, and for each stage of flight:

(i) The temperatures must be stabilised under the conditions from which entry is made into the stage of flight being investigated; or

(ii) If the entry condition normally does not allow temperatures to stabilise, operation through the full entry condition must be conducted before entry into the stage of flight being investigated in order to allow the temperatures to attain their natural levels at the time of entry.

(2) For each helicopter during the take-off stage of flight the climb at take-off power must be preceded by a period of hover during which the temperatures are stabilised.

(c) *Duration of test.* For each stage of flight the tests must be continued until:

(1) The temperatures stabilise or 5 minutes after the occurrence of the highest temperature recorded, as appropriate to the test condition;

(2) That stage of flight is completed; or

(3) An operating limitation is reached.

INDUCTION SYSTEM**CS 27.1091 Air induction**

(a) The air induction system for each engine must supply the air required by that engine under the operating conditions and manoeuvres for which certification is requested.

(b) Each cold air induction system opening must be outside the cowling if backfire flames can emerge.

CS-27 BOOK 1

(c) If fuel can accumulate in any air induction system, that system must have drains that discharge fuel:

- (1) Clear of the rotorcraft; and
- (2) Out of the path of exhaust flames.

(d) For turbine engine-powered rotorcraft:

(1) There must be means to prevent hazardous quantities of fuel leakage or overflow from drains, vents, or other components of flammable fluid systems from entering the engine intake system; and

(2) The air inlet ducts must be located or protected so as to minimise the ingestion of foreign matter during take-off, landing, and taxiing.

CS 27.1093 Induction system icing protection

(a) *Reciprocating engines.* Each reciprocating engine air induction system must have means to prevent and eliminate icing. Unless this is done by other means, it must be shown that, in air free of visible moisture at a temperature of -1°C (30°F) and with the engines at 75% of maximum continuous power:

(1) Each rotorcraft with sea-level engines using conventional venturi carburetors has a preheater that can provide a heat rise of 50°C (90°F);

(2) Each rotorcraft with sea-level engines using carburetors tending to prevent icing has a sheltered alternate source of air, and that the preheat supplied to the alternate air intake is not less than that provided by the engine cooling air downstream of the cylinders;

(3) Each rotorcraft with altitude engines using conventional venturi carburetors has a preheater capable of providing a heat rise of 67°C (120°F); and

(4) Each rotorcraft with altitude engines using carburetors tending to prevent icing has a preheater that can provide a heat rise of:

- (i) 56°C (100°F); or
- (ii) If a fluid de-icing system is used, at least 22°C (40°F).

(b) *Turbine engines*

(1) It must be shown that each turbine engine and its air inlet system can operate

throughout the flight power range of the engine (including idling):

(i) Without accumulating ice on engine or inlet system components that would adversely affect engine operation or cause a serious loss of power under the icing conditions specified in appendix C of CS-29; and

(ii) In snow, both falling and blowing, without adverse effect on engine operation, within the limitations established for the rotorcraft.

(2) Each turbine engine must idle for 30 minutes on the ground, with the air bleed available for engine icing protection at its critical condition, without adverse effect, in an atmosphere that is at a temperature between -9°C and -1°C (15° and 30°F) and has a liquid water content not less than 0.3 grams per cubic metre in the form of drops having a mean effective diameter of not less than 20 microns, followed by momentary operation at take-off power or thrust. During the 30 minutes of idle operation, the engine may be run up periodically to a moderate power or thrust setting in a manner acceptable to the Agency.

(c) *Supercharged reciprocating engines.* For each engine having superchargers to pressurise the air before it enters the carburettor, the heat rise in the air caused by that supercharging at any altitude may be utilised in determining compliance with subparagraph (a) if the heat rise utilised is that which will be available, automatically, for the applicable altitude and operating condition because of supercharging.

EXHAUST SYSTEM**CS 27.1121 General**

For each exhaust system:

(a) There must be means for thermal expansion of manifolds and pipes;

(b) There must be means to prevent local hot spots;

(c) Exhaust gases must discharge clear of the engine air intake, fuel system components, and drains;

(d) Each exhaust system part with a surface hot enough to ignite flammable fluids or vapours must be located or shielded so that leakage from

CS-27 BOOK 1

any system carrying flammable fluids or vapours will not result in a fire caused by impingement of the fluids or vapours on any part of the exhaust system including shields for the exhaust system;

(e) Exhaust gases may not impair pilot vision at night due to glare;

(f) If significant traps exist, each turbine engine exhaust system must have drains discharging clear of the rotorcraft, in any normal ground and flight attitudes, to prevent fuel accumulation after the failure of an attempted engine start; and

(g) Each exhaust heat exchanger must incorporate means to prevent blockage of the exhaust port after any internal heat exchanger failure.

CS 27.1123 Exhaust piping

(a) Exhaust piping must be heat and corrosion resistant and must have provisions to prevent failure due to expansion by operating temperatures.

(b) Exhaust piping must be supported to withstand any vibration and inertia loads to which it would be subjected in operations.

(c) Exhaust piping connected to components between which relative motion could exist must have provisions for flexibility.

POWERPLANT CONTROLS AND ACCESSORIES**CS 27.1141 Powerplant controls: general**

(a) Powerplant controls must be located and arranged under CS 27.777 and marked under CS 27.1555.

(b) Each flexible powerplant control must be approved.

(c) Each control must be able to maintain any set position without:

- (1) Constant attention; or
- (2) Tendency to creep due to control loads or vibration.

(d) Controls of powerplant valves required for safety must have:

(1) For manual valves, positive stops or in the case of fuel valves suitable index provisions, in the open and closed position; and

(2) For power-assisted valves, a means to indicate to the flight crew when the valve:

(i) Is in the fully open or fully closed position; or

(ii) Is moving between the fully open and fully closed position.

(e) For turbine-engine-powered rotorcraft, no single failure or malfunction, or probable combination thereof, in any powerplant control system may cause the failure of any powerplant function necessary for safety.

CS 27.1143 Engine controls

(a) There must be a separate power control for each engine.

(b) Power controls must be grouped and arranged to allow:

- (1) Separate control of each engine; and
- (2) Simultaneous control of all engines.

(c) Each power control must provide a positive and immediately responsive means of controlling its engine.

(d) If a power control incorporates a fuel shut-off feature, the control must have a means to prevent the inadvertent movement of the control into the shut-off position. The means must:

(1) Have a positive lock or stop at the idle position; and

(2) Require a separate and distinct operation to place the control in the shut-off position.

(e) For rotorcraft to be certificated for a 30-second OEI power rating, a means must be provided to automatically activate and control the 30-second OEI power and prevent any engine from exceeding the installed engine limits associated with the 30-second OEI power rating approved for the rotorcraft.

CS 27.1145 Ignition switches

(a) There must be means to quickly shut off all ignition by the grouping of switches or by a master ignition control.

CS-27 BOOK 1

(b) Each group of ignition switches, except ignition switches for turbine engines for which continuous ignition is not required, and each master ignition control must have a means to prevent its inadvertent operation.

CS 27.1147 Mixture controls

If there are mixture controls, each engine must have a separate control and the controls must be arranged to allow:

- (a) Separate control of each engine; and
- (b) Simultaneous control of all engines.

CS 27.1151 Rotor brake controls

(a) It must be impossible to apply the rotor brake inadvertently in flight.

(b) There must be means to warn the crew if the rotor brake has not been completely released before take-off.

CS 27.1163 Powerplant accessories

(a) Each engine-mounted accessory must:

- (1) Be approved for mounting on the engine involved;
- (2) Use the provisions on the engine for mounting; and
- (3) Be sealed in such a way as to prevent contamination of the engine oil system and the accessory system.

(b) Unless other means are provided, torque limiting means must be provided for accessory drives located on any component of the transmission and rotor drive system to prevent damage to these components from excessive accessory load.

POWERPLANT FIRE PROTECTION**CS 27.1183 Lines, fittings, and components**

(a) Except as provided in sub-paragraph (b), each line, fitting, and other component carrying flammable fluid in any area subject to engine fire

conditions must be fire resistant, except that flammable fluid tanks and supports which are part of and attached to the engine must be fireproof or be enclosed by a fireproof shield unless damage by fire to any non-fireproof part will not cause leakage or spillage of flammable fluid. Components must be shielded or located so as to safeguard against the ignition of leaking flammable fluid. An integral oil sump of less than 24 litres (5.2 Imperial gallons/25 US quart) capacity on a reciprocating engine need not be fireproof nor be enclosed by a fireproof shield.

(b) Sub-paragraph (a) does not apply to:

(1) Lines, fittings, and components which are already approved as part of a type certificated engine; and

(2) Vent and drain lines, and their fittings, whose failure will not result in, or add to, a fire hazard.

(c) Each flammable fluid drain and vent must discharge clear of the induction system air inlet.

CS 27.1185 Flammable fluids

(a) Each fuel tank must be isolated from the engines by a firewall or shroud.

(b) Each tank or reservoir, other than a fuel tank, that is part of a system containing flammable fluids or gases must be isolated from the engine by a firewall or shroud unless the design of the system, the materials used in the tank and its supports, the shutoff means, and the connections, lines and controls provide a degree of safety equal to that which would exist if the tank or reservoir were isolated from the engines.

(c) There must be at least 13 mm (½ in) of clear airspace between each tank and each firewall or shroud isolating that tank, unless equivalent means are used to prevent heat transfer from each engine compartment to the flammable fluid.

(d) Absorbent materials close to flammable fluid system components that might leak must be covered or treated to prevent the absorption of hazardous quantities of fluids.

CS 27.1187 Ventilation and drainage

Each compartment containing any part of the powerplant installation must have provision for ventilation and drainage of flammable fluids. The drainage means must be:

CS-27 BOOK 1

(a) Effective under conditions expected to prevail when drainage is needed; and

(b) Arranged so that no discharged fluid will cause an additional fire hazard.

CS 27.1189 Shut-off means

(a) There must be means to shut off each line carrying flammable fluids into the engine compartment, except:

(1) Lines, fittings, and components forming an integral part of an engine;

(2) For oil systems for which all components of the system, including oil tanks, are fireproof or located in areas not subject to engine fire conditions; and

(3) For reciprocating engine installations only, engine oil system lines in installations using engines of less than 8195 cm³ (500 cubic inches) displacement.

(b) There must be means to guard against inadvertent operation of each shutoff, and to make it possible for the crew to reopen it in flight after it has been closed.

(c) Each shut-off valve and its control must be designed, located, and protected to function properly under any condition likely to result from an engine fire.

CS 27.1191 Firewalls

(a) Each engine, including the combustor, turbine, and tailpipe sections of turbine engines must be isolated by a firewall, shroud or equivalent means, from personnel compartments, structures, controls, rotor mechanisms, and other parts that are:

(1) Essential to a controlled landing; and

(2) Not protected under CS 27.861.

(b) Each auxiliary power unit and combustion heater, and any other combustion equipment to be used in flight, must be isolated from the rest of the rotorcraft by firewalls, shrouds, or equivalent means.

(c) In meeting sub-paragraphs (a) and (b), account must be taken of the probable path of a fire as affected by the airflow in normal flight and in autorotation.

(d) Each firewall and shroud must be constructed so that no hazardous quantity of air,

fluids, or flame can pass from any engine compartment to other parts of the rotorcraft.

(e) Each opening in the firewall or shroud must be sealed with close-fitting, fireproof grommets, bushings, or firewall fittings.

(f) Each firewall and shroud must be fireproof and protected against corrosion.

CS 27.1193 Cowling and engine compartment covering

(a) Each cowling and engine compartment covering must be constructed and supported so that it can resist the vibration, inertia, and air loads to which it may be subjected in operation.

(b) There must be means for rapid and complete drainage of each part of the cowling or engine compartment in the normal ground and flight attitudes.

(c) No drain may discharge where it might cause a fire hazard.

(d) Each cowling and engine compartment covering must be at least fire resistant.

(e) Each part of the cowling or engine compartment covering subject to high temperatures due to its nearness to exhaust system parts or exhaust gas impingement must be fireproof.

(f) A means of retaining each openable or readily removable panel, cowling, or engine or rotor drive system covering must be provided to preclude hazardous damage to rotors or critical control components in the event of structural or mechanical failure of the normal retention means, unless such failure is extremely improbable.

CS 27.1194 Other surfaces

All surfaces aft of, and near, powerplant compartments, other than tail surfaces not subject to heat, flames, or sparks emanating from a powerplant compartment, must be at least fire resistant.

CS 27.1195 Fire detector systems

Each turbine engine-powered rotorcraft must have approved quick-acting fire detectors in numbers and locations insuring prompt detection of fire in the engine compartment which cannot be readily observed in flight by the pilot in the cockpit.

CS-27 BOOK 1

CS-27 BOOK 1**SUBPART F — EQUIPMENT****GENERAL****CS 27.1301 Function and installation**

Each item of installed equipment must:

- (a) Be of a kind and design appropriate to its intended function;
- (b) Be labelled as to its identification, function, or operating limitations, or any applicable combination of these factors;
- (c) Be installed according to limitations specified for that equipment; and
- (d) Function properly when installed.

CS 27.1302 Installed systems and equipment for use by the crew members

(See AMC 27.1302, GM1 and GM2 27.1302)

This paragraph applies to installed systems and equipment intended to be used by the crew members when operating the rotorcraft from their normal seating positions in the cockpit or their operating positions in the cabin. The installed systems and equipment must be shown, individually and in combination with other such systems and equipment, to be designed so that trained crew members can safely perform their tasks associated with the intended function of the systems and equipment by meeting the following requirements:

- (a) The controls and information necessary for the accomplishment of the tasks must be provided.
- (b) The controls and information required by paragraph (a), which are intended for use by the crew members, must:
 - (1) be presented in a clear and unambiguous form, at a resolution and with a precision appropriate to the crew member tasks;
 - (2) be accessible and usable by the crew members in a manner appropriate to the urgency, frequency, and duration of their tasks; and

- (3) make the crew members aware of the effects their actions may have on the rotorcraft or its systems, if they require awareness for the safe operation of the rotorcraft.
- (c) Operationally relevant behaviour of the installed systems and equipment must be:
 - (1) predictable and unambiguous; and
 - (2) designed to enable the crew members to intervene in a manner that is appropriate to accomplish their tasks.
- (d) The installed systems and equipment must enable the crew members to manage the errors that result from the kinds of crew member interactions with the system and equipment that can be reasonably expected in service, assuming the crew member acts in good faith. Paragraph (d) does not apply to skill-related errors associated with the manual control of the rotorcraft.

[Amdt No: 27/8]

CS 27.1303 Flight and navigation instruments

The following are the required flight and navigation instruments:

- (a) An airspeed indicator.
- (b) An altimeter.
- (c) A magnetic direction indicator.

CS 27.1305 Powerplant instruments

The following are the required powerplant instruments:

- (a) A carburettor air temperature indicator, for each engine having a pre-heater that can provide a heat rise in excess of 33°C (60°F).
- (b) A cylinder head temperature indicator, for each:
 - (1) Air cooled engine;
 - (2) Rotorcraft with cooling shutters; and
 - (3) Rotorcraft for which compliance with CS 27.1043 is shown in any condition

CS-27 BOOK 1

other than the most critical flight condition with respect to cooling.

(c) A fuel pressure indicator, for each pump-fed engine.

(d) A fuel quantity indicator, for each fuel tank.

(e) A manifold pressure indicator, for each altitude engine.

(f) An oil temperature warning device to indicate when the temperature exceeds a safe value in each main rotor drive gearbox (including any gearboxes essential to rotor phasing) having an oil system independent of the engine oil system.

(g) An oil pressure warning device to indicate when the pressure falls below a safe value in each pressure-lubricated main rotor drive gearbox (including any gearboxes essential to rotor phasing) having an oil system independent of the engine oil system.

(h) An oil pressure indicator for each engine.

(i) An oil quantity indicator for each oil tank.

(j) An oil temperature indicator for each engine.

(k) At least one tachometer to indicate the rpm of each engine and, as applicable:

(1) The rpm of the single main rotor;

(2) The common rpm of any main rotors whose speeds cannot vary appreciably with respect to each other; or

(3) The rpm of each main rotor whose speed can vary appreciably with respect to that of another main rotor.

(l) A low fuel warning device for each fuel tank which feeds an engine. This device must:

(1) Provide a warning to the flight crew when approximately 10 minutes of usable fuel remains in the tank; and

(2) Be independent of the normal fuel quantity indicating system.

(m) Means to indicate to the flight crew the failure of any fuel pump installed to show compliance with CS 27.955.

(n) A gas temperature indicator for each turbine engine.

(o) Means to enable the pilot to determine the torque of each turboshaft engine, if a torque limitation is established for that engine under CS 27.1521 (e).

(p) For each turbine engine, an indicator to indicate the functioning of the powerplant ice protection system.

(q) An indicator for the fuel filter required by CS 27.997 to indicate the occurrence of contamination of the filter at the degree established by the applicant in compliance with CS 27.955.

(r) For each turbine engine, a warning means for the oil strainer or filter required by CS 27.1019, if it has no by-pass, to warn the pilot of the occurrence of contamination of the strainer or filter before it reaches the capacity established in accordance with CS 27.1019 (a)(2).

(s) An indicator to indicate the proper functioning of any selectable or controllable heater used to prevent ice clogging of fuel system components.

(t) For rotorcraft for which a 30-second/2-minute OEI power rating is requested, a means must be provided to alert the pilot when the engine is at the 30-second and 2-minute OEI power levels, when the event begins, and when the time interval expires.

(u) For each turbine engine utilising 30-second/2-minute OEI power, a device or system must be provided for use by ground personnel which:

(1) Automatically records each usage and duration of power in the 30-second and 2-minute OEI levels;

(2) Permits retrieval of the recorded data;

(3) Can be reset only by ground maintenance personnel: and

(4) Has a means to verify proper operation of the system or device.

(v) Warning or caution devices to signal to the flight crew when ferromagnetic particles are detected by the chip detection system required by CS 27.1337(e).

[Amdt No: 27/2]

[Amdt No: 27/9]

CS 27.1307 Miscellaneous equipment

The following is the required miscellaneous equipment:

(a) An approved seat for each occupant.

(b) An approved safety belt for each occupant.

(c) A master switch arrangement.

CS-27 BOOK 1

(d) An adequate source of electrical energy, where electrical energy is necessary for operation of the rotorcraft.

(e) Electrical protective devices.

CS 27.1309 Equipment, systems, and installations

(a) The equipment, systems, and installations whose functioning is required by this CS-27 must be designed and installed to ensure that they perform their intended functions under any foreseeable operating condition.

(b) The equipment, systems, and installations of a multi-engine rotorcraft must be designed to prevent hazards to the rotorcraft in the event of a probable malfunction or failure.

(c) The equipment, systems, and installations of single-engine rotorcraft must be designed to minimise hazards to the rotorcraft in the event of a probable malfunction or failure.

[Amdt No: 27/4]

CS 27.1316 Electrical and electronic system lightning protection

(a) Each electrical and electronic system that performs a function whose failure would prevent the continued safe flight and landing of the rotorcraft must be designed and installed in a way that:

(1) the function is not adversely affected during and after the rotorcraft's exposure to lightning; and

(2) the system automatically recovers normal operation of that function in a timely manner after the rotorcraft's exposure to lightning unless the system's recovery conflicts with other operational or functional requirements of the system that would prevent continued safe flight and landing of the rotorcraft.

(b) For rotorcraft approved for instrument flight rules operation, each electrical and electronic system that performs a function whose failure would reduce the capability of the rotorcraft or the ability of the flight crew to respond to an adverse operating condition must be designed and installed in a way that the function recovers normal operation in a timely manner after the rotorcraft's exposure to lightning.

[Amdt 27/4]

CS 27.1317 High-Intensity Radiated Fields (HIRF) protection

(a) Each electrical and electronic system that performs a function whose failure would prevent the continued safe flight and landing of the rotorcraft must be designed and installed in a way that:

(1) the function is not adversely affected during and after the rotorcraft's exposure to HIRF environment I as described in Appendix D;

(2) the system automatically recovers normal operation of that function in a timely manner after the rotorcraft's exposure to HIRF environment I as described in Appendix D unless the system's recovery conflicts with other operational or functional requirements of the system that would prevent continued safe flight and landing of the rotorcraft;

(3) the system is not adversely affected during and after the rotorcraft's exposure to HIRF environment II as described in Appendix D; and

(4) each function required during operation under visual flight rules is not adversely affected during and after the rotorcraft's exposure to HIRF environment III as described in Appendix D.

(b) Each electrical and electronic system that performs a function whose failure would significantly reduce the capability of the rotorcraft or the ability of the flight crew to respond to an adverse operating condition must be designed and installed in a way that the system is not adversely affected when the equipment providing the function is exposed to equipment HIRF test level 1 or 2 as described in Appendix D.

(c) Each electrical and electronic system that performs a function whose failure would reduce the capability of the rotorcraft or the ability of the flight crew to respond to an adverse operating condition must be designed and installed in a way that the system is not adversely affected when the equipment providing the function is exposed to equipment HIRF test level 3 as described in Appendix D.

[Amdt 27/4]

CS 27.1319 Equipment, systems and network information security protection

(a) Equipment, systems and networks of Category A rotorcraft, considered separately and in relation to other systems, must be protected

CS-27 BOOK 1

from intentional unauthorised electronic interactions (IUEIs) that may result in catastrophic or hazardous effects on the safety of the rotorcraft. Protection must be ensured by showing that the security risks have been identified, assessed and mitigated as necessary.

(b) When required by paragraph (a), the applicant must make procedures and Instructions for Continued Airworthiness (ICA) available which ensure that the security protections of the rotorcraft equipment, systems and networks are maintained.'

[Amdt 27/7]

INSTRUMENTS: INSTALLATION**CS 27.1321 Arrangement and visibility**

(a) Each flight, navigation, and powerplant instrument for use by any pilot must be easily visible to him.

(b) For each multi-engine rotorcraft, identical powerplant instruments must be located so as to prevent confusion as to which engine each instrument relates.

(c) Instrument panel vibration may not damage, or impair the readability or accuracy of, any instrument.

(d) If a visual indicator is provided to indicate malfunction of an instrument, it must be effective under all probable cockpit lighting conditions.

CS 27.1322 Warning, caution, and advisory lights

If warning, caution or advisory lights are installed in the cockpit, they must, unless otherwise approved the Agency, be:

(a) Red, for warning lights (lights indicating a hazard which may require immediate corrective action);

(b) Amber, for caution lights (lights indicating possible need for future corrective action);

(c) Green, for safe operation lights; and

(d) Any other colour, including white, for lights not described in sub-paragraphs (a) to (c), provided the colour differs sufficiently from the colours prescribed in sub-paragraphs (a) to (c) to avoid possible confusion.

CS 27.1323 Airspeed indicating system

(a) Each airspeed indicating instrument must be calibrated to indicate true airspeed (at

sea-level with a standard atmosphere) with a minimum practicable instrument calibration error when the corresponding pitot and static pressures are applied.

(b) The airspeed indicating system must be calibrated in flight at forward speeds of 37 km/h (20 knots) and over.

(c) At each forward speed above 80% of the climbout speed, the airspeed indicator must indicate true airspeed, at sea-level with a standard atmosphere, to within an allowable installation error of not more than the greater of:

- (1) $\pm 3\%$ of the calibrated airspeed; or
- (2) 9.3 km/h (5 knots).

CS 27.1325 Static pressure systems

(a) Each instrument with static air case connections must be vented so that the influence of rotorcraft speed, the opening and closing of windows, airflow variation, and moisture or other foreign matter does not seriously affect its accuracy.

(b) Each static pressure port must be designed and located in such a manner that the correlation between air pressure in the static pressure system and true ambient atmospheric static pressure is not altered when the rotorcraft encounters icing conditions. An anti-icing means or an alternate source of static pressure may be used in showing compliance with this requirement. If the reading of the altimeter, when on the alternate static pressure system, differs from the reading of the altimeter when on the primary static system by more than 15 m (50 feet), a correction card must be provided for the alternate static system.

(c) Except as provided in sub-paragraph (d), if the static pressure system incorporates both a primary and an alternate static pressure source, the means for selecting one or the other source must be designed so that:

(1) When either source is selected, the other is blocked off, and

(2) Both sources cannot be blocked off simultaneously.

(d) For unpressurised rotorcraft, sub-paragraph (c)(1) does not apply if it can be demonstrated that the static pressure system calibration, when either static pressure source is selected is not changed by the other static pressure source being open or blocked.

CS 27.1327 Magnetic direction indicator

(a) Except as provided in sub-paragraph (b):

CS-27 BOOK 1

(1) Each magnetic direction indicator must be installed so that its accuracy is not excessively affected by the rotorcraft's vibration or magnetic fields; and

(2) The compensated installation may not have a deviation, in level flight, greater than 10° on any heading.

(b) A magnetic non-stabilised direction indicator may deviate more than 10° due to the operation of electrically powered systems such as electrically heated windshields if either a magnetic stabilised direction indicator, which does not have a deviation in level flight greater than 10° on any heading, or a gyroscopic direction indicator, is installed. Deviations of a magnetic non-stabilised direction indicator of more than 10° must be placarded in accordance with CS 27.1547 (e).

CS 27.1329 Automatic pilot system

(a) Each automatic pilot system must be designed so that the automatic pilot can:

(1) Be sufficiently overpowered by one pilot to allow control of the rotorcraft; and

(2) Be readily and positively disengaged by each pilot to prevent it from interfering with control of the rotorcraft.

(b) Unless there is automatic synchronisation, each system must have a means to readily indicate to the pilot the alignment of the actuating device in relation to the control system it operates.

(c) Each manually operated control for the system's operation must be readily accessible to the pilots.

(d) The system must be designed and adjusted so that, within the range of adjustment available to the pilot, it cannot produce hazardous loads on the rotorcraft or create hazardous deviations in the flight path under any flight condition appropriate to its use, either during normal operation or in the event of a malfunction, assuming that corrective action begins within a reasonable period of time.

(e) If the automatic pilot integrates signals from auxiliary controls or furnishes signals for operation of other equipment, there must be positive interlocks and sequencing of engagement to prevent improper operation.

(f) If the automatic pilot system can be coupled to airborne navigation equipment, means must be provided to indicate to the pilots the current mode of operation. Selector switch position is not acceptable as a means of indication.

CS 27.1335 Flight director systems

If a flight director system is installed, means must be provided to indicate to the flight crew its current mode of operation. Selector switch position is not acceptable as a means of indication.

CS 27.1337 Powerplant instruments

(a) *Instruments and instrument lines*

(1) Each powerplant instrument line must meet the requirements of CS 27.961 and 27.993.

(2) Each line carrying flammable fluids under pressure must:

(i) Have restricting orifices or other safety devices at the source of pressure to prevent the escape of excessive fluid if the line fails; and

(ii) Be installed and located so that the escape of fluids would not create a hazard.

(3) Each powerplant instrument that utilises flammable fluids must be installed and located so that the escape of fluid would not create a hazard.

(b) *Fuel quantity indicator.* Each fuel quantity indicator must be installed to clearly indicate to the flight crew the quantity of fuel in each tank in flight. In addition:

(1) Each fuel quantity indicator must be calibrated to read 'zero' during level flight when the quantity of fuel remaining in the tank is equal to the unusable fuel supply determined under CS 27.959;

(2) When two or more tanks are closely interconnected by a gravity feed system and vented, and when it is impossible to feed from each tank separately, at least one fuel quantity indicator must be installed; and

(3) Each exposed sight gauge used as a fuel quantity indicator must be protected against damage.

(c) *Fuel flow meter system.* If a fuel flow meter system is installed, each metering component must have a means for bypassing the fuel supply if malfunction of that component severely restricts fuel flow.

(d) *Oil quantity indicator.* There must be means to indicate the quantity of oil in each tank:

(1) On the ground (including during the filling of each tank); and

(2) In flight, if there is an oil transfer system or reserve oil supply system.

CS-27 BOOK 1

(e) *Chip detection system.* Rotor drive system transmissions and gearboxes utilising ferromagnetic materials must be equipped with chip detection systems designed and demonstrated to effectively indicate the presence of ferromagnetic particles resulting from damage or excessive wear within the transmission or gearbox. Each chip detection system must:

(1) be designed to provide a signal to the warning or caution devices in accordance with CS 27.1305(v); and

(2) be provided with a means to allow crew members to check or to be informed of, in flight, whether the electrical circuits of the chip detection system function correctly.

[Amdt No: 27/9]

ELECTRICAL SYSTEMS AND EQUIPMENT**CS 27.1351 General**

(a) *Electrical system capacity.* Electrical equipment must be adequate for its intended use. In addition:

(1) Electric power sources, their transmission cables, and their associated control and protective devices must be able to furnish the required power at the proper voltage to each load circuit essential for safe operation; and

(2) Compliance with paragraph (a) (1) must be shown by an electrical load analysis, or by electrical measurements that take into account the electrical loads applied to the electrical system, in probable combinations and for probable durations.

(b) *Function.* For each electrical system the following apply:

(1) Each system, when installed, must be:

(i) Free from hazards in itself, in its method of operation, and in its effects on other parts of the rotorcraft; and

(ii) Protected from fuel, oil, water, other detrimental substances, and mechanical damage.

(2) Electric power sources must function properly when connected in combination or independently.

(3) No failure or malfunction of any source may impair the ability of any remaining source to supply load circuits essential for safe operation.

(4) Each electric power source control must allow the independent operation of each source.

(c) *Generating system.* There must be at least one generator if the system supplies power to load circuits essential for safe operation. In addition:

(1) Each generator must be able to deliver its continuous rated power;

(2) Generator voltage control equipment must be able to dependably regulate each generator output within rated limits;

(3) Each generator must have a reverse current cut-out designed to disconnect the generator from the battery and from the other generators when enough reverse current exists to damage that generator; and

(4) Each generator must have an over voltage control designed and installed to prevent damage to the electrical system, or to equipment supplied by the electrical system, that could result if that generator were to develop an over voltage condition.

(d) *Instruments.* There must be means to indicate to appropriate crew members the electric power system quantities essential for safe operation of the system. In addition –

(1) For direct current systems, an ammeter that can be switched into each generator feeder may be used; and

(2) If there is only one generator, the ammeter may be in the battery feeder.

(e) *External power.* If provisions are made for connecting external power to the rotorcraft, and that external power can be electrically connected to equipment other than that used for engine starting, means must be provided to ensure that no external power supply having a reverse polarity, or a reverse phase sequence, can supply power to the rotorcraft's electrical system.

CS 27.1353 Storage battery design and installation

(a) Each storage battery must be designed and installed as prescribed in this paragraph.

(b) Safe cell temperatures and pressures must be maintained during any probable charging and discharging condition. No uncontrolled increase in cell temperature may result when the battery is recharged (after previous complete discharge):

(1) At maximum regulated voltage or power;

CS-27 BOOK 1

(2) During a flight of maximum duration; and

(3) Under the most adverse cooling condition likely to occur in service.

(c) Compliance with sub-paragraph (b) must be shown by test unless experience with similar batteries and installations has shown that maintaining safe cell temperatures and pressures presents no problem.

(d) No explosive or toxic gases emitted by any battery in normal operation, or as the result of any probable malfunction in the charging system or battery installation, may accumulate in hazardous quantities within the rotorcraft.

(e) No corrosive fluids or gases that may escape from the battery may damage surrounding structures or adjacent essential equipment.

(f) Each nickel cadmium battery installation capable of being used to start an engine or auxiliary power unit must have provisions to prevent any hazardous effect on structure or essential systems that may be caused by the maximum amount of heat the battery can generate during a short circuit of the battery or of its individual cells.

(g) Nickel cadmium battery installations capable of being used to start an engine or auxiliary power unit must have:

(1) A system to control the charging rate of the battery automatically so as to prevent battery overheating;

(2) A battery temperature sensing and over-temperature warning system with a means for disconnecting the battery from its charging source in the event of an over-temperature condition; or

(3) A battery failure sensing and warning system with a means for disconnecting the battery from its charging source in the event of battery failure.

CS 27.1357 Circuit protective devices

(a) Protective devices, such as fuses or circuit breakers, must be installed in each electrical circuit other than:

(1) The main circuits of starter motors; and

(2) Circuits in which no hazard is presented by their omission.

(b) A protective device for a circuit essential to flight safety may not be used to protect any other circuit.

(c) Each resettable circuit protective device ('trip free' device in which the tripping

mechanism cannot be overridden by the operating control) must be designed so that:

(1) A manual operation is required to restore service after tripping; and

(2) If an overload or circuit fault exists, the device will open the circuit regardless of the position of the operating control.

(d) If the ability to reset a circuit breaker or replace a fuse is essential to safety in flight, that circuit breaker or fuse must be located and identified so that it can be readily reset or replaced in flight.

(e) If fuses are used, there must be one spare of each rating, or 50% spare fuses of each rating, whichever is greater.

CS 27.1361 Master switch

(a) There must be a master switch arrangement to allow ready disconnection of each electric power source from the main bus. The point of disconnection must be adjacent to the sources controlled by the switch.

(b) Load circuits may be connected so that they remain energised after the switch is opened, if they are protected by circuit protective devices, rated at five amperes or less, adjacent to the electric power source.

(c) The master switch or its controls must be installed so that the switch is easily discernible and accessible to a crew member in flight.

CS 27.1365 Electric cables

(a) Each electric connecting cable must be of adequate capacity.

(b) Each cable that would overheat in the event of circuit overload or fault must be at least flame resistant and may not emit dangerous quantities of toxic fumes.

(c) Insulation on electrical wire and cable installed in the rotorcraft must be self-extinguishing when tested in accordance with CS-25, appendix F, part I (a)(3).

CS 27.1367 Switches

Each switch must be:

(a) Able to carry its rated current;

(b) Accessible to the crew; and

(c) Labelled as to operation and the circuit controlled.

CS-27 BOOK 1

LIGHTS

CS 27.1381 Instrument lights

The instrument lights must:

- (a) Make each instrument, switch, and other devices for which they are provided easily readable; and
- (b) Be installed so that:
 - (1) Their direct rays are shielded from the pilot's eyes; and
 - (2) No objectionable reflections are visible to the pilot.

CS 27.1383 Landing lights

- (a) Each required landing or hovering light must be approved.
- (b) Each landing light must be installed so that:
 - (1) No objectionable glare is visible to the pilot;
 - (2) The pilot is not adversely affected by halation; and
 - (3) It provides enough light for night operation, including hovering and landing.
- (c) At least one separate switch must be provided, as applicable:
 - (1) For each separately installed landing light; and
 - (2) For each group of landing lights installed at a common location.

CS 27.1385 Position light system installation

- (a) *General.* Each part of each position light system must meet the applicable requirements of this paragraph, and each system as a whole must meet the requirements of CS 27.1387 to 27.1397.
- (b) *Forward position lights.* Forward position lights must consist of a red and a green light spaced laterally as far apart as practicable and installed forward on the rotorcraft so that, with the rotorcraft in the normal flying position, the red light is on the left side and the green light is on the right side. Each light must be approved.
- (c) *Rear position light.* The rear position light must be a white light mounted as far aft as practicable, and must be approved.

(d) *Circuit.* The two forward position lights and the rear position light must make a single circuit.

(e) *Light covers and colour filters.* Each light cover or colour filter must be at least flame resistant and may not change colour or shape or lose any appreciable light transmission during normal use.

CS 27.1387 Position light system dihedral angles

(a) Except as provided in sub-paragraph (e), each forward and rear position light must, as installed, show unbroken light within the dihedral angles described in this paragraph.

(b) Dihedral angle L (left) is formed by two intersecting vertical planes, the first parallel to the longitudinal axis of the rotorcraft, and the other at 110° to the left of the first, as viewed when looking forward along the longitudinal axis.

(c) Dihedral angle R (right) is formed by two intersecting vertical planes, the first parallel to the longitudinal axis of the rotorcraft, and the other at 110° to the right of the first, as viewed when looking forward along the longitudinal axis.

(d) Dihedral angle A (aft) is formed by two intersecting vertical planes making angles of 70° to the right and to the left, respectively, to a vertical plane passing through the longitudinal axis, as viewed when looking aft along the longitudinal axis.

(e) If the rear position light, when mounted as far aft as practicable in accordance with 27.1385 (c), cannot show unbroken light within dihedral angle A (as defined in sub-paragraph (d)), a solid angle or angles of obstructed visibility totalling not more than 0.04 steradians is allowable within that dihedral angle, if such solid angle is within a cone whose apex is at the rear position light and whose elements make an angle of 30° with a vertical line passing through the rear position light.

CS 27.1389 Position light distribution and intensities

(a) *General.* The intensities prescribed in this paragraph must be provided by new equipment with light covers and colour filters in place. Intensities must be determined with the light source operating at a steady value equal to the average luminous output of the source at the normal operating voltage of the rotorcraft. The

CS-27 BOOK 1

light distribution and intensity of each position light must meet the requirements of subparagraph (b).

(b) *Forward and rear position lights.* The light distribution and intensities of forward and rear position lights must be expressed in terms of minimum intensities in the horizontal plane, minimum intensities in any vertical plane, and maximum intensities in overlapping beams, within dihedral angles L, R, and A, and must meet the following requirements:

(1) *Intensities in the horizontal plane.*

Each intensity in the horizontal plane (the plane containing the longitudinal axis of the rotorcraft and perpendicular to the plane of symmetry of the rotorcraft) must equal or exceed the values in CS 27.1391.

(2) *Intensities in any vertical plane.*

Each intensity in any vertical plane (the plane perpendicular to the horizontal plane) must equal or exceed the appropriate value in CS 27.1393, where *I* is the minimum intensity prescribed in CS 27.1391 for the corresponding angles in the horizontal plane.

(3) *Intensities in overlaps between adjacent signals.* No intensity in any overlap between adjacent signals may exceed the values in CS 27.1395, except that higher intensities in overlaps may be used with main beam intensities substantially greater than the minima specified in CS 27.1391 and 27.1393, if the overlap intensities in relation to the main beam intensities do not adversely affect signal clarity. When the peak intensity of the forward position lights is greater than 100 candelas, the maximum overlap intensities between them may exceed the values in CS 27.1395 if the overlap intensity in Area A is not more than 10% of peak position light intensity and the overlap intensity in Area B is not more than 2.5% of peak position light intensity.

CS 27.1391 Minimum intensities in the horizontal plane of forward and rear position lights

Each position light intensity must equal or exceed the applicable values in the following table:

| Dihedral angle (light included) | Angle from right or left of longitudinal axis, measured from dead ahead | Intensity (candelas) |
|---------------------------------|---|----------------------|
| L and R (forward red) | 0° to 10° | 40 |

| | | |
|----------------|--------------|----|
| and green) | 10° to 20° | 30 |
| | 20° to 110° | 5 |
| A (rear white) | 110° to 180° | 20 |

CS 27.1393 Minimum intensities in any vertical plane of forward and rear position lights

Each position light intensity must equal or exceed the applicable values in the following table:

| Angle above or below the horizontal plane – | Intensity |
|---|---------------|
| 0 | 1.0 <i>I</i> |
| 0° to 5° | 0.90 <i>I</i> |
| 5° to 10° | 0.80 <i>I</i> |
| 10° to 15° | 0.70 <i>I</i> |
| 15° to 20° | 0.50 <i>I</i> |
| 20° to 30° | 0.30 <i>I</i> |
| 30° to 40° | 0.10 <i>I</i> |
| 40° to 90° | 0.05 <i>I</i> |

CS 27.1395 Maximum intensities in overlapping beams of forward and rear position lights

No position light intensity may exceed the applicable values in the following table, except as provided in CS 27.1389(b)(3):

| Overlaps | Maximum intensity | |
|--------------------------------|-------------------|-------------------|
| | Area A (candelas) | Area B (candelas) |
| Green in dihedral angle L | 10 | 1 |
| Red in dihedral angle R | 10 | 1 |
| Green in dihedral angle A | 5 | 1 |
| Red in dihedral angle A | 5 | 1 |
| Rear white in dihedral angle L | 5 | 1 |
| Rear white in dihedral angle R | 5 | 1 |

Where:

(a) Area A includes all directions in the adjacent dihedral angle that pass through the light source and intersect the common boundary plane at more than 10° but less than 20°; and

(b) Area B includes all directions in the adjacent dihedral angle that pass through the light source and intersect the common boundary plane at more than 20°.

CS 27.1397 Colour specifications

Each position light colour must have the applicable International Commission on Illumination chromaticity co-ordinates as follows:

CS-27 BOOK 1

(a) *Aviation red:*

'y' is not greater than 0.335; and

'z' is not greater than 0.002.

(b) *Aviation green:*

'x' is not greater than $0.440 - 0.320y$;

'x' is not greater than $y - 0.170$; and

'y' is not less than $0.390 - 0.170x$.

(c) *Aviation white:*

'x' is not less than 0.300 and not greater than 0.540;

'y' is not less than 'x-0.040' or 'y_o-0.010', whichever is the smaller; and

'y' is not greater than 'x + 0.020' nor '0.636 - 0.400x';

Where 'y_o' is the 'y' co-ordinate of the Planckian radiator for the value of 'x' considered.

CS 27.1399 Riding light

(a) Each riding light required for water operation must be installed so that it can:

(1) Show a white light for at least 3.7 km (two nautical miles) at night under clear atmospheric conditions; and

(2) Show a maximum practicable unbroken light with the rotorcraft on the water.

(b) Externally hung lights may be used.

CS 27.1401 Anti-collision light system

(a) *General.* If certification for night operation is requested, the rotorcraft must have an anti-collision light system that:

(1) Consists of one or more approved anti-collision lights located so that their emitted light will not impair the crew's vision or detract from the conspicuity of the position lights; and

(2) Meets the requirements of sub-paragraphs (b) to (f).

(b) *Field of coverage.* The system must consist of enough lights to illuminate the vital areas around the rotorcraft, considering the physical configuration and flight characteristics of the rotorcraft. The field of coverage must extend in each direction within at least 30° above and 30° below the horizontal plane of the rotorcraft, except that there may be solid angles

of obstructed visibility totalling not more than 0.5 steradians.

(c) *Flashing characteristics.* The arrangement of the system, that is, the number of light sources, beam width, speed of rotation, and other characteristics, must give an effective flash frequency of not less than 40, nor more than 100, cycles per minute. The effective flash frequency is the frequency at which the rotorcraft's complete anti-collision light system is observed from a distance, and applies to each sector of light including any overlaps that exist when the system consists of more than one light source. In overlaps, flash frequencies may exceed 100, but not 180, cycles per minute.

(d) *Colour.* Each anti-collision light must be aviation red and must meet the applicable requirements of CS 27.1397.

(e) *Light intensity.* The minimum light intensities in any vertical plane, measured with the red filter (if used) and expressed in terms of 'effective' intensities, must meet the requirements of sub-paragraph (f). The following relation must be assumed:

where: I_e = effective intensity (candelas).

$I(t)$ = instantaneous intensity as a function of time.

$t_2 - t_1$ = flash time interval (seconds).

Normally, the maximum value of effective intensity is obtained when t_2 and t_1 are chosen so that the effective intensity is equal to the instantaneous intensity at t_2 and t_1 .

(f) *Minimum effective intensities for anti-collision light.* Each anti-collision light effective intensity must equal or exceed the applicable values in the following table:

| Angle above or below the horizontal plane | Effective intensity (candelas) |
|---|--------------------------------|
| 0° to 5° | 150 |
| 5° to 10° | 90 |
| 10° to 20° | 30 |
| 20° to 30° | 15 |

SAFETY EQUIPMENT**CS 27.1411 General**

(a) *Accessibility.* Required safety equipment to be used by the crew in an emergency must be readily accessible.

CS-27 BOOK 1

(b) *Stowage provisions.* Stowage provisions for required safety equipment must be furnished and must:

(1) be arranged so that the equipment is directly accessible and its location is obvious; and

(2) protect the safety equipment from damage.

[Amdt No: 27/5]

CS 27.1413 Safety belts

Each safety belt must be equipped with a metal to metal latching device.

CS 27.1415 Ditching equipment

If certification with ditching provisions or emergency flotation provisions is requested by the applicant, the additional safety equipment required by any applicable operating rule must meet the requirements of this CS.

(a) All equipment must be approved.

(b) Life rafts.

(1) Required life raft(s) must be remotely deployable for use in an emergency. Remote controls capable of deploying the life raft(s) must be located within easy reach of the flight crew, occupants of the passenger cabin and survivors in the water, with the rotorcraft in the upright floating or capsized position. It must be substantiated that life rafts sufficient to accommodate all rotorcraft occupants, without exceeding the rated capacity of any life raft, can be reliably deployed with the rotorcraft in any

$$I_e = \frac{\int_{t_1}^{t_2} I(t)dt}{0.2 + (t_2 - t_1)}$$

reasonably foreseeable floating attitude, including capsized, and in the sea conditions chosen for showing compliance with CS 27.801(e).

(2) Each life raft must be attached to the rotorcraft by a short retaining line to keep it alongside the rotorcraft and a long retaining line designed to keep it attached to the rotorcraft. Both retaining lines must be weak enough to break before submerging the empty life raft to which they are attached. The long retaining line must be of sufficient length that a drifting life raft will not be drawn towards any part of the rotorcraft that would pose a

danger to the life raft itself or the persons on board.

(3) Each life raft must be substantiated as suitable for use in all sea conditions covered by the certification with ditching or emergency flotation provisions.

(c) Life preservers.

If the applicable operating rule allows for life preservers not to be worn at all times, stowage provisions must be provided that accommodate one life preserver for each occupant for which certification with ditching or emergency flotation provisions is requested. A life preserver must be within easy reach of each occupant while seated.

[Amdt No: 27/5]

CS 27.1419 Ice protection

(a) To obtain certification for flight into icing conditions, compliance with this paragraph must be shown.

(b) It must be demonstrated that the rotorcraft can be safely operated in the continuous maximum and intermittent maximum icing conditions determined under appendix C of CS-29 within the rotorcraft altitude envelope. An analysis must be performed to establish, on the basis of the rotorcraft's operational needs, the adequacy of the ice protection system for the various components of the rotorcraft.

(c) In addition to the analysis and physical evaluation prescribed in sub-paragraph (b), the effectiveness of the ice protection system and its components must be shown by flight tests of the rotorcraft or its components in measured atmospheric icing conditions and by one or more of the following tests as found necessary to determine the adequacy of the ice protection system:

(1) Laboratory dry air or simulated icing tests, or a combination of both, of the components or models of the components.

(2) Flight dry air tests of the ice protection system as a whole, or its individual components.

(3) Flight tests of the rotorcraft or its components in measured simulated icing conditions.

(d) The ice protection provisions of this paragraph are considered to be applicable primarily to the airframe. Powerplant installation requirements are contained in Subpart E of this CS-27.

CS-27 BOOK 1

(e) A means must be identified or provided for determining the formation of ice on critical parts of the rotorcraft. Unless otherwise restricted, the means must be available for night-time as well as daytime operation. The rotorcraft flight manual must describe the means of determining ice formation and must contain information necessary for safe operation of the rotorcraft in icing conditions.

CS 27.1435 Hydraulic systems

(a) *Design.* Each hydraulic system and its elements must withstand, without yielding, any structural loads expected in addition to hydraulic loads.

(b) *Tests.* Each system must be substantiated by proof pressure tests. When proof tested, no part of any system may fail, malfunction, or experience a permanent set. The proof load of each system must at least 1.5 times the maximum operating pressure of that system.

(c) *Accumulators.* No hydraulic accumulator or pressurised reservoir may be installed on the engine side of any firewall unless it is an integral part of an engine.

CS 27.1457 Cockpit voice recorders

(a) Each cockpit voice recorder required by the applicable operating rules must be approved, and must be installed so that it will record the following:

(1) Voice communications transmitted from or received in the rotorcraft by radio.

(2) Voice communications of flight-crew members on the flight deck.

(3) Voice communications of flight-crew members on the flight deck, using the rotorcraft's interphone system.

(4) Voice or audio signals identifying navigation or approach aids introduced into a headset or speaker.

(5) Voice communications of flight-crew members using the passenger loudspeaker system, if there is such a system, and if the fourth channel is available in accordance with the requirements of sub-paragraph (c) (4) (ii).

(b) The recording requirements of sub-paragraph (a) (2) may be met:

(1) By installing a cockpit-mounted area microphone located in the best position for recording voice communications originating at the first and second pilot

stations and voice communications of other crew members on the flight deck when directed to those stations; or

(2) By installing a continually energised or voice-activated lip microphone at the first and second pilot stations. The microphone specified in this paragraph must be so located and if necessary, the preamplifiers and filters of the recorder must be adjusted or supplemented so that the recorded communications are intelligible when recorded under flight cockpit noise conditions and played back. The level of intelligibility must be approved by the Agency. Repeated aural or visual playback of the record may be used in evaluating intelligibility.

(c) Each cockpit voice recorder must be installed so that the part of the communication or audio signals specified in sub-paragraph (a) obtained from each of the following sources is recorded on a separate channel:

(1) For the first channel, from each microphone, headset, or speaker used at the first pilot station.

(2) For the second channel, from each microphone, headset, or speaker used at the second pilot station.

(3) For the third channel, from the cockpit-mounted area microphone, or the continually energised or voice-activated lip microphone at the first and second pilot stations.

(4) For the fourth channel, from:

(i) Each microphone, headset, or speaker used at the stations for the third and fourth crew members; or

(ii) If the stations specified in sub-paragraph (c) (4) (i) are not required or if the signal at such a station is picked up by another channel, each microphone on the flight deck that is used with the passenger loud-speaker system if its signals are not picked up by another channel.

(iii) Each microphone on the flight deck that is used with the rotorcraft's loudspeaker system if its signals are not picked up by another channel.

(d) Each cockpit voice recorder must be installed so that:

(1) It receives its electric power from the bus that provides the maximum reliability for operation of the cockpit voice recorder

CS-27 BOOK 1

without jeopardising service to essential or emergency loads;

(2) There is an automatic means to simultaneously stop the recorder and prevent each erasure feature from functioning, within 10 minutes after crash impact; and

(3) There is an aural or visual means for pre-flight checking of the recorder for proper operation.

(e) The record container must be located and mounted to minimise the probability of rupture of the container as a result of crash impact and consequent heat damage to the record from fire.

(f) If the cockpit voice recorder has a bulk erasure device, the installation must be designed to minimise the probability of inadvertent operation and actuation of the device during crash impact.

(g) Each recorder container must be either bright orange or bright yellow.

CS 27.1459 Flight recorders

(a) Each flight recorder required by the applicable operating rules must be installed so that:

(1) It is supplied with airspeed, altitude, and directional data obtained from sources that meet the accuracy requirements of CS 27.1323, CS 27.1325, and 27.1327, as applicable;

(2) The vertical acceleration sensor is rigidly attached, and located longitudinally within the approved centre of gravity limits of the rotorcraft;

(3) It receives its electrical power from the bus that provides the maximum reliability for operation of the flight recorder without jeopardising service to essential or emergency loads;

(4) There is an aural or visual means for pre-flight checking of the recorder for proper recording of data in the storage medium;

(5) Except for recorders powered solely by the engine-driven electrical generator system, there is an automatic means to simultaneously stop a recorder that has a data erasure feature and prevent each erasure feature from functioning, within 10 minutes after any crash impact; and

(b) Each non-ejectable recorder container must be located and mounted so as to minimise

the probability of container rupture resulting from crash impact and subsequent damage to the record from fire.

(c) A correlation must be established between the flight recorder readings of airspeed, altitude, and heading and the corresponding readings (taking into account correction factors) of the first pilot's instruments. This correlation must cover the airspeed range over which the aircraft is to be operated, the range of altitude to which the aircraft is limited, and 360° of heading. Correlation may be established on the ground as appropriate.

(d) Each recorder container must:

(1) Be either bright orange or bright yellow;

(2) Have a reflective tape affixed to its external surface to facilitate its location underwater; and

(3) Have an underwater locating device, when required by the applicable operating rules, on or adjacent to the container which is secured in such a manner that they are not likely to be separated during crash impact.

CS 27.1461 Equipment containing high energy rotors

(a) Equipment containing high energy rotors must meet sub-paragraphs (b), (c), or (d).

(b) High energy rotors contained in equipment must be able to withstand damage caused by malfunctions, vibration, abnormal speeds, and abnormal temperatures. In addition:

(1) Auxiliary rotor cases must be able to contain damage caused by the failure of high energy rotor blades; and

(2) Equipment control devices, systems, and instrumentation must reasonably ensure that no operating limitations affecting the integrity of high energy rotors will be exceeded in service.

(c) It must be shown by test that equipment containing high energy rotors can contain any failure of a high energy rotor that occurs at the highest speed obtainable with the normal speed control devices inoperative.

(d) Equipment containing high energy rotors must be located where rotor failure will neither endanger the occupants nor adversely affect continued safe flight.

CS-27 BOOK 1

CS 27.1470 Emergency locator transmitter

Each emergency locator transmitter, including sensors and antennae, required by the applicable operating rule, must be installed so as to minimise damage that would prevent its functioning following an accident or incident.

[Amdt No: 27/5]

CS-27 BOOK 1

SUBPART G – OPERATING LIMITATIONS AND INFORMATION

GENERAL

CS 27.1501 General

(a) Each operating limitation specified in CS 27.1503 to 27.1525 and other limitations and information necessary for safe operation must be established.

(b) The operating limitations and other information necessary for safe operation must be made available to the crew members as prescribed in CS 27.1541 to 27.1593.

[Amdt No: 27/4]

OPERATING LIMITATIONS

CS 27.1503 Airspeed limitations: general

(a) An operating speed range must be established.

(b) When airspeed limitations are a function of weight, weight distribution, altitude, rotor speed, power, or other factors, airspeed limitations corresponding with the critical combinations of these factors must be established.

CS 27.1505 Never-exceed speed

(a) The never-exceed speed, V_{NE} , must be established so that it is:

- (1) Not less than 74 km/h (40 knots) (CAS); and
- (2) Not more than the lesser of:
 - (i) 0.9 times the maximum forward speeds established under CS 27.309;
 - (ii) 0.9 times the maximum speed shown under CS 27.251 and 27.629; or
 - (iii) 0.9 times the maximum speed substantiated for advancing blade tip mach number effects.

(b) V_{NE} may vary with altitude, rpm, temperature, and weight, if:

- (1) No more than two of these variables (or no more than two instruments integrating more

than one of these variables) are used at one time; and

(2) The ranges of these variables (or of the indications on instruments integrating more than one of these variables) are large enough to allow an operationally practical and safe variation of V_{NE} .

(c) For helicopters, a stabilised power-off V_{NE} denoted as V_{NE} (power-off) may be established at a speed less than V_{NE} established pursuant to subparagraph (a), if the following conditions are met:

(1) V_{NE} (power-off) is not less than a speed midway between the power-on V_{NE} and the speed used in meeting the requirements of:

- (i) CS 27.65(b) for single engine helicopters; and
- (ii) CS 27.67 for multi-engine helicopters.

(2) V_{NE} (power-off) is:

- (i) A constant airspeed;
- (ii) A constant amount less than power-on V_{NE} ; or
- (iii) A constant airspeed for a portion of the altitude range for which certification is requested, and a constant amount less than power-on V_{NE} for the remainder of the altitude range.

CS 27.1509 Rotor speed

(a) *Maximum power-off (autorotation)*. The maximum power-off rotor speed must be established so that it does not exceed 95% of the lesser of:

- (1) The maximum design rpm determined under CS 27.309(b); and
- (2) The maximum rpm shown during the type tests.

(b) *Minimum power-off*. The minimum power-off rotor speed must be established so that it is not less than 105% of the greater of:

- (1) The minimum shown during the type tests; and
- (2) The minimum determined by design substantiation.

(c) *Minimum power-on*. The minimum power-on rotor speed must be established so that it is:

- (1) Not less than the greater of:

CS-27 BOOK 1

(i) The minimum shown during the type tests; and

(ii) The minimum determined by design substantiation; and

(2) Not more than a value determined under CS 27.33 (a)(1) and (b)(l).

CS 27.1519 Weight and centre of gravity

The weight and centre of gravity limitations determined under CS 27.25 and 27.27, respectively, must be established as operating limitations.

CS 27.1521 Powerplant limitations

(a) *General.* The powerplant limitations prescribed in this paragraph must be established so that they do not exceed the corresponding limits for which the engines are type certificated.

(b) *Take-off operation.* The powerplant take-off operation must be limited by:

(1) The maximum rotational speed, which may not be greater than:

(i) The maximum value determined by the rotor design; or

(ii) The maximum value shown during the type tests;

(2) The maximum allowable manifold pressure (for reciprocating engines);

(3) The time limit for the use of the power corresponding to the limitations established in sub-paragraphs (b)(1) and (2);

(4) If the time limit in sub-paragraph (b)(3) exceeds 2 minutes, the maximum allowable cylinder head, coolant outlet, or oil temperatures;

(5) The gas temperature limits for turbine engines over the range of operating and atmospheric conditions for which certification is requested.

(c) *Continuous operation.* The continuous operation must be limited by:

(1) The maximum rotational speed which may not be greater than:

(i) The maximum value determined by the rotor design; or

(ii) The maximum value shown during the type tests;

(2) The minimum rotational speed shown under the rotor speed requirements in CS 27.1509(c); and

(3) The gas temperature limits for turbine engines over the range of operating and atmospheric conditions for which certification is requested.

(d) *Fuel grade or designation.* The minimum fuel grade (for reciprocating engines), or fuel designation (for turbine engines), must be established so that it is not less than that required for operation of the engines within the limitations in sub-paragraphs (b) and (c).

(e) *Turboshaft engine torque.* For rotorcraft with main rotors driven by turboshaft engines, and that do not have a torque limiting device in the transmission system, the following apply:

(1) A limit engine torque must be established if the maximum torque that the engine can exert is greater than:

(i) The torque that the rotor drive system is designed to transmit; or

(ii) The torque that the main rotor assembly is designed to withstand in showing compliance with CS 27.547(d).

(2) The limit engine torque established under sub-paragraph (e)(1) may not exceed either torque specified in sub-paragraph (e)(1)(i) or (ii).

(f) *Ambient temperature.* For turbine engines, ambient temperature limitations (including limitations for winterization installations, if applicable) must be established as the maximum ambient atmospheric temperature at which compliance with the cooling provisions of CS 27.1041 to 27.1045 is shown.

(g) *Two and one-half minute OEI power operation.* Unless otherwise authorised, the use of 2½-minute OEI power must be limited to engine failure operation of multi-engine, turbine-powered rotorcraft for not longer than 2½ minutes after failure of an engine. The use of 2½-minute OEI power must also be limited by:

(1) The maximum rotational speed, which may not be greater than:

(i) The maximum value determined by the rotor design; or

(ii) The maximum demonstrated during the type tests;

(2) The maximum allowable gas temperature; and

(3) The maximum allowable torque.

(h) *Thirty-minute OEI power operation.* Unless otherwise authorised, the use of 30-minute OEI power

CS-27 BOOK 1

must be limited to multi-engine, turbine-powered rotorcraft for not longer than 30 minutes after failure of an engine. The use of 30-minute OEI power must also be limited by:

(1) The maximum rotational speed which may not be greater than:

(i) The maximum value determined by the rotor design; or

(ii) The maximum value demonstrated during the type tests;

(2) The maximum allowable gas temperature; and

(3) The maximum allowable torque.

(i) *Continuous OEI power operation.* Unless otherwise authorised, the use of continuous OEI power must be limited to multi-engine, turbine-powered rotorcraft for continued flight after failure of an engine. The use of continuous OEI power must also be limited by:

(1) The maximum rotational speed, which may not be greater than:

(i) The maximum value determined by the rotor design; or

(ii) The maximum value demonstrated during the type tests;

(2) The maximum allowable gas temperature; and

(3) The maximum allowable torque.

(j) *Rated 30-second OEI power operation.* Rated 30-second OEI power is permitted only on multi-engine, turbine-powered rotorcraft, also certificated for the use of rated 2-minute OEI power, and can only be used for continued operation of the remaining engine(s) after a failure or precautionary shutdown of an engine. It must be shown that following application of 30-second OEI power, any damage will be readily detectable by the applicable inspections and other related procedures furnished in accordance with paragraph A27.4 of Appendix A of this CS-27. The use of 30-second OEI power must be limited to not more than 30 seconds for any period in which that power is used, and by:

(1) The maximum rotational speed which may not be greater than:

(i) The maximum value determined by the rotor design; or

(ii) The maximum value demonstrated during the type tests;

(2) The maximum allowable gas temperature; and

(3) The maximum allowable torque.

(k) *Rated 2-minute OEI power operation.* Rated 2-minute OEI power is permitted only on multi-engine, turbine-powered rotorcraft, also certificated for the use of rated 30-second OEI power, and can only be used for continued operation of the remaining engine(s) after a failure or precautionary shutdown of an engine. It must be shown that following application of 2-minute OEI power, any damage will be readily detectable by the applicable inspections and other related procedures furnished in accordance with A27.4 of appendix A of this CS-27. The use of 2-minute OEI power must be limited to not more than 2 minutes for any period in which that power is used, and by:

(1) The maximum rotational speed, which may not be greater than:

(i) The maximum value determined by the rotor design; or

(ii) The maximum value demonstrated during the type tests;

(2) The maximum allowable gas temperature; and

(3) The maximum allowable torque.

[Amdt No: 27/3]

CS 27.1523 Minimum flight crew

The minimum flight crew must be established so that it is sufficient for safe operation, considering:

(a) The workload on individual crew members;

(b) The accessibility and ease of operation of necessary controls by the appropriate crew member; and

(c) The kinds of operation authorised under CS 27.1525.

CS 27.1525 Kinds of operations

The kinds of operations (such as VFR, IFR, day, night, or icing) for which the rotorcraft is approved are established by demonstrated compliance with the applicable certification requirements and by the installed equipment.

CS 27.1527 Maximum operating altitude

The maximum altitude up to which operation is allowed, as limited by flight, structural, powerplant,

CS-27 BOOK 1

functional, or equipment characteristics, must be established.

CS 27.1529 Instructions for Continued Airworthiness

Instructions for Continued Airworthiness in accordance with Appendix A must be prepared.

MARKINGS AND PLACARDS**CS 27.1541 General**

- (a) The rotorcraft must contain:
 - (1) The markings and placards specified in CS 27.1545 to 27.1565, and
 - (2) Any additional information, instrument markings, and placards required for the safe operation of rotorcraft with unusual design, operating or handling characteristics.
- (b) Each marking and placard prescribed in sub-paragraph (a):
 - (1) Must be displayed in a conspicuous place; and
 - (2) May not be easily erased, disfigured, or obscured.

CS 27.1543 Instrument markings: general

For each instrument:

- (a) When markings are on the cover glass of the instrument, there must be means to maintain the correct alignment of the glass cover with the face of the dial; and
- (b) Each arc and line must be wide enough, and located, to be clearly visible to the pilot.

CS 27.1545 Airspeed indicator

- (a) Each airspeed indicator must be marked as specified in sub-paragraph (b), with the marks located at the corresponding indicated airspeeds.
- (b) The following markings must be made:
 - (1) A red radial line:
 - (i) For rotorcraft other than helicopters, at V_{NE} ; and

- (ii) For helicopters at V_{NE} (power-on).

- (2) A red cross-hatched radial line at V_{NE} (power-off) for helicopters, if V_{NE} (power-off) is less than V_{NE} (power-on).
- (3) For the caution range, a yellow arc.
- (4) For the safe operating range, a green arc.

CS 27.1547 Magnetic direction indicator

- (a) A placard meeting the requirements of this paragraph must be installed on or near the magnetic direction indicator.
- (b) The placard must show the calibration of the instrument in level flight with the engines operating.
- (c) The placard must state whether the calibration was made with radio receivers on or off.
- (d) Each calibration reading must be in terms of magnetic heading in not more than 45° increments.
- (e) If a magnetic non-stabilised direction indicator can have a deviation of more than 10° caused by the operation of electrical equipment, the placard must state which electrical loads, or combination of loads, would cause a deviation of more than 10° when turned on.

CS 27.1549 Powerplant instruments

For each required powerplant instrument, as appropriate to the type of instrument:

- (a) Each maximum and, if applicable, minimum safe operating limit must be marked with a red radial or a red line;
- (b) Each normal operating range must be marked with a green arc or green line, not extending beyond the maximum and minimum safe limits;
- (c) Each take-off and precautionary range must be marked with a yellow arc or yellow line;
- (d) Each engine or propeller range that is restricted because of excessive vibration stresses must be marked with red arcs or red lines; and
- (e) Each OEI limit or approved operating range must be marked to be clearly differentiated from the markings of sub-paragraphs (a) to (d) except that no marking is normally required for the 30-second OEI limit.

CS-27 BOOK 1

CS 27.1551 Oil quantity indicator

Each oil quantity indicator must be marked with enough increments to indicate readily and accurately the quantity of oil.

CS 27.1553 Fuel quantity indicator

If the unusable fuel supply for any tank exceeds 3.8 litres (0.8 Imperial gallon/1 US gallon), or 5% of the tank capacity, whichever is greater, a red arc must be marked on its indicator extending from the calibrated zero reading to the lowest reading obtainable in level flight.

CS 27.1555 Control markings

(a) Each cockpit control, other than primary flight controls or control whose function is obvious, must be plainly marked as to its function and method of operation.

(b) For powerplant fuel controls:

(1) Each fuel tank selector control must be marked to indicate the position corresponding to each tank and to each existing cross feed position;

(2) If safe operation requires the use of any tanks in a specific sequence, that sequence must be marked on, or adjacent to, the selector for those tanks; and

(3) Each valve control for any engine of a multi-engine rotorcraft must be marked to indicate the position corresponding to each engine controlled.

(c) Usable fuel capacity must be marked as follows:

(1) For fuel systems having no selector controls, the usable fuel capacity of the system must be indicated at the fuel quantity indicator.

(2) For fuel systems having selector controls, the usable fuel capacity available at each selector control position must be indicated near the selector control.

(d) For accessory, auxiliary, and emergency controls:

(1) each essential visual position indicator, such as those showing rotor pitch or landing gear position, must be marked so that each crew member can determine at any time the position of the unit to which it relates; and

(2) each emergency control must be marked as to the method of operation and be red unless it may need to be operated underwater, in which case it must be marked with yellow and black stripes.

(e) For rotorcraft incorporating retractable landing gear, the maximum landing gear operating speed must be displayed in clear view of the pilot.

[Amdt No: 27/5]

CS 27.1557 Miscellaneous markings and placards

(a) *Baggage and cargo compartments, and ballast location.* Each baggage and cargo compartment and each ballast location must have a placard stating any limitations on contents, including weight, that are necessary under the loading requirements.

(b) *Seats.* If the maximum allowable weight to be carried in a seat is less than 77 kg (170 lbs), a placard stating the lesser weight must be permanently attached to the seat structure.

(c) *Fuel and oil filler openings.* The following apply:

(1) Fuel filler openings must be marked at or near the filler cover with:

(i) The word 'fuel';

(ii) For reciprocating engine-powered rotorcraft, the minimum fuel grade;

(iii) For turbine engine-powered rotorcraft, the permissible fuel designations; and

(iv) For pressure fuelling systems, the maximum permissible fuelling supply pressure and the maximum permissible defuelling pressure.

(2) Oil filler openings must be marked at or near the filler cover with the word 'oil'.

(d) *Emergency exit placards.* Each placard and operating control for each emergency exit must differ in colour from the surrounding fuselage. A placard must be near each emergency exit control and must clearly indicate the location of that exit and its method of operation.

[Amdt No: 27/5]

CS 27.1559 Limitations placard

CS-27 BOOK 1

There must be a placard in clear view of the pilot that specifies the kinds of operations (such as VFR, IFR, day, night or icing) for which the rotorcraft is approved.

CS 27.1561 Safety equipment

(a) Each safety equipment control to be operated by the crew or passenger in an emergency must be plainly marked with its identification and its method of operation.

(b) Each location, such as a locker or compartment that carries any fire extinguishing, signalling, or other safety equipment, must be appropriately marked in order to identify the contents and if necessary indicate how to remove the equipment.

(c) Each item of safety equipment carried must be marked with its identification and must have obviously marked operating instructions.

[Amdt No: 27/5]

CS 27.1565 Tail rotor

Each tail rotor must be marked so that its disc is conspicuous under normal daylight ground conditions.

ROTORCRAFT FLIGHT MANUAL AND APPROVED MANUAL MATERIAL**CS 27.1581 General**

(a) *Furnishing information.* A rotorcraft flight manual must be furnished with each rotorcraft, and it must contain the following:

(1) Information required by CS 27.1583 to 27.1589.

(2) Other information that is necessary for safe operation because of design, operating, or handling characteristics.

(b) *Approved information.* Each part of the manual listed in CS 27.1583 to 27.1589, that is appropriate to the rotorcraft, must be furnished, verified, and approved, and must be segregated, identified, and clearly distinguished from each unapproved part of that manual.

(c) (Reserved).

(d) Table of contents. Each rotorcraft flight manual must include a table of contents if the complexity of the manual indicates a need for it.

CS 27.1583 Operating limitations

(a) *Airspeed and rotor limitations.* Information necessary for the marking of airspeed and rotor limitations on, or near, their respective indicators must be furnished. The significance of each limitation and of the colour coding must be explained.

(b) *Powerplant limitations.* The following information must be furnished:

(1) Limitations required by CS 27.1521.

(2) Explanation of the limitations, when appropriate.

(3) Information necessary for marking the instruments required by CS 27.1549 to 27.1553.

(c) *Weight and loading distribution.* The weight and centre of gravity limits required by CS 27.25 and 27.27, respectively, must be furnished. If the variety of possible loading conditions warrants, instructions must be included to allow ready observance of the limitations.

(d) *Flight crew.* When a flight crew of more than one is required, the number and functions of the minimum flight crew determined under CS 27.1523 must be furnished.

(e) *Kinds of operation.* Each kind of operation for which the rotorcraft and its equipment installations are approved must be listed.

(f) (Reserved)

(g) *Altitude.* The altitude established under CS 27.1527 and an explanation of the limiting factors must be furnished.

CS 27.1585 Operating procedures

(a) Parts of the manual containing operating procedures must have information concerning any normal and emergency procedures and other information necessary for safe operation, including take-off and landing procedures and associated airspeeds. The manual must contain any pertinent information including:

(1) The kind of take-off surface used in the tests and each appropriate climb out speed; and

CS-27 BOOK 1

(2) The kind of landing surface used in the tests and appropriate approach and glide airspeeds.

(b) For multi-engine rotorcraft, information identifying each operating condition in which the fuel system independence prescribed in CS 27.953 is necessary for safety must be furnished, together with instructions for placing the fuel system in a configuration used to show compliance with that paragraph.

(c) For helicopters for which a V_{NE} (power-off) is established under CS 27.1505 (c), information must be furnished to explain the V_{NE} (power-off) and the procedures for reducing airspeed to not more than the V_{NE} (power-off) following failure of all engines.

(d) For each rotorcraft showing compliance with CS 27.1353(g)(2) or (g)(3), the operating procedures for disconnecting the battery from its charging source must be furnished.

(e) If the unusable fuel supply in any tank exceeds 5% of the tank capacity, or 3.8 litres (0.8 Imperial gallon/1 US gallon), whichever is greater, information must be furnished which indicates that when the fuel quantity indicator reads 'zero' in level flight, any fuel remaining in the fuel tank cannot be used safely in flight.

(f) Information on the total quantity of usable fuel for each fuel tank must be furnished.

(g) The airspeeds and rotor speeds for minimum rate of descent and best glide angle as prescribed in CS 27.71 must be provided.

CS 27.1587 Performance information

(a) The rotorcraft flight manual (RFM) must contain the following information, determined in accordance with CS 27.49 through CS 27.79 and CS 27.143 (c) and (d):

(1) Enough information to determine the limiting height-speed envelope.

(2) Information relative to:

(i) The steady rates of climb and descent, in-ground effect and out-of-ground effect hovering ceilings, together with the corresponding airspeeds and other pertinent information including the calculated effects of altitude and temperatures;

(ii) The maximum weight for each altitude and temperature condition at which the rotorcraft can safely hover in-ground effect and out-of-ground effect in winds of not less than 31 km/h (17 knots) from all

azimuths. This data must be clearly referenced to the appropriate hover charts. In addition, if there are other combinations of weight, altitude and temperature for which performance information is provided and at which the rotorcraft cannot land and take-off safely with the maximum wind value, those portions of the operating envelope and the appropriate safe wind conditions must be stated in the Rotorcraft Flight Manual;

(iii) For reciprocating engine-powered rotorcraft, the maximum atmospheric temperature at which compliance with the cooling provisions of CS 27.1041 to 27.1045 is shown; and

(iv) Glide distance as a function of altitude when autorotating at the speeds and conditions for minimum rate of descent and best glide as determined in CS 27.71.

(b) The RFM must contain:

(1) In its performance information section any pertinent information concerning the take-off weights and altitudes used in compliance with CS 27.51;

(2) The horizontal take-off distance determined in accordance with CS 27.65(a)(2)(i); and

(3) The substantiated sea conditions and any associated information relating to the certification obtained with ditching or emergency flotation provisions

[Amdt No: 27/1]

[Amdt No: 27/5]

27.1589 Loading information

There must be loading instructions for each possible loading condition between the maximum and minimum weights determined under CS 27.25 that can result in a centre of gravity beyond any extreme prescribed in CS 27.27, assuming any probable occupant weights.

**CS 27.1593 Exposure to volcanic cloud hazards
(See AMC 27.1593)**

If required by an operating rule, the susceptibility of rotorcraft features to the effects of volcanic cloud hazards must be established.

CS-27 BOOK 1

[Amdt No: 27/4]

INTENTIONALLY LEFT BLANK

CS-27 BOOK 1**APPENDICES****Appendix A – Instructions for Continued Airworthiness****A27.1 General**

(a) This appendix specifies requirements for the preparation of instructions for continued airworthiness as required by CS 27.1529.

(b) The instructions for continued airworthiness for each rotorcraft must include the instructions for continued airworthiness for each engine and rotor (hereinafter designated 'products'), for each appliance required by any applicable CS or operating rule, and any required information relating to the interface of those appliances and products with the rotorcraft. If instructions for continued airworthiness are not supplied by the manufacturer of an appliance or product installed in the rotorcraft the instructions for continued airworthiness for the rotorcraft must include the information essential to the continued airworthiness of the rotorcraft.

A27.2 Format

(a) The instructions for continued airworthiness must be in the form of a manual or manuals as appropriate for the quantity of data to be provided.

(b) The format of the manual or manuals must provide for a practical arrangement.

A27.3 Content

The contents of the manual or manuals must be prepared in a language acceptable to the Agency. The instructions for continued airworthiness must contain the following manuals or sections, as appropriate, and information:

(a) *Rotorcraft maintenance manual or section*

(1) Introduction information that includes an explanation of the rotorcraft's features and data to the extent necessary for maintenance or preventive maintenance.

(2) A description of the rotorcraft and its systems and installations including its engines, rotors, and appliances.

(3) Basic control and operation information describing how the rotorcraft components and systems are controlled and

how they operate, including any special procedures and limitations that apply.

(4) Servicing information that covers details regarding servicing points, capacities of tanks, reservoirs, types of fluids to be used, pressures applicable to the various systems, location of access panels for inspection and servicing, locations of lubrication points, the lubricants to be used, equipment required for servicing, tow instructions and limitations, mooring, jacking, and levelling information.

(b) *Maintenance instructions*

(1) Scheduling information for each part of the rotorcraft and its engines, auxiliary power units, rotors, accessories, instruments and equipment that provides the recommended periods at which they should be cleaned, inspected, adjusted, tested, and lubricated, and the degree of inspection, the applicable wear tolerances, and work recommended at these periods. However, it is allowed to refer to an accessory, instrument, or equipment manufacturer as the source of this information if it is shown that the item has an exceptionally high degree of complexity requiring specialised maintenance techniques, test equipment, or expertise. The recommended overhaul periods and necessary cross references to the Airworthiness Limitations section of the manual must also be included. In addition an inspection program that includes the frequency and extent of the inspections necessary to provide for the continued airworthiness of the rotorcraft must be included.

(2) Troubleshooting information describing probable malfunctions, how to recognise those malfunctions, and the remedial action for those malfunctions.

(3) Information describing the order and method of removing and replacing products and parts with any necessary precautions to be taken.

(4) Other general procedural instructions including procedures for system testing during ground running, symmetry checks, weighing and determining the centre of gravity, lifting and shoring, and storage limitations.

(c) Diagrams of structural access plates and information needed to gain access for inspections when access plates are not provided.

CS-27 BOOK 1

(d) Details for the application of special inspection techniques including radiographic and ultrasonic testing where such processes are specified.

(e) Information needed to apply protective treatments to the structure after inspection.

(f) All data relative to structural fasteners such as identification, discard recommendations, and torque values.

(g) A list of special tools needed.

[Amdt 27/2]

A27.4 Airworthiness Limitations Section

The instructions for continued airworthiness must contain a section titled airworthiness limitations, that is segregated and clearly distinguishable from the rest of the document. This section must set forth each mandatory replacement time, structural inspection interval, and related structural inspection procedure required for type-certification. If the instructions for continued airworthiness consist of multiple documents, the section required by this paragraph must be included in the principal manual. This section must contain a legible statement in a prominent location that reads: ‘the airworthiness limitations section is approved and variations must also be approved.’

INTENTIONALLY LEFT BLANK

[Amdt 27/3]

Appendix A.27.5 Information system security Instructions for Continued Airworthiness

The applicant must prepare Instructions for Continued Airworthiness (ICA) that are applicable to aircraft information system security protection as required by CS 27.1319 (see AMC 20-42 Section 9).

[Amdt 27/7]

CS-27 BOOK 1

Appendix B

Airworthiness Criteria for Helicopter Instrument Flight

I. *General.* A small helicopter may not be type certificated for operation under the instrument flight rules (IFR) unless it meets the design and installation requirements contained in this appendix.

II. *Definitions*

(a) V_{YI} means instrument climb speed, utilised instead of V_Y for compliance with the climb requirements for instrument flight.

(b) V_{NEI} means instrument flight never exceed speed, utilised instead of V_{NE} for compliance with maximum limit speed requirements for instrument flight.

(c) V_{MINI} means instrument flight minimum speed, utilised in complying with minimum limit speed requirements for instrument flight.

III. *Trim.* It must be possible to trim the cyclic, collective, and directional control forces to zero at all approved IFR airspeeds, power settings, and configurations appropriate to the type.

IV. *Static longitudinal stability*

(a) *General.* The helicopter must possess positive static longitudinal control force stability at critical combinations of weight and centre of gravity at the conditions specified in paragraphs IV(b) or (c) of this Appendix. The stick force must vary with speed so that any substantial speed change results in a stick force clearly perceptible to the pilot. For single pilot approval the airspeed must return to within 10% of the trim speed when the control force is slowly released for each trim condition specified in paragraph IV(b) of this Appendix.

(b) *For single-pilot approval*

(1) *Climb.* Stability must be shown in climb throughout the speed range 37 km/h (20 knots) either side of trim with:

- (i) The helicopter trimmed at V_{YI} ;
- (ii) Landing gear retracted (if retractable); and
- (iii) Power required for limit climb rate (at least 5 m/s (1000 fpm)) at V_{YI} or maximum continuous power, whichever is less.

(2) *Cruise.* Stability must be shown throughout the speed range from 0.7 to 1.1 V_H or V_{NEI} , whichever is lower, not to exceed ± 37 km/h (± 20 knots) from trim with:

(i) The helicopter trimmed and power adjusted for level flight at 0.9 V_H or 0.9 V_{NEI} , whichever is lower; and

(ii) Landing gear retracted (if retractable).

(3) *Slow cruise.* Stability must be shown throughout the speed range from 0.9 V_{MINI} to 1.3 V_{MINI} or 37 km/h (20 knots) above trim speed, whichever is greater, with:

(i) The helicopter trimmed and power adjusted for level flight at 1.1 V_{MINI} ; and

(ii) Landing gear retracted (if retractable).

(4) *Descent.* Stability must be shown throughout the speed range 37 km/h (20 knots) either side of trim with:

(i) The helicopter trimmed at 0.8 V_H or 0.8 V_{NEI} (or 0.8 V_{LE} for the landing gear extended case), whichever is lower;

(ii) Power required for 1000 fpm descent at trim speed; and

(iii) Landing gear extended and retracted, if applicable.

(5) *Approach.* Stability must be shown throughout the speed range from 0.7 times the minimum recommended approach speed to 37 km/h (20 knots) above the maximum recommended approach speed with:

(i) The helicopter trimmed at the recommended approach speed or speeds;

(ii) Landing gear extended and retracted, if applicable; and

(iii) Power required to maintain a 3° glide path and power required to maintain the steepest approach gradient for which approval is requested.

(c) Helicopters approved for a minimum crew of two pilots must comply with the provisions of paragraphs IV(b)(2) and IV(b)(5) of this Appendix.

CS-27 BOOK 1

Appendix B (Continued)

V. *Static lateral-directional stability*

(a) Static directional stability must be positive throughout the approved ranges of airspeed, power, and vertical speed. In straight and steady sideslips up to $\pm 10^\circ$ from trim, directional control position must increase without discontinuity with the angle of sideslip, except for a small range of sideslip angles around trim. At greater angles up to the maximum sideslip angle appropriate to the type, increased directional control position must produce increased angle of sideslip. It must be possible to maintain balanced flight without exceptional pilot skill or alertness.

(b) During sideslips up to $\pm 10^\circ$ from trim throughout the approved ranges of airspeed, power, and vertical speed there must be no negative dihedral stability perceptible to the pilot through lateral control motion or force. Longitudinal cyclic movement with sideslip must not be excessive.

[Amdt. No.: 27/1]

VI. *Dynamic stability*

(a) For single-pilot approval:

(1) Any oscillation having a period of less than 5 seconds must damp to $\frac{1}{2}$ amplitude in not more than one cycle.

(2) Any oscillation having a period of 5 seconds or more but less than 10 seconds must damp to $\frac{1}{2}$ amplitude in not more than two cycles.

(3) Any oscillation having a period of 10 seconds or more but less than 20 seconds must be damped.

(4) Any oscillation having a period of 20 seconds or more may not achieve double amplitude in less than 20 seconds.

(5) Any a periodic response may not achieve double amplitude in less than 6 seconds.

(b) For helicopters approved with a minimum crew of two pilots:

(1) Any oscillation having a period of less than 5 seconds must damp to $\frac{1}{2}$ amplitude in not more than two cycles.

(2) Any oscillation having a period of 5 seconds or more but less than 10 seconds must be damped.

(3) Any oscillation having a period of 10 seconds or more may not achieve double amplitude in less than 10 seconds.

VII. *Stability augmentation system (SAS)*

(a) If a SAS is used, the reliability of the SAS must be related to the effects of its failure. Any SAS failure condition that would prevent continued safe flight and landing must be extremely improbable. It

must be shown that, for any failure condition of the SAS which is not shown to be extremely improbable:

(1) The helicopter is safely controllable when the failure or malfunction occurs at any speed or altitude within the approved IFR operating limitations; and

(2) The overall flight characteristics of the helicopter allow for prolonged instrument flight without undue pilot effort. Additional unrelated probable failures affecting the control system must be considered. In addition:

(i) The controllability and manoeuvrability requirements in Subpart B of CS-27 must be met throughout a practical flight envelope;

(ii) The flight control, trim, and dynamic stability characteristics must not be impaired below a level needed to allow continued safe flight and landing; and

(iii) The static longitudinal and static directional stability requirements of Subpart B of CS-27 must be met throughout a practical flight envelope.

(b) The SAS must be designed so that it cannot create a hazardous deviation in flight path or produce hazardous loads on the helicopter during normal operation or in the event of malfunction or failure, assuming corrective action begins within an appropriate period of time. Where multiple systems are installed, subsequent malfunction conditions must be considered in sequence unless their occurrence is shown to be improbable.

[Amdt. No.: 27/1]

VIII. *Equipment, systems, and installation.*

The basic equipment and installation must comply with CS 29.1303, 29.1431 and 29.1433, with the following exceptions and additions:

(a) Flight and navigation instruments

(1) A magnetic gyro-stabilised direction indicator instead of the gyroscopic direction indicator required by CS 29.1303 (h); and

(2) A standby attitude indicator which meets the requirements of CS 29.1303(g)(1) to (7), instead of a rate-of-turn indicator required by CS 29.1303(g). For two-pilot configurations, one pilot's primary indicator may be designated for this purpose. If standby batteries are provided they may be charged from the aircraft electrical system if adequate isolation is incorporated.

(b) Miscellaneous requirements

(1) Instrument systems and other systems essential for IFR flight that could be adversely affected by icing must be adequately

CS-27 BOOK 1

Appendix B (Continued)

protected when exposed to the continuous and intermittent maximum icing conditions defined in appendix C of CS-29, whether or not the rotorcraft is certificated for operation in icing conditions.

(2) There must be means in the generating system to automatically de-energise and disconnect from the main bus any power source developing hazardous overvoltage.

(3) Each required flight instrument using a power supply (electric, vacuum, etc.) must have a visual means integral with the instrument to indicate the adequacy of the power being supplied.

(4) When multiple systems performing like functions are required, each system must be grouped, routed, and spaced so that physical separation between systems is provided to ensure that a single malfunction will not adversely affect more than one system.

(5) For systems that operate the required flight instruments at each pilot's station:

(i) Only the required flight instruments for the first pilot may be connected to that operating system;

(ii) Additional instruments, systems, or equipment may not be connected to an operating system for a second pilot unless provisions are made to ensure the continued normal functioning of the required instruments in the event of any malfunction of the additional instruments, systems, or equipment which is not shown to be extremely improbable;

(iii) The equipment, systems, and installations must be designed so that one display of the information essential to the safety of flight which is provided by the instruments will remain available to a pilot, without additional crewmember action, after any single failure or combination of failures that is not shown to be extremely improbable; and

(iv) For single-pilot configurations, instruments which require a static source must be provided with a means of selecting an alternate source and that source must be calibrated.

IX. *Rotorcraft flight manual.* A rotorcraft flight manual or rotorcraft flight manual IFR supplement must be provided and must contain:

(a) *Limitations.* The approved IFR flight envelope, the IFR flight crew composition, the revised kinds of operation, and the steepest IFR precision approach gradient for which the helicopter is approved;

(b) *Procedures.* Required information for proper operation of IFR systems and the recommended procedures in the event of stability augmentation or electrical system failures; and

(c) *Performance.* If V_{YI} differs from V_Y , climb performance at V_{YI} and with maximum continuous power throughout the ranges of weight, altitude, and temperature for which approval is requested.

CS-27 BOOK 1

Appendix C

Criteria for Category A

| | |
|---|--|
| <p>C27.1 <i>General.</i> A small multi-engine rotorcraft may not be type certificated for category A operation unless it meets the design installation and performance provisions contained in this appendix in addition to the provisions of this CS-27.</p> <p>C27.2 <i>Applicable CS-29 paragraphs.</i> The following paragraphs of CS-29 must be met in addition to the requirements of this CS:</p> <p>29.45(a) – General. and (b)(2)</p> <p>29.49(a) – Performance at minimum operating speed.</p> <p>29.51 – Take-off data: General.</p> <p>29.53 – Take-off: Category A.</p> <p>29.55 – Take-off decision point: Category A.</p> <p>29.59 – Take-off path: Category A.</p> <p>29.60 – Elevated heliport take-off path: Category A.</p> <p>29.61 – Take-off distance: Category A.</p> <p>29.62 – Rejected take-off: Category A.</p> <p>29.64 – Climb: General.</p> <p>29.65(a) – Climb: AEO.</p> <p>29.67(a) – Climb: OEI.</p> <p>29.75 – Landing: General.</p> <p>29.77 – Landing decision point: Category A.</p> <p>29.79 – Landing: Category A.</p> <p>29.81 – Landing distance (ground level sites): Category A.</p> <p>29.85 – Balked landing: Category A.</p> <p>29.87(a) – Height-velocity envelope.</p> <p>29.547(a) – Main and tail rotor structure. and (b)</p> <p>(29.571 – Fatigue evaluation of structure.) AC Material only: AC 29-2C Change 4 dated 1 May 2014, Paragraph AC29.571A.b(2).</p> <p>29.861(a) – Fire protection of structure, controls and other parts.</p> <p>29.901(c) – Powerplant: Installation.</p> <p>29.903(b), (c) and (e) – Engines.</p> <p>29.908(a) – Cooling fans.</p> | <p>29.917(a), (b) – Rotor drive system: Design. (29.917(a) replaces 27.917(d))</p> <p>and (c)(1)</p> <p>29.927(c)(1)</p> <p>and (c)(2) – Additional tests.</p> <p>29.953(a) – Fuel system independence.</p> <p>29.1027(a) – Transmission and gearboxes: General.</p> <p>29.1045(a)(1), (b), (c), (d) and (f) – Climb cooling test procedures.</p> <p>29.1047(a) – Take-off cooling test procedures.</p> <p>29.1181(a) – Designated fire zones: Regions included.</p> <p>29.1187(e) – Drainage and ventilation of fire zones.</p> <p>29.1189(c) – Shutoff means.</p> <p>29.1191(a)(l) – Firewalls.</p> <p>29.1193(e) – Cowling and engine compartment covering.</p> <p>29.1195(a) – Fire extinguishing systems (one and (d) shot).</p> <p>29.1197 – Fire extinguishing agents.</p> <p>29.1199 – Extinguishing agent containers.</p> <p>29.1201 – Fire extinguishing system materials.</p> <p>29.1305(a)(6) – Powerplant instruments. and (b)</p> <p>29.1309(b)(2)(i) – Equipment, systems and and (d) installations.</p> <p>29.1323(c)(1) – Airspeed indicating system.</p> <p>29.1331(b) – Instruments using a power supply.</p> <p>29.1337(e) – Chip detection system.</p> <p>29.1351(d)(2) – Additional requirements for Category A rotorcraft (Operation with the normal electrical power generating system inoperative.)</p> <p>29.1585(h) – Operating Procedures.</p> <p>29.1587(a) – Performance information.</p> <p>If certification with ditching provisions is requested by the applicant, the following requirements of CS-29 must also be met in addition to the ones of this CS:</p> <p>29.801(c) and (g)– Ditching.</p> |
|---|--|

CS-27 BOOK 1

- 29.803(c) – Emergency evacuation.
- 29.809(j)(2) – Emergency exit arrangement.
- 29.811(h)(1) – Emergency exit marking.
- 29.1415(d) – Ditching equipment.

If certification of an emergency flotation system alone is requested by the applicant, the following requirements of CS 29 must also be met in addition to the ones of this CS:

- 29.801(g) – Ditching.

(See AC 29-2C Change 7 dated 4 February 2016 and AMC material to CS-29)

- [Amdt No: 27/2]
- [Amdt No: 27/4]
- [Amdt No: 27/5]
- [Amdt No: 27/6]
- [Amdt No: 27/9]

CS-27 BOOK 1**Appendix D****HIRF Environments and Equipment HIRF Test Levels****Appendix D — HIRF Environments and Equipment HIRF Test Levels**

This Appendix specifies the HIRF environments and equipment HIRF test levels for electrical and electronic systems under CS 27.1317. The field strength values for the HIRF environments and equipment HIRF test levels are expressed in root-mean-square units measured during the peak of the modulation cycle.

(a) HIRF environment I is specified in the following table:

Table I — HIRF Environment I

| FREQUENCY | FIELD STRENGTH (V/m) | |
|---------------|----------------------|---------|
| | PEAK | AVERAGE |
| 10 kHz–2 MHz | 50 | 50 |
| 2–30 MHz | 100 | 100 |
| 30–100 MHz | 50 | 50 |
| 100–400 MHz | 100 | 100 |
| 400–700 MHz | 700 | 50 |
| 700 MHz–1 GHz | 700 | 100 |
| 1–2 GHz | 2000 | 200 |
| 2–6 GHz | 3000 | 200 |
| 6–8 GHz | 1000 | 200 |
| 8–12 GHz | 3000 | 300 |
| 12–18 GHz | 2000 | 200 |
| 18–40 GHz | 600 | 200 |

In this table, the higher field strength applies to the frequency band edges.

(b) HIRF environment II is specified in the following table:

Table II — HIRF Environment II

| FREQUENCY | FIELD STRENGTH (V/m) | |
|---------------|----------------------|---------|
| | PEAK | AVERAGE |
| 10–500 kHz | 20 | 20 |
| 500 kHz–2 MHz | 30 | 30 |

CS-27 BOOK 1

| | | |
|---------------|------|-----|
| 2–30 MHz | 100 | 100 |
| 30–100 MHz | 10 | 10 |
| 100–200 MHz | 30 | 10 |
| 200–400 MHz | 10 | 10 |
| 400 MHz–1 GHz | 700 | 40 |
| 1–2 GHz | 1300 | 160 |
| 2–4 GHz | 3000 | 120 |
| 4–6 GHz | 3000 | 160 |
| 6–8 GHz | 400 | 170 |
| 8–12 GHz | 1230 | 230 |
| 12–18 GHz | 730 | 190 |
| 18–40 GHz | 600 | 150 |

In this table, the higher field strength applies to the frequency band edges.

(c) HIRF environment III is specified in the following table:

Table III — HIRF Environment III

| FREQUENCY | FIELD STRENGTH (V/m) | |
|-----------------|----------------------|---------|
| | PEAK | AVERAGE |
| 10–100 kHz | 150 | 150 |
| 100 kHz–400 MHz | 200 | 200 |
| 400–700 MHz | 730 | 200 |
| 700 MHz–1 GHz | 1400 | 240 |
| 1–2 GHz | 5000 | 250 |
| 2–4 GHz | 6000 | 490 |
| 4–6 GHz | 7200 | 400 |
| 6–8 GHz | 1100 | 170 |
| 8–12 GHz | 5000 | 330 |
| 12–18 GHz | 2000 | 330 |
| 18–40 GHz | 1000 | 420 |

In this table, the higher field strength applies at the frequency band edges.

(d) Equipment HIRF Test Level 1

CS-27 BOOK 1

- (1) From 10 kilohertz (kHz) to 400 megahertz (MHz), use conducted susceptibility tests with continuous wave (CW) and 1 kHz square wave modulation with 90 % depth or greater. The conducted susceptibility current must start at a minimum of 0.6 milliamperes (mA) at 10 kHz, increasing 20 decibels (dB) per frequency decade to a minimum of 30 mA at 500 kHz.
 - (2) From 500 kHz to 40 MHz, the conducted susceptibility current must be at least 30 mA.
 - (3) From 40 MHz to 400 MHz, use conducted susceptibility tests, starting at a minimum of 30 mA at 40 MHz, decreasing 20 dB per frequency decade to a minimum of 3 mA at 400 MHz.
 - (4) From 100 MHz to 400 MHz, use radiated susceptibility tests at a minimum of 20 volts per meter (V/m) peak with CW and 1 kHz square wave modulation with 90 % depth or greater.
 - (5) From 400 MHz to 8 gigahertz (GHz), use radiated susceptibility tests at a minimum of 150 V/m peak with pulse modulation of 4 % duty cycle with 1 kHz pulse repetition frequency. This signal must be switched on and off at a rate of 1 Hz with a duty cycle of 50 %.
- (e) Equipment HIRF Test Level 2. Equipment HIRF Test Level 2 is HIRF environment II in Table II of this Appendix reduced by acceptable aircraft transfer function and attenuation curves. Testing must cover the frequency band of 10 kHz to 8 GHz.
- (f) Equipment HIRF Test Level 3
- (1) From 10 kHz to 400 MHz, use conducted susceptibility tests, starting at a minimum of 0.15 mA at 10 kHz, increasing 20 dB per frequency decade to a minimum of 7.5 mA at 500 kHz.
 - (2) From 500 kHz to 40 MHz, use conducted susceptibility tests at a minimum of 7.5 mA.
 - (3) From 40 MHz to 400 MHz, use conducted susceptibility tests, starting at a minimum of 7.5 mA at 40 MHz, decreasing 20 dB per frequency decade to a minimum of 0.75 mA at 400 MHz.
 - (4) From 100 MHz to 8 GHz, use radiated susceptibility tests at a minimum of 5 V/m.

CS-27 BOOK 2

CS-27

Book 2

**Acceptable Means of Compliance
and Guidance Material
for
Small Rotorcraft**

CS–27 BOOK 2**AMC 27 General**

1. The AMC to CS–27 consists of FAA AC 27-1B Change 7, dated 4 February 2016, with the changes/additions given in this Book 2 of CS–27.

2. The primary reference for each of these AMCs is the CS–27 paragraph. Where there is an appropriate paragraph in FAA AC 27-1B Change 7, dated 4 February 2016, this is added as a secondary reference.

[Amdt No: 27/2]

[Amdt No: 27/4]

[Amdt No: 27/6]

AMC 27.45 Performance General

This AMC provides further guidance and acceptable means of compliance to supplement FAA AC 27-1B Change 7 AC 27.45. § 27.45 PERFORMANCE – GENERAL which is the EASA acceptable means of compliance, as provided for in AMC 27 General. However, some aspects of the FAA AC are deemed by EASA to be at variance with EASA’s interpretation or its regulatory system. EASA’s interpretation of these aspects is described below. Paragraphs of FAA AC 27.45. § 27.45 that are not amended below are considered to be EASA acceptable means of compliance.

[...]

b. Procedures

[...]

(7) Engine Failure Testing Considerations

- (i) For all tests used to investigate the behaviour of the rotorcraft following an engine failure, the failure of the engine is usually simulated in some way. When engines are controlled with a hydro-mechanical governing system, it is common practice to close the throttle quickly to idle. For rotorcraft equipped with engine electronic control systems, and particularly those with a 2-minute/30-second OEI rating structure, it is common practice to simulate an OEI condition by using reduced power on all engines by means of a flight test tool.
- (ii) In every case, it must be demonstrated that all aspects of rotorcraft and powerplant behaviour are identical to those that would occur in the event of an actual engine failure with the remaining engine developing minimum-specification power. Of particular concern are ‘dead engine’ power decay characteristics, ‘live engine’ acceleration characteristics, and rotor RPM control.
- (iii) To this end, it is expected that a number of actual engine shut down tests will be conducted to generate sufficient data to validate the fidelity of the flight test tool and methodology, which will then allow its use in developing regulatory performance data. In general, it is best to conduct the tests in a low hover with the rotorcraft stabilised below the HV low point. An engine is then shut down and, following the appropriate pilot intervention time, the collective control is raised to cushion the landing.

[Amdt No: 27/6]

CS-27 BOOK 2

AMC No 1 to CS 27.351 Yawing conditions

(a) Definitions:

- (1) Suddenly. For the purpose of this AMC, 'suddenly' is defined as an interval not to exceed 0.2 seconds for a complete control input. A rational analysis may be used to substantiate an alternative value.
- (2) Initial Trim Condition. Steady, 1G level flight condition with zero bank angle or zero sideslip.
- (3) 'Line'. The rotorcraft's sideslip envelope, defined by the rule, between 90° at $0.6V_{NE}$ and 15° at V_{NE} or V_H whichever is less (see Figure 1).
- (4) Resulting Sideslip Angle. The rotorcraft's stabilised sideslip angle that results from a sustained maximum cockpit directional control deflection or as limited by pilot effort in the initial level flight power conditions.

(b) Explanation: The rule requires a rotorcraft's 'structural' yaw or sideslip design envelope that must cover a minimum forward speed or hover to V_{NE} or V_H whichever is less. The scope of the rule is intended to cover structural components that are primarily designed for the critical combinations of tail rotor thrust, inertial and aerodynamic forces. This may include but is not limited to fuselage, tailboom and attachments, vertical control surfaces, tail rotor and tail rotor support structure.

- (1) The rotorcraft's structure must be designed to withstand the loads in the specified yawing conditions. The standard does not require a structural flight demonstration. It is a structural design standard.
- (2) The standard applies only to power-on conditions. Autorotation need not be considered.
- (3) This standard requires the maximum allowable rotor revolutions per minute (RPM) consistent with each flight condition for which certification is requested.
- (4) For the purpose of this AMC, the analysis may be performed in international standard atmosphere (ISA) sea level conditions.
- (5) Maximum displacement of the directional control, except as limited by pilot effort (27.397(a)), is required for the conditions cited in the rule. A control-system-limiting device may be used, however the probability of failure or malfunction of these system(s) should be considered (See AMC No 2 to CS 27.351 Interaction of System and Structure).
- (6) Both right and left yaw conditions should be evaluated.
- (7) The air loads on the vertical stabilisers may be assumed independent of the tail rotor thrust.
- (8) Loads associated with sideslip angles exceeding the values of the 'line', defined in Figure 1, do not need to be considered. The corresponding points of the manoeuvre may be deleted.

(c) Procedure: The design loads should be evaluated within the limits of Figure 1 or the maximum yaw capability of the rotorcraft whichever is less at speeds from zero to V_H or V_{NE} whichever is less for the following phases of the manoeuvre (see Note 1):

- (1) With the rotorcraft at an initial trim condition, the cockpit directional control is suddenly displaced to the maximum deflection limited by the control stops or by the maximum pilot force specified in 27.397(a). This is intended to generate a high tail rotor thrust.
- (2) While maintaining maximum cockpit directional control deflection, within the limitation specified in (c)(1) of this AMC allow the rotorcraft to yaw to the maximum transient

CS-27 BOOK 2

sideslip angle. This is intended to generate high aerodynamic loads that are determined based on the maximum transient sideslip angle or the value defined by the 'line' in Figure 1 whichever is less (see Note 1).

- (3) Allow the rotorcraft to attain the resulting sideslip angle. In the event that the resulting sideslip angle is greater than the value defined by the 'line' in Figure 1, the rotorcraft should be trimmed to that value of the angle using less than maximum cockpit directional-control deflection by taking into consideration the manoeuvre's entry airspeed (see Note 2).
- (4) With the rotorcraft yawed to the resulting sideslip angle specified in (c)(3) of this AMC, the cockpit control is suddenly returned to its initial trim position. This is intended to combine a high tail rotor thrust and high aerodynamic restoring forces.

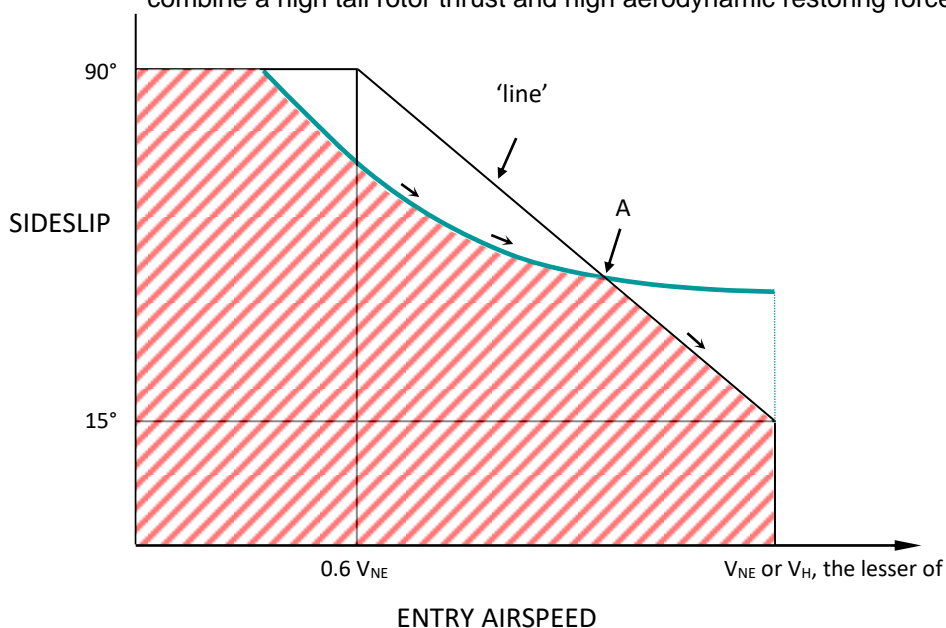

Figure 1 — YAW/FORWARD SPEED DIAGRAM

NOTE:

- (1) When comparing the rotorcraft's sideslip angle against the 'line' of Figure 1, the entry airspeed of the manoeuvre should be used.
- (2) When evaluating the yawing condition against the 'line' of Figure 1, sufficient points should be investigated in order to determine the critical design conditions. This investigation should include the loads that result from the manoeuvre, specifically initiated at the intermediate airspeed which is coincident with the intersection of the 'line' and the resultant sideslip angle (point A in Figure 1).
- (d) Another method of compliance may be used with a rational analysis (dynamic simulation), acceptable to the Agency/Authority, performed up to V_H or V_{NE} whichever is less, to the maximum yaw capability of the rotorcraft with recovery initiated at the resulting sideslip angle at its associated airspeed. Loads should be considered for all portions of the manoeuvre.

[Amdt No: 27/4]

CS-27 BOOK 2**AMC No 2 to CS 27.351 Yaw manoeuvre conditions****1. Introduction**

This AMC provides further guidance and acceptable means of compliance to supplement FAA AC 27-1B § AC 27.351. § 27.351 to meet the Agency's interpretation of CS 27.351. As such it should be used in conjunction with the FAA AC but take precedence over it, where stipulated, in the showing of compliance.

Specifically, this AMC addresses two areas where the FAA AC has been deemed by the Agency as being unclear or at variance to the Agency's interpretation. These areas are as follows:

a. Aerodynamic Loads

The certification specification CS 27.351 provides a minimum safety standard for the design of rotorcraft structural components that are subjected in flight to critical loads combinations of anti-torque system thrust (e.g. tail rotor), inertia and aerodynamics. A typical example of these structural components is the tailboom.

However, compliance with this standard according to the FAA AC may not necessarily be adequate for the design of rotorcraft structural components that are principally subjected in flight to significant aerodynamic loads (e.g. vertical empennage, fins, cowlings and doors).

For these components and their supporting structure, suitable design criteria should be developed by the Applicant and agreed with the Agency.

In lieu of acceptable design criteria developed by the applicant, a suitable combination of sideslip angle and airspeed for the design of rotorcraft components subjected to aerodynamic loads may be obtained from a simulation of the yaw manoeuvre of CS 27.351, starting from the initial directional control input specified in CS 27.351(b)(1) and (c)(1), until the rotorcraft reaches the maximum transient sideslip angle (overswing) resulting from its motion around the yaw axis.

b. Interaction of System and Structure

Maximum displacement of the directional control, except as limited by pilot effort (CS 27.397(a)), is required for the conditions cited in the certification specification. In the load evaluation credit may be taken for consideration of the effects of control system limiting devices.

However, the probability of failure or malfunction of these system(s) should also be considered and if it is shown not to be extremely improbable then further load conditions with the system in the failed state should be evaluated. This evaluation may include Flight Manual Limitations, if failure of the system is reliably indicated to the crew.

A yaw limiting device is a typical example of a system whose failed condition should be investigated in the assessment of the loads requested by CS 27.351.

An acceptable methodology to investigate the effects of all system failures not shown to be extremely improbable on the loading conditions of CS 27.351 is as follows:

- i) With the system in the failed state and considering any appropriate reconfiguration and flight limitations, it should be shown that the rotorcraft structure can withstand without failure the loading conditions of CS 27.351, when the manoeuvre is performed in accordance with the provisions of this AMC.
- ii) The factor of safety to apply to the above specified loading conditions to comply with CS 27.305 is defined in the figure below.

CS-27 BOOK 2

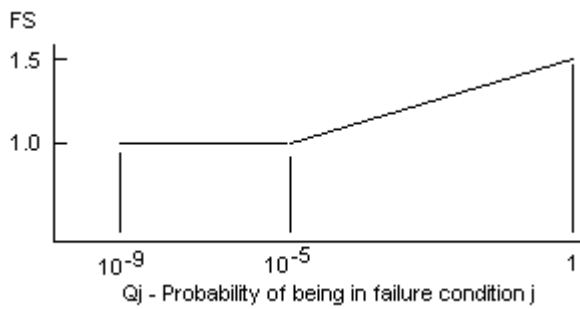

$$Q_j = (T_j)(P_j)$$

where:

T_j = Average flight time spent with a failed limiting system j (in hours)

P_j = Probability of occurrence of failure of control limiting system j (per hour)

Note: If P_j is greater than 1×10^{-3} per flight hour then a 1.5 factor of safety should be applied to all limit load conditions evaluated for the system failure under consideration.

[Amdt No: 27/2]

[Amdt No: 27/4]

AMC 27.563 Structural ditching and emergency flotation provisions

This AMC replaces FAA AC 27.563 and AC 27.563A.

(a) Explanation.

This AMC contains specific structural conditions to be considered to support the ditching requirements of CS 27.801, and the emergency flotation requirements of CS 27.802.

For rotorcraft for which certification with ditching provisions is requested by the applicant, in accordance with CS 27.801 (a), the structural conditions apply to the complete rotorcraft.

For rotorcraft for which certification with emergency flotation provisions is requested by the applicant, in accordance with CS 27.802 (b), the structural conditions apply only to the flotation units and their attachments to the rotorcraft.

At Amendment 5, the requirement for flotation stability on waves was appreciably changed. A requirement for the substantiation of acceptable stability by means of scale model testing in irregular waves was introduced at this amendment. This change made the usage of Sea State (World Meteorological Organization) no longer appropriate. The sea conditions are now defined in terms of significant wave height (H_s) and mean wave period (T_z). These terms are therefore also used in this AMC when defining sea conditions.

(1) The landing conditions specified in CS 27.563(a) may be considered as follows:

- (i) The rotorcraft contacts the most severe sea conditions for which certification with ditching or emergency flotation provisions is requested by the applicant, selected in accordance with Table 1 of AMC to CS 27.801(e) and 27.802(c) and as illustrated in Figure 1a). These conditions may be simulated considering the rotorcraft contacting a plane of stationary water as illustrated in Figure 1b), inclined with a range of steepness from zero to the significant steepness given by $S_s = 2\pi H_s / (g T_z^2)$. Values of S_s are given in Table 1 of AMC to 27.801(e) and 27.802(c). The rotorcraft contacts the inclined plane of stationary water with a flight direction contained in a vertical plane. This vertical plane is perpendicular to the inclined plane, as illustrated in Figure 1 b). Likely rotorcraft pitch, roll and yaw attitudes at water entry that would reasonably be expected to occur in service,

CS-27 BOOK 2

should also be considered. Autorotation, run-on landing, or one-engine-inoperative flight tests, or a validated simulation should be used to confirm the attitudes selected.

- (ii) The forward ground speed should not be less than 15.4 m/s (30 kt), and the vertical speed not less than 1.5 m/s (5 ft/s).
 - (iii) A rotor lift of not more than two-thirds of the design maximum weight may be assumed to act through the rotorcraft's centre of gravity during water entry.
 - (iv) The above conditions may be simulated or tested using a calm horizontal water surface with an equivalent impact angle and speed relative to the water surface as illustrated in Figure 1 c).
- (2) For floats that are fixed or intended to be deployed before water contact, CS 27.563(b)(1) defines the applicable load condition for entry into water, with the floats in their intended configuration.

CS 27.563(b)(1) also requires consideration of the following cases:

- The floats and their attachments to the rotorcraft should be designed for the loads resulting from a fully immersed float unless it is shown that full immersion is unlikely. If full immersion is shown to be unlikely, the determination of the highest likely buoyancy load should include consideration of a partially immersed float creating restoring moments to compensate for the upsetting moments caused by the side wind, unsymmetrical rotorcraft loading, water wave action, rotorcraft inertia, and probable structural damage and leakage considered under CS 27.801(e) or 27.802(c). The maximum roll and pitch angles established during compliance with CS 27.801(e) or 27.802(c) may be used, to determine the extent of immersion of each float. When determining this, damage to the rotorcraft that could be reasonably expected should be accounted for.
 - To mitigate the case when the crew is unable to, or omits to, deploy a normally stowed emergency flotation system before entering the water, if approval with ditching provisions is sought, it should be substantiated that the floats will survive and function properly. The floats in their un-deployed condition, their attachments to the rotorcraft and the local structure should be designed to withstand the water entry loads without damage that would prevent the floats inflating as intended. Risks such as the splintering of surrounding components in a way that might damage the un-deployed or deploying floats should be considered. There is, however, no requirement to assess the expected loading on other parts of the rotorcraft when entering the water, with unintended un-deployed floats.
 - The floats and their attachments to the rotorcraft should be substantiated as capable of withstanding the loads generated in flight. The airspeed chosen for assessment of the loads should be the appropriate operating limitation multiplied by 1.11. For fixed floats, the operating limitation should be the rotorcraft V_{NE} . For deployable floats, if an operating limitation for the deployment of floats and/or flight with floats deployed is given, the highest such limitation should be used, otherwise the rotorcraft V_{NE} should be used.
- (3) For floats intended to be deployed after water contact, CS 27.563(b)(2) requires the floats and their attachments to the rotorcraft to be designed to withstand the loads generated when entering the water with the floats in their intended condition.

Simultaneous vertical and drag loading on the floats and their attachments should be considered to account for the rotorcraft moving forward through the water during float deployment.

The vertical loads should be those resulting from fully immersed floats unless it is shown that full immersion is unlikely. If full immersion is shown to be unlikely, the determination of the highest likely buoyancy load should include consideration of a partially immersed float creating restoring moments to compensate for the upsetting moments caused by side wind, unsymmetrical rotorcraft loading, water wave action, rotorcraft inertia, and probable structural damage and leakage considered under CS 27.801(e) or 27.802(c). The maximum roll and pitch angles established during compliance with CS 27.801(e) or

CS-27 BOOK 2

27.802(c) may be used, if significant, to determine the extent of immersion of each float. When determining this, damage to the rotorcraft that could be reasonably expected should be accounted for.

The drag loads should be those resulting from movement of the rotorcraft through the water at 10.3 m/s (20 knots).

(b) Procedures

- (1) The floats and the float attachment structure should be substantiated for rational limit and ultimate loads.
- (2) The most severe sea conditions for which certification with ditching or emergency flotation provisions is requested by the applicant are to be considered. The sea conditions should be selected in accordance with the AMC to CS 27.801(e) and 27.802(c).
- (3) Landing load factors and the water load distribution may be determined by water drop tests or validated analysis.

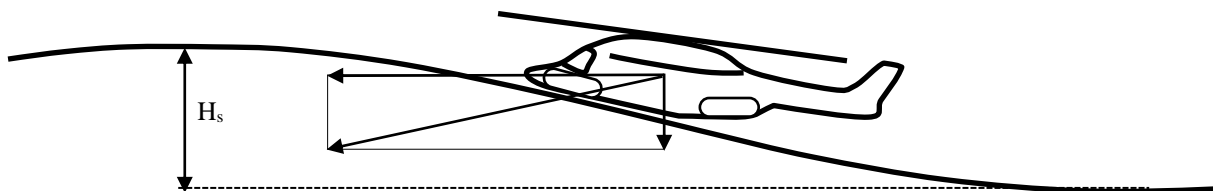

a) Water entry into wave

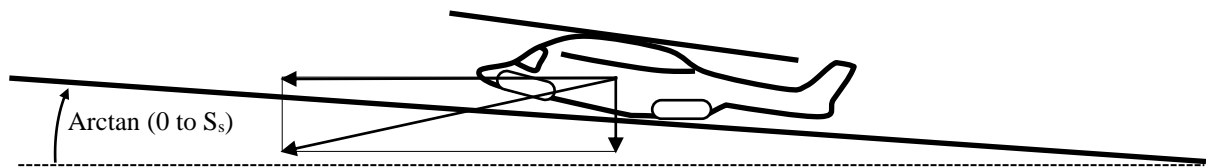

CS-27 BOOK 2

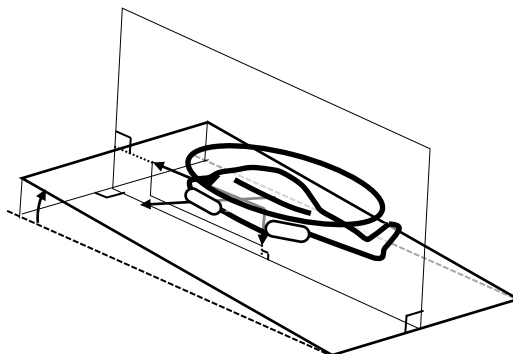

- b) Water entry into inclined plane of stationary water, steepness range - zero to significant steepness (S_s)

$$S_s = 2\pi H_s / (gT_z^2)$$

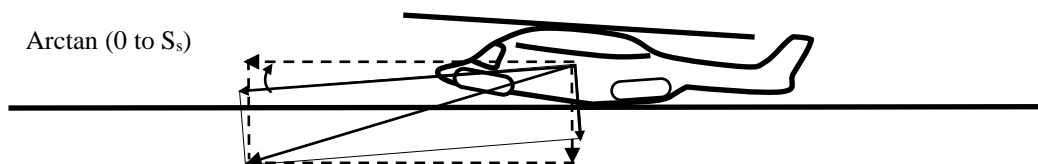

- c) Water entry into a stationary horizontal water surface using an equivalent water entry angle and velocity relative to the water surface (Dashed arrows show required horizontal and vertical speeds)

Figure 1 — Illustration of water entry test or simulation conditions which may be considered for structural provisions assessment

[Amdt No: 27/5]

AMC1 27.631 Bird strike

- (a) To demonstrate the remaining capability of the rotorcraft after a single bird strike, the applicant should evaluate the parts of the rotorcraft as follows:
- (1) the windshield directly in front of the occupants and its supporting frame should be capable of withstanding a bird strike without penetration; and
 - (2) any systems and equipment (including their controls) that are essential to ensure a safe landing and are installed near the windshield and its supporting frame should remain operative in case of shock loads resulting from a bird strike.
- Note: the capability to withstand multiple bird strikes is only evaluated for engines as specified under CS-E 800 'Bird Strike and Ingestion'.
- (b) For the demonstration under point (a), the altitude range within which the velocity V_H is evaluated should be defined and should not exceed 2 438 m (8 000 ft).

[Amdt No: 27/9]

AMC 27.783 Doors

This AMC provides further guidance and acceptable means of compliance to supplement FAA AC 27-1B AC 27.783 § 27.783 to meet EASA's interpretation of CS 27.783. As such it should be used

CS-27 BOOK 2

in conjunction with the FAA AC but take precedence over it, where stipulated, in the showing of compliance.

Specifically, this AMC addresses one area where the FAA AC has been deemed by EASA as being at variance to EASA's interpretation. This area is as follows:

(a) Explanation

[...]

- (4) Any means of egress (door, hatch, openable window) intended for use following ditching need not have a threshold above the waterline of the rotorcraft in calm water. However, the usability of the egress means should be substantiated in all sea conditions up to and including those chosen for showing compliance with CS 27.801(e) or 27.802(c) as appropriate. See also AMC 27.801 paragraph (b)(10) and AMC 27.802 paragraph (b)(7).

[Amdt No: 27/5]

CS-27 BOOK 2**AMC 27.801 Ditching**

This AMC replaces FAA AC 27.801.

(a) Definitions

- (1) Ditching: a controlled emergency landing on water, deliberately executed in accordance with rotorcraft flight manual (RFM) procedures, with the intent of abandoning the rotorcraft as soon as practicable.
- (2) Emergency flotation system (EFS): a system of floats and any associated parts (e.g. gas cylinders, means of deployment, pipework and electrical connections) that is designed and installed on a rotorcraft to provide buoyancy and flotation stability in a ditching.

(b) Explanation

- (1) Ditching certification is performed only if requested by the applicant.
- (2) For a rotorcraft to be certified for ditching, in addition to the other applicable requirements of CS-27, the rotorcraft must specifically satisfy CS 27.801 together with the requirements referenced in CS 27.801(a).
- (3) Ditching certification encompasses four primary areas of concern: rotorcraft water entry and flotation stability (including loads and flotation system design), occupant egress, and occupant survival. CS-27 Amendment 5 has developed enhanced standards in all of these areas.
- (4) The scope of the ditching requirements is expanded at Amendment 5 through a change in the ditching definition. All potential failure conditions that could result in a controlled 'land immediately' action by the pilot are now included. This primarily relates to changes in water entry conditions. While the limiting conditions for water entry have been retained (15.4 m/s (30 kt), 1.5 m/s (5 ft/s)), the alleviation that previously allowed less than 15.4 m/s (30 kt) forward speed to be used as the maximum applicable value has been removed (also from CS 27.563).
- (5) Flotation stability is enhanced through the introduction of a new standard based on a probabilistic approach to capsizes.
- (6) Failure of the EFS to operate when required will lead to the rotorcraft rapidly capsizing and sinking. Operational experience has shown that localised damage or failure of a single component of an EFS, or the failure of the flight crew to activate or deploy the EFS, can lead to the loss of the complete system. Therefore, the design of the EFS needs careful consideration; automatic deployment has been shown to be practicable and to offer a significant safety benefit.
- (7) The sea conditions, on which certification with ditching provisions is to be based, are selected by the applicant and should take into account the expected sea conditions in the intended areas of operation. The wave climate of the northern North Sea is adopted as the default wave climate as it represents a conservative condition. The applicant may select alternative/additional sea areas, with any associated certification then being limited to those geographical regions. The significant wave height, and any geographical limitations (if applicable – see the AMC to CS 27.801(e) and 27.802(c)) should be included in the RFM as performance information.
- (8) During scale model testing, appropriate allowances should be made for probable structural damage and leakage. Previous model tests and other data from rotorcraft of similar configurations that have already been substantiated, based on equivalent test conditions, may be used to satisfy the ditching requirements. In regard to flotation stability, the test conditions should be equivalent to those defined in the AMC to CS 27.801(e) and 27.802(c).
- (9) CS 27.801 requires that after ditching in sea conditions for which certification with ditching provisions is requested by the applicant, the probability of capsizing in a 5 minute exposure is acceptably low in order to allow the occupants to leave the rotorcraft and enter life rafts. This should be interpreted to mean that up to and including the worst-case sea conditions for which certification with ditching provisions is requested by the

CS-27 BOOK 2

applicant, the probability that the rotorcraft will capsize should be not higher than the target stated in CS 27.801(e). An acceptable means of demonstrating post-ditching flotation stability is through scale model testing using irregular waves. The AMC to CS 27.801(e) and 27.802(c) contains a test specification that has been developed for this purpose.

- (10) Providing a 'wet floor' concept (water in the cabin) by positioning the floats higher on the fuselage sides and allowing the rotorcraft to float lower in the water can be a way of increasing the stability of a ditched rotorcraft (although this would need to be verified for the individual rotorcraft type for all weight and loading conditions), or it may be desirable for other reasons. This is permissible provided that the mean static level of water in the cabin is limited to being lower than the upper surface of the seat cushion (for all rotorcraft mass and centre of gravity cases, with all flotation units intact), and that the presence of water will not unduly restrict the ability of occupants to evacuate the rotorcraft and enter the life raft.
 - (11) The sea conditions approved for ditching should be stated in the performance information section of the RFM.
 - (12) Current practices allow wide latitude in the design of cabin interiors and, consequently, of stowage provisions for safety and ditching equipment. Rotorcraft manufacturers may deliver aircraft with unfinished (green) interiors that are to be completed by a modifier.
 - (i) Segmented certification is permitted to accommodate this practice. That is, the rotorcraft manufacturer shows compliance with the flotation time, stability, and emergency exit requirements while a modifier shows compliance with the equipment requirements and egress requirements with the interior completed. This procedure requires close cooperation and coordination between the manufacturer, modifier, and EASA.
 - (ii) The rotorcraft manufacturer may elect to establish a token interior for ditching certification. This interior may subsequently be modified by a supplemental type certificate (STC). The ditching provisions should be shown to be compliant with the applicable requirements after any interior configuration or limitation change.
 - (iii) The RFM and any RFM supplements deserve special attention if a segmented certification procedure is pursued.
- (c) Procedures
- (1) Flotation system design
 - (i) Structural integrity should be established in accordance with CS 27.563.
 - (ii) Rotorcraft handling qualities should be verified to comply with the applicable certification specifications throughout the approved flight envelope with floats installed. Where floats are normally deflated, and deployed in flight, the handling qualities should be verified for the approved operating envelopes with the floats in:
 - (A) the deflated and stowed condition;
 - (B) the fully inflated condition; and
 - (C) the in-flight inflation condition; for float systems which may be inflated in flight, rotorcraft controllability should be verified by test or analysis taking into account all possible emergency flotation system inflation failures.
 - (iii) Reliability should be considered in the basic design to assure approximately equal inflation of the floats to preclude excessive yaw, roll, or pitch in flight or in the water:
 - (A) Maintenance procedures should not degrade the flotation system (e.g. by introducing contaminants that could affect normal operation, etc.).
 - (B) The flotation system design should preclude inadvertent damage due to normal personnel traffic flow and wear and tear. Protection covers should be evaluated for function and reliability.

CS-27 BOOK 2

- (C) The designs of the floats should provide means to minimise the likelihood of damage or tear propagation between compartments. Single compartment float designs should be avoided.
- (D) When showing compliance with CS 27.801(c)(1), and where practicable, the design of the flotation system should consider the likely effects of water impact (i.e. crash) loads. For example:
 - (a) locate system components away from the major effects of structural deformation;
 - (b) use flexible pipes/hoses; and
 - (c) avoid passing pipes/hoses or electrical wires through bulkheads that could act as a 'guillotine' when the structure is subject to water impact loads.
- (iv) The floats should be fabricated from highly conspicuous material of to assist in locating the rotorcraft following a ditching (and possible capsized).
- (2) Flotation system inflation.

Emergency flotation systems (EFSs) that are normally stowed in a deflated condition and are inflated either in flight or after contact with water should be evaluated as follows:

- (i) The emergency flotation system should include a means to verify its system integrity prior to each flight.
- (ii) Means should be provided to automatically trigger the inflation of the EFS upon water entry, irrespective of whether or not inflation prior to water entry is the intended operation mode. If a manual means of inflation is provided, the float activation switch should be located on one of the primary flight controls and should be safeguarded against inadvertent actuation.
- (iii) The inflation system should be safeguarded against spontaneous or inadvertent actuation in flight conditions for which float deployment has not been demonstrated to be safe.
- (iv) The maximum airspeeds for intentional in-flight actuation of the emergency flotation system and for flight with the floats inflated should be established as limitations in the RFM unless in-flight actuation is prohibited by the RFM.
- (v) Activation of the emergency flotation system upon water entry (irrespective of whether or not inflation prior to water entry is the intended operation mode) should result in an inflation time short enough to prevent the rotorcraft from becoming excessively submerged.
- (vi) A means should be provided for checking the pressure of the gas stowage cylinders prior to take-off. A table of acceptable gas cylinder pressure variation with ambient temperature and altitude (if applicable) should be provided.
- (vii) A means should be provided to minimise the possibility of over inflation of the flotation units under any reasonably probable actuation conditions.
- (viii) The ability of the floats to inflate without puncturing when subjected to actual water pressures should be substantiated. A demonstration of a full-scale float immersion in a calm body of water is one acceptable method of substantiation. Precautions should also be taken to avoid floats being punctured due to the proximity of sharp objects, during inflation in flight and with the helicopter in the water, and during subsequent movement of the helicopter in waves. Examples of objects that need to be considered are aerials, probes, overboard vents, unprotected split-pin tails, guttering and any projections sharper than a three-dimensional right-angled corner.
- (3) Injury prevention during and following water entry.

An assessment of the cabin and cockpit layouts should be undertaken to minimise the potential for injury to occupants in a ditching. This may be performed as part of the compliance with CS 27.785. Attention should be given to the avoidance of injuries due to

CS-27 BOOK 2

leg/arm flailing, as these can be a significant impediment to occupant egress and subsequent survivability. Practical steps that could be taken include:

- (i) locating potentially hazardous items away from the occupants;
- (ii) installing energy-absorbing padding onto interior components;
- (iii) using frangible materials; and
- (iv) designs that exclude hard or sharp edges.

(4) Water entry procedures.

Tests or simulations (or a combination of both) should be conducted to establish procedures and techniques to be used for water entry, based on the conditions given in (5). These tests/simulations should include determination of the optimum pitch attitude and forward velocity for ditching in a calm sea, as well as entry procedures for the most severe sea condition to be certified. Procedures for all failure conditions that may lead to a 'land immediately' action (e.g. one engine inoperative, all engines inoperative, tail rotor/drive failure) should be established. However, only the procedures for the most critical all-engines-inoperative condition need be verified by water entry test data.

(5) Water entry behaviour.

CS 27.801(d) requires the probable behaviour of the rotorcraft to be shown to exhibit no unsafe characteristics, e.g. that would lead to an inability to remain upright.

This should be demonstrated by means of scale model testing, based on the following conditions:

- (i) For entry into a calm sea:
 - (A) the optimum pitch, roll and yaw attitudes determined in (c)(4) above, with consideration for variations that would reasonably be expected to occur in service;
 - (B) ground speeds from 0 to 15.4 m/s (0 to 30 kt); and
 - (C) descent rate of 1.5 m/s (5 ft/s) or greater;
- (ii) For entry into the most severe sea condition:
 - (A) the optimum pitch attitude and entry procedure determined in (c)(4) above;
 - (B) ground speed of 15.4 m/s (30 kt);
 - (C) descent rate of 1.5 m/s (5 ft/s) or greater;
 - (D) likely roll and yaw attitudes; and
 - (E) sea conditions may be represented by regular waves having a height at least equal to the significant wave height (H_s), and a period no larger than the wave zero-crossing period (T_z) for the wave spectrum chosen for demonstration of rotorcraft flotation stability after water entry (see (c)(6) below and AMC to 27.801(e) and 27.802(c));
- (iii) Scoops, flaps, projections, and any other factors likely to affect the hydrodynamic characteristics of the rotorcraft must be considered.
- (iv) Probable damage to the structure due to water entry should be considered during the water entry evaluations (e.g. failure of windows, doors, skins, panels, etc.); and
- (v) Rotor lift does not have to be considered.

Alternatively, if scale model test data for a helicopter of a similar configuration has been previously successfully used to justify water entry behaviour, this data could form the basis for a comparative analytical approach.

(6) Flotation stability tests.

An acceptable means of flotation stability testing is contained in the AMC to CS 27.801(e) and 27.802(c). Note that model tests in a wave basin on a number of

CS-27 BOOK 2

different rotorcraft types have indicated that an improvement in seakeeping performance can consistently be achieved by fitting float scoops.

(7) Occupant egress and survival.

The ability of the occupants to deploy life rafts, egress the rotorcraft, and board the life rafts should be evaluated. For configurations which are considered to have critical occupant egress capabilities due to the life raft locations or the emergency exit locations and the proximity of the float (or a combination of both), an actual demonstration of egress may be required. When a demonstration is required, it may be conducted on a full-scale rotorcraft actually immersed in a calm body of water or using any other rig or ground test facility shown to be representative. The demonstration should show that the floats do not impede a satisfactory evacuation. Service experience has shown that it is possible for occupants to have escaped from the cabin but to have not been able to board a life raft and to have had difficulty in finding handholds to stay afloat and together. Handholds or lifelines should be provided on appropriate parts of the rotorcraft. The normal attitude of the rotorcraft and the possibility of capsizing should be considered when positioning the handholds or lifelines.

[Amdt No: 27/5]

AMC to CS 27.801(e) and 27.802(c) Model test method for flotation stability

This AMC should be used when showing compliance with CS 27.801(e) or CS 27.802(c) as introduced at Amendment 5.

(a) Explanation

(1) Model test objectives

The objective of the model tests described in the certification specification is to establish the performance of the rotorcraft in terms of its stability in waves. The wave conditions in which the rotorcraft is to be certified should be selected according to the desired level of operability (see (a)(2) below).

This will enable the overall performance of the rotorcraft to be established for inclusion in the rotorcraft flight manual (RFM) as required by CS 27.1587(b)(3). In the case of approval with ditching provisions, the wave conditions selected for substantiation of behaviour during the water entry phase must also be taken into account.

The rotorcraft design is to be tested, at each mass condition (see paragraph b(1)(ii) below), with its flotation system intact, and with its single most critical flotation compartment damaged (i.e. the single-puncture case which has the worst adverse effect on flotation stability).

(2) Model test wave conditions

The rotorcraft is to be tested in a single sea condition comprising a single combination of significant wave height (H_s) and zero-crossing period (T_z). The values of H_s and T_z should be no less than, and no more than, respectively, those chosen for certification, i.e. as selected from table 1. This approach is necessary in order to constrain the quantity of testing required within reasonable limits and is considered to be conservative. The justification is detailed in Appendix 2.

The applicant is at liberty to certify the rotorcraft to any significant wave height H_s . This significant wave height will be noted as performance information in the RFM.

Using reliable wave climate data for an appropriate region of the ocean for the anticipated flight operations, a T_z is selected to accompany the H_s . This T_z should be typical of those occurring at H_s as determined in the wave scatter table for the region. The mode or median of the T_z distribution at H_s should be used.

It is considered that the northern North Sea represents a conservatively 'hostile' region of the ocean worldwide and should be adopted as the default wave climate for certification.

CS–27 BOOK 2

However, this does not preclude an applicant from certifying a rotorcraft specifically for a different region. Such a certification for a specific region would require the geographical limits of that certification region to be noted as performance information in the RFM. Certification for the default northern North Sea wave climate does not require any geographical limits.

In the case of an approval with emergency flotation provisions, operational limitations may limit flight to ‘non-hostile’ sea areas. For simplicity, the northern North Sea may still be selected as the wave climate for certification, or alternatively a wave climate derived from a non-hostile region’s data may be used. If the latter approach is chosen, and it is desired to avoid geographical limits, a ‘non-hostile’ default wave climate will need to be agreed with EASA.

Wave climate data for the northern North Sea were obtained from the United Kingdom Meteorological Office (UK Met Office) for a typical ‘hostile’ helicopter route. The route selected was from Aberdeen to Block 211/27 in the UK sector of the North Sea. Data tables were derived from a UK Met Office analysis of 34 years of 3-hourly wave data generated within an 8-km, resolved wave model hindcast for European waters. This data represents the default wave climate.

Table 1 below has been derived from this data and contains combinations of H_s and T_z . Table 1 also includes the probability of exceedance (P_e) of the H_s .

Table 1 — Northern North Sea wave climate

| Spectrum shape: JONSWAP, peak enhancement factor $\gamma = 3.3$ | | | | |
|---|-------------------------------|------------------------|---|---------------------------------------|
| | Significant wave height H_s | Mean wave period T_z | Significant steepness $S_s = 2\pi H_s / (g T_z^2)$ | H_s probability of exceedance P_e |
| Intact flotation system | 6 m | 7.9 s | 1/16.2 | 1.2 % |
| | 5.5 m | 7.6 s | 1/16.4 | 2 % |
| | 5 m | 7.3 s | 1/16.6 | 3 % |
| | 4.5 m | 7.0 s | 1/17.0 | 5 % |
| | 4 m | 6.7 s | 1/17.5 | 8 % |
| | 3.5 m | 6.3 s | 1/17.7 | 13 % |
| | 3 m | 5.9 s | 1/18.1 | 20 % |
| | 2.5 m | 5.5 s | 1/18.9 | 29 % |
| | 2 m | 5.1 s | 1/20.3 | 43 % |
| | 1.25 m | 4.4 s | 1/24.2 | 72 % |

(3) Target probability of capsizing

Target probabilities of capsizing have been derived from a risk assessment. The target probabilities to be applied are as stated in CS 27.801(e) and 27.802(c), as applicable.

For ditching, the intact flotation system probability of capsizing of 3 % is derived from a historic ditching rate of 3.32×10^{-6} per flight hour and an AMC 27.1309 consequence of hazardous, which implies a frequency of capsizing of less than 10^{-7} per flight hour. The damaged flotation system probability of capsizing is increased by a factor of 10 to 30 % on the assumption that the probability of failure of the critical float compartment is 0.1; this probability has been estimated, as there is insufficient data on flotation system failure rates.

For emergency flotation equipment, an increase of half an order ($\sqrt{10}$) is allowed on the assumption of a reduced exposure to the risk, resulting in a probability of capsizing of

CS-27 BOOK 2

10 %. The probability of a capsizing with a damaged flotation system is consequently increased to 100 %, hence no test is required.

(4) Intact flotation system

For the case of an intact flotation system, if the northern North Sea default wave climate has been chosen for certification, the rotorcraft should be shown to resist capsize in a sea condition selected from Table 1. The probability of capsizing in a 5-minute exposure to the selected sea condition is to be demonstrated to be less than or equal to the appropriate value provided in CS 27.801(e) or 27.802(c), as appropriate, with a confidence of 95 % or greater.

(5) Damaged flotation system

For the case of a damaged flotation compartment (see (1) above), the same sea condition may be used, but a 10-fold increased probability of capsizing is permitted. This is because it is assumed that flotation system damage will occur in approximately one out of ten emergency landings on water. Thus, the probability of capsizing in a 5-minute exposure to the sea condition is to be demonstrated to be less than or equal to 10 times the required probability for the intact flotation system case, with a confidence of 95 % or greater. Where a 10-times probability is equal to or greater than 100 %, it is not necessary to perform a model test to determine the capsize probability with a damaged flotation system.

Alternatively, the applicant may select a wave condition with 10 times the probability of exceedance P_e of the significant wave height (H_s) selected for the intact flotation condition. In this case, the probability of capsizing in a 5-minute exposure to the sea condition is to be demonstrated to be less than or equal to the required value (see CS 27.801(e) or 27.802(c)), with a confidence of 95 % or greater.

(6) Long-crested waves

Whilst it is recognised that ocean waves are in general multidirectional (short-crested), the model tests are to be performed in unidirectional (long-crested) waves, this being regarded as a conservative approach to capsize probability.

(b) Procedures

(1) Rotorcraft model

(i) Construction and scale of the model

The rotorcraft model, including its emergency flotation, is to be constructed to be geometrically similar to the full-scale rotorcraft design at a scale that will permit the required wave conditions to be accurately represented in the model basin. It is recommended that the scale of the model should be not smaller than 1/15.

The construction of the model is to be sufficiently light to permit the model to be ballasted to achieve the desired weight and rotational inertias specified in the mass conditions (see (b)(1)(ii) below)¹.

Where it is likely that water may flood into the internal spaces following an emergency landing on water, for example through doors opened to permit escape, or any other opening, the model should represent these internal spaces and openings as realistically as possible.

It is permissible to omit the main rotor(s) from the model, but its (their) mass is to be represented in the mass and inertia conditions².

¹ It should be noted that rotorcraft tend to have a high centre of gravity due to the position of the engines and gearbox on top of the cabin. It therefore follows that most of the ballast is likely to be required to be installed in these high locations of the model.

² Rotors touching the waves can promote capsize, but they can also be a stabilising factor depending on the exact circumstances. Furthermore, rotor blades are often lost during the ditching due to contact with the sea. It is therefore considered acceptable to omit them from the model.

CS-27 BOOK 2

(ii) Mass conditions

As it is unlikely that the most critical condition can be determined reliably prior to testing, the model is to be tested in two mass conditions:

- (A) maximum mass condition, mid C of G; and
- (B) minimum mass condition, mid C of G.

(iii) Mass properties

The model is to be ballasted in order to achieve the required scale weight, centre of gravity, roll and yaw inertia for each of the mass conditions to be tested.

Once ballasted, the model's floating draft and trim in calm water is to be checked and compared with the design floating attitude.

The required mass properties and floating draft and trim, and those measured during model preparation, are to be fully documented and compared in the report.

(iv) Model restraint system

The primary method of testing is with a restrained model, but an alternative option is for a free-floating model (See (3)(iii) below).

For the primary restrained method, a flexible restraint or mooring system is to be provided to restrain the model in order for it to remain beam-on to the waves in the model basin³.

This restraint system should fulfil the following criteria:

- (A) be attached to the model on the centre line at the front and rear of the fuselage in such a position that roll motion coupling is minimised; an attachment at or near the waterline is preferred; and
- (B) be sufficiently flexible that the natural frequencies of the model surging/swaying on this restraint system are much lower than the lowest wave frequencies in the spectrum.

(v) Sea anchor

Whether or not the rotorcraft is to be fitted with a sea anchor, such an anchor is not to be represented in these model tests⁴.

(2) Test facility

The model test facility is to have the capability to generate realistic long non-repeating sequences of unidirectional (long-crested) irregular waves, as well as the characteristic wave condition at the chosen model scale. The facility is to be deep enough to ensure that the waves are not influenced by the depth (i.e. deep-water waves).

The dimensions of the test facility are to be sufficiently large to avoid any significant reflection/refraction effects influencing the behaviour of the rotorcraft model.

The facility is to be fitted with a high-quality wave-absorbing system or beach.

³ In general the model cannot be permitted to float freely in the basin because in the necessarily long-wave test durations, the model would otherwise drift down the basin and out of the calibrated wave region. Constraining the model to remain beam-on to the waves and not float freely is regarded as a conservative approach to the capsize test. A free-floating test is optional after a specific capsize event, in order to investigate whether the restraint system contributed to the event. It may also be possible to perform a complete free-floating test campaign by combining many short exposures in a wave basin capable of demonstrating a large calibrated wave region.

⁴ A sea anchor deployed from the rotorcraft nose is intended to improve stability by keeping the rotorcraft nose into the waves. However, such devices take a significant time to deploy and become effective, and so, their beneficial effect is to be ignored. The rotorcraft model will be restrained to remain beam-on to the waves.

CS-27 BOOK 2

The model basin is to provide full details of the performance of the wave maker and the wave absorption system prior to testing.

(3) Model test set-up

(i) General

The model is to be installed in the wave facility in a location sufficiently distant from the wave maker, tank walls and beach/absorber such that the wave conditions are repeatable and not influenced by the boundaries.

The model is to be attached to the model restraint system (see (b)(1)(iv) above).

(ii) Instrumentation and visual records

During wave calibration tests, three wave elevation probes are to be installed and their outputs continuously recorded. These probes are to be installed at the intended model location, a few metres to the side and a few metres ahead of this location.

The wave probe at the model location is to be removed during tests with the rotorcraft model present.

All tests are to be continuously recorded on digital video. It is required that at least two simultaneous views of the model are to be recorded. One is to be in line with the model axis (i.e. viewing along the wave crests), and the other is to be a three-quarter view of the model from the up-wave direction. Video records are to incorporate a time code to facilitate synchronisation with the wave elevation records in order to permit the investigation of the circumstances and details of a particular capsizing event.

(iii) Wave conditions and calibration

Prior to the installation of the rotorcraft model in the test facility, the required wave conditions are to be pre-calibrated.

Wave elevation probes are to be installed at the model location, alongside and ahead of the intended model location.

The intended wave spectrum is to be run for the full exposure duration required to demonstrate the required probability of capsizing. The analysis of these wave calibration runs is to be used to:

- (A) confirm that the required wave spectrum has been obtained at the model location; and
- (B) verify that the wave spectrum does not deteriorate appreciably during the run in order to help establish the maximum duration test that can be run before the test facility must be allowed to become calm again.

It should be demonstrated that the wave spectrum measured at each of the three locations is the same.

If a free-floating model is to be used, then the waves are to be calibrated for a range of locations down the basin, and the spectrum measured in each of these locations should be shown to be the same. The length of the basin covered by this range will be the permitted test region for the free-floating model, and the model will be recovered when it drifts outside this region (See Section 4). It should be demonstrated that the time series of the waves measured at the model location does not repeat during the run. Furthermore, it should be demonstrated that one or more continuation runs can be performed using exactly the same wave spectrum and period, but with different wave time series. This is to permit a long exposure to the wave conditions to be built up from a number of separate runs without any unrealistic repetition of the time series.

CS-27 BOOK 2

No wind simulation is to be used⁵.

(iv) Required wave run durations

The total duration of runs required to demonstrate that the required probability of capsizing has been achieved (or bettered) is dependent on that probability itself, and on the reliability or confidence of the capsize probability required to be demonstrated.

With the assumption that each 5-minute exposure to the wave conditions is independent, the equations provided in (b)(5) below can be used to determine the duration without a capsize that is required to demonstrate the required performance.⁶ (See Appendix 1 below for examples.)

(4) Test execution and results

Tests are to start with the model at rest and the wave basin calm.

Following the start of the wave maker, sufficient time is to elapse to permit the slowest (highest-frequency) wave components to arrive at the model, before data recording starts.

Wave runs are to continue for the maximum permitted duration determined in the wave calibration test, or in the free-floating option for as long as the model remains in the calibrated wave region. Following sufficient time to allow the basin to become calm again, additional runs are to be conducted until the necessary total exposure duration (T_{test}) has been achieved (see (b)(5) below).

In the case of the free-floating option, the model may be recovered and relaunched without stopping the wave maker, provided that the maximum permitted duration is not exceeded. See paragraph (4)(iv) for requirements regarding relaunching the free-floating model.

If and when a model capsize occurs, the time of the capsize from the start of the run is to be recorded, and the run stopped. The model is to be recovered, drained of any water, and reset in the basin for a continuation run to be performed.

There are a number of options that may be taken following a capsize event:

(i) Continuing with the same model configuration.

If the test is to be continued with the same model configuration, the test can be restarted with a different wave time series, or continued from the point of capsizing in a pseudorandom time series.

(ii) Reducing the wave severity to achieve certification at a lower significant wave height.

Provided that the same basic pseudorandom wave time series can be reproduced by the wave basin at a lower wave height and corresponding period, it is permitted to restart the wave maker time series at a point at least 5 minutes prior to the capsize event, and if the model is now seen to survive the wave sequence that caused a capsize in the more severe condition, then credit can then be taken for the run duration successfully achieved prior to the capsize. Clearly, such a restart is only possible with a model basin using pseudorandom wave generation.

This method is only permitted if the change in significant wave height and period is sufficiently small that the same sequence of capsizing waves, albeit at a lower amplitude, can be seen in the wave basin. If this is not the case, then credit cannot be taken for the exposure time prior to capsize, and the wave time series must be restarted from the beginning.

⁵ Wind generally has a tendency to redirect the rotorcraft nose into the wind/waves, thus reducing the likelihood of capsize. Therefore, this conservative testing approach does not include a wind simulation.

⁶ Each 5-minute exposure might not be independent if, for example, there was flooding of the rotorcraft, progressively degrading its stability. However, in this context, it is considered that the assumption of independence is conservative.

CS-27 BOOK 2

- (iii) Modifying the model with the intention of avoiding a capsizes.

If it is decided to modify the model flotation with the intention of demonstrating that the modified model does not capsize in the wave condition, then the pseudorandom wave maker time series should be restarted at a point at least 5 minutes prior to the capsizes event so that the model is seen to survive the wave that caused a capsizes prior to the modification. Credit can then be taken for the duration of the run successfully achieved prior to the capsizes.

- (iv) Repeating a restrained capsizes event with a free-floating model.

If it is suspected that the model restraint system might have contributed to the capsizes event, it is permitted to repeat that part of the pseudorandom time series with a free-floating model. The model is to be temporally restrained with light lines and then released beam-on to the waves such that the free-floating model is seen to experience the same wave time series that caused a capsizes in exactly the same position in the basin. It is accepted that it might require several attempts to find the precise model release time and position to achieve this.

If the free-floating model, having been launched beam-on to the waves, is seen to yaw into a more beneficial heading once released, and seen to survive the wave that caused a capsizes in the restrained model, then this is accepted as negating the capsizes seen with the restrained model.

The test may then continue with a restrained model as with (i) above.

- (v) Special considerations regarding relaunching a free-floating model into the calibrated wave region.

If a free-floating model is being used for the tests, then it is accepted that the model will need to be recovered as it leaves the calibrated wave region, and then relaunched at the top of that region. It is essential that this process does not introduce any statistical or other bias into the behaviour of the model. For example, there might be a natural tendency to wait for a spell of calmer waves into which to launch the model. This particular bias is to be avoided by strictly obeying a fixed time delay between recovery and relaunch.

Any water accumulated inside the model is not to be drained prior to the relaunch.

If the model has taken up a heading to the waves that is not beam-on, then it is permissible to relaunch the model at that same heading.

In all the above cases, continuation runs are to be performed until the total duration of exposure to the wave condition is sufficient to establish that the 5-minute probability of capsizing has been determined with the required confidence of 95 %.

- (5) Results analysis

Given that it has been demonstrated that the wave time series are non-repeating and statistically random, the results of the tests may be analysed on the assumption that each 5-minute element of the total time series is independent.

If the model rotorcraft has not capsized during the total duration of the tests, the confidence that the probability of capsizing within 5 minutes is less than the target value of $P_{capsizes(target)}$, as shown below:

$$C = 1 - (1 - P_{capsizes(target)})^{\left[\frac{T_{test}}{T_{criterion}} \right]}$$

$$\approx 1 - \exp\left(-\frac{P_{capsizes(target)} T_{test}}{T_{criterion}} \right)$$

CS-27 BOOK 2

and so the total duration of the model test required without capsizes is provided by:

$$T_{test} \approx -\frac{T_{criterion} \ln(1-C)}{P_{capsize(target)}}$$

where:

- (A) T_{test} is the required full-scale duration of the test (in seconds);
- (B) $P_{capsize(target)}$ is the required maximum probability of capsizing within 5 minutes;
- (C) $T_{criterion}$ is the duration (in seconds) in which the rotorcraft must meet the no-capsize probability (= 5 x 60 s), as defined in CS 27.801(e); and
- (D) C is the required confidence that the probability of capsizing has been achieved (0.95).

If the rotorcraft has capsized $N_{capsize}$ times during the tests, the probability of capsizing within 5 minutes can be estimated as:

$$P_{capsize} = \frac{N_{capsize} T_{criterion}}{T_{test}}$$

and the confidence that the required capsizes criteria have been met is:

$$C = 1 - \sum_{k=0}^{N_{capsize}} \frac{([T_{test}/T_{criterion}])!}{([T_{test}/T_{criterion}] - k)!} (P_{capsize(target)})^k (1 - P_{capsize(target)})^{([T_{test}/T_{criterion}] - k)}$$

$$\approx 1 - \left\{ \sum_{k=0}^{N_{capsize}} \frac{1}{k!} \left(\frac{P_{capsize(target)} T_{test}}{T_{criterion}} \right)^k \right\} \exp\left(-\frac{P_{capsize(target)} T_{test}}{T_{criterion}} \right)$$

It should be noted that, if the rotorcraft is permitted to fly over sea conditions with significant wave heights (H_s) above the certification limit, then $P_{capsize(target)}$ should be reduced by the probability of exceedance of the certification limit for the significant wave height (P_e) (see Appendix 2 below).

(c) Deliverables

- (1) A comprehensive report describing the model tests, the facility they were performed in, the model properties, the wave conditions used, the results of the tests, and the method of analysis to demonstrate compliance with CS 27.801(d) and (e).
- (2) Conclusions in this report are to clarify the compliance (or otherwise) with those provisions.
- (3) Digital video and data records of all tests performed.
- (4) A specification for a certification model test should also be expected to include:
 - (i) an execution plan and timescale;
 - (ii) formal progress reports on content and frequency; and
 - (iii) quality assurance requirements.

CS-27 BOOK 2

Appendix 1 — Worked example

The target 5-minute capsizing probabilities for a rotorcraft certified to CS 27.801 are:

Certification with ditching provisions:

| | |
|--|--------|
| Fully serviceable emergency flotation system (EFS) | – 3 % |
| Critical flotation compartment failed | – 30 % |

Certification with emergency flotation provisions:

| | |
|--|----------------------------|
| Fully serviceable emergency flotation system (EFS) | – 10 % |
| Critical flotation compartment failed | —no demonstration required |

One option available to the rotorcraft designer is to test at the selected wave height and demonstrate a probability of capsizing no greater than these values. However, to enhance offshore helicopter safety, some national aviation authorities (NAAs) have imposed restrictions that prevent normal operations (i.e. excluding emergencies, search and rescue (SAR), etc.) over sea conditions that are more severe than those for which performance has been demonstrated. In such cases, the helicopter may be operationally limited.

These operational restrictions may be avoided by accounting for the probability of exposure to sea conditions that exceed the selected wave height by certifying the rotorcraft for a lower probability of capsizing. Since it is conservatively assumed that the probability of capsizing in sea conditions that exceed the certified wave height is unity, the lower capsizing probability required to be met is the target value minus the probability of the selected wave height being exceeded. However, it should also be noted that, in addition to restricting normal helicopter overwater operations to the demonstrated capability, i.e. the applicant's chosen significant wave height limit ($H_{s(limit)}$), an NAA may declare a maximum limit above which all operations will be suspended due to the difficulty of rescuing persons from the sea in extreme conditions. There will, therefore, be no operational benefit in certifying a rotorcraft for sea conditions that exceed the national limits for rescue.

In the following examples, we shall use the three target probabilities of capsizing without any reduction to avoid operational restrictions. The test times quoted are full-scale times; to obtain the actual model test run time, these times should be divided by the square root of the model scale.

Certification with ditching provisions — fully serviceable EFS

Taking this first case, we need to demonstrate a $\leq 3\%$ probability of capsizing with a 95% confidence. Applying equation (5)(i) above, this can be achieved with a 499-minute (full-scale time) exposure to the sea condition without a capsizing.

Rearranging this equation, we have:

$$T_{test} \approx -\ln(1 - C) \frac{T_{criterion}}{P_{capsize(target)}}$$

$$T_{test} \approx -\ln(1 - 0.95) \frac{5 \times 60}{0.03} = 29957 \text{ s} = 499 \text{ min}$$

Alternatively, applying equation (5)(ii) above, the criterion would also be met if the model were seen to capsize just three times (for example) in a total 21.5 hours of exposure to the sea condition, or four times (for example) in a total of 25.5 hours of exposure.

Equation (ii) cannot be readily rearranged to solve T_{test} , so the easiest way to solve it is by using a spreadsheet on a trial-and-error method. For the four-capsizing case, we find that a 25.5-hour exposure gives a confidence of 0.95.

$$C \approx 1 - \left\{ \sum_{k=0}^{4c} \frac{1}{k!} \left(\frac{0.03 \times 25.5 \times 60 \times 60}{5 \times 60} \right)^k \right\} \exp \left(- \frac{0.03 \times 25.5 \times 60 \times 60}{5 \times 60} \right) = 0.95$$

CS-27 BOOK 2**Certification with ditching provisions — critical flotation compartment failed**

In this case, we need to demonstrate a $\leq 30\%$ probability of capsizing with a 95% confidence. This can be achieved with a 50-minute (full-scale time) exposure to the sea condition without a capsizing.

$$T_{test} \approx -\ln(1 - 0.95) \frac{5 \times 60}{0.30} = 2996 \text{ s} = 50 \text{ min}$$

As above, the criterion would also be met if the model were seen to capsize just three times (for example) in a total 2.2 hours of exposure to the sea condition, or four times (for example) in a total of 2.6 hours of exposure.

Solving by trial and error in a spreadsheet, we find that a 2.6-hour exposure with no more than four capsizes gives a confidence of 0.95.

$$C \approx 1 - \left\{ \sum_{k=0}^{4e} \frac{1}{k!} \left(\frac{0.30 \times 2.6 \times 60 \times 60}{5 \times 60} \right)^k \right\} \exp\left(- \frac{0.30 \times 2.6 \times 60 \times 60}{5 \times 60} \right) = 0.95$$

Certification with emergency flotation provisions — fully serviceable EFS

In this case, we need to demonstrate a $\leq 10\%$ probability of capsizing with a 95% confidence. By solving the equations as above, this can be achieved with a 150-minute (full-scale time) exposure to the sea condition without a capsizing.

$$T_{test} \approx -\ln(1 - 0.95) \frac{5 \times 60}{0.10} = 8987 \text{ s} = 150 \text{ min}$$

As above, the criterion would also be met if the model were seen to capsize just three times (for example) in a total 6.5 hours of exposure to the sea condition, or four times (for example) in a total of 7.6 hours of exposure.

Solving by trial and error in a spreadsheet we find that a 7.6-hour exposure with no more than four capsizes gives a confidence of 0.95.

$$C \approx 1 - \left\{ \sum_{k=0}^{4e} \frac{1}{k!} \left(\frac{0.10 \times 7.6 \times 60 \times 60}{5 \times 60} \right)^k \right\} \exp\left(- \frac{0.10 \times 7.6 \times 60 \times 60}{5 \times 60} \right) = 0.95$$

Certification with ditching provisions — critical flotation compartment failed

As stated in CS 27.802(c), no demonstration of capsizing resistance is required for the case of the critical float compartment having failed.

This is because the allowed factor of ten increase in the probability of capsizing, as explained in (a)(3) above, results in a probability of 100%.

CS-27 BOOK 2

Appendix 2 — Test specification rationale

(a) Introduction

The overall risk of capsizing within the 5-minute exposure period consists of two components: the probability of capsizing in a given wave condition, and the probability of experiencing that wave condition in an emergency landing on water.

If it is assumed that an emergency landing on water occurs at random and is not linked with weather conditions, the overall risk of a capsizing can be established by combining two pieces of information:

- (1) The wave climate scatter table, which shows the probability of meeting any particular combination of H_s and T_z . An example scatter table is shown below in **Figure 1 — Example of all-year wave scatter table**. Each cell of the table contains the probability of experiencing a wave condition with H_s and T_z in the range provided. Thus, the total of all cells in the table adds up to unity.
- (2) The probability of a capsizing in a 5-minute exposure for each of these height/period combinations. This probability of capsizing is different for each helicopter design and for each wave height/period combination, and is to be established through scale model testing using the method defined above.

In theory, a model test for the rotorcraft design should be performed in the full range of wave height/period combinations covering all the cells in the scatter table. Clearly, wave height/period combinations with zero or very low probabilities of occurrence might be ignored. It might also be justifiably assumed that the probability of capsizing at very high wave heights is unity, and at very low wave heights, it is zero. However, there would still remain a very large number of intermediate wave height/period combinations that would need to be investigated in model tests, and it is considered that such a test programme would be too lengthy and costly to be practicable.

The objective here is therefore to establish a justifiable method of estimating the overall 5-minute capsize probability using model test results for a single-wave condition. That is a single combination of H_s and T_z . Such a method can never be rigorously linked with the safety objective, but it is proposed that it may be regarded as a conservative approximation.

(b) Test methodology

The proposed test methodology is as follows:

The rotorcraft designer selects a desired significant wave height limit $H_{s(limit)}$ for ditching or the emergency flotation certification of his helicopter. Model tests are performed in the sea condition $H_{s(limit)} T_{z(limit)}$ (where $T_{z(limit)}$ is the zero-crossing period most likely to accompany $H_{s(limit)}$) with the selected spectrum shape using the method specified above, and the 5-minute probability of capsizing ($P_{capsize}$) established in this sea condition.

The way in which $P_{capsize}$ varies for other values of H_s and T_z is not known because it is not proposed to perform model tests in all the other possible combinations. Furthermore, there is no theoretical method to translate a probability of capsizing from one sea condition to another.

However, it is known that the probability of capsizing is related to the exposure to breaking waves of sufficient height, and that this is in turn linked with wave steepness. Hence:

- (1) the probability of capsizing is likely to be higher for wave heights just less than $H_{s(limit)}$ but with wave periods shorter than $T_{z(limit)}$; and
- (2) the probability of capsizing will be lower for the larger population of wave conditions with wave heights less than $H_{s(limit)}$ and with wave periods longer than $T_{z(limit)}$.

So, a reasonable and conservative assumption is that on average, the same $P_{capsize}$ holds good for all wave conditions with heights less than or equal to $H_{s(limit)}$.

A further conservative assumption is that $P_{capsize}$ is unity for all wave heights greater than $H_{s(limit)}$.

Using these assumptions, a comparison of the measured $P_{capsize}$ in $H_{s(limit)} T_{z(limit)}$ against the target probability of capsizing ($P_{capsize(target)}$) can be performed.

CS-27 BOOK 2

In jurisdictions where flying is not permitted when the wave height is above $H_{S(limit)}$, the rotorcraft will have passed the certification criteria provided that $P_{capsize} \leq P_{capsize(target)}$.

In jurisdictions where flying over waves greater than $H_{S(limit)}$ is permitted, the rotorcraft will have passed the certification criteria provided that: $P_{capsize} \leq P_{capsize(target)} - P_e$, where P_e is the probability of exceedance of $H_{S(limit)}$. Clearly, in this case, it can be seen that it would not be permissible for the rotorcraft designer to select an $H_{S(limit)}$ which has a probability of exceedance greater than $P_{capsize(target)}$.

| Hs (m) >= Hs (m) < | | | | | | | | | | | | | | | | | | | | | | TOTALS | | |
|--------------------|------|-----|-----|-----|-----|-----|-----|-----|-----|-----|-----|-----|-----|-----|-----|-----|-----|------|------|------|------|--------|--------|--------|
| 12.5 | 13 | | | | | | | | | | | | | | | | | | | | | 0.0000 | 0.0000 | 0.0000 |
| 12 | 12.5 | | | | | | | | | | | | | | | | | | | | | | | 0.0000 |
| 11.5 | 12 | | | | | | | | | | | | | | | | | | | | | | | 0.0000 |
| 11 | 11.5 | | | | | | | | | | | | | | | | | | | | | | | 0.0000 |
| 10.5 | 11 | | | | | | | | | | | | | | | | | | | | | | | 0.0000 |
| 10 | 10.5 | | | | | | | | | | | | | | | | | | | | | | | 0.0001 |
| 9.5 | 10 | | | | | | | | | | | | | | | | | | | | | | | 0.0001 |
| 9 | 9.5 | | | | | | | | | | | | | | | | | | | | | | | 0.0002 |
| 8.5 | 9 | | | | | | | | | | | | | | | | | | | | | | | 0.0004 |
| 8 | 8.5 | | | | | | | | | | | | | | | | | | | | | | | 0.0007 |
| 7.5 | 8 | | | | | | | | | | | | | | | | | | | | | | | 0.0010 |
| 7 | 7.5 | | | | | | | | | | | | | | | | | | | | | | | 0.0017 |
| 6.5 | 7 | | | | | | | | | | | | | | | | | | | | | | | 0.0028 |
| 6 | 6.5 | | | | | | | | | | | | | | | | | | | | | | | 0.0045 |
| 5.5 | 6 | | | | | | | | | | | | | | | | | | | | | | | 0.0075 |
| 5 | 5.5 | | | | | | | | | | | | | | | | | | | | | | | 0.0120 |
| 4.5 | 5 | | | | | | | | | | | | | | | | | | | | | | | 0.0195 |
| 4 | 4.5 | | | | | | | | | | | | | | | | | | | | | | | 0.0301 |
| 3.5 | 4 | | | | | | | | | | | | | | | | | | | | | | | 0.0457 |
| 3 | 3.5 | | | | | | | | | | | | | | | | | | | | | | | 0.0683 |
| 2.5 | 3 | | | | | | | | | | | | | | | | | | | | | | | 0.0998 |
| 2 | 2.5 | | | | | | | | | | | | | | | | | | | | | | | 0.1396 |
| 1.5 | 2 | | | | | | | | | | | | | | | | | | | | | | | 0.1826 |
| 1 | 1.5 | | | | | | | | | | | | | | | | | | | | | | | 0.2125 |
| 0.5 | 1 | | | | | | | | | | | | | | | | | | | | | | | 0.1534 |
| 0 | 0.5 | | | | | | | | | | | | | | | | | | | | | | | 0.0175 |
| Tz (s) >= | 1.5 | 2 | 2.5 | 3 | 3.5 | 4 | 4.5 | 5 | 5.5 | 6 | 6.5 | 7 | 7.5 | 8 | 8.5 | 9 | 9.5 | 10 | 10.5 | 11 | 11.5 | | | 1.0000 |
| Tz (s) < | 2 | 2.5 | 3 | 3.5 | 4 | 4.5 | 5 | 5.5 | 6 | 6.5 | 7 | 7.5 | 8 | 8.5 | 9 | 9.5 | 10 | 10.5 | 11 | 11.5 | 12 | | | |

Figure 1 — Example of all-year wave scatter table

[Amdt No: 27/5]

AMC 27.802 Emergency Flotation

This AMC replaces FAA AC 27 MG 10.

(a) Definitions

- (1) Ditching: a controlled emergency landing on the water, deliberately executed in accordance with rotorcraft flight manual (RFM) procedures, with the intent of abandoning the rotorcraft as soon as practicable.

NOTE: Although the term ‘ditching’ is most commonly associated with the design standards related to CS 27.801, a rotorcraft equipped to the less demanding requirements of CS 27.802, when performing an emergency landing on water, would nevertheless be commonly described as carrying out the process of ditching. The term ‘ditching’ is therefore used in this AMC in this general sense.

- (2) Emergency flotation system (EFS): a system of floats and any associated parts (e.g. gas cylinders, means of deployment, pipework and electrical connections) that is designed and installed on a rotorcraft to provide buoyancy and flotation stability during and after ditching.

(b) Explanation

- (1) Approval of emergency flotation equipment is performed only if requested by the applicant. Operational rules may accept that a helicopter conducts flights over certain sea areas provided it is fitted with approved emergency flotation equipment (i.e. an EFS), rather than being certified with full ditching provisions.

CS-27 BOOK 2

- (2) Emergency flotation certification encompasses emergency flotation system loads and design, and rotorcraft flotation stability.
 - (3) Failure of the EFS to operate when required will lead to the rotorcraft rapidly capsizing and sinking. Operational experience has shown that localised damage or failure of a single component of an EFS can lead to the loss of the complete system. Therefore, the design of the EFS needs careful consideration.
 - (4) The sea conditions, on which certification with emergency flotation is to be based, are selected by the applicant and should take into account the expected sea conditions in the intended areas of operation. Capsize resistance is required to meet the same requirements as for full ditching approval but with the allowable capsize probability being set at 10 %. The default wave climate specified in this requirement is that of the northern North Sea, as it represents a conservative condition. An applicant might consider this to be inappropriate, as it represents a hostile sea area. The applicant may therefore propose a different wave climate based on data from a non-hostile sea area. The associated certification will then be limited to the geographical region(s) thus represented. Alternatively, a non-hostile default wave climate might be agreed, with no associated need for geographical limits to the certification. The significant wave height, and any geographical limitations (if applicable, see the AMC to 27.801(e) and 27.802(c)) should be included in the RFM as performance information.
 - (5) During scale model testing, appropriate allowances should be made for probable structural damage and leakage. Previous model tests and other data from rotorcraft of similar configurations that have already been substantiated based on equivalent test conditions may be used to satisfy the emergency flotation requirements. In regard to flotation stability, test conditions should be equivalent to those defined in the AMC to 27.801(e) and 27.802(c).
 - (6) CS 27.802 requires that in sea conditions for which certification with emergency flotation is requested by the applicant, the probability of capsizing in a 5-minute exposure is acceptably low in order to allow the occupants to leave the rotorcraft and enter the life rafts. This should be interpreted to mean that up to and including the worst-case sea conditions for which certification with emergency flotation is requested by the applicant, the probability that the rotorcraft will capsize should be not higher than the target stated in CS 27.802(c). An acceptable means of demonstrating post-ditching flotation stability is through scale model testing using irregular waves. The AMC to 27.801(e) and 27.802(c) contains a test specification that has been developed for this purpose.
 - (7) Providing a 'wet floor' concept (water in the cabin) by positioning the floats higher on the fuselage sides and allowing the rotorcraft to float lower in the water can be a way of increasing the stability of a ditched rotorcraft (although this would need to be verified for the individual rotorcraft type for all weight and loading conditions), or it may be desirable for other reasons. This is permissible provided that the mean static level of water in the cabin is limited to being lower than the upper surface of the seat cushion (for all rotorcraft mass and centre of gravity cases, with all flotation units intact), and that the presence of water will not unduly restrict the ability of occupants to evacuate the rotorcraft and enter the life raft.
 - (8) The sea conditions approved for ditching should be stated in the performance information section of the RFM.
- (c) Procedures
- (1) Flotation system design
 - (i) Structural integrity should be established in accordance with CS 27.563. CS 27.802(a) only requires the floats and their attachments to the rotorcraft to be designed to withstand the load conditions defined in CS 27.563. Other parts of the rotorcraft (e.g. fuselage underside structure, chin windows, doors) do not need to be shown to be capable of withstanding these load conditions.
 - (ii) Rotorcraft handling qualities should be verified to comply with the applicable certification specifications throughout the approved flight envelope with floats

CS-27 BOOK 2

installed. Where floats are normally deflated and deployed in flight, the handling qualities should be verified for the approved operating envelopes with the floats in:

- (A) the deflated and stowed condition;
 - (B) the fully inflated condition; and
 - (C) the in-flight inflation condition; for float systems which may be inflated in flight, rotorcraft controllability should be verified by test or analysis taking into account all possible emergency flotation system inflation failures.
- (iii) Reliability should be considered in the basic design to assure approximately equal inflation of the floats to preclude excessive yaw, roll, or pitch in flight or in the water:
- (A) Maintenance procedures should not degrade the flotation system (e.g. introducing contaminants that could affect normal operation, etc.).
 - (B) The flotation system design should preclude inadvertent damage due to normal personnel traffic flow and wear and tear. Protection covers should be evaluated for function and reliability.
 - (C) The designs of the floats should provide means to minimise the likelihood of damage or tear propagation between compartments. Single compartment float designs should be avoided.
- (iv) The floats should be fabricated from highly conspicuous materials to assist in locating the rotorcraft following a ditching (and possible capsizing).
- (2) Flotation system inflation

Emergency flotation systems (EFSs) which are normally stowed in a deflated condition and are inflated either in flight or after water contact should be evaluated as follows:

- (i) The emergency flotation system should include a means to verify system integrity prior to each flight.
- (ii) If a manual means of inflation is provided, the float activation switch should be located on one of the primary flight controls and should be safeguarded against inadvertent actuation.
- (iii) The inflation system should be safeguarded against spontaneous or inadvertent actuation in flight conditions for which float deployment has not been demonstrated to be safe.
- (iv) The maximum airspeeds for intentional in-flight actuation of the emergency flotation system and for flight with the floats inflated should be established as limitations in the RFM unless in-flight actuation is prohibited by the RFM.
- (v) Activation of the emergency flotation system upon water entry (irrespective of whether or not inflation prior to water entry is the intended operation mode) should result in an inflation time short enough to prevent the rotorcraft from becoming excessively submerged.
- (vi) A means should be provided for checking the pressure of the gas stowage cylinders prior to take-off. A table of acceptable gas cylinder pressure variation with ambient temperature and altitude (if applicable) should be provided.
- (vii) A means should be provided to minimise the possibility of over-inflation of the flotation units under any reasonably probable actuation conditions.
- (viii) The ability of the floats to inflate without puncturing when subjected to actual water pressures should be substantiated. A demonstration of a full-scale float immersion in a calm body of water is one acceptable method of substantiation. Precautions should also be taken to avoid floats being punctured due to the proximity of sharp objects, during inflation in flight or with the helicopter in the water, and during subsequent movement of the helicopter in waves. Examples of objects that need to be considered are airdrops, probes, overboard vents, unprotected split-pin tails,

CS-27 BOOK 2

guttering and any projections sharper than a three-dimensional right angled corner.

(3) Injury prevention during and following water entry.

An assessment of the cabin and cockpit layouts should be undertaken to minimise the potential for injury to occupants in a ditching. This may be performed as part of the compliance with CS 27.785. Attention should be given to the avoidance of injuries due to leg/arm flailing, as these can be a significant impediment to occupant egress and subsequent survivability. Practical steps that could be taken include:

- (i) locating potentially hazardous items away from the occupants;
- (ii) installing energy-absorbing padding onto interior components;
- (iii) using frangible materials; and
- (iv) designs that exclude hard or sharp edges.

(4) Water entry procedures.

Tests or simulations (or a combination of both) should be conducted to establish procedures and techniques to be used for water entry. These tests/simulations should include determination of the optimum pitch attitude and forward velocity for ditching in a calm sea, as well as entry procedures for the most severe sea condition to be certified. Procedures for all failure conditions that may lead to a 'land immediately' action (e.g. one engine inoperative, all engines inoperative, tail rotor/drive failure) should be established.

(5) Flotation stability tests.

An acceptable means of flotation stability testing is contained in AMC to 27.801(e) and 27.802(c). Note that model tests in a wave basin on a number of different rotorcraft types have indicated that an improvement in seakeeping performance can consistently be achieved by fitting float scoops.

(6) Occupant egress and survival.

The ability of the occupants to deploy life rafts, egress the rotorcraft, and board the life rafts should be evaluated. For configurations which are considered to have critical occupant egress capabilities due to the life raft locations or the emergency exit locations and the proximity of the float (or a combination of both), an actual demonstration of egress may be required. When a demonstration is required, it may be conducted on a full-scale rotorcraft actually immersed in a calm body of water or using any other rig or ground test facility shown to be representative. The demonstration should show that floats do not impede a satisfactory evacuation. Service experience has shown that it is possible for occupants to have escaped from the cabin but to have not been able to board a life raft and to have had difficulty in finding handholds to stay afloat and together. Handholds or lifelines should be provided on appropriate parts of the rotorcraft. The normal attitude of the rotorcraft and the possibility of a capsized should be considered when positioning the handholds or lifelines.

[Amdt No: 27/5]

AMC 27.805(c) Flight crew emergency exits

This AMC supplements FAA AC 27.805.

(a) Explanation

To facilitate a rapid escape, flight crew underwater emergency exits should be designed for use with the rotorcraft in both the upright position and in any foreseeable floating attitude. The flight crew underwater emergency exits should not be obstructed during their operation by water or floats to the extent that rapid escape would not be possible or that damage to the flotation system may occur. This should be substantiated for any rotorcraft floating attitude, upright or capsized, and with the emergency flotation system intact and with any single compartment failed. With the rotorcraft capsized and floating, the flight crew underwater emergency exits

CS-27 BOOK 2

should be usable with the cabin flooded, and the markings required to enable occupants to escape in darkness should continue to function when the rotorcraft is capsized and the cabin is submerged.

(b) Procedures

- (1) It should be shown by test, demonstration or analysis that there is no interference with the flight crew underwater emergency exits from water or any stowed or deployed emergency flotation devices, with the rotorcraft in any foreseeable floating attitude.
- (2) Flight crew should be able to reach the operating device for their underwater emergency exit, whilst seated, with restraints fastened, with seat energy absorption features at any design position, and with the rotorcraft in any attitude.
- (3) Likely damage sustained during a ditching should be considered.
- (4) It is acceptable for the underwater emergency exit threshold to be below the waterline when the rotorcraft is floating upright, but in such a case, it should be substantiated that there is no obstruction to the use of the exit and that no excessive force (see FAA AC 29.809) is required to operate the exit.
- (5) It is permissible for flight crew to be unable to directly enter life rafts from the underwater flight crew emergency exits and to have to take a more indirect route, e.g. by climbing over a forward flotation unit. In such a case, the feasibility of the exit procedure should be assessed. Handholds may need to be provided on the rotorcraft.
- (6) CS 27.807(b)(3) requires emergency exit markings to be provided and enable the emergency exit to be located and operated in darkness. Furthermore, CS 27.805(c) requires these illuminated markings to continue to function if the cabin becomes submerged. This should be shown by test, demonstration or analysis.
- (7) To make it easier to recognise underwater, the operating device for the underwater emergency exit should have black and yellow markings with at least two bands of each colour of approximately equal widths. Any other operating feature, e.g. highlighted 'push here' decal(s) for openable windows, should also incorporate black-and-yellow-striped markings.

[Amdt No: 27/5]

AMC 27.807(d) Underwater emergency exits for passengers

This AMC replaces FAA AC 27.807, AC 27.807A and AC 27.807B.

(a) Explanation

CS-27 Amendment 5 re-evaluates the need for and the concept behind emergency exits for rotorcraft approved with ditching provisions. Prior to CS-27 Amendment 5, there were no additional ditching provisions for rotorcraft certified for ditching with regard to the number of emergency exits.

Operational experience has shown that in a ditching in which the rotorcraft remains upright, use of the passenger doors can be very beneficial in ensuring a rapid and orderly evacuation onto the life raft(s). However, when a rotorcraft capsizes, doors may be unusable and the number and availability of emergency exits that can be readily used underwater will be crucial to ensuring that passengers are able to escape in a timely manner. Experience has shown that the number of emergency exits required in the past by design requirements has been inadequate in a capsized situation, and a common design solution has been to use the passenger cabin windows as additional emergency egress means by including a jettison feature. The jettison feature has commonly been provided by modifying the elastomeric window seal such that its retention strength is either reduced, or can be reduced by providing a removable part of its cross section, i.e. the so called 'push out' window, although other design solutions have been employed. The provision of openable windows has been required by some air operations regulations.

CS-27 BOOK 2

In recognition of this identified need for an increased number of exits for underwater escape, Amendment 5 created a new set of exit terminology and CS 27.807(d)(1) was revised to require one pair of 'underwater emergency exits', i.e. one on each side of the rotorcraft, to be provided for each unit, or part of a unit, of four passenger seats, and passenger seats to be located relative to these exits in a way to best facilitate escape. This new terminology was seen as describing the real intent of this higher number of required emergency exits for rotorcraft approved with ditching provisions.

The objective is for no passenger to be in a worse position than the second person to egress through an exit. The size of each underwater emergency exit should at least meet the dimensional provisions of CS 27.807(b)(1), i.e. it should provide an unobstructed opening through which a 0.48 m x 0.66 m (19 in. x 26 in.) elliptical object could pass.

This provision is based on the need to facilitate egress in the case of a capsizing that occurs soon after the rotorcraft has alighted on the water or in the event of a survivable water impact in which the cabin will likely be immediately flooded. The time available for evacuation is very short in such situations, and therefore, CS-27 Amendment 5 has increased the safety level by mandating additional exits, in the form of underwater emergency exits, to both shorten available escape routes and to ensure that no occupant should need to wait for more than one other person to escape before being able to make their own escape. The provision of an underwater emergency exit in each side of the fuselage for each unit (or part of a unit) of four passenger seats will make this possible, provided that seats are positioned relative to the exits in a favourable manner.

Critical evacuation factors are the distance to an underwater emergency exit and how direct and obvious the exit route is, taking into account that the passengers are likely to be disoriented.

So called 'push-out' windows (see above) have some advantages in that they are not susceptible to jamming and may open by themselves in a water impact due to flexing of the fuselage upon water entry and/or external water pressure.

The risk of a capsizing during evacuation onto the life rafts can be mitigated to some extent by instructing passengers to open all the underwater emergency exits as a matter of course soon after the helicopter has alighted on the water, thus avoiding the delay due to opening the exits in the event that the exits are needed. Such advice should be considered for inclusion in the documentation provided to the helicopter operator.

(b) Procedures

- (1) The number and the size of underwater emergency exits should be as specified above.
- (2) Care should be taken regarding oversized exits to avoid them becoming blocked if more than one passenger attempts to use the same exit simultaneously.
- (3) A higher seat-to-exit ratio may be accepted if the exits are large enough to allow the simultaneous escape of more than one passenger. For example, a pair of exits may be approved for eight passengers if the size of each exit provides an unobstructed area that encompasses two ellipses of 0.48 m x 0.66 m (19 in. x 26 in.) side by side.
- (4) Test, demonstration, compliance inspection, or analysis is required to substantiate that an exit is free from interference from stowed or deployed emergency flotation devices. In the event that an analysis or inspection is insufficient or that a given design is questionable, a test or demonstration may be required. Such a test or demonstration would consist of an accurate, full-size replica (or true representation) of the rotorcraft and flotation devices, both when stowed and after their deployment.
- (5) Consideration should be given to reducing the potential confusion caused by the lack of standardisation of the location of the operating devices (pull tab, handle) for underwater emergency exits. For example, the operating device should be located next to the handhold (see (10) below). The occupant then has only to find the handhold to locate the operating device. Each adjacent occupant should be able to reach the handhold and operating device whilst seated, with restraints fastened, with seat energy absorption features at any design position, and with the rotorcraft in any attitude. If a single underwater emergency exit is designed for the simultaneous egress of two occupants

CS-27 BOOK 2

side by side, a handhold and an operating device should be within reach of each occupant seated adjacent to the exit.

- (6) Underwater emergency exits should be shown to be operable with the rotorcraft in any foreseeable attitude, including with the rotorcraft capsized.
- (7) Underwater emergency exits should be designed so that they are optimised for use with the rotorcraft capsized. For example, the handhold(s) should be located close to the bottom of the window (top if inverted) to assist an occupant in overcoming the buoyancy loads of an immersion suit, and by ensuring that markings and lighting will help identify the exit(s) and readily assist in an escape.
- (8) The means to open an underwater emergency exit should be simple and obvious and should not require any exceptional effort. Designs with any of the following characteristics (non-exhaustive list) are considered to be non-compliant:
 - (i) More than one hand is needed to operate the exit itself (use of the handhold may occupy the other hand);
 - (ii) Any part of the opening means, e.g. an operating handle or control, is located remotely from the exit such that it would be outside of a person's direct vision when looking directly at the exit, or that the person needs to move away from the immediate vicinity of the exit in order to reach it; and
 - (iii) The exit does not meet the opening effort limitations set by FAA AC 29.809.
- (9) It should be possible to readily grasp and operate any operating handle or control using either a bare or a gloved hand.
- (10) Handholds, as required by CS 27.807(d)(3), should be mounted close to the bottom of each underwater emergency exit such that they fall easily to hand for a normally seated occupant. In the case of exits between face-to-face seating, the provision of two handholds is required. Handholds should be designed such that the risk is low of escapees' clothing or emergency equipment snagging on them.
- (11) To make it easier to recognise underwater, the operating device for the underwater emergency exit should have black and yellow markings with at least two bands of each colour of approximately equal widths. Any other operating features, e.g. highlighted 'push here' decal(s) for openable windows, should also incorporate black-and-yellow-striped markings.
- (12) With regard to the location of seats relative to the exits, the most obvious layout that maximises achievement of the objective that no passenger is in a worse position than the second person to egress through an exit is a four-abreast arrangement with all the seats in each row located appropriately and directly next to the emergency exits. However, this might not be possible in all rotorcraft designs due to issues such as limited cabin width, the need to locate seats such as to accommodate normal boarding and egress, and the installation of items other than seats in the cabin. Notwithstanding this, an egress route necessitating movement such as along an aisle, around a cabin item, or in any way other than directly towards the nearest emergency exit, to escape the rotorcraft is not considered to be compliant with CS 27.807(d)(1).

[Amdt No: 27/5]

AMC 27.865 External Loads

This AMC provides further guidance and acceptable means of compliance to supplement FAA AC 27-1B Change 7 AC 27.865B § 27.865 EXTERNAL LOADS to meet EASA's interpretation of CS 27.865. As such, it should be used in conjunction with the FAA AC but should take precedence over it, where stipulated, in the showing of compliance.

AMC No 1 addresses certification for applications that require the use of Category A rotorcraft.

AMC No 2 addresses the specificities of complex personnel-carrying device systems for human external cargo applications. This AMC provides further guidance and acceptable means of compliance to supplement FAA AC 27-1B Change 7 AC 27.865B § 27.865 (Amendment 27-36) EXTERNAL LOADS to meet EASA's interpretation of CS 27.865.

CS-27 BOOK 2

AMC No 3 contains a recognised approach to the approval of simple personnel-carrying device systems if required by the applicable operating rule or if an applicant elects to include simple personnel-carrying device systems within the scope of type certification.

[Amdt No: 27/6]

AMC No 1 to CS 27.865 Human External Cargo applications that require the use of Category A rotorcraft

1. Introduction

This additional EASA AMC, used in conjunction with FAA guidance⁷ on Human External Cargo (HEC), provides an acceptable means of compliance with CS 27.865 for Human External Cargo (HEC) applications requiring the use of Category A rotorcraft.

This AMC addresses the difference in operational requirements between the USA and Europe and the absence of dedicated material within the FAA AC.

2. Basic Definition and Intended Use

CS 27.865 classifies external loads as HEC or NHEC, which are defined in AMC No 2 to CS 27.865. Operational rules may, however, require the use of Category A rotorcraft for specific applications, and this AMC clarifies the corresponding considerations for compliance with CS 27.865.

3. Certification Considerations

For Category A, a one-engine-inoperative/out-of-ground effect (OEI/OGE) hover performance weight, altitude and temperature envelope should be provided in the flight manual. This becomes the maximum envelope that can be used for HEC applications requiring OEI/OGE hover performance.

4. Compliance Procedures

4.1 The rotorcraft is required to meet the Category A engine isolation specifications of CS-27 Appendix C, and provide an OEI/OGE hover performance data for a jettisonable HEC weight, altitude, and temperature envelope.

- (i) In determining OEI hover performance, dynamic engine failures should be considered. Each hover verification test should begin from a stabilised hover at the maximum OEI hover weight, at the requested in-ground-effect (IGE) or OGE skid or wheel height, and with all engines operating. At this point, the critical engine should be failed and the aircraft should remain in a stabilised hover condition without exceeding any rotor limits or engine limits for the operating engine(s). As with all performance testing, engine power should be limited to minimum specification power.
- (ii) Normal pilot reaction time should be used following the engine failure to maintain the stabilised hover flight condition. When hovering OGE or IGE at maximum OEI hover weight, an engine failure should not result in an altitude loss of more than 10 percent or four (4) feet, whichever is greater, of the altitude established at the time of engine failure. In either case, a sufficient power margin should be available from the operating engine(s) to regain the altitude lost during the dynamic engine failure and to transition to forward flight.
- (iii) Consideration should also be given to the time required to recover or manoeuvre the human external cargo and to transition into forward flight. An example, is the time to winch up and bring aboard personnel in hoisting operations or manoeuvre clear of power lines for fixed strop/basket operations. The time necessary to perform such

⁷ See reference in AMC 27 General.

CS-27 BOOK 2

actions may exceed the short duration OEI power ratings. For example, for a helicopter with a 30-second/2-minute rating structure that sustains an engine failure at a height of 40 feet, the time required to re-stabilise in a hover, recover the external load (given the hoist speed limitations), and then transition to forward flight (with minimal altitude loss) would likely exceed 30 seconds and a power reduction into the 2-minute rating would be necessary.

- (iv) The rotorcraft flight manual (RFM) should contain information that describes the expected altitude loss, any special recovery techniques, and the time increment used for recovery of the external load when establishing maximum weights and wheel or skid heights. The OEI hover chart should be placed in the performance section of the RFM or RFM supplement. Allowable altitude extrapolation for the hover data should not exceed 2000 feet.
- 4.2 For helicopters that incorporate engine-driven generators, the hoist should remain operational following an engine or generator failure. A hoist should not be powered from a bus that is automatically shed following the loss of an engine or generator. Maximum two-engine generator loads should be established so that when one engine or generator fails, the remaining generator can assume the entire rotorcraft electrical load (including the maximum hoist electrical load) without exceeding approved limitations.
- 4.3 The external load attachment means and the complex personnel-carrying device should be shown to meet the provisions of CS 27.865(a) for the proposed operating envelope.
- 4.4 The rotorcraft is required to be equipped for, or otherwise allow, direct intercommunication under any operational conditions among crew members and the HEC. For HEC applications that require the use of Category A rotorcraft, two-way radios or intercoms should be employed.

[Amdt No: 27/6]

AMC No 2 to CS 27.865 EXTERNAL LOADSa. Explanation

- (1) This AMC contains guidance for the certification of helicopter external-load attaching means and load-carrying systems to be used in conjunction with operating rules, such as Regulation (EU) No 965/2012 on Air Operations⁸. Also, paragraph CS 27.25 concerns, in part, jettisonable external cargo.
- (2) CS 27.865 provides a minimum level of safety for small rotorcraft designs to be used with operating rules, such as Regulation (EU) No 965/2012 on Air Operations. Certain aspects of operations, such as microwave tower and high-line wirework, may also be regulated separately by other national rules. For applications that could fall under the scope of applicability of several regulations, special certification emphasis will be required by both the applicant and the approving authority to assure all relevant safety requirements are identified and met. Potential additional requirements, where thought to exist, are noted herein.
- (3) The CS 27.865 provisions for external loads do not discern the difference between a crew member and a compensating passenger when either is carried external to the rotorcraft. Both are considered to be HEC.

b. Definitions

- (1) Backup quick-release subsystem (BQRS): the secondary or 'second choice' subsystem used to perform a normal or emergency jettison of external cargo.

⁸ Commission Regulation (EU) No 965/2012 of 5 October 2012 laying down technical requirements and administrative procedures related to air operations pursuant to Regulation (EC) No 216/2008 of the European Parliament and of the Council (OJ L 296, 25.10.2012, p. 1).

CS-27 BOOK 2

- (2) Cargo: the part of any rotorcraft-load combination that is removable, changeable, and is attached to the rotorcraft by an approved means. For certification purposes, 'cargo' applies to HEC and non-human external cargo (NHEC).
- (3) Cargo hook: a hook that can be rated for both HEC and NHEC. It is typically used by being fixed directly to a designated hard point on the rotorcraft.
- (4) Dual actuation device (DAD): this is a sequential control that requires two distinct actions in series for actuation. One example is the removal of a lock pin followed by the activation of a 'then free' switch or lever for load release to occur (in this scenario, a load release switch protected only by an uncovered switch guard is not acceptable). For jettisonable HEC applications, a simple, covered switch does not qualify as a DAD. Familiarity with covered switches allows the pilot to both open and activate the switch in one motion. This has led to inadvertent load release.
- (5) Emergency jettison (or complete load release): the intentional, instantaneous release of NHEC or HEC in a preset sequence by the quick-release system (QRS) that is normally performed to achieve safer aircraft operation in an emergency.
- (6) External fixture: a structure external to and in addition to the basic airframe that does not have true jettison capability and has no significant payload capability in addition to its own weight. An example is an agricultural spray boom. These configurations are not approvable as 'External Loads' under CS 27.865.
- (7) External Load System. The entire installation related to the carriage of external loads to include not only the hoist or hook, but also the structural provisions and release systems. A complex PCDS is also considered to be part of the external load system.
- (8) Hoist: a hoist is a device that exerts a vertical pull, usually through a cable and drum system (i.e. a pull that does not typically exceed a 30-degree cone measured around the z-rotorcraft axis).
- (9) Hoist demonstration cycle (or 'one cycle'): the complete extension and retraction of at least 95 % of the actual cable length, or 100 % of the cable length capable of being used in service (i.e. that would activate any extension or retraction limiting devices), whichever is greater.
- (10) Hoist load-speed combinations: some hoists are designed so that the extension and retraction speed slows as the load increases or nears the end of a cable extension. Other hoist designs maintain a constant speed as the load is varied. In the latter designs, the load-speed combination simply means the variation in load at the constant design speed of the hoist.
- (11) Human external cargo (HEC): a person (or persons) who, at some point in the operation, is (are) carried external to the rotorcraft.
- (12) Non-human external cargo (NHEC): any external cargo operation that does not at any time involve a person (or persons) carried external to the rotorcraft.
- (13) Normal jettison (or selective load release): the intentional release, normally at optimum jettison conditions, of NHEC.
- (14) Personnel-carrying device system (PCDS) is a device that has the structural capability and features needed to transport occupants external to the helicopter during HEC or helicopter hoist operations. A PCDS includes but is not limited to life safety harnesses (including, if applicable, a quick-release and strop with a connector ring), rigid baskets and cages that are either attached to a hoist or cargo hook or mounted to the rotorcraft airframe.
- (15) Primary quick-release subsystem (PQRS): the primary or 'first choice' subsystem used to perform a normal or emergency jettison of external cargo.
- (16) Quick-release system (QRS): the entire release system for jettisonable external cargo (i.e. the sum total of both the primary and backup quick-release subsystem). The QRS consists of all the components including the controls, the release devices, and everything in between.

CS-27 BOOK 2

- (17) Rescue hook (or hook): a hook that can be rated for both HEC and NHEC. It is typically used in conjunction with a hoist or equivalent system.
- (18) Rotorcraft-load combination (RLC): the combination of a rotorcraft and an external load, including the external-load attaching means.
- (19) Spider: a spider is a system of attaching a lowering cable or rope or a harness to an NHEC (or HEC) RLC to eliminate undesirable flight dynamics during operations. A spider usually has four or more legs (or load paths) that connect to various points of a PCDS to equalise loading and prevent spinning, twisting, or other undesirable flight dynamics.
- (20) True jettison capability: the ability to safely release an external load using an approved QRS in 30 seconds or less.

NOTE: In all cases, a PQRS should release the external load in less than 5 seconds. Many PQRSs will release the external load in milliseconds, once the activation device is triggered. However, a manual BQRS, such as a set of cable cutters, could take as much as 30 seconds to release the external load. The 30 seconds would be measured starting from the time the release command was given and ending when the external load was cut loose.

- (21) True payload capability: the ability of an external device or tank to carry a significant payload in addition to its own weight. If little or no payload can be carried, the external device or tank is an external fixture (see definition above).
- (22) Winch: a winch is a device that can employ a cable and drum or other means to exert a horizontal (i.e. x-rotorcraft axis) pull. However, in designs that utilise a winch to perform a hoist function by use of a 90-degree cable direction change device (such as a pulley or pulley system), the winch system is considered to be a hoist.

c. Procedures

The following certification procedures are provided in the most general form. Where there are significant differences between the cargo types, these differences are highlighted.

- (1) General Compliance Procedures for CS 27.865: The applicant should clearly identify the applicable cargo types (NHEC or HEC) for which an application is being made. The structural loads and operating envelopes for each applicable cargo type should be determined and used to formulate the flight manual supplement and basic loads report. The applicant should show by analysis, test, or both, that the rotorcraft structure, the external-load attaching means, and the complex PCDS, if applicable, meet the specific requirements of CS 27.865 and any other relevant requirements of CS-27 for the proposed operating envelope.

NOTE: the approved maximum internal gross weight should never be exceeded for any approved HEC configuration (or simultaneous NHEC and HEC configuration).

- (2) Reliability of the external load system, including the QRS.
 - (i) The hoist, QRS, and rescue hook system should be reliable for all phases of flight and the applicable configurations for those phases (i.e. operating, stowed, or unstowed) for which approval is sought. The hoist should be disabled (or an overriding, fail-safe mechanical safety device such as either a flagged removable shear pin or a load-lowering brake should be utilised) to prevent inadvertent load unspooling or release during any extended flight phases in which hoist operation is not intended. Loss of hoist operational control should also be considered.
 - (ii) A failure of the external load system (including QRS, hook, complex PCDS where applicable, and attachments to the rotorcraft) should be shown to be extremely improbable (i.e. 1×10^{-9} failures per flight) for all failure modes that could cause a catastrophic failure, serious injury or a fatality anywhere in the total airborne system. Uncontrolled high-speed descent of the hoist cable would fall into this category. All significant failure modes of lesser consequence should be evaluated and shown to be at least improbable (i.e. 1×10^{-5} failures per flight).
 - (iii) The reliability of the system should be demonstrated by completion and approval of the following:

CS-27 BOOK 2

- (A) A functional hazard assessment (FHA) to determine the hazard severity of failures associated with the external load system. The effect of the flailing cable after a load release should be considered.
 - (B) A fault tree analysis (FTA) or equivalent to verify that the hazard classification of the FHA has been met.
 - (C) A system safety assessment (SSA) to demonstrate compliance with the applicable certification requirements.
 - (D) An analysis of the non-redundant external load system components that constitute the primary load path (e.g., beam, cable, hook), to demonstrate compliance with the applicable structural requirements.
 - (E) A repetitive test of all functional devices that cycles these devices under critical structural conditions, operational conditions, or a combination of both, at least 10 times each for NHEC and 30 times for HEC. This is applicable to both primary and backup subsystems. It is assumed that only one hoist cycle will typically occur per flight. This rationale has been used to determine the 10 demonstration cycles for NHEC applications and 30 demonstration cycles for HEC applications. However, if a particular application requires more than one hoist cycle per flight, then the number of demonstration cycles should be increased accordingly by multiplying the test cycles by the intended higher cycle number per flight. These repetitive tests may be conducted on the rotorcraft or by using a bench simulation that accurately replicates the rotorcraft installation.
 - (F) An environmental qualification for the proposed operating environment. This review includes consideration of low and high temperatures (typically – 40 °C (– 40 °F) to + 65.6 °C (+ 150 °F), altitudes to 12 000 feet, humidity, salt spray, sand and dust, vibration, shock, rain, fungus, and acceleration. The appropriate rotorcraft sections of RTCA Document DO-160/ EUROCAE ED-14 for high and low temperature and vibration are considered to be acceptable for environmental qualification. The environmental qualification will address icing for those external load systems installed on rotorcraft approved for flight into icing conditions.
 - (G) Qualification of the hoist itself to the appropriate electromagnetic interference (EMI) and lightning threat levels specified for NHEC or HEC, as applicable. This qualification can occur separately or as part of the entire on-board QRS.
- (3) Testing.
- (i) Hoist system load-speed combination ground tests: the load versus-speed combinations of the hoist should be demonstrated on the ground (either using an accurate engineering mock-up or a rotorcraft) by showing repeatability of the no load-speed combination, the 50 per cent load-speed combination, the 75 per cent load-speed combination, and the 100 per cent (i.e. system rated limit) load-speed combination. If more than one operational speed range exists, the preceding tests should be performed at the most critical speed.
 - (A) At least 1/10 of the hoist demonstration cycles (see definition) should include the maximum aft angular displacement of the load from the vertical, applied for under CS 27.865(a).
 - (B) A minimum of six consecutive, complete operation cycles should be conducted at the system's 100 per cent (i.e. system limit rated) load-speed combination.
 - (C) In addition, the demonstration should cover all normal and emergency modes of intended operation and should include operation of all control devices such as limit switches, braking devices, and overload sensors in the system.

CS-27 BOOK 2

- (D) All quick disconnect devices and cable cutters should be demonstrated at 0 per cent, 25 per cent, 50 per cent, 75 per cent, and 100 per cent of system limit load or at the most critical percentage of limit load.
- Note: some hoist designs have built-in cable tensioning devices that function at the no load-speed combination, as well as at other load-speed combinations. This device should work during the no load-speed and other load-speed cable-cutting combinations.
- (E) Any devices or methods used to increase the mechanical advantage of the hoist should also be demonstrated.
- (F) During a portion of each demonstration cycle, the hoist should be operated from each station from which it can be controlled.
- (ii) Hoist and rescue hook systems or cargo hook systems flight test: an in-flight demonstration test of the hoist system should be conducted for helicopters designed to carry NHEC or HEC. The rotorcraft should be flown to the extremes of the applicable manoeuvre flight envelope and to all conditions that are critical to strength, manoeuvrability, stability, and control, or any other factor affecting airworthiness. Unless a lesser load is determined to be more critical for either dynamic stability or other reasons, the maximum hoist system rated load or, if less, the maximum load requested for approval (and the associated limit load data placards) should be used for these tests. The minimum hoist system load (or zero load) should also be demonstrated in these tests.
- (iii) CS 27.865(d) Flight test Verification Work: flight test verification work that thoroughly examines the operational envelope should be conducted with the external cargo carriage device for which approval is requested (especially those that involve HEC). The flight test programme should show that all aspects of the operations applied for are safe, uncomplicated, and can be conducted by a qualified flight crew under the most critical service environment, and, in the case of HEC, under emergency conditions. Flight tests should be conducted for the simulated representative NHEC and HEC loads to demonstrate their in-flight handling and separation characteristics. Each placard, marking, and flight manual supplement should be validated during flight testing.
- (A) General: flight testing or an equivalent combination of analysis, ground tests, and flight tests should be conducted under the critical combinations of configurations and operating conditions for which basic type certification approval is sought. The critical load condition of the intended cargo (e.g. rocks, lumber, radio towers, HEC) may be defined by a heavy weight and low area cargo or a low weight and high area cargo. The effects of these load conditions should be evaluated throughout the operational aspects of cargo loading, take-off, cruise up to maximum allowable speed with cargo, jettison, and landing. The helicopter handling with different cable conditions should include lateral transitions and quick stops up to the helicopter approved low airspeed limitations. Additional combinations of external load and operating conditions may be subsequently approved under relevant operational requirements as long as the structural limits and reliability considerations of the basic certification approval are not exceeded (i.e. equivalent safety is maintained). The qualification flight test of this subparagraph is intended to be accomplished primarily by analysis or bench testing. However, at least one in-flight, limit load drop test should be conducted for the critical load case. If one critical load case cannot be clearly identified, then more than one drop test might be necessary. Also, in-flight tests for the minimum load case (i.e. typically the cable hook itself) with the load trailing both in the minimum and maximum cable length configurations should be conducted. Any safety-of-flight limitations should be documented and placed in the RFM or RFMS. In certain low-gross weight, jettisonable HEC configurations, the complex PCDS may act as a trailing aerofoil that could result in entangling the complex PCDS with the rotorcraft. These configurations should be assessed on a case-by-case

CS-27 BOOK 2

basis by analysis or flight test to ensure that any safety-of-flight limitations are clearly identified and placed in the RFM or RFMS (also see PCDS).

- (B) Separation characteristics of jettisonable external loads: for all jettisonable RLCs of any applicable cargo type, satisfactory post-jettison separation characteristics of all loads should meet the minimum criteria that follow:
 - (1) Separate functioning of the PQRS and BQRS resulting in a complete, immediate release of the external load without interference by the rotorcraft or external load system.
 - (2) No damage to the helicopter during or following actuation of the QRS and load jettisoning.
 - (3) A jettison trajectory that is clear of the helicopter.
 - (4) No inherent instability of the jettisonable (or just jettisoned) HEC or NHEC while in proximity to the helicopter.
 - (5) No adverse or uncontrollable helicopter reactions at the time of jettison.
 - (6) Stability and control characteristics after jettison that are within the originally approved limits.
 - (7) No adverse degradation on helicopter performance characteristics after jettison.
- (C) Jettison requirements for jettisonable external loads: for representative cargo types (low, medium, and high-density loads on long and short lines), emergency and normal jettison procedures should be demonstrated (by a combination of analysis, ground tests, and flight tests) in sufficient combinations of flight conditions to establish a jettison envelope that should be placed in the flight manual.
- (D) QRS demonstration; repetitive jettison demonstrations that use the PQRS, which may be accomplished during ground or flight tests, should be conducted. The BQRS should be utilised at least once.
- (E) QRS reliability (i.e. failure modes) affecting flight performance: the FHA of the QRS (see paragraph c.(2) above) should show that any single system failure will not result in unsatisfactory flight characteristics, including any QRS failures resulting in asymmetric loading conditions.
- (F) Flight test weight and CG locations: all flight tests should be conducted at the extreme or critical combinations of weight and longitudinal and lateral CG conditions within the applied-for flight envelope. Typically the two load conditions would be a heavy weight and low area cargo, and a low weight and high area cargo. The rotorcraft should remain within approved weight and CG limits, both with the external load applied, and after jettison of the load.
- (G) Jettison Envelopes: emergency and normal jettison demonstrations should be performed at sufficient airspeeds and descent rates to establish any restrictions for satisfactory separation characteristics. Both the maximum and minimum airspeed limits and the maximum descent rate for safe separation should be determined. The sideslip envelope as a function of airspeed should be determined.
- (H) Altitude: emergency and normal jettison demonstrations should be performed at altitudes that are consistent with the approvable operational envelope and with the manoeuvres necessary to overcome any adverse effects of the jettison.
- (I) Attitude: emergency and normal jettison demonstrations should be performed from all attitudes that are appropriate to normal and emergency operational usage. Where the attitudes of HEC or NHEC with respect to the

CS-27 BOOK 2

helicopter may be varied, the most critical attitude should be demonstrated. This demonstration would normally be accomplished by bench testing.

- (4) Rotorcraft Flight Manual (RFM) and Rotorcraft Flight Manual Supplement (RFMS):
- (i) General.
- (A) Present appropriate flight manual procedures and limitations for all HEC operations.
- (1) The approval of an external loads equipment design in accordance with CS 27.865 does not provide an approval to conduct external loads operations. Therefore, the following should be included as a limitation in the RFM or RFMS:
- *The external load equipment certification approval does not constitute an operational approval; an operational approval for external load operations must be granted by the competent authority.*
- (2) The RFM or RFMS that will be approved through the certification activity should not contain any references to the previously used RLC classes.
- (B) For non-HEC designs, the following limitation should be included within the RFM or RFMS:
- *The external load system does not comply with the CS-27 certification provisions for Human External Cargo (HEC).*
- (C) The RFM or RFMS may contain suitable text to clarify whether the external load system meets the applicable certification provisions for lifting an external load free of land or water, and whether the load is jettisonable.
- (D) The RFM or RFMS should contain emergency procedures detailing the steps to be taken by the flight crew during emergencies such as an engine failure, hoist failure, flight director or autopilot failure, etc.
- (E) The RFM or RFMS normal procedures should explain the required procedures to conduct a safe external load operation. Such information may include the methods for attachment and normal release of the external load.
- (ii) HEC installations.
- (A) For HEC installations, the following additional information/limitation should be included in the RFM or RFMS:
- (1) That the external load system meets the CS-27 certification specifications for Human External Cargo (HEC).
- (2) Operation of the external load equipment with HEC requires the use of an approved Personnel Carrying Device Systems (PCDS).
- NOTE: for a simple PCDS, also refer to AMC No. 3 to 27.865
- (B) Crew member communications.
- (1) The flight manual should clearly define the method of communication between the flight crew and the HEC. These instructions and manuals should be validated during flight testing.
- (2) If the external load system does not include equipment to allow direct intercommunication among required crew members and external occupants, the following limitation may be included within the limitations section of the RFM or RFMS:

CS-27 BOOK 2

- *This external load system does not include equipment to allow direct intercommunication among required crew members and external occupants. Operating this external load equipment with HEC is not authorised unless appropriate equipment to allow direct intercommunication between required crew members and external occupants has an airworthiness approval.*
- (iii) Additional RFM or RFMS requirements are contained within each applicable paragraph of this AMC.
- (5) Continued airworthiness.
- (i) Instructions for Continued Airworthiness: maintenance manuals (and RFM supplements) developed by applicants for external load applications should be presented for approval and should include all appropriate inspection and maintenance procedures. The applicant should provide sufficient data and other information to establish the frequency, extent, and methods of inspection of critical structure, systems, and components. CS 27.1529 and Appendix A to CS-27 requires this information to be included in the maintenance manual. For example, maintenance requirements for sensitive QRS squibs should be carefully determined, documented, approved during certification, and included as specific mandatory scheduled maintenance requirements that may require either 'daily' or 'pre-flight' checks (especially for HEC applications).
- (ii) Hoist system continued airworthiness. The design life of the hoist system and any limited life components should be clearly identified, and the Airworthiness Limitations Section of the maintenance manual should include these requirements. For STCs, a maintenance manual supplement should be provided that includes these requirements.

Note: the design life of a hoist and cable system is typically between 5 000 and 8 000 cycles. Some hoist systems have usage time meters installed. Others may have cycle counters installed. Cycle counters should be considered for HEC operations and high-load or other operations that may cause low-cycle fatigue failures.

- (6) CS 27.865(a) Static Structural Substantiation and CS 27.865(f) Fatigue Substantiation Procedures: The following static structural substantiation methods and fatigue substantiation should be used:
- (i) Critical Basic Load Determination. The critical basic loads and corresponding flight envelope are determined by statically substantiating the gross weight range limits, the corresponding vertical limit load factors (N_{ZW}) and the safety factors applicable for the type of external load for which the application is being made.
- NOTE: in cases where NHEC or HEC can have more than one shape, centre of gravity, centre of lift, or be carried at more than one distance in-flight from the rotorcraft attachment, a critical configuration for certification purposes may not be determinable. If such a critical configuration can be determined, it may be examined for approval as a 'worst case' to satisfy a particular certification criterion or several criteria, as appropriate. If such a critical configuration cannot be determined, the extreme points of the operational external load configuration envelope should be examined, with consideration given to any other points within the envelope that experience or any other rationale indicates as points that need to be investigated.
- (ii) Vertical Limit and Ultimate Load Factors. The basic N_{ZW} is converted to the ultimate load by multiplying the maximum vertical limit load by the appropriate safety factor (for restricted category approvals, see the guidance in paragraph AC 27 MG 5 of FAA AC 27-1B Change 7). This ultimate load is used to substantiate all the existing structure affected by,

CS-27 BOOK 2

and all the added structure associated with, the load-carrying device, its attachments and its cargo. Casting factors, fitting factors, and other dynamic load factors should be applied where appropriate.

- (A) NHEC applications. In most cases, it is acceptable to perform a standard static analysis to show compliance. A vertical limit load factor (N_{zw}) of 2.5 g is typical for heavy gross weight NHEC hauling configurations (ref.: CS 27.337). This vertical load factor should be applied to the maximum external load for which the application is being made, together with a minimum safety factor of 1.5.
- (B) HEC applications.
 - (1) If a safety factor of 3.0 or more is used, it is acceptable to perform a standard static analysis to show compliance. The safety factor should be applied to the yield strength of the weakest component in the system (QRS, complex PCDS, and attachment load path). If a safety factor of less than 3.0 is used, both an analysis and a full-scale ultimate load test of the relevant parts of the system should be performed.
 - (2) Since HEC applications typically involve lower gross weight configurations, a higher vertical limit load factor is required to assure that the limit load is not exceeded in service. The applicant should use either the conservative value of 3.5 g or an analytically derived maximum vertical limit load factor for the requested operating envelope. Linear interpolation between the vertical load factors of the maximum and minimum design weights may be used. However, in no case may the vertical limit load factor be less than 2.5 g for any HEC application.
 - (3) For the purpose of structural analysis or test, applicants should assume a 101.2-kg (223-pound) man as the minimum weight of each occupant carried as HEC.

NOTE: if the HEC is engaged in work tasks that employ devices of significant added weight (e.g. heavy backpacks, tools, fire extinguishers, etc.), the total weight of the 101.2-kg (223-pound) man and their equipment should be assumed in the structural analysis or test.

- (iii) Critical Structural Case. For applications involving more than one RLC class or cargo type, the structural substantiation is required only for the most critical case. The most critical case should be determined by rational analysis.
- (iv) Jettisonable Loads. For the substantiating analyses or tests of all jettisonable external loads, including HEC, the maximum external load should be applied at the maximum angle that can be achieved in service, but not less than 30 degrees. The angle should be measured from the sling-load-line to the rotorcraft vertical axis (z axis) and may be in any direction that can be achieved in service. The 30-degree angle may be reduced in some or all directions if it is impossible to obtain due to physical constraints or operating limitations. The maximum allowable cable angle should be determined and approved. The angle approved should be based on structural requirements, mechanical interference limits, and flight-handling characteristics over the most critical conditions and combinations of conditions in the approved flight envelope.
- (v) Hoist System Limit Load.

NOTE: if a hoist cable or a long-line cable is utilised, a new dynamic system is established. The characteristics of the system should be evaluated to assure that either no hazardous failure modes exist or that they are acceptably minimised. For example, the hoist cable or long-line cable may exhibit a natural frequency that could be excited by sources internal to the

CS-27 BOOK 2

overall structural system (i.e. the rotorcraft) or by sources external to the system. Another example is the loading effect of the cable acting as a spring between the rotorcraft and the suspended external load.

- (A) Determine the basic loads that would result in the failure or unspooling of the hoist or its installation, respectively.

NOTE: This determination should be based on static strength and any significant dynamic load magnification factors.

- (B) Select the lower of the two values as the ultimate load of the hoist system installation.
- (C) Divide the selected ultimate load by 1.5 to determine the true structural limit load of the system.
- (D) Determine the manufacturer's approved 'limit design safety factor' (or that which the applicant has applied for). Divide this factor into the true structural limit load (from (C) above) to determine the hoist system's working (or placarded) limit load.
- (E) Compare the system's derived limit load to that applied for one 'g' payload multiplied by the maximum downward vertical load factor ($N_{Z_{WMAX}}$) to determine the critical payload's limit value.
- (F) The critical payload limit should be equal to or less than the system's derived limit load for the installation to be approvable.

(vi) Fatigue Substantiation Procedures

NOTE: the term 'hazard to the rotorcraft' is defined to include all hazards to either the rotorcraft, to the occupants thereof, or both.

- (A) Fatigue evaluation of NHEC applications. Any critical components of the suspended system and their attachments (e.g. the cargo hook, or bolted or pinned truss attachments), the failure of which could result in a hazard to the rotorcraft, should be included in an acceptable fatigue analysis.
- (B) Fatigue evaluation of HEC applications. The entire external load system, including the complex PCDS, should be reviewed on a component-by-component basis to determine which, if any, components are fatigue critical. These components should be analysed or tested to ensure that their fatigue life limits are properly determined, and the limits should then be placed in the limited life section of the maintenance manual.

- (7) CS 27.865(b) and CS 27.865(c) Procedures for Quick-Release Systems and Cargo Hooks: for jettisonable RLCs of any applicable cargo type, both a primary quick-release system (PQRS) and a backup quick-release system (BQRS) are required. Features that should be considered are:

- (i) The PQRS, BQRS and their load-release devices and subsystems (such as electronically actuated guillotines) should be separate (i.e. physically, systematically, and functionally redundant).
- (ii) The controls for the PQRS should be installed on one of the pilot's primary controls, or in an equivalently accessible location. The use of an 'equivalent accessible location' should be reviewed on a case-by-case basis and utilised only where equivalent safety is clearly maintained.
- (iii) The controls for the BQRS may be less sophisticated than those of the PQRS. For instance, manual cable cutters are acceptable provided they are listed in the flight manual as a required device and have a dedicated, placarded storage location.
- (iv) The PQRS should release the external load in less than 5 seconds. The BQRS should release the external load in less than 30 seconds. This time

CS-27 BOOK 2

interval begins the moment an emergency is declared and ends when the load is released.

- (v) Each quick-release device should be designed and located to allow the pilot or a crew member to accomplish the release of the external cargo release without hazardously limiting the ability to control the rotorcraft during emergency situations. The flight manual should reflect the requirement for a crew member and their related functions.
- (vi) CS 27.865(c)(1) QRS Requirements for Jettisonable HEC Operations.
 - (A) For jettisonable HEC operations, both the PQRS and BQRS are required to have a dual actuation device (DAD) for external cargo release. The DAD should be designed to require two actions with a definite change of direction of movement, such as opening a switch or pushbutton cover followed by a definite change of direction in order to activate the release switch or pushbutton. Any possibility of opening the switch cover and inadvertently releasing the load with a single motion is not acceptable. An additional level of safety may also be provided through the use of Advisory and Caution messages. For example, an advisory 'ON' message might be illuminated when the pilot energises (but not arms) the system with a master switch. A cautionary 'ARMED' message would then illuminate when the pilot opens the switch guard. In this case, a possible unwanted flip of the switch guard would be immediately recognised by the crew. The switch design should be evaluated by ground or flight test. The RFM or RFMS should contain a clear description of the DAD functionality that includes the associated safety features, normal and emergency procedures, and applicable advisory and caution messages.
 - (B) The DAD is intended for emergency use during the phases of flight in which the HEC is carried or retrieved. The DAD can be used for both NHEC and HEC operations. However, because it can be used for HEC, the instructions for continued airworthiness should be carefully reviewed and documented. The DAD can be operated by the pilot from a primary control, or, after a command is given by the pilot, by a crew member from a remote location. Additional safety precautions (such as a lock wire) should be considered for a remote hoist console in the cabin. Any emergency release function provided by a remote hoist console should also be designed to protect against inadvertent activation during the hoist operation. If the backup DAD is a cable cutter, it should be properly secured, placarded and readily accessible to the crew member who is intended to use it.
- (vii) CS 27.865(b)(3)(ii) Electromagnetic Interference. Protection of the QRS against potential internal and external sources of EMI and lightning is required. This is necessary to prevent an inadvertent load release from sources such as lightning strikes, stray electromagnetic signals, and static electricity.
 - (A) Jettisonable NHEC systems should not be adversely affected when exposed to the electrical field of a minimum of 20 volts per metre (i.e. CAT U or equivalent) radio-frequency (RF) field strength per RTCA Document DO-160/ EUROCAE ED-14.
 - (B) Jettisonable HEC systems should not be adversely affected when exposed to the electrical field of a minimum of 200 volts per metre (i.e. CAT Y) RF field strength per RTCA Document DO-160/ EUROCAE ED-14.
 - (1) These RF field threat levels may need to be increased for certain special applications such as microwave tower and high voltage high line repairs. Separate criteria for special applications under multi-agency regulation (such as IEEE or

CS-27 BOOK 2

OSHA standards) should also be addressed, as applicable, during certification. When necessary, the Special Condition process can be used to establish a practicable level of safety for specific high voltage or other special application conditions. The helicopter High-intensity Radiated Fields (HIRF) safety assessment should consider the effects on helicopter flight safety due to a HIRF-induced failure or a malfunction of external load systems, such as an uncommanded hoist winch activation without the ability to jettison, or an uncommanded load jettison. The appropriate failure effect classification should be assigned based on this assessment, and compliance should be demonstrated with CS 27.1317 and the guidance in AMC 20-158. This should not be limited to the cable cutter devices or load jettison subsystems only. In some designs, an uncommanded load release or a hoist winch activation could also result from a failure of the command and control circuits of the system.

- (2) An approved standard rotorcraft test, which includes the full HIRF frequency and amplitude external and internal environments, on the QRS and any applicable complex PCDS, or the entire rotorcraft including the QRS and any applicable complex PCDS, could be substituted for the jettisonable NHEC and HEC systems tests as long as the RF field strengths directly on the QRS and PCDS are shown to equal or exceed those defined by paragraphs c.(7)(vii)(A) and c.(7)(vii)(B) above for NHEC and HEC respectively.
- (3) The EMI levels specified in paragraphs c.(7)(vii)(A) and c.(7)(vii)(B) above are total EMI levels to be applied to the QRS (and affected QRS component) boundary. The total EMI level applied should include the effects of both external EMI sources and internal EMI sources. All aspects of internally generated EMI should be carefully considered, including peaks that could occur from time-to-time due to any combination of on-board systems being operated. For example, special attention should be given to EMI from hoist operations that involve the switching of very high currents. Those currents can generate significant voltages in closely spaced wiring that, if allowed to reach some squib designs, could activate the device. Shielding, bonding, and grounding of wiring associated with operation of the hoist and the quick-release mechanism should be clearly and adequately evaluated in design and certification. When recognised good practices for such installation are applied, an analysis may be sufficient to highlight that the maximum possible pulse generated into the squib circuit will have an energy content orders of magnitude below the squib no-fire energy. If insufficient data is available for the installation and/or the squib no-fire energy, this evaluation may require testing. One acceptable test method to demonstrate the adequacy of QRS shielding, bonding, and grounding would be to actuate the hoist under maximum load, together with likely critical combinations of other aircraft electrical loads, and demonstrate that the test squibs (which are more EMI sensitive than the squibs specified for use in the QRS) do not inadvertently operate during the test.
- (8) Cargo Hooks or Equivalent Devices and their Related Systems. All cargo hooks or equivalent devices should be approved to acceptable aircraft industry standards. The applicant should present these standards, and any related manufacturer's certificates of production or qualification, as part of the approval package.

CS-27 BOOK 2

- (i) General. Cargo hook systems should have the same reliability goals and should be functionally demonstrated under the critical loads for NHEC and HEC, as appropriate. All engagement and release modes should be demonstrated. If the hook is used as a quick-release device, then the release of critical loads should be demonstrated under conditions that simulate the maximum allowable bank angles and speeds and any other critical operating conditions. Demonstration of any re-latching features and any safety or warning devices should also be conducted. Demonstration of actual in-flight emergency quick-release capability may not be necessary if the quick-release capability can be acceptably simulated by other means.

NOTE: Cargo hook manufacturers specify particular shapes, sizes, and cross sections for lifting eyes to assure compatibility with their hook design (e.g. Breeze Eastern Service Bulletin CAB-100-41). Experience has shown that, under certain conditions, a load may inadvertently hang up because of improper geometry at the hook-to-eye interface that will not allow the eye to slide off an open hook as intended.

For both NHEC and HEC designs, the phenomenon of hook dynamic roll-out (inadvertent opening of the hook latch and subsequent release of the load) should be considered to assure that QRS reliability goals are not compromised. This is of particular concern for HEC applications. Hook dynamic roll-out occurs during certain ground-handling and flight conditions that may allow the lifting eye to work its way out of the hook.

Hook dynamic roll-out typically occurs when either the RLC's sling or harness is not properly attached to the hook, is blown by down draft, is dragged along the ground or through water, or is otherwise placed into a dangerous hook-to-eye configuration.

The potential for hook dynamic roll-out can be minimised in design by specifying particular hook-and-eye shape and cross-section combinations. For non-jettisonable RLCs, a pin can be used to lock the hook-keeper in place during operations.

Some cargo hook systems may employ two or more cargo hooks for safety. These systems are approvable. However, a loss of any load by a single hook should be shown to not result in a loss of control of the rotorcraft. In a dual hook system, if the hook itself is the quick-release device (i.e. if a single release point does not exist in the load path between the rotorcraft and the dual hooks), the pilot should have a dual PQRS that includes selectable, co-located individual quick releases that are independent for each hook used. A BQRS should also be present for each hook. For cargo hook systems with more than two hooks, either a single release point should be present in the load path between the rotorcraft and the multiple hook system, or multiple PQRSs and BQRSs should be present.

- (ii) Jettisonable Cargo Hook Systems. For jettisonable applications, each cargo hook:
- (A) should have a sufficient amount of slack in the control cable to permit cargo hook movement without tripping the hook release;
 - (B) should be shown to be reliable (see paragraph c(1));
 - (C) for HEC systems, unless the cargo hook is to be the primary quick-release device, each cargo hook should be designed so that operationally induced loads cannot inadvertently release the load. For example, a simple cargo hook should have a one-way, spring-loaded gate (i.e. 'snap hook') that allows load attachment going into the gate but does not allow the gate to open (and subsequently lose the HEC) when an operationally induced load is applied in the opposite direction. For HEC applications, cargo hooks that also serve as quick-release devices should be carefully reviewed to assure they are reliable.

CS-27 BOOK 2

- (iii) Other Load Release Types. In some current configurations, such as those used for high-line operations, a load release may be present that is not on the rotorcraft but is on the PCDS itself. Examples are a tension-release device that lets out line under an operationally induced load, or a personal rope cutter. For long-line/sling operations, a load release may also be present that is not on the rotorcraft but is a remote release system. The long-line remote release allows the pilot to not release the line itself during repetitive loading operations. The release of the load by a dedicated switch at the pilot controls, through the secondary hook on a long line, presents additional risks due to the possibility of the long line impacting the tail or the main rotor after a release, due to its elasticity. These devices are acceptable if:
- (A) The off-rotorcraft release is considered to be a 'third release' means. This type of release is not a substitute for a required release (i.e. PQRS or BQRS);
 - (B) The cargo hook release and the long line remote release are placed on the primary controls in a way that avoids confusion during operation. One example of compliance would be to place the cargo hook release on the cyclic, and the long line remote release on the collective, to avoid any possible confusion in the operation;
 - (C) The RFM or RFMS includes a description of the new control in the cockpit, and its function and an RFM or RFMS note to the pilot is included, indicating that the helicopter hook emergency release procedures are fully applicable;
 - (D) The release meets all the other relevant requirements of CS 27.865 and the methods of this AMC or equivalent methods; and
 - (E) The release has no operational or failure modes that would affect continued safe flight and landing under any operations, critical failure modes, conditions, or combinations of these.

For long-line remote release, the following points should be considered:

- (1) The long line should not be of an elastic material that allows spring up/rebound when unloaded, or elevated dynamics when loaded.
- (2) The long line should have a residual weight that allows its release from the helicopter hook when the long line is unloaded.
- (3) The RFM or RFMS should include all operating procedures to ensure that the long line does not impact the rotors after cargo release or during unloaded flight phases.
- (4) The hook should be designed to minimise inadvertent activation. An example may be a protective device (cage) around the locking mechanism of the long line hook.
- (5) A means should be provided to prevent any fouling of cables in the event of a rotation of the external load. An example may be the inclusion of a swivel or slip ring.
- (6) Installation of a long line that is provided with electrical wiring to control the hook will generally represent a new electromagnetic coupling path from the external area to the internal systems that may not have been considered for type certification. As such, the impact of this installation on the coupling to helicopter systems, due to direct connection or cross talk to wiring, should be addressed as part of compliance with CS 27.610, 27.1316 and 27.1317.

CS-27 BOOK 2

- (9) Cable
- (i) Cable attachment. Either the cable should be positively attached to the hoist drum and this attachment should have ultimate load capability, or an equivalent means should be provided to minimise the possibility of inadvertent, complete cable unspooling.
 - (ii) Cable length and marking. A length of cable closest to the cable's attachment to the hoist drum should be visually marked to indicate to the operator that the cable is near full extension. The length of the cable to be marked is a function of the maximum extension speed of the system and the operator's reaction time needed to prevent cable run out. It should be determined during certification demonstration tests. In no case should the length be less than 3.5 drum circumferences.
 - (iii) Cable stops. Means should be present to automatically stop cable movement quickly when the system's extension and retraction operational limits are reached.
- (10) CS 27.865(c)(2) PCDS: for all HEC applications that use complex PCDSs, an approval is required. The complex PCDS may be either previously approved or is required to be approved during certification. In either case, its installation should be approved.

NOTE: Complex PCDS designs can include relatively complex devices such as multiple occupant cages or gondolas. The purpose of the complex PCDS is to provide a minimum acceptable level of safety for personnel being transported outside the rotorcraft. The personnel being transported may be healthy or injured, conscious or unconscious.

- (i) Regulation (EU) No 965/2012 on Air Operations contains the minimum performance specifications and standards for simple PCDSs, such as HEC body harnesses.
- (ii) Static Strength. The complex PCDS should be substantiated for the allowable ultimate load and loading conditions as determined under paragraph c(6) above.
- (iii) Fatigue. The complex PCDSs should be substantiated for fatigue as determined under paragraph c(6) above.
- (iv) Personnel Safety. For each complex PCDS design, the applicant should submit a design evaluation that assures the necessary level of personnel safety is provided. As a minimum, the following should be evaluated:
 - (A) The complex PCDS should be easily and readily entered or exited.
 - (B) It should be placarded with its proper capacity, the internal arrangement and location of occupants, and ingress and egress instructions.
 - (C) For door latch fail-safety, more than one fastener or closure device should be used. The latch device design should provide direct visual inspectability to assure it is fastened and secured.
 - (D) Any fabric used should be durable and should be at least flame-resistant.
 - (E) Reserved
 - (F) Occupant retention devices and the related design safety features should be used as necessary. In simple designs, rounded corners and edges with adequate strapping (or other means of HEC retention relative to the complex PCDS) and head supports or pads may be all the safety features that are necessary. Complex PCDS designs may require safety features such as seat belts, handholds, shoulder harnesses, placards, or other personnel safety standards.

CS-27 BOOK 2

- (v) EMI and Lightning Protection. All essential, affected components of the complex PCDS, such as intercommunication equipment, should be protected against RF field strengths to a minimum of RTCA Document DO-160/EUROCAE ED-14 CAT Y.
- (vi) Instructions for Continued Airworthiness. All instructions and documents necessary for continued airworthiness, normal operations and emergency operations should be completed, reviewed and approved during the certification process. There should be clear instructions to describe when the complex PCDS is no longer serviceable and should be replaced in part or as a whole due to wear, impact damage, fraying of fibres, or other forms of degradation. In addition, any life limitations resulting from compliance with paragraphs c (10)(ii) and (iii) should be provided.
- (vii) Flotation Devices. Complex PCDSs that are intended to have a dual role as flotation devices or life preservers should meet the relevant requirements for 'Life Preservers'. Also, any PCDS design to be used in the water should have a flotation kit. The flotation kit should support the weight of the maximum number of occupants and the complex PCDS in the water and minimise the possibility of the occupants floating face down.
- (viii) Considerations for flight testing. It should be shown by flight tests that the device is safely controllable and manoeuvrable during all requested flight regimes without requiring exceptional piloting skill. The flight tests should entail the complex PCDS weighted to the most critical weight. Some complex PCDS designs may spin, twist or otherwise respond unacceptably in flight. Each of these designs should be structurally restrained with a device such as a spider, a harness, or an equivalent device to minimise undesirable flight dynamics.
- (ix) Medical Design Considerations. Complex PCDSs should be designed to the maximum practicable extent and placarded to maximise the HEC's protection from medical considerations such as blocked air passages induced by improper body configurations and excessive losses of body heat during operations. Injured or water-soaked persons may be exposed to high body heat losses from sources such as rotor washes and the airstreams. The safety of occupants of complex PCDSs from transit-induced medical considerations can be greatly increased by proper design.
- (x) Hoist operator safety device. When hoisting operations require the presence of a hoist operator on board, appropriate provisions should be provided to allow the hoist operator to perform their task safely. These provisions shall include an appropriate hoist operator restraint system. This safety device is typically composed of a safety harness and a strap attached to the cabin, used to adequately restrain the hoist operator inside the cabin while operating the hoist. For certification approval, the hoist operator safety device should comply with CS 27.561(b)(3) for personnel safety. The applicant should submit a design evaluation that assures the necessary level of personnel safety is provided. As a minimum, the following should be evaluated:
 - (A) The strap attaching point on the body harness should be appropriately located in order to minimise, as far as is practicable, the likelihood of injury to the wearer in the case of a fall or crash.
 - (B) The safety device should be designed to be adjustable so that the strap is tightened behind the hoist operator.
 - (C) The strap should allow the hoist operator to detach themselves quickly from the cabin in emergency conditions (e.g. crash, ditching). For that purpose, it should include a QRS including a DAD.
 - (D) The safety device should be easily and readily donned or doffed.
 - (E) It should be placarded with its proper capacity and lifetime limitation.

CS-27 BOOK 2

- (F) Any fabric used should be durable and should be at least flame resistant.
- (11) CS 27.865(c)(4) Intercom Systems for HEC Operations: for all HEC operations, the rotorcraft is required to be equipped for, or otherwise allow, direct intercommunication under any operational conditions among crew members and the HEC. An intercommunications system may also be approved as part of the external load system, or alternatively, a limitation may be placed in the RFM or RFMS as described under paragraph c.(4)(ii)(B)(2) of this AMC.
- (12) CS 27.865(e) External Loads Placards and Markings: placards and markings should be installed next to the external-load attaching means, in a clearly noticeable location, that state the primary operational limitations — specifically including the maximum authorised external load. Not all operational limitations need be stated on the placard (or equivalent markings); only those that are clearly necessary for immediate reference in operations. Other more detailed operational limitations of lesser immediate importance should be stated either directly in the RFM or in an RFM supplement.
- (13) Other Considerations
- (i) Agricultural Installations (AIs): AIs can be approved for either jettisonable or non-jettisonable NHEC or HEC operations as long as they meet relevant certification and operations requirements and follow appropriate compliance methods. However, most current AI designs are external fixtures (see definition), not external loads. External fixtures are not approvable as jettisonable external cargo because they do not have a true payload (see definition), true jettison capability (see definition), or a complete QRS. Many AI designs can dump their solid or liquid chemical loads by use of a 'purge port' release over a relatively long time period (i.e. greater than 30 seconds). This is not considered to be a true jettison capability (see definition) since the external load is not released by a QRS and since the release time span is typically greater than 30 seconds (ref.: b(20) and c(7)). Thus, these types of AIs should be approved as non-jettisonable external loads. However, other designs that have the entire AI (or significant portions thereof) attached to the rotorcraft, that have short time frame jettison (or release) capabilities provided by QRSs that meet the definitions herein and that have no post-jettison characteristics that would endanger continued safe flight and landing may be approved as jettisonable external loads. For example, if all the relevant criteria are properly met, a jettisonable fluid load can be approved as an NHEC external cargo. FAA AC 27-1B Change 7 AC 27 MG 5 discusses other AI certification methodologies.
- (ii) External Tanks: external tank configurations that have true payload (see definition) and true jettison capabilities (see definition) should be approved as jettisonable NHEC. External tank configurations that have true payload capabilities but do not have true jettison capabilities should be approved as non-jettisonable NHEC. An external tank that has neither a true payload capability nor true jettison capability is an external fixture; it should not be approved as an external load under CS 27.865. If an external tank is to be jettisoned in flight, it should have a QRS that is approved for the maximum jettisonable external tank payload and is either inoperable or is otherwise rendered reliable to minimise inadvertent jettisons above the maximum jettisonable external tank payload.
- (iii) Logging Operations: These operations are very susceptible to low-cycle fatigue because of the large loads and relatively high load cycles that are common to this industry. It is recommended that load-measuring devices (such as load cells) be used to assure that no unrecorded overloads occur and to assure that cycles producing high fatigue damage are properly considered. Cycle counters are recommended to assure that acceptable cumulative fatigue damage levels are identifiable and are not exceeded. As either a supplementary method or an alternate method, maintenance

CS-27 BOOK 2

instructions should be considered to assure proper cycle counting and load recording during operations.

[Amdt No: 27/6]

AMC No 3 to 27.865 EXTERNAL LOADS OPERATIONS USING SIMPLE PERSONNEL-CARRYING DEVICE SYSTEMS

If required by the applicable operating rule or if an applicant elects to, this AMC provides a means of compliance for the airworthiness certification of a simple personnel-carrying device system (PCDS) and attaching means to the hook, providing safety factors and consideration of calendar life replacement limits in lieu of a dedicated fatigue analysis and test.

A PCDS is considered to be simple if:

- (a) it meets an EN standard under Directive 89/686/EEC, or Regulation (EU) 2016/425, as applicable, or subsequent revision;
- (b) it is designed to restrain no more than a single person (e.g. hoist or cargo hook operator, photographer, etc.) inside the cabin, or to restrain no more than two persons outside the cabin;
- (c) it is not a rigid structure such as a cage, a platform or a basket.

PCDSs that cannot be considered to be simple are considered to be complex.

Note 1: EASA or the relevant Authority should be contacted to confirm the classification in the event that:

- a PCDS includes new or novel features;
- a PCDS has not been proven by appreciable and satisfactory service experience; or
- there is any doubt in the classification.

Approval of Simple PCDSs

If the approval of a simple PCDS is requested, then Directive 89/686/EEC, or Regulation (EU) 2016/425 or subsequent revision are an acceptable basis for the certification of a simple PCDS provided that:

- (a) the applicable Directive 89/686/EEC, or Regulation (EU) 2016/425, as applicable, or subsequent revision and corresponding EN standards for the respective components are complied with (EC Type Examination Certificate);
- (b) the applicant for the minor change has obtained from the manufacturer and keeps on record the applicable EC Conformity Certificate(s).

Note 2: A simple PCDS has an EC Type Examination Certificate (similar to an STC), issued by a Notified Certification Body and, for the production and marketing, an EC Conformity Certificate (similar to an EASA Form 1) issued by the manufacturer.

Note 3: In cases where ropes or elements connect simple PCDSs to the hoist/cargo hook or internal helicopter cabin, the EN certification can be achieved by a body meeting the transposition into national law of the applicable EC/EU regulation.

The EC-certified components are appropriately qualified for the intended use and the environmental conditions.

Note 4: The intended use and corresponding risks must be considered when selecting EN standards. For example hoist operators and rescuers that have to work at the edge of the cabin or outside should have full body harnesses to address the risk of inversion. Litters and the corresponding restraint systems should be adequately designed for the loads that can be generated during spinning.

Note 5: The assembly of the different components should also consider the intended use. For example, the attachment of the tethering strap to the harness of a hoist operator should be of a DAD quick-release type to allow quick detachment from the aircraft following a ditching or

CS-27 BOOK 2

emergency landing. The tethering strap should also be adjustable to take up slack and avoid shock loads being transmitted to other components.

- (c) The maximum load applied to each component between the HEC and the hook is conservatively estimated. This is particularly important when more than one person is attached by a single system to the cargo hook/ hoist. Appendix 1 defines the appropriate minimum ultimate load (UL_{min}). If UL_{min} is above the static strength currently declared by the supplier of the PCDS or of a component of the attachments, through compliance with an EN standard, then proof of sufficient strength is to be provided by static tests. All possible service load cases (including asymmetric load distribution) are to be considered. In this case, the PCDS and/or the attaching means (e.g. rope, carabineer, shackles, etc.) must be capable of supporting UL_{min} for a minimum of 3 minutes without failure. There should be no deformation of components that could allow the release of the HEC. Components and details added to the EN-approved equipment (such as splicing, knots, stitching, seams, press fits, etc.) or the materials used (textiles, composites, etc.) that might reduce the strength of a product or could (in combination) have other detrimental effects have been investigated by the applicant and accounted for in the substantiation.
- (d) The effects of ageing (due to sunlight, temperature, water immersion, etc.) and other operational factors that may affect the strength of the PCDS are accounted for through appropriate inspections and the application of a calendar life limit as appropriate. The PCDS and the related attachment elements are limited to the carriage of HEC.
- (e) The risk of fatigue failure is minimised. See section below for further details.
- (f) Instructions for Continued Airworthiness (ICA) should be provided. Typically, the ICA would comprise an inspection programme and maintenance instructions based on the applicable manufacturer's data. The ICA should ensure that specific operational uses of the system that might affect its strength are accounted for. A calendar life limit should be applied when appropriate.
- (g) When the harness is not designed to transport an incapacitated or untrained person, then the labelling and/or the user/flight manual should include a specific limitation of use as applicable.

Note 6: The following considerations and corresponding instructions/limitations should be taken for EN 1498 Type A and C rescue loops due to their potential detrimental physiological effects and the risk of falling out:

- (a) whether life is in imminent risk;
- (b) the physical condition of the person to be hoisted, particularly whether the rescuee will remain conscious and coherent during the hoist process;
- (c) the potential for the person to remain compliant with the brief given prior to hoisting;
- (d) alternative methods and devices to recover the person; and
- (e) whether the risk of falling from the device would result in further serious injury or death.

Simple PCDS Helicopter Compatibility

The ingress/egress of the simple PCDS in the cabin should be verified on the specific rotorcraft by means of a test. The compatibility with the hoist hook, unless the ring is already specified in the RFM, should also be verified by means of a test.

The verification of the hook and simple PCDS compatibility should also verify the absence of any roll-out/jamming phenomenon in order to:

- (a) prevent any inadvertent release of the load from the cargo hook; and/or
- (b) prevent the ring from jamming on the load beam during the release.

Manufacturing and Identification

Simple PCDSs that comply with Directive 89/686/EEC, or Regulation (EU) 2016/425, as applicable, or subsequent revision and the corresponding EN standards for the respective components are labelled by the manufacturer according to the applicable standard. If not already contained in the manufacturer

CS-27 BOOK 2

labelling, the following additional information, as applicable, should be made visible on labelling on simple PCDSs:

- (a) manufacturing date;
- (b) life-limit date (if different from any existing one marked on the personal protective equipment (PPE));
- (c) manufacturer's identification;
- (d) part number;
- (e) serial number or unique identification of the single PCDS;
- (f) STC/minor change approval number (if applicable);
- (g) authorised load in kg;
- (h) authorised number of persons;
- (i) any other limitation not recorded in the manufacturer labelling.

Simple PCDS Static Strength

The PCDS should be substantiated for the loading conditions determined under the applicable paragraphs of FAA AC 27.865. For a PCDS to be certified separately from the hoist, using the guidance of this certification memo, the minimum ultimate load (UL_{min}) to be substantiated is defined as follows:

$$UL_{min} = M \times n \times j \times jf \times K \times g \text{ (units are Newtons)}$$

Where:

M is the total mass of the PCDS equipment/component and persons restrained by the part being substantiated (this is equivalent to the working load rating of an EN). The mass of each person should be assumed to be 100 kg.

NOTE: If the person(s) or their task requires the personal carriage of heavy items (backpacks, tools, fire extinguishers, etc.), these must be accounted for in the total mass **M**, in addition to the person's mass of 100 kg.

n is the helicopter manoeuvring limit load factor and must be assumed = 3.5 (CS 27.337 and 27.865).

j is the ultimate load factor of safety for all parts = 1.5 (CS 27.303).

K is an additional safety factor for textiles = 2.0 (see NOTE 1) (CS 27.619).

jf is an additional fitting factor = 1.33 applying to all joints, fittings, etc. (CS 27.619).

g is the acceleration due to gravity of 9.81 m/s².

The resulting values to ensure compliance with the CS-27 static strength requirements are:

UL_{min} for metallic elements with a fitting factor (needed for all joints and fittings): = 7 Mg.

(NOTE: To address fatigue, a value of 10 Mg may be required; see the section below on fatigue.)

UL_{min} for textiles (webbing, ropes, etc.) with fitting factor: = 14 Mg (see NOTE 1).

UL_{min} may be compared to the strength of the PCDS components already substantiated according to Directive 89/686/EEC, or Regulation (EU) 2016/425, as applicable, or subsequent revision and the corresponding EN Standards or Directive 2006/42/EC Annex I Point 6. Where UL_{min} is greater than that laid down in the Directives/EN requirements, a static test to not less than UL_{min} will be necessary. The test load must be sustained for 3 minutes. In addition, there should be no detrimental or permanent deformation of the metallic components at 3.5 Mg (CS 27.305).

NOTE 7: Directive 2006/42/EC Annex I Point 6 recommends a safety factor of 14 (2×7) for textiles applied to the working load (equivalent to 14 M above) for equipment lifting humans, whereas for a rescue harness, EN 1497 requires a static test load of not less than the greater of either 15 kN or 10 times the working load. Considering this difference, for each textile component within the PCDS

CS-27 BOOK 2

certified to one of the following ENs, the value of K may be reduced, such that UL_{min} is not less than $10 M \times g$, where M is not more than 150 kg:

For harnesses, EN 361, EN 1497 or EN 12277A, EN 813 or EN 12277C apply; for belts or straps and for lanyards, EN 354 applies. This allowance is not applicable to ropes.

Furthermore, to allow this reduced value of UL_{min} and to address any potential deterioration of textiles due to environmental and other hidden damage, the ICA must include a life limitation of 5 years (or the life indicated by the PCDS manufacturer, if less) and an annual detailed inspection of the general condition of the harness.

Simple PCDS Fatigue

When the simple PCDS and the related attachment elements are limited to the carriage of HEC only, no further specific fatigue substantiation is necessary for each part of the simple PCDS that is either:

- (a) certified in accordance with an applicable EN that is referenced in this AMC for which the allowable working load is not exceeded by the mass M; or
- (b) substantiated for static strength as described above with UL_{min} not less than 10 Mg.

[Amdt No: 27/2]

[Amdt No: 27/5]

[Amdt No: 27/6]

CS-27 BOOK 2**AMC 27.1302 Installed systems and equipment for use by the crew members****1)_INTRODUCTION****1.1_Background**

Demonstrating compliance with the design requirements that relate to human abilities and limitations is subject to interpretation. Findings may vary depending on the novelty, complexity or integration of the system design. EASA considers that describing a structured approach to selecting and developing acceptable means of compliance is useful in supporting the standardisation of compliance demonstration practices.

1.2_Applicability

- (a) This acceptable means of compliance (AMC) provides the means for demonstrating compliance with CS 27.1302 and complements the means of compliance (MoC) for several other paragraphs in CS-27 (refer to paragraph 2, Table 1 of this AMC) that relate to the installed systems and equipment used by the crew members for the operation of a rotorcraft. In particular, this AMC addresses the design and approval of installed systems and equipment intended for use by the crew members from their normal seating positions in the cockpit, or their normal operating positions in the cabin.
- (b) This AMC applies to crew member interfaces and system behaviour for all the installed systems and equipment used by the crew members in the cockpit and the cabin while operating the rotorcraft in normal, abnormal/malfunction and emergency conditions. The functions of the crew members that operate from the cabin need to be considered in case they may interfere with the ones under the responsibility of the cockpit crew, or in case dedicated certification specifications are included in CS-27.
- (c) This AMC does not apply to crew member training, qualification or licensing requirements.
- (d) EASA recognises that when Part 21 requires 27.1302 to be part of the certification basis, the amount of effort the applicant has to make for demonstrating compliance with it may vary and not all the material contained within this AMC should be systematically followed. A proportionate approach is embedded within the AMC and is described in paragraph 3.2.9. The proportionate approach affects the demonstration of compliance and depends on criteria such as the rotorcraft category (A or B), the type of operation (VFR, IFR), and the classification of the change.

CS-27 BOOK 2

1.3_Definitions

For the purposes of this AMC, the following definitions apply:

- **alert:** a cockpit indication that is meant to attract the attention of the crew, and identify to them an operational or aircraft system condition. Warnings, cautions, and advisories are considered alerts.
- **assessment:** the process of finding and interpreting evidence to be used by the applicant in order to establish compliance with a specification. For the purposes of this AMC, the term 'assessment' may refer to both evaluations and tests. Evaluations are intended to be conducted using partially representative test means, whereas tests make use of conformed test articles.
- **automation:** the technique of controlling an apparatus, a process or a system by means of electronic and/or mechanical devices, which replaces the human organism in the sensing, decision-making and deliberate output.
- **cabin:** the area of the aircraft, excluding the cockpit, where the crew members can operate the rotorcraft systems; for the purposes of this AMC, the scope of the cabin is limited to the areas used by the crew members to operate:
 - the systems that share controls and information with the cockpit;
 - the systems which have controls and information with similar direct or indirect consequences other than the one in the cockpit (e.g. precision hovering).
- **catachresis:** applied to the area of tools, 'catachresis' means the use of a tool for a function other than the one planned by the designer of the tool; for instance, the use of a circuit breaker as a switch.
- **clutter:** an excessive number and/or variety of symbols, colours, or other information that may reduce the access to the relevant information, increase interpretation time and the likelihood of interpretation error.
- **cockpit:** the area of the aircraft where the flight crew members work and where the primary flight controls are located.
- **conformity:** official verification that the cockpit/system/product conforms to the type design data.
- **cockpit controls:** the interaction with a control means that the crew manipulates in order to operate, configure, and manage the aircraft or its flight control surfaces, systems, and other equipment.

This may include equipment in the cockpit such as:

- control devices,
- buttons,
- switches,
- knobs,
- flight controls, and
- levers.

CS-27 BOOK 2

- **control device:** a control device is a piece of equipment that allows the crew to interact with the virtual controls, typically used with the graphical user interface; control devices may include the following:
 - keyboards,
 - touchscreens,
 - cursor-control devices (keypads, trackballs, pointing devices),
 - knobs, and
 - voice-activated controls.
- **crew member:** a person that is involved in the operation of the aircraft and its systems; in the case of rotorcraft, the operator in the cabin that can interfere with the cockpit-crew tasks (for instance, the operator in the cabin assigned to operate the rescue hoist or to help the cockpit-crew control the aircraft in a hover is considered a crew member).
- **cursor-control device:** a control device for interacting with the virtual controls, typically used with a graphical user interface on an electro-optical display.
- **design eye reference point (DERP):** a point in the cockpit that provides a finite reference enabling the precise determination of geometric entities that define the layout of the cockpit.
- **design feature:** a design feature is an attribute or a characteristic of a design.
- **design item:** a design item is a system, an equipment, a function, a component or a design feature.
- **design philosophy:** a high-level description of the human-centred design principles that guide the designer and aid in ensuring that a consistent, coherent user interface is presented to the crew.
- **design-related human performance issue:** a deficiency that results from the interaction between the crew and the system. It includes human errors, but also encompasses other kinds of shortcomings such as hesitation, doubt, difficulty in finding information, suboptimal strategies, inappropriate levels of workload, or any other observable item that cannot be considered to be a human error, but still reveals a design-related concern.
- **display:** a device that transmits data or information from the aircraft to the crew.
- **flight crew member:** a licensed crew member charged with duties that are essential for the operation of an aircraft during a flight duty period.
- **human error:** a deviation from what is considered correct in some context, especially in the hindsight of the analysis of accidents, incidents, or other events of interest. Some types of human error may be the following: an inappropriate action, a difference from what is expected in a procedure, an incorrect decision, an incorrect keystroke, or an omission. In the context of this AMC, human error is sometimes referred to as 'crew error' or 'pilot error'.
- **multifunction control:** a control device that can be used for many functions, as opposed to a control device with a single dedicated function.
- **abnormal/malfunction or emergency conditions:** for the purposes of this AMC, abnormal/malfunction or emergency operating conditions refer to conditions that do require the crew to apply procedures different from the normal procedures included in the rotorcraft flight manual (RFM).

CS–27 BOOK 2

- **operationally relevant behaviour:** operationally relevant behaviour is meant to convey the net effect of the system logic, controls, and displayed information of the equipment upon the awareness of the crew or their perception of the operation of the system to the extent necessary for planning actions or operating the system. The intent is to distinguish such system behaviour from the functional logic within the system design, much of which the crew does not know or does not need to know, and which should be transparent to them.
- **system function allocation:** a human factors (HFs) method for deciding whether a particular function will be accomplished by a person, technology (hardware or software) or some mix of a person and technology (also referred to as ‘task allocation’).
- **task analysis:** a formal analytical method used to describe the nature and relationships of complex tasks involving a human operator.

1.4_Abbreviations

The following is a list of abbreviations used in this AMC:

| | |
|-------------|--|
| AC | advisory circular |
| AMC | acceptable means of compliance |
| CAM | cockpit area microphone |
| CRM | crew resource management |
| CVR | cockpit voice recorder |
| CS | certification specification |
| DLR | data link recorder |
| DOT | Department of Transportation |
| EASA | European Union Aviation Safety Agency |
| ED | EUROCAE Document |
| FAA | Federal Aviation Administration |
| FMS | flight management system |
| GM | guidance material |
| HFs | human factors |
| HMI | human–machine interface |
| ICAO | International Civil Aviation Organization |
| ISO | International Standards Organization |
| LoI | level of involvement |
| MoC | means of compliance |
| PA | public address |
| RFM | rotorcraft flight manual |
| SAE | Society of Automotive Engineers |
| STC | supplemental type certificate |
| TAWS | terrain awareness and warning system |
| TCAS | traffic alert and collision avoidance system |
| TSO | technical standard order |
| VOR | very high frequency omnidirectional range |

CS-27 BOOK 2**2)_RELATION BETWEEN CS 27.1302 AND OTHER SPECIFICATIONS, AND ASSUMPTIONS****2.1_The relation of CS 27.1302 to other specifications**

- (a) CS-27 Book 2 establishes that the AMC for CS-27 is the respective FAA AC 27-1 revision adopted by EASA with the changes/additions included within Book 2. AC 27-1 includes the Miscellaneous Guidance MG-20 'Human Factors'. MG-20 aims to assist the applicant in understanding the HFs implications of the CS-27 paragraphs. In order to achieve this objective, MG-20 provides a list of all CS-27 HFs-related specifications, including those relevant to the performance and handling qualities, and helps to address within the certification plan some of the specifications that deal with the system design with additional guidance. However, MG-20 does not include specific guidance on how to perform a comprehensive HFs assessment as required by 27.1302. Therefore, adherence to the guidance material included within AC 27-1 and the associated MG-20 is not sufficient to demonstrate compliance with CS 27.1302.
- (b) This AMC provides dedicated guidance for demonstrating compliance with CS 27.1302. To help the applicant reach the objectives of CS 27.1302, some additional guidance related to other specifications associated with the installed equipment that the crew members use to operate the rotorcraft is also provided in Section 4. Table 1 below contains a list of these specifications related to cockpit design and crew member interfaces for which this AMC provides additional design guidance. Note that this AMC does not provide a comprehensive means of compliance for any of the specifications beyond CS 27.1302.

Paragraph 2 — Table 1: Certification specifications relevant to this AMC

| CS-27 BOOK 1 references | General topic | Referenced material in this AMC |
|--------------------------------|--|---|
| CS 27.771(a) | Unreasonable concentration or fatigue | Error, 4.5. Integration, 4.6. Controls, 4.2. System behaviour, 4.4. |
| CS 27.771(b) | Controllable from either pilot seat | Controls, 4.2. Integration, 4.6. |
| CS 27.773 | Pilot compartment view | Integration, 4.6. |
| CS 27.777(a) | Convenient operation of the controls | Controls, 4.2. Integration, 4.6. |
| CS 27.777(b) | Fully and unrestricted movement | Controls, 4.2. Integration, 4.6. |
| CS 27.779 | Motion and effect of cockpit controls | Controls, 4.2. |
| CS 27.1301(a) | Intended function of installed systems | Error, 4.5. Integration, 4.6. Controls, 4.2. Presentation of information, 4.3. System behaviour, 4.4. |
| CS 27.1302 | Crew error | Error, 4.5. Integration, 4.6. Controls, 4.2. Presentation of information, 4.3. System behaviour, 4.4. |

CS-27 BOOK 2

| CS-27 BOOK 1 references | General topic | Referenced material in this AMC |
|--------------------------------|--|--|
| CS 27.1309(a) | Intended function of required equipment under all operating conditions | Controls, 4.2. Integration, 4.6. |
| CS 27.1321 | Visibility of instruments | Integration, 4.6. |
| CS 27.1322 | Warning caution and advisory lights | Integration, 4.6. |
| CS 27.1329 and Appendix B VII | Automatic pilot system | System behaviour, 4.4. |
| CS 27.1335 | Flight director systems | System behaviour, 4.4 |
| CS 27.1523 | Minimum crew | Controls, 4.2. Integration, 4.6. |
| CS 27.1543(b) | Visibility of instrument markings | Presentation of information, 4.3. |
| CS 27.1549 | Powerplant instruments | Presentation of information, 4.3. |
| CS 27.1555(a) | Control markings | Controls, 4.2. |
| CS 27.1557 | Miscellaneous marking and placards | Presentation of information, 4.3. |

- (c) Where means of compliance in other AMCs are provided for specific equipment and systems, those means are assumed to take precedence if a conflict exists with the means provided here.

2.2_Crew member capabilities

In order to demonstrate compliance with all the specifications referenced by this AMC, all the certification activities should be based on the assumption that the rotorcraft will be operated by qualified crew members who are trained in the use of the installed systems and equipment.

CS-27 BOOK 2

3) HUMAN FACTORS CERTIFICATION

3.1 Overview

- (a) This paragraph provides an overview of the human factors (HFs) certification process that is acceptable to demonstrate compliance with CS 27.1302. This includes a description of the recommended applicant activities, the communication between the applicant and EASA, and the expected deliverables.
- (b) Figure 1 illustrates the main steps in the HFs certification process.

Paragraph 3 — Figure 1: Methodical approach to the certification for design-related human performance issues

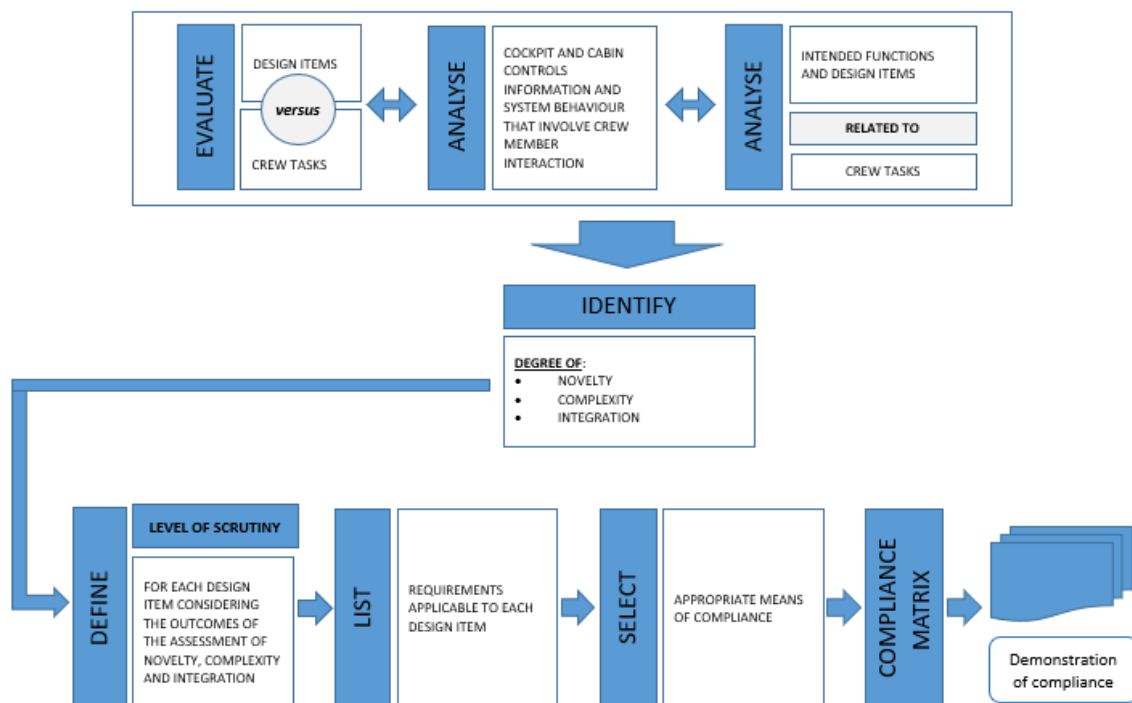

3.2 Certification steps and deliverables

3.2.1 Identification of the cockpit and cabin controls, information and systems that involve crew member interaction

- (a) As an initial step, the applicant should consider all the design items used by the crew members with the aim of identifying the controls, information and system behaviour that involve crew member interaction.
- (b) In case of a modification, the scope of the functions to be analysed is limited to the design items affected by the modification and its integration.
- (c) The objective is to analyse and document the crew member tasks to be performed, or how tasks might be changed or modified as a result of introducing a new design item(s).
- (d) Rotorcraft can be operated in different environments and types of missions. Therefore, while mapping the cockpit and the applicable crew member interfaces in the cabin or, in case of

CS-27 BOOK 2

modification, the modified design items versus the crew member tasks and the design item intended functions, the type of approvals under the type design applicable to the rotorcraft under assessment should be considered and documented.

For instance, approvals for:

- VFR,
- IFR,
- NVIS,
- SAR,
- aerial work (cargo hook or rescue hoist), or
- flight in known icing conditions

require different equipment to be installed or a different use of the same equipment. Therefore, the applicant should clarify the assumptions made when the assessment of the cockpit and the cabin functions is carried out.

3.2.2_The intended function of the equipment and the associated crew member tasks

- (a) CS 27.1301(a) requires that 'each item of installed equipment must be of a kind and design appropriate to its intended function'. CS 27.1302 establishes the requirements to ensure that the design supports the ability of the crew members to perform the tasks associated with the intended function of a system. In order to demonstrate compliance with CS 27.1302, the intended function of a system and the tasks expected to be performed by the crew members must be known.
- (b) An applicant's statement of the intended function should be sufficiently specific and detailed so that it is possible to evaluate whether the system is appropriate for the intended function(s) and the associated crew member tasks. For example, a statement that a new display system is intended to 'enhance situational awareness' should be further explained. A wide variety of different displays enhance the situational awareness in different ways. Some examples are terrain awareness, vertical profiles, and even the primary flight displays. The applicant may need to provide more detailed descriptions for designs with greater levels of novelty, complexity, or integration.
- (c) The applicant should describe the intended function(s) and associated task(s) for:
- (1) each design item affected by the modification and its integration;
 - (2) crew indications and controls for that equipment; and
 - (3) the prominent characteristics of those indications and controls.

This type of information is of the level typically provided in a pilot handbook or an operations manual. It would describe the indications, controls, and crew member procedures.

- (d) The applicant may evaluate whether the statement of the intended function(s) and the associated task(s) is sufficiently specific and detailed by using the following questions:
- (1) Does each design item have a stated intent?
 - (2) Are the crew member tasks associated with the function(s) described?
 - (3) What assessments, decisions, and actions are crew members expected to make based on the information provided by the system?

CS–27 BOOK 2

- (4) What other information is assumed to be used in combination with the system?
 - (5) Will the installation or use of the system interfere with the ability of the crew members to operate other cockpit systems?
 - (6) Are any assumptions made about the operational environment in which the equipment will be used?
 - (7) What assumptions are made about the attributes or abilities of the crew members beyond those required in the regulations governing operations, training, or qualification?
- (e) The output of this step is a list of design items, with each of the associated intended functions that has been related to the crew member tasks.

3.2.3 Determining the level of scrutiny

- (a) The depth and extent of the HFs investigation to be performed in order to demonstrate compliance with CS 27.1302 is driven by the level of scrutiny.

The level of scrutiny is determined by analysing the design items using the criteria described in the following subparagraph:

- (1) **Integration.** The level of the systems' integration refers to the extent to which there are interdependencies between the systems that affect the operation of the rotorcraft by the crew members. The applicant should describe the integration between systems because it may affect the means of compliance. Paragraph 4.6 also refers to integration. In the context of that paragraph, 'integration' defines how specific systems are integrated into the cockpit and how the level of integration may affect the means of compliance.
- (2) **Complexity.** The level of complexity of the system design from the crew members' perspective is an important factor that may also affect the means of compliance. Complexity has multiple dimensions, for instance:
 - the number, the accessibility and the level of integration of information that the crew members have to use (the number of items of information on a display, the number of colours), alerts, or voice messages may be an indication of the complexity;
 - the number, the location and the design of the cockpit controls associated with each system and the logic associated with each of the controls; and
 - the number of steps required to perform a task, and the complexity of the workflows.
- (3) **Novelty.** The novelty of a design item is an important factor that may also affect the means of compliance. The applicant should characterise the degree of novelty on the basis of the answers to the following questions:
 - (i) Are any new functions introduced into the cockpit design?
 - (ii) Does the design introduce a new intended function for an existing or a new design item?
 - (iii) Are any new technologies introduced that affect the way the crew members interact with the systems?

CS-27 BOOK 2

- (iv) Are any new design items introduced at aircraft level that affect crew member tasks?
- (v) Are any unusual procedures needed as a result of the introduction of a new design item?
- (vi) Does the design introduce a new way for the crew members to interact with the system?

While answering the above questions, each negative response should be justified by the applicant identifying the reference product as well that has been considered. The reference product can be an avionics suite or an entire flight deck previously certified by the same applicant.

The degree of novelty should be proportionate to the number of positive answers to the above questions.

- (b) All the affected design items (refer to point 3.2.1) are expected to be scrutinised. If none of the criteria in point (a) above is met, the related design item is candidate for a low level of scrutiny.

The level of scrutiny performed by the applicant should be proportionate to the number of the above criteria which are met by each design item. Applicants should be aware that the impact of a complex design item might also be affected by its novelty and the extent of its integration with other elements of the cockpit. For example, a complex but not novel design item is likely to require a lower level of scrutiny than one that is both complex and novel. The applicant is expected to include in the certification plan all the items that have been analysed with the associated level of scrutiny.

- (c) The applicant may use a simpler approach for design items that have been assigned a low level of scrutiny.

3.2.4_Determining the level of scrutiny — EASA’s familiarity with the project

The assessment of the classifications of the level of scrutiny proposed by the applicant requires the EASA flight and HFs panels to be familiar with the project, making use of the available material and tools.

3.2.5_Applicable HFs design requirements

- (a) The applicant should identify the HFs design requirements applicable to each design item for which compliance must be demonstrated. This may be accomplished by identifying the design characteristics of the design items that could adversely affect the performance of the crew members, or that pertain to the avoidance and management of crew member errors. Specific design considerations for the requirements that involve human performance are discussed in paragraph 4.
- (b) The expected output of this step is a compliance matrix that links the design items and the HFs design requirements that are deemed to be relevant and applicable so that a detailed assessment objective can be derived from each pair of a design item and a HFs design requirement. That objective will have then to be verified using the most appropriate means of compliance, or a combination of means of compliance. GM2 27.1302 provides one possible example of this matrix.

CS-27 BOOK 2

3.2.6_Selecting the appropriate means of compliance

- (a) The applicant should review paragraph 5.2 for guidance on the selection of the means of compliance, or multiple means of compliance, appropriate to the design. In general, it is expected that the level of scrutiny should increase with higher levels of novelty, complexity or integration of the design. It is also expected that the amount of effort dedicated to the demonstration of compliance should increase with higher levels of scrutiny (e.g. by using multiple means of compliance and/or multiple HF assessments on the same topic).
- (b) The output of this step will consist of the list of means of compliance that will be used to verify the HF objectives.

3.2.7_Certification programme

The applicant should document the certification process, outputs and agreements described in the previous paragraphs. This may be done in a separate plan or incorporated into a higher-level certification programme.

3.2.8_Other deliverables

- (a) A HF test programme should be produced for each assessment and should describe the experimental protocol (the number of scenarios, the number and profiles of the crew members, practical organisation of the assessment, etc.), the HF objectives that are meant to be addressed, the expected crew member behaviour, and the scenarios expected to be run. When required by the Lol, the HF test programme should be provided well in advance to EASA.
- (b) A HF test report should be produced including at least the following information:
 - (1) A summary of:
 - (i) the test vehicle configuration,
 - (ii) of test vehicle limitations/representativeness,
 - (iii) the detailed HF objectives, and
 - (iv) the HF test protocol, including the number of sessions and crew members, type of crews (test or operational pilots from the applicant, authority pilots, customer pilots), a description of the scenarios, the organisation of the session (training, briefing, assessment, debriefing), and the observers;
 - (2) A description of the data gathered with the link to the HF objectives;
 - (3) In-depth analyses of the observed HF findings;
 - (4) Conclusions regarding the related HF test objectives; and
 - (5) A description of the proposed way to mitigate the HF findings (by a design modification, improvements in procedures, and/or training actions).

If EASA has retained the review of the test report as part of its Lol, then the applicant should deliver it following every HF assessment.

CS-27 BOOK 2

3.2.9_Proportional approach in the compliance demonstration

In order to determine the certification programme, some alleviations (in terms of certification strategy and certification deliverables) may be granted by EASA for compliance demonstration process, according to the criteria below:

- (a) New types
 - (1) An applicant that seeks an approval for a CS-27 rotorcraft for IFR or CAT A operations, should follow this AMC in its entirety.
 - (2) An applicants that seeks an approval for a CS-27 rotorcraft only for CAT B and VFR operations, may take advantage of the alleviations listed in (b)(2) below.

In particular, the alleviations listed in (b)(2) are expected to be fully recognised if at least one of the following conditions is met:

 - (i) the rotorcraft is single engined;
 - (ii) the rotorcraft design to be approved is not compatible with a future approval for IFR operations.
- (b) Significant and non-significant changes
 - (1) An applicant for a significant change should follow the criteria established in (a)(1) or (a)(2) above, depending on the case.
 - (2) An applicant for a non-significant change (refer to the change classification in point 21.A.101 of Part 21 and the related GM):
 - (i) is not required to develop a dedicated HFs test programme;
 - (ii) is allowed to use a single occurrence of a test for compliance demonstration;
 - (iii) is allowed to use a single crew to demonstrate the HFs-scenario-based assessments.

3.3_Certification strategy and methodologies

3.3.1_Certification strategy

- (a) The HFs assessment should follow an iterative process. Consequently, where appropriate, there may be several iterations of the same system-specific assessment allowing the applicant to reassess the system if the previous campaigns resulted in design modifications.
- (b) A HFs certification strategy based only on one assessment, aiming to demonstrate that the design assumptions are valid, is generally not sufficient (i.e. one final exercise proposed for compliance demonstration at the very end of the process).
- (c) In order to allow a sufficient amount of design and assessment iterations, it is suggested that the applicant initiate the certification process as early as possible starting from the early development phase. The certification process could include familiarisation sessions that would allow EASA to become familiar with the proposed design, but also participate in assessments that would possibly allow early credits to be granted. Potential issues may be identified early on by using this approach, thus reducing the risk of a late redesign of design items that may not be acceptable to EASA. Both parties may have an interest in authority early involvement, as the authority is continuously gaining experience and confidence in the HFs process and the compliance of the cockpit design. The representativeness of the systems and of the simulation means in the early stages of the development is not a key driver, and will not prevent EASA's

CS-27 BOOK 2

involvement as long as the representativeness issues do not compromise the validity of the data to be collected.

- (d) If an applicant plans to use data provided by a supplier for compliance demonstration, the approach and the criteria for accepting that data will have to be shared and agreed with EASA as part of the HF's certification plan.

3.3.2 Methodological considerations applicable to HF's assessments

Various means of compliance may be selected, as described in paragraph 5.

For the highest level of scrutiny, the 'scenario-based' approach is likely to be the most appropriate methodology for some means of compliance.

The purpose of the following points is to provide guidelines on how to implement the scenario-based approach.

- (a) The scenario-based approach is intended to substantiate the compliance of human-machine interfaces (HMIs). It is based on a methodology that involves a sample of various crews that are representative of the future users, being exposed to real operational conditions in a test bench or a simulator, or in the rotorcraft. The scenarios are designed to show compliance with selected rules and to identify any potential deviations between the expected behaviour of the crew members and the activities of the crew members that are actually observed. The scenario designers can make use of triggering events or conditions (e.g. a system failure, an ATC request, weather conditions, etc.) in order to build operational situations that are likely to trigger observable crew member errors, difficulties or misunderstandings. The scenarios need to be well consolidated before the test campaign begins. A dry-run session should be performed by the applicant before any HF's campaign in order to validate the operational relevance of the scenarios. This approach should be used for both system- and rotorcraft-level assessments.
- (b) System-level assessments focus on a specific design item and are intended for an in-depth assessment of the related functional and operational aspects, including all the operational procedures. The representativeness of the test article is to be evaluated taking into account the scope of the assessment. Rotorcraft-level assessments consider the scope of the full cockpit, and focus on integration and interdependence issues.
- (c) The scenarios are expected to cover a subset of the detailed HF's test objectives. The link between each scenario and the test objectives should be substantiated. This rationale should be described in the certification test plan or in any other relevant document.
- (d) The criteria used to select the crew members involved in the HF's assessments with certification credit should be adequate to the scope of the tests to be conducted and the selection process of the crew members should be recorded. The applicant should ensure that the test participants are representative of the end users.
- (e) Due to interindividual variability, HF's scenario-based assessments performed with a single crew member are not acceptable. The usually accepted number of different crew members used for a given campaign varies from three to five, including the authority crew, if applicable. In the case of a crew of two with HF's objectives focused on the duties of only one of the crew members, it is fully acceptable for the applicant to use the same pilot flying or monitoring (the one who is not expected to produce any HF's data) throughout the campaign.
- (f) In addition to the test report, and in order to reduce the certification risk, it is recommended that the preliminary analyses resulting from recorded observations and comments should be presented by the applicant to EASA soon after the simulator/flight sessions in order to allow expert discussions to take place.

CS-27 BOOK 2

- (g) An initial briefing should be given to the crew members at the beginning of each session to present the following general information:
- (1) A detailed schedule describing the type and duration of the activities (the duration of the session, the organisation of briefing and debriefings, breaks, etc.);
 - (2) What is expected from the crew members: it has to be clearly mentioned that the purpose of the assessment is to assess the design of the cockpit, not the performance of the pilot;
 - (3) The policy for simulator occupancy: how many people should be in the simulator versus the number of people in the control room, and who they should be; and
 - (4) The roles of the crew members: if crew members from the applicant participate in the assessment, they should be made aware that their role differs significantly from their typical expert pilot role in the development process. For the process to be valid without significant bias, they are expected to react and behave in the cockpit as standard operational pilots.
 - (5) However, the crew members that participate in the assessment should not be:
 - (i) briefed in advance about the details of the failures and events to be simulated; this is to avoid an obvious risk of experimental bias; nor
 - (ii) asked before the assessment for their opinion about the scenarios to be flown.
- (h) The crew members need to be properly trained prior to every assessment so that during the analysis, the 'lack of training' factor can be excluded to the maximum extent possible from the set of potential causes of any observed design-related human performance issue. Furthermore, for operational representativeness purposes, realistic crew member task sharing, from normal to emergency workflows and checklists, should be respected during HF assessments. The applicant should make available any draft or final RFM, procedures and checklists sufficiently in advance for the crew members to prepare.
- (i) When using simulation, the immersion feeling of the crew should be maximised in order to increase the validity of the data. This generally leads to recommendations about a sterile environment (with no outside noise or visual perturbation), no intervention by observers, no interruptions in the scenarios unless required by the nature of the objectives, realistic simulation of ATC communications, pilots wearing headsets, etc.
- (j) The method used to collect HF data needs to take into account the following principles:
- (1) Principles applicable to the collection of HF-related data
 - (i) In order to substantiate compliance with CS 27.1302, it is necessary to collect both objective and related subjective data.
 - (A) **Objective data** on crew member performance and behaviour should be collected through direct observation. The observables should not be limited to human errors, but should also include pilot verbalisations in addition to behavioural indicators such as hesitation, suboptimal or unexpected strategies, catachresis, etc.
 - (B) **Subjective data** should be collected during the debriefing by the observer through an interactive dialogue with the observed crew members. The debriefing should be led using a neutral and critical positioning from the observer.
This subjective data is typically data that cannot be directly observed (e.g.

CS-27 BOOK 2

- pilot intention, pilot reasoning, etc.) and facilitate better understanding of the observed objective data from (i).
- (ii) Other tools such as questionnaires and rating scales could be used as complementary means. However, it is never sufficient to rely solely on self-administered questionnaires due to the fact that crew members are not necessarily aware of all their errors, or of deviations with respect to the intended use.
- (2) The HF's assessment should be systematically video recorded (both ambient camera and displays). Records may be used by the applicant as a complementary observation means, and by the authority for verification purposes, when required.
- (3) It is very important to conduct debriefings after the HF's assessments. They allow the applicant's HF's observers to gather all the necessary data that has to be used in the subsequent HF's analyses.
- (4) HF's observers should respect the best practices with regard to observation and debriefing techniques.
- (5) Debriefings should be based on non-directive or semidirective interviewing techniques and should avoid the experimental biases that are well described in the literature in the field of social sciences (e.g. the expected answer contained in the question, non-neutral attitude of the interviewer, etc.).
- (k) If HF's-related concerns are raised that are not directly related to the objective of the assessment, they should nevertheless be recorded, adequately investigated and analysed in the test report.
- (l) Every design-related human performance issue observed or reported by the crew members should be analysed following the assessment. In the case of a human error, the analysis should provide information about at least the following:
- (1) The type of error;
 - (2) The observed operational consequences, and any reductions in the safety margins;
 - (3) The description of the operational context at the time of observation;
 - (4) Was the error detected? By whom, when and how?
 - (5) Was the error recovered? By whom, when and how?
 - (6) Existing means of mitigation;
 - (7) Possible effects of the representativeness of the test means on the validity of the data; and
 - (8) The possible causes of the error.
- (m) The analysis of design-related human performance issues has to be concluded by detailing the appropriate way forward, which is one of the following:
- (1) No action required;
 - (2) An operational recommendation (for a procedural improvement or a training action);
 - (3) A recommendation for a design improvement; or
 - (4) A combination of items (2) and (3).
- (n) Workload assessment is considered and addressed in different ways through several requirements within CS-27.

CS-27 BOOK 2

- (1) The intent of CS 27.1523 is to evaluate the workload with the objective of demonstrating compliance with the minimum flight crew requirements.
- (2) The intent of CS 27.1302 is to identify design-related human performance issues.
- (3) As per CS 27.1302, the acceptability of workload levels is one parameter among many to be investigated in order to highlight potential usability problems. The CS 27.1302 evaluations should not be limited to the workload alone. Workload ratings should be complementary to other data from observations of crew member behaviour or other types.
- (4) The techniques used to collect data in the context of the CS 27.1302 evaluations could make use of workload rating scales, but in that case no direct conclusion should be made from the results about the compliance with CS 27.1302.

CS-27 BOOK 2**4)_DESIGN CONSIDERATIONS AND GUIDANCE****4.1_Overview**

- (a) This material provides the standard which should be applied in order to design a cockpit that is in line with the objectives of CS 27.1302. Not all the criteria can or should be met by all systems. Applicants should use their judgment and experience in determining which design standard should apply to each part of the design in each situation.
- (b) The following provide a cross reference between this paragraph and the requirements listed in CS 27.1302:
 - (1) 'Controls' mainly relates to 1302(a) and (b);
 - (2) 'Presentation of information' mainly relates to 1302(a) and (b);
 - (3) 'System behaviour' mainly relates to 1302(c); and
 - (4) 'Error management' mainly relates to 1302(d).

Additionally, specific considerations on integration are given in paragraph 4.6.

4.2_Controls

- (a) Applicants should show that in the proposed design, as defined in CS 27.777, 27.779, 27.1543 and 27.1555, the controls comply with CS 27.1302(a) and (b).
- (b) Each function, method of operating a control, and result of actuating a control should comply with the requirements. Each control must be shown to be:
 - (1) clear,
 - (2) unambiguous,
 - (3) appropriate in resolution and precision,
 - (4) accessible, and
 - (5) usable.
 - (6) It must also enable crew member awareness, including the provision of adequate feedback.
- (c) For each of these design requirements, consideration should be given to the following control characteristics for each control individually and in relation to other controls:
 - (1) The physical location of the control;
 - (2) The physical characteristics of the control (e.g. its shape, dimensions, surface texture, range of motion, and colour);
 - (3) The equipment or system(s) that the control directly affects;
 - (4) How the control is labelled;
 - (5) The available settings of the control;

CS-27 BOOK 2

- (6) The effect of each possible actuation or setting, as a function of the initial control setting or other conditions;
- (7) Whether there are other controls that can produce the same effect (or can affect the same target parameter), and the conditions under which this will happen; and
- (8) The location and nature of the feedback that shows the control was actuated.

The following provides additional guidance for the design of controls that comply with CS 27.1302.

- (d) The clear and unambiguous presentation of control-related information
 - (1) Distinguishable and predictable controls (CS 27.1301(a), CS 27.1302)
 - (i) Each crew member should be able to identify and select the current function of the control with the speed and accuracy appropriate to the task. The function of a control should be readily apparent so that little or no familiarisation is required.
 - (ii) The applicant should evaluate the consequences of actuating each control and show they are predictable and obvious to each crew member. This includes the control of multiple displays with a single device, and shared display areas that crew members may access with individual controls. The use of a single control should also be assessed.
 - (iii) Controls should be made distinguishable and/or predictable by differences in form, colour, location, motion, effect and/or labelling. For example, the use of colour alone as an identifying feature is usually not sufficient.
 - (2) Labelling (CS 27.1301(b), CS 27.1302(a) and (b), CS 27.1543(b), CS 27.1555(a))
 - (i) For the general marking of controls, see CS 27.1555(a).

Labels should be readable from the crew member's normal seating positions, including the marking used by the crew member from their operating positions in the cabin (if applicable) in all lighting and environmental conditions.

Labelling should include all the intended functions unless the function of the control is obvious. Labels of graphical controls accessed by a cursor-control device, such as a trackball, should be included on the graphical display. If menus lead to additional choices (submenus), the menu label should provide a reasonable description of the next submenu.
 - (ii) The applicant can label the controls with text or icons. The text and the icons should be shown to be distinct and meaningful for the function that they label. The applicant should use standard or unambiguous abbreviations, nomenclature, or icons, consistent within a function and across the cockpit. ICAO Doc 8400 'Procedures for Air Navigation Services (PANS) — ICAO Abbreviations and Codes' provides standard abbreviations, and is an acceptable basis for selecting labels.
 - (iii) If an icon is used instead of a text label, the applicant should show that the crew members require only a brief exposure to the icon to determine the function of the control and how it operates. Based on design experience, the following guidelines for icons have been shown to lead to usable designs:

CS-27 BOOK 2

- (A) The icon should be analogous to the object it represents;
 - (B) The icon should be generally used in aviation and well known to crews, or has been validated during a HFs assessment; and
 - (C) The icon should be based on established standards, if they exist, and on conventional meanings.
- (3) Interactions of multiple controls (CS 27.1302(b)(3))
- If multiple controls for one function are provided to the crew members, the applicant should show that there is sufficient information to make the crew members aware of which control is currently functioning. As an example, crew members need to know which crew member's input has priority when two cursor-control devices can access the same display. Designers should use caution for dual controls that can affect the same parameter simultaneously.
- (e) The accessibility of controls (CS 27.777(a), CS 27.777(b), CS 27.1302)
- (1) Any control required for crew member operation (in normal, abnormal/malfunction and emergency conditions) should be shown to be visible, reachable, and operable by the crew members with the stature specified in CS 27.777(b), from the seated position with shoulder restraints on. If the shoulder restraints are lockable, the applicant should show that the pilots can reach and actuate high-priority controls needed for the safe operation of the aircraft with the shoulder harnesses locked.
 - (2) Layering of information, as with menus or multiple displays, should not hinder the crew members from identifying the location of the desired control. Evaluating the location and accessibility of a control requires the consideration of more than just the physical aspects of the control. Other location and accessibility considerations include where the control functions may be located within various menu layers, and how the crew member navigates those layers to access the functions. Accessibility should be shown in conditions of system failures and of a master minimum equipment list (MMEL) dispatch.
 - (3) The position and direction of motion of a control should be oriented according to CS 27.777.
- (f) The use of controls
- (1) Environmental factors affecting the controls (CS 27.1301(a) and CS 27.1302)
 - (i) If the use of gloves is anticipated, the cockpit design should allow their use with adequate precision as per CS 27.1302(b)(2) and (c)(2).
 - (ii) The sensitivity of the controls should provide sufficient precision (without being overly sensitive) to perform tasks even in adverse environments as defined for the rotorcraft's operational envelope per CS 27.1302(c)(2) and (d). The analysis of the environmental factors as a means of compliance is necessary, but not sufficient, for new control types or technologies, or for novel use of the controls that are themselves not new or novel.
 - (iii) The applicant should show that the controls required to regain control of the rotorcraft or system and the controls required to continue operating the rotorcraft in a safe manner are usable in conditions with extreme lighting conditions and severe vibration levels and should not prevent the crew members from performing all their tasks with an acceptable level of performance and workload.

CS-27 BOOK 2**(2) Control display compatibility (CS 27.777 and CS 27.779)**

CS 27.779 describes the direction of movement of the cockpit controls.

- (i) To ensure that a control is unambiguous per CS 27.1302(b)(1), the relationship and interaction between a control and its associated display or indications should be readily apparent, understandable, and logical. For example, the applicant should specifically assess any rotary knob that has no obvious 'increase' or 'decrease' function with regard to the crew members' expectations and its consistency with the other controls in the cockpit. The Society of Automotive Engineers' (SAE) publication ARP4102, Chapter 5, is an acceptable means of compliance for controls used in cockpit equipment.
- (ii) CS 27.777(a) requires each cockpit control to be located so that it provides convenient operation and prevents confusion and inadvertent operation. The controls associated with a display should be located so that they do not interfere with the performance of the crew members' tasks. Controls whose function is specific to a particular display surface should be mounted near to the display or the function being controlled. Locating controls immediately below a display is generally preferable, as mounting controls immediately above a display has, in many cases, caused the crew member's hand to obscure their view of the display when operating the controls. However, controls on the bezel of multifunction displays have been found to be acceptable.
- (iii) Spatial separation between a control and its display may be necessary. This is the case with a control of a system that is located with other controls for that same system, or when it is one of several controls on a panel dedicated to controls for that multifunction display. When there is a large spatial separation between a control and its associated display, the applicant should show that the use of the control for the associated task(s) is acceptable in accordance with 27.777(a) and 27.1302.
- (iv) In general, the design and placement of controls should avoid the possibility that the visibility of information could be blocked. If the range of movement of a control temporarily blocks the crew members' view of information, the applicant should show that this information is either not necessary at that time or is available in another accessible location (CS 27.1302(b)(2) requires the information intended for use by the crew members to be accessible and useable by the crew members in a manner appropriate to the urgency, frequency, and duration of the crew members' tasks).
- (v) Annunciations/labels on electronic displays should be identical to the labels on the related switches and buttons located elsewhere on the cockpit. If display labels are not identical to those on the related controls, the applicant should show that crew members can quickly, easily, and accurately identify the associated controls so they can safely perform all the tasks associated with the intended function of the systems and equipment (27.1302).

(3) Control display design

- (i) Controls of a variable nature that use a rotary motion should move clockwise from the OFF position, through an increasing range, to the full ON position.

CS-27 BOOK 2

- (g) Adequacy of feedback (CS 27.771(a), CS 27.1301(a), CS 27.1302)
- (1) Feedback for the operation of the controls is necessary to give the crew members awareness of the effects of their actions. The meaning of the feedback should be clear and unambiguous. For example, if the intent of the feedback is to indicate a commanded event versus system state. Additionally, provide feedback when a crew member's input is not accepted or not followed by the system (27.1302(b)(1)). This feedback can be visual, auditory, or tactile.
 - (2) To meet the objectives of CS 27.1302, the applicant should show that feedback in all forms is obvious and unambiguous to the crew members when performing their tasks associated with the intended function of the equipment. Feedback, in an appropriate form, should be provided to inform the crew members that:
 - (i) a control has been activated (commanded state/value);
 - (ii) the function is in process (given an extended processing time);
 - (iii) the action associated with the control has been initiated (actual state/value if different from the commanded state); or
 - (iv) when a control is used to move an actuator through its range of travel, the equipment should provide, if needed (for example, fly-by-wire system), within the time required for the relevant task, operationally significant feedback of the actuator's position within its range. Examples of information that could appear relative to an actuator's range of travel include the target speed, and the state of the valves of various systems.
 - (3) The type, duration and appropriateness of the feedback will depend upon the crew member's task and the specific information required for successful operation. As an example, the switch position alone is insufficient feedback if awareness of the actual system response or the state of the system as a result of an action is required in accordance with CS 27.1302(b)(3).
 - (4) Controls that may be used while the user is looking outside or at unrelated displays should provide tactile feedback. Keypads should provide tactile feedback for any key depression. In cases when this is omitted, it should be replaced with appropriate visual or other feedback indicating that the system has received the inputs and is responding as expected.
 - (5) The equipment should provide appropriate visual feedback, not only for knob, switch, and push-button positions, but also for graphical control methods such as pull-down menus and pop-up windows. The user interacting with a graphical control should receive a positive indication that a hierarchical menu item has been selected, a graphical button has been activated, or another input has been accepted.

CS-27 BOOK 2

4.3_The presentation of information

(a) Introduction

- (1) The presentation of information to the crew members can be visual (for instance, on a display), auditory (a 'talking' checklist), or tactile (for example, control feel). The presentation of information in the integrated cockpit, regardless of the medium used, should meet all of the requirements bulleted above. For visual displays, this AMC addresses mainly display format issues and not display hardware characteristics. The following provides design considerations for the requirements found in CS 27.1301(a), CS 27.1301(b), CS 27.1302, and CS 27.1543(b).
- (2) Applicants should show that, in the proposed design, as defined in CS 27.1301, 27.771(a) and 27.771(b), the presented information is:
 - clear,
 - unambiguous,
 - appropriate in resolution and precision,
 - accessible,
 - usable, and
 - able to provide adequate feedback for crew member awareness.

(b) The clear and unambiguous presentation of information

Qualitative and quantitative display formats (CS 27.1301(a) and CS 27.1302)

- (1) Applicants should show, as per CS 27.1302(b), that display formats include the type of information the crew member needs for the task, specifically with regard to the required speed and precision of reading. For example, the information could be in the form of a text message, numerical value, or a graphical representation of state or rate information. State information identifies the specific value of a parameter at a particular time. Rate information indicates the rate of change of that parameter.
- (2) If the crew member's sole means of detecting abnormal values is by monitoring the values presented on the display, the equipment should offer qualitative display formats. Analogue displays of data are best for conveying rate and trend information. If this is not practical, the applicant should show that the crew members can perform the tasks for which the information is used. Digital presentations of information are better for tasks requiring precise values. Refer to CS 27.1322 when an abnormal value is associated with a crew alert.

(c) Display readability (CS 27.1301(b) and CS 27.1543(b))

Crew members, seated at their stations and using normal head movement, should be able to see and read display format features such as fonts, symbols, icons and markings. In some cases, cross-cockpit readability may be required to meet the intended function that both pilots must be able to access and read the display. Examples of situations where this might be needed are cases of display failures or when cross-checking flight instruments. Readability must be maintained in sunlight viewing conditions (as per CS 27.773(a)) and under other adverse conditions such as vibration. Figures and letters should subtend not less than the visual angles defined in SAE ARP4102-7 at the design eye position of the crew member that normally uses the information.

CS–27 BOOK 2**(d) Colour (CS 27.1302)**

- (1) The use of many different colours to convey meaning on displays should be avoided. However, if thoughtfully used, colour can be very effective in minimising the workload and response time associated with display interpretation. Colour can be used to group functions or data types in a logical way. A common colour philosophy across the cockpit is desirable.
- (2) Applicants should show that the chosen colour set is not susceptible to confusion or misinterpretation due to differences in colour coordinates between the displays.
- (3) Improper colour-coding increases the response times for display item recognition and selection, and increases the likelihood of errors, which is particularly true in situations where the speed of performing a task is more important than the accuracy, so the compatibility of colours with the background should be verified in all the foreseeable lighting conditions. The use of the red and amber colours for other than alerting functions or potentially unsafe conditions is discouraged. Such use diminishes the attention-getting characteristics of true warnings and cautions.
- (4) The use of colour as the sole means of characterising an item of information is also discouraged. It may be acceptable, however, to indicate the criticality of the information in relation to the task. Colour, as a graphical attribute of an essential item of information, should be used in addition to other coding characteristics such as texture or differences in luminance. FAA AC 27-1B Change 7, MG-19, contains recommended colour sets for specific display features.
- (5) Applicants should show that the layering of information on a display does not add to confusion or clutter as a result of the colour standards and symbols used. Designs that require crew members to manually declutter such displays should also be avoided.

(e) Symbology, text, and auditory messages (CS 27.1302)

- (1) Designs can base many elements of electronic display formats on established standards and conventional meanings. For example, ICAO Doc 8400 'Procedures for Air Navigation Services (PANS) — ICAO Abbreviations and Codes' provides abbreviations, and is one standard that could be applied to the textual material used in the cockpit.

SAE ARP4102-7, Appendices A to C, and SAE ARP5289A are acceptable standards for avionics display symbols.
- (2) The position of a message or symbol within a display also conveys meaning to the crew members. Without the consistent or repeatable location of a symbol in a specific area of the electronic display, interpretation errors and response times may increase.
- (3) Applicants should give careful attention to symbol priority (the priority of displaying one symbol overlaying another symbol by editing out the secondary symbol) to ensure that higher-priority symbols remain viewable.
- (4) New symbols (a new design or a new symbol for a function which historically had an associated symbol) should be assessed for their distinguishability and for crew understanding and retention.
- (5) Applicants should show that displayed text and auditory messages are distinct and meaningful for the information presented. CS 27.1302 requires the information intended for use by the crew members to be provided in a clear and unambiguous format in a

CS-27 BOOK 2

resolution and precision appropriate to the task, and the information to convey the intended meaning. The equipment should display standard and/or unambiguous abbreviations and nomenclature, consistent within a function and across the cockpit.

- (f) The accessibility and usability of information
- (1) The accessibility of information (CS 27.1302)
- (i) Information intended for the crew members must be accessible and useable by the crew members in a manner appropriate to the urgency, frequency, and duration of their tasks, as per CS 27.1302(b)(2). The crew members may, at certain times, need some information immediately, while other information may not be necessary during all phases of flight. The applicant should show that the crew members can access and manage (configure) all the necessary information on the dedicated and multifunction displays for the given phase of flight. The applicant should show that any information required for continued safe flight and landing is accessible in the relevant degraded display modes following failures as defined by CS 27.1309. The applicant should specifically assess what information is necessary in those conditions, and how such information will be simultaneously displayed. The applicant should also show that supplemental information does not displace or otherwise interfere with the required information.
- (ii) Analysis as the sole means of compliance is not sufficient for new or novel display management schemes. The applicant should use simulation of typical operational scenarios to validate the crew member's ability to manage the available information.
- (2) Clutter (CS 27.1302)
- (i) Visual or auditory clutter is undesirable. To reduce the crew member's interpretation time, the equipment should present information simply and in a well-ordered way. Applicants should show that an information delivery method (whether visual or auditory) presents the information that the crew member actually requires to perform the task at hand. Crew members can use their own discretion to limit the amount of information that needs to be presented at any point in time. For instance, a design might allow the crew members to program a system so that it displays the most important information all the time, and less important information on request. When a design allows the crew members to select additional information, the basic display modes should remain uncluttered.
- (ii) Display options that automatically hide information for the purpose of reducing visual clutter may hide needed information from the crew member. If the equipment uses automatic deselection of data to enhance the crew member's performance in certain emergency conditions, the applicant must show, as per CS 27.1302(a), that it provides the information the crew member needs. The use of part-time displays depends not only on the removal of clutter from the information, but also on the availability and criticality of the display. Therefore, when designing such design items, the applicant should follow the guidance in CS-27 Book 2 (e.g. FAA AC 27, MG-19).
- (iii) Because of the transient nature of the auditory information presentation, designers should be careful to avoid the potential for competing auditory presentations that may conflict with each other and hinder their interpretation. Prioritisation and timing may be useful to avoid this potential problem.

CS-27 BOOK 2

(iv) Information should be prioritised according to the criticality of the task. Lower-priority information should not mask higher-priority information, and higher-priority information should be available, readily detectable, easily distinguishable and usable.

(3) System response time.

Long or variable response times between a control input and the system response can adversely affect the usability of the system. The applicant should show that the response to a control input, such as setting values, displaying parameters, or moving a cursor symbol on a graphical display, is fast enough to allow the crew members to complete the task at an acceptable level of performance. For actions that require a noticeable system processing time, the equipment should indicate that the system response is pending.

4.4_System behaviour

(a) Introduction

The demands of the crew members' tasks vary depending on the characteristics of the system design. Systems differ in their responses to relevant crew member inputs. The response can be direct and unique, as in mechanical systems, or it can vary as a function of an intervening subsystem (such as hydraulics or electrics). Some systems even automatically vary their responses to capture or maintain a desired rotorcraft or system state.

- (1) CS 27.1302(c) states that the installed equipment must be designed so that the behaviour of the equipment that is operationally relevant to the crew members' tasks is: (1) predictable and unambiguous, and (2) designed to enable the crew members to intervene in a manner appropriate to the task (and intended function).
- (2) The requirement for operationally relevant system behaviour to be predictable and unambiguous will enable the crew members to know what the system is doing and what they did to enable/disable the behaviour. This distinguishes the system behaviour from the functional logic within the system design, much of which the crew members do not know or do not need to know.
- (3) If crew member intervention is part of the intended function, or part of the abnormal/malfunction or emergency procedures for the system, the crew member may need to take some action, or change an input to the system. The system must be designed accordingly. The requirement for crew member intervention capabilities recognises this reality.
- (4) Improved technologies, which have increased safety and performance, have also introduced the need to ensure proper cooperation between the crew members and the integrated, complex information and control systems. If the system behaviour is not understood or expected by the crew members, confusion may result.
- (5) Some automated systems involve tasks that require crew members' attention for effective and safe performance. Examples include flight management systems (FMSs) or flight guidance systems. Alternatively, systems designed to operate autonomously, in the sense that they require very limited or no human interaction, are referred to as 'automatic systems'. Such systems are switched 'ON' or 'OFF' or run automatically, and, when operating in normal conditions, the guidance material of this paragraph is not applicable to them. Examples include full authority digital engine controls (FADECs). Detailed

CS–27 BOOK 2

specific guidance for automatic systems can be found in the relevant parts of CS-27.

- (b) The allocation of functions between crew members and automation.

The applicant should show that the allocation of functions is conducted in such a way that:

- (1) the crew members are able to perform all the tasks allocated to them, considering normal, abnormal/malfunction and emergency operating conditions, within the bounds of an acceptable workload and without requiring undue concentration or causing undue fatigue (see CS 27.1523 and 27.771(a) for workload assessment); and
- (2) the system enables the crew members to understand the situation, and enables timely failure detection and crew member intervention when appropriate.

- (c) The functional behaviour of a system

- (1) The functional behaviour of an automated system results from the interaction between the crew members and the automated system, and is determined by:

- (i) the functions of the system and the logic that governs its operation; and
- (ii) the user interface, which consists of the controls that communicate the crew members' inputs to the system, and the information that provides feedback to the crew members on the behaviour of the system.

- (2) The design should consider both the functions of the system and the user interface together. This will avoid a design in which the functional logic governing the behaviour of the system can have an unacceptable effect on the performance of the crew members. Examples of system functional logic and behavioural issues that may be associated with errors and other difficulties for the crew members are the following:

- (i) The complexity of the crew members' interface for both control actuation and data entry, and the complexity of the corresponding system indications provided to the crew members;
- (ii) The crew members having inadequate understanding and incorrect expectations of the behaviour of the system following mode selections and transitions; and
- (iii) The crew members having inadequate understanding and incorrect expectations of what the system is preparing to do next, and how it is behaving.

- (3) Predictable and unambiguous system behaviour (CS 27.1302(c)(1))

Applicants should detail how they will show that the behaviour of the system or the system mode in the proposed design is predictable and unambiguous to the crew members.

- (i) System or system mode behaviour that is ambiguous or unpredictable to the crew members has been found to cause or contribute to crew errors. It can also potentially degrade the crew's ability to perform their tasks in normal, abnormal/malfunction and emergency conditions. Certain design characteristics have been found to minimise crew errors and other crew performance problems.
- (ii) The following design considerations are applicable to operationally relevant systems and to the modes of operation of the systems:

CS-27 BOOK 2

- (A) The system behaviour should be simple (for example, the number of modes, or mode transitions).
 - (B) Mode annunciation should be clear and unambiguous. For example, a mode engagement or arming selection by the crew members should result in annunciation, indication or display feedback that is adequate to provide awareness of the effect of their action. Additionally, any change in the mode as a result of the rotorcraft changing from one operational mode (for instance, on an approach) to another should be clearly and unambiguously annunciated and fed back to the crew members.
 - (C) Methods of mode arming, engagement and deselection should be accessible and usable. For example, the control action necessary to arm, engage, disarm or disengage a mode should not depend on the mode that is currently armed or engaged, on the setting of one or more other controls, or on the state or status of that or another system.
 - (D) Uncommanded mode changes and reversion should have sufficient annunciation, indication, or display information to provide awareness of any uncommanded changes of the engaged or armed mode of a system. 'Uncommanded' could refer both to a mode change not commanded by the pilot but by the automation as part of its normal operation, or to a mode change resulting from a malfunction.
 - (E) The current mode should remain identified and displayed at all times.
- (4) Crew member intervention (CS 27.1302(c)(2))
- (i) Applicants should propose the means that they will use to show that the behaviour of the systems in the proposed design allows the crew members to intervene in the operation of the systems without compromising safety. This should include descriptions of how they will determine that the functions and conditions in which intervention should be possible have been addressed.
 - (ii) The methods proposed by the applicants should describe how they would determine that each means of intervention is appropriate to the task.

(5) Controls for automated systems

Automated systems can perform various tasks selected by and under the supervision of the crew members. Controls should be provided for managing the functionality of such a system or set of systems. The design of such 'automation-specific' controls should enable the crew members to:

- (i) safely prepare the system for the immediate task to be executed or the subsequent task to be executed; preparation of a new task (for example, a new flight trajectory) should not interfere, or be confused, with the task being executed by the automated system;
- (ii) activate the appropriate system function and clearly understand what is being controlled; for example, the crew members must clearly understand that they can set either the vertical speed or the flight path angle when they operate a vertical speed indicator;

CS–27 BOOK 2

(iii) manually intervene in any system function, as required by the operational conditions, or revert to manual control; for example, manual intervention might be necessary if a system loses functions, operates abnormally, or fails.

(6) Displays for automated systems

Automated systems can perform various tasks with minimal crew member intervention, but under the supervision of the crew members. To ensure effective supervision and maintain crew member awareness of the system state and system 'intention' (future states), displays should provide recognisable feedback on:

- (i) the entries made by the crew members into the system so that the crew members can detect and correct errors;
- (ii) the present state of the automated system or its mode of operation (*What is it doing?*);
- (iii) the actions taken by the system to achieve or maintain a desired state (*What is it trying to do?*);
- (iv) future states scheduled by the automation (*What is it going to do next?*); and
- (v) transitions between system states.

(7) The applicant should consider the following aspects of automated system designs:

- (i) Indications of the commanded and actual values should enable the crew members to determine whether the automated systems will perform according to the crew members' expectations;
- (ii) If the automated system nears its operational authority or is operating abnormally for the given conditions, or is unable to perform at the selected level, it should inform the crew members, as appropriate for the task;
- (iii) The automated system should support crew coordination and cooperation by ensuring that there is shared awareness of the system status and the crew members' inputs to the system; and
- (iv) The automated system should enable the crew to review and confirm the accuracy of the commands before they are activated. This is particularly important for automated systems because they can require complex input tasks.

4.5_Crew member error management**(a) Meeting the objective of CS 27.1302(d)**

- (1) CS 27.1302(d) addresses the fact that crews will make errors, even when they are well trained, experienced, rested, and use well-designed systems.

CS 27.1302(d) addresses errors that are design related only. It is not intended to require consideration of errors resulting from acts of violence, sabotage or threats of violence.

- (2) To meet the objective of CS 27.1302(d), the applicant should consider the following:
 - (i) enable the crew members to detect (see 4.5(b)) and recover from errors (see 4.5(c));

CS-27 BOOK 2

- (ii) ensure that the effects of crew errors on the rotorcraft functions or capabilities are evident to the crew members, and continued safe flight and landing is possible (see 4.5(d));
 - (iii) prevent crew errors by using switch guards, interlocks, confirmation actions, or similar means;
 - (iv) preclude the effects of errors through system logic and/or redundant, robust, or fault-tolerant system designs (see 4.5(e)).
- (3) The strategies described in (2) above:
- (i) recognise and assume that crew member errors cannot be entirely prevented, and that no validated methods exist to reliably predict either their probability or all the sequences of events with which they may be associated;
 - (ii) call for means of compliance that are methodical and complementary to, and separate and distinct from, rotorcraft system analysis methods such as system safety assessments.
- (4) When demonstrating compliance, the applicant should consider the crew members' tasks in all operating conditions, considering that many of the same design characteristics are relevant in each case. For example, under abnormal/malfunction or emergency conditions, the flying tasks (navigation, communication and monitoring) are generally still present, although they may be more difficult. So, the tasks associated with the abnormal/malfunction or emergency conditions should be considered as additive. The applicant should not expect the errors considered to be different from those in normal conditions, but any assessment should account for the change in the expected tasks.
- (5) To demonstrate compliance with CS 27.1302(d), the applicant may employ any of the general types of methods of compliance discussed in paragraph 5, individually or in combination. These methods must be consistent with an approved certification plan as discussed in paragraph 3, and account for the objectives above and the considerations described below. When using some of these methods, it may be helpful for some applicants to refer to other references related to understanding the occurrence of errors. Here is a brief summary of those methods and how they can be applied to address crew member error considerations:
- (i) Statement of similarity (paragraph 5.3): A statement of similarity may be used to substantiate that the design has sufficient certification precedent to conclude that the ability of the crew members to manage errors has not significantly changed. Applicants may also use in-service data to identify errors known to commonly occur for similar crew member interfaces or system behaviour. As part of compliance demonstration, the applicant should identify the steps taken in the new design to avoid or mitigate similar errors. However, the absence of in-service events related to a particular design item cannot be considered to be an acceptable means of demonstrating compliance with CS 27.1302.
 - (ii) Design descriptions (paragraph 5.3): Applicants may structure design descriptions and rationales to show how various types of errors are considered in the design and addressed, mitigated or managed. Applicants can also use a description of how the design adheres to an established and valid design philosophy to substantiate that the design enables crews to manage errors.
 - (iii) Calculation and engineering analysis (paragraph 5.3): As one possible means of demonstrating compliance with CS 27.1302(d), an applicant may document the means of error management through the analysis of controls, indications, system behaviour, and related crew member tasks. This would need to be done in

CS-27 BOOK 2

conjunction with an understanding of the potential error opportunities and the means available for the crew members to manage those errors. In most cases, it is not considered feasible to predict the probability of crew member errors with sufficient validity or precision to support a means of compliance. If an applicant chooses to use a quantitative approach, the validity of the approach should be established.

- (iv) Assessments (paragraph 5.3): For compliance purposes, assessments are intended to identify error possibilities that may be considered for mitigation in design or training. In any case, scenario objectives and assumptions should be clearly stated before running the evaluations or tests. In that way, any discrepancy in those expectations can be discussed and explained in the analysis of the results.
- (6) As discussed further in paragraph 5, these evaluations or tests should use appropriate scenarios that reflect the intended functions and tasks, including the use of the equipment in normal, abnormal/malfunction and emergency conditions. Scenarios should be designed to consider crew member errors. If inappropriate scenarios are used or important conditions are not considered, incorrect conclusions can result. For example, if no errors occur during an assessment, it may only mean that the scenarios are too simple, incomplete, or not fully representative. On the other hand, if some errors do occur, it may mean any of the following:
 - (i) The design, procedures, or training should be modified;
 - (ii) The scenarios are unrealistically challenging; or
 - (iii) Insufficient training was delivered prior to the assessment.
- (7) In such assessments, it is not considered feasible to establish criteria for the frequency of errors.
- (b) Error detection
 - (1) Applicants should design equipment to provide information to the crew members so that they can become aware of an error. Applicants should show that this information is available to the crew members, is adequately detectable, and it shows a clear relationship between the crew member action and the error so a recovery can be made in a timely manner.
 - (2) The information for error detection may take three basic forms:
 - (i) Indications provided to the crew members during normal monitoring tasks.
 - (A) As an example, if an incorrect knob was used, resulting in an unintended heading change, the change would be detected through the display of target values. The presentation of a temporary flight plan for crew review before accepting it would be another way of providing crew awareness of errors.
 - (B) Indications on instruments in the primary field of view that are used during normal operations may be adequate if the indications themselves contain information used on a regular basis and are provided in a readily accessible form. These may include mode annunciations and normal rotorcraft state information such as the altitude or heading. Other locations for the information may be appropriate depending on the crew's tasks and the importance of the information, such as on the control display unit when the task involves dealing with a flight plan. Paragraph 5.4 'Presentation of information' contains additional guidance to determine whether the information is adequately detectable.

CS-27 BOOK 2

- (ii) Indications to the crew members that provide information of an error or a resulting rotorcraft system condition.
 - (A) An alert that activates following a crew member error may be sufficient to show an error is detectable and provides sufficient information. The alert should directly relate to the error or be easily assessed by the crew members as related to the error. Alerts should not be confusing leading the crew members to believe there may be non-error causes for the annunciated condition.
 - (B) If a crew member error is only one of several possible causes for an alert about a system, then the information that the alert provides is insufficient. If, on the other hand, additional information is available that would allow the crew to identify and correct the error, then the alert, in combination with the additional information, would be sufficient to comply with CS 27.1302(d) for that error.
 - (C) An error that is detectable by the system should provide an alert and provide sufficient information that a crew member error has occurred, such as in the case of a take-off configuration warning. On the other hand, an alert about the system state resulting from accidentally shutting down a hydraulic pump, for example, may not provide sufficient information to the crew members to enable them to distinguish an error from a system fault. In this case, flight manual procedures may provide the error detection means as the crew performs the 'loss of hydraulic system' procedures.
 - (D) If the system can detect pilot error, the system could be designed to prevent pilot errors. For example, if the system can detect an incorrect frequency entry by the pilot, then the system should be able to disallow that entry and provide appropriate feedback to the pilot. Examples are automated error checking and filters that prevent the entry of unallowable or illogical entries.
 - (iii) 'Global' alerts cover a multitude of possible errors by annunciating external hazards, the envelope of the rotorcraft, or operational conditions. Examples include monitoring systems such as a terrain awareness and warning system (TAWS) and a traffic alert and collision avoidance system (TCAS). An example would be a TAWS alert resulting from turning in the wrong direction in a holding pattern in mountainous terrain.
- (3) The applicant should consider the following when establishing whether the level or type of information available to the crew members is adequately detectable and clearly related to the error:
- (i) The effects of some errors are easily and reliably determined by the system because of its design, and some are not. For those that cannot be sensed by the system, the design and arrangement of the information monitored and scanned by the crew members can facilitate error detection.

An example would be the alignment of engine speed indicator needles in the same direction during normal operations. In the event of an engine asymmetrical thrust linked to crew member error, which manifested itself in a change in the rpm on one engine, the spatial misalignment of the needles could assist the pilots in diagnosing the issue and identifying asymmetrical thrust-lever position.
 - (ii) Rotorcraft alerting and indication systems may not detect whether an action is erroneous because the systems cannot know the intent of the crew in many operational circumstances. For crew member errors of this nature, error detection

CS-27 BOOK 2

depends on the crew's interpretation of the available information. Training, crew resource management (CRM), and monitoring systems (such as TAWS and TCAS) are examples of ways to provide a redundant level of safety.

- (4) The applicant may establish that information is available and clearly related to the error by using a design description when a precedent exists or when a reasonable case may be made that the content of the information is clearly related to the error that caused it. In some cases, a crew member assessment (see 5.3) may be needed to assess whether the information provided is adequately available and detectable.
- (c) Error recovery
- (1) When an error or its effects are detected, the next logical step is to ensure that the error can be reversed, or that the effect of the error can be mitigated in some way so that the rotorcraft is returned to a safe state.
 - (2) An acceptable means to establish that an error is recoverable is to show that:
 - (i) controls and indications exist that can be used either to reverse an erroneous action directly so that the rotorcraft or system is returned to the original state, or to mitigate the effect so that the rotorcraft or system is returned to a safe state; and
 - (ii) those controls and indications can be expected to be used by the crew members to accomplish the corrective actions in a timely manner.
 - (3) For simple or familiar types of system interfaces, or systems that are not novel, even if they are complex, a statement of similarity or a description of the design of the crew member interfaces and the procedures associated with the indications may be an acceptable means of compliance.
 - (4) To establish that the crew members can be expected to use those controls and indications to accomplish corrective actions in a timely manner, an assessment of the crew member procedures in a simulated cockpit environment can be highly effective. This assessment should include an examination of the nomenclature used in alert messages, controls, and other indications. It should also include the logical flow of procedural steps and the effects that executing the procedures have on other systems.
- (d) Error effects
- (1) Another means of satisfying the objective of error mitigation is to ensure that the effects of the error or the relevant effects on the state of the rotorcraft:
 - (i) are evident to the crew; and
 - (ii) do not adversely impact on safety.

CS-27 BOOK 2

- (2) Piloted assessments in the rotorcraft or in simulation may be relevant if crew member performance issues are in question for determining whether a state following an error permits continued safe flight and landing. Assessments and/or analyses may be used to show that, following an error, the crew member has the information in an effective form and has the rotorcraft capability required for continued safe flight and landing.
- (e) Precluding errors or their effects
- (1) For irreversible errors that have potential safety implications, means to prevent errors are recommended. Acceptable ways to prevent errors include switch guards, interlocks, or confirmation actions. For example, generator drive controls on many rotorcraft have guards over the switches to prevent their inadvertent actuation, because once disengaged, the drives cannot be re-engaged while in flight or with the engine running. An example of confirmation action would be the presentation of a flight plan modification in a temporary flight plan, where the crew members will activate the flight plan through a confirmation action.
- (2) Another way of avoiding crew member error is to design systems to remove misleading or inaccurate information (e.g. sensor failures) from displays. An example would be a system that removes the flight director bars from a primary flight display or removes the 'own-ship' position from an airport surface map display when the data driving the symbols is incorrect.
- (3) The applicant should avoid applying an excessive number of protections for a given error. The excessive use of protections could have unintended safety consequences. They might hamper the crew member's ability to use judgment and take action in the best interest of safety in situations that were not predicted by the applicant. If protections become a nuisance in daily operation, crews may use well-intentioned and inventive means to circumvent them. This could have further effects that were not anticipated by the operator or the designer.

4.6_Integration**(a) Introduction**

- (1) Many systems, such as flight management systems (FMSs), are integrated physically and functionally into the cockpit and may interact with other cockpit systems. It is important to consider a design not just in isolation, but in the context of the overall cockpit. Integration issues include where a display or control is installed, how it interacts with other systems, and whether there is internal consistency across functions within a multi-function display, as well as consistency with the rest of the cockpit equipment.
- (2) Analyses, evaluations, tests and other data developed to establish compliance with each of the specific requirements in CS 27.1302(a) to (d) should address the integration of new design items. It should include consideration of the following integration factors:
- (i) consistency (see 4.6(b)),
 - (ii) consistency trade-offs (see 4.6(c)),
 - (iii) the cockpit environment (see 4.6(d)), and
 - (iv) integration-related workload and error (see 4.6(e)).

CS-27 BOOK 2**(b) Consistency**

- (1) If similar information is presented in multiple locations or modes (both visual and auditory, for example), the consistent presentation of the information is desirable. If information cannot be presented consistently within the cockpit, the applicant should show that the differences do not increase the error rates or task times, which would lead to a significant reduction in the safety margins or an increase in the crew members' workload, and do not cause confusion to crew members.
- (2) Consistency needs to be considered within a given system and across the cockpit. Inconsistencies may result in vulnerabilities that may lead to human performance issues, such as increased workload and errors, especially during stressful situations. For example, in some flight management systems (FMSs), the format for entering the latitude and longitude differs between the display pages. This may induce crew member errors, or at least increase the crew's workload. Additionally, errors may result if the latitude and longitude are displayed in a format that differs from the formats used on the most commonly used paper charts. Because of this, it is desirable to use formats that are consistent with other media whenever possible. One way in which the applicant can achieve consistency within a given system, as well as within the overall cockpit, is to adhere to a comprehensive cockpit design philosophy. The following are design attributes to consider for their consistency within and across systems:
 - (i) Symbology, data entry conventions, formatting, the colour philosophy, terminology, and labelling.
 - (ii) Function and logic. For example, when two or more systems are active and perform the same function, they should operate consistently and use an interface in the same style.
 - (iii) Information presented with other information of the same type that is used in the cockpit. It is important that functions that convey the same information be consistent. One example is symbol sets. Traffic or terrain awareness systems should display consistent symbol sets if generated by separate installed systems.
- (3) Another way to demonstrate consistency is to show that certain aspects of the design are consistent with accepted, published standards such as the labels and abbreviations recommended in ICAO Doc 8400 'Procedures for Air Navigation Services (PANS) - ICAO Abbreviations and Codes' or in SAE ARP4105C 'Abbreviations, Acronyms, and Terms for Use on the Flight Deck'. The applicant might standardise the symbols used to depict navigation aids (very high frequency omnidirectional range (VOR), for example), by following the conventions recommended in SAE ARP5289A 'Electronic Aeronautical Symbols'. However, inappropriate standardisation, rigidly applied, can be a barrier to innovation and product improvement. Thus, the guidance in this paragraph promotes consistency rather than rigid standardisation.

(c) Consistency trade-offs

It is recognised that it is not always possible or desirable to provide a consistent crew member interface. Despite conformance with the cockpit design philosophy, principles of consistency, etc., it is possible to negatively impact on the crew's workload. For example, all the auditory alerts may adhere to a cockpit alerting philosophy, but the number of alerts may be unacceptable. The use of a consistent format across the cockpit may not work when individual task requirements necessitate the presentation of data in two significantly different formats. An example is a weather radar display formatted to show a sector of the environment, while a

CS-27 BOOK 2

moving-map display shows a 360-degree view. In such cases, it should be demonstrated that the design of the interface is compatible with the requirements of the piloting task, and that it can be used individually and in combination with other interfaces without interference with either the system or the function.

Additionally:

- (1) The applicant should provide an analysis identifying each piece of information or data presented in multiple locations, and show that the data is presented in a consistent manner or, where that is not true, justify why that is not appropriate.
 - (2) Where information is inconsistent, that inconsistency should be obvious or annunciated, and should not contribute to errors in the interpretation of information.
 - (3) There should be a rationale for instances where the design of a system diverges from the cockpit design philosophy. Applicants should consider any impact on the workload and on errors as a result of such divergences.
 - (4) The applicant should describe what conclusion the crew members are expected to draw and what action should be taken when information on the display conflicts with other information in the cockpit (either with or without a failure).
- (d) Cockpit environment
- (1) The cockpit system is influenced by the physical characteristics of the rotorcraft into which a system is integrated, as well as by the characteristics of the operational environment. The system is subject to such influences on the cockpit as turbulence, noise, ambient light, smoke, and vibrations (such as those that may result from ice or the loss of a fan blade). The design of the system should recognise the effect of such influences on usability, workload, and crew member task performance. Turbulence and ambient light, for example, may affect the readability of a display. Cockpit noise may affect the audibility of aural alerts. The applicant should also consider the impact of the cockpit environment for abnormal situations, such as recovery from an unusual attitude or regaining control of the rotorcraft or system.
 - (2) The cockpit environment includes the layout, or the physical arrangement of the controls and information displays. Layouts should take into account the crew member requirements in terms of:
 - (i) access and reach (to the controls);
 - (ii) visibility and readability of the displays and labels; and
 - (iii) the task-oriented location and grouping of HMI elements.

An example of poor physical integration would be a required piece of information that is obscured by a control in its normal operating position.

CS-27 BOOK 2

- (e) Integration-related workload and error
- (1) When integrating functions and/or equipment, designers should be aware of the potential effects, both positive and negative, that integration can have on the workload of the crew members and its subsequent impact on error management. Systems must be designed and assessed, both in isolation and in combination with other cockpit systems, to ensure that the crew members are able to detect, reverse, or recover from errors. This may be more challenging when integrating systems that employ higher levels of automation or have a high degree of interaction and dependency on other cockpit systems.
 - (2) Applicants should show that the integrated design does not adversely impact on the workload or errors in the context of the entire flight regime. Examples of such impacts would be taking more time to:
 - (i) interpret a function;
 - (ii) make a decision; or
 - (iii) take appropriate action.
 - (3) Controls, particularly multi-function controls and/or novel types of control, may present the potential for misidentification and increased response times. Designs should generally avoid multi-function controls with hidden functions, because they increase both the workload of the crew members and the potential for error.
 - (4) Two examples of integrated design items that may or may not impact on errors and the workload are as follows:
 - (i) Presenting the same information in two different formats. This may increase the workload, such as when altitude information is presented concurrently in both tape and round-dial formats. However, different formats may be suitable, depending on the design and the crew task. For example, an analogue display of engine revolutions per minute (rpm) can facilitate a quick scan, whereas a digital numeric display can facilitate precise inputs. The applicant is responsible for demonstrating compliance with CS 27.1523 and showing that the differences in the formats do not result in unacceptable levels of workload.
 - (ii) Presenting conflicting information. Increases in workload and error may result from two displays depicting conflicting altitude information on the cockpit concurrently, regardless of the formats. Systems may exhibit minor differences between each crew member station, but all such differences should be assessed specifically to ensure that the potential for interpretation error is minimised, or that a method exists for the crew members to detect any incorrect information, or that the effects of these errors can be precluded.

CS-27 BOOK 2

- (iii) The applicant should show that the proposed function will not inappropriately draw attention away from other cockpit information and tasks in a way that degrades the performance of the crew members and decreases the overall level of safety. There are some cases in which it may be acceptable for the system design to increase the workload. For example, adding a display into the cockpit may increase the workload by virtue of the additional time crew members spend looking at it, but the safety benefit that the additional information provides may make it an acceptable trade-off.

- (iv) Since each new system integrated into the cockpit may have a positive or negative effect on the workload, each must be assessed in isolation and in combination with the other systems for compliance with CS 27.1523. This is to ensure that the overall workload is acceptable, i.e. that the performance of flight tasks is not adversely impacted, and that the crew's detection and interpretation of information does not lead to unacceptable response times. Special attention should be paid to items that are workload factors. They include the 'accessibility, ease, and simplicity of operation of all necessary flight, power, and equipment controls'.

CS–27 BOOK 2

5)_MEANS OF COMPLIANCE

5.1_Overview

This paragraph provides considerations the applicant should use when selecting the means of compliance. It discusses seven types of means of compliance and provides specific HF considerations for their use.

The applicant should determine the means of compliance to be used on a given project on a case-by-case basis, taking into account the specific compliance issues. In any case, the nature of the HF objective to be assessed should drive the selection of the appropriate means of compliance.

Some certification projects may necessitate more than one means of demonstrating compliance with a particular CS. For example, when flight testing in a conforming rotorcraft is not possible, a combination of a design review and a part-task evaluation may be proposed. In this context, part-task evaluation focuses only on specific sub-functions of the design item.

The uses and limitations of each type of means of compliance are provided in paragraph 5.3.

5.2_List of the means of compliance

The most common means of compliance that are used to demonstrate compliance with HF certification specifications are discussed in this paragraph and include:

- (a) MC0: Compliance statements,
- (b) MC1: Design review,
- (c) MC2: Calculations and analyses,
- (d) MC4: Laboratory tests,
- (e) MC5: Ground tests,
- (f) MC6: Flight tests,
- (g) MC8: Simulation.

When the ‘scenario-based’ methodology is used as part of the above-listed means of compliance, additional guidance can be found in paragraph 3.3.2.

5.3_Selecting the means of compliance

5.3.1_Credit from previous compliance certification processes

When determining the level of scrutiny applicable to each design item, the applicant should identify a reference product.

The reference product can also play a role in the compliance demonstration process if data from previous certification exercises is used. However, the following two dimensions should be taken into account when assessing the extent to which certification credits can be granted:

- The reference product from which the applicant intends to claim compliance;
- The certification basis that was used to certify that reference product.

The applicant is then expected to gain more certification credits from the equipment installed on one of its rotorcraft already certified under CS 27/29.1302.

CS-27 BOOK 2

Fewer certification credits can be requested when the equipment installed on a rotorcraft was certified by the applicant under a HF's regulatory material different from CS 27.1302. The acceptability of this approach will be evaluated on a case-by-case basis by assessing the compatibility of the reference regulatory material and the methods used at the time of the initial certification.

As a general principle, no certification credit can be claimed when the design item installed on a rotorcraft was certified by another design organisation or when it was not certified by EASA. However, in accordance with 3.3.1(d), the applicant might take credit for the activities carried out by an equipment supplier that performed certain HF's assessments on a voluntary basis.

5.3.2_Representativeness of the test article

Means of compliance MC4, MC5, MC6 and MC8 require the use of a test article (benches, mock-ups, the actual rotorcraft, or a simulator).

As explained in paragraph 3.3.1, in order to achieve its objectives, the HF's assessment should be started in the early stage of the project and follow an iterative process. This iterative nature of the process may require the applicant to perform assessments in the early stage of the project when the design is still likely to change. On the other hand, test articles that are not fully representative of the final design can be available later on during the certification process and may be the only available ones to actually perform some assessments (for example, a bench or a simulator may be the only means to assess the behaviour for failures that cannot be simulated in flight).

Therefore, the verification of the test article's representativeness, with its deviations from the intended final standard, is a step of paramount importance for the HF's assessment. These deviations should be evaluated taking into account the objectives of the assessment.

For example:

- If a ground test is carried out to assess the controls reachability, specific attention should be paid at the cockpit geometry being representative of the design under certification while the conformity of the avionics is not required.
- If a simulator is used, the required functional and physical representativeness of the simulation (or degree of realism) will typically depend on the configurations, design items, and crew tasks to be assessed.

As a general principle, as long as the deviations from the intended final standard are known and monitored and do not compromise the validity of the data to be collected, the lack of full representativeness should not prevent the use of a test article. In such cases, partial certification credits may still be granted, provided that the applicant can show that the deviations do not affect the test results.

CS-27 BOOK 2

5.3.3 Presentation of the means of compliance

(a) MC0 Compliance statement based on similarity

| Description |
|---|
| A statement of similarity is a declaration of (full or partial) compliance based on a description of the system to be approved compared to a description of a previously approved system, detailing the physical, logical, and operational similarities relevant for the regulation the applicant wishes to demonstrate compliance with. |
| Use |
| A statement of similarity can be sufficient or used in combination with other means of compliance. |
| Limitations |
| A statement of similarity, for the purpose of compliance demonstration, should be used with care. The cockpit should be assessed as a whole, not merely as a set of individual functions or systems. Two design items previously approved on separate programmes may be incompatible when combined in a single cockpit. Also, changing one feature in the cockpit may necessitate corresponding changes in other features, to maintain consistency and prevent confusion. |
| Example |
| If the window design in a new rotorcraft is identical to that in an existing rotorcraft, a statement of similarity may be an acceptable means of compliance to meet CS 27.773. |

(b) MC1 Design review

The applicant may elect to substantiate that the design meets the objectives of a specific paragraph by describing the design. The applicant has traditionally used drawings, configuration descriptions, and/or design philosophies to demonstrate compliance.

(1) Drawings

| Description |
|---|
| Drawings depicting the physical arrangement of hardware or display graphics. |
| Use |
| Applicants can use drawings for very simple certification programmes when the change to the cockpit is very simple and straightforward. Drawings can also be used to support compliance findings for more complex interfaces. |
| Limitations |
| The use of drawings is limited to physical arrangements and graphical concerns. |

(2) Configuration description

| Description |
|---|
| A configuration description is a description of the layout, general arrangement, direction of movement, etc., of a design item. It can also be a reference to documentation that provides such a description. It could be used to show the relative locations of flight instruments, groupings of |

CS-27 BOOK 2

| |
|--|
| control functions, the allocation of colour codes to displays and alerts, etc. |
| Use |
| Configuration descriptions are generally less formalised than engineering drawings. They are developed to point out features of the design that support a finding of compliance. In some cases, such configuration descriptions may provide sufficient information for a finding of compliance. More often, however, they provide important background information, while the final confirmation of compliance is found through other means, such as demonstrations or tests. The background information provided by configuration descriptions may significantly reduce the risk associated with demonstrations or tests. The applicant will have already communicated how a system works with the configuration description, and any discussions or assumptions may have already been coordinated. |
| Limitations |
| Configuration descriptions may provide sufficient information for a finding of compliance only with a specific requirement. |

(3) Design philosophy

| |
|--|
| Description |
| A design philosophy approach can be used to demonstrate that an overall safety-centred philosophy, as detailed in the design specifications for the product/system or cockpit, has been applied. |
| Use |
| It documents that the design qualifies to meet the objectives of a specific paragraph. |
| Limitations |
| In most cases, this means of compliance will be insufficient as the sole means to demonstrate compliance. |
| Example |
| The design philosophy may be used as a means of compliance when a new alert is added to the cockpit provided the new alert is consistent with the acceptable, existing alerting philosophy. |

(c) MC2 Calculations/analyses

| |
|---|
| Description |
| Calculations or engineering analyses ('paper and pencil' assessments) that do not require direct participant interaction with a physical representation of the equipment. |
| Use |
| Provides a systematic analysis of specific or overall aspects of the human interface part of the product/system/cockpit. |
| Limitations |
| The applicant should carefully consider the validity of the assessment technique if the analyses are not based on recognised industry standard methods. The applicant may be asked to validate any computational tools used in such analyses. If the analysis involves comparing measured |

CS-27 BOOK 2

characteristics with recommendations derived from pre-existing research (internal or public domain), the applicant may be asked to justify the applicability of the data to the project. While analyses are useful to start investigating the potential for design-related human errors, as well as the theoretical efficiency of the available means of protection, this demonstration should be complemented by observations through other means of compliance when required.

Analysis cannot be used to assess complex cognitive issues.

Example

An applicant may conduct a vision analysis to demonstrate that the crew member has a clear and undistorted view out of the windshield. Similarly, an analysis may also demonstrate that flight, navigation and power plant instruments are plainly visible from the crew member stations. The applicant may need to validate the results of the analysis in a ground or flight test, or by using a means of simulation that is geometrically representative. An applicant may also conduct an analysis based on evidence collected during similar previous HFs assessments.

(d) MC4 Laboratory tests

Description

An assessment made using a bench test representing the HMI. This can be conducted on an avionics bench when the purpose is to assess the information, or on a mock-up when the purpose is to assess the cockpit geometry.

Bench or laboratory assessment

The applicant can conduct an assessment using devices emulating crew member interfaces for a single system or a group of related systems. The applicant can use flight hardware, simulated systems, or combinations of these.

Example of a bench or laboratory assessment

A bench assessment for an integrated system could be conducted using an avionics suite installed in a mock-up of a cockpit, with the main displays and autopilot controls included. Such a tool may be valuable during development and for making EASA familiar with the system. However, in a highly integrated architecture, it may be difficult or impossible to assess how well the avionics system will fit into the overall cockpit without more complete simulation or use of the actual rotorcraft.

Mock-up evaluation

A mock-up is a full-scale, static representation of the physical configuration (form and fit). It does not include functional aspects of the cockpit and its installed equipment.

Mock-ups can be used as representations of the design, allowing participants to physically interact with the design. Three-dimensional representations of the design in a CAD system, in conjunction with three-dimensional models of the cockpit occupants, have also been used as 'virtual' mock-ups for certain limited types of evaluations. Reachability, for example, can be addressed using either type of mock-up.

Example of a mock-up evaluation

An analysis to demonstrate that the controls are arranged so that crew members from 1.57 m (5 ft 2 in) to 1.83 m (6 ft) in height can reach all controls. This analysis may use computer-generated data based on engineering drawings. The applicant may demonstrate the results of the analysis in the actual rotorcraft.

CS-27 BOOK 2

| Limitations |
|--|
| Bench tests or mock-ups cannot be used to assess complex cognitive issues. |

(e) MC5 Ground tests

| Description |
|---|
| An assessment conducted on a flight test article on ground. |
| Limitations |
| Ground tests cannot be used to assess complex cognitive issues. |
| Example |
| An example of a ground test is the assessment of the displays' potential for reflections on the windshield and on the windows. Such an assessment involves covering the cockpit windows to simulate darkness and setting the cockpit lighting to the desired levels. This particular assessment may not be possible in a simulator because of differences in the light sources, display hardware, and/or construction of the windows. |

(f) MC6 Flight tests and MC8 Simulation

The applicant may use a wide variety of part-task to full-installation representations of the product/system or cockpit for assessment purposes. The representation of the HMI does not necessarily conform to the final design. The paragraphs below address both system- and rotorcraft-level evaluations that typically make up this group of means of compliance.

| Description |
|--|
| As soon as the maturity of the design allows pilots to take part in the compliance demonstration, HFs assessments are conducted in a dynamic operational context. Depending on the HFs objectives to be addressed, and according to the HFs test programme, those assessments can be either conducted at the system level or the rotorcraft level. Both simulators and real rotorcraft can be used, but the selection of the MoC depends on the nature of the test objectives. |
| Use |
| Traditionally, these types of activities are part of the design process. They allow applicants to continuously improve their designs thanks to the application of an iterative approach. |

(f)(i) MC8 Simulation

| Simulator assessment |
|--|
| A simulator assessment uses devices that present an integrated emulation (using flight hardware, simulated systems, or combinations of these) of the cockpit and the operational environment. These devices can also be 'flown' with response characteristics that replicate, to some extent, the responses of the rotorcraft. |

CS-27 BOOK 2

(f)(ii) MC6 Flight tests

In-flight assessment

Flight testing during certification is the final compliance demonstration of the design, and is conducted in a conforming rotorcraft during flight. The rotorcraft and its components (cockpit) are the most representative of the type design to be certified and will be the closest to real operations of the equipment. In-flight testing is the most realistic testing environment, although it is limited to those tests that can be conducted safely. Flight testing can be used to validate and verify other assessments previously conducted during the development and certification programme. It is often best to use flight testing as the final confirmation of data collected using other means of compliance, including analyses and assessments.

Flights tests carried out for areas of investigation outside the HFs scope can be given partial credit for demonstrating compliance with 27.1302. The acceptability of this approach has, however, to be assessed by EASA on a case-by-case basis. A prerequisite for acceptance by EASA is the respect of the basic HFs methodical principles for data collection and processing. These flight tests should only be used as a complementary approach to dedicated HFs assessments.

(f)(iii) MC6 versus MC8

MC6 versus MC8:

The selection of the flight test as a means of assessment should not be exclusively motivated by the absence of any other available means, but should be duly justified, taking into account its inherent limitations:

- Due to safety reasons, the actual testing on a rotorcraft may be inappropriate for the malfunction assessment.
- Flight test does not normally allow the manipulation of the operational environment which may be needed to apply the scenario-based approach.
- HFs in-flight scenarios may be challenging to replicate due to the difficulty in reproducing the operational context. For example, events like ATC communications, weather, etc., which are expected to trigger a crew reaction to be tested may not be repeatable. This may hamper the collection of homogeneous data and may adversely affect its validity.

However, flight test is deemed adequate when the operational and/or system representativeness is a key driver for the validity of HFs data. For example, an in-flight assessment is typically more adequate when dealing with workload determination.

CS-27 BOOK 2**AMC 27.1302 APPENDIX 1: Related regulatory material and documents**

EASA AMC:

- AC 27-1B Change 7 MG-19 *Electronic Display Systems* and MG-20 *Human Factors*
- PS-ANM100-01-03A, *Factors to Consider When Reviewing an Applicant's Proposed Human Factors Methods for Compliance for Flight Deck Certification*

Other documents:

The following is a list of other documents relevant to cockpit design and crew member interfaces that may be useful when applying this AMC. Some are not aviation specific, such as International Standard ISO 9241-4, which, however, provides useful guidance. When using that document, applicants should consider environmental factors such as the intended operational environment, turbulence, and lighting, as well as cross-side reach.

- Policy Memo ANM-99-2, *Guidance for Reviewing Certification Plans to Address Human Factors for Certification of Transport Airplane Flight Decks*
- AMC 25-11, *Electronic Flight Deck Displays*, November 2018
- SAE ARP4033, *Pilot-System Integration*, August 1995
- SAE ARP5289A, *Electronic Aeronautical Symbols*
- SAE ARP4102/7, *Electronic Displays*
- SAE ARP4105C, *Abbreviations, Acronyms, and Terms for Use on the Flight Deck*
- ICAO Doc 8400, *Procedures for Air Navigation Services — ICAO Abbreviations and Codes*, Ninth Edition, 2016
- ICAO Doc 9683 – AN/950, *Human Factors Training Manual*, First Edition, 1998
- International Standards ISO 9241-4, *Ergonomic Requirements for Office Work with Visual Display Terminals (VDTs)*
- FAA Human Factors Team report on: *The Interfaces Between Flight crews and Modern Flight Deck Systems*, 1996
- DOT/FAA/RD-93/5: *Human Factors for Flight Deck Certification Personnel*, 1993
- FAA AC 20-175 *Controls for Flight Deck Systems*, 2011
- FAA AC 00-74 *Avionics Human Factors Considerations for Design and Evaluation*, 2019
- DOT/FAA/TC-13/44 *Human Factors Considerations in the Design and Evaluation of Flight Deck Displays and Controls*, 2016

CS–27 BOOK 2**GM1 27.1302 Explanatory material****1_Introduction**

- (a) Accidents most often result from a sequence or combination of different errors and safety-related events (e.g. equipment failures and weather conditions). Analyses show that the design of the cockpit and other systems can influence the crew's task performance and the occurrence and effects of some crew member errors.
- (b) Crew members make a positive contribution to the safety of the aviation system because of their ability to continuously assess changing conditions and situations, analyse potential actions, and make reasoned decisions. However, even well-trained, qualified, healthy, alert crew members make errors. Some of these errors may be induced or influenced by the designs of the systems and their crew interfaces, even with those that are carefully designed. Most of these errors have no significant safety effects, or are detected and mitigated in the normal course of events. However, some of them may lead or contribute to the occurrence of unsafe conditions. Accident analyses have identified crew member performance and errors as recurrent factors in the majority of accidents involving rotorcraft.
- (c) Some current requirements are intended to improve safety by requiring the cockpit and its equipment to be designed with certain capabilities and characteristics. The approval of cockpit systems with respect to design-related crew member error has typically been addressed by referring to system-specific or general applicability requirements, such as CS 27.1301(a), CS 27.771(a), and CS 27.1523. However, little or no guidance exists to show how the applicant may address potential crew member limitations and errors. That is why CS 27.1302 and this guidance material have been developed.
- (d) CS 27.1302 was developed to provide a basis for addressing the design-related aspects of the avoidance and management of crew member errors by taking the following approach.
 - (i) Firstly, by providing means to address the design characteristics that are known to reduce or avoid crew member error and that address crew member capabilities and limitations. CS 27.1302(a) to (c) are intended to reduce the design contribution to such errors by ensuring that the information and controls needed by the crew members to perform the tasks associated with the intended function of installed equipment are provided, and that they are provided in a usable form.

In addition, operationally relevant system behaviour must be understandable, predictable, and supportive of the crew's tasks. Guidance is provided in this paragraph on the avoidance of design-induced crew member errors.
 - (ii) Secondly, CS 27.1302(d) addresses the fact that since crew member errors will occur, even with a well-trained and proficient crew operating well-designed systems, the design must support the management of those errors to avoid any safety consequences. Paragraph 5.7 below on crew member error management provides the relevant guidance.
- (e) EASA would like to bring the applicants' attention to the fact that the implementation of the CS 27.1302 process may require up to several years, depending on the characteristics of the project. However, STCs may require much less time.

CS-27 BOOK 2**2_CS 27.1302: applicability and explanatory material**

- (a) CS-27 contains certification specifications for the design of cockpit equipment that is system specific (refer to AMC 27.1302, Table 1, in paragraph 2), generally applicable (e.g. CS 27.1301(a), CS 27.771(a)), and establishes minimum crew requirements (e.g. CS 27.1523). CS 27.1302 complements the generally applicable requirements by adding more explicit objectives for the design attributes related to the avoidance and management of crew member errors. Other ways to avoid and manage crew member errors are regulated through the requirements governing the licensing and qualifications of crew members and rotorcraft operations. Taken together, these complementary approaches provide an adequate level of safety.
- (b) The complementary approach is important. It is based upon the recognition that equipment design, training/licensing/qualifications and operations/procedures each provide safety contributions to risk mitigation. An appropriate balance is needed between them. There have been cases in the past where design characteristics known to contribute to crew member errors were accepted based upon the rationale that training or procedures would mitigate that risk. We now know that this can often be an inappropriate approach. Similarly, due to unintended consequences, it would not be appropriate to require equipment design to provide total risk mitigation.
- (c) A proper balance is needed between certification specifications in CS-27 and the requirements for training/licensing/qualifications and operations/procedures. CS 27.1302 and this GM were developed with the intent of achieving that appropriate balance.
- (1) Introduction. The introductory sentence of CS 27.1302 states that ‘this paragraph applies to installed systems and equipment intended to be used by the crew members when operating the rotorcraft from their normal seating positions in the cockpit or their operating positions in the cabin’.
- (i) ‘Intended to be used by the crew members when operating the rotorcraft from their normal seating positions in the cockpit or their operating positions in the cabin’ means that the intended function of the installed equipment includes its use by the crew members when operating the rotorcraft. An example of such installed equipment would be a display that provides information enabling the crew to navigate. The term ‘crew members’ is intended to include any or all individuals comprising the minimum crew as determined for compliance with CS 27.1523. The phrase ‘from their normal seating positions in the cockpit’ means that the crew members are seated at their normal duty stations for operating the rotorcraft.
- (ii) The phrase ‘from their normal seating positions in the cockpit or their operating positions in the cabin’ means that the crew members are positioned at their normal duty stations in the cabin. These phrases are intended to limit the scope of this requirement so that it does not address the systems or equipment that are/is not used by the crew members while performing their duties in operating the rotorcraft in normal, abnormal/malfunction and emergency conditions. For example, this paragraph is not intended to apply to design items such as certain circuit breakers or maintenance controls intended for use by the maintenance crew (or by the crew when not operating the rotorcraft).
- (iii) The phrase ‘The installed systems and equipment must be shown [...]’ in the first paragraph means that the applicant must provide sufficient evidence to support compliance determinations for each of the CS 27.1302 objectives. This is not intended to require a demonstration of compliance beyond that required by point 21.A.21(a) of Part 21. Accordingly, for simple design items or items similar to

CS-27 BOOK 2

previously approved equipment and installations, the demonstrations, assessments or data needed to demonstrate compliance with CS 27.1302 are not expected to entail more extensive or onerous efforts than are necessary to demonstrate compliance with the previous requirements.

- (iv) The phrase ‘individually and in combination with other such equipment’ means that the objectives of this paragraph must be met when equipment is installed in the cockpit with other equipment. The installed equipment must not prevent other equipment from complying with these objectives. For example, applicants must not design a display so that the information it provides is inconsistent or is in conflict with information provided from other installed equipment.
 - (v) In addition, this paragraph presumes a qualified crew member that is trained to use the installed equipment. This means that the design must meet these objectives for crew members who are allowed to fly the rotorcraft by meeting the qualification requirements of the operating rules. If the applicant seeks a type design or supplemental type design approval before a training programme is accepted, the applicant should document any novel, complex or highly integrated design items and assumptions made during the design phase that have the potential to affect the training time or the crew member procedures. The certification specification and associated material are written assuming that either these design items and assumptions or the knowledge of a training programme (proposed or in the process of being developed) will be coordinated with the appropriate operational approval organisation when assessing the adequacy of the design.
 - (vi) The objective for the equipment to be designed so that the crew members can safely perform their tasks associated with the intended function of the equipment applies in normal, abnormal/malfunction and emergency conditions. The tasks intended to be performed under all the above conditions are generally those prescribed by the crew member procedures. The phrase ‘safely perform their tasks’ is intended to describe one of the safety objectives of this certification specification. The objective is for the equipment design to enable the crew members to perform their tasks with sufficient accuracy and in a timely manner, without unduly interfering with their other required tasks. The phrase ‘tasks associated with its intended function’ is intended to characterise either the tasks required to operate the equipment or the tasks for which the intended function of the equipment provides support.
- (2) **CS 27.1302(a)** requires the applicant to install the appropriate controls and provide the necessary information for any cockpit equipment identified in the first paragraph of CS 27.1302. The controls and the information displays must be sufficient to allow the crew members to accomplish their tasks. Although this may seem obvious, this objective is included because a review of CS-27 on the subject of HFs revealed that a specific objective for cockpit controls and information to meet the crew member needs is necessary. This objective is not reflected in other parts of the rules, so it is important to be explicit.
- (3) **CS 27.1302(b)** addresses the objective for cockpit controls and information that are/is necessary and appropriate for the crew members to accomplish their tasks, as determined in (a) above. The intent is to ensure that the design of the controls and information devices makes them usable by the crew members. This subparagraph seeks to reduce design-induced crew member errors by imposing design objectives for cockpit information presentation and controls. Subparagraphs (1) through (3) specify these design objectives. The design objectives for information and controls are necessary to:

CS–27 BOOK 2

- (i) properly support the crew members in planning their tasks;
 - (ii) make available to the crew members appropriate, effective means to carry out planned actions; and
 - (iii) enable the crew members to have appropriate feedback information about the effects of their actions on the rotorcraft.
- (4) **CS 27.1302(b)(1)** specifically requires controls and information to be designed in a clear and unambiguous form, at a resolution and precision appropriate to the task.
- (i) As applied to information, ‘clear and unambiguous’ means that it can be perceived correctly (is legible) and can be comprehended in the context of the crew member tasks associated with the intended functions of the equipment, such that the crew members can perform all the associated tasks.
 - (ii) For controls, the objective for ‘clear and unambiguous’ presentation means that the crew members must be able to use them appropriately to achieve the intended functions of the equipment. The general intent is to foster the design of equipment controls whose operation is intuitive, consistent with the effects on the parameters or states that they affect, and compatible with the operation of the other controls in the cockpit.
 - (iii) 27.1302(b)(1) also requires the information or control to be provided, or to operate, at a level of detail and accuracy appropriate for accomplishing the task. Insufficient resolution or precision would mean the crew members could not perform the task adequately. Conversely, excessive resolution has the potential to make a task too difficult because of poor readability or the implication that the task should be accomplished more precisely than is actually necessary.
- (5) **CS 27.1302(b)(2)** requires controls and information to be accessible and usable by the crew members in a manner appropriate to the urgency, frequency, and duration of their tasks. For example, controls that are used more frequently or urgently must be readily accessible, or require fewer steps or actions to perform the task. Less accessible controls may be acceptable if they are needed less frequently or less urgently. Controls that are used less frequently or less urgently should not interfere with those used more urgently or more frequently. Similarly, tasks requiring a longer time for interaction should not interfere with the accessibility to information required for urgent or frequent tasks.
- (6) **CS 27.1302(b)(3)** requires equipment to present information that makes the crew members aware of the effects of their actions on the rotorcraft or systems, if that awareness is required for the safe operation of the rotorcraft. The intent is for the crew members to be aware of the system or rotorcraft states resulting from crew actions, permitting them to detect and correct their own errors. This subparagraph is included because new technology enables new kinds of crew member interfaces that previous objectives did not address. Specific deficiencies of existing objectives in addressing HFs are described below:
- (i) CS 27.771(a) addresses this topic for controls, but does not include criteria for the presentation of information;
 - (ii) CS 27.777(a) addresses controls, but only their location;
 - (iii) CS 27.777(b) and CS 25.779 address the direction of motion and actuation but do not encompass new types of controls, such as cursor-control devices. These

CS–27 BOOK 2

requirements also do not encompass types of control interfaces that can be incorporated into displays via menus, for example, thus affecting their accessibility;

- (iv) CS 27.1523 has a different context and purpose (determining the minimum crew), so it does not address these requirements in a sufficiently general way.
- (7) **CS 27.1302(c)** requires installed equipment to be designed so that its behaviour that is operationally relevant to crew member tasks is:
 - (i) predictable and unambiguous, and
 - (ii) designed to enable the crew members to intervene in a manner appropriate to the task (and intended function).

Other related considerations are the following:

- (iii) Improved cockpit technologies involving integrated and complex information and control systems have increased safety and performance. However, they have also introduced the need to ensure proper interactions between the crew and those systems. In-service experience has shown that some equipment behaviour (especially from automated systems) is excessively complex or dependent upon logical states or mode transitions that are not well understood or expected by the crew members. Such design characteristics can confuse the crew members and have been determined to contribute to incidents and accidents.
- (8) **CS 27.1302(c)(1)** requires the behaviour of a system to be such that a qualified crew member knows what the system is doing and why it is doing it. It requires operationally relevant system behaviour to be 'predictable and unambiguous'. This means that a crew can retain enough information about what their action or a changing situation will cause the system to do under foreseeable circumstances, so they can operate the system safely.

The behaviour of a system must be unambiguous because the actions of the crew may have different effects on the rotorcraft, depending on its current state or operational circumstances.

- (9) **CS 27.1302(c)(2)** requires the design to be such that the crew members will be able to take some action, or change or alter an input to the system, in a manner appropriate to the task.
- (10) **CS 27.1302(d)** addresses the reality that even well-trained, proficient crews using well-designed systems will make errors. It requires the equipment to be designed such in order to enable the crew members to manage such errors. For the purpose of this CS, errors 'resulting from crew interaction with the equipment' are those errors that are in some way attributable, or related, to the design of the controls, the behaviour of the equipment, or the information presented. Examples of designs or information that could cause errors are indications and controls that are complex and inconsistent with each other or with other systems on the cockpit. Another example is a procedure that is inconsistent with the design of the equipment. Such errors are considered to be within the scope of this CS and the related AMC.
 - (i) What is meant by a design which enables the crew members to 'manage errors' is that:

CS-27 BOOK 2

- (A) the crew members must be able to detect and/or recover from errors resulting from their interaction with the equipment; or
 - (B) the effects of such crew member errors on the rotorcraft functions or capabilities must be evident to the crew members, and continued safe flight and landing must be possible; or
 - (C) crew member errors must be prevented by switch guards, interlocks, confirmation actions, or other effective means; or
 - (D) the effects of errors must be precluded by system logic or redundant, robust, or fault-tolerant system design.
- (ii) The objective to manage errors applies to those errors that can be reasonably expected in service from qualified and trained crews. The term 'reasonably expected in service' means errors that have occurred in service with similar or comparable equipment. It also means errors that can be predicted to occur based on general experience and knowledge of human performance capabilities and limitations related to the use of the type of controls, information, or system logic being assessed.
- (iii) CS 27.1302(d) includes the following statement: 'This subparagraph does not apply to skill-related errors associated with the manual control of the rotorcraft.' That statement is intended to exclude errors resulting from the crew's proficiency in the control of the flight path and attitude with the primary roll, pitch, yaw and thrust controls, and which are related to the design of the flight control systems. These issues are considered to be adequately addressed by the existing certification specifications, such as CS-27 Subpart B and CS 27.671(a). It is not intended that the design should be required to compensate for deficiencies in crew training or experience. This assumes at least the minimum crew requirements for the intended operation, as discussed at the beginning of paragraph 5.1 above.
- (iv) This objective is intended to exclude the management of errors resulting from crew member decisions, acts or omissions that are not in good faith. It is intended to avoid imposing requirements on the design to accommodate errors committed with malicious or purely contrary intent. CS 27.1302 is not intended to require applicants to consider errors resulting from acts of violence or threats of violence.

This 'good faith' exclusion is also intended to avoid imposing requirements on designs to accommodate errors due to a crew member's obvious disregard for safety. However, it is recognised that errors committed intentionally may still be in good faith, but could be influenced by the characteristics of the design under certain circumstances. An example would be a poorly designed procedure that is not compatible with the controls or information provided to the crew members.

Imposing requirements without considering their economic feasibility or the commensurate safety benefits should be avoided. Operational practicability should also be addressed, such as the need to avoid introducing error management features into the design that would inappropriately impede crew actions or decisions in normal, abnormal/malfunction and emergency conditions. For example, it is not intended to require so many guards or interlocks on the means to shut down an engine that the crew members would be unable to do this reliably within the available time. Similarly, it is not intended to reduce the authority or

CS-27 BOOK 2

means for the crew to intervene or carry out an action when it is their responsibility to do so using their best judgment in good faith.

This subparagraph is included because managing errors (which can be reasonably expected in service) that result from crew member interactions with the equipment is an important safety objective. Even though the scope of applicability of this material is limited to errors for which there is a contribution from or a relationship to the design, CS 27.1302(d) is expected to result in design changes that will contribute to safety. One example, among others, would be the use of 'undo' functions in certain designs.

CS–27 BOOK 2

GM2 27.1302 Examples of compliance matrices

The compliance matrix developed by the applicant should provide the essential information in order to understand the relationship between the following elements:

- the design items,
- the applicable certification specifications,
- the test objectives,
- the means of compliance, and
- the deliverables.

The two matrices below are provided as examples only. The applicant might present the necessary information through any format that meets the above objectives.

An example with a *design item* entry:

| Function | Sub-function | Focus | CS reference | CS description | Assessed dimension | MoC | Reference to the related deliverable |
|-------------------------------------|------------------------------------|---|--------------|--|--|--|---|
| Electronic checklist (ECL) function | Display electronic checklist (ECL) | Electronic checklist quick access keys (ECL QAKs) | CS 79.777(a) | The cockpit controls must be: (a) located so in order to provide convenient operation and to prevent confusion and inadvertent operation; | Assess the ECL QAKs location for convenient operation and prevention of inadvertent operation. | MoC8 HFs campaign #2 Scenario #4 | HFs Test Report XXX123 |
| | | | CS27.777(b) | The cockpit controls must be: (b) located and arranged with respect to the pilot seats so that there is full and unrestricted movement of each control without interference from the cockpit structure or the pilot clothing when pilots from 1.57 m (5ft 2in) to 1.83 m (6 ft) in height are seated. | Assess accessibility to control the ECL QAKs. | MoC4 HFs Reachability Analysis MoC5 HFs Reachability and Accessibility Campaign | HFs Reachability and Accessibility Assessment Report XXX123 |
| | | | [...] | [...] | [...] | [...] | [...] |

CS-27 BOOK 2

| Function | Sub-function | Focus | CS reference | CS description | Assessed dimension | MoC | Reference to the related deliverable |
|----------|--------------|-------|------------------|---|--|---|--|
| | | | CS 27.1302(a) | All the controls and information necessary to accomplish these tasks must be provided; | Assess that appropriate controls are provided in order to display ECL. | MoC1 ECL implementation description for XXXX | ECL implementation description document for XXXX |
| | | | CS 27.1302(b)(1) | (b) All the controls and information required by paragraph (a), which are intended for use by the crew members, must: (1) be presented in a clear and unambiguous form, at a resolution and with a precision appropriate to the task; | Assess the appropriateness of the ECL QAKs labels. | MoC8 HFs campaign #4 Scenario #1 | HFs Test Report XXX345 |

CS-27 BOOK 2

Another example with a *certification specification* entry:

| CS reference | CS description | Focus | Assessed dimension | MoC | Reference to the related deliverable |
|------------------|--|----------------------|--|--|--|
| CS 27.777(a) | The cockpit controls must be: (a) Located so in order to provide convenient operation and to prevent confusion and inadvertent operation; | All cockpit controls | Assess the locations of all cockpit controls for convenient operation and prevention of inadvertent operation. | MoC8 All HFs simulator evaluations | HFs Test Reports XXX123 XXX456 XXX789 |
| | | ECL QAKs | Assess the location of the ECL QAKs for convenient operation and prevention of inadvertent operation. | MoC8 HFs campaign #2 Scenario #4 | HFs Test Report XXX123 |
| CS 27.777(b) | The cockpit controls must be: (b) located and arranged with respect to the pilot seats so that there is full and unrestricted movement of each control without interference from the cockpit structure or the pilot clothing when pilots from 1.57 m (5ft 2in) to 1.83 m (6ft) in height are seated. | All cockpit controls | Assess the accessibility of all cockpit controls. | MoC4 HFs Reachability Analysis MoC5 HFs Reachability and Accessibility Campaign | HFs Reachability and Accessibility Assessment Report XXX123 |
| | | ECL QAKs | Assess the accessibility to control the ECL QAKs. | MoC4 HFs Reachability Analysis MoC5 HFs Reachability and Accessibility Campaign | HFs Reachability and Accessibility Assessment Report XXX123 |
| [...] | [...] | | | | |
| CS 27.1302(a) | All the controls and information necessary to accomplish these tasks must be provided; | | | | |
| CS 27.1302(b)(1) | (b) All the controls and information required by paragraph (a), which are intended for use by the crew members, must: (1) be presented in a clear and unambiguous form, at a resolution and with a precision | | | | |

CS-27 BOOK 2

| CS reference | CS description | Focus | Assessed dimension | MoC | Reference to the related deliverable |
|--------------|--------------------------|-------|--------------------|-----|--------------------------------------|
| | appropriate to the task; | | | | |

[Amdt No: 27/8]

AMC 27.1319 Equipment, systems and network information security protection

In showing compliance with CS 27.1319, an applicant that wishes to certify a Category A rotorcraft may consider AMC 20-42, which provides acceptable means, guidance and methods to perform security risk assessments and mitigation for aircraft information systems.

The term 'mitigated as necessary' clarifies that the applicant has the discretion to establish appropriate means of mitigation against security risks

[Amdt No: 27/7]

AMC1 27.1337(e) Powerplant instruments

CHIP DETECTION SYSTEM

This AMC provides further guidance and acceptable means of compliance to supplement Federal Aviation Administration (FAA) Advisory Circular (AC) 27 1B, § AC 27.1337. As such, it should be used in conjunction with the FAA AC.

The applicant should consider the following aspects of chip detection systems:

(a) Chip detection effectiveness

The effectiveness of the chip detection system should be understood as its capability to indicate the presence of ferromagnetic particles within a transmission or a gearbox. As a chip detection system requires these ferromagnetic particles to be near its sensing element(s) (chip detector(s)), its effectiveness depends on the following:

- the design of the rotor drive system's transmission or gearbox, which may help or prevent released ferromagnetic particles to move to the chip detector location(s);
- the location of the chip detector; and
- the design of the chip detector.

(b) Demonstration of effectiveness

As specified in CS 27.1337(e), the applicant should demonstrate that a chip detection system that is installed in a rotor drive system's transmission or gearbox effectively indicates the presence of ferromagnetic particles resulting from damage or excessive wear within the transmission or gearbox. For this purpose, the applicant should consider the approach that is described in this section.

As mentioned above, the design of the transmission or gearbox, and the location of the chip detectors within them also affect the effectiveness of a chip detection system. As a result, when assessing the effectiveness of a chip detection system, the applicant should consider the characteristics of the complete transmission or gearbox. Hence, as part of the demonstration of the effectiveness of a chip detection system, the applicant should demonstrate that the system can consistently generate a caution/warning signal, within an acceptable period of time, of a limited amount of representative ferromagnetic particles being released. In doing so, the applicant should also consider the characteristics of the corresponding transmission or gearbox, such as oil ways and flow paths towards the chip detectors.

To demonstrate the effectiveness of a chip detection system, the applicant should carry out a detailed design assessment, using representative test data that support the performance of the relevant chip detectors in their local environments.

CS-27 BOOK 2

The applicant should use this assessment to demonstrate that the design provisions are adequate to ensure that the ferromagnetic particles that are released due to damage or excessive wear in the relevant locations will reach at least one chip detector. Sufficient test data to support the performance of the relevant chip detectors in representative environments should be available to demonstrate that the caution/warning signal that is specified in CS 27.1305(v) is generated. When assessing the available test data, the applicant should consider that based on the area of the transmission or gearbox where the particles originate, additional test points may be needed, depending on the design of the chip detectors and of the areas around them. If the design of the transmission or gearbox has questionable features that may trap particles or impede their progress, representative test data or in-service experience that demonstrate the impact of these features on the effectiveness of the chip detection system should be available to support the assessment.

The applicant may obtain supporting test data from representative full-scale tests, previous similar designs and/or components, or sub-assembly tests, as appropriate.

To demonstrate the effectiveness of the chip detection system, as described in this section, the applicant should also ensure that the chip detection system performs its intended function under any expected operating conditions. Therefore, the applicant should consider, through design analysis and/or dedicated testing, any aspects of the chip detection system and of the elements in which it is installed (i.e. gearboxes and transmissions) that could affect the effectiveness of the system. These aspects should include the following:

- attitude of the rotorcraft;
- temperature and viscosity of the oil; and
- exact location from which the ferromagnetic particles originate, and the vicinity of potential retention features.

(c) Acceptable level of effectiveness

This section provides an acceptable measure for demonstrating the effectiveness of the chip detection system that is described in point (b).

An acceptable level of effectiveness is demonstrated when the chip detection system generates a caution/warning signal following the release of an amount of ferromagnetic particles. The applicant should justify that this amount results from the damage or excessive wear caused by the failure modes of the specific area of the transmission or gearbox under assessment. Alternatively, the applicant may choose to use 60 mg of ferromagnetic particles.

In addition, no more than 20 minutes should elapse between the introduction of the first ferromagnetic particles and the generation of the caution/warning signal by the chip detection system. However, if the applicant demonstrates that a specific design feature of the chip detection systems consistently leads to effective detection in a period greater than 20 min, the adequacy of that system may be considered on a case-by-case basis.

When demonstrating the effectiveness of the chip detection system, the applicant should consider particles with characteristics (shapes, sizes, densities, and magnetic properties) representative of the damage or excessive wear associated with the areas being tested.

(d) Other considerations

(1) Reliability considerations

CS 27.1337(e) focuses on the overall effectiveness of the chip detection system. The assumption is made that the electrical elements of the system, the chip detector(s), and the instruments function reliably due to good design practices and compliance with the applicable requirements for electrical systems.

(2) Design considerations

- (i) Flat oil sumps can significantly limit the capability of ferromagnetic particles, coming from different locations in the transmission or gearbox, that need to move across the sump to reach a chip detector. Therefore, the applicant should normally use substantiating test data to support the certification of this type of design feature.

CS-27 BOOK 2

Note: if the applicant has successfully performed tests in accordance with point (b), no further test data are necessary.

- (ii) When designing rotor drive system transmissions and gearboxes, the applicant should ensure that the flow path of the lubricating oil that is intended to carry ferromagnetic particles is directed to the locations of the chip detectors. The location, orientation, and flow of oil jets may affect the movement of the ferromagnetic particles subject to their influence.
- (iii) The applicant should avoid, wherever possible, specific features, such as cavities or pockets that could act as retention features for ferromagnetic particles.
- (iv) In pressure-lubricated gearboxes, ferromagnetic particles may be drawn into the lubrication circuit at the pump intake. This can be advantageous for locating chip detectors. However, the applicant should carefully consider that the chip detection system may require particles to be acquired and retained, allowing them to be recovered and analysed. Thus, areas of strong oil flow should be carefully considered, ensuring that the final location is defined and implemented in the design for particle recovery.

For non-pressure-lubricated gearboxes, the applicant should place the chip detector at the lowest point of the system.

(3) Maintenance and ICA considerations

The applicant should consider that CS 27.1337(e) focuses on the fitment of a chip detection system. That system should be an effective means to indicate the presence of ferromagnetic particles in rotor drive system transmissions and gearboxes, which may be caused by damage or excessive wear. It should also be capable to indicate the presence of such particles and to be checked in flight. However, following the detection of such particles by the rotorcraft chip detection system, additional actions are typically needed to ensure the airworthiness of the rotorcraft. The applicant should define the following actions in the instructions for continuing airworthiness (ICA):

- instructions to assess findings from any indication from the chip detection system, which may involve:
 - analysis of the quantity and characteristics of the ferromagnetic particles that are detected and retrieved, and/or
 - maintenance checks to retrieve additional ferromagnetic particles from other areas of the rotor drive system, such as the oil filter of the lubrication system;
- specific criteria to establish whether any findings may indicate that parts of the affected transmission or gearbox are subject to damage or wear and require to be restored to a serviceable condition; and
- additional inspections in support of continued operation when the aforementioned criteria are not reached.

In addition, the applicant may consider complementing the caution/warning signal of the chip detection system by regular inspection of the chip detector(s) and/or other elements of the transmission or gearbox where ferromagnetic particles may be located.

Finally, the applicant should ensure that the reliability of the system is maintained in service by conducting the necessary in-flight and maintenance checks to verify that the elements of the chip detection system function correctly.

[Amdt No: 27/9]

GM1 27.1337(e) Powerplant instruments

CHIP DETECTION SYSTEM

CS-27 BOOK 2

The chip detection system typically includes one or more sensing elements (i.e. 'chip detectors') per transmission or gearbox. Those chip detectors have the function of detecting the presence of ferromagnetic particles and generating a caution/warning signal. The chip detection system also includes the connectors' wiring, as well as the hardware unit for processing the caution/warning signal, if needed, transferring it, and generating the warning or caution required by CS 27.1305(v).

[Amdt No: 27/9]

AMC 27.1411 Safety equipment — General

This AMC replaces FAA AC 27.1411.

(a) Explanation

CS-27 Amendment 5 introduced changes related to ditching and associated equipment. In particular, it defined a standard set of terminology, it simplified CS 27.1411 in line with it being a general certification specification for safety equipment, reorganised CS 27.1415 specifically for ditching equipment, and created a new CS 27.1470 on the installation and carriage of emergency locator transmitters (ELTs). All requirements relating to life raft installations are now co-located in CS 27.1415.

- (1) The safety equipment should be accessible and appropriately stowed, and it should be ensured that:
 - (i) locations for stowage of all required safety equipment have been provided;
 - (ii) safety equipment is readily accessible to both crew members and passengers, as appropriate, during any reasonably probable emergency situation;
 - (iii) stowage locations for all required safety equipment will adequately protect such equipment from inadvertent damage during normal operations; and
 - (iv) safety equipment stowage provisions will protect the equipment from damage during emergency landings when subjected to the inertia loads specified in CS 27.561.

(b) Procedures

- (1) A cockpit evaluation should be conducted to demonstrate that all required emergency equipment to be used by the flight crew will be readily accessible during any probable emergency situation. This evaluation should include, for example, emergency flotation equipment actuation devices, remote life raft releases, door jettison handles, handheld fire extinguishers, and protective breathing equipment.
- (2) Stowage provisions for safety equipment shown to be compatible with the vehicle configuration presented for certification should be provided and identified so that:
 - (i) equipment is readily accessible regardless of the operational configuration;
 - (ii) stowed equipment is free from inadvertent damage from passengers and handling; and
 - (iii) stowed equipment is adequately restrained to withstand the inertia forces specified in CS 27.561(b)(3) without sustaining damage.

[Amdt No: 27/5]

AMC 27.1415 Ditching equipment

This AMC replaces FAA AC 27.1415.

(a) Explanation

CS-27 BOOK 2

- (1) Additional safety equipment is not required for all rotorcraft overwater operations. However, if such equipment is required by the applicable operating rule, the equipment supplied should satisfy this AMC.

NOTE: Although the term 'ditching' is most commonly associated with the design standards related to CS 27.801 (ditching approval), a rotorcraft equipped to the less demanding requirements of CS 27.802 (emergency flotation approval), when performing an emergency landing on to water, would nevertheless be commonly described as carrying out the process of ditching. The term 'ditching equipment' is therefore to be considered to apply to any safety equipment required by operational rule for operation over water.

It is a frequent practice for the rotorcraft manufacturer to provide the substantiation for only those portions of the ditching requirements relating to rotorcraft flotation and emergency exits. Completion of the ditching certification to include the safety equipment installation and stowage provisions is then left to the affected operator to arrange via a modifier so that those aspects can best be adopted to the selected cabin interior. In such cases, the 'Limitations' section of the rotorcraft flight manual (RFM) should identify the substantiations yet to be provided in order to justify the full certification with ditching provisions. The modifier performing these final installations is then concerned directly with the details of this AMC. Any issues arising from aspects of the basic rotorcraft flotation and emergency exits certification that are not compatible with the modifier's proposed safety equipment provisions should be resolved between the type certificate (TC) holder and the modifier prior to the certifying authority's certification with ditching provisions (see AMC 27.801(b)(12) and AMC 27.1415(a)(2)(ii)).

- (2) Compliance with the requirements of CS 27.801 for rotorcraft ditching requires compliance with the safety equipment stowage requirements and ditching equipment requirements of CS 27.1411 and CS 27.1415, respectively.
- (i) Ditching equipment, installed to complete ditching certification, or required by the applicable operating rule, should be compatible with the basic rotorcraft configuration presented for ditching certification. It is satisfactory if the operating equipment is not incorporated at the time of the original rotorcraft type certification provided that suitable information is included in the 'Limitations' section of the rotorcraft flight manual (RFM) to identify the extent of ditching certification not yet completed.
 - (ii) When ditching equipment is being installed by a person other than the applicant who provided the rotorcraft flotation system and emergency exits, special care should be taken to avoid degrading the functioning of those items, and to make the ditching equipment compatible with them (see AMC 27.801(b)(12)).

(b) Procedures

All ditching equipment, including life rafts, life preservers, immersion suits, emergency breathing systems etc., should be of an approved type. Life rafts should be chosen to be suitable for use in all sea conditions covered by the certification with ditching provisions.

(1) Life rafts

- (i) Life rafts are rated during their approval according to the number of people that can be carried under normal conditions and the number that can be accommodated in an overload condition. Only the normal rating may be used in relation to the number of occupants permitted to fly in the rotorcraft.
- (ii) Where two life rafts are installed, they should deploy on opposite sides of the rotorcraft in order to minimise the probability that both will be damaged during water entry/impact, and to provide the maximum likelihood that at least one raft will be useable in any wind condition.
- (iii) Successful deployment of life raft installations should be demonstrated in representative orientations. Testing should be performed, including underwater deployment, if applicable, to demonstrate that life rafts sufficient to accommodate all rotorcraft occupants, without exceeding the rated capacity of any life raft, will deploy reliably with the rotorcraft in any reasonably foreseeable floating attitude,

CS-27 BOOK 2

including capsized. It should also be substantiated that reliable deployment will not be compromised by inertial effects from the rolling/pitching/heaving of the rotorcraft in the sea conditions chosen for the demonstration of compliance with the flotation/trim requirements of CS 27.801(e), or by intermittent submerging of the stowed raft location (if applicable) and the effects of wind. This substantiation should also consider all reasonably foreseeable rotorcraft floating attitudes, including capsized. Reasonably foreseeable floating attitudes are considered to be, as a minimum, upright, with and without loss of the critical emergency flotation system (EFS) compartment, and capsized, also with and without loss of the critical EFS compartment. Consideration should also be given towards maximising, where practicable, the likelihood of life raft deployment for other cases of EFS damage.

- (iv) Rotorcraft fuselage attachments for the life raft retaining lines should be provided.
 - (A) Each life raft must be equipped with two retaining lines to be used for securing the life raft to the rotorcraft. The short retaining line should be of such a length as to hold the raft at a point next to an upright floating rotorcraft such that the occupants can enter the life raft directly without entering the water. If the design of the rotorcraft is such that the flight crew cannot enter the passenger cabin, it is acceptable that they would need to take a more indirect route when boarding the life raft. After life raft boarding is completed, the short retaining line may be cut and the life raft then remain attached to the rotorcraft by means of the long retaining line.
 - (B) Attachments on the rotorcraft for the retaining lines should not be susceptible to damage when the rotorcraft is subjected to the maximum water entry loads established by CS 27.563.
 - (C) Attachments on the rotorcraft for the retaining lines should be structurally adequate to restrain a fully loaded life raft.
 - (D) Life rafts should be attached to the rotorcraft by the required retaining lines after deployment without further action from the crew or passengers.
 - (E) It should be verified that the length of the long retaining line will not result in the life raft taking up a position which could create a potential puncture risk or hazard to the occupants, such as directly under the tail boom, tail rotor or main rotor disc.
 - (v) Life raft stowage provisions should be sufficient to accommodate rafts for the maximum number of occupants for which certification for ditching is requested by the applicant.

- (vi) Life raft activation

The following should be provided for each life raft:

- (A) primary activation: manual activation control(s), readily accessible to each pilot on the flight deck whilst seated;
- (B) secondary activation: manual activation control(s) accessible from the passenger cabin; if any control is located within the cabin, it should be protected from inadvertent operation; and
- (C) tertiary activation: manual activation control(s) accessible to a person in the water, with the rotorcraft in all foreseeable floating attitudes, including capsized.

It is acceptable for two or more of the above functions to be incorporated into one control.

Automatic life raft activation is not prohibited (e.g. it could be triggered by water immersion). However, if such a capability is provided, it should be in addition to the above manual activation controls, not instead of them, and issues such as inadvertent deployment in flight and the potential for damage from turning rotors during deployment on the water should be mitigated.

CS-27 BOOK 2

Placards should be installed, of appropriate size, number and location, to highlight the location of each of the above life raft activation controls. All reasonably foreseeable rotorcraft floating attitudes should be considered.

(vii) Protection of life rafts from damage

Service experience has shown that following deployment, life rafts are susceptible to damage while in the water adjacent to the rotorcraft due to projections on the exterior of the rotorcraft such as antennas, overboard vents, unprotected split-pin tails, guttering, etc. and any projections sharper than a three-dimensional right angled corner. Projections likely to cause damage to a deployed life raft should be avoided by design, or suitably protected to minimise the likelihood of their causing damage to a deployed life raft. In general, projections on the exterior surface of the helicopter, that are located in a zone delineated by boundaries that are 1.22 m (4 ft) above and 0.61 m (2 ft) below the established static water line should be assessed. Relevant maintenance information should also provide procedures for maintaining such protection for rotorcraft equipped with life rafts. Furthermore, due account should be taken of the likely damage that may occur (e.g. disintegration of carbon-fibre panels or structure) during water entry and its potential hazard to deployed life rafts.

(2) Life preservers.

No provision for the stowage of life preservers is necessary if the applicable operating rule mandates the need for constant-wear life preservers.

(3) Emergency signalling equipment.

Emergency signalling equipment required by the applicable operating rule should be free from hazards in its operation, and operable using either bare or gloved hands. Required signalling equipment should be easily accessible to the passengers or crew and located near an emergency exit or included in the survival equipment attached to the life rafts.

[Amdt No: 27/5]

AMC 27.1470 Emergency locator transmitters (ELTs)

(a) Explanation

The purpose of this AMC is to provide specific guidance for compliance with CS 27.1301, CS 27.1309, CS 27.1470, CS 27.1529 and CS 27.1581 regarding emergency locator transmitters (ELT) and their installation.

An ELT is considered to be a passive and dormant device whose status is unknown until it is required to perform its intended function. As such, its performance is highly dependent on proper installation and post-installation testing.

(b) References

Further guidance on this subject can be found in the following references:

- (1) ETSO-C126b 406 and 121.5 MHz Emergency Locator Transmitter;
- (2) ETSO-C126b 406 MHz Emergency Locator Transmitter;
- (3) FAA TSO-C126b 406 MHz Emergency Locator Transmitter (ELT);
- (4) EUROCAE ED-62AMOPS for aircraft emergency locator transmitters (406 MHz and 121.5 MHz (optional 243 MHz));
- (5) RTCA DO-182 Emergency Locator Transmitter (ELT) Equipment Installation and Performance; and
- (6) RTCA DO-204A Minimum Operational Performance Standards for 406 MHz Emergency Locator Transmitters (ELTs).

(c) Definitions

CS-27 BOOK 2

- (1) ELT (AF): an ELT (automatic fixed) is intended to be permanently attached to the rotorcraft before and after a crash, is automatically activated by the shock of the crash, and is designed to aid search and rescue (SAR) teams in locating a crash site.
 - (2) ELT (AP): an ELT (automatic portable) is intended to be rigidly attached to the rotorcraft before a crash and is automatically activated by the shock of the crash, but is readily removable from the rotorcraft after a crash. It functions as an ELT (AF) during the crash sequence. If the ELT does not employ an integral antenna, the rotorcraft-mounted antenna may be disconnected and an auxiliary antenna (stowed in the ELT case) connected in its place. The ELT can be tethered to a survivor or a life raft. This type of ELT is intended to assist SAR teams in locating the crash site or survivor(s).
 - (3) ELT (S): an ELT (survival) should survive the crash forces, be capable of transmitting a signal, and have an aural or visual indication (or both) that power is on. Activation of an ELT (S) usually occurs by manual means but automatic activation (e.g. activation by water) may also apply.
 - (i) ELT (S) Class A (buoyant): this type of ELT is intended to be removed from the rotorcraft, deployed and activated by survivors of a crash. It can be tethered to a life raft or a survivor. The equipment should be buoyant and it should be designed to operate when floating in fresh or salt water, and should be self-righting to establish the antenna in its nominal position in calm conditions.
 - (ii) ELT (S) Class B (non-buoyant): this type of ELT should be integral to a buoyant device in the rotorcraft, deployed and activated by the survivors of a crash.
 - (4) ELT (AD) or automatically deployable emergency locator transmitter (ADELT): this type of automatically deployable ELT is intended to be rigidly attached to the rotorcraft before a crash and automatically deployed after the crash sensor determines that a crash has occurred or after activation by a hydrostatic sensor. This type of ELT should float in water and is intended to aid SAR teams in locating the crash site.
 - (5) A crash acceleration sensor (CAS) is a device that detects an acceleration and initiates the transmission of emergency signals when the acceleration exceeds a predefined threshold (Gth). It is also often referred to as 'g switch'.
- (d) Procedures
- (1) Installation aspects of ELTs.

The installation of the equipment should be designed in accordance with the ELT manufacturer's instructions.

- (i) Installation of the ELT transmitter unit and crash acceleration sensors

The location of the ELT should be chosen to minimise the potential for inadvertent activation or damage by impact, fire, or contact with passengers, baggage or cargo.

The ELT transmitter unit should ideally be mounted on primary rotorcraft load-carrying structures such as trusses, bulkheads, longerons, spars, or floor beams (not rotorcraft skin). Alternatively, the structure should meet the requirements of the test specified in 6.1.8 of ED-62A. For convenience, the requirements of this test are reproduced here, as follows:

'The mounts shall have a maximum static local deflection no greater than 2.5 mm when a force of 450 Newtons (100 lbf) is applied to the mount in the most flexible direction. Deflection measurements shall be made with reference to another part of the airframe not less than 0.3 m or more than 1.0 m from the mounting location.'

However, this does not apply to an ELT (S), which should be installed or stowed in a location that is conspicuously marked and readily accessible, or should be integral to a buoyant device such as a life raft, depending on whether it is of Class A or B.

A poorly designed crash acceleration sensor installation can be a source of problems such as nuisance triggers, failures to trigger and failures to deploy.

CS-27 BOOK 2

Nuisance triggers can occur when the crash acceleration sensor does not work as expected or is installed in a way that exposes it to shocks or vibration levels outside those assumed during equipment qualification. This can also occur as a result of improper handling and installation practices.

A failure to trigger can occur when an operational ELT is installed such that the crash sensor is prevented from sensing the relevant crash accelerations.

Particular attention should be paid to the installation orientation of the crash acceleration sensor. If the equipment contains a crash sensor with particular installation orientation needs, the part of the equipment containing the crash sensor will be clearly marked by the ELT manufacturer to indicate the correct installation orientation(s).

The design of the installation should follow the instructions contained in the installation manual provided by the equipment manufacturer. In the absence of an installation manual, in general, in the case of a helicopter installation, if the equipment has been designed to be installed on fixed-wing aircraft, it may nevertheless be acceptable for a rotorcraft application. In such cases, guidance should be sought from the equipment manufacturer. This has typically resulted in a recommendation to install the ELT with a different orientation, e.g. 45 degrees with respect to the main longitudinal axis (versus zero degrees for a fixed wing application). This may help the sensor to detect forces in directions other than the main longitudinal axis, since, during a helicopter crash, the direction of the impact may differ appreciably from the main aircraft axis. However, some ELTs are designed specifically for helicopters or designed to sense forces in several axes.

(ii) Use of hook and loop style fasteners

In several recent aircraft accidents, ELTs mounted with hook and loop style fasteners, commonly known from the brand name Velcro®, have detached from their aircraft mountings. The separation of the ELT from its mount could cause the antenna connection to be severed, rendering the ELT ineffective.

Inconsistent installation and reinstallation practices can lead to the hook and loop style fastener not having the necessary strength to perform its intended function. Furthermore, the retention capability of the hook and loop style fastener may degrade over time, due to wear and environmental factors such as vibration, temperature, or contamination. The safety concern about these attachments increases when the ELT manufacturer's instructions for continued airworthiness (ICA) do not contain specific instructions for regularly inspecting the hook and loop style fasteners, or a replacement interval (e.g. Velcro life limit). This concern applies, regardless of how the hook and loop style fastener is installed in the aircraft.

Separation of ELTs has occurred, even though the associated hook and loop style fastener design was tested during initial European Technical Standard Order (ETSO) compliance verification against crash shock requirements.

Therefore, it is recommended that when designing an ELT installation, the ELT manufacturer's ICA is reviewed and it is ensured that the ICA for the rotorcraft (or the modification, as applicable) appropriately addresses the in-service handling of hook and loop style fasteners.

It is to be noted that ETSO/TSO-C126b states that the use of hook and loop fasteners is not an acceptable means of attachment for automatic fixed (AF) and automatic portable (AP) ELTs.

(iii) ELT antenna installation

This section does not apply to the ELT(S) or ELT (AD) types of ELT. The most recurrent issue found during accident investigations concerning ELTs is the detachment of the antenna (coaxial cable), causing the transmission of the ELT unit to be completely ineffective.

CS-27 BOOK 2

Chapter 6 of ED-62A addresses the installation of an external antenna and provides guidance, in particular, on:

- (A) the location of the antenna;
- (B) the position of the antenna relative to the ELT transmission unit;
- (C) the characteristics of coaxial-cables; and
- (D) the installation of coaxial-cables.

Any ELT antenna should be located away from other antennas to avoid disruption of the antenna radiation patterns. In any case, during installation of the antenna, it should be ensured that the antenna has a free line of sight to the orbiting COSPAS-SARSAT satellites at most times when the aircraft is in the normal flight attitude.

Ideally, for the 121.5 MHz ELT antenna, a separation of 2.5 metres from antennas receiving very high frequency (VHF) communications and navigation data is sufficient to minimise unwanted interference. The 406 MHz ELT antenna should be positioned at least 0.8 metres from antennas receiving VHF communications and navigation data to minimise interference.

External antennas which have been shown to be compatible with a particular ELT will either be part of the ETSO/TSO-approved ELT or will be identified in the ELT manufacturer's installation instructions. Recommended methods for installing antennas are outlined in FAA AC 43.13-2B.

The antenna should be mounted as close to the respective ELT as practicable. Provision should be taken to protect coaxial cables from disconnection or from being cut. Therefore, installation of the external antenna close to the ELT unit is recommended. Coaxial cables connecting the antenna to the ELT unit should not cross rotorcraft production breaks.

In the case of an external antenna installation, ED-62A recommends that its mounting surface should be able to withstand a static load equal to 100 times the antenna's weight applied at the antenna mounting base along the longitudinal axis of the rotorcraft. This strength can be substantiated by either test or conservative analysis.

If the antenna is installed within a fin cap, the fin cap should be made of an RF-transparent material that will not severely attenuate the radiated transmission or adversely affect the antenna radiation pattern shape.

In the case of an internal antenna location, the antenna should be installed as close to the ELT unit as practicable, insulated from metal window casings and restrained from movement within the cabin area. The antenna should be located such that its vertical extension is exposed to an RF-transparent window. The antenna's proximity to the vertical sides of the window and to the window pane and casing as well as the minimum acceptable window dimensions should be in accordance with the equipment manufacturer's instructions.

The voltage standing wave ratio (VSWR) of the installed external antenna should be checked at all working frequencies, according to the test equipment manufacturer's recommendations, during the first certification exercise for installation on a particular rotorcraft type.

Coaxial cables between the antenna and the ELT unit should be provided on each end with an RF connector that is suitable for the vibration environment of the particular installation application. When the coaxial cable is installed and the connectors mated, each end should have some slack in the cable, and the cable should be secured to rotorcraft structures for support and protection.

In order to withstand exposure to fire or flames, the use of fire-resistant coaxial cables or the use of fire sleeves compliant to SAE AS1072 is recommended.

(2) Deployment aspects of ELTs

CS-27 BOOK 2

Automatically deployable emergency locator transmitters (ADELTs) have particularities in their designs and installations that need to be addressed independently of the general recommendations.

The location of an ADELT and its manner of installation should minimise the risk of injury to persons or damage to the rotorcraft in the event of its inadvertent deployment. The means to manually deploy the ADELT should be located in the cockpit, and be guarded, such that the risk of inadvertent manual deployment is minimised.

Automatically deployable ELTs should be located so as to minimise any damage to the structure and surfaces of the rotorcraft during their deployment. The deployment trajectory of the ELT should be demonstrated to be clear of interference from the airframe or any other parts of the rotorcraft, or from the rotor in the case of helicopters. The installation should not compromise the operation of emergency exits or of any other safety features.

In some helicopters, where an ADELT is installed aft of the transport joint in the tail boom, any disruption of the tail rotor drive shaft has the potential to disrupt or disconnect the ADELT wiring. From accident investigations, it can be seen that if a tail boom becomes detached, an ADELT that is installed there, aft of the transport joint, will also become detached before signals from sensors that trigger its deployment can be received.

Therefore, it is recommended to install the ADELT forward of the transport joint of the tail boom. Alternatively, it should be assured that ELT system operation will not be impacted by the detachment of the structural part on which it is installed.

The hydrostatic sensor used for automatic deployment should be installed in a location shown to be immersed in water within a short time following a ditching or water impact, but not subject to water exposure in the expected rotorcraft operations. This assessment should include the most probable rotorcraft attitude when crashed, i.e. its capability to keep an upright position after a ditching or a crash into water.

The installation supporting the deployment feature should be demonstrated to be robust to immersion. Assuming a crash over water or a ditching, water may immerse not only the beacon and the hydrostatic sensor, which is designed for this, but also any electronic component, wires and the source of power used for the deployment.

(3) Additional considerations**(i) Human factors (HF)**

The ELT controls should be designed and installed so that they are not activated unintentionally. These considerations should address the control panel locations, which should be clear from normal flight crew movements when getting into and out of the cockpit and when operating the rotorcraft, and the control itself. The means for manually activating the ELT should be guarded in order to avoid unintentional activation.

(ii) The rotorcraft flight manual (RFM) should document the operation of the ELT, and in particular, any feature specific to the installed model.**(iii) Batteries**

An ELT operates using its own power source. The ELT manufacturer indicates the useful life and expiration date of the batteries by means of a dedicated label. The installation of the ELT should be such that the label indicating the battery expiration date is clearly visible without requiring the removal of the ELT or other LRU from the rotorcraft.

(4) Maintenance and inspection aspects

This Chapter provides guidance for the applicant to produce ICA related to ELT systems. The guidance is based on Chapter 7 of ED-62A.

(i) The ICA should explicitly mention that:

CS-27 BOOK 2

- (A) The self-test function should be performed according to the manufacturer's recommendation but no less than once every 6 months. Regulation at the place of operation should be considered when performing self-tests, as national aviation authorities (NAAs) may have established specific procedures to perform self-tests.
 - (B) As a minimum, a periodic inspection should occur at every battery replacement unless an inspection is required more frequently by the airworthiness authorities or the manufacturer.
- (ii) Each inspection should include:
- (A) the removal of all interconnections to the ELT antenna, and inspection of the cables and terminals;
 - (B) the removal of the ELT unit, and inspection of the mounting;
 - (C) access to the battery to check that there is no corrosion;
 - (D) a check of all the sensors as recommended by Chapter 7.6 of ED-62A — Periodic inspection; and
 - (E) measurement of the transmission frequencies and the power output.
- (5) Rotorcraft flight manual (RFM)/Rotorcraft flight manual supplement (RFMS)

The rotorcraft flight manual (RFM) or supplement (RFMS), as appropriate, should contain all the pertinent information related to the operation of the ELT, including the use of the remote control panel in the cockpit. If there are any limitations on its use, these should be declared in the 'Limitations' section.

Detailed instructions for pre-flight and post-flight checks should be provided. As a pre-flight check, the ELT remote control should be checked to ensure that it is in the armed position. Post-flight, the ELT should be checked to ensure that it does not transmit, by activating the indicator on the remote control or monitoring 121.5 MHz.

Information on the location and deactivation of ELTs should also be provided. Indeed, accident investigations have shown that following aircraft ground impact, the remote control switch on the instrument panel may become inoperative, and extensive fuselage disruption may render the localisation of, and the access to, the ELT unit difficult. As a consequence, in the absence of information available to the accident investigators and first responders, this has led to situations where the ELT transmitted for a long time before being shut down, thus blocking the SAR channel for an extended time period. It is therefore recommended that information explaining how to disarm or shut down the ELT after an accident, including when the remote control switch is inoperative, should be included.

[Amdt No: 27/5]

CS-27 BOOK 2**AMC 27.1555 Control markings**

This AMC supplements FAA AC 27.1555.

(a) Explanation

CS-27 Amendment 5 introduced the need to mark emergency controls for use following a ditching or water impact with black and yellow stripes, instead of red, to make them more conspicuous when viewed underwater.

(b) Procedures

- (1) Any emergency control that may be required to be operated underwater (e.g. an emergency flotation system deployment switch, a life raft deployment switch or handle) should be coloured with black and yellow stripes.
- (2) Black and yellow markings should consist of at least two bands of each colour of approximately equal widths.

[Amdt No: 27/5]

AMC 27.1561 Safety equipment

This AMC supplements FAA AC 27.1561.

(a) Explanation

CS 27.1561 requires each safety equipment control that can be operated by a crew member or passenger to be plainly marked to identify its function and method of operation. (Note that the marking of safety equipment controls located within the cockpit and intended for use by the flight crew is addressed in CS 27.1555.)

In addition, a location marking for each item of stowed safety equipment should be provided that identifies the contents and how to remove them. All safety equipment, including ditching and survival equipment, should be clearly identifiable and provided with operating instructions. Markings and placards should be conspicuous and durable as per CS 27.1541. Both passengers and crew should be able to easily identify and then use the safety equipment.

(b) Procedures

- (1) Release devices such as levers or latch handles for life rafts and other safety equipment should be plainly marked to identify their function and method of operation. The method of operation should be also marked. Stencils, permanent decals, placards, or other permanent labels or instructions may be used.
- (2) Lockers, compartments, or pouches used to contain safety equipment such as life vests, etc., should be marked to identify the equipment therein and to also identify, if not obvious, the method or means of accessing or releasing the equipment.
- (3) Safety equipment should be labelled and provided with instructions for its use or operation.
- (4) Locating signs for safety equipment should be legible in daylight from the furthest seated point in the cabin or recognisable from a distance equal to the width of the cabin. Letters, 2.5 cm (1 in) high, should be acceptable to satisfy the recommendation. Operating instructions should be legible from a distance of 76 cm (30 in). These recommendations are based on the exit requirements of CS 29.811(b) and (e)(1).
- (5) As prescribed, each life raft and its installed equipment should be provided with clear operating instruction markings that cannot be easily erased or disfigured and are readable at low levels of illumination.
- (6) Easily recognised or identified and easily accessible safety equipment located in sight of the occupants, such as a passenger compartment fire extinguisher that all

CS-27 BOOK 2

passengers can see, may not require locating signs, stencils, or decals. However, operating instructions are required.

[Amdt No: 27/5]

AMC 27.1587(b)(3) Performance Information

a. Explanation

The rotorcraft flight manual (RFM) is an important element in the certification process of the rotorcraft for approval with ditching or emergency flotation provisions. The material may be presented in the form of a supplement or a revision to the basic manual. This material should include:

- (1) A statement in the 'Limitations' section stating that the rotorcraft is approved for ditching or emergency flotation, as appropriate.

If certification with ditching provisions is obtained in a segmented fashion (i.e. one applicant performing the safety equipment installation and operations portion and another designing and substantiating the safety equipment's performance and deployment facilities), the RFM limitations should state that the ditching provisions are not approved until all the segments are completed. The outstanding ditching provisions for a complete certification should be identified in the 'Limitations' section.

- (2) Procedures and limitations for the inflation of a flotation device.
- (3) A statement in the performance information section of the RFM, identifying the substantiated sea conditions and any other pertinent information. If substantiation was performed using the default North Sea wave climate (JONSWAP), the maximum substantiated significant wave height (H_s) should be stated. If extended testing was performed in accordance with the AMC to 27.801(e) and 27.802(c) to demonstrate that the target level of capsizing probability can be reached without any operational limitations, this should also be stated. If substantiation was performed for other sea conditions, the maximum substantiated significant wave height (H_s) and the limits of the geographical area represented should be stated.
- (4) Recommended rotorcraft water entry attitude and speed.
- (5) Procedures for the use of safety equipment.
- (6) Egress and life raft entry procedures.

[Amdt No: 27/5]

AMC 27.1593 Exposure to volcanic cloud hazards

The aim of CS 27.1593 is to support commercial and non-commercial operators operating complex motor-powered rotorcraft by identifying and assessing airworthiness hazards associated with operations in contaminated airspace. Providing such data to operators will enable those hazards to be properly managed as part of an established management system.

Acceptable means of establishing the susceptibility of rotorcraft features to the effects of volcanic clouds should include a combination of experience, studies, analysis, and/or testing of parts or sub-assemblies.

Information necessary for safe operation should be contained in the unapproved part of the flight manual or other appropriate manual, and should be readily usable by operators in preparing a safety risk assessment as part of their overall management system.

A volcanic cloud comprises volcanic ash together with gases and other chemicals. Although the primary hazard is volcanic ash itself, other elements of the volcanic cloud may also be undesirable to operate through, thus their effect on airworthiness should be assessed.

In determining the susceptibility of rotorcraft features to the effects of volcanic clouds as well as the necessary information to be provided to operators, the following points should be considered:

CS-27 BOOK 2

- (a) Identify the features of the rotorcraft that are susceptible to airworthiness effects of volcanic clouds. These may include but are not limited to the following:
- (1) malfunction or failure of one or more engines, leading not only to reduction or complete loss of thrust but also to failures of electrical, pneumatic and hydraulic systems;
 - (2) blockage of pitot and static sensors, resulting in unreliable airspeed indications and erroneous warnings;
 - (3) windscreen abrasion, resulting in windscreens rendered partially or completely opaque;
 - (4) fuel contamination;
 - (5) volcanic-ash and/or toxic chemical contamination of cabin air-conditioning packs, possibly leading to loss of cabin pressurisation or noxious fumes in the cockpit and/or cabin;
 - (6) erosion, blockage or malfunction of external and internal rotorcraft components;
 - (7) volcanic-cloud static discharge, leading to prolonged loss of communications; and
 - (8) reduced cooling efficiency of electronic components, leading to a wide range of rotorcraft system failures.
- (b) The nature and severity of effects.
- (c) Details of any device or system installed on the rotorcraft that can detect the presence of volcanic cloud hazards (e.g. volcanic ash (particulate) sensors or volcanic gas sensors).
- (d) The effect of volcanic ash on operations arriving to or departing from contaminated aerodromes.
- (e) The related pre-flight, in-flight and post-flight precautions to be taken by the operator including any necessary amendments to Aircraft Operating Manuals, Aircraft Maintenance Manuals, Master Minimum Equipment List/Dispatch Deviation or equivalents, required to support the operator. Pre-flight precautions should include clearly defined procedures for the removal of any volcanic ash detected on parked rotorcraft.
- (f) The recommended continuing-airworthiness inspections associated with operations in airspace contaminated by (a) volcanic cloud(s) and arriving to or departing from aerodromes contaminated by volcanic ash; this may take the form of Instructions for Continued Airworthiness (ICA) or other advice.

[Amdt No: 27/4]

AMC MG 1 Certification procedure for rotorcraft avionics equipment

This AMC provides further guidance and acceptable means of compliance to supplement FAA AC 27-1B Change 7 MG 1, which is the EASA acceptable means of compliance, as provided for in AMC 27 General. However, some aspects of the FAA AC are deemed by EASA to be at variance with EASA's interpretation or its regulatory system. EASA's interpretation of these aspects is described below. The paragraphs of FAA AC 27-1B Change 7 MG 1 that are not amended below are considered to be EASA acceptable means of compliance.

a. Pre-test Requirements

[...]

(4)

- (i) Environment. An appropriate means for environmental testing is set forth in Radio Technical Commission for Aeronautics (RTCA) Document DO-160. Applicants should submit test reports showing that the laboratory-tested categories, such as temperature, vibration, altitude, etc., are compatible with the environmental demands placed on the rotorcraft. This can be achieved by determining the specific local environmental conditions in which the equipment will be installed and establishing the compatibility with the required DO-160 environmental condition.

[...]

b. Test Procedures

[...]

CS-27 BOOK 2

(4)

[...]

- (v) Localiser performance should be checked for rotor modulation in approach while varying the rotor RPM throughout its normal range.
- (A) Localiser intercept. In the approach configuration and a distance of at least 10 NM from the localiser facility, fly toward the localiser front course, inbound, at an angle of at least 50 degrees. Perform this manoeuvre from both left and right of the localiser beam. No flags should appear during the period of time in which the deviation indicator moves from full deflection to on course. If the total antenna pattern has not been shown to be adequate by ground checks or by VOR flight evaluation, additional intercepts should be made. The low limits of interception should be determined.
- (B) Localiser tracking. While flying the localiser inbound and not more than 5 miles before reaching the outer marker, change the heading of the rotorcraft to obtain full needle deflection. Then fly the rotorcraft to establish localiser on course operation. The localiser deviation indicators should direct the rotorcraft to the localiser on course. Perform this manoeuvre with both a left and a right needle deflection. Continue tracking the localiser until over the transmitter. Conduct at least three acceptable front, and if applicable, back course flights to 200 feet or less above the threshold.

(5)

[...]

- (ii) Glideslope Intercept. The glideslope should be intercepted at both short and long distances in order to ensure correct functioning. Observe the glideslope deviation indicator for proper crossover as the aircraft flies through the glide path. No flags should appear between the time when the needle leaves the full-scale fly-up position and when it reaches the full-scale fly-down position.

[...]

- (v) Glideslope performance should be sampled for rotor modulation during the approach, while varying the rotor RPM throughout its normal range.

(6)

[...]

- (iii) Technical. Approach the markers at a reasonable ground speed and at an altitude of 1 000 feet above ground level. While passing over the outer and middle markers with the localiser deviation indicator centred, the annunciators should illuminate for an appropriate duration. Check that the intensity of the indicator lights is acceptable in bright sunlight and at night. For slower rotorcraft, the duration should be proportionately longer.

[...]

- (12) Inertial Navigation. AC 20-138 (current version) contains the basic criteria for the engineering evaluation of an inertial navigation system (INS). Further tailoring and refinement of the guidance contained within AC 20-138 may be required by the applicant in order to make it fully applicable to the rotorcraft domain.

[...]

(18)

[...]

- (iv) Flight Test.

[...]

- (B) The suitable glide path angles at low speed (< 70 kt KIAS) should be evaluated for IFR certificated aircraft.

CS-27 BOOK 2

(1) Evaluate:

[...]

- (ix) If the glide path angle for IFR aircraft has not been evaluated, then a limitation should be included in the rotorcraft flight manual or rotorcraft flight manual supplement. This limitation should limit IFR coupled RNAV approach operations to an appropriate and justifiably conservative glide path angle and the minimum approach airspeed that meet flight manual limitations. This is necessary until evaluations are accomplished and the determination is made that the autopilot-GPS integration supports steep-angle, low speed operations.

[Amdt No: 27/6]

AMC MG 4 Full Authority Digital Electronic Controls (FADEC)

Note: Certification procedures identified in MG4 refer specifically to the FAA regulatory system. For guidance on EASA procedures, reference should be made to Commission Regulation (EC) No 1702/2003 (as amended) (Part-21), AMC-20 (and specifically AMC 20-1 and 20-3) and to EASA internal working procedures, all of which are available on EASA's web site: <http://www.easa.europa.eu/>

[Amdt No: 27/2]

AMC MG 5 Agricultural dispensing equipment installation

Certification procedures identified in MG5 refer specifically to the FAA regulatory system and are not fully applicable to the EASA regulatory system due to the different applicability of restricted certification. The EASA regulatory system does not encompass a restricted certification category for design changes or Supplemental Type Certificates.

The certification basis of design changes or Supplemental Type Certificates for agricultural dispensing is to be established in accordance with 21.A.101 of Annex I to Regulation (EU) No 748/2012, on a case-by-case basis through compliance with the applicable airworthiness requirements contained in MG5, supplemented by any special conditions in accordance with 21.A.16B of Regulation (EU) No 748/2012 that are appropriate to the application and specific operating limitations and conditions. If appropriate to the proposed design, compliance with the above could be achieved through the provisions contained in 21A.103(a)2(ii) or 21A.115(b)2 of Regulation (EU) No 748/2012.

[Amdt No: 27/4]

AMC MG 6 Emergency Medical Service (EMS) systems installations, including interior arrangements, equipment, Helicopter Terrain Awareness and Warning System (HTAWS), radio altimeter, and Flight Data Monitoring System (FDMS)

This AMC provides further guidance and acceptable means of compliance to supplement the FAA AC 27-1B Change 7 MG6, which is the EASA acceptable means of compliance, as provided for in AMC 27 General. However, some aspects of the FAA AC are deemed by EASA to be at variance with EASA's interpretation or its regulatory system. EASA's interpretation of these aspects is described below. Paragraphs of FAA AC 27-1B MG6 that are not amended below are considered to be EASA acceptable means of compliance:

a. Explanation. This AMC pertains to EMS configurations and associated rotorcraft airworthiness standards. EMS configurations are usually unique interior arrangements that are subject to the appropriate airworthiness standards (CS-27 or other applicable standards) to which the rotorcraft was certified. No relief from the standards is intended except through the procedures contained in Regulation (EU) No 748/2012 (namely Part-21 point 21.A.21(c)). EMS configurations are seldom, if ever, done by the original manufacturer.

CS-27 BOOK 2

- (1) Regulation (EU) No 965/2012 specifies the minimum equipment required to operate as a helicopter air ambulance service provider. This equipment, as well as all other equipment presented for evaluation and approval, is subject to compliance with airworthiness standards. Any equipment not essential to the safe operation of the rotorcraft may be approved provided the use, operation, and possible failure modes of the equipment are not hazardous to the rotorcraft. Safe flight, safe landing, and prompt evacuation of the rotorcraft, in the event of a minor crash landing, for any reason, are the objectives of the EASA's evaluation of interiors and equipment unique to EMS.
- i. For example, a rotorcraft equipped only for transportation of a non-ambulatory person (e.g. a police rotorcraft with one litter) as well as a rotorcraft equipped with multiple litters and complete life support systems and two or more attendants or medical personnel may be submitted for approval. These configurations will be evaluated to the airworthiness standards appropriate to the rotorcraft certification basis.
 - ii. Small category rotorcraft should comply with flight crew and passenger safety standards, which will result in the need to re-evaluate certain features of the baseline existing type certified rotorcraft related to the EMS arrangement, such as doors and emergency exits, and occupant protection. Compliance with airworthiness standards results in the following features that should be retained as part of the rotorcraft's baseline type design: an emergency interior lighting system, placards or markings for doors and exits, exit size, exit quantity and location, exit access, safety belts and possibly shoulder harnesses or other restraint or passenger protection means. The features, placards, markings, and 'emergency' systems required as part of the rotorcraft's baseline type design should be retained unless specific replacements or alternate designs are necessary for the EMS configuration to comply with airworthiness standards.
- (2) Many EMS configurations of small rotorcraft are typically equipped with the following:
- i. attendant and medical personnel seats, which may swivel;
 - ii. multiple litters, some of which may tilt;
 - iii. medical equipment stowage compartments;
 - iv. life support and other complex medical equipment;
 - v. human infant incubator ('isolette');
 - vi. curtains or other interior light shielding for the flight crew compartment;
 - vii. external loudspeakers and search lights;
 - viii. special internal and external communication radio equipment;
 - ix. FDMS;
 - x. radio altimeter;
 - xi. HTAWS.
- (3) All helicopter air ambulance service providers are required to operate at all times in accordance with Regulation (EU) No 965/2012, which also defines the equipment required for an operational approval to be obtained.

b. Procedures**(2) Evacuation and interior arrangements**

- iii. When an evacuation demonstration is determined to be appropriate for compliance, 90 seconds should be used as the time interval for evacuation of the rotorcraft. Attendants and flight crew, trained in the evacuation procedures, may

CS-27 BOOK 2

be used to remove the litter patient(s). It is preferable for the patient(s) to remain in the litter; however, the patient(s) may be removed from the litter to facilitate rapid evacuation through the exit. The patient(s) is (are) not ambulatory during the demonstration. Evacuation procedures should be included if isolettes are part of the interior. The demonstration may be conducted in daylight with the dark of the night simulated and the rotorcraft in a normal attitude with the landing gear extended. For the purpose of the demonstration, exits on one side (critical side) should be used. Exits on the opposite side are blocked and not accessible for the demonstration.

(3) Restraint of occupants and equipment

The emergency landing conditions specified in CS 27.561(b) dictate the design load conditions. See FAA AC 27-1, sections 27.561 and 27.785, for further information.

- i. Whether seated or recumbent, the occupants must be protected from serious injury as prescribed in CS 27.785. Swivel seats and tilt litters may be used provided they are substantiated for the appropriate loads for the position selected for approval. Placards or markings may be used to ensure proper orientation for flight, take-off, or landing and emergency landing conditions. The seats and litters should be listed in the type design data for the configuration. See paragraph b.(17) for substitutions.

(6) Interior or 'medical' lights

The view of the flight crew must be free from glare and reflections that could cause interference. Curtains that meet flammability standards may be used. Complete partition or separation of the flight crew and passenger compartment is not prudent. Means for visual and verbal communication are usually necessary. Refer to FAA AC 27-1, section 27.773, which addresses pilot visibility aspects.

[Amdt No: 27/4]

[Amdt No: 27/6]

AMC MG 16 Certification guidance for rotorcraft Night Vision Imaging System (NVIS) aircraft lighting systems

This AMC provides further guidance and acceptable means of compliance to supplement FAA AC 27-1B Change 7 MG 16, which is the EASA acceptable means of compliance, as provided for in AMC 27 General. However, some aspects of the FAA AC are deemed by EASA to be at variance with EASA's interpretation or its regulatory system. EASA's interpretation of these aspects is described below. Paragraphs of FAA AC 27-1B Change 7 MG 16 that are not amended below are considered to be EASA acceptable means of compliance.

[...]

d. References (use the current versions of the following references).**(1) Regulatory (CS-27).**

| | | |
|-----------|---------|---------|
| 27.1 | 27.1322 | 27.1501 |
| 27.21 | 27.1351 | 27.1523 |
| 27.141(c) | 27.1357 | 27.1525 |
| 27.603(c) | 27.1367 | 27.1529 |
| 27.771 | 27.1381 | 27.1541 |
| 27.773 | 27.1383 | 27.1543 |

CS-27 BOOK 2

| | | |
|--------------|---------|---------|
| 27.777 | 27.1385 | 27.1545 |
| 27.785 | 27.1387 | 27.1549 |
| 27.807(b)(3) | 27.1389 | 27.1553 |
| 27.853 | 27.1391 | 27.1555 |
| 27.1301 | 27.1393 | 27.1557 |
| 27.1303 | 27.1395 | 27.1561 |
| 27.1305 | 27.1397 | 27.1581 |
| 27.1307 | 27.1399 | 27.1583 |
| 27.1309 | 27.1401 | 27.1585 |
| 27.1321 | | |

(2) Other references.

| Document | Title |
|---------------|---|
| FAA AC 25-11B | Electronic Flight Displays |
| FAA AC 20-74 | Aircraft Position and Anticollision Light Measurements |
| FAA AC 20-88A | Guidelines on the Marking of Aircraft Powerplant Instruments (Displays) |
| FAA AC 20-152 | RTCA, Inc., Document RTCA/DO-254, Design Assurance Guidance for Airborne Electronic Hardware |
| RTCA DO-268 | Concept of Operations, Night Vision Imaging System for Civil Operators |
| RTCA DO-275 | Minimum Operational Performance Standards for Integrated Night Vision Imaging System Equipment |
| SAE ARP 4754A | Certification considerations for highly-integrated or complex aircraft systems |
| SAE ARP 4761 | Guidelines and Methods for Conducting the Safety Assessment Process on Civil Airborne Systems and Equipment |

| Document | Title |
|---------------|---|
| SAE ARP 5825A | Design Requirements and Test Procedures for Dual Mode Exterior Lights |
| ETSO-C4c | Bank and Pitch Instruments |
| ETSO-C8e | Vertical Velocity Instrument (Rate-of-Climb) |
| ETSO-C87a | Airborne Low-Range Radio Altimeter |
| ETSO-C164 | Night Vision Goggles (NVG) |

CS-27 BOOK 2

[...]

e. Background.

[...]

- (7) Night vision goggles (NVGs) enhance a pilot's night vision by amplifying certain energy frequencies. The NVGs for civil use are based on performance criteria in ETSO-C164 and RTCA Document DO-275. These NVGs are known as 'Class B NVGs' because they have filters applied to the objective lenses that block energy below the wavelength of 665 nanometres (nm). The Class B objective lens filter allows more use of colour in the cockpit, with truer reds and ambers. The ETSO specifies Class B NVGs for civil use. Because NVGs will amplify energy that is not within the range of the filter, it is important that the NVIS lighting system keeps those incompatible frequencies out of the cockpit. However, there are NVGs in civil use that do not conform to the ETSO-C164 standard because they have Class A filters on their objective lenses. Class A filters block energy below the wavelength of 625 nm. As a result, Class A NVGs amplify more wavelengths of visible light, so they require special care in the use of colour in the cockpit. Applicants are advised that Class A NVGs are deemed to be not acceptable for certification by EASA.

[...]

- (9) Point 21.A.91 of Annex I to Regulation (EU) No 748/2012 contains the criteria for the classification of changes to a type certificate. For NVIS-approved rotorcraft, experience has shown that some changes, which are classified as being minor according to the AMC to 21.A.91 for unaided flight, may have an appreciable effect on the cockpit/cabin lighting characteristics, and thus on crew vision through the NVGs. Therefore, the classification of design changes of NVIS-approved rotorcraft should take into account the effects on cockpit/cabin lighting characteristics and the NVIS.

[...]

f. Procedures.

[...]

- (6) Required equipment, instrument arrangement and visibility.
- (i) In addition to the instruments and equipment required for flight at night, the following additional instruments and equipment will typically be necessary for NVG operations (to be defined for each rotorcraft). The applicable operational regulations that specify aircraft equipment required for night and NVG operations should be reviewed.
- (A) NVIS lighting.
 - (B) A helmet with suitable NVG mount for each pilot and crew member required to use NVGs.
 - (C) NVGs for each pilot and crew members required to use NVGs.
 - (D) Point SPA.NVIS.110(b) of Annex V (Part-SPA) to Regulation (EU) 965/2012 on air operations, and the associated AMC and GM, requires a radio altimeter with an analogue representation. It is recommended that an applicant carries out a careful evaluation of the radio altimeter human-machine interface (including the presentation of height and the possibility of selecting the DH) to establish that it is able to provide the crew with the necessary information.
 - (E) A slip/skid indicator.
 - (F) A gyroscopic attitude indicator.
 - (G) A gyroscopic direction indicator or its equivalent.
 - (H) A vertical speed indicator or its equivalent.

CS-27 BOOK 2

- (I) Communications and navigation equipment necessary for the successful completion of an inadvertent IMC procedure in the intended area of operations.
- (J) Any other aircraft or personal equipment required for the operation (e.g. curtains, NVG stowage, extra batteries for NVGs).

[Amdt No: 27/6]

AMC MG 17 Guidance on analysing an Advanced Flight Controls (AdFC) System

The guidance contained within FAA AC 27-1B Change 7 MG 17 has been deemed by EASA to be at variance with EASA's interpretation or its regulatory system, and it therefore should not be considered to be EASA acceptable means of compliance.

[Amdt No: 27/6]

AMC MG 21 Guidance on creating a system level Functional Hazard Assessment (FHA)

The guidance contained within FAA AC 27-1B Change 7 MG 21 has been deemed by EASA to be at variance with EASA's interpretation or its regulatory system, and it therefore should not be considered to be EASA acceptable means of compliance.

[Amdt No: 27/6]

AMC MG 23 Automatic Flight Guidance and Control Systems (AFGCS) installation in CS-27 Rotorcraft

This AMC provides further guidance and acceptable means of compliance to supplement FAA AC 27-1B Change 7 MG 23, which is the EASA acceptable means of compliance, as provided for in AMC 27 General. However, some aspects of the FAA AC are deemed by EASA to be at variance with EASA's interpretation or its regulatory system. EASA's interpretation of these aspects is described below. Paragraphs of FAA AC 27-1B Change 7 MG 23 that are not amended below are considered to be EASA acceptable means of compliance.

a. Purpose.

- (1) The following Radio Technical Commission for Aeronautics (RTCA) documents are considered to be guidance for showing compliance with the relevant certification specifications for the installation of automatic flight control guidance and control systems (AFGCS).
 - (i) RTCA Document DO-325, *Minimum Operational Performance Standards (MOPS) for Automatic Flight Guidance and Control Systems and Equipment*, issued 8 December 2010.
 - (ii) RTCA Document DO-336, *Guidance for Certification of Installed Automatic Flight Guidance and Control Systems (AFGCS) for Part 27/29 Rotorcraft*, issued 21 March 2012.
- (2) RTCA Document DO-325 contains the minimum operational performance standards (MOPS) for AFGCS equipment.
DO-336 provides guidance on the certification of AFGCS in rotorcraft. It invokes parts of DO-325 as the performance standards that are applicable for the installation of AFGCS equipment in rotorcraft. It provides guidance on conducting a safety assessment. Lastly, DO-336 provides lists of the regulations that can be applicable to an AFGCS installation, and potential methods of compliance with those regulations.
- (3) The guidance contained in DO-336 and DO-325 is not mandatory and provides guidance for showing compliance with the applicable provisions of CS-27.

Note: following this guidance alone does not guarantee acceptance by EASA. EASA may require additional substantiation or design changes as a basis for finding compliance.

CS-27 BOOK 2**b. Guidance for the use of RTCA Documents DO-325 and DO-336.**

RTCA Document DO-336 has two primary focus items: to highlight the requirements for a proper safety assessment (Chapter 8) and the compliance demonstration (Chapter 9).

Note: each of these should be discussed with EASA very early in the certification programme, and included in the certification plan.

c. References.**(1) CS-27 provisions**

| Paragraph | Title |
|---------------------|--|
| 27.671 | General. (Control Systems) |
| 27.672 | Stability augmentation, automatic, and power-operated systems. |
| 27.1309 | Equipment, systems, and installations. |
| 27.1329 | Automatic pilot system. |
| 27.1335 | Flight director systems. |
| Appendix B to CS-27 | Airworthiness Criteria for Helicopter Instrument Flight |

(2) AMC/ACs (available at <http://rgl.faa.gov/> or <https://www.easa.europa.eu/document-library/certification-specifications/group/amc-20-general-acceptable-means-of-compliance-for-airworthiness-of-products-parts-and-appliances#group-table>)

| AMC/AC | Title |
|------------------------|---|
| 20-115D | Airborne Software Development Assurance Using EUROCAE ED-12 and RTCA DO-178 |
| 20-138D | Airworthiness Approval of Positioning and Navigation Systems |
| 20-152 | RTCA, Inc., Document RTCA/DO-254, Design Assurance Guidance for Airborne Electronic Hardware. |
| 21-50 | Installation of TSOA Articles and LODA Appliances |
| 27-1B Section 27.671 | Control Systems - General. |
| 27-1B, Section 27.672 | Stability Augmentation, Automatic, and Power-Operated Systems. |
| 27-1B, Section 27.1309 | Equipment, Systems, and Installations. |
| 27-1B, Section 27.1329 | Automatic Pilot System. |
| 27-1B, Section 27.1335 | Flight Director Systems. |

CS-27 BOOK 2

- (3) Industry standards (RTCA documents are available at www.rtca.org and SAE international documents are available at www.sae.org):

| Document | Title |
|------------------------------|---|
| RTCA/ DO-178 | Software Considerations in Airborne Systems and Equipment Certification |
| RTCA/ DO-254 | Design Assurance Guidance for Airborne Electronic Hardware |
| RTCA/ DO-325 | Minimum Operational Performance Standards (MOPS) for Automatic Flight Guidance and Control Systems and Equipment, issued December 8, 2010. |
| RTCA/ DO-336 | Guidance for Certification of Installed Automatic Flight Guidance and Control Systems (AFGCS) for Part 27/29 Rotorcraft, issued March 21, 2012. |
| SAE, International ARP 4754A | Certification considerations for highly-integrated or complex aircraft systems |
| SAE, International ARP 4761 | Guidelines and Methods for Conducting the Safety Assessment Process on Civil Airborne Systems and Equipment |

[Amdt No: 27/6]