

# European Aviation Safety Agency

## European Technical Standard Order (ETSO)

Subject: DIRECTION INSTRUMENT, MAGNETIC (GYROSCOPICALLY STABILIZED)

### 1 – Applicability

This ETSO gives the requirements which new models of direction instruments, magnetic (gyroscopically stabilized) that are manufactured on or after the date of this ETSO must meet in order to be identified with the applicable ETSO marking.

### 2 - Procedures

#### 2.1. – General

Applicable procedures are detailed in CS-ETSO Subpart A.

#### 2.2 - Specific

None

### 3 - Technical Conditions

#### 3.1 - General

##### 3.1.1 - Minimum Performance Standard

Standards set forth in the SAE Aerospace Standard (AS) document: AS-8013A, "Direction Instrument, Magnetic (Gyroscopically Stabilized)", dated September 1996, as modified by Appendix 1 of this ETSO.

##### 3.1.2 - Environmental Standard

See CS-ETSO Subpart A paragraph 2.1

##### 3.1.3 - Computer Software

See CS-ETSO Subpart A paragraph 2.2

##### 3.1.4 Electronic Hardware Qualification

See CS-ETSO Subpart A paragraph 2.3

#### 3.2 – Specific

##### 3.2.1 Failure Condition Classification

See CS-ETSO Subpart A paragraph 2.4

Failure of the function defined in paragraph 3.1.1 of this ETSO has been determined to be a major failure condition.

### 4 - Marking

#### 4.1 – General

Marking is detailed in CS-ETSO Subpart A, paragraph 1.2

4.2 - Specific

None, Clarification: SAE AS 8013A paragraph 3.15 is not applicable.

**5 - Availability of Referenced Document**

See CS-ETSO Subpart A paragraph 3.

APPENDIX 1

MODIFICATION TO MPS FOR DIRECTION INSTRUMENT, MAGNETIC  
(GYROSCOPICALLY STABILIZED)

Modify AS8013A as follows:

<b><i>SAE AS8013A reference:</i></b>	<b><i>Replace with:</i></b>
Section 3.4: Except for small parts (such as knobs, fasteners, seals, grommets, and small electrical parts) that would not contribute significantly to the propagation of a fire, all materials must be self-extinguishing when tested in accordance with the requirements of Federal Aviation Regulation 25.1359 (d) and Appendix F thereto, with paragraph (b) of Appendix F or may be configured as used.	Except for small parts (knobs, fasteners, seals, grommets, and small electrical parts) that do not contribute significantly to the propagation of a fire, all materials must be self-extinguishing when tested according to EASA CS 25.869(a). See further to Appendix F, Part I (b)(2), <i>Specimen configuration</i> , for current requirements.

# European Aviation Safety Agency

## European Technical Standard Order (ETSO)

SUBJECT: VERTICAL VELOCITY INSTRUMENT (RATE-OF-CLIMB)

### 1 – Applicability

This ETSO gives the requirements which new models of vertical velocity instruments that are manufactured on or after the date of this ETSO must meet in order to be identified with the applicable ETSO marking.

### 2 - Procedures

#### 2.1. - General

Applicable procedures are detailed in CS-ETSO Subpart A.

#### 2.2 - Specific

None

### 3 - Technical Conditions

#### 3.1 - Basic

##### 3.1.1 - Minimum Performance Standard

Standards set forth in the SAE Aerospace Standard (AS) document: AS 8016A "Vertical Velocity Instrument (Rate-of-Climb)" dated September 1996.

##### 3.1.2 - Environmental Standard

See CS-ETSO Subpart A paragraph 2.1

##### 3.1.3 - Computer Software

See CS-ETSO Subpart A paragraph 2.2

##### 3.1.4 Electronic Hardware Qualification

See CS-ETSO Subpart A paragraph 2.3

#### 3.2 – Specific

##### 3.2.1 Failure Condition Classification

See CS-ETSO Subpart A paragraph 2.4

Failure of the function defined in paragraph 3.1.1 of this ETSO has been determined to be a minor failure condition.

### 4 - Marking

#### 4.1 - General

Marking is detailed in CS-ETSO Subpart A paragraph 1.2.

4.2 – Specific

See SAE AS 8016 paragraph 1.2

**5 - Availability of Referenced Document**

See CS-ETSO Subpart A paragraph 3

# European Aviation Safety Agency

## European Technical Standard Order (ETSO)

Subject: AIRCRAFT SEATS and BERTHS CERTIFIED BY STATIC TESTING ONLY

### 1 – Applicability

This ETSO gives the requirements which aircraft seats and berths that are manufactured on or after the date of this ETSO must meet in order to be identified with the applicable ETSO marking for the following types:

Type A- Large Aeroplane (9g forward load seats only)

Type I – Large Aeroplane (berths only)

Type II – Normal, Utility and Commuter

Type III – Acrobatic

Type IV - Rotorcraft

### 2 - Procedures

#### 2.1. - General

Applicable procedures are detailed in CS-ETSO Subpart A.

#### 2.2 - Specific

None

### 3 - Technical Conditions

#### 3.1 - Basic

##### 3.1.1 - Minimum Performance Standard

##### 3.1.1.2 - Type A

Standards set forth in sections 3.1.4, 3.1.8, 3.1.11, 3.1.14, 3.1.15, 3.1.17, 3.1.18, 3.1.19, 3.1.20, 3.2, 3.3, 3.4 (except 3.4.2), 3.5, 4 (except 4.2), 5 (except 5.3 and 5.4) of SAE Aerospace Standard (AS) document AS 8049 Rev. A, "Performance Standard for Seats in Civil Rotorcraft, Transport Aircraft, and General Aviation Aircraft" dated September 1997, as modified by **Appendix 1** of this ETSO.

Seat cushions, when included, for large aeroplane passenger, flight attendant, and observer seats shall meet the fire protection provisions of Appendix F, Part II of EASA CS 25, as required by CS 25.853(c).

##### 3.1.1.3 - Type I, II, III and IV

Standards set forth in the National Aerospace Standard (NAS) Specification 809, dated January 1, 1956 with the following exception:

- (i) The sideward loads as specified in 4.1.2. Table I of NAS 809 need not exceed the requirements of the applicable Certification Specification (CS).

(ii) Materials in Type I berths must comply with the fire protection provisions of CS 25.853(a).

3.1.2 - Environmental Standard

None

3.1.3 - Computer Software

None

3.1.4 Electronic Hardware Qualification

None

3.2 - Specific

None

**4 - Marking**

4.1 - General

Marking is detailed in CS-ETSO Subpart A paragraph 1.2.

4.2 – Specific

4.2.1 The marking must also include the applicable seat type: "Type A-", "Type I-", "Type II-", "Type III-", or "Type IV-" followed by the appropriate seat facing direction designation: "FF" – forward; "RF"- rearward; or "SF" – sideward

4.2.2 Each passenger, flight attendant and observer seat cushion required for qualification of the seating system must be marked with "Complies with CS 25.853(c)" when tested in accordance with the requirements of CS 25.853(c)

**5 - Availability of Referenced Document**

See CS-ETSO Subpart A paragraph 3

## APPENDIX 1

### MODIFICATION TO AS 8049 Rev. A

Modify SAE AS8049 Rev. A as follows:

- (1) Disregard first paragraph in section 3.2 Requirements.
- (2) Revise Section 3.2.1 as follows:

Seat systems shall be designed to provide protection for the occupant at seat adjustment positions, orientations, and locations allowed to be occupied during takeoff and landing.
- (3) Revise Section 3.2.2 as follows:

Seat elements shall be designed so that, when evaluated under the static test conditions of this document, they do not leave hazardous projections that could significantly contribute to occupant injury or impede rapid evacuation.
- (4) Revise Section 3.2.6 as follows:

Adjustable features (seat swivel, back recline, and stowage of movable tables, armrests, footrests, etc.) shall be designed to permit the seat occupant access to those features to adjust to the positions required for takeoff and landing without releasing the occupant's restraints.
- (5) Revise Section 3.2.7 as follows:

When an under-seat baggage restraint is incorporated in a passenger seat, it shall be designed to restrain at least 9.1 kg (20 lb) or the placard weight of stowed items per passenger place, under the static test conditions of this document in a manner that will not significantly impede rapid egress from the seat.
- (6) Revise Section 3.5 as follows:

Allowable permanent deformations sustained by a seat subjected to the ultimate static tests of this document are specified below. Permanent seat deformations shall be measured on the critically loaded seat after static tests. Significant measuring points shall be identified and marked on the test seat, and their positions measured in the lateral, vertical, and longitudinal directions relative to fixed points on the test fixture. Measurement of the selected points shall be recorded before and after the tests. Post test deformations shall be recorded and reported.
- (7) Revise Section 4 as follows:

STRENGTH: All seats qualified for occupancy during takeoff and landing shall be capable of withstanding, within the criteria defined below, statically applied loading.
- (8) Revise Section 5 as follows:

QUALIFICATION TESTS: Initial qualification of a seat shall be performed by static tests. Subsequent qualifications related to design changes to seats of a similar type may be performed by rational analysis based on existing qualification test data.
- (9) Revise Section 3.1.11 as follows:

Restraint system anchorages should provide self-aligning features. If self-aligning features are not provided, the static tests in this document should be conducted with the restraints and anchorages positioned in the most adverse configuration allowed by the design. The anchorage system should minimise the possibility of incorrect installation or inadvertent disconnection of the restraints.



# European Aviation Safety Agency

## European Technical Standard Order

Subject: AIR TRAFFIC CONTROL RADAR BEACON SYSTEM/MODE SELECT  
(ATCRBS/MODE S) AIRBORNE EQUIPMENT

### 1 - Applicability

This ETSO gives the requirements which airborne Mode S air traffic control (ATC) transponder equipment that is manufactured on or after the date of this ETSO, must meet in order to be identified with the applicable ETSO marking.

### 2 - Procedures

#### 2.1 - General

Applicable procedures are detailed in CS-ETSO Subpart A.

#### 2.2 - Specific

None

### 3 - Technical Conditions

#### 3.1 - General

##### 3.1.1 - Minimum Performance Standard

Standards set forth in EUROCAE document ED-73C, "Minimum Operational Performance Specification for Secondary Surveillance Radar Mode S Transponders" dated September 2008.

The following correction applies to: EUROCAE ED-73C. The paragraph 3.29 c. is extended as follows: "In case the optional ACAS interface is not provided the transponder must set Bit 16 of the Data Link Capability Report (BDS 1,0) to zero (0) indicating that no ACAS interface is available."

##### 3.1.2 - Environmental Standard

See CS-ETSO Subpart A paragraph 2.1

##### 3.1.3 - Computer Software

See CS-ETSO Subpart A paragraph 2.2

##### 3.1.4 - Electronic Hardware Qualification

See CS-ETSO Subpart A paragraph 2.3.

#### 3.2 – Specific

##### 3.2.1 - Failure Condition Classification

See CS-ETSO Subpart A paragraph 2.4

Failure of the function defined in paragraph 3.1.1 of this ETSO has been determined to be a major failure condition. The applicant must develop the system to at least the design assurance level commensurate with this failure condition.

#### **4 - Marking**

##### 4.1 - General

Marking is detailed in CS-ETSO Subpart A paragraph 1.2

##### 4.2 - Specific

None

#### **5 - Availability of Referenced Document**

See CS-ETSO Subpart A paragraph 3

# European Aviation Safety Agency

## European Technical Standard Order (ETSO)

Subject: COCKPIT VOICE RECORDER SYSTEMS

### 1 – Applicability

This ETSO gives the requirements that new models of cockpit voice recorder systems that are manufactured on or after the date of this ETSO must meet in order to be identified with the applicable ETSO marking.

### 2 - Procedures

#### 2.1. - General

Applicable procedures are detailed in CS-ETSO Subpart A.

#### 2.2 - Specific

None

### 3 - Technical Conditions

#### 3.1 - Basic

##### 3.1.1 - Minimum Performance Standard

Standards set forth in the applicable sections of EUROCAE document ED-112, dated March 2003 that pertain to the CVR type, as modified by **Appendix 1** of this ETSO, except:

- a) *Recorder start and stop times, Section 2-1.5:* Start and stop times must comply with applicable operational regulations.
- b) *Recorder location, Section 2-5.4.1:* Recorder location must comply with applicable EASA Certification Specifications.
- c) *Equipment Installation and Installed Performance (Deployable recorders) Section 3-4.*
- d) *Equipment Installation and Installed Performance, Part 1-6.*
- e) *Other ED-112 requirements for installation, flight testing, aircraft maintenance, and others that do not pertain to MPS specific criteria.*

The first two exceptions above to ED-112 are related to compliance with the operational regulations and certification specifications. The last three items are exceptions to requirements for installation, flight testing, aircraft maintenance, and others that do not pertain to MPS criteria specific to the ETSO equipment.

Table 1 below lists recorder types and the ED-112 Section and part containing the MPS for each type:

**Table 1. Recorder MPS Requirements**

<b>Recorder Type</b>	<b>ED-112 Reference</b>
Single CVR	Section 2 and Part I
CVR function in a deployable recorder	Section 2, Section 3 and Part I
CVR function in a combined recorder	Section 2, Section 4, and Part I

See Appendix 1 for size, shape, and identification standards for crash protected enclosures.

### 3.1.2 - Environmental Standard

See CS-ETSO Subpart A paragraph 2.1

### 3.1.3 - Computer Software

See CS-ETSO Subpart A paragraph 2.2

### 3.1.4 - Electronic Hardware Qualification

See CS-ETSO Subpart A paragraph 2.3.

## 3.2 – Specific

### 3.2.1 - Failure Condition Classification

Failure of the function defined in paragraph 3.1.1 of this ETSO has been determined to be a minor failure condition. The applicant must develop the system to at least the design assurance level commensurate with this failure condition.

Note: The failure classification is driven by the accident investigation need.

## 4 - Marking

### 4.1 - General

Marking is detailed in CS-ETSO Subpart A paragraph 1.2

### 4.2 – Specific

#### 4.2.1 - Lettering

EUROCAE ED112-Section 2-1 paragraph 2-1.16.3 requires the lettering on the recorder to be at least 25 mm in height. Where it is considered impractical to incorporate lettering of this height due to the size of the recorder case, the applicant may propose an alternative height provided that the size is adequate in relation to the size of the unit and allows easy readability.

#### 4.2.2 - Marking recommendation

Marking in French: "ENREGISTREUR DE VOL NE PAS OUVRIR" is optional.

## 5 - Availability of Referenced Document

See CS-ETSO Subpart A paragraph 3

**APPENDIX 1**

**STANDARDS FOR CRASH PROTECTED ENCLOSURE**

**1 - Physical Size.**

As technology allows for increased miniaturisation, manufacturers continue to shrink the crash enclosure. Now, the enclosure can be very difficult to find in wreckage. The sum of the height (a), width (b), and depth (c) of the crash enclosure must be 23 cm (9 inches) or greater. Each of these major dimensions must be 5 cm (2 inches) or greater. Here are five examples of a crash enclosure and the minimum required dimensions:

NOTE: The dimensions of the crash protected enclosure shall not include the underwater locator beacon (ULB) or its attachment hardware.

**2 - Identification.**

Paint the crash enclosure according to CS 23.1457(g), 25.1457(g), 27.1457(g), or 29.1457(g) and mark in accordance with paragraph 4 of this ETSO.

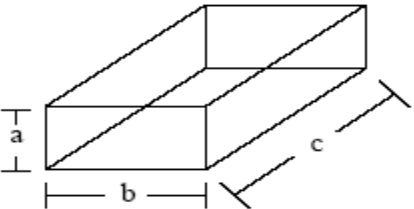

$a, b, c \geq 5 \text{ cm (2 inches)}$   
 $a+b+c \geq 23 \text{ cm (9 inches)}$

**Figure 1. Crash enclosure shaped like a rectangular prism.**



Apply minimum dimensions to the major axis (a), minor axis (b), and length (c) of the enclosure.

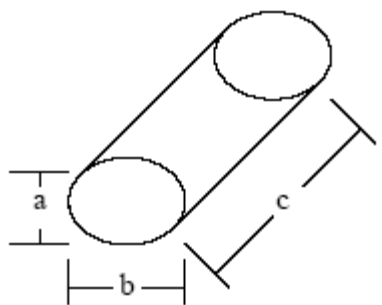

$a, b, c \geq 5 \text{ cm (2 inches)}$   
 $a+b+c \geq 23 \text{ cm (9 inches)}$

**Figure 2. Crash enclosure shaped like an elliptical cylinder.**



Height, width, and depth are all equal to the diameter of the sphere which must be equal to or greater than 7.7 cm (3.0 inches) because of the,  $a + b + c \geq 23$  cm (9 inches), requirement.

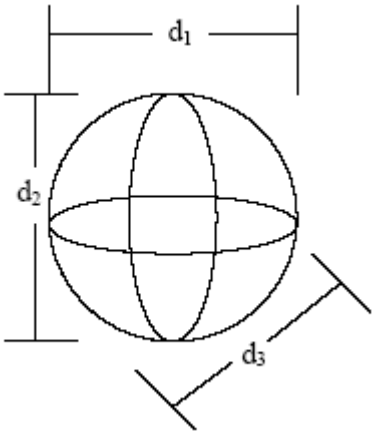

$d_i \geq 7.7$  cm (3 inches)

$d_1 + d_2 + d_3 \geq 23$  cm (9 inches)

**Figure 3. Crash enclosure shaped like a sphere.**

-----

Dimensions a, b, and c are not necessarily equal

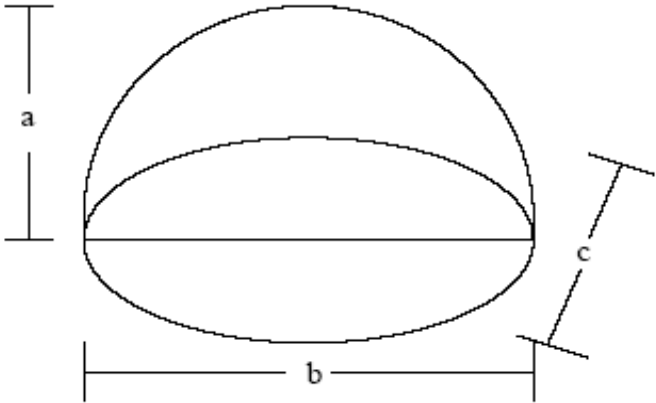

$a, b, c \geq 5$  cm (2 inches)

$a + b + c \geq 23$  cm (9 inches)

**Figure 4. Crash enclosure shaped like an ellipsoid hemisphere.**

-----

Width (a) is the largest width of the enclosure, depth (b) is the largest depth of the enclosure and height (c) is the largest height of the enclosure. Take each of these major dimensions from the outer surface of the enclosure. Do not include any protrusions such as mounting flanges or plates.

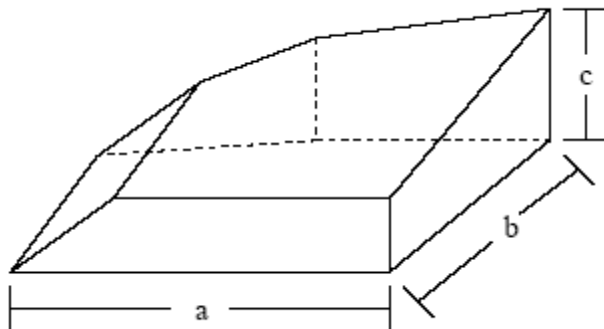

$$a, b, c \geq 5 \text{ cm (2 inches)}$$

$$a+b+c \geq 23 \text{ cm (9 inches)}$$

**Figure 5. Crash enclosure is generically shaped.**

# European Aviation Safety Agency

## European Technical Standard Order (ETSO)

Subject: FLIGHT DATA RECORDER SYSTEMS

### 1 – Applicability

This ETSO gives the requirements that new models of flight data recorder systems that are manufactured on or after the date of this ETSO must meet in order to be identified with the applicable ETSO marking.

### 2 - Procedures

#### 2.1. - General

Applicable procedures are detailed in CS-ETSO Subpart A.

#### 2.2 - Specific

None

### 3 - Technical Conditions

#### 3.1 - Basic

##### 3.1.1 - Minimum Performance Standard

Standards set forth in the applicable sections of EUROCAE document ED-112, dated March 2003 that pertain to the FDR type, as modified by **Appendix 1** of this ETSO, except:

The ED-112 exceptions below are due to conflicts with operational regulations and EASA Certification specifications. The following are exceptions to the ED-112 part and to the sections in table 1 below.

As part of this ETSO, compliance is not required for:

- a) *Recorder start and stop times, Section 2-1.5.* Start and stop times must comply with applicable operational regulations.
- b) *Recorder location, Section 2-5.4.1.* Recorder location must comply with applicable EASA Certification Specifications.
- c) *Recorder parameters, Annex II-A.* Recorder parameters must comply with applicable operational regulations.
- d) *All ED-112 requirements* for aircraft level equipment installation, test, and maintenance.

Table 1 below lists recorder types and the ED-112 Section and part containing the MPS for each type:



**Table 1. Recorder MPS Requirements**

<b>Recorder Type</b>	<b>ED-112 Reference</b>
Single FDR	Section 2 and Part II
FDR function in a deployable recorder	Section 2, Section 3 and Part II
FDR function in a combined recorder	Section 2, Section 4, and Part II

See Appendix 1 for size, shape, and identification standards for crash protected enclosures.

### 3.1.2 - Environmental Standard

See CS-ETSO Subpart A paragraph 2.1

### 3.1.3 - Computer Software

See CS-ETSO Subpart A paragraph 2.2

### 3.1.4 Electronic Hardware Qualification

See CS-ETSO Subpart A paragraph 2.3

## 3.2 – Specific

### 3.2.1 Failure Condition Classification

Failure of the function defined in paragraph 3.1.1 of this ETSO has been determined to be a minor failure condition. The applicant must develop the system to at least the design assurance level commensurate with this failure condition.

Note: The failure classification is driven by the accident investigation need.

## 4 - Marking

### 4.1 - General

Marking is detailed in CS-ETSO Subpart A paragraph 1.2

### 4.2 – Specific

#### 4.2.1 - Lettering

EUROCAE ED112-Section 2-1 paragraph 2-1.16.3 requires the lettering on the recorder to be at least 25 mm in height. Where it is considered impractical to incorporate lettering of this height due to the size of the recorder case, the applicant may propose an alternative height provided that the size is adequate in relation to the size of the unit and allows easy readability.

#### 4.2.2 - Marking recommendation

Marking in French: "ENREGISTREUR DE VOL NE PAS OUVRIR" is optional.

## 5 - Availability of Referenced Document

See CS-ETSO Subpart A paragraph 3

**APPENDIX 1**

**STANDARDS FOR CRASH PROTECTED ENCLOSURE**

**1 - Physical Size.**

As technology allows for increased miniaturisation, manufacturers continue to shrink the crash enclosure. Now, the enclosure can be very difficult to find in wreckage. The sum of the height (a), width (b), and depth (c) of the crash enclosure must be 23 cm (9 inches) or larger. Each of these major dimensions must be 5 cm (2 inches) or larger. Here are five examples of a crash enclosure and the minimum required dimensions:

NOTE: The dimensions of the crash protected enclosure shall not include the underwater locator beacon (ULB) or its attachment hardware.

**2 - Identification.**

Paint the crash enclosure according to CS 23.1459(g), 25.1459(g), 27.1459(g), or 29.1459(g) and mark in accordance with paragraph 4 of this ETSO.

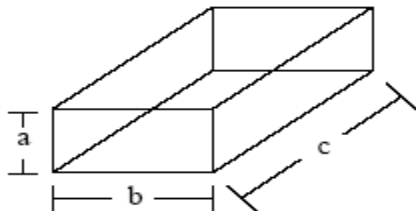

$$a, b, c \geq 5 \text{ cm (2 inches)}$$

$$a+b+c \geq 23 \text{ cm (9 inches)}$$

**Figure 1. Crash enclosure shaped like a rectangular prism.**

-----

Apply minimum dimensions to the major axis (a), minor axis (b), and length (c) of the enclosure.

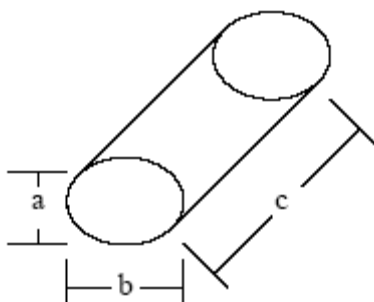

$$a, b, c \geq 5 \text{ cm (2 inches)}$$

$$a+b+c \geq 23 \text{ cm (9 inches)}$$

**Figure 2. Crash enclosure shaped like an elliptical cylinder.**

-----

Height, width, and depth are all equal to the diameter of the sphere which must be equal to or larger than 7.7 cm (3.0 inches) because of the,  $a + b + c \geq 23$  cm (9 inches), requirement.

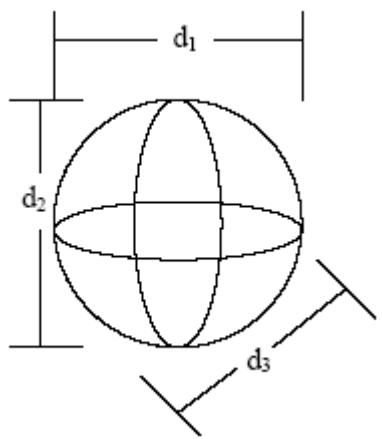

$d_i \geq 7.7$  cm (3 inches)  
 $d_1 + d_2 + d_3 \geq 23$  cm (9 inches)

**Figure 3. Crash enclosure shaped like a sphere.**

Dimensions a, b, and c are not necessarily equal

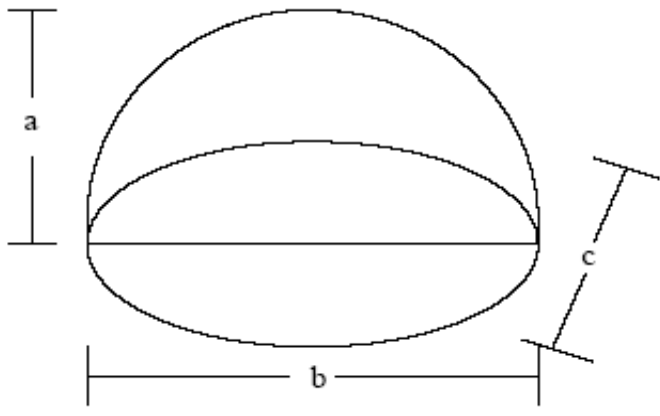

$a, b, c \geq 5$  cm (2 inches)  
 $a + b + c \geq 23$  cm (9 inches)

**Figure 4. Crash enclosure shaped like an ellipsoid hemisphere.**

Width (a) is the largest width of the enclosure, depth (b) is the largest depth of the enclosure and height (c) is the largest height of the enclosure. Take each of these major dimensions from the outer surface of the enclosure. Do not include any protrusions such as mounting flanges or plates.

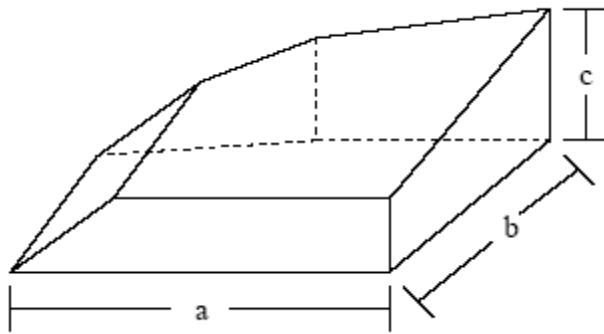

$$a, b, c \geq 5 \text{ cm (2 inches)}$$

$$a+b+c \geq 23 \text{ cm (9 inches)}$$

**Figure 5. Crash enclosure is generically shaped.**

# European Aviation Safety Agency

## European Technical Standard Order

Subject: LARGE AEROPLANE WHEELS AND WHEEL AND BRAKE ASSEMBLIES

### 1 - Applicability

This ETSO prescribes the minimum performance standard that large aeroplane wheels, and wheel and brake assemblies must meet to be identified with the applicable ETSO marking. Brakes and associated wheels are to be considered as an assembly for ETSO authorisation purposes.

### 2 - Procedures

#### 2.1 - General

Applicable procedures are detailed in CS-ETSO Subpart A.

#### 2.2 - Specific

##### 2.2.1 - Data Requirements.

2.2.1.1 - In addition to the data specified in CS-ETSO Subpart A, the manufacturer must furnish one copy each of the following to the Agency:

2.2.1.2 - The applicable limitations pertaining to installation of wheels or wheel and brake assemblies on aeroplane(s), including the data requirements of paragraph 4.1 of Appendix 1 or Appendix 2 of this ETSO.

2.2.1.3 - The manufacturer's ETSO qualification test report.

##### 2.2.2 - Data to be furnished with Manufactured Articles.

2.2.2.1 - Prior to entry into service use, the manufacturer must make available to the Agency all applicable maintenance instructions and data necessary for continued airworthiness.

2.2.2.2 - The manufacturer must provide the applicable maintenance instructions and data necessary for continued airworthiness to each organisation or person receiving one or more articles manufactured under this ETSO. In addition, a note with the following statement must be included:

"The existence of ETSO approval of the article displaying the required marking does not automatically constitute the authority to install and use the article on an aeroplane. The conditions and tests required for ETSO approval of this article are minimum performance standards. It is the responsibility of those desiring to install this article either on or within a specific type or class of aeroplane to determine that the aeroplane operating conditions are within the ETSO standards. The article may be installed only if further evaluation by the user/installer documents an acceptable installation and the installation is approved by the Agency.

Additional requirements may be imposed based on aeroplane specifications, wheel and brake design, and quality control specifications. In-service maintenance, modifications, and use of replacement components must be in compliance with the performance standards of this ETSO, as well as any additional specific aeroplane requirements."

### **3 - Technical Conditions**

#### 3.1 - Basic

##### 3.1.1 - Minimum Performance Standard

###### 3.1.1.1 – Hydraulically actuated brakes and wheels

Standards set forth in Appendix 1.

###### 3.1.1.2 – Electrically actuated brakes and wheels

Standards set forth in Appendix 2 for the brakes plus the applicable requirements of Appendix 1 for the wheels.

##### 3.1.2 - Environmental Standard

None

##### 3.1.3 - Computer Software

None

#### 3.2 - Specific

None

### **4 - Marking**

#### 4.1 - General

In addition to the marking specified in CS-ETSO Subpart A paragraph 1.2; the following information shall be legibly and permanently marked on the major equipment components:

(i) Size (this marking applies to wheels only).

(ii) Hydraulic fluid type (this marking applies to hydraulic brakes only).

(iii) Serial Number.

4.1.1 All stamped, etched, or embossed markings must be located in non-critical areas.

#### 4.2 - Specific

None.

### **5 - Availability of Referenced Document**

See CS-ETSO Subpart A paragraph 3.

## APPENDIX 1

### MINIMUM PERFORMANCE SPECIFICATION FOR LARGE AEROPLANE WHEELS, BRAKES, AND WHEEL AND BRAKE ASSEMBLIES

#### CHAPTER 1

#### INTRODUCTION

##### 1.1 PURPOSE AND SCOPE.

This Minimum Performance Specification defines the minimum performance standards for wheels, brakes, and wheel and brake assemblies to be used on aeroplanes certificated under CS-25. Compliance with this specification is not considered approval for installation on any large aeroplane.

##### 1.2 APPLICATION.

Compliance with this minimum specification by the applicant is required as a means of assuring that the equipment will have the capability to satisfactorily perform its intended function(s).

**Note:** Certain performance capabilities may be affected by aeroplane operational characteristics and other external influences. Consequently, anticipated aeroplane braking performance should be verified by aeroplane testing.

##### 1.3 COMPOSITION OF EQUIPMENT.

The words "equipment" or "brake assembly" or "wheel assembly," as used in this document, include all components that form part of the particular unit.

For example, a wheel assembly typically includes a hub or hubs, bearings, flanges, drive bars, heat shields, and fuse plugs. A brake assembly typically includes a backing plate, torque tube, cylinder assemblies, pressure plate, heat sink, and temperature sensor.

It should not be inferred from these examples that each wheel assembly and brake assembly will necessarily include either all or any of the above example components; the actual assembly will depend on the specific design chosen by the applicant.

##### 1.4 DEFINITIONS AND ABBREVIATIONS.

###### 1.4.1 Brake Lining.

Brake lining is individual blocks of wearable material, discs that have wearable material integrally bonded to them, or discs in which the wearable material is an integral part of the disc structure.

###### 1.4.2 BROP<sub>MAX</sub> - Brake Rated Maximum Operating Pressure.

BROP<sub>MAX</sub> is the maximum design metered pressure that is available to the brake to meet aeroplane stopping performance requirements.

###### 1.4.3 BRP<sub>MAX</sub> - Brake Rated Maximum Pressure.

BRP<sub>MAX</sub> is the maximum pressure to which the brake is designed to be subjected (typically aeroplane nominal maximum system pressure).

###### 1.4.4 BRP<sub>RET</sub> - Brake Rated Retraction Pressure.

BRP<sub>RET</sub> is the pressure to which the brake inlet pressure must be reduced to cause full piston retraction after a brake is sufficiently pressurised to extend all pistons.

1.4.5 BRPP<sub>MAX</sub> - Brake Rated Maximum Parking Pressure.

BRPP<sub>MAX</sub> is the maximum parking pressure available to the brake.

1.4.6 BRWL - Brake Rated Wear Limit.

BRWL is the brake maximum wear limit to ensure compliance with paragraph 3.3.3, and, if applicable, paragraph 3.3.4 of this Appendix 1.

1.4.7 D - Distance Averaged Deceleration.

$D = ((\text{Initial brakes-on speed})^2 - (\text{Final brakes-on speed})^2) / (2 (\text{braked flywheel distance}))$ .

D is the distance averaged deceleration to be used in all deceleration calculations.

1.4.8 D<sub>DL</sub> - Rated Design Landing Deceleration.

D<sub>DL</sub> is the minimum of the distance averaged decelerations demonstrated by the wheel, brake and tyre assembly during the 100 KE<sub>DL</sub> stops in paragraph 3.3.2 of this Appendix 1

1.4.9 D<sub>RT</sub> - Rated Accelerate-Stop Deceleration.

D<sub>RT</sub> is the minimum of the distance averaged decelerations demonstrated by the wheel, brake, and tyre assembly during the KE<sub>RT</sub> stops in paragraph 3.3.3 of this Appendix 1

1.4.10 D<sub>SS</sub> - Rated Most Severe Landing Stop Deceleration.

D<sub>SS</sub> is the distance averaged deceleration demonstrated by the wheel, brake and tyre assembly during the KE<sub>SS</sub> Stop in paragraph 3.3.4 of this Appendix 1

1.4.11 Heat Sink.

The heat sink is the mass of the brake that is primarily responsible for absorbing energy during a stop. For a typical brake, this would consist of the stationary and rotating disc assemblies.

1.4.12 KE<sub>DL</sub> - Wheel/Brake Rated Design Landing Stop Energy.

KE<sub>DL</sub> is the minimum energy absorbed by the wheel/brake/tyre assembly during every stop of the 100 stop design landing stop test. (paragraph 3.3.2 of this Appendix 1).

1.4.13 KE<sub>RT</sub> - Wheel/Brake Rated Accelerate-Stop Energy.

KE<sub>RT</sub> is the energy absorbed by the wheel/brake/tyre assembly demonstrated in accordance with the accelerate-stop test in paragraph 3.3.3 of this Appendix 1

1.4.14 KE<sub>SS</sub> - Wheel/Brake Rated Most Severe Landing Stop Energy.

KE<sub>SS</sub> is the energy absorbed by the wheel/brake/tyre assembly demonstrated in accordance with paragraph 3.3.4 of this Appendix 1

1.4.15 L - Wheel Rated Radial Limit Load.

L is the wheel rated maximum radial limit load (paragraph 3.2.1 of this Appendix 1).

1.4.16 R - Wheel Rated Tyre Loaded Radius.

R is the static radius at load "S" for the wheel rated tyre size at WRP. The static radius is defined as the minimum distance from the axle centreline to the tyre/ground contact interface.



1.4.17 S -Wheel Rated Static Load.

S is the maximum static load (Reference CS 25.731(b)).

1.4.18 ST<sub>R</sub> - Wheel/Brake Rated Structural Torque.

ST<sub>R</sub> is the maximum structural torque demonstrated (paragraph 3.3.5 of this Appendix 1).

1.4.19 TS<sub>BR</sub> - Brake Rated Tyre Type(s) and Size(s).

TS<sub>BR</sub> is the tyre type(s) and size(s) used to achieve the KE<sub>DL</sub>, KE<sub>RT</sub>, and KE<sub>SS</sub> brake ratings. TS<sub>BR</sub> must be a tyre type and size approved for installation on the wheel (TS<sub>WR</sub>).

1.4.20 TS<sub>WR</sub> - Wheel Rated Tyre Type(s) and Size(s).

TS<sub>WR</sub> is the wheel rated tyre type(s) and Size(s) defined for use and approved by the aeroplane manufacturer for installation on the wheel.

1.4.21 TT<sub>BT</sub> - Suitable Tyre for Brake Tests.

TT<sub>BT</sub> is the rated tyre type and size.

TT<sub>BT</sub> is the tyre type and size that has been determined as being the most critical for brake performance and/or energy absorption tests. The TT<sub>BT</sub> must be a tyre type and size approved for installation on the wheel (TS<sub>WR</sub>). The suitable tyre may be different for different tests.

1.4.22 TT<sub>WT</sub> - Suitable Tyre for Wheel Test.

TT<sub>WT</sub> is the wheel rated tyre type and size for wheel test.

TT<sub>WT</sub> is the tyre type and size determined as being the most appropriate to introduce loads and/or pressure that would induce the most severe stresses in the wheel.

TT<sub>WT</sub> must be a tyre type and size approved for installation on the wheel (TS<sub>WR</sub>). The suitable tyre may be different for different tests.

1.4.23 V<sub>DL</sub> - Wheel/Brake Design Landing Stop Speed.

V<sub>DL</sub> is the initial brakes-on speed for a design landing stop (paragraph 3.3.2 of this Appendix 1).

1.4.24 V<sub>R</sub> - Aeroplane Maximum Rotation Speed.

1.4.25 V<sub>RT</sub> - Wheel/Brake Accelerate-Stop Speed.

V<sub>RT</sub> is the initial brakes-on speed used to demonstrate KE<sub>RT</sub> (paragraph 3.3.3 of this Appendix 1).

1.4.26 V<sub>SS</sub> - Wheel/Brake Most Severe Landing Stop Speed.

V<sub>SS</sub> is the initial brakes-on speed used to demonstrate KE<sub>SS</sub> (paragraph 3.3.4 of this Appendix 1).

1.4.27 WRP - Wheel Rated Inflation Pressure.

WRP is the wheel rated inflation pressure (wheel unloaded).

## CHAPTER 2

### GENERAL DESIGN SPECIFICATION

#### 2.1 AIRWORTHINESS.

The continued airworthiness of the wheels (without brakes) and wheel and brake assemblies must be considered. See chapter 4 of this Appendix 1, titled "DATA REQUIREMENTS".

#### 2.2 FIRE PROTECTION.

Except for small parts (such as fasteners, seals, grommets, and small electrical parts) that would not contribute significantly to the propagation of a fire, all solid materials used must be self-extinguishing. See also paragraphs 2.4.5, 3.3.3.5 and 3.3.4.5 of this Appendix 1.

#### 2.3 DESIGN.

Unless shown to be unnecessary by test or analysis, the equipment must comply with the following:

##### 2.3.1 Lubricant Retainers.

Lubricant retainers must retain the lubricant under all operating conditions, prevent the lubricant from reaching braking surfaces, and prevent foreign matter from entering the lubricated cavity.

##### 2.3.2 Removable Flanges.

All removable flanges must be assembled onto the wheel in a manner that will prevent the removable flanges and retaining devices from leaving the wheel if a tyre deflates while the wheel is rolling.

##### 2.3.3 Adjustment.

The brake mechanism must be equipped with suitable adjustment devices to maintain appropriate running clearance when subjected to BRP<sub>RET</sub>.

##### 2.3.4 Water Seal.

Wheels intended for use on amphibious aircraft must be sealed to prevent entrance of water into the wheel bearings or other portions of the wheel or brake, unless the design is such that brake action and service life will not be impaired by the presence of sea water or fresh water.

##### 2.3.5 Burst Prevention.

Means must be provided to prevent wheel failure and tyre burst that might result from over-pressurisation or from elevated brake temperatures. The means must take into account the pressure and the temperature gradients over the full operating range.

##### 2.3.6 Wheel Rim and Inflation Valve.

Tyre and Rim Association (Reference: Aircraft Year Book-Tyre and Rim Association Inc.) or, The European Tyre and Rim Technical Organisation (Reference: Aircraft Tyre and Rim Data Book) approval of the rim dimensions and inflation valve is encouraged.

##### 2.3.7 Brake Piston Retention.

The brake must incorporate means to ensure that the actuation system does not allow hydraulic fluid to escape if the limits of piston travel are reached.

2.3.8 Wear Indicator.

A reliable method must be provided for determining when the heat sink is worn to its permissible limit.

2.3.9 Wheel Bearings.

Means should be incorporated to avoid mis-assembly of wheel bearings.

2.3.10 Fatigue.

The design of the wheel must incorporate techniques to improve fatigue resistance of critical areas of the wheel and minimise the effects of the expected corrosion and temperature environment. The wheel must include design provisions to minimise the probability of fatigue failures that could lead to flange separation or other wheel burst failures.

2.3.11 Dissimilar Materials.

When dissimilar materials are used in the construction and the galvanic potential between the materials indicate galvanic corrosion is likely, effective means to prevent the corrosion must be incorporated in the design. In addition, differential thermal expansion must not unduly affect the functioning, load capability, and the fatigue life of the components.

2.4 CONSTRUCTION.

The suitability and durability of the materials used for components must be established on the basis of experience or tests. In addition, the materials must conform to approved specifications that ensure the strength and other properties are those that were assumed in the design.

2.4.1 Castings.

Castings must be of high quality, clean, sound, and free from blowholes, porosity, or surface defects caused by inclusions, except that loose sand or entrapped gases may be allowed when serviceability is not impaired.

2.4.2 Forgings.

Forgings must be of uniform condition, free from blisters, fins, folds, seams, laps, cracks, segregation, and other defects. Imperfections may be removed if strength and serviceability would not be impaired as a result.

2.4.3 Bolts and Studs.

When bolts or studs are used for fastening together sections of a wheel or brake, the length of the threads must be sufficient to fully engage the nut, including its locking feature, and there must be sufficient unthreaded bearing area to carry the required load.

2.4.4 Environmental Protection.

All the components used must be suitably protected against deterioration or loss of strength in service due to any environmental cause, such as weathering, corrosion, and abrasion.

2.4.5 Magnesium Parts.

Magnesium and alloys having magnesium as a major constituent must not be used on brakes or braked wheels.

## CHAPTER 3

### MINIMUM PERFORMANCE UNDER STANDARD TEST CONDITIONS

#### 3.1 INTRODUCTION.

The test conditions and performance criteria described in this chapter provide a laboratory means of demonstrating compliance with this ETSO minimum performance standard. The aeroplane manufacturer normally defines relevant test parameter values, however these may also be derived from published aircraft data for applicants for supplementary type certificates (STC).

#### 3.2 WHEEL TESTS.

To establish the ratings for a wheel, it must be substantiated that standard production wheel samples will meet the following radial load, combined load, roll load, roll-on-rim (if applicable) and overpressure test requirements.

For all tests, except the roll-on-rim test in paragraph 3.2.4 of this Appendix 1, the wheel must be fitted with a suitable tyre,  $TT_{WT}$ , and wheel loads must be applied through the tyre. The ultimate load tests in paragraphs 3.2.1.3 and 3.2.2.3 of this Appendix 1 provide for an alternative method of loading if it is not possible to conduct these tests with the tyre mounted.

##### 3.2.1 Radial Load Test.

If the radial limit load of paragraph 3.2.2 of this Appendix 1 is equal to or greater than the radial limit load in this paragraph, the test specified in this paragraph may be omitted.

Test the wheel for yield and ultimate loads as follows:

##### 3.2.1.1 Test method.

With a suitable tyre,  $TT_{WT}$ , installed, mount the wheel on its axle, and position it against a flat, non-deflecting surface. The wheel axle must have the same angular orientation to the non-deflecting surface that it will have to a flat runway when it is mounted on an aeroplane and is under the maximum radial limit load,  $L$ . Inflate the tyre to the pressure recommended for the Wheel Rated Static Load,  $S$ , with gas and/or liquid.

If liquid inflation is used, liquid must be bled off to obtain the same tyre deflection that would result if gas inflation were used.

Liquid pressure must not exceed the pressure that would develop if gas inflation were used and the tyre was deflected to its maximum extent. Load the wheel through its axle with the load applied perpendicular to the flat, non-deflecting surface. Deflection readings must be taken at suitable points to indicate deflection and permanent set of the wheel rim at the bead seat.

##### 3.2.1.2 Yield Load.

Apply to the wheel and tyre assembly a load not less than 1.15 times the maximum radial limit load,  $L$ , reference CS 25.471 through 25.511, as appropriate.

Determine the most critical wheel orientation with respect to the non-deflecting surface. Apply the load with the tyre loaded against the non-deflecting surface, and with the wheel rotated 90 degrees with respect to the most critical orientation. Repeat the loading with the wheel 180, 270, and 0 degrees from the most critical orientation. The bearing cups, cones, and rollers used in operation

must be used for these loadings. If at a point of loading during the test bottoming of the tyre occurs, then the tyre pressure may be increased an amount sufficient only to prevent bottoming.

Three successive loadings at the 0 degree position must not cause permanent set increments of increasing magnitude. The permanent set increment caused by the last loading at the 0 degree position may not exceed 5 percent of the deflection caused by that loading or 0.005 inches (0.125mm), whichever is greater. There must be no yielding of the wheel such as would result in loose bearing cups, liquid or gas leakage through the wheel or past the wheel seal.

### 3.2.1.3 Ultimate Load.

Apply to the wheel used in the yield test in paragraph 3.2.1.2 of this Appendix 1, and the tyre assembly, a load not less than 2 times the maximum radial limit load, L, for castings, and 1.5 times the maximum radial limit load, L, for forgings. Reference CS 25.471 through 25.511, as appropriate.

Apply the load with the tyre and wheel against the non-deflecting surface and the wheel positioned at 0 degree orientation (paragraph 3.2.1.2 of this Appendix 1). The bearing cones may be replaced with conical bushings, but the cups used in operation must be used for this loading. If, at a point of loading during the test, it is shown that the tyre will not successfully maintain pressure or if bottoming of the tyre occurs, the tyre pressure may be increased. If bottoming of the tyre continues to occur with increased pressure, then a loading block that fits between the rim flanges and simulates the load transfer of the inflated tyre may be used. The arc of the wheel supported by the loading block must be no greater than 60 degrees.

The wheel must support the load without failure for at least 3 seconds. Abrupt loss of load-carrying capability or fragmentation during the test constitutes failure.

### 3.2.2 Combined Radial and Side Load Test.

Test the wheel for the yield and ultimate loads as follows:

#### 3.2.2.1 Test Method.

With a suitable tyre,  $TT_{WT}$ , installed, mount the wheel on its axle and position it against a flat, non-deflecting surface. The wheel axle must have the same angular orientation to the non-deflecting surface that it will have to a flat runway when it is mounted on an aeroplane and is under the combined radial and side limit loads. Inflate the tyre to the pressure recommended for the maximum static load with gas and/or liquid.

If liquid inflation is used, liquid must be bled off to obtain the same tyre deflection that would result if gas inflation were used.

For the radial load component, load the wheel through its axle with load applied perpendicular to the flat non-deflecting surface. Apply the two loads simultaneously, increasing them either continuously or in increments no greater than 10 percent of the total loads to be applied.

If it is impossible to generate the side load because of friction limitations, the radial load may be increased, or a portion of the side load may be applied directly to the tyre/wheel. In such circumstances it must be demonstrated that the moment resulting from the side load is no less severe than would otherwise have occurred.

Alternatively, the vector resultant of the radial and side loads may be applied to the axle.

Deflection readings must be taken at suitable points to indicate deflection and permanent set of the wheel rim at the bead seat.

#### 3.2.2.2 Combined Yield Load.

Apply to the wheel and tyre assembly radial and side loads not less than 1.15 times the respective ground limit loads, reference CS 25.485, 25.495, 25.497, and 25.499, as appropriate. If at a point of loading during the test bottoming of the tyre occurs, then the tyre pressure may be increased an amount sufficient only to prevent bottoming.

Determine the most critical wheel orientation with respect to the non-deflected surface.

Apply the load with the tyre loaded against the non-deflecting surface, and with the wheel rotated 90 degrees with respect to the most critical orientation. Repeat the loading with the wheel 180, 270, and 0 degrees from the most critical orientation.

The bearing cups, cones, and rollers used in operation must be used in this test.

A tube may be used in a tubeless tyre only when it has been demonstrated that pressure will be lost due to the inability of a tyre bead to remain properly positioned under the load. The wheel must be tested for the most critical inboard and outboard side loads.

Three successive loadings at the 0 degree position must not cause permanent set increments of increasing magnitude. The permanent set increment caused by the last loadings at the 0 degree position must not exceed 5 percent of the deflection caused by the loading, or 0.005 inches (0.125mm), whichever is greater. There must be no yielding of the wheel such as would result in loose bearing cups, gas or liquid leakage through the wheel or past the wheel seal.

#### 3.2.2.3 Combined Ultimate Load.

Apply to the wheel, used in the yield test of paragraph 3.2.2.2 of this Appendix 1, radial and side loads not less than 2 times for castings and 1.5 times for forgings, the respective ground limit loads reference CS 25.485, 25.495, 25.497, and 25.499, as appropriate.

Apply these loads with a tyre and wheel against the non-deflecting surface and the wheel oriented at the 0 degree position (paragraph 3.2.2.2 of this Appendix 1). The bearing cones may be replaced with conical bushings, but the cups used in operation must be used for this loading.

If at any point of loading during the test it is shown that the tyre will not successfully maintain pressure, or if bottoming of the tyre on the non-deflecting surface occurs, the tyre pressure may be increased. If bottoming of the tyre continues to occur with this increased pressure, then a loading block that fits between the rim flanges and simulates the load transfer of the inflated tyre may be used. The arc of wheel supported by the loading block must be no greater than 60 degrees.

The wheel must support the loads without failure for at least 3 seconds. Abrupt loss of load-carrying capability or fragmentation during the test constitutes failure.

#### 3.2.3 Wheel Roll Test.

3.2.3.1 Test Method.

With a suitable tyre,  $TT_{WT}$ , installed, mount the wheel on its axle and position it against a flat non-deflecting surface or a flywheel. The wheel axle must have the same angular orientation to the non-deflecting surface that it will have to a flat runway when it is mounted on an aeroplane and is under the Wheel Rated Static Load,  $S$ . During the roll test, the tyre pressure must not be less than 1.14 times the Wheel Rated Inflation Pressure,  $WRP$ , (0.10 to account for temperature rise and 0.04 to account for loaded tyre pressure). For side load conditions, the wheel axle must be yawed to the angle that will produce a wheel side load component equal to 0.15  $S$  while the wheel is being roll tested.

3.2.3.2 Roll Test.

The wheel must be tested under the loads and for the distances shown in Table 3-1.

TABLE 3-1 Load Conditions and Roll Distances for Roll Test

Load Conditions	Roll Distance Miles (km)
Wheel Rated Static Load, $S$	2000 (3220)
Wheel Rated Static Load, $S$ , plus a 0.15x $S$ side load applied in the outboard direction	100 (161)
Wheel Rated Static Load, $S$ , plus a 0.15x $S$ side load applied in the inboard direction	100 (161)

At the end of the test, the wheel must not be cracked, there must be no leakage through the wheel or past the wheel seal(s), and the bearing cups must not be loose.

3.2.4 Roll-on-Rim Test (not applicable to nose wheels).

The wheel assembly without a tyre must be tested at a speed of no less than 10 mph (4.6 m/s) under a load equal to the Wheel Rated Static Load,

$S$ . The test roll distance (in feet) must be determined as  $0.5V_R^2$  but need not exceed 15,000 feet (4,572 meters). The test axle angular orientation with the load surface must represent that of the aeroplane axle to the runway under the static load  $S$ .

The wheel assembly must support the load for the distance defined above. During the test, no fragmentation of the wheel is permitted; cracks are allowed.

3.2.5 Overpressure Test.

The wheel assembly, with a suitable tyre,  $TT_{WT}$ , installed, must be tested to demonstrate that it can withstand the application of 4.0 times the wheel rated inflation pressure,  $WRP$ . The wheel must retain the pressure for at least 3 seconds. Abrupt loss of pressure containment capability or fragmentation during the test constitutes failure. Plugs may be used in place of over-pressurisation protection device(s) to conduct this test (reference CS 25.731(d)).

### 3.2.6 Diffusion Test.

A tubeless tyre and wheel assembly must hold its rated inflation pressure, WRP, for 24 hours with a pressure drop no greater than 5 percent. This test must be performed after the tyre growth has stabilised.

## 3.3 WHEEL AND BRAKE ASSEMBLY TESTS.

### 3.3.1 General.

3.3.1.1 The wheel and brake assembly, with a suitable tyre,  $TT_{BT}$ , installed, must be tested on a testing machine in accordance with the following, as well as paragraphs 3.3.2, 3.3.3, 3.3.5 and, if applicable, 3.3.4 of this Appendix 1

3.3.1.2 For tests detailed in paragraphs 3.3.2, 3.3.3, and 3.3.4 of this Appendix 1, the test energies  $KE_{DL}$ ,  $KE_{RT}$ , and  $KE_{SS}$  and brake application speeds  $V_{DL}$ ,  $V_{RT}$ , and  $V_{SS}$  are as normally defined by the aeroplane manufacturer.

3.3.1.3 For tests detailed in paragraphs 3.3.2, 3.3.3, and 3.3.4 of this Appendix 1, the initial brake application speed must be as close as practicable to, but not greater than, the speed established in accordance with paragraph 3.3.1.2 of this Appendix 1, with the exception that marginal speed increases are allowed to compensate for brake pressure release permitted in paragraphs 3.3.3.4 and 3.3.4.4 of this Appendix 1. An increase in the initial brake application speed is not a permissible method of accounting for a reduced (i.e., lower than ideal) dynamometer mass. This method is not permissible because, for a target test deceleration, a reduction in the energy absorption rate would result, and could produce performance different from that which would be achieved with the correct brake application speed. The energy to be absorbed during any stop must not be less than that established in accordance with paragraph 3.3.1.2 of this Appendix 1. Additionally, forced air or other artificial cooling means are not permitted during these stops.

3.3.1.4 The brake assembly must be tested using the fluid (or other actuating means) specified for use with the brake on the aeroplane.

### 3.3.2 Design Landing Stop Test.

3.3.2.1 The wheel and brake assembly under test must complete 100 stops at the  $KE_{DL}$  energy, each at the mean distance averaged deceleration,  $D$ , normally defined by the aeroplane manufacturer, but not less than  $10 \text{ ft/s}^2$  ( $3.05 \text{ m/s}^2$ ). (Reference CS 25.735(f)(1)).

3.3.2.2 During the design landing stop test, the disc support structure must not be changed if it is intended for reuse, or if the wearable material is integral to the structure of the disc. One change of individual blocks or integrally bonded wearable material is permitted. For discs using integrally bonded wearable material, one change is permitted, provided that the disc support structure is not intended for reuse. The remainder of the wheel/brake assembly parts must withstand the 100  $KE_{DL}$  stops without failure or impairment of operation.

### 3.3.3 Accelerate-Stop Test.

3.3.3.1 The wheel and brake assembly under test must complete the accelerate-stop test at the mean distance averaged deceleration,  $D$ , normally defined by the aeroplane manufacturer, but not less than  $6 \text{ ft/s}^2$  ( $1.83 \text{ m/s}^2$ ). (Reference CS 25.735(f)(2)).

This test establishes the maximum accelerate-stop energy rating,  $KE_{RT}$ , of the wheel and brake assembly using:

- a. The Brake Rated Maximum Operating Pressure,  $BROP_{MAX}$ ; or



b. The maximum brake pressure consistent with the aeroplane's braking pressure limitations (e.g. tyre/runway drag capability based on substantiated data).

3.3.3.2 For the accelerate-stop test, the tyre, wheel, and brake assembly must be tested at  $KE_{RT}$  for both a new brake and a fully worn brake.

a. A new brake is defined as a brake on which less than 5 percent of the usable wear range of the heat sink has been consumed.

b. A worn brake is defined as a brake on which the usable wear range of the heat sink has already been fully consumed to BRWL.

The proportioning of wear through the brake for the various friction pairs for this test must be based on service wear experience or wear test data of an equivalent or similar brake. Either operationally worn or mechanically worn brake components may be used. If mechanically worn components are used, it must be shown that they can be expected to provide similar results to operationally worn components. The test brake must be subjected to a sufficient number and type of stops to ensure that the brake's performance is representative of in-service use; at least one of these stops, with the brake near the fully worn condition, must be a design landing stop.

3.3.3.3 At the time of brake application, the temperatures of the tyre, wheel, and brake, particularly the heat sink, must, as closely as practicable, be representative of a typical in-service condition. Preheating by taxi stops is an acceptable means.

These temperatures must be based on a rational analysis of a braking cycle, taking into account a typical brake temperature at which an aeroplane may be dispatched from the ramp, plus a conservative estimate of heat sink temperature change during subsequent taxiing and takeoff acceleration, as appropriate.

Alternatively, in the absence of a rational analysis, the starting heat sink temperature must be that resulting from the application of 10 percent  $KE_{RT}$  to the tyre, wheel and brake assembly, initially at not less than normal ambient temperature (59°F/15°C).

3.3.3.4 A full stop demonstration is not required for the accelerate-stop test. The test brake pressure may be released at a test speed of up to 23 mph (10 m/s). In this case, the initial brakes-on speed must be adjusted such that the energy absorbed by the tyre, wheel and brake assembly during the test is not less than the energy absorbed if the test had commenced at the specified speed and continued to zero ground speed.

3.3.3.5 Within 20 seconds of completion of the stop, or of the brake pressure release in accordance with paragraph 3.3.3.4 of this Appendix 1, the brake pressure must be adjusted to the Brake Rated Maximum Parking Pressure,  $BRPP_{MAX}$ , and maintained for at least 3 minutes (Reference CS 25.735(g)).

No sustained fire that extends above the level of the highest point of the tyre is allowed before 5 minutes have elapsed after application of parking brake pressure; until this time has elapsed, neither fire fighting means nor coolants may be applied.

The time of initiation of tyre pressure release (e.g., by wheel fuse plug), if applicable, is to be recorded. The sequence of events described in paragraphs 3.3.3.4 and 3.3.3.5 of this Appendix 1 is illustrated in figure 3-1.

### 3.3.4 Most Severe Landing Stop Test.

3.3.4.1 The wheel and brake assembly under test must complete the most severe landing braking condition expected on the aeroplane as normally defined by the aeroplane manufacturer. This test is not required if the testing required in paragraph 3.3.3 of this Appendix 1 is more severe or the condition is shown to be extremely improbable, normally by the aeroplane manufacturer.

This test establishes, if required, the maximum energy rating,  $KE_{SS}$ , of the wheel/brake assembly for landings under abnormal conditions using:

- a. The Brake Rated Maximum Operating Pressure,  $BROP_{MAX}$ ; or
- b. The maximum brake pressure consistent with an aeroplane's braking pressure limitations (e.g. tyre/runway drag capability based on substantiated data).

3.3.4.2 For the most severe landing stop test, the tyre, wheel and brake assembly must be capable of absorbing the test energy,  $KE_{SS}$ , with a brake on which the usable wear range of the heat sink has already been fully consumed to BRWL (Reference CS 25.735(f)(3)).

The proportioning of wear through the brake for the various friction pairs for this test must be based on service wear experience or wear test data of an equivalent or similar brake. Either operationally worn or mechanically worn brake components may be used. If mechanically worn components are used, it must be shown that they can be expected to provide similar results to operationally worn components. The test brake must be subjected to a sufficient number and type of stops to ensure that the brake's performance is representative of in-service use; at least one of these stops with the brake near the fully worn condition, must be a design landing stop.

3.3.4.3 At the time of brake application, the temperatures of the tyre, wheel, and brake, particularly the heat sink, must, as closely as practicable, be representative of a typical in-service condition. Preheating by taxi stops is an acceptable means.

These temperatures must be based on a rational analysis of a braking cycle, taking into account a typical brake temperature at which the aeroplane may be dispatched from the ramp, plus a conservative estimate of heat sink temperature change during taxi, takeoff, and flight, as appropriate.

Alternatively, in the absence of a rational analysis, the starting heat sink temperature must be that resulting from the application of 5 percent  $KE_{RT}$  to the tyre, wheel and brake assembly initially at not less than normal ambient temperature (59°F/15°C).

3.3.4.4 A full stop demonstration is not required for the most severe landing-stop test. The test brake pressure may be released at a test speed of up to 20 knots. In this case, the initial brakes-on speed must be adjusted such that the energy absorbed by the tyre, wheel, and brake assembly during the test is not less than the energy absorbed if the test had commenced at the specified speed and continued to zero ground speed.

3.3.4.5 Within 20 seconds of completion of the stop, or of the brake pressure release in accordance with paragraph 3.3.4.4 of this Appendix 1, the brake pressure must be adjusted to the Brake Rated Maximum Parking Pressure,  $BRPP_{MAX}$ , and maintained for at least 3 minutes.

No sustained fire that extends above the level of the highest point of the tyre is allowed before 5 minutes have elapsed after application of parking brake

pressure; until this time has elapsed, neither fire fighting means nor coolants may be applied.

The time of initiation of tyre pressure release (e.g., by wheel fuse plug), if applicable, is to be recorded. The sequence of events described in paragraphs 3.3.4.4 and 3.3.4.5 of this Appendix 1 is illustrated in Figure 3-2.

### 3.3.5 Structural Torque Test.

The Wheel/Brake Rated Structural Torque,  $ST_R$ , is equal to the torque demonstrated in the test defined in 3.3.5.1 of this Appendix 1.

3.3.5.1 Apply to the wheel, brake and tyre assembly, the radial load  $S$  and the drag load corresponding to the torque specified in paragraph 3.3.5.2 or 3.3.5.3 of this Appendix 1, as applicable, for at least 3 seconds. Rotation of the wheel must be resisted by a reaction force transmitted through the brake, or brakes, by the application of at least Brake Rated Maximum Operating Pressure,  $BROP_{MAX}$ , or equivalent. If such pressure or its equivalent is insufficient to prevent rotation, the friction surface may be clamped, bolted, or otherwise restrained while applying the pressure. A fully worn brake configuration, BRWL, must be used for this test. The proportioning of wear through the brake for the various friction pairs for this test must be based on service wear experience of an equivalent or similar brake or test machine wear test data. Either operationally worn or mechanically worn brake components may be used. An actuating fluid other than that specified for use on the aeroplane may be used for the structural torque test

3.3.5.2 For landing gear with one wheel per landing gear strut, the torque is  $1.2(SxR)$ .

3.3.5.3 For landing gear with more than one wheel per landing gear strut, the torque is  $1.44(SxR)$ .

3.3.5.4 The wheel and brake assembly must support the loads without failure for at least 3 seconds.

### 3.3.6 Wheel to Brake Clearance

There must be no interference in any critical areas between the wheel and brake assembly (with fittings) up to limit load conditions, taking into account the axle angular orientation. Lack of interference can be established by analyses and/or tests. If chosen, testing shall be conducted per the following methods:

#### 3.3.6.1 Radial Limit Load Wheel and Brake Clearance Test.

With a suitable tyre, TTWT, installed, mount the wheel and brake on a suitable axle, and position it against a flat, non-deflecting surface. The wheel axle must have the same angular orientation to the non-deflecting surface that it will have to a flat runway when it is mounted on an airplane and is under the maximum radial limit load,  $L$ .

Inflate the tyre to the pressure recommended for the Wheel Rated Static Load,  $S$ , with gas and/or liquid. If liquid inflation is used, liquid must be bled off to obtain the same tire deflection that would result if gas inflation were used. Liquid pressure must not exceed the pressure that would develop if gas inflation were used and the tyre was deflected to its maximum extent. Load the wheel through its axle with the load applied perpendicular to the flat, non-deflecting surface. Reference CS 25.471 through 25.511, as appropriate. If the radial limit load of paragraph 3.3.6.2 of this Appendix 1 is equal to or greater than the radial limit load specified in this paragraph, the test specified in this paragraph may be omitted.

Determine the most critical wheel orientation with respect to the non-deflecting surface. Apply the load with the tire loaded against the non-deflecting surface. If multiple critical orientations are determined, repeat the testing for each critical orientation. The bearing cups, cones, and rollers used in operation must be used for this loading. If at a point of loading during the test bottoming of the tire occurs, then the tire pressure may be increased an amount sufficient only to prevent bottoming.

#### 3.3.6.2 Combined Limit Load Wheel and Brake Clearance Test.

With a suitable tyre,  $TT_{WT}$ , installed, mount the wheel and brake on a suitable axle, and position it against a flat, non-deflecting surface. The wheel axle must have the same angular orientation to the non-deflecting surface that it will have to a flat runway when it is mounted on an airplane and is under the maximum radial limit load, L. Apply to the wheel and tyre assembly radial and side loads not less than the respective ground limit loads. Reference, CS 25.485, 25.495, 25.497, and 25.499, as appropriate.

If at a point of loading during the test bottoming of the tyre occurs, then the tyre pressure may be increased an amount sufficient only to prevent bottoming.

Determine the most critical wheel orientation with respect to the non-deflected surface.

Apply the load with the tyre loaded against the non-deflecting surface with the wheel in the most critical orientation.

The bearing cups, cones, and rollers used in operation must be used in this test.

A tube may be used in a tubeless tire only when it has been demonstrated that pressure will be lost due to the inability of a tyre bead to remain properly positioned under the load. The wheel must be tested for the most critical inboard and outboard side loads. If multiple critical orientations are determined to apply, repeat the testing for each critical orientation.

### 3.4 BRAKE TESTS.

The brake assembly must be tested using the fluid (or other actuating means) specified for use with the brake on the aeroplane. It must be substantiated that standard production samples of the brake will pass the following tests:

#### 3.4.1 Yield & Overpressure Test.

The brake must withstand a pressure equal to 1.5 times  $BRP_{MAX}$  for at least 5 minutes without permanent deformation of the structural components under test.

The brake, with actuator piston(s) extended to simulate a maximum worn condition, must, for at least 3 seconds, withstand hydraulic pressure equal to 2.0 times the Brake Rated Maximum Pressure,  $BRP_{MAX}$ , available to the brakes. If necessary, piston extension must be adjusted to prevent contact with retention devices during this test.

#### 3.4.2 Endurance Test.

A brake assembly must be subjected to an endurance test during which structural failure or malfunction must not occur. If desired, the heat sink components may be replaced by a reasonably representative dummy mass for this test.

The test must be conducted by subjecting the brake assembly to 100,000 cycles of an application of the average of the peak brake pressures needed in the design landing stop test (paragraph 3.3.2 of this Appendix 1) and release to a pressure not exceeding the Brake Rated Retraction Pressure,  $BRP_{RET}$ . The pistons must be adjusted so that 25,000 cycles are performed at each of the four positions where the pistons would be at

rest when adjusted to nominally 25, 50, 75, and 100 percent of the wear limit, BRWL. The brake must then be subjected to 5000 cycles of application of pressure to  $BRP_{MAX}$  and release to  $BRP_{RET}$  at the 100 percent wear limit.

Hydraulic brakes must not exceed a total leakage of 5cc during the test.

#### 3.4.3 Piston Retention.

The hydraulic pistons must be positively retained without leakage at 1.5 times  $BRP_{MAX}$  for at least 10 seconds with the heat sink removed.

#### 3.4.4 Extreme Temperature Soak Test.

Hydraulic brakes must not exceed a total leakage of 5cc during the following tests.

Subject the brake to at least a 24-hour hot soak at the maximum piston housing fluid temperature experienced during a design landing stop test (paragraph 3.3.2 of this Appendix 1), conducted without forced air cooling. While at the hot soak temperature, the brake must be subjected to the application of the average of the peak brake pressures required during the 100 design landing stops and release to a pressure not exceeding  $BRP_{RET}$  for 1000 cycles, followed by 25 cycles of  $BROP_{MAX}$  and release to a pressure not exceeding  $BRP_{RET}$ .

The brake must then be cooled from the hot soak temperature to a cold soak temperature of  $-40^{\circ}F$  ( $-40^{\circ}C$ ) and maintained at this temperature for at least 24 hours. While at the cold soak temperature, the brake must be subjected to the application of the average of the peak brake pressures required during the  $KE_{DL}$  stops and release to a pressure not exceeding  $BRP_{RET}$ , for 25 cycles, followed by 5 cycles of  $BROP_{MAX}$  and release to a pressure not exceeding  $BRP_{RET}$ .

#### 3.4.5 Leakage Tests (Hydraulic Brakes).

##### 3.4.5.1 Static Leakage Test.

The brake must be subjected to a pressure equal to 1.5 times  $BRP_{MAX}$  for at least 5 minutes. The brake pressure must then be adjusted to an operating pressure of 5 psig (35 kPa) for at least 5 minutes. There must be no measurable leakage (less than one drop) during this test.

##### 3.4.5.2 Dynamic Leakage Test.

The brake must be subjected to 25 applications of  $BRP_{MAX}$ , each followed by the release to a pressure not exceeding  $BRP_{RET}$ . Leakage at static seals must not exceed a trace. Leakage at moving seals must not exceed one drop of fluid per each 3 inches (76mm) of peripheral seal length.

## CHAPTER 4

### DATA REQUIREMENTS

4.1 The applicant must provide the following data with any application for approval of equipment.

4.1.1 The following wheel and brake assembly ratings:

a. Wheel Ratings.

Wheel Rated Static Load,  $S$ ,  
Wheel Rated Inflation Pressure,  $WRP$ ,  
Wheel Rated Tyre Loaded Radius,  $R$ .  
Wheel Rated Maximum Limit Load,  $L$ ,  
Wheel Rated Tyre Size,  $TS_{WR}$ .

b. Wheel/Brake and Brake Ratings.

Wheel/Brake Rated Design Landing Energy,  $KE_{DL}$ , and associated brakes-on-speed,  $V_{DL}$ ,  
Wheel/Brake Rated Accelerate-Stop Energy,  $KE_{RT}$ , and associated brakes-on-speed,  $V_{RT}$ ,  
Wheel/Brake Rated Most Severe Landing Stop Energy,  $KE_{SS}$ , and associated brakes-on-speed,  $V_{SS}$  (if applicable),  
Brake Rated Maximum Operating Pressure,  $BROP_{MAX}$ ,  
Brake Rated Maximum Pressure,  $BRP_{MAX}$ ,  
Brake Rated Retraction Pressure,  $BRP_{RET}$ ,  
Wheel/Brake Rated Structural Torque,  $ST_R$ ,  
Rated Design Landing Deceleration,  $D_{DL}$ ,  
Rated Accelerate-Stop Deceleration,  $D_{RT}$ ,  
Rated Most Severe Landing Stop Deceleration,  $D_{SS}$  (if applicable),  
Brake Rated Tyre Size,  $TS_{BR}$ ,  
Brake Rated Wear Limit, BRWL.

4.1.2 The weight of the wheel or brake, as applicable.

4.1.3 Specification of hydraulic fluid used, as applicable.

4.1.4 One copy of the test report showing compliance with the test requirements.

NOTE: When test results are being recorded for incorporation in the compliance test report, it is not sufficient to note merely that the specified performance was achieved. The actual numerical values obtained for each of the parameters tested must be recorded, except where tests are pass/fail in character.

4.2 Prior to entry into service, a component maintenance manual (CMM), covering periodic maintenance, calibration, and repair, for the continued airworthiness of installed wheels and wheel and brake assemblies, including recommended inspection intervals and service life.

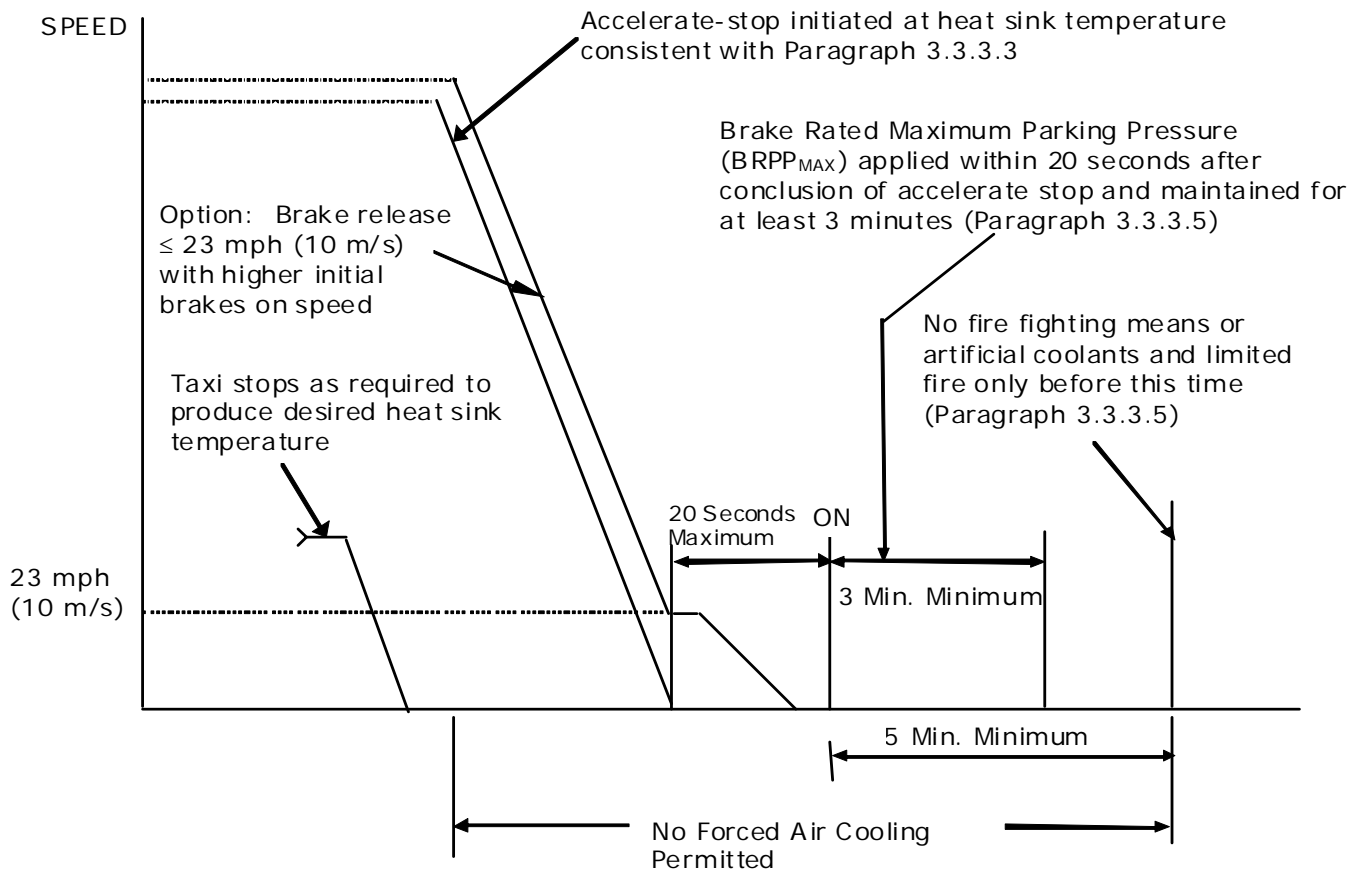

**Figure 3-1. Taxi, Accelerate-Stop, Park Test Sequence**

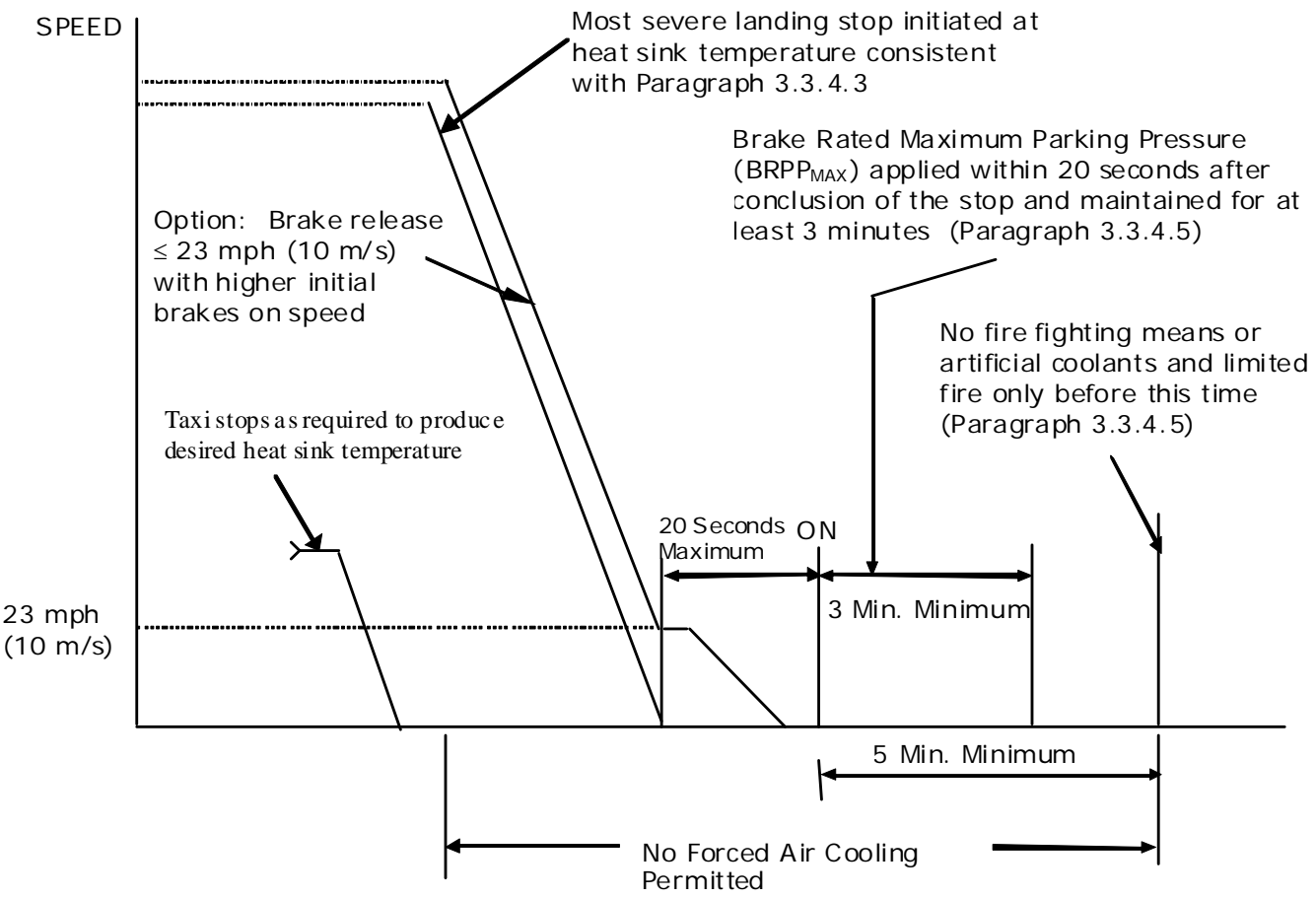

**Figure 3-2. Most Severe Landing-Stop, Park Test Sequence**



## APPENDIX 2.

### MPS FOR LARGE AEROPLANE WHEEL AND BRAKE ASSEMBLIES FOR ELECTRICALLY ACTUATED BRAKES

#### CHAPTER 1

#### INTRODUCTION

##### 1.1 PURPOSE AND SCOPE.

This Minimum Performance Specification defines the minimum performance standards for wheels, brakes, and wheel and brake assemblies to be used on aeroplanes certificated under CS-25. Compliance with this specification is not considered approval for installation on any Large Aeroplane.

##### 1.2 APPLICATION.

Compliance with this minimum specification by the applicant is required as a means of assuring that the equipment will have the capability to satisfactorily perform its intended function(s).

**Note:** Certain performance capabilities may be affected by aeroplane operational characteristics and other external influences. Consequently, anticipated aeroplane braking performance should be verified by aeroplane testing.

##### 1.3 COMPOSITION OF EQUIPMENT.

The words "equipment" or "brake assembly" or "wheel assembly," as used in this document, include all components that form part of the particular unit.

For example, a wheel assembly typically includes a hub or hubs, bearings, flanges, drive bars, heat shields, and fuse plugs. A brake assembly typically includes a backing plate, torque tube, electro-mechanical actuators, pressure plate, heat sink, temperature sensor, and other axle mounted components integral to the braking activity.

For the purpose of this specification, the interface boundaries of the equipment are the wheel and brake attachments to the landing gear and the electrical connectors to the aircraft brake control system.

It should not be inferred from these examples that each wheel assembly and brake assembly will necessarily include either all or any of the above example components; the actual assembly will depend on the specific design chosen by the applicant.

##### 1.4 DEFINITIONS AND ABBREVIATIONS.

###### 1.4.1 Brake Lining.

Brake lining is individual blocks of wearable material, discs that have wearable material integrally bonded to them, or discs in which the wearable material is an integral part of the disc structure.

###### 1.4.2 BOP – Brake Off Position

BOP is a retracted EMA position that permits free rotation of the wheel and brake assembly after a brake application and release cycle.

###### 1.4.3 BRWL - Brake Rated Wear Limit.

BRWL is the brake maximum wear limit to ensure compliance with paragraph 3.3.3, and, if applicable, paragraph 3.3.4 of this Appendix 2.

###### 1.4.4 D - Distance Averaged Deceleration.

$D = (\text{Initial brakes-on speed})^2 - (\text{Final brakes-on speed})^2 / (2(\text{braked flywheel distance}))$

D is the distance averaged deceleration to be used in all deceleration calculations.

1.4.5 D<sub>DL</sub> - Rated Design Landing Deceleration.

D<sub>DL</sub> is the minimum of the distance averaged decelerations demonstrated by the wheel, brake and tire assembly during the 100 KE<sub>DL</sub> stops in paragraph 3.3.2 of this Appendix 2.

1.4.6 D<sub>RT</sub> - Rated Accelerate-Stop Deceleration.

D<sub>RT</sub> is the minimum of the distance averaged decelerations demonstrated by the wheel, brake, and tire assembly during the KE<sub>RT</sub> stops in paragraph 3.3.3 of this Appendix 2.

1.4.7 D<sub>SS</sub> - Rated Most Severe Landing Stop Deceleration.

D<sub>SS</sub> is the distance averaged deceleration demonstrated by the wheel, brake and tire assembly during the KE<sub>SS</sub> Stop in paragraph 3.3.4 of this Appendix 2.

1.4.8 EMA – Electro-Mechanical Actuator

The EMA is the brake subassembly, typically comprised of but not limited to, the ball screw or roller screw, electric motor, and gear train that converts electrical power to brake clamping force.

1.4.9 Heat Sink.

The heat sink is the mass of the brake that is primarily responsible for absorbing energy during a stop. For a typical brake, this would consist of the stationary and rotating disc assemblies.

1.4.10 I<sub>BMAX</sub> - Maximum Brake Current

I<sub>BMAX</sub> is the maximum current drawn by the brake in the most critical of the dynamic tests of paragraph 3.3.3 or 3.3.4 of this Appendix 2. as determined by test or analysis of test results.

1.4.11 I<sub>SMAX</sub> – Maximum Brake System Current

I<sub>SMAX</sub> is the maximum current the aircraft brake control system can deliver to the brake assembly in normal operation.

1.4.12 KE<sub>DL</sub> - Wheel/Brake Rated Design Landing Stop Energy.

KE<sub>DL</sub> is the minimum energy absorbed by the wheel/brake/tire assembly during every stop of the 100 stop design landing stop test in paragraph 3.3.2 of this Appendix 2.

1.4.13 KE<sub>RT</sub> - Wheel/Brake Rated Accelerate-Stop Energy.

KE<sub>RT</sub> is the energy absorbed by the wheel/brake/tire assembly demonstrated in accordance with the accelerate-stop test in paragraph 3.3.3 of this Appendix 2.

1.4.14 KE<sub>SS</sub> - Wheel/Brake Rated Most Severe Landing Stop Energy.

KE<sub>SS</sub> is the energy absorbed by the wheel/brake/tire assembly demonstrated in accordance with paragraph 3.3.4 of this Appendix 2.

1.4.15 L<sub>BMAX</sub> - Maximum Brake Load

L<sub>BMAX</sub> is the nominal maximum clamping load the brake is designed to generate with maximum brake control system command under normal conditions established by analysis or test.

1.4.16 L<sub>DL</sub> - Brake Design Landing Load

$L_{DL}$  is the average of the 100 peak clamping loads generated in the brake assembly during the  $KE_{DL}$  stop test of paragraph 3.3.2 of this Appendix 2 as determined by test or analysis of test results.

#### 1.4.17 $L_{LMT}$ - Brake Limit Load

$L_{LMT}$  is the maximum clamping load the brake structure may be subjected to in its operation which would not result in permanent deformation that would prevent it from performing its intended function.

#### 1.4.18 $P_{BMAX}$ - Maximum EMA Brake Power

$P_{BMAX}$  is the maximum power supplied to the brake during the most critical of the dynamic tests of Section 3 of this Appendix 2 as determined by test or analysis of test results.

#### 1.4.19 $P_{SMAX}$ - Maximum Brake System Power

$P_{SMAX}$  is the maximum power that is available to the brake assembly from the aircraft brake control system.

#### 1.4.20 PBC – Parking Brake Command

PBC is the configuration to which the EMAs are commanded following a high energy stop as normally defined by the aeroplane manufacturer associated with the parking brake applications in paragraphs 3.3.3.5 and 3.3.4.5 of this Appendix 2.

#### 1.4.21 R - Wheel Rated Tyre Loaded Radius.

R is the static radius at load "S" for the wheel rated tyre size at WRP. The static radius is defined as the minimum distance from the axle centreline to the tyre/ground contact interface.

#### 1.4.22 S -Wheel Rated Static Load.

S is the maximum static load (Reference CS 25.731(b)).

#### 1.4.23 $ST_R$ - Wheel/Brake Rated Structural Torque.

$ST_R$  is the maximum structural torque demonstrated in paragraph 3.3.5 of this Appendix 2.

#### 1.4.24 $TS_{BR}$ - Brake Rated Tyre Type(s) and Size(s).

$TS_{BR}$  is the tyre type(s) and size(s) used to achieve the  $KE_{DL}$ ,  $KE_{RT}$ , and  $KE_{SS}$  brake ratings.  $TS_{BR}$  must be a tyre type and size approved for installation on the wheel ( $TS_{WR}$ ).

#### 1.4.25 $TS_{WR}$ - Wheel Rated Tyre Type(s) and Size(s).

$TS_{WR}$  is the wheel rated tyre type(s) and Size(s) defined for use and approved for installation on the wheel ( $TS_{WR}$ ), normally by the aeroplane manufacturer.

#### 1.4.26 $TT_{BT}$ - Suitable Tire for Brake Tests.

$TT_{BT}$  is the rated tire type and size.

$TT_{BT}$  is the tyre type and size that has been determined as being the most critical for brake performance and/or energy absorption tests. The  $TT_{BT}$  must be a tyre type and size approved for installation on the wheel ( $TS_{WR}$ ), normally by the aeroplane manufacturer. The suitable tyre may be different for different tests.

#### 1.4.27 $V_{BMAX}$ - Maximum EMA Brake Voltage

$V_{BMAX}$  is the maximum voltage applied to the brake assembly during the most critical of the dynamic tests of Section 3 of this Appendix 2 as determined by test or analysis of test results.

#### 1.4.28 $V_{SMAX}$ – Maximum Brake System Voltage

$V_{SMAX}$  is the maximum voltage that is available to the brake assembly from the aircraft brake control system.

#### 1.4.29 $V_{DL}$ - Wheel/Brake Design Landing Stop Speed

$V_{DL}$  is the initial brakes-on speed for a design-landing stop in paragraph 3.3.2 of this Appendix 2.

#### 1.4.30 $V_{RT}$ – wheel/brake accelerate-stop speed

$V_{RT}$  is the initial brakes-on speed used to demonstrate  $KE_{RT}$  in paragraph 3.3.3 of this Appendix 2.

#### 1.4.31 $V_{SS}$ - wheel/brake most severe landing stop speed

$V_{SS}$  is the initial brakes-on speed used to demonstrate  $KE_{SS}$  in paragraph 3.3.4 of this Appendix 2.

## CHAPTER 2

### GENERAL DESIGN SPECIFICATIONS

#### 2.1 AIRWORTHINESS

The continued airworthiness of the wheels and wheel and brake assemblies must be considered. See paragraph 4 of this Appendix 2 titled "DATA REQUIREMENTS".

#### 2.2 FIRE PROTECTION

Except for small parts such as fasteners, seals, grommets, and small electrical parts that would not contribute significantly to the propagation of a fire, all solid materials used must be self-extinguishing. See also paragraphs 2.4.5, 3.3.3.5 and 3.3.4.5 of this Appendix 2.

#### 2.3 DESIGN

Unless shown to be unnecessary by test or analysis, the equipment must comply with the following:

##### 2.3.1 Lubricant Retainers

Lubricant retainers must retain the lubricant under all operating conditions, prevent the lubricant from reaching braking surfaces, and prevent foreign matter from entering the lubricated cavity.

##### 2.3.2 Brake Release And Wear Adjustment

The brake assembly and its control system must provide a suitable means to maintain an appropriate running clearance throughout the entire heat sink wear and thermal range when no braking is commanded.

##### 2.3.3 Wear Indicator

A reliable method must be provided for determining when the heat sink is worn to its permissible limit.

##### 2.3.4 Dissimilar Materials

When dissimilar materials are used in the construction and the galvanic potential between the materials indicate galvanic corrosion is likely, effective means to prevent the corrosion must be incorporated in the design. In addition, differential thermal expansion must not unduly affect the functioning, load capability, and the fatigue life of the components.

#### 2.3.5 Insulation Resistance

The equipment shall have an adequate insulation resistance level to ensure the design is robust to leakage current paths in accordance with established industry standards.

#### 2.3.6 Dielectric Strength

The equipment shall have a suitable dielectric withstanding capability for the voltages and voltage surges to which it will be subjected in accordance with established industry standards.

#### 2.3.7 Bonding, Grounding

The equipment shall employ suitable electrical bonding and grounding techniques in its design to protect ground personnel and the equipment, from fault currents and from the potentially high voltages that may be present, in accordance with established industry standards.

### 2.4 CONSTRUCTION

The suitability and durability of the materials used for components must be established on the basis of experience or tests. In addition, the materials must conform to approved specifications that ensure the strength and other properties are those that were assumed in the design.

#### 2.4.1 Castings

Castings must be of high quality, clean, sound, and free from blowholes, porosity, or surface defects caused by inclusions, except that loose sand or entrapped gases may be allowed when serviceability is not impaired.

#### 2.4.2 Forgings

Forgings must be of uniform condition, free from blisters, fins, folds, seams, laps, cracks, segregation, and other defects. Imperfections may be removed if strength and serviceability would not be impaired as a result.

#### 2.4.3 Bolts and Studs

When bolts or studs are used for fastening together sections of a wheel or brake, the length of the threads must be sufficient to fully engage the nut, including its locking feature, and there must be sufficient unthreaded bearing area to carry the required load.

#### 2.4.4 Environmental Protection

All the components used must be suitably protected against deterioration or loss of strength in service due to any environmental cause, such as weathering, corrosion, and abrasion.

#### 2.4.5 Magnesium Parts

Magnesium and alloys having magnesium, as a major constituent, must not be used on brakes or braked wheels.

## CHAPTER 3

### MINIMUM PERFORMANCE UNDER STANDARD TEST CONDITIONS

#### 3.1 INTRODUCTION

The test conditions and performance criteria described in this chapter provide a laboratory means of demonstrating compliance with this ETSO minimum performance standard. The aeroplane manufacturer normally defines relevant test parameter values, however these may also be derived from published aircraft data for applicants for supplementary type certificates (STC).

#### 3.2 WHEEL TESTS

The wheel should be tested, results documented, and reported per Appendix 1, paragraphs 3.2, 4.1.1(a) and 4.1.4.

#### 3.3 WHEEL AND BRAKE ASSEMBLY TESTS.

##### 3.3.1 General

3.3.1.1 The wheel and brake assembly, with a suitable tyre,  $TT_{BT}$ , installed, must be tested on a testing machine in accordance with the following, as well as paragraphs 3.3.2, 3.3.3, 3.3.5 and, if applicable, 3.3.4 of this Appendix 2.

3.3.1.2 For tests detailed in paragraphs 3.2.2, 3.3.3, and 3.3.4 of this Appendix 2 the test energies  $KE_{DL}$ ,  $KE_{RT}$ , and  $KE_{SS}$  and brake application speeds  $V_{DL}$ ,  $V_{RT}$  and  $V_{SS}$  are as normally defined by the aeroplane manufacturer.

3.3.1.3 For tests detailed in paragraphs 3.3.2, 3.3.3, and 3.3.4 of this Appendix 2 the initial brake application speed must be as close as practicable to, but not greater than the speed established in accordance with paragraph 3.3.1.2 of this Appendix 2, with the exception that marginal speed increases are allowed to compensate for brake clamping force release permitted in paragraphs 3.3.3.4 and 3.3.4.4 of this Appendix 2. An increase in the initial brake application speed is not a permissible method of accounting for a reduced (that is, lower than ideal) dynamometer mass. This method is not permissible because, for a target test deceleration, a reduction in the energy absorption rate would result, and could produce performance different from that which would be achieved with the correct brake application speed. The energy to be absorbed during any stop must not be less than that established in accordance with paragraph 3.3.1.2 of this Appendix 2. Additionally, forced air or other artificial cooling means are not permitted during these stops.

3.3.1.4 For brake stopping performance tests, the brake assembly must be tested using a control system and electrical power source providing representative characteristics of the actuating means to the EMAs, including limitations, specified for the aircraft braking system.  $I_{BMAX}$ ,  $V_{BMAX}$  and  $P_{BMAX}$  shall not exceed the capabilities of the aircraft brake control system,  $I_{SMAX}$ ,  $V_{SMAX}$  and  $P_{SMAX}$ , for which the equipment is intended.

3.3.1.5 For brake structural tests, the brake assembly may be tested with an alternate control system to that required for the brake stopping performance tests. The control system must be capable of structurally loading the EMA load path and brake structure to the static values required by the test conditions.

##### 3.3.2 Design Landing Stop Test

3.3.2.1 The wheel and brake assembly under test must complete 100 stops at the  $KE_{DL}$  energy, each at the mean distance averaged deceleration,  $D$ , normally

defined by the aeroplane manufacturer, but not less than 10 ft/s<sup>2</sup> (3.05 m/s<sup>2</sup>). (Reference CS 25.735(f)(1)).

3.3.2.2 During the design landing stop test, the disc support structure must not be changed if it is intended for reuse, or if the wearable material is integral to the structure of the disc. One change of individual blocks or integrally bonded wearable material is permitted. For discs using integrally bonded wearable material, one change is permitted, provided that the disc support structure is not intended for reuse. The remainder of the wheel/brake assembly parts must withstand the 100 KE<sub>DL</sub> stops without failure or impairment of operation.

### 3.3.3 Accelerate-Stop Test

3.3.3.1 The wheel and brake assembly under test must complete the accelerate-stop test at the mean distance averaged deceleration,  $D$ , normally defined by the aeroplane manufacturer, but not less than 6 ft/s<sup>2</sup> (1.83 m/s<sup>2</sup>). (Reference CS 25.735(f)(2)).

This test establishes the maximum accelerate-stop energy rating, KE<sub>RT</sub>, of the wheel and brake assembly using:

- a.  $I_{S_{MAX}}$ ,  $V_{S_{MAX}}$  and  $P_{S_{MAX}}$ ; or
- b. The maximum brake current, voltage and power inputs consistent with the airplane's braking force limitations (tyre/runway drag capability based on substantiated data).

3.3.3.2 For the accelerate-stop test, the tyre, wheel, and brake assembly must be tested at KE<sub>RT</sub> for both a new brake and a fully worn brake.

- a. A new brake is defined as a brake on which less than 5 percent of the usable wear range of the heat sink has been consumed.
- b. A worn brake is defined as a brake on which the usable wear range of the heat sink has already been fully consumed to BRWL.

The proportioning of wear through the brake for the various friction pairs for this test must be based on service wear experience or wear test data of an equivalent or similar brake. Either operationally worn or mechanically worn brake components may be used. If mechanically worn components are used, it must be shown that they can be expected to provide similar results to operationally worn components. The test brake must be subjected to a sufficient number and type of stops to ensure that the brake's performance is representative of in-service use; at least one of these stops, with the brake near the fully worn condition, must be a design landing stop.

3.3.3.3 At the time of brake application, the temperatures of the tyre, wheel, and brake assembly, particularly the heat sink and EMAs, must, as closely as practicable, be representative of a typical in-service condition. Preheating by taxi stops is an acceptable means.

These temperatures must be based on a rational analysis of a braking cycle, taking into account a typical brake temperature at which an airplane may be dispatched from the ramp, plus a conservative estimate of heat sink temperature change during subsequent taxiing and takeoff acceleration, as appropriate.

Alternatively, in the absence of a rational analysis, the starting heat sink and EMA temperatures must be that resulting from the application of 10 percent KE<sub>RT</sub> to the tyre, wheel and brake assembly, initially at not less than normal ambient temperature (59°F/15°C).

3.3.3.4 A full stop demonstration is not required for the accelerate-stop test. The test brake clamping force may be released at a test speed of up to 23 mph (10 m/s). In this case, the initial brakes-on speed must be adjusted such that the energy absorbed by the tyre, wheel and brake assembly during the test is not less than the energy absorbed if the test had commenced at the specified speed and continued to zero ground speed.

3.3.3.5 Within 20 seconds of completion of the stop, or of the brake clamping force release in accordance with paragraph 3.3.3.4 of this Appendix 2, apply the Parking Brake Command (PBC) and maintain for at least 3 minutes (reference CS 25.735(g)).

No sustained fire that extends above the level of the highest point of the tire is allowed before 5 minutes have elapsed after application of brake clamping force; until this time has elapsed, neither fire fighting means nor coolants may be applied.

The time of initiation of tyre pressure release (for example, by wheel fuse plug), if applicable, is to be recorded. The sequence of events described in paragraphs 3.3.3.4 and 3.3.3.5 is illustrated in Figure 3-1 of this Appendix 2.

#### 3.3.4 Most Severe Landing Stop Test

3.3.4.1 The wheel and brake assembly under test must complete the most severe landing braking condition expected on the aeroplane as normally defined by the aeroplane manufacturer. This test is not required if the testing required in paragraph 3.3.3 of this Appendix 2 is more severe or the condition is shown to be extremely improbable, normally by the aeroplane manufacturer.

This test establishes if required, the maximum energy rating,  $KE_{SS}$ , of the wheel/brake assembly for landings under abnormal conditions using:

- a.  $I_{SMAX}$ ,  $V_{SMAX}$  and  $P_{SMAX}$ ; or
- b. The maximum brake current, voltage and power inputs consistent with the airplane's braking force limitations (for example, tyre/runway drag capability based on substantiated data).

3.3.4.2 For the most severe landing stop test, the tyre, wheel, and brake assembly must be capable of absorbing the test energy,  $KE_{SS}$ , with a brake on which the usable wear range of the heat sink has already been fully consumed to BRWL (reference CS 25.735(f)(3)).

The proportioning of wear through the brake for the various friction pairs for this test must be based on service wear experience or wear test data of an equivalent or similar brake. Either operationally worn or mechanically worn brake components may be used. If mechanically worn components are used, it must be shown that they can be expected to provide similar results to operationally worn components. The test brake must be subjected to a sufficient number and type of stops to ensure that the brake's performance is representative of in-service use; at least one of these stops, with the brake near the fully worn condition, must be a design landing stop.

3.3.4.3 At the time of brake application, the temperatures of the tyre, wheel, and brake, particularly the heat sink and EMA, must, as closely as practicable, be representative of a typical in service condition. Preheating by taxi stops is an acceptable means.

These temperatures must be based on a rational analysis of a braking cycle, taking into account a typical brake temperature at which the airplane may be



dispatched from the ramp, plus a conservative estimate of heat sink temperature change during taxi, takeoff, and flight, as appropriate.

Alternatively, in the absence of a rational analysis, the starting heat sink and EMA temperatures must be that resulting from the application of 5 percent  $KE_{RT}$  to the tyre, wheel and brake assembly initially at not less than normal ambient temperature (59°F/15°C).

3.3.4.4 A full stop demonstration is not required for the most severe landing-stop test. The test brake clamping force may be released at a test speed of up to 23 mph (10 m/s). In this case, the initial brakes-on speed must be adjusted such that the energy absorbed by the tyre, wheel, and brake assembly during the test is not less than the energy absorbed if the test had commenced at the specified speed and continued to zero ground speed.

3.3.4.5 Within 20 seconds of completion of the stop, or of the brake clamping force release in accordance with paragraph 3.3.4.4 of this Appendix 2, apply the Parking Brake Command (PBC) and maintain for at least 3 minutes (reference CS 25.735(g)).

No sustained fire that extends above the level of the highest point of the tire is allowed before 5 minutes have elapsed after application of brake clamping force; until this time has elapsed, neither fire fighting means nor coolants may be applied.

The time of initiation of tyre pressure release (for example by wheel fuse plug), if applicable, is to be recorded. The sequence of events described in paragraphs 3.3.4.4 and 3.3.4.5 is illustrated in Figure 3-2 of this Appendix 2.

### 3.3.5 Structural Torque Test

The Wheel/Brake Rated Structural Torque, STR, is equal to the torque demonstrated in the test defined in paragraph 3.3.5.1 of this Appendix 2.

3.3.5.1 Apply to the wheel, brake and tyre assembly, the radial load  $S$  and the drag load corresponding to the torque specified in paragraphs 3.3.5.2 or 3.3.5.3 of this Appendix 2, as applicable, for at least 3 seconds. Rotation of the wheel must be resisted by a reaction force transmitted through the brake, or brakes, by the application of at least  $L_{BMAX}$ , or equivalent. If such clamping force or its equivalent is insufficient to prevent rotation, the friction surface may be clamped, bolted, or otherwise restrained while applying the clamping force. A fully worn brake configuration, BRWL, must be used for this test. The proportioning of wear through the brake for the various friction pairs for this test must be based on service wear experience of an equivalent or similar brake or test machine wear test data. Either operationally worn or mechanically worn brake components may be used. The EMA may be cooled and/or restrained at the source of electromotive force generation after initial application of  $L_{BMAX}$  in lieu of maintaining application of electrical current throughout the test.

3.3.5.2 For landing gear with one wheel per landing gear strut, the torque is  $1.2(SxR)$ .

3.3.5.3 For landing gear with more than one wheel per landing gear strut, the torque is  $1.44(SxR)$ .

3.3.5.4 The wheel and brake assembly must support the loads without failure for at least 3 seconds. Abrupt loss of load-carrying capability or fragmentation during the test constitutes failure.

### 3.3.6 Wheel to Brake Clearance

There must be no interference in any critical areas between the wheel and brake assembly (with fittings) up to limit load conditions, taking into account the axle angular orientation. Lack of interference can be established by analyses and/or tests. If chosen, testing shall be conducted per the following methods:

#### 3.3.6.1 Radial Limit Load Wheel and Brake Clearance Test.

With a suitable tyre,  $TT_{WT}$ , installed, mount the wheel and brake on a suitable axle, and position it against a flat, non-deflecting surface. The wheel axle must have the same angular orientation to the non-deflecting surface that it will have to a flat runway when it is mounted on an airplane and is under the maximum radial limit load, L.

Inflate the tyre to the pressure recommended for the Wheel Rated Static Load, S, with gas and/or liquid. If liquid inflation is used, liquid must be bled off to obtain the same tire deflection that would result if gas inflation were used. Liquid pressure must not exceed the pressure that would develop if gas inflation were used and the tyre was deflected to its maximum extent. Load the wheel through its axle with the load applied perpendicular to the flat, non-deflecting surface. Reference CS 25.471 through 25.511, as appropriate. If the radial limit load of paragraph 3.3.6.2 of this Appendix 2 is equal to or greater than the radial limit load specified in this paragraph, the test specified in this paragraph may be omitted.

Determine the most critical wheel orientation with respect to the non-deflecting surface. Apply the load with the tyre loaded against the non-deflecting surface. If multiple critical orientations are determined, repeat the testing for each critical orientation. The bearing cups, cones, and rollers used in operation must be used for this loading. If at a point of loading during the test bottoming of the tyre occurs, then the tyre pressure may be increased an amount sufficient only to prevent bottoming.

#### 3.3.6.2 Combined Limit Load Wheel and Brake Clearance Test.

With a suitable tyre,  $TT_{WT}$ , installed, mount the wheel and brake on a suitable axle, and position it against a flat, non-deflecting surface. The wheel axle must have the same angular orientation to the non-deflecting surface that it will have to a flat runway when it is mounted on an aeroplane and is under the maximum radial limit load, L. Apply to the wheel and tyre assembly radial and side loads not less than the respective ground limit loads. Reference CS 25.485, 25.495, 25.497, and 25.499, as appropriate. If at a point of loading during the test bottoming of the tyre occurs, then the tyre pressure may be increased an amount sufficient only to prevent bottoming.

Determine the most critical wheel orientation with respect to the non-deflected surface.

Apply the load with the tyre loaded against the non-deflecting surface with the wheel in the most critical orientation.

The bearing cups, cones, and rollers used in operation must be used in this test.

A tube may be used in a tubeless tyre only when it has been demonstrated that pressure will be lost due to the inability of a tyre bead to remain properly positioned under the load. The wheel must be tested for the most critical inboard and outboard side loads. If multiple critical orientations are determined to apply, repeat the testing for each critical orientation.

### 3.4 BRAKE TESTS

It must be substantiated that standard production samples of the brake will pass the following tests:

#### 3.4.1 Limit and Ultimate Load Test

Alternative control systems and artificial cooling of the electromotive devices may be used for the following tests if needed to generate and maintain the required clamping forces.

Limit Load: The brake must withstand for at least 5 seconds a force equal to the Brake Limit Load ( $L_{LMT}$ ) without permanent deformation that would prevent it from performing its intended function after the test.

Ultimate Load: The brake, with EMAs extended to simulate a maximum worn condition, must for at least 3 seconds withstand a force equal to 1.5 times  $L_{LMT}$ . If necessary, EMA extension may be adjusted to prevent interaction with any retention means during this test.

#### 3.4.2 Endurance Test

A brake assembly must be subjected to an endurance test during which structural failure or malfunction must not occur. If desired, the heat sink components may be replaced by a reasonably representative dummy mass for this test.

The test must be conducted by subjecting the brake assembly to 100,000 cycles of an application of the Brake Design Landing Load ( $L_{DL}$ ) in the design landing stop test (paragraph 3.3.2 of this Appendix 2) and release to the Brake Off Position (BOP). The EMAs must be adjusted so that the cycles are equally divided among at least five or more equally incremented wear positions, including the new and fully worn positions, BRWL.

The brake must then be subjected to 5000 cycles of application of force to the Maximum Brake Load ( $L_{BMAX}$ ) and release to BOP. The EMAs must be adjusted so that the cycles are equally divided between at least five or more equally incremented, wear positions including the new and fully worn positions, BRWL.

The brake assembly must meet the integrity requirements of paragraph 3.4.4 of this Appendix 2 at the completion of this test.

#### 3.4.3 Extreme Temperature Soak Test

Subject the brake to at least a 24-hour hot soak at the maximum actuator housing temperature experienced during a design landing stop test (paragraph 3.3.2 of this Appendix 2), conducted without forced air cooling. While at the hot soak temperature, the brake must be subjected to the application of the Brake Design Landing Load ( $L_{DL}$ ) required during the 100 design landing stops and release to BOP for 1000 cycles, followed by 25 cycles of Maximum Brake Load ( $L_{BMAX}$ ) and release to BOP.

The brake must then be cooled from the hot soak temperature to a cold soak temperature of  $-40^{\circ}\text{F}$  ( $-40^{\circ}\text{C}$ ) and maintained at this temperature for at least 24 hours. While at the cold soak temperature, the brake must be subjected to the application of the Brake Design Landing Load ( $L_{DL}$ ) required during the  $KE_{DL}$  stops and release to BOP, for 25 cycles, followed by 5 cycles of Maximum Brake Load ( $L_{BMAX}$ ) and release to BOP.

The brake assembly must meet the integrity requirements of paragraph 3.4.4 of this Appendix 2 at the completion of this test.

#### 3.4.4 Brake Assembly Integrity

The brake assembly shall meet the functional test requirements (acceptance tests) established to assure continued airworthiness.

## CHAPTER 4

### DATA REQUIREMENTS

4.1 The applicant must provide the following data with any application for approval of equipment:

4.1.1 The following wheel and brake assembly ratings:

a. Wheel Ratings

See Appendix 1, paragraph 4.1.1a.

b. Wheel/Brake and Brake Ratings

Wheel/Brake Rated Design Landing Energy,  $KE_{DL}$ , and associated brakes-on-speed,  $V_{DL}$   
Wheel/Brake Rated Accelerate-Stop Energy,  $KE_{RT}$ , and associated brakes-on-speed,  $V_{RT}$   
Wheel/Brake Rated Most Severe Landing Stop Energy,  $KE_{SS}$ , and associated brakes-on-speed,  $V_{SS}$  (if applicable)

Maximum Brake Load,  $L_{BMAX}$

Brake Limit Load,  $L_{LMT}$

Wheel/Brake Rated Structural Torque,  $ST_R$

Rated Design Landing Deceleration,  $D_{DL}$

Rated Accelerate-Stop Deceleration,  $D_{RT}$

Rated Most Severe Landing Stop Deceleration,  $D_{SS}$  (if applicable)

Brake Rated Tire Size,  $TS_{BR}$

Brake Rated Wear Limit,  $BRWL$

Maximum EMA Brake Voltage,  $V_{BMAX}$

Maximum EMA Brake Current,  $I_{BMAX}$

Maximum EMA Brake Power,  $P_{BMAX}$

Maximum System Voltage,  $V_{SMAX}$

Maximum System Current,  $I_{SMAX}$

Maximum System Power,  $P_{SMAX}$

4.1.2 The weight of the wheel and brake assemblies, as applicable.

4.1.3 Specification of the voltage and current supply limitations used during the tests.

4.1.4 Analysis and/or data substantiating  $I_{BMAX}$ ,  $L_{BMAX}$ ,  $L_{DL}$ ,  $L_{LMT}$ ,  $P_{BMAX}$  and  $V_{BMAX}$ , as appropriate.

4.1.5 One copy of the test report showing compliance with the test requirements.

NOTE: When test results are being recorded for incorporation in the compliance test report, it is not sufficient to note merely that the specified performance was achieved. The actual numerical values obtained for each of the parameters tested must be recorded, except where tests are pass/fail in character.

4.2 Prior to entry into service, a component maintenance manual (CMM), covering periodic maintenance, calibration, and repair, for the continued airworthiness of installed wheels and wheel and brake assemblies, including recommended inspection intervals and service life.

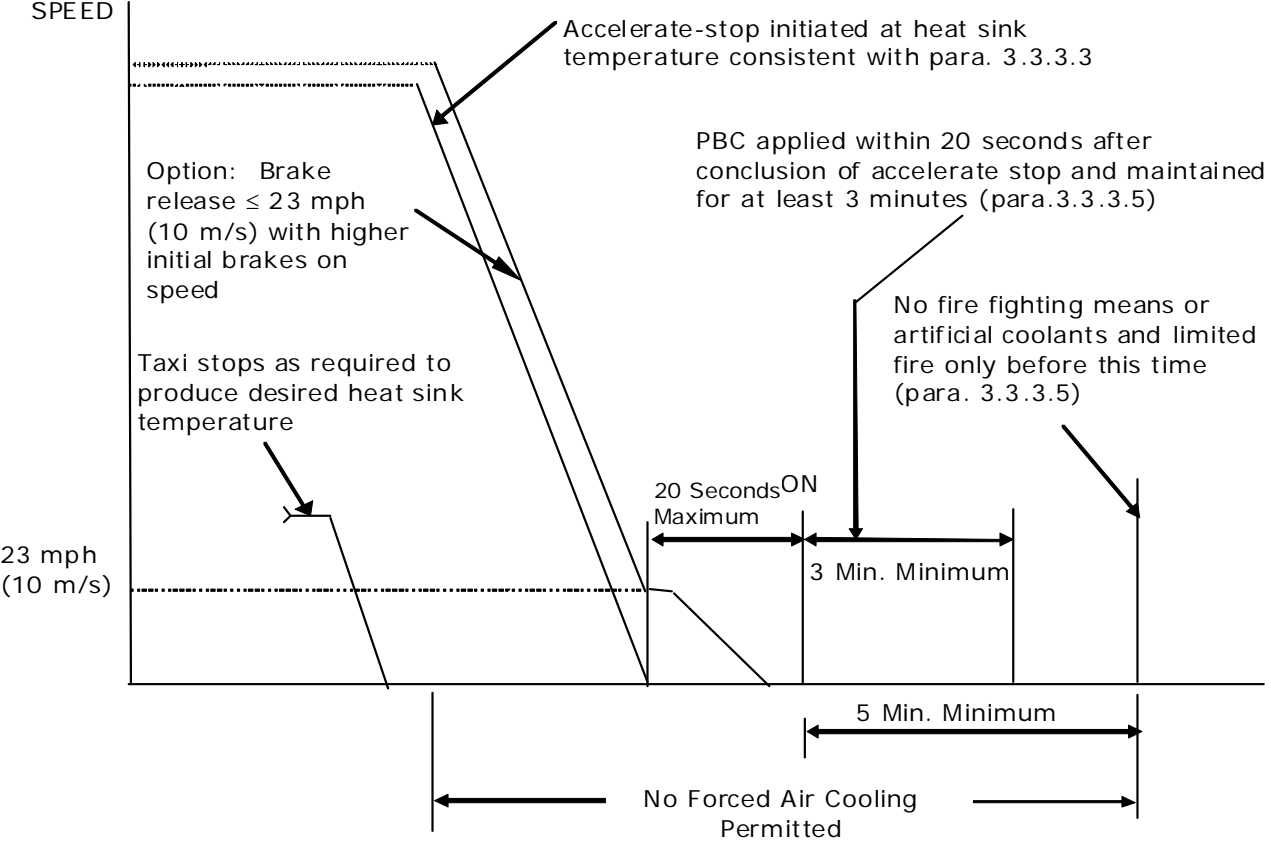

**Figure 3-1 - Taxi, Accelerate-Stop, Park Test Sequence**

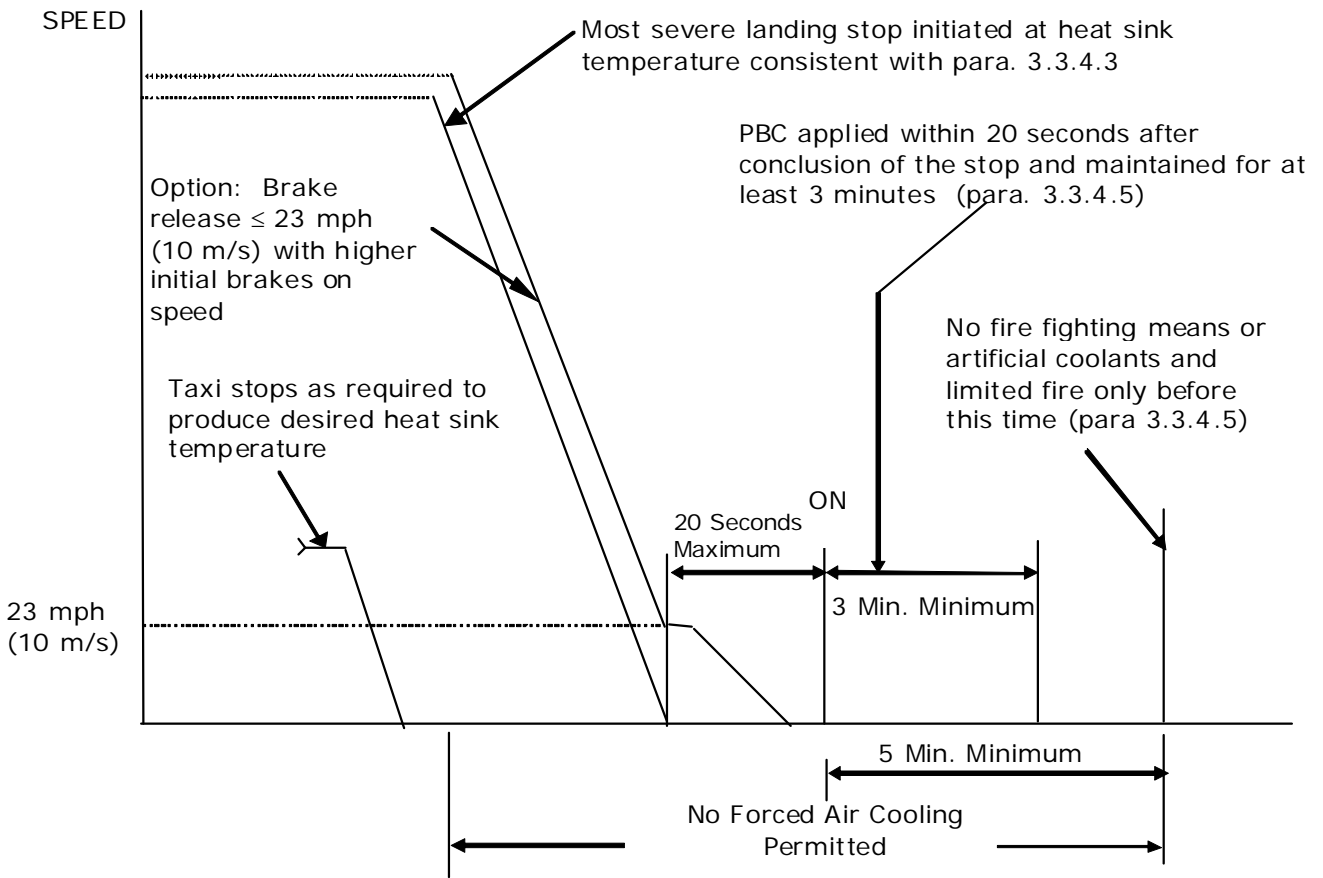

**Figure 3-2 - Most Severe Landing-Stop, Park Test Sequence**

# European Aviation Safety Agency

## European Technical Standard Order (ETSO)

Subject: AIRCRAFT AUDIO SYSTEMS AND EQUIPMENT

### 1 – Applicability

This ETSO gives the requirements which new models of aircraft audio systems and associated equipment that are manufactured on or after the date of this ETSO must meet in order to be identified with the applicable ETSO marking.

This ETSO cancels ETSO-C50c “Audio Selector Panels and Amplifiers”, ETSO-C57a “Headsets and Speakers” and ETSO-C58a “Aircraft Microphones”.

### 2 - Procedures

#### 2.1. - General

Applicable procedures are detailed in CS-ETSO Subpart A.

#### 2.2 - Specific

None

### 3 - Technical Conditions

#### 3.1 - Basic

##### 3.1.1 - Minimum Performance Standard

Standards set forth in section 2 of the RTCA document DO-214 “Audio Systems Characteristics and Minimum Performance Standards for Aircraft Audio Systems and Equipment” dated March 2, 1993, with the following clarifications:

In sub-paragraph 2.8.2.7.1 Input-to-Output Crosstalk and Bleed-Through Levels:  $V_{ref}$  will be defined as the rated output level of the monitored output in lieu of the rated input.

In sub-paragraph 2.8.2.7.2 Input-to-Input Crosstalk:  $V_{ref}$  will be defined as the rated input level of the monitored input.

##### 3.1.2 - Environmental Standard

See CS-ETSO Subpart A paragraph 2.1

##### 3.1.3 - Computer Software

See CS-ETSO Subpart A paragraph 2.2

##### 3.1.4 Electronic Hardware Qualification.

See CS-ETSO Subpart A paragraph 2.3

#### 3.2 - Specific

##### 3.2.1 Failure Condition Classification

See CS-ETSO Subpart A paragraph 2.4

Failure of the function defined in paragraph 3.1.1 of this ETSO has been determined to be a major failure condition.

#### **4 - Marking**

##### 4.1 - General

Marking is detailed in CS-ETSO Subpart A paragraph 1.2

##### 4.2 – Specific

None

#### **5 - Availability of Referenced Document**

See CS-ETSO Subpart A paragraph 3



# European Aviation Safety Agency

## European Technical Standard Order (ETSO)

Subject: PASSIVE AIRBORNE GLOBAL NAVIGATION SATELLITE SYSTEM (GNSS)  
ANTENNA

### 1 – Applicability

This ETSO gives the requirements which new models of passive airborne Global Navigation Satellite System (GNSS) Antenna that are manufactured on or after the date of this ETSO must meet in order to be identified with applicable ETSO marking.

### 2 - Procedures

#### 2.1. - General

Applicable procedures are detailed in CS-ETSO Subpart A.

#### 2.2 - Specific

None

### 3 - Technical Conditions

#### 3.1 - Basic

##### 3.1.1 - Minimum Performance Standard

Standards set forth in RTCA document DO-228, "Minimum Operational Performance Standards for Global Navigation Satellite Systems (GNSS) Airborne Antenna Equipment" dated October 20, 1995, Section 2 (excluding Sections 2.2.2 and 2.4.3) and Change 1 to DO-228.

Note 1: For Active Airborne Global Navigation Satellite System (GNSS) Antenna, see ETSO-C190

Note 2: The ETSO standards herein apply to equipment intended to receive and provide signals to a global positioning system (GPS)/satellite based augmentation system (SBAS) operational Class 1, or GPS, sensor or system that will provide flight path deviation commands to the pilot or autopilot. These standards do not address the use of the signals received through this antenna for other applications. GPS/SBAS operational classes are defined in RTCA document DO-229D "Minimum Operational Performance Standards for Global Positioning System/Wide Area Augmentation System Airborne Equipment", dated December 13, 2006, Section 1.4.2.

##### 3.1.2 - Environmental Standard

See CS-ETSO Subpart A paragraph 2.1

##### 3.1.3 - Computer Software

See CS-ETSO Subpart A paragraph 2.2

### 3.1.4 - Electronic Hardware Qualification

See CS-ETSO Subpart A paragraph 2.3

### 3.2 – Specific

#### 3.2.1 - Failure Condition Classification

See CS-ETSO Subpart A paragraph 2.4

Failure of the function defined in paragraph 3.1.1 of this ETSO has been determined to be a major failure condition.

## **4 - Marking**

### 4.1 - General

Marking is detailed in CS-ETSO Subpart A paragraph 1.2.

### 4.2 – Specific

None

## **5 - Availability of Referenced Document**

See CS-ETSO Subpart A paragraph 3.

# European Aviation Safety Agency

## European Technical Standard Order (ETSO)

Subject: AIRBORNE NAVIGATION SENSORS USING THE GLOBAL POSITIONING SYSTEM AUGMENTED BY THE SATELLITE BASED AUGMENTATION SYSTEM

### 1 – Applicability

This ETSO gives the requirements which new models of airborne navigation sensors using the Global Positioning System (GPS) augmented by the Satellite Based Augmentation System (SBAS) that are manufactured on or after the date of this ETSO must meet in order to be identified with the applicable ETSO marking.

The standards of this ETSO apply to equipment intended to provide position information to a navigation management unit that outputs deviation commands referenced to a desired flight path, Pilots or autopilots will use these deviations to guide the aircraft.

### 2 - Procedures

#### 2.1. - General

Applicable procedures are detailed in CS-ETSO Subpart A.

#### 2.2 - Specific

None

### 3 - Technical Conditions

#### 3.1 – Basic

##### 3.1.1 - Minimum Performance Standard

Standards set forth for functional equipment Class Beta in RTCA document DO-229D, Minimum Operational Performance Standards for Global Positioning System/Wide Area Augmentation System Airborne Equipment dated December 13, 2006, Section 2, except as modified in **Appendix 1** of this ETSO.

Class Beta equipment is defined in DO-229D, Section 1.4.

##### 3.1.2 - Environmental Standard

See CS-ETSO Subpart A paragraph 2.1

##### 3.1.3 - Computer Software

See CS-ETSO Subpart A paragraph 2.2

##### 3.1.4 Electronic Hardware Qualification.

See CS-ETSO Subpart A paragraph 2.3

#### 3.2 – Specific

##### 3.2.1 Failure Condition Classification

See CS-ETSO Subpart A paragraph 2.4

Failure of the function defined in paragraph 3.1.1 of this ETSO is a:

- *Major* failure condition for loss of function and malfunction of en route, terminal, approach lateral navigation (LNAV), and approach LNAV/vertical navigation (VNAV) position data,
- *Major* failure condition for loss of function of approach localiser performance without vertical guidance (LP), and approach localiser performance with vertical guidance (LPV) position data, and
- *Hazardous* failure condition for malfunction of approach (LP and LPV) position data.

3.3. - Functional qualifications.

None

#### **4 - Marking**

4.1 - General

Marking is detailed in CS-ETSO Subpart A paragraph 1.2

4.2 – Specific

At least one major component must be permanently and legibly marked with the operational equipment class as defined in Section 1.4.2 of RTCA document DO-229D (e.g., Class 2). A marking of Class 4 indicates compliance to Delta-4 requirements. The functional equipment class defined in Section 1.4.1 of RTCA document DO-229D (e.g. Gamma, Delta) is not required to be marked.

It is sufficient to declare the proper functional equipment class in the DDP.

#### **5 - Availability of Referenced Document**

See CS-ETSO Subpart A paragraph 3

APPENDIX 1

MPS for airborne navigation sensors using GPS augmented by SBAS

1. This appendix prescribes EASA modifications to the MPS for functional equipment Class Beta in RTCA document DO-229D, Section 2. Operational Class 3 equipment already complies with the MPS changes below. These MPS changes apply for operational Class 1 or Class 2 equipment only.

a Section 2.5

Section 2.5.6.1, Scenario #1, Step 3)

Change step 3) to read: "Broadband external interference noise ( $I_{Ext, Test}$ ) of spectral density equal to -170.5 dBm/Hz at the antenna port."

Section 2.5.6.1, Scenario #2, Step 4)

Change step 4) to read: "Broadband external interference noise ( $I_{Ext, Test}$ ) of spectral density equal to -170.5 dBm/Hz at the antenna port."

Section 2.5.8.2, Requirement 1), Item a)

Change item a) to read: "The broadband external interference noise ( $I_{Ext, Test}$ ) of spectral density equal to -170.5 dBm/Hz at the antenna port."

b Appendix C, Figure C-2, In-Band and Near-Band Interference Environments

Replace Figure C-2 with the following:

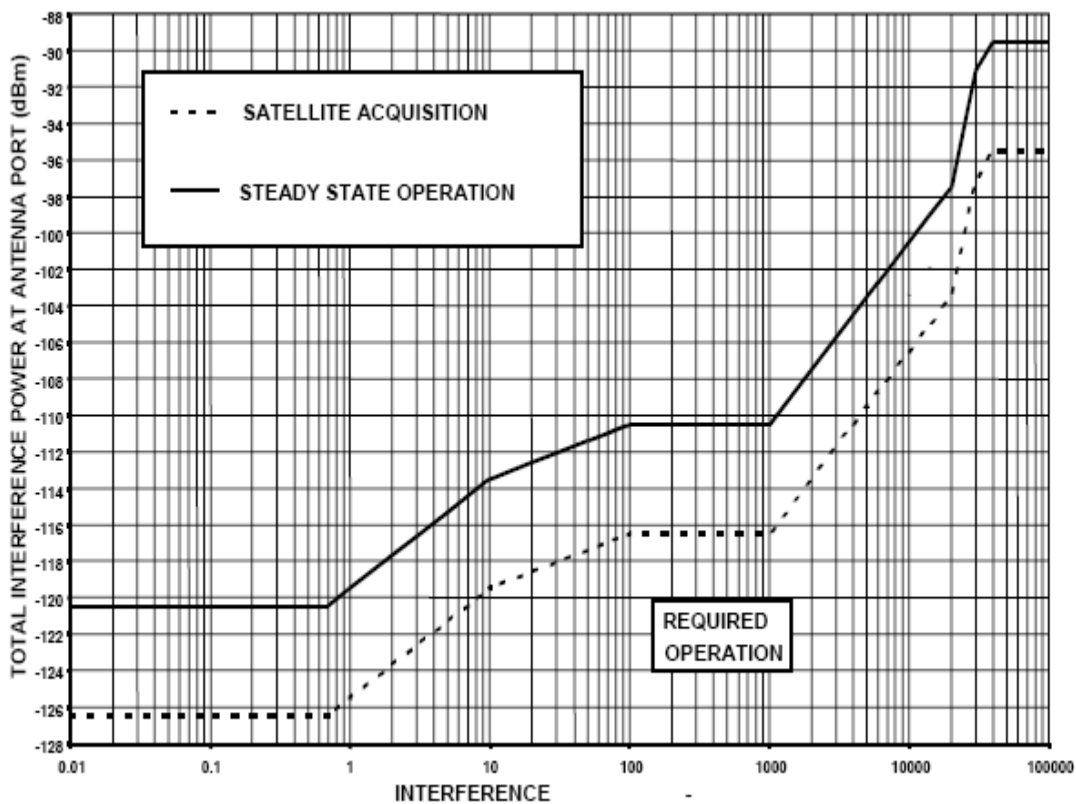

**c Appendix C, Section C.2.2**

Change the first paragraph to read:

The baseline in-band and near-band interference environments apply to steady-state operation. For initial acquisition of the GPS and SBAS signals prior to steady-state navigation, the in-band and near-band interference levels are 6 dB less than those for steady-state operation. The interference bandwidth is the 3 dB bandwidth.

Delete the last paragraph in the section (as shown below).

The in-band and near-band interference levels for the LNAV approach steady-state navigation operations are 3 dB less than those for LNAV/VNAV, LP, and LPV approach steady-state navigation operations. For terminal area and en route steady-state navigation operations, and for initial acquisition of the GPS and WAAS signals prior to steady-state navigation for all flight phase operations, the in-band and near-band interference levels are 6 dB less than those for LNAV, LNAV/VNAV, and LPV approach steady-state navigation operations.

# European Aviation Safety Agency

## European Technical Standard Order (ETSO)

Subject: STAND ALONE AIRBORNE NAVIGATION EQUIPMENT USING THE GLOBAL POSITIONING SYSTEM AUGMENTED BY THE SATELLITE BASED AUGMENTATION SYSTEM

### 1 – Applicability

This ETSO gives the requirements which new models of stand alone airborne navigation equipment using the Global Positioning System (GPS) augmented by the Satellite Based Augmentation System that are manufactured on or after the date of this ETSO must meet in order to be identified with the applicable ETSO marking.

### 2 - Procedures

#### 2.1. - General

Applicable procedures are detailed in CS-ETSO Subpart A.

#### 2.2 - Specific

None

### 3 - Technical Conditions

#### 3.1 - Basic

##### 3.1.1 - Minimum Performance Standard

Standards set forth for functional equipment Class Gamma or Delta in RTCA document DO-229D, *Minimum Operational Performance Standards for Global Positioning System/Wide Area Augmentation System Airborne Equipment*, dated December 13 2006, Section 2, except as modified by **Appendix 1** of this ETSO.

Classes Gamma and Delta equipment are defined in DO-229D, Section 1.4.

##### 3.1.2 - Environmental Standard

See CS-ETSO Subpart A paragraph 2.1

##### 3.1.3 - Computer Software

See CS-ETSO Subpart A paragraph 2.2

##### 3.1.4 Electronic Hardware Qualification.

See CS-ETSO Subpart A paragraph 2.3

#### 3.2 - Specific

##### 3.2.1 Failure Condition Classification

See CS-ETSO Subpart A paragraph 2.4.

Failure of the function defined in paragraph 3.1.1 of this ETSO is a:

- *Major* failure condition for loss of function and malfunction of en route, terminal, approach lateral navigation (LNAV), and approach LNAV/vertical navigation (VNAV) position data,
- *Major* failure condition for loss of function of approach localiser performance without vertical guidance (LP), and approach localiser performance with vertical guidance (LPV) position data, and
- *Hazardous* failure condition for malfunction of approach (LP and LPV) position data.

3.3. - Functional qualifications.

None

#### **4 - Marking**

4.1 - General

Marking is detailed in CS-ETSO Subpart A paragraph 1.2

4.2 – Specific

At least one major component must be permanently and legibly marked with the operational equipment class as defined in Section 1.4.2 of RTCA document DO-229D (e.g., Class 2). A marking of Class 4 indicates compliance to Delta-4 requirements. The functional equipment class defined in Section 1.4.1 of RTCA document DO-229D (e.g. Gamma, Delta) is not required to be marked.

It is sufficient to declare the proper functional equipment class in the DDP.

#### **5 - Availability of Referenced Document**

See CS-ETSO Subpart A paragraph 3.



APPENDIX 1

MPS for stand-alone airborne navigation equipment using GPS augmented by SBAS

1. This appendix prescribes modifications to the MPS for functional equipment class Gamma found in RTCA document DO-229D, Section 2. Gamma operational Class 3 and Delta operational Class 4 equipment already complies with the MPS changes below. These MPS changes apply for operational Class 1 or Class 2 equipment only.

a Section 2.5

Section 2.5.6.1, Scenario #1, Step 3)

Change step 3) to read: "Broadband external interference noise ( $I_{Ext, Test}$ ) of spectral density equal to -170.5 dBm/Hz at the antenna port."

Section 2.5.6.1, Scenario #2, Step 4)

Change step 4) to read: "Broadband external interference noise ( $I_{Ext, Test}$ ) of spectral density equal to -170.5 dBm/Hz at the antenna port."

Section 2.5.8.2, Requirement 1), Item a)

Change item a) to read: "The broadband external interference noise ( $I_{Ext, Test}$ ) of spectral density equal to -170.5 dBm/Hz at the antenna port."

b Appendix C, Figure C-2, In-Band and Near-Band Interference Environments

Replace Figure C-2 with the following:

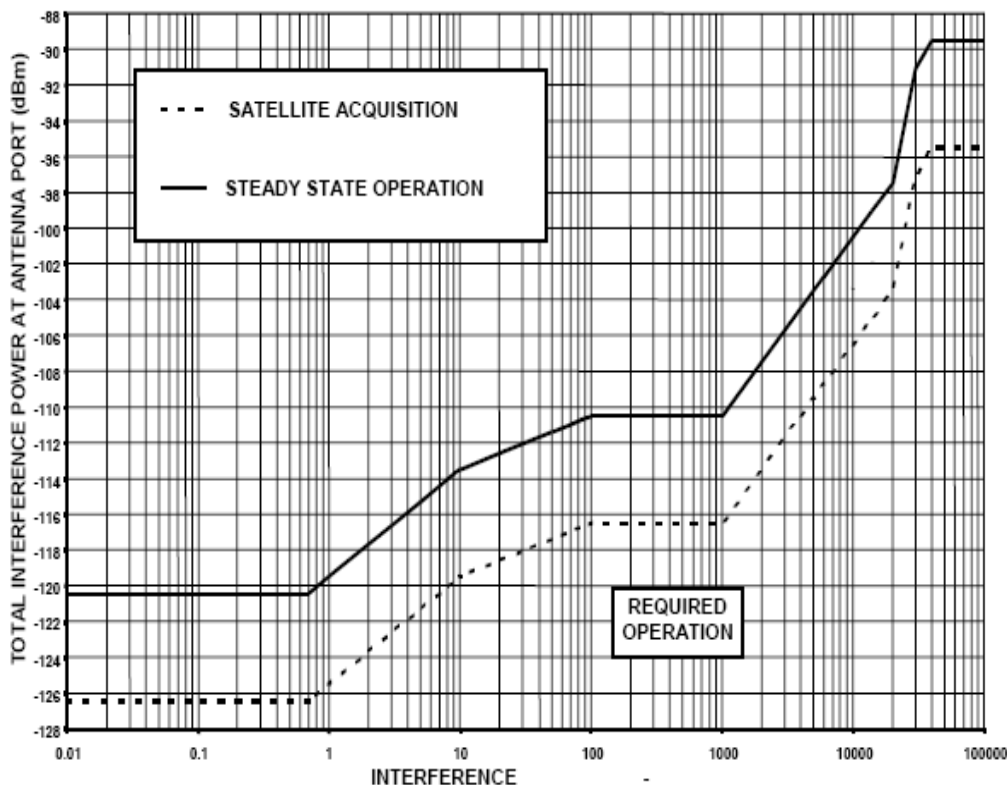

**c Appendix C, Section C.2.2**

Change the first paragraph to read:

The baseline in-band and near-band interference environments apply to steady-state operation. For initial acquisition of the GPS and SBAS signals prior to steady-state navigation, the in-band and near-band interference levels are 6 dB less than those for steady-state operation. The interference bandwidth is the 3 dB bandwidth.

Delete the last paragraph in the section (as shown below).

~~The in-band and near-band interference levels for the LNAV approach steady-state navigation operations are 3 dB less than those for LNAV/VNAV, LP, and LPV approach steady-state navigation operations. For terminal area and en route steady-state navigation operations, and for initial acquisition of the GPS and WAAS signals prior to steady-state navigation for all flight phase operations, the in-band and near-band interference levels are 6 dB less than those for LNAV, LNAV/VNAV, and LPV approach steady-state navigation operations.~~

# European Aviation Safety Agency

## European Technical Standard Order (ETSO)

Subject: RECORDER INDEPENDENT POWER SUPPLY

### 1 – Applicability

This ETSO gives the requirements which new models of recorder independent power supply equipment, that are manufactured on or after the date of this ETSO must meet in order to be identified with the applicable ETSO marking.

This ETSO applies to equipment intended to provide back-up power to an installed cockpit crash protected recorder, whether it is:

- Voice
- Image
- Data
- Combination voice/data
- Combination voice/image, or
- Combination image/data.

### 2 - Procedures

#### 2.1. - General

Applicable procedures are detailed in CS-ETSO Subpart A.

#### 2.2 - Specific

None

### 3 - Technical Conditions

#### 3.1 - Basic

##### 3.1.1 - Minimum Performance Standard

Standards set forth in **Appendix 1** of this ETSO.

##### 3.1.2 - Environmental Standard

See CS-ETSO Subpart A paragraph 2.1 and **Appendix 2** to this ETSO.

##### 3.1.3 - Computer Software

See CS-ETSO Subpart A paragraph 2.2

##### 3.1.4 Electronic Hardware Qualification.

See CS-ETSO Subpart A paragraph 2.3

#### 3.2 - Specific

##### 3.2.1 Failure Condition Classification

See CS-ETSO Subpart A paragraph 2.4

Failure of the function defined in paragraph 3.1.1 of this ETSO has been determined to be a minor failure condition.

#### **4 - Marking**

##### 4.1 - General

Marking is detailed in CS-ETSO Subpart A paragraph 1.2

##### 4.2 – Specific

None

#### **5 - Availability of Referenced Document**

See CS-ETSO Subpart A paragraph 3.

**APPENDIX 1**

**MINIMUM PERFORMANCE STANDARD (MPS) FOR RECORDER INDEPENDENT POWER SUPPLY (RIPS)**

RIPS supplies direct current (DC) voltage to an aircraft installed recorder for a specified time whenever the primary aircraft power is removed. RIPS ensures continued recording. RIPS supports recorders of cockpit voice, image, combination voice/data, combination voice/image, or combination image/data. RIPS doesn't distinguish between a normal shutdown and loss of electrical power from an emergency. It executes operational cycles regardless of the type of power loss.

In the tables below are standards for RIPS classified by performance requirements:

<b>1. Power Requirements:</b>	
Aircraft Voltage	Operate from either 115V <sub>AC</sub> single phase 360-800Hz variable frequency, or from 27.5V <sub>DC</sub> primary aircraft power, or both (depends on model).
Availability	Power the recorder any time the aircraft's electrical power is removed. Includes normal shutdown

<b>2. RIPS Power output:</b>	
Supplied Voltage	Power the recorder continuously or only after aircraft power is lost. Output voltage should be 27.5V <sub>DC</sub> nominal but can vary from 18V <sub>DC</sub> to 32.2V <sub>DC</sub> . Ripple voltage will not exceed limits at <b>Figure 1</b> (shown after this table). Output power should be prevented from causing damage when short-circuited. Output power should not be hazardous to personnel during handling.
Energy Requirements	Provide minimum 12 watts for the supply duration. Corresponds to stored energy of 6480 to 7920 watt-seconds (9 to 11 minutes times 60 seconds/minute= 12 watts)
Recharging	Be ready to function within 15 minutes from application or re-application of primary power. Since stored energy could be fully depleted, design the charging system to restore the stored energy source. Restoration should be from any initial charge state, back to the minimum energy level specified above. Unit can provide full 10 minutes of power no more than 15 minutes from aircraft power restoration. Recharge time required for unit to provide 6 minutes of power: not more than 10 minutes

<b>3. Built In Monitoring:</b>	Be equipped with built-in test equipment (BITE) to detect internal failures and to monitor the unit's condition. If maintenance is required based on any combination of the following aspects, monitor and log the maintenance: <ul style="list-style-type: none"> <li>- Energy source life expiration (number of hours operating time until battery replacement),</li> <li>- Other energy source failure,</li> <li>- - Absence of energy source in the device, and</li> <li>- - Number of energy source cycles</li> </ul> Manufacturers may add other operational aspects
--------------------------------	--

<p><b>4. Maintenance Warning:</b></p>	<p>Issues a warning as discrete output, alerting of any inability to perform the intended function or that maintenance is required. To do this, RIPS provides an output that indicates:</p> <ul style="list-style-type: none"> <li>- A fail condition with an OPEN circuit. Resistance greater than 100,000 ohms or voltage greater than 18 V<sub>DC</sub> (36V<sub>DC</sub> Max), and</li> <li>- A normal operation by a standard GROUND. V<sub>OUT</sub> less than 3.5 V<sub>DC</sub></li> </ul>
<p><b>5. Operational Timing:</b></p>	<p>Monitors the line voltage supplied to the recorder. When aircraft power is lost, the RIPS restores power to recorder from its stored energy no more than 50 milliseconds after the line voltage falls below the specified recorder minimum operating voltage (18 V<sub>DC</sub> or 100 V<sub>AC</sub>)</p>
<p>Tolerance</p>	<p>Tolerance on the 10 minute output is ± 1 minute</p>
<p>Operational Reset</p>	<p>If input power to RIPS is restored before the 10 minute period ends, RIPS should reset the 10 minute timer to 0 and resume monitoring the recorder line voltage. The RIPS should recharge as required (see "Recharging," above)</p>

**Figure 1 – DC Ripple Voltage Limits**

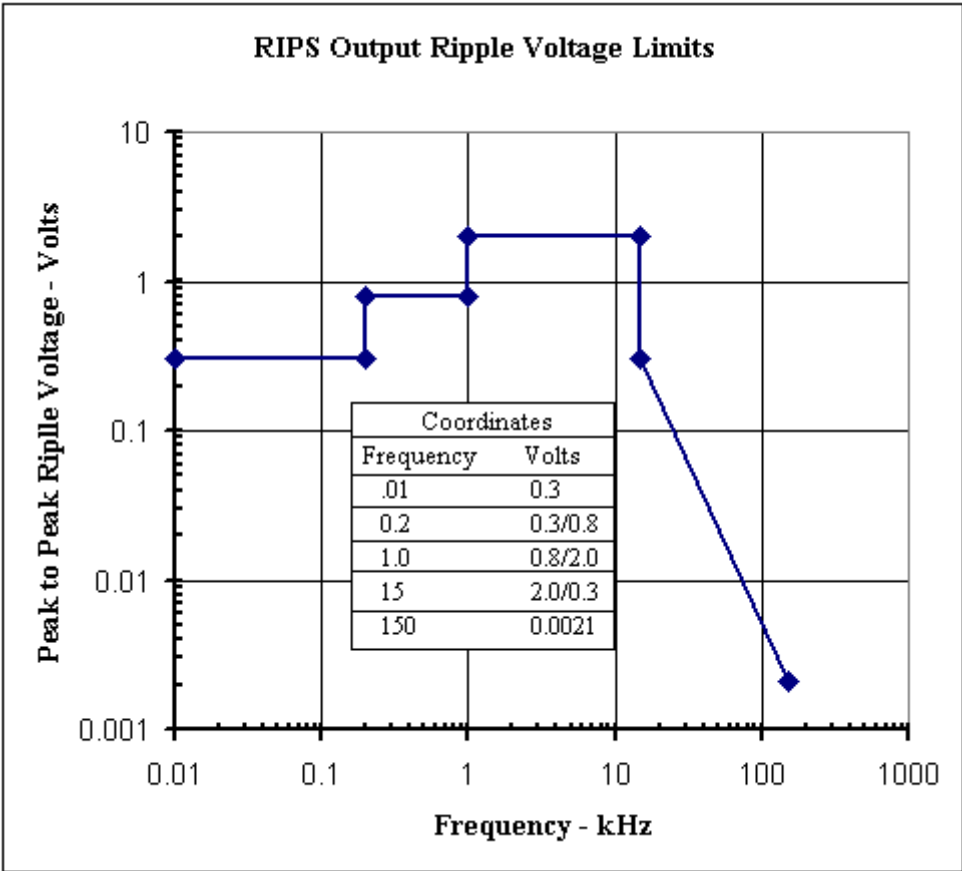

**APPENDIX 2**

**ENVIRONMENTAL QUALIFICATION EQUIPMENT CATEGORY/CLASS**

<b>Environmental Qualification</b>	<b>ED-14() Category or class</b>
Audio Frequency Conducted Susceptibility--Power Inputs	Category A(WF)
Emission of Radio Frequency Energy	Category M
Explosion Proof	Category E for equipment intended for use in Environment II
Fluids Susceptibility	Category F
Fungus Resistance	Category F
Humidity	Category A
Induced Signal Susceptibility	Category C
Lightning Induced Transient Susceptibility	Category A2C3
Magnetic Effect	Class Z
Operational Shocks and Crash Safety	Category B
Power Input	Category A(WF), AC, and DC supply
Radio Frequency Susceptibility (Radiated and Conducted)	Category V
Temperature and Altitude	Category D2
Temperature Variation	Category B. Test the control electronics over the entire temperature range. Test the energy source from a lower test limit of -20° C to the upper test limit
Vibration	Category H, curve C1, and Y equipment
Voltage Spike	Category A
Waterproof	Category W

# European Aviation Safety Agency

## European Technical Standard Order (ETSO)

SUBJECT: ELECTRONIC MAP DISPLAY EQUIPMENT FOR GRAPHICAL DEPICTION OF AIRCRAFT POSITION

### 1 – Applicability

This ETSO gives the requirements which new models of Electronic Map Display Equipment for Graphical Depiction of Aircraft Position, that are manufactured on or after the date of this ETSO, must meet in order to be identified with the applicable ETSO marking.

### 2 - Procedures

#### 2.1. - General

Applicable procedures are detailed in CS-ETSO Subpart A.

#### 2.2 - Specific

None

### 3 - Technical Conditions

#### 3.1 - Basic

##### 3.1.1 - Minimum Performance Standard

New models of Electronic Map Displays that are to be so identified and that are manufactured on or after the effective date of this ETSO must meet the standards set forth for moving map equipment in Section 2 of RTCA document DO-257A, "Minimum Operational Performance Standards for the Depiction of Navigational Information on Electronic Maps," dated June, 25, 2003.

Electronic Map Displays for use in flight must meet the MPS in Sections 2.1 and 2.2 of DO-257A.

Electronic Map Displays for use on the airport surface must meet the MPS in Sections 2.1, 2.2, and 2.3 of DO-257A, and Electronic Map Displays including Vertical Situation Displays (VSD) for use in facilitating pilot's awareness of the aircraft's vertical flight path must meet the MPS in Sections 2.1, 2.2, and 2.4 of DO-257A.

##### 3.1.2 - Environmental Standard

See CS-ETSO Subpart A paragraph 2.1.

##### 3.1.3 - Computer Software

See CS-ETSO Subpart A paragraph 2.2

##### 3.1.4 Electronic Hardware Qualification.

See CS-ETSO Subpart A paragraph 2.3



### 3.2 - Specific

#### 3.2.1 Failure Condition Classification

See CS-ETSO Subpart A paragraph 2.4

Failure of the functions defined in paragraph 3.1.1 of this ETSO for Electronic Map Displays used in flight and VSD equipment (airborne applications) have been determined to be a major failure condition for malfunctions causing the display of misleading information.

Loss of function for Electronic Map Displays used in flight and VSD equipment (airborne applications) have been determined to be a minor failure condition.

Failure of the function defined in paragraph 3.1.1 of this ETSO for Electronic Map Displays used on the airport surface (ground applications) have been determined to be a minor failure condition for malfunctions causing the display of misleading information.

Loss of function for Electronic Map Displays used on the airport surface (ground applications) is determined to be a no safety effect failure condition.

### **4 - Marking**

#### 4.1 - General

Marking is detailed in CS-ETSO Subpart A paragraph 1.2

#### 4.2 – Specific

None

### **5 - Availability of Referenced Document**

See CS-ETSO Subpart A paragraph 3

# European Aviation Safety Agency

## European Technical Standard Order (ETSO)

SUBJECT: AIRCRAFT COCKPIT IMAGE RECORDER SYSTEMS

### 1 – Applicability

This ETSO gives the requirements that new models of aircraft cockpit image recorder systems that are manufactured on or after the date of this ETSO must meet in order to be identified with the applicable ETSO marking.

### 2 - Procedures

#### 2.1. - General

Applicable procedures are detailed in CS-ETSO Subpart A.

#### 2.2 - Specific

None

### 3 - Technical Conditions

#### 3.1 - Basic

##### 3.1.1 - Minimum Performance Standard

Standards set forth in the applicable sections of EUROCAE document ED-112, Minimum Operational Performance Specification for Crash Protected Airborne Recorder Systems, dated March 2003 including amendment 1 dated 25 July 2003 and amendment 2 dated 22 September 2003 that pertain to the Cockpit Image Recorder (CIR) type, except that compliance with ED-112 chapters 2-5, 3-4, 5-6, and all ED-112 requirements for installation, flight testing, aircraft maintenance, and others that do not pertain to MPS specific criteria are not required for this ETSO.

The table below lists recorder types and the ED-112 section or part with the MPS for each:

Recorder MPS Requirements	
Recorder Type	ED-112 Reference
Single CIR	Section 2 and Part III
CIR function in deployable recorder	Section 2, Part III, and Section 3
CIR function in combined recorder	Section 2, Part III, and Section 4

##### 3.1.2 - Environmental Standard

See CS-ETSO Subpart A paragraph 2.1

##### 3.1.3 - Computer Software

See CS-ETSO Subpart A paragraph 2.2

##### 3.1.4 Electronic Hardware Qualification.

See CS-ETSO Subpart A paragraph 2.3

### 3.2 - Specific

#### 3.2.1 Failure Condition Classification

Failure of the function defined in paragraph 3.1.1 of this ETSO depends on the aircraft installation. The applicant must develop the system to at least the design assurance level commensurate with the failure condition classification in the table below:

<b>Classifications of Failure Conditions for Recorders</b>	
<b>Recorder type</b>	<b>Failure Classification</b>
Single CIR	Minor
CIR function in deployable recorder	Major
CIR function in combined recorder function: <ul style="list-style-type: none"><li>• Aeroplane or rotorcraft with two recorders</li><li>• Rotorcraft with one combined recorder</li></ul>	Minor Major

Note: The failure classification is driven by the accident investigation need.

## 4 - Marking

### 4.1 - General

Marking is detailed in CS-ETSO Subpart A paragraph 1.2

### 4.2 – Specific

#### 4.2.1 - Lettering

ED112-Chapter 2-1 paragraph 2-1.16.3 requires the lettering on the recorder be at least 25 mm in height. Where it is considered impractical to incorporate lettering of this height due to the size of the recorder case, the applicant may propose an alternative height provided that the size is adequate in relation to the size of the unit and allows easy readability.

#### 4.2.2 - Marking recommendation

Marking in French: "ENREGISTREUR DE VOL NE PAS OUVRIR" is optional.

## 5 - Availability of Referenced Document

See CS-ETSO Subpart A paragraph 3

# European Aviation Safety Agency

## European Technical Standard Order (ETSO)

SUBJECT: DATA LINK RECORDER SYSTEMS

### 1 – Applicability

This ETSO gives the requirements that new models of data link recorder systems that are manufactured on or after the date of this ETSO must meet in order to be identified with the applicable ETSO marking.

### 2 - Procedures

#### 2.1. - General

Applicable procedures are detailed in CS-ETSO Subpart A.

#### 2.2 - Specific

None

### 3 - Technical Conditions

#### 3.1 - Basic

##### 3.1.1 - Minimum Performance Standard

Standards set forth in the applicable sections of EUROCAE document ED-112 “Minimum Operational Performance Specification for Crash Protected Airborne Recorder Systems” dated March 2003 that pertain to the data link recorder types, except that compliance with ED-112 chapters 2-5, 3-4, 5-6, and all ED-112 requirements for installation, flight testing, aircraft maintenance are not required for this ETSO.

The table below lists recorder types and the ED-112 chapter and part containing the Minimum Performance Specification for each:

Recorder MPS Requirements, Excluding Aircraft Level Requirements	
Recorder Type	ED-112 Reference
Single DLR	Section 2 and Part IV
DLR function in a deployable recorder	Section 2, Section 3 and Part IV
DLR function in a combined recorder	Section 2, Section 4 and Part IV

##### 3.1.2 - Environmental Standard

See CS-ETSO Subpart A paragraph 2.1

##### 3.1.3 - Computer Software

See CS-ETSO Subpart A paragraph 2.2

##### 3.1.4 Electronic Hardware Qualification.

See CS-ETSO Subpart A paragraph 2.3

### 3.2 - Specific

#### 3.2.1 Failure Condition Classification

Failure of the function defined in paragraph 3.1.1 of this ETSO has been determined to be a minor failure condition. The applicant must develop the system to at least the design assurance level commensurate with this failure condition.

Note: The failure classification is driven by the accident investigation need.

## **4 - Marking**

### 4.1 - General

Marking is detailed in CS-ETSO Subpart A paragraph 1.2

### 4.2 – Specific

#### 4.2.1 Lettering

ED112-Chapter 2-1 paragraph 2-1.16.3 requires the lettering on the recorder be at least 25 mm in height. Where it is considered impractical to incorporate lettering of this height due to the size of the recorder case, the applicant may propose an alternative height provided that the size is adequate in relation to the size of the unit and allows easy readability.

#### 4.2.2 Marking recommendation

Marking in French: "ENREGISTREUR DE VOL NE PAS OUVRIR" is optional.

## **5 - Availability of Referenced Document**

See CS-ETSO Subpart A paragraph 3

# European Aviation Safety Agency

## European Technical Standard Order (ETSO)

SUBJECT: ACTIVE AIRBORNE GLOBAL NAVIGATION SATELLITE SYSTEM (GNSS)  
ANTENNA

### 1 – Applicability

This ETSO gives the requirements for new models of Active Airborne Global Navigation Satellite System (GNSS) Antenna that are manufactured on or after the date of this ETSO must meet in order to be identified with the applicable ETSO marking.

This ETSO apply to equipment intended to receive and provide signals to global positioning system (GPS)/satellite based augmentation system (SBAS) sensors or systems of all operational classes, and GPS/ground based augmentation system (GBAS) sensors or systems that will provide flight path deviation commands to the pilot or autopilot. These standards do not address the use of the signals received through this antenna for other applications. GPS/SBAS receiver operational classes are defined in RTCA document DO-229D “Minimum Operational Performance Standards for Global Positioning System/Wide Area Augmentation System Airborne Equipment” dated December 13, 2006, Section 1.4.2.

Note: For Passive Airborne Global Navigation Satellite System (GNSS) Antenna, see ETSO-C144a

### 2 - Procedures

#### 2.1. - General

Applicable procedures are detailed in CS-ETSO Subpart A.

#### 2.2 - Specific

None

### 3 - Technical Conditions

#### 3.1 - Basic

##### 3.1.1 - Minimum Performance Standard

Standards set forth in the RTCA document DO-301 “Minimum Operational Performance Standards for Global Navigation Satellite System (GNSS) Airborne Active Antenna Equipment for the L1 Frequency Band” dated December 13, 2006, Section 2.

##### 3.1.2 - Environmental Standard

See CS-ETSO Subpart A paragraph 2.1

##### 3.1.3 - Computer Software

See CS-ETSO Subpart A paragraph 2.2

##### 3.1.4 Electronic Hardware Qualification.

See CS-ETSO Subpart A paragraph 2.3

### 3.2 - Specific

#### 3.2.1 Failure Condition Classification

See CS-ETSO Subpart A paragraph 2.4

Failure of the function defined in paragraphs 3.1.1 of this ETSO constitutes a loss of navigation which is a major failure condition.

## **4 - Marking**

### 4.1 - General

Marking is detailed in CS-ETSO Subpart A paragraph 1.2

### 4.2 – Specific

None

## **5 - Availability of Referenced Document**

See CS-ETSO Subpart A paragraph 3

# European Aviation Safety Agency

## European Technical Standard Order (ETSO)

SUBJECT: CARBON MONOXIDE DETECTOR INSTRUMENTS

### 1 – Applicability

#### 1.1. - General

This ETSO gives the requirements for new models of carbon monoxide detector instruments, which are manufactured on or after the date of this ETSO, must meet in order to be identified with the applicable ETSO marking.

#### 1.2 - Specific

This ETSO refers to two basic types of detector instruments:

- TYPE A instruments are completely self-contained and carry their own power source and warning system.
- TYPE B instruments are powered by the aircraft power supplies including the alarm system.

### 2 - Procedures

#### 2.1. - General

Applicable procedures are detailed in CS-ETSO Subpart A.

#### 2.2 - Specific

None

### 3 - Technical Conditions

#### 3.1 – Basic

##### 3.1.1 - Minimum Performance Standard

See **Appendix 1**

##### 3.1.2 - Environmental Standard

See CS-ETSO Subpart A paragraph 2.1 and **Appendix 2**

##### 3.1.3 - Computer Software

See CS-ETSO Subpart A paragraph 2.2

##### 3.1.4 – Electronic Hardware Qualification

See CS-ETSO Subpart A paragraph 2.3

#### 3.2 - Specific



### 3.2.1 Failure Condition Classification

See CS-ETSO Subpart A paragraph 2.4

Failure of the function defined in paragraph 3.1.1 of this ETSO has been determined to be a minor failure condition.

## **4. Marking**

### 4.1 - General

Marking is detailed in CS-ETSO Subpart A paragraph 1.2

### 4.2 – Specific

The component must be permanently and legibly marked with the equipment class as defined in paragraph 1.2 of this ETSO.

## **5 - Availability of Referenced Document**

See CS-ETSO Subpart A paragraph 3

**APPENDIX 1**

**Minimum Performance Standard**

The following requirements apply to both TYPE A & B unless otherwise stated.

**1 - Performance Standard**

- a. The Instrument shall trigger visual and aural alarm when CO is detected.
- b. The concentration against time characteristic of the alarm activation shall meet the requirements of Table 1 below:
- c. The instrument may provide a readout of actual detected CO concentration level in parts per million (ppm) by volume.
- d. The probability of false alarms should be shown by the manufacturer to be sufficiently remote so as not to encourage the flight crew to distrust the instrument.
- e. The warm-up time of the instrument should not exceed 5 minutes.

<b>CONCENTRATION (ppm by volume)</b>	<b>NO ALARM BEFORE (minutes)</b>	<b>ALARM BEFORE (minutes)</b>
Less than or equal to 30	<b>DO NOT ALARM</b>	<b>DO NOT ALARM</b>
More than 30	120	180
More that 50	60	90
More than 100	10	40
More than 300	No delay	3

**Table 1: Alarm Activation Concentration**

**2 - Alarm Operation**

- a. There shall be a flashing AMBER indication, visible within the angle shown in Figure 1 below, whenever any of the criteria, described in Table 1, are met.

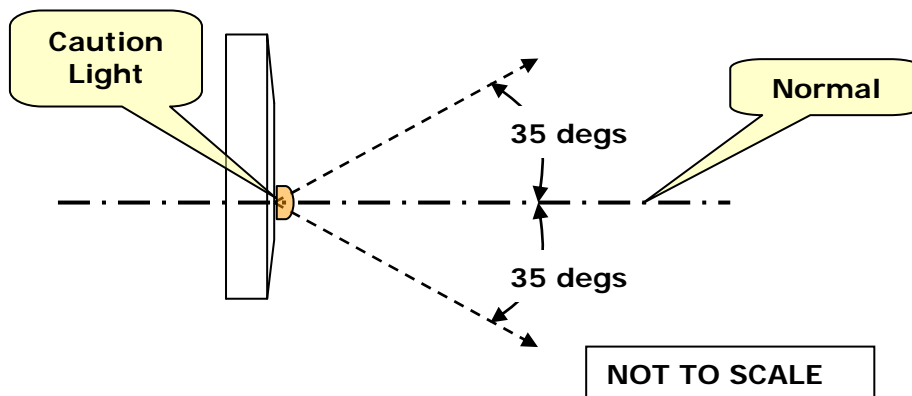

**Figure 1 Plan View of Instrument showing Minimum Viewing Angle**

- b. The flashing visual caution light shall be accompanied by an intermittent aural alarm of a distinctive characteristic that cannot be confused with other aural alarms or indications that are typically found in the aircraft.
- c. The aural alarm shall be of such a characteristic that the attenuation by an Automatic Noise Reduction Headset will be kept to a minimum.
- d. In order to mitigate any distraction at critical stages of the flight, the aural alarm should initially alarm at a low intensity. At each cycle of the alarm the intensity should be increased until it is at least 85dBA at a range of 3 metres.
- e. It shall be possible for the pilot to cancel the alarms. Once cancelled the instrument should re-set within 2 minutes. At this point, the instrument should continue to monitor the air and re-warn if the criteria of paragraph 1b are met.

### 3 - Function/Power Indications

- a. Self test:

Both types of unit should have a function indicator which illuminates showing that a self test of the instrument has been successfully completed. The test should confirm as many of the functions as possible.

- b. Battery Power test. TYPE A only

The TYPE A unit shall provide the pilot with a steady visual indication that there is 5 hours or less of useful battery power remaining. If there is less than 2 hours left, the visual indication should be made to flash.

### 4 - Standard Performance Test

The following is a detailed test requirement to be carried out when specified. During all tests the detector should be mounted in its normal operating orientation.

- a. Test gases for Alarm Operation: the following concentrations should be used to check the alarm operation.

REF	CO TEST GAS (ppm by volume)	NO ALARM BEFORE (minutes)	ALARM BEFORE (minutes)
A	20-25	240	-
B	31-37	120	180
C	51-61	60	90
D	101-121	10	40
E	301-361	-	3
F	5000-5500	-	3

- b. The test conditions for the standard test are:
  - Temperature: 15 to 25°C
  - Humidity: Between 30% and 70% Relative humidity.
  - Pressure: 980 to 1050 hPa
- c. Standard Test procedure: the following is required:
  - Switch on instrument and allow to warm up for 5 minutes
  - Purge with clean air for 15 minutes

- Test Gas B and check alarm between 120 to 180 minutes
- Purge with clean air for 15 minutes
- Test Gas C and check alarm between 60 to 90 minutes
- Purge with clean air for 15 minutes
- Test Gas D and check alarm between 10 to 40 minutes
- Purge with clean air for 15 minutes
- Test Gas E and check alarm before 3 minutes

d. Digital Display

If a digital display is featured on the equipment then it should be checked that it reads in the band  $\pm 10\%$  of the actual value for each of the conditions above.

**5 - Low CO concentration test.**

To ensure that nuisance warnings do not occur at low concentrations, carry out the following test exposing the instrument to the following gases:

- Clean air for 15 min
- Test gas A for 240 min or more
- Check that the alarm is not triggered
- Test gas B and ensure that alarm is triggered between 120 and 180 min

**6 - High CO concentration test.**

To ensure that the instrument is capable of reacting to extremely high concentrations, carry out the following test exposing the instrument to the following gases:

- Pass clean air for 15 min
- Pass test gas F.
- Check that the alarm is triggered within 3 min.
- Pass clean air for 10 min
- Pass test gas B.
- Check that the alarm triggers between 120 and 180 min.

**7 – Documentation**

The supplier shall provide written guidance in the following areas:

7.1 - Operation

General description including the principle of operation including;

- Details of and interpretation of warnings.
- Details of and interpretation of test indications.
- Limitations.
- Battery changing procedure if applicable.

Action in the event of receiving a warning

Suggest generic actions helping the installer defining appropriate AFM procedures.

7.2 - Installation

The installation instruction must make it clear which categories of aircraft the instrument is suitable for and any restrictions in its use must also be clearly stated.

A general description of

- the optimum position for the instrument in different aircraft types and
- the positions to be avoided to ensure reliable air sampling and to avoid compass interference.

### 7.3 – Continued Airworthiness

Cleaning and other instructions as required.

## **APPENDIX 2:**

### **Additional Tests**

The following additional tests are required.

a - Effect of Fuel contaminated air.

- i Air contaminated with 1,000 ppm by volume of 100LL fuel is to be passed through the instrument for 2 hours
- ii Verify that there are no false alarms during that period
- iii Pass test sample D through the instrument and ensure that the alarm is triggered between 10 and 40 minutes
- iv Repeat 2.2-a, 2.2-b and 2.2-c using JET A1 fuel.
- v Repeat 2.2-a, 2.2-b and 2.2-c using MOGAS Leaded fuel to BS:4040:1988.
- vi Repeat 2.2-a, 2.2-b and 2.2-c using MOGAS Unleaded fuel to BS:7070 or EN228:1995.
- vii Repeat 2.2-a, 2.2-b and 2.2-c using diesel fuel

# European Aviation Safety Agency

## European Technical Standard Order (ETSO)

SUBJECT: VHF RADIO COMMUNICATIONS TRANSCEIVER EQUIPMENT OPERATING  
WITHIN THE RADIO FREQUENCY RANGE 117.975 TO 137.000 MEGAHERTZ

### 1 – Applicability

This ETSO gives the requirements which new models of VHF Radio Communications Transceiver Equipment Operating within the Radio Frequency Range 117.975 to 137.000 Megahertz that are manufactured on or after the date of this ETSO must meet in order to be identified with the applicable ETSO marking.

This ETSO cancels ETSO-2C37e “VHF Radio Communication Transmitting Equipment Operating within the Radio Frequency Range 117.975-137.000 Megahertz” and ETSO-2C38e “VHF Radio communication Receiving Equipment Operating within the Radio Frequency Range 117.975-137.000 Megahertz”.

### 2 - Procedures

#### 2.1. - General

Applicable procedures are detailed in CS-ETSO Subpart A.

#### 2.2 - Specific

This ETSO applies to equipment intended for aircraft VHF amplitude modulated (AM) communications operating within 117.975 to 137.000 MHz. This includes 25 and 8.33 kHz channel spacing capabilities. VHF communication equipment covered by this ETSO is primarily intended for aeronautical operational control (AOC) and air traffic services (ATS) safety communications.

### 3 - Technical Conditions

#### 3.1 - Basic

##### 3.1.1 - Minimum Performance Standard

Standards set forth in EUROCAE document ED-23C “Minimum Operational Performance Standards for Airborne VHF Receiver-Transmitter Operating within the Radio Frequency Range 117.975-137.000 MHz”, dated June 2009 for the equipment classes defined in the following table.

**Table of Equipment Classes for VHF Communication Equipment**

<b>Equipment Class</b>	<b>Description</b>
C	Receiver used in a 25 kHz channel separation environment having off-set carrier operation
D	Receiver used in a 25 kHz channel separation environment not having off-set carrier operation
E	Receiver used in an 8.33 kHz channel separation environment not having off-set carrier operation
H1 and H2	Receivers which are to be used in a 8,33 kHz channel separation environment and intended for off-set carrier operation with only two carriers.
3	Transmitter used in a 25 kHz channel separation environment and intended to operate with a range of 200 nautical miles.
4	Transmitter used in a 25 kHz channel separation environment and intended to operate with a range of 100 nautical miles.
5	Transmitter used in an 8.33 kHz channel separation environment and intended to operate with a range of 200 nautical miles.
6	Transmitter used in an 8.33 kHz channel separation environment and intended to operate with a range of 100 nautical miles.

It is recommended that, when applying for ETSO-2C169a authorisation, the applicant also applies for ETSO-2C128 "Devices that Prevent Blocked Channels Used in Two-Way Radio Communications due to Unintentional Transmission" authorisation.

### 3.1.2 - Environmental Standard

See CS-ETSO Subpart A paragraph 2.1.

### 3.1.3 - Computer Software

See CS-ETSO Subpart A paragraph 2.2

### 3.1.4 Electronic Hardware Qualification.

See CS-ETSO Subpart A paragraph 2.3

## 3.2 - Specific

### 3.2.1 Failure Condition Classification

See CS-ETSO Subpart A paragraph 2.4

Failure of the function defined in paragraph 3.1.1 of this ETSO has been determined to be a major failure condition.

## 4 - Marking

### 4.1 - General

Marking is detailed in CS-ETSO Subpart A paragraph 1.2

### 4.2 – Specific

None

## 5 - Availability of Referenced Document

See CS-ETSO Subpart A paragraph 3