



Easy Access Rules for Large Rotorcraft (CS-29) (Amendment 9)

EASA eRules: aviation rules for the 21st century

Rules are the core of the EU civil aviation system. The aim of the **EASA eRules** project is to make them **accessible** to stakeholders in an efficient and reliable way.

The **EASA eRules** is a comprehensive, single system for structuring, sharing, and storing of rules. It is the single, easy-access online database for all aviation safety rules applicable to European airspace users.

The **Easy Access Rules (EAR)** are the output of the eRules project. They are consolidated versions of those rules, combining EU regulations with EASA certification specifications (CSs), acceptable means of compliance (AMC), and guidance material (GM) in an easy-to-read format with advanced navigation features through links and bookmarks. EAR are regularly updated, following the adoption of an official publication.

The **EAR** are available:

- in PDF format;
- as dynamic online publications (online format) with a wide range of functionalities, such as filters to obtain regulatory material tailored to one's needs, a search function through the table of contents to quickly access the relevant sections, and easy navigation for computers, tablets, and mobiles; and
- in XML (machine-readable format) that can be easily processed and automated by recipients, producing output that is compatible and can be synchronised with local applications, search databases, etc.

The **EASA eRules** system is developed and implemented in close cooperation with the Member States and aviation industry to ensure that all its capabilities are relevant and effective.

Published December 2022¹

Copyright notice

© European Union, 1998-2022

Unless otherwise specified, you can re-use the legal documents published in EUR-Lex for commercial or non-commercial purposes [...] ('© European Union, <http://eur-lex.europa.eu/>, 1998-2022')².

¹ The published date represents the date when the consolidated version of the document was generated.

² Euro-Lex, Important Legal Notice: <http://eur-lex.europa.eu/content/legal-notice/legal-notice.html>.

DISCLAIMER

This document is issued by the European Union Aviation Safety Agency (referred to as both 'EASA' and 'the Agency') to provide its stakeholders with an updated, consolidated, and easy-to-read publication. It has been prepared by putting together the officially published EU regulations with the related EASA certification specifications (CSs), acceptable means of compliance (AMC) and guidance material (GM) (including their amendments) adopted so far. However, this document is not an official publication, and EASA accepts no liability for damage of any kind resulting from the risks inherent in its use.

NOTE FROM THE EDITOR

The content of this document is arranged as follows: the cover regulation (recitals and articles) of the implementing rule (IR) or delegated rule (DR) appears first, then the IR or DR annex points, followed by the related acceptable means of compliance (AMC) and guidance material (GM).

In case of certification specifications (CSs), a CS is followed by the related AMC and GM.

All elements (i.e. articles, IRs, DRs, AMC, CSs, and GM) are colour-coded and can be identified according to the illustration below. The EU regulation or EASA Executive Director (ED) decision through which the article, IR, DR, CS, AMC, or GM was introduced or last amended is indicated below the article, IR, DR, CS, AMC, or GM title *in italics*.

Certification specification	<i>ED decision</i>
Acceptable means of compliance	<i>ED decision</i>
Guidance material	<i>ED decision</i>

This document will be updated regularly to incorporate further amendments.

The format of this document has been adjusted to make it user-friendly and for reference purposes. Any comments should be sent to erules@easa.europa.eu.

INCORPORATED AMENDMENTS

CS/AMC/GM (ED DECISIONS)

Incorporated ED Decision	CS/AMC Issue No, Amendment No	Applicability date
ED Decision 2003/16/RM	CS-29/ Initial issue	14/11/2003
ED Decision 2007/014/R	CS-29/ Amendment 1	30/11/2007
ED Decision 2008/010/R	CS-29/ Amendment 2	17/11/2008
ED Decision 2012/022/R	CS-29/ Amendment 3	18/12/2012
ED Decision 2016/025/R	CS-29/ Amendment 4	2/12/2016
ED Decision 2018/007/R	CS-29/ Amendment 5	26/6/2018
ED Decision 2018/015/R	CS-29/ Amendment 6	18/12/2018
ED Decision 2019/013/R	CS-29/ Amendment 7	17/7/2019
ED Decision 2020/006/R	CS-29/ Amendment 8	1/1/2021
ED Decision 2021/010/R	CS-29/ Amendment 9	17/6/2021

Note: To access the official versions, please click on the hyperlinks provided above.

TABLE OF CONTENTS

Disclaimer	3
Note from the editor	4
Incorporated amendments	4
Table of contents	6
Preamble	20
Subpart A — General	25
AMC 29 General	25
CS 29.1 Applicability	25
Subpart B — Flight	26
GENERAL	26
CS 29.21 Proof of compliance	26
CS 29.25 Weight limits	26
CS 29.27 Centre of gravity limits	27
CS 29.29 Empty weight and corresponding centre of gravity	27
CS 29.31 Removable ballast	27
CS 29.33 Main rotor speed and pitch limits	28
PERFORMANCE	29
CS 29.45 General	29
CS 29.49 Performance at minimum operating speed	29
CS 29.51 Take-off data: General	30
CS 29.53 Take-off: Category A	30
CS 29.55 Take-off Decision Point: Category A	30
CS 29.59 Take-off Path: Category A	31
CS 29.60 Elevated heliport take-off path: Category A	31
CS 29.61 Take-off distance: Category A	32
CS 29.62 Rejected take-off: Category A	32

CS 29.63 Take-off: Category B	32
CS 29.64 Climb: General	33
CS 29.65 Climb: All engines operating	33
CS 29.67 Climb: One Engine Inoperative (OEI)	33
CS 29.71 Helicopter angle of glide: Category B	34
CS 29.75 Landing: General	34
CS 29.77 Landing Decision Point: Category A.....	35
CS 29.79 Landing: Category A.....	35
CS 29.81 Landing distance (ground level sites): Category A.....	35
CS 29.83 Landing: Category B.....	35
CS 29.85 Balked landing: Category A.....	36
CS 29.87 Height-velocity envelope	36
FLIGHT CHARACTERISTICS	37
CS 29.141 General	37
Appendix B – Airworthiness Criteria for Helicopter Instrument Flight	37
CS 29.143 Controllability and manoeuvrability.....	41
CS 29.151 Flight controls	42
CS 29.161 Trim control	42
CS 29.171 Stability: general	43
CS 29.173 Static longitudinal stability	43
CS 29.175 Demonstration of static longitudinal stability	43
CS 29.177 Static directional stability	44
CS 29.181 Dynamic stability: Category A rotorcraft	45
GROUND AND WATER HANDLING CHARACTERISTICS.....	46
CS 29.231 General	46
CS 29.235 Taxying condition	46
CS 29.239 Spray characteristics.....	46
CS 29.241 Ground resonance	46
MISCELLANEOUS FLIGHT REQUIREMENTS	47
CS 29.251 Vibration	47

Subpart C — Strength requirements	48
GENERAL	48
CS 29.301 Loads.....	48
CS 29.303 Factor of safety.....	48
CS 29.305 Strength and deformation	48
CS 29.307 Proof of structure	48
CS 29.309 Design limitations.....	49
FLIGHT LOADS	50
CS 29.321 General	50
CS 29.337 Limit manoeuvring load factor	50
CS 29.339 Resultant limit manoeuvring loads.....	50
CS 29.341 Gust loads	51
CS 29.351 Yawing conditions	51
AMC No 1 to CS 29.351 Yawing conditions	51
AMC No 2 to CS 29.351 Yaw manoeuvre conditions	54
CS 29.361 Engine torque.....	55
CONTROL SURFACE AND SYSTEM LOADS.....	56
CS 29.391 General	56
CS 29.395 Control system	56
CS 29.397 Limit pilot forces and torques	57
CS 29.399 Dual control system.....	57
CS 29.411 Ground clearance: tail rotor guard	57
CS 29.427 Unsymmetrical loads	57
GROUND LOADS.....	59
CS 29.471 General	59
CS 29.473 Ground loading conditions and assumptions.....	59
CS 29.475 Tyres and shock absorbers.....	59
CS 29.477 Landing gear arrangement.....	59
CS 29.479 Level landing conditions	59
CS 29.481 Tail-down landing conditions	60
CS 29.483 One-wheel landing conditions	60
CS 29.485 Lateral drift landing conditions	60
CS 29.493 Braked roll conditions.....	61

CS 29.497 Ground loading conditions: landing gear with tail wheels.....	61
CS 29.501 Ground loading conditions: landing gear with skids.....	63
CS 29.505 Ski landing conditions	64
CS 29.511 Ground load: unsymmetrical loads on multiple-wheel units	65
WATER LOADS.....	66
CS 29.519 Hull type rotorcraft: Water-based and amphibian	66
CS 29.521 Float landing conditions.....	66
MAIN COMPONENT REQUIREMENTS.....	68
CS 29.547 Main and tail rotor structure	68
AMC 29.547 Main rotor and tail rotor structure	68
CS 29.549 Fuselage and rotor pylon structures	69
CS 29.551 Auxiliary lifting surfaces.....	69
EMERGENCY LANDING CONDITIONS	70
CS 29.561 General	70
CS 29.562 Emergency landing dynamic conditions	71
CS 29.563 Structural ditching and emergency flotation provisions.....	72
AMC 29.563 Structural ditching and emergency flotation provisions	73
FATIGUE EVALUATION.....	77
CS 29.571 Fatigue Tolerance Evaluation of Metallic Structure	77
CS 29.573 Damage Tolerance and Fatigue Evaluation of Composite Rotorcraft Structures	78
Subpart D — Design and Construction	80
GENERAL.....	80
CS 29.601 Design	80
CS 29.602 Critical parts	80
CS 29.603 Materials.....	80
CS 29.605 Fabrication methods.....	80
CS 29.607 Fasteners.....	81
CS 29.609 Protection of structure	81
CS 29.610 Lightning and static electricity protection	81
CS 29.611 Inspection provisions.....	82
CS 29.613 Material strength properties and design values	82
CS 29.619 Special factors	82

CS 29.621 Casting factors.....	83
CS 29.623 Bearing factors	84
CS 29.625 Fitting factors	84
CS 29.629 Flutter and divergence	84
CS 29.631 Birdstrike	85
ROTORS.....	86
CS 29.653 Pressure venting and drainage of rotor blades	86
CS 29.659 Mass balance.....	86
CS 29.661 Rotor blade clearance.....	86
CS 29.663 Ground resonance prevention means	86
CONTROL SYSTEMS	87
CS 29.671 General	87
CS 29.672 Stability augmentation, automatic, and power-operated systems	87
CS 29.673 Primary flight controls	87
CS 29.674 Interconnected controls.....	88
CS 29.675 Stops.....	88
CS 29.679 Control system locks.....	88
CS 29.681 Limit load static tests.....	88
CS 29.683 Operation tests	89
CS 29.685 Control system details	89
CS 29.687 Spring devices	90
CS 29.691 Autorotation control mechanism	90
CS 29.695 Power boost and power-operated control system.....	90
LANDING GEAR	91
CS 29.723 Shock absorption tests.....	91
CS 29.725 Limit drop test.....	91
CS 29.727 Reserve energy absorption drop test	92
CS 29.729 Retracting mechanism	92
CS 29.731 Wheels	93
CS 29.733 Tyres	93
CS 29.735 Brakes	94
CS 29.737 Skis	94

FLOATS AND HULLS	95
CS 29.751 Main float buoyancy.....	95
CS 29.753 Main float design.....	95
CS 29.755 Hull buoyancy.....	95
CS 29.757 Hull and auxiliary float strength.....	95
PERSONNEL AND CARGO ACCOMMODATIONS.....	96
CS 29.771 Pilot compartment	96
CS 29.773 Pilot compartment view	96
CS 29.775 Windshields and windows	96
CS 29.777 Cockpit controls.....	97
CS 29.779 Motion and effect of cockpit controls	97
CS 29.783 Doors	97
CS 29.785 Seats, berths, safety belts, and harnesses	98
CS 29.787 Cargo and baggage compartments.....	100
CS 29.801 Ditching.....	100
AMC 29.801 Ditching.....	101
AMC to CS 29.801(e) and 29.802(c) Model test method for flotation stability	108
Appendix 1 — Worked example	117
Appendix 2 — Test specification rationale.....	120
CS 29.802 Emergency Flotation.....	122
AMC 29.802 Emergency Flotation	122
CS 29.803 Emergency evacuation.....	127
Appendix D – Criteria for demonstration of emergency evacuation procedures under CS 29.803	128
AMC 29.803(c) Emergency evacuation	129
CS 29.805 Flight crew emergency exits.....	130
AMC 29.805(c) Flight crew emergency exits	130
CS 29.807 Passenger emergency exits	131
AMC 29.807(d) Underwater emergency exits for passengers	133
CS 29.809 Emergency exit arrangement	134
AMC 29.809 Emergency exit arrangement	136
CS 29.811 Emergency exit marking	138
AMC 29.811(h) Underwater emergency exit markings.....	139
CS 29.812 Emergency lighting	140
CS 29.813 Emergency exit access	141
AMC 29.813 Emergency exit access.....	142
CS 29.815 Main aisle width.....	143

CS 29.831 Ventilation	143
CS 29.833 Heaters	143
FIRE PROTECTION.....	144
CS 29.851 Fire extinguishers	144
AMC 29.851 Fire extinguishers	144
CS 29.853 Compartment interiors	144
CS 29.855 Cargo and baggage compartments.....	146
CS 29.859 Combustion heater fire protection.....	147
CS 29.861 Fire protection of structure, controls, and other parts.....	148
CS 29.863 Flammable fluid fire protection	149
EXTERNAL LOADS	150
CS 29.865 External loads.....	150
AMC 29.865 External Loads	152
AMC No 1 to CS 29.865 External loads	152
AMC No 2 to CS 29.865 External loads operations using simple personnel-carrying device systems.....	172
MISCELLANEOUS	176
CS 29.871 Levelling marks.....	176
CS 29.873 Ballast provisions	176
Subpart E — Powerplant	177
GENERAL.....	177
CS 29.901 Installation	177
CS 29.903 Engines.....	178
CS 29.907 Engine vibration	178
CS 29.908 Cooling fans.....	179
ROTOR DRIVE SYSTEM.....	180
CS 29.917 Design	180
AMC 29.917 Rotor drive system design.....	180
CS 29.921 Rotor brake	183
CS 29.923 Rotor drive system and control mechanism tests	183
CS 29.927 Additional tests	187
AMC 29.927 Additional tests	189
CS 29.931 Shafting critical speed.....	197
CS 29.935 Shafting joints	197

CS 29.939 Turbine engine operating characteristics.....	197
FUEL SYSTEMS.....	198
CS 29.951 General	198
CS 29.952 Fuel system crash resistance	198
CS 29.953 Fuel system independence.....	200
CS 29.954 Fuel system lightning protection	200
CS 29.955 Fuel flow	201
CS 29.957 Flow between inter-connected tanks	202
CS 29.959 Unusable fuel supply	202
CS 29.961 Fuel system hot weather operation	202
CS 29.963 Fuel tanks: general	202
CS 29.965 Fuel tank tests	203
CS 29.967 Fuel tank installation	204
CS 29.969 Fuel tank expansion space	204
CS 29.971 Fuel tank sump	204
CS 29.973 Fuel tank filler connection	205
CS 29.975 Fuel tank vents and carburetor vapour vents	205
CS 29.977 Fuel tank outlet	206
CS 29.979 Pressure refuelling and fuelling provisions below fuel level.....	206
FUEL SYSTEM COMPONENTS.....	207
CS 29.991 Fuel pumps.....	207
CS 29.993 Fuel system lines and fittings	207
CS 29.995 Fuel valves.....	207
CS 29.997 Fuel strainer or filter.....	208
CS 29.999 Fuel system drains	208
CS 29.1001 Fuel jettisoning	208
OIL SYSTEM	210
CS 29.1011 Engines: General.....	210
CS 29.1013 Oil tanks	210
CS 29.1015 Oil tank tests	211
CS 29.1017 Oil lines and fittings	211
CS 29.1019 Oil strainer or filter	211

CS 29.1021 Oil system drains	212
CS 29.1023 Oil radiators	212
CS 29.1025 Oil valves.....	212
CS 29.1027 Transmissions and gearboxes: General.....	212
COOLING	214
CS 29.1041 General	214
CS 29.1043 Cooling tests.....	214
CS 29.1045 Climb cooling test procedures	215
CS 29.1047 Take-off cooling test procedures.....	216
CS 29.1049 Hovering cooling test procedures.....	217
INDUCTION SYSTEM	218
CS 29.1091 Air induction.....	218
CS 29.1093 Induction system icing protection	218
CS 29.1101 Carburettor air preheater design	219
CS 29.1103 Induction systems ducts and air duct systems	219
CS 29.1105 Induction system screens.....	220
CS 29.1107 Inter-coolers and after-coolers.....	220
CS 29.1109 Carburettor air cooling.....	220
EXHAUST SYSTEM.....	221
CS 29.1121 General	221
CS 29.1123 Exhaust piping	221
CS 29.1125 Exhaust heat exchangers	222
POWERPLANT CONTROLS AND ACCESSORIES	223
CS 29.1141 Powerplant controls: general	223
CS 29.1142 Auxiliary power unit controls.....	223
CS 29.1143 Engine controls.....	223
CS 29.1145 Ignition switches.....	224
CS 29.1147 Mixture controls.....	224
CS 29.1151 Rotor brake controls	224
CS 29.1157 Carburettor air temperature controls.....	224
CS 29.1159 Supercharger controls.....	224
CS 29.1163 Powerplant accessories	225

CS 29.1165 Engine ignition systems	225
POWERPLANT FIRE PROTECTION	226
CS 29.1181 Designated fire zones: regions included	226
CS 29.1183 Lines, fittings, and components.....	226
CS 29.1185 Flammable fluids	227
CS 29.1187 Drainage and ventilation of fire zones.....	227
CS 29.1189 Shutoff means	227
CS 29.1191 Firewalls.....	228
CS 29.1193 Cowling and engine compartment covering	228
CS 29.1194 Other surfaces	229
CS 29.1195 Fire extinguishing systems	229
CS 29.1197 Fire extinguishing agents	230
AMC 29.1197 Fire extinguishing agents.....	230
CS 29.1199 Extinguishing agent containers	232
CS 29.1201 Fire extinguishing system materials	232
CS 29.1203 Fire detector systems.....	232
Subpart F — Equipment	234
GENERAL	234
CS 29.1301 Function and installation	234
CS 29.1302 Installed systems and equipment for use by the crew members	234
AMC 29.1302 Installed systems and equipment for use by the crew members.....	235
AMC 29.1302 APPENDIX 1: Related regulatory material and documents	276
GM1 29.1302 Explanatory material.....	277
GM2 29.1302 Examples of compliance matrices.....	283
CS 29.1303 Flight and navigation instruments.....	286
AMC 29.1303 Flight and navigation instruments	287
CS 29.1305 Power plant instruments	288
CS 29.1307 Miscellaneous equipment.....	290
CS 29.1309 Equipment, systems, and installations	290
CS 29.1316 Electrical and electronic system lightning protection	291
CS 29.1317 High-Intensity Radiated Fields (HIRF) protection	292
Appendix E – HIRF Environments and Equipment HIRF Test Levels.....	292
CS 29.1319 Equipment, systems and network information security protection .	295
AMC 29.1319 Equipment, systems and network information security protection....	295
INSTRUMENTS: INSTALLATION	296

CS 29.1321 Arrangement and visibility	296
CS 29.1322 Warning, caution, and advisory lights	296
CS 29.1323 Airspeed indicating system	297
CS 29.1325 Static pressure and pressure altimeter systems.....	297
CS 29.1327 Magnetic direction indicator	298
CS 29.1329 Automatic pilot system.....	298
CS 29.1331 Instruments using a power supply.....	299
CS 29.1333 Instrument systems	299
CS 29.1335 Flight director systems.....	299
CS 29.1337 Powerplant instruments	300
ELECTRICAL SYSTEMS AND EQUIPMENT	301
CS 29.1351 General	301
CS 29.1353 Electrical equipment and installations.....	302
CS 29.1355 Distribution system	303
CS 29.1357 Circuit protective devices.....	303
CS 29.1359 Electrical system fire and smoke protection	304
CS 29.1363 Electrical system tests.....	304
LIGHTS.....	305
CS 29.1381 Instrument lights	305
CS 29.1383 Landing lights	305
CS 29.1385 Position light system installation	305
CS 29.1387 Position light system dihedral angles	306
CS 29.1389 Position light distribution and intensities	306
CS 29.1391 Minimum intensities in the horizontal plane of forward and rear position lights	307
CS 29.1393 Minimum intensities in any vertical plane of forward and rear position lights.....	307
CS 29.1395 Maximum intensities in overlapping beams of forward and rear position lights	307
CS 29.1397 Colour specifications.....	308
CS 29.1399 Riding light	308
CS 29.1401 Anti-collision light system	308
SAFETY EQUIPMENT	310

CS 29.1411 General	310
AMC 29.1411 Safety equipment — General	310
CS 29.1413 Safety belts: passenger warning device	311
CS 29.1415 Ditching equipment	311
AMC 29.1415 Ditching equipment	312
CS 29.1419 Ice protection	315
Appendix C – Icing Certification	316
MISCELLANEOUS EQUIPMENT	323
CS 29.1431 Electronic equipment.....	323
CS 29.1433 Vacuum systems.....	323
CS 29.1435 Hydraulic systems.....	323
CS 29.1439 Protective breathing equipment	324
CS 29.1457 Cockpit voice recorders.....	324
AMC 29.1457 Cockpit Voice Recorders.....	326
CS 29.1459 Flight data recorders.....	331
AMC 29.1459 Flight Data Recorders.....	332
CS 29.1460 Data link recorders	334
AMC 29.1460 Data link recorders.....	335
CS 29.1461 Equipment containing high energy rotors.....	336
CS 29.1465 Vibration Health Monitoring	336
AMC 29.1465 Vibration health monitoring.....	337
CS 29.1470 Emergency locator transmitter (ELT)	349
AMC 29.1470 Emergency locator transmitters (ELTs).....	349
Subpart G — Operating Limitations and Information	356
GENERAL	356
CS 29.1501 General	356
OPERATING LIMITATIONS	357
CS 29.1503 Airspeed limitations: general	357
CS 29.1505 Never-exceed speed	357
CS 29.1509 Rotor speed.....	358
CS 29.1517 Limiting height-speed envelope	358
CS 29.1519 Weight and centre of gravity.....	358
CS 29.1521 Powerplant limitations	358
CS 29.1522 Auxiliary power unit limitations.....	361
CS 29.1523 Minimum flight crew	361

CS 29.1525 Kinds of operation	361
CS 29.1527 Maximum operating altitude	361
CS 29.1529 Instructions for Continued Airworthiness	362
Appendix A – Instructions for Continued Airworthiness	362
MARKINGS AND PLACARDS	364
CS 29.1541 General	364
CS 29.1543 Instrument markings: general	364
CS 29.1545 Airspeed indicator	364
CS 29.1547 Magnetic direction indicator	365
CS 29.1549 Powerplant instruments	365
CS 29.1551 Oil quantity indicator	365
CS 29.1553 Fuel quantity indicator	365
CS 29.1555 Control markings	365
AMC 29.1555 Control markings	366
CS 29.1557 Miscellaneous markings and placards	367
CS 29.1559 Limitations placard	367
CS 29.1561 Safety equipment	367
AMC 29.1561 Safety Equipment	368
CS 29.1565 Tail rotor	368
ROTORCRAFT FLIGHT MANUAL	369
CS 29.1581 General	369
CS 29.1583 Operating limitations	369
AMC 29.1583 Operating limitations	370
CS 29.1585 Operating procedures	370
AMC 29.1585 Operating Procedures	371
CS 29.1587 Performance information	371
AMC 29.1587(c) Performance Information	373
CS 29.1589 Loading information	374
CS 29.1593 Exposure to volcanic cloud hazards	374
AMC 29.1593 Exposure to volcanic cloud hazards	374
Miscellaneous guidance	376
MG 1 Certification procedure for rotorcraft avionics equipment	376
MG4 Full Authority Digital Electronic Controls (FADEC)	378
MG5 Agricultural dispensing equipment installation	378

MG 6 Emergency Medical Service (EMS) systems installations, including interior arrangements, equipment, Helicopter Terrain Awareness and Warning System (HTAWS), radio altimeter, and Flight Data Monitoring System (FDMS).....	378
MG 16 Certification guidance for rotorcraft Night Vision Imaging System (NVIS) aircraft lighting systems.....	381
MG 17 Guidance on analysing an Advanced Flight Controls (AdFC) System	383
MG 21 Guidance on creating a system level Functional Hazard Assessment (FHA).....	383
MG 23 Automatic Flight Guidance and Control Systems (AFGCS) installation in CS-29 Rotorcraft.....	384

PREAMBLE

ED Decision 2021/010/R

CS-29 Amendment 9

The following is a list of paragraphs affected by this amendment:

Subpart F	
CS 29.1302	Created (NPA 2019-01)
AMC 29.1302	Created (NPA 2019-01)
AMC 29.1302 Appendix 1	Created (NPA 2019-01)
GM1 29.1302	Created (NPA 2019-01)
GM2 29.1302	Created (NPA 2019-01)
CS 29.1457	Amended (NPA 2019-12)
AMC 29.1457	Amended (NPA 2019-12)
CS 29.1459	Amended (NPA 2019-12)
AMC 29.1459	Amended (NPA 2019-12)
CS 29.1460	Created (NPA 2019-12)
AMC 29.1460	Created (NPA 2019-12)

ED Decision 2020/006/R

CS-29 Amendment 8

The following is a list of paragraphs affected by this amendment:

Subpart F	
CS 29.1319	Created (NPA 2019-01)
AMC 29.1319	Created (NPA 2019-01)
Subpart G	
Appendix A29.5	Created (NPA 2019-01)

ED Decision 2019/013/R

CS-29 Amendment 7

The following is a list of paragraphs affected by this amendment:

Subpart F	
CS 29.1457	Amended (NPA 2018-03)
AMC 29.1457	Created (NPA 2018-03)
CS 29.1459	Amended (NPA 2018-03)
AMC 29.1459	Created (NPA 2018-03)

ED Decision 2018/015/R

CS-29 Amendment 6

The following is a list of paragraphs affected by this amendment:

Subpart A	
-----------	--

AMC 29 General	Amended (Article 15 consultation with the ABs)
Subpart D	
AMC 29.865	Amended (Article 15 consultation with the ABs)
AMC No 1 to CS 29.865	Amended (Article 15 consultation with the ABs)
AMC No 2 to CS 29.865	Amended (Article 15 consultation with the ABs)
Subpart F	
AMC 29.1303	Created (Article 15 consultation with the ABs)
Miscellaneous guidance	
MG 1	Created (Article 15 consultation with the ABs)
MG 6	Amended (Article 15 consultation with the ABs)
MG 16	Created (Article 15 consultation with the ABs)
MG 17	Created (Article 15 consultation with the ABs)
MG 21	Created (Article 15 consultation with the ABs)
MG 23	Created (Article 15 consultation with the ABs)

ED Decision 2018/007/R

CS-29 Amendment 5

The following is a list of paragraphs affected by this amendment:

Subpart C	
CS 29.563	Amended (NPA 2016-01)
AMC 29.563	Created (NPA 2016-01)
Subpart D	
CS 29.725	Amended (editorial change)
CS 29.783	Amended (NPA 2016-01)
CS 29.801	Amended (NPA 2016-01)
AMC 29.801	Created (NPA 2016-01)
AMC to 29.801(e) and 29.802(c)	Created (NPA 2016-01)
CS 29.802	Created (NPA 2016-01)
AMC 29.802	Created (NPA 2016-01)
CS 29.803	Amended (NPA 2016-01)
AMC 29.803(c)	Created (NPA 2016-01)
CS 29.805	Amended (NPA 2016-01)
AMC 29.805(c)	Created (NPA 2016-01)
CS 29.807	Amended (NPA 2016-01)
AMC 29.807(d)	Created (NPA 2016-01)
CS 29.809	Amended (NPA 2016-01)
AMC 29.809	Created (NPA 2016-01)
CS 29.811	Amended (NPA 2016-01)
AMC 29.811(h)	Created (NPA 2016-01)
CS 29.812	Amended (NPA 2016-01)
CS 29.813	Amended (NPA 2016-01)
AMC 29.813	Created (NPA 2016-01)
CS 29.865	Amended (Article 16 consultation with the ABs)
AMC 29.865	Created (Article 16 consultation with the ABs)
AMC No 1 to CS 29.865	Created (Article 16 consultation with the ABs)

AMC No 2 to 29.865	Created (Article 16 consultation with the ABs)
Subpart E	
CS 29.917	Amended (NPA 2017-07)
AMC 29.917	Amended (NPA 2017-07)
CS 29.927	Amended (NPA 2017-07)
AMC 29.927	Created (NPA 2017-07)
Subpart F	
CS 29.1411	Amended (NPA 2016-01)
AMC 29.1411	Created (NPA 2016-01)
CS 29.1415	Amended (NPA 2016-01)
AMC 29.1415	Created (NPA 2016-01)
CS 29.1470	Created (NPA 2016-01)
AMC 29.1470	Created (NPA 2016-01)
Subpart G	
CS 29.1555	Amended (NPA 2016-01)
AMC 29.1555	Created (NPA 2016-01)
CS 29.1561	Amended (NPA 2016-01)
AMC 29.1561	Created (NPA 2016-01)
CS 29.1585	Amended (NPA 2017-07)
AMC 29.1585	Created (NPA 2017-07)
CS 29.1587	Amended (NPA 2016-01)
AMC 29.1587(c)	Created (NPA 2017-07)

ED Decision 2016/025/R

CS-29 Amendment 4

The following is a list of paragraphs affected by this amendment:

Subpart A	
AMC 29 General	Amended (NPA 2013-04)
CS 29.1	Amended (Editorial change)
Subpart C	
AMC No 1 to CS 29.351	Created (NPA 2013-21)
AMC No 2 to CS 29.351	Renamed and amended (NPA 2013-21)
Subpart D	
CS 29.610	Amended (NPA 2014-16)
Subpart F	
CS 29.1309	Amended (NPA 2014-16)
CS 29.1316	Created (NPA 2014-16)
CS 29.1317	Created (NPA 2014-16)
CS-29 Appendix E	Created (NPA 2014-16)
Subpart G	
CS 29.1501	Amended (NPA 2011-17)
AMC 29.1583	Created (NPA 2013-04)
CS 29.1593	Created (NPA 2014-16)
AMC 29.1593	Created (NPA 2011-17)
Miscellaneous guidance	

MG5	Created (NPA 2013-04)
MG6	Created (NPA 2013-04)

ED Decision 2012/022/R

CS-29 Amendment 3

The following is a list of paragraphs affected by this amendment:

Subpart C	
AMC 29.547	Created (NPA 2010-12)
CS 29.571	Created (NPA 2010-06)
CS 29.573	Created (NPA 2010-04)
Subpart D	
AMC 29.851	Created (NPA 2011-14)
Subpart E	
AMC 29.917	Created (NPA 2010-12)
CS 29.955	Editorial change
AMC 29.1197	Created (NPA 2011-14)
Subpart F	
CS 29.1401	Editorial change
CS 29.1465	Created (NPA 2010-12)
AMC 29.1465	Created (NPA 2010-12)
Subpart G	
CS-29 Appendix A A29.4	Amended (NPA 2010-04)

ED Decision 2008/010/R

CS-29 Amendment 2

The following is a list of paragraphs affected by this amendment:

Subpart A	
AMC 29 General	Amended (NPA 2007-17)
Subpart B	
CS 29.143	Corrected
Subpart C	
AMC 29.351	Created (NPA 2007-17)
Subpart D	
AMC 29.602	Deleted (NPA 2007-17)
Subpart F	
CS 29.1305	Amended (NPA 2007-17)
AMC 29.1305(a)(25) and (26)	Deleted (NPA 2007-17)
Subpart G	
CS 29.1587	Amended (NPA 2007-17)
CS-29 Appendix A	Amended (NPA 2007-17)
AMC to Appendix A, A29.3(b)(2)	Deleted (NPA 2007-17)
Miscellaneous guidance	
MG4	Created (NPA 2007-17)

CS-29 Amendment 1

The following is a list of paragraphs affected by this amendment:

Preamble	Preamble added
Subpart B	
CS 29.25	Amended (NPA 12/2006)
CS-29 Appendix B	Amended (NPA 12/2006)
CS 29.143	Amended (NPA 12/2006)
CS 29.173	Amended (NPA 12/2006)
CS 29.175	Amended (NPA 12/2006)
CS 29.177	Amended (NPA 12/2006)
Subpart G	
CS 29.1587	Amended (NPA 12/2006)

SUBPART A — GENERAL

AMC 29 General

ED Decision 2018/015/R

1. The AMC to CS-29 consists of FAA AC 29-2C — Change 7, dated 4 February 2016, with the changes/additions given in this BOOK 2 of CS-29.
2. The primary reference for each of these AMCs is the CS-29 paragraph. Where there is an appropriate paragraph in FAA AC 29-2C — Change 7, dated 4 February 2016, this is added as a secondary reference.

[Amdt No: 29/2]

[Amdt No: 29/4]

[Amdt No: 29/6]

CS 29.1 Applicability

ED Decision 2016/025/R

- (a) These certification specifications are applicable to large rotorcraft.
- (b) Large rotorcraft must be certificated in accordance with either the Category A or Category B requirements. A multi-engine rotorcraft may be type certificated as both Category A and Category B with appropriate and different operating limitations for each category.
- (c) Rotorcraft with a maximum weight greater than 9072 kg (20 000 pounds) and 10 or more passenger seats must be type certificated as Category A rotorcraft.
- (d) Rotorcraft with a maximum weight greater than 9072 kg (20 000 pounds) and nine or less passenger seats may be type certificated as Category B rotorcraft provided the Category A requirements of Subparts C, D, E, and F are met.
- (e) Rotorcraft with a maximum weight of 9072 kg (20 000 pounds) or less but with 10 or more passenger seats may be type certificated as Category B rotorcraft provided the Category A requirements of [CS 29.67\(a\)\(2\)](#), [29.87](#), [29.1517](#), and of Subparts C, D, E, and F are met.
- (f) Rotorcraft with a maximum weight of 9072 kg (20 000 pounds) or less and nine or less passenger seats may be type certificated as Category B rotorcraft.

[Amdt 29/4]

SUBPART B — FLIGHT

GENERAL

CS 29.21 Proof of compliance

ED Decision 2003/16/RM

Each requirement of this Subpart must be met at each appropriate combination of weight and centre of gravity within the range of loading conditions for which certification is requested. This must be shown:

- (a) By tests upon a rotorcraft of the type for which certification is requested, or by calculations based on, and equal in accuracy to, the results of testing; and
- (b) By systematic investigation of each required combination of weight and centre of gravity, if compliance cannot be reasonably inferred from combinations investigated.

CS 29.25 Weight limits

ED Decision 2007/014/R

- (a) *Maximum weight.* The maximum weight (the highest weight at which compliance with each applicable requirement of this CS-29 is shown) or, at the option of the applicant, the highest weight for each altitude and for each practicably separable operating condition, such as take-off, en-route operation, and landing, must be established so that it is not more than:
 - (1) The highest weight selected by the applicant;
 - (2) The design maximum weight (the highest weight at which compliance with each applicable structural loading condition of this CS-29 is shown); or
 - (3) The highest weight at which compliance with each applicable flight requirement of this CS-29 is shown.
 - (4) For Category B rotorcraft with 9 or less passenger seats, the maximum weight, altitude, and temperature at which the rotorcraft can safely operate near the ground with the maximum wind velocity determined under [CS 29.143\(c\)](#) and may include other demonstrated wind velocities and azimuths. The operating envelopes must be stated in the Limitations section of the Rotorcraft Flight Manual.
- (b) *Minimum weight.* The minimum weight (the lowest weight at which compliance with each applicable requirement of this CS-29 is shown) must be established so that it is not less than:
 - (1) The lowest weight selected by the applicant;
 - (2) The design minimum weight (the lowest weight at which compliance with each structural loading condition of this CS-29 is shown); or
 - (3) The lowest weight at which compliance with each applicable flight requirement of this CS-29 is shown.
- (c) *Total weight with jettisonable external load.* A total weight for the rotorcraft with a jettisonable external load attached that is greater than the maximum weight established under subparagraph (a) may be established for any rotorcraft-load combination if:
 - (1) The rotorcraft-load combination does not include human external cargo,

- (2) Structural component approval for external load operations under either [CS 29.865](#), or under equivalent operational standards is obtained,
- (3) The portion of the total weight that is greater than the maximum weight established under sub-paragraph (a) is made up only of the weight of all or part of the jettisonable external load,
- (4) Structural components of the rotorcraft are shown to comply with the applicable structural requirements of this CS-29 under the increased loads and stresses caused by the weight increase over that established under sub-paragraph (a), and
- (5) Operation of the rotorcraft at a total weight greater than the maximum certificated weight established under sub-paragraph (a) is limited by appropriate operating limitations under [CS 29.865\(a\) and \(d\)](#).

[Amdt. No.: 29/1]

CS 29.27 Centre of gravity limits

ED Decision 2003/16/RM

The extreme forward and aft centres of gravity and, where critical, the extreme lateral centres of gravity must be established for each weight established under [CS 29.25](#). Such an extreme may not lie beyond –

- (a) The extremes selected by the applicant;
- (b) The extremes within which the structure is proven; or
- (c) The extremes within which compliance with the applicable flight requirements is shown.

CS 29.29 Empty weight and corresponding centre of gravity

ED Decision 2003/16/RM

- (a) The empty weight and corresponding centre of gravity must be determined by weighing the rotorcraft without the crew and payload, but with:
 - (1) Fixed ballast;
 - (2) Unusable fuel; and
 - (3) Full operating fluids, including:
 - (i) Oil;
 - (ii) Hydraulic fluid; and
 - (iii) Other fluids required for normal operation of rotorcraft systems, except water intended for injection in the engines.
- (b) The condition of the rotorcraft at the time of determining empty weight must be one that is well defined and can be easily repeated, particularly with respect to the weights of fuel, oil, coolant, and installed equipment.

CS 29.31 Removable ballast

ED Decision 2003/16/RM

Removable ballast may be used in showing compliance with the flight requirements of this Subpart.

CS 29.33 Main rotor speed and pitch limits

ED Decision 2003/16/RM

- (a) *Main rotor speed limits.* A range of main rotor speeds must be established that:
- (1) With power on, provides adequate margin to accommodate the variations in rotor speed occurring in any appropriate manoeuvre, and is consistent with the kind of governor or synchroniser used; and
 - (2) With power off, allows each appropriate autorotative manoeuvre to be performed throughout the ranges of airspeed and weight for which certification is requested.
- (b) *Normal main rotor high pitch limit (power-on).* For rotorcraft, except helicopters required to have a main rotor low speed warning under sub-paragraph (e), it must be shown, with power on and without exceeding approved engine maximum limitations, that main rotor speeds substantially less than the minimum approved main rotor speed will not occur under any sustained flight condition. This must be met by:
- (1) Appropriate setting of the main rotor high pitch stop;
 - (2) Inherent rotorcraft characteristics that make unsafe low main rotor speeds unlikely; or
 - (3) Adequate means to warn the pilot of unsafe main rotor speeds.
- (c) *Normal main rotor low pitch limit (power-off).* It must be shown, with power off, that:
- (1) The normal main rotor low pitch limit provides sufficient rotor speed, in any autorotative condition, under the most critical combinations of weight and airspeed; and
 - (2) It is possible to prevent overspeeding of the rotor without exceptional piloting skill.
- (d) *Emergency high pitch.* If the main rotor high pitch stop is set to meet sub-paragraph (b)(1), and if that stop cannot be exceeded inadvertently, additional pitch may be made available for emergency use.
- (e) *Main rotor low speed warning for helicopters.* For each single engine helicopter, and each multi-engine helicopter that does not have an approved device that automatically increases power on the operating engines when one engine fails, there must be a main rotor low speed warning which meets the following requirements:
- (1) The warning must be furnished to the pilot in all flight conditions, including power-on and power-off flight, when the speed of a main rotor approaches a value that can jeopardise safe flight.
 - (2) The warning may be furnished either through the inherent aerodynamic qualities of the helicopter or by a device.
 - (3) The warning must be clear and distinct under all conditions, and must be clearly distinguishable from all other warnings. A visual device that requires the attention of the crew within the cockpit is not acceptable by itself.
 - (4) If a warning device is used, the device must automatically deactivate and reset when the low-speed condition is corrected. If the device has an audible warning, it must also be equipped with a means for the pilot to manually silence the audible warning before the low-speed condition is corrected.

PERFORMANCE

CS 29.45 General

ED Decision 2003/16/RM

- (a) The performance prescribed in this subpart must be determined:
 - (1) With normal piloting skill; and
 - (2) Without exceptionally favourable conditions.
- (b) Compliance with the performance requirements of this subpart must be shown:
 - (1) For still air at sea-level with a standard atmosphere; and
 - (2) For the approved range of atmospheric variables.
- (c) The available power must correspond to engine power, not exceeding the approved power, less:
 - (1) Installation losses; and
 - (2) The power absorbed by the accessories and services at the values for which certification is requested and approved.
- (d) For reciprocating engine-powered rotorcraft, the performance, as affected by engine power, must be based on a relative humidity of 80% in a standard atmosphere.
- (e) For turbine engine-powered rotorcraft, the performance, as affected by engine power, must be based on a relative humidity of:
 - (1) 80%, at and below standard temperature; and
 - (2) 34%, at and above standard temperature plus 28°C (50°F).Between these two temperatures, the relative humidity must vary linearly.
- (f) For turbine-engine-powered rotorcraft, a means must be provided to permit the pilot to determine prior to take-off that each engine is capable of developing the power necessary to achieve the applicable rotorcraft performance prescribed in this subpart.

CS 29.49 Performance at minimum operating speed

ED Decision 2003/16/RM

- (a) For each Category A helicopter, the hovering performance must be determined over the ranges of weight, altitude and temperature for which take-off data are scheduled:
 - (1) With not more than take-off power;
 - (2) With the landing gear extended; and
 - (3) At a height consistent with the procedure used in establishing the take-off, climbout and rejected take-off paths.
- (b) For each Category B helicopter, the hovering performance must be determined over the ranges of weight, altitude and temperature for which certification is requested, with:
 - (1) Take-off power;
 - (2) The landing gear extended; and

- (3) The helicopter in ground effect at a height consistent with normal take-off procedures.
- (c) For each helicopter, the out-of ground- effect hovering performance must be determined over the ranges of weight, altitude and temperature for which certification is requested, with take-off power.
- (d) For rotorcraft other than helicopters, the steady rate of climb at the minimum operating speed must be determined over the ranges of weight, altitude and temperature for which certification is requested, with:
 - (1) Take-off power; and
 - (2) The landing gear extended.

CS 29.51 Take-off data: General

ED Decision 2003/16/RM

- (a) The take-off data required by [CS 29.53](#), [29.55](#), [29.59](#), [29.60](#), [29.61](#), [29.62](#), [29.63](#) and [29.67](#) must be determined:
 - (1) At each weight, altitude, and temperature selected by the applicant; and
 - (2) With the operating engines within approved operating limitations.
- (b) Take-off data must:
 - (1) Be determined on a smooth, dry, hard surface; and
 - (2) Be corrected to assume a level take-off surface.
- (c) No take-off made to determine the data required by this paragraph may require exceptional piloting skill or alertness, or exceptionally favourable conditions.

CS 29.53 Take-off: Category A

ED Decision 2003/16/RM

The take-off performance must be determined and scheduled so that, if one engine fails at any time after the start of take-off, the rotorcraft can:

- (a) Return to and stop safely on, the take-off area; or
- (b) Continue the take-off and climb-out, and attain a configuration and airspeed allowing compliance with [CS 29.67\(a\)\(2\)](#).

CS 29.55 Take-off Decision Point: Category A

ED Decision 2003/16/RM

- (a) The take-off decision point (TDP) is the first point from which a continued take-off capability is assured under [CS 29.59](#) and is the last point in the take-off path from which a rejected take-off is assured within the distance determined under [CS 29.62](#).
- (b) The TDP must be established in relation to the take-off path using no more than two parameters, such as airspeed and height, to designate the TDP.
- (c) Determination of the TDP must include the pilot recognition time interval following failure of the critical engine.

CS 29.59 Take-off Path: Category A

ED Decision 2003/16/RM

- (a) The take-off path extends from the point of commencement of the take-off procedure to a point at which the rotorcraft is 305 m (1000 ft) above the take-off surface and compliance with [CS 29.67\(a\)\(2\)](#) is shown. In addition:
- (1) The take-off path must remain clear of the height-velocity envelope established in accordance with [CS 29.87](#);
 - (2) The rotorcraft must be flown to the engine failure point at which point the critical engine must be made inoperative and remain inoperative for the rest of the take-off;
 - (3) After the critical engine is made inoperative, the rotorcraft must continue to the TDP, and then attain V_{TOSS} .
 - (4) Only primary controls may be used while attaining V_{TOSS} and while establishing a positive rate of climb. Secondary controls that are located on the primary controls may be used after a positive rate of climb and V_{TOSS} are established but in no case less than 3 seconds after the critical engine is made inoperative; and
 - (5) After attaining V_{TOSS} and a positive rate of climb, the landing gear may be retracted.
- (b) During the take-off path determination made in accordance with sub-paragraph (a) and after attaining V_{TOSS} and a positive rate of climb, the climb must be continued at a speed as close as practicable to, but not less than, V_{TOSS} until the rotorcraft is 61 m (200 ft) above the take-off surface. During this interval, the climb performance must meet or exceed that required by [CS 29.67\(a\)\(1\)](#).
- (c) During the continued take-off the rotorcraft shall not descend below 4.6 m (15 ft) above the take-off surface when the TDP is above 4.6 m (15 ft).
- (d) From 61 m (200 ft) above the take-off surface, the rotorcraft take-off path must be level or positive until a height 305 m (1000 ft) above the take-off surface is attained with not less than the rate of climb required by [CS 29.67\(a\)\(2\)](#). Any secondary or auxiliary control may be used after attaining 61 m (200 ft) above the take-off surface.
- (e) Take-off distance will be determined in accordance with [CS 29.61](#).

CS 29.60 Elevated heliport take-off path: Category A

ED Decision 2003/16/RM

- (a) The elevated heliport take-off path extends from the point of commencement of the take-off procedure to a point in the take-off path at which the rotorcraft is 305 m (1 000 ft) above the take-off surface and compliance with [CS 29.67\(a\)\(2\)](#) is shown. In addition:
- (1) The requirements of [CS 29.59\(a\)](#) must be met;
 - (2) While attaining V_{TOSS} and a positive rate of climb, the rotorcraft may descend below the level of the take-off surface if, in so doing and when clearing the elevated heliport edge, every part of the rotorcraft clears all obstacles by at least 4.6 m (15 ft);
 - (3) The vertical magnitude of any descent below the take-off surface must be determined; and
 - (4) After attaining V_{TOSS} and a positive rate of climb, the landing gear may be retracted.

- (b) The scheduled take-off weight must be such that the climb requirements of [CS 29.67\(a\)\(1\)](#) and [CS 29.67\(a\)\(2\)](#) will be met.
- (c) Take-off distance will be determined in accordance with [CS 29.61](#).

CS 29.61 Take-off distance: Category A

ED Decision 2003/16/RM

- (a) The normal take-off distance is the horizontal distance along the take-off path from the start of the take-off to the point at which the rotorcraft attains and remains at least 11 m (35 ft) above the take-off surface, attains and maintains a speed of at least V_{TOSS} ; and establishes a positive rate of climb, assuming the critical engine failure occurs at the engine failure point prior to the TDP.
- (b) For elevated heliports, the take-off distance is the horizontal distance along the take-off path from the start of the take-off to the point at which the rotorcraft attains and maintains a speed of at least V_{TOSS} and establishes a positive rate of climb, assuming the critical engine failure occurs at the engine failure point prior to the TDP.

CS 29.62 Rejected take-off: Category A

ED Decision 2003/16/RM

The rejected take-off distance and procedures for each condition where take-off is approved will be established with:

- (a) The take-off path requirements of [CS 29.59](#) and [29.60](#) being used up to the TDP where the critical engine failure is recognised, and the rotorcraft landed and brought to a stop on the take-off surface;
- (b) The remaining engines operating within approved limits;
- (c) The landing gear remaining extended throughout the entire rejected take-off; and
- (d) The use of only the primary controls until the rotorcraft is on the ground. Secondary controls located on the primary control may not be used until the rotorcraft is on the ground. Means other than wheel brakes may be used to stop the rotorcraft if the means are safe and reliable and consistent results can be expected under normal operating conditions.

CS 29.63 Take-off: Category B

ED Decision 2003/16/RM

The horizontal distance required to take-off and climb over a 15 m (50-foot) obstacle must be established with the most unfavourable centre of gravity. The take-off may be begun in any manner if –

- (a) The take-off surface is defined;
- (b) Adequate safeguards are maintained to ensure proper centre of gravity and control positions; and
- (c) A landing can be made safely at any point along the flight path if an engine fails.

CS 29.64 Climb: General

ED Decision 2003/16/RM

Compliance with the requirements of [CS 29.65](#) and [29.67](#) must be shown at each weight, altitude and temperature within the operational limits established for the rotorcraft and with the most unfavourable centre of gravity for each configuration. Cowl flaps, or other means of controlling the engine-cooling air supply, will be in the position that provides adequate cooling at the temperatures and altitudes for which certification is requested.

CS 29.65 Climb: All engines operating

ED Decision 2003/16/RM

- (a) The steady rate of climb must be determined:
 - (1) With maximum continuous power;
 - (2) With the landing gear retracted; and
 - (3) At V_Y for standard sea-level conditions and at speeds selected by the applicant for other conditions.
- (b) For each Category B rotorcraft except helicopters, the rate of climb determined under subparagraph (a) must provide a steady climb gradient of at least 1:6 under standard sea-level conditions.

CS 29.67 Climb: One Engine Inoperative (OEI)

ED Decision 2003/16/RM

- (a) For Category A rotorcraft, in the critical take-off configuration existing along the take-off path, the following apply:
 - (1) The steady rate of climb without ground effect, 61 m (200 ft) above the take-off surface, must be at least 30 m (100 ft) per minute, for each weight, altitude, and temperature for which take-off data are to be scheduled with:
 - (i) The critical engine inoperative and the remaining engines within approved operating limitations, except that for rotorcraft for which the use of 30-second/2-minute OEI power is requested, only the 2-minute OEI power may be used in showing compliance with this paragraph;
 - (ii) The landing gear extended; and
 - (iii) The take-off safety speed selected by the applicant.
 - (2) The steady rate of climb without ground effect, 305 m (1 000 ft) above the take-off surface, must be at least 46 m (150 ft) per minute, for each weight, altitude, and temperature for which take-off data are to be scheduled with:
 - (i) The critical engine inoperative and the remaining engines at maximum continuous power including continuous OEI power, if approved, or at 30-minute OEI power for rotorcraft for which certification for use of 30-minute OEI power is requested;
 - (ii) The landing gear retracted; and
 - (iii) The speed selected by the applicant.

- (3) The steady rate of climb (or descent), in feet per minute, at each altitude and temperature at which the rotorcraft is expected to operate and at each weight within the range of weights for which certification is requested, must be determined with:
 - (i) The critical engine inoperative and the remaining engines at maximum continuous power including continuous OEI power, if approved, and at 30-minute OEI power for rotorcraft for which certification for the use of 30-minute OEI power is requested;
 - (ii) The landing gear retracted; and
 - (iii) The speed selected by the applicant.
- (b) For multi-engine Category B rotorcraft meeting the Category A engine isolation requirements, the steady rate of climb (or descent) must be determined at the speed for best rate of climb (or minimum rate of descent) at each altitude, temperature, and weight at which the rotorcraft is expected to operate, with the critical engine inoperative and the remaining engines at maximum continuous power including continuous OEI power, if approved, and at 30-minute OEI power for rotorcraft for which certification for the use of 30-minute OEI power is requested.

CS 29.71 Helicopter angle of glide: Category B

ED Decision 2003/16/RM

For each Category B helicopter, except multi-engine helicopters meeting the requirements of [CS 29.67\(b\)](#) and the powerplant installation requirements of Category A, the steady angle of glide must be determined in autorotation:

- (a) At the forward speed for minimum rate of descent as selected by the applicant;
- (b) At the forward speed for best glide angle;
- (c) At maximum weight; and
- (d) At the rotor speed or speeds selected by the applicant.

CS 29.75 Landing: General

ED Decision 2003/16/RM

- (a) For each rotorcraft:
 - (1) The corrected landing data must be determined for a smooth, dry, hard and level surface;
 - (2) The approach and landing must not require exceptional piloting skill or exceptionally favourable conditions; and,
 - (3) The landing must be made without excessive vertical acceleration or tendency to bounce, nose over, ground loop, porpoise, or water loop.
- (b) The landing data required by [CS 29.77](#), [29.79](#), [29.81](#), [29.83](#) and [29.85](#) must be determined:
 - (1) At each weight, altitude and temperature for which landing data are approved:
 - (2) With each operating engine within approved operating limitations: and
 - (3) With the most unfavourable centre of gravity.

CS 29.77 Landing Decision Point: Category A

ED Decision 2003/16/RM

- (a) The landing decision point (LDP) is the last point in the approach and landing path from which a balked landing can be accomplished in accordance with [CS 29.85](#).
- (b) Determination of the LDP must include the pilot recognition time interval following failure of the critical engine.

CS 29.79 Landing: Category A

ED Decision 2003/16/RM

- (a) For Category A rotorcraft:
 - (1) The landing performance must be determined and scheduled so that if the critical engine fails at any point in the approach path, the rotorcraft can either land and stop safely or climb out and attain a rotorcraft configuration and speed allowing compliance with the climb requirement of [CS 29.67\(a\)\(2\)](#);
 - (2) The approach and landing paths must be established with the critical engine inoperative so that the transition between each stage can be made smoothly and safely;
 - (3) The approach and landing speeds must be selected for the rotorcraft and must be appropriate to the type of rotorcraft; and
 - (4) The approach and landing path must be established to avoid the critical areas of the height-velocity envelope determined in accordance with [CS 29.87](#).
- (b) It must be possible to make a safe landing on a prepared landing surface after complete power failure occurring during normal cruise.

CS 29.81 Landing distance (ground level sites): Category A

ED Decision 2003/16/RM

The horizontal distance required to land and come to a complete stop (or to a speed of approximately 5.6 km/h (3 knots) for water landings) from a point 15 m (50 ft) above the landing surface must be determined from the approach and landing paths established in accordance with [CS 29.79](#).

CS 29.83 Landing: Category B

ED Decision 2003/16/RM

- (a) For each Category B rotorcraft, the horizontal distance required to land and come to a complete stop (or to a speed of approximately 5.6 km/h (3 knots) for water landings) from a point 15 m (50 ft) above the landing surface must be determined with:
 - (1) Speeds appropriate to the type of rotorcraft and chosen by the applicant to avoid the critical areas of the height-velocity envelope established under [CS 29.87](#); and
 - (2) The approach and landing made with power on and within approved limits.

- (b) Each multi-engine Category B rotorcraft that meets the powerplant installation requirements for Category A must meet the requirements of:
 - (1) [CS 29.79](#) and [29.81](#); or
 - (2) Sub-paragraph (a).
- (c) It must be possible to make a safe landing on a prepared landing surface if complete power failure occurs during normal cruise.

CS 29.85 Balked landing: Category A

ED Decision 2003/16/RM

For Category A rotorcraft, the balked landing path with the critical engine inoperative must be established so that:

- (a) The transition from each stage of the manoeuvre to the next stage can be made smoothly and safely;
- (b) From the LDP on the approach path selected by the applicant, a safe climbout can be made at speeds allowing compliance with the climb requirements of [CS 29.67\(a\)\(1\) and \(2\)](#); and
- (c) The rotorcraft does not descend below 4.6 m (15 ft) above the landing surface. For elevated heliport operations, descent may be below the level of the landing surface provided the deck edge clearance of [CS 29.60](#) is maintained and the descent (loss of height) below the landing surface is determined.

CS 29.87 Height-velocity envelope

ED Decision 2003/16/RM

- (a) If there is any combination of height and forward velocity (including hover) under which a safe landing cannot be made after failure of the critical engine and with the remaining engines (where applicable) operating within approved limits, a height-velocity envelope must be established for:
 - (1) All combinations of pressure altitude and ambient temperature for which take-off and landing are approved; and
 - (2) Weight, from the maximum weight (at sea-level) to the highest weight approved for take-off and landing at each altitude. For helicopters, this weight need not exceed the highest weight allowing hovering out of ground effect at each altitude.
- (b) For single engine or multi-engine rotorcraft that do not meet the Category A engine isolation requirements, the height-velocity envelope for complete power failure must be established.

FLIGHT CHARACTERISTICS

CS 29.141 General

ED Decision 2003/16/RM

The rotorcraft must:

- (a) Except as specifically required in the applicable paragraph, meet the flight characteristics requirements of this Subpart:
 - (1) At the approved operating altitudes and temperatures;
 - (2) Under any critical loading condition within the range of weights and centres of gravity for which certification is requested; and
 - (3) For power-on operations, under any condition of speed, power, and rotor rpm for which certification is requested; and
 - (4) For power-off operations, under any condition of speed, and rotor rpm for which certification is requested that is attainable with the controls rigged in accordance with the approved rigging instructions and tolerances;
- (b) Be able to maintain any required flight condition and make a smooth transition from any flight condition to any other flight condition without exceptional piloting skill, alertness, or strength, and without danger of exceeding the limit load factor under any operating condition probable for the type, including:
 - (1) Sudden failure of one engine, for multi-engine rotorcraft meeting Category A engine isolation requirements;
 - (2) Sudden, complete power failure, for other rotorcraft; and
 - (3) Sudden, complete control system failures specified in [CS 29.695](#); and
- (c) Have any additional characteristics required for night or instrument operation, if certification for those kinds of operation is requested. Requirements for helicopter instrument flight are contained in [appendix B](#).

Appendix B – Airworthiness Criteria for Helicopter Instrument Flight

ED Decision 2007/014/R

- I. *General.* A large helicopter may not be type certificated for operation under the instrument flight rules (IFR) unless it meets the design and installation requirements contained in this appendix.
- II. *Definitions*
 - (a) V_{VI} means instrument climb speed, utilised instead of V_Y for compliance with the climb requirements for instrument flight.
 - (b) V_{NEI} means instrument flight never-exceed speed, utilised instead of V_{NE} for compliance with maximum limit speed requirements for instrument flight.
 - (c) V_{MINI} means instrument flight minimum speed, utilised in complying with minimum limit speed requirements for instrument flight.

- III. *Trim*. It must be possible to trim the cyclic, collective, and directional control forces to zero at all approved IFR airspeeds, power settings, and configurations appropriate to the type.
- (a) *General*. The helicopter must possess positive static longitudinal control force stability at critical combinations of weight and centre of gravity at the conditions specified in subparagraphs IV (b) to (f) of this appendix. The stick force must vary with speed so that any substantial speed change results in a stick force clearly perceptible to the pilot. The airspeed must return to within 10% of the trim speed when the control force is slowly released for each trim condition specified in subparagraphs IV (b) to (f) of this appendix.
- (b) *Climb*. Stability must be shown in climb throughout the speed range 37 km/h (20 knots) either side of trim with:
- (1) The helicopter trimmed at V_{Y1} ;
 - (2) Landing gear retracted (if retractable); and
 - (3) Power required for limit climb rate (at least 5.1 m/s (1000 fpm)) at V_{Y1} or maximum continuous power, whichever is less.
- (c) *Cruise*. Stability must be shown throughout the speed range from 0.7 to 1.1 V_H or V_{NE1} , whichever is lower, not to exceed ± 37 km/h (± 20 knots) from trim with:
- (1) The helicopter trimmed and power adjusted for level flight at 0.9 V_H or 0.9 V_{NE1} , whichever is lower; and
 - (2) Landing gear retracted (if retractable).
- (d) *Slow cruise*. Stability must be shown throughout the speed range from 0.9 V_{MIN1} to 1.3 V_{MIN1} or 37 km/h (20 knots) above trim speed, whichever is greater, with:
- (1) The helicopter trimmed and power adjusted for level flight at 1.1 V_{MIN1} ; and
 - (2) Landing gear retracted (if retractable).
- (e) *Descent*. Stability must be shown throughout the speed range 37 km/h (20 knots) either side of trim with:
- (1) The helicopter trimmed at 0.8 V_H or 0.8 V_{NE1} (or 0.8 V_{LE} for the landing gear extended case), whichever is lower;
 - (2) Power required for 5.1 m/s (1000 fpm) descent at trim speed; and
 - (3) Landing gear extended and retracted, if applicable.
- (f) *Approach*. Stability must be shown throughout the speed range from 0.7 times the minimum recommended approach speed to 37 km/h (20 knots) above the maximum recommended approach speed with:
- (1) The helicopter trimmed at the recommended approach speed or speeds;
 - (2) Landing gear extended and retracted, if applicable; and
 - (3) Power required to maintain a 3° glide path and power required to maintain the steepest approach gradient for which approval is requested.
- V. *Static lateral-directional stability*
- (a) Static directional stability must be positive throughout the approved ranges of airspeed, power, and vertical speed. In straight and steady sideslips up to $\pm 10^\circ$ from trim, directional control position must increase without discontinuity with the angle of sideslip, except for a small range of sideslip angles around trim. At greater angles up to the

maximum sideslip angle appropriate to the type, increased directional control position must produce increased angle of sideslip. It must be possible to maintain balanced flight without exceptional pilot skill or alertness.

- (b) During sideslips up to $\pm 10^\circ$ from trim throughout the approved ranges of airspeed, power, and vertical speed there must be no negative dihedral stability perceptible to the pilot through lateral control motion or force. Longitudinal cyclic movement with sideslip must not be excessive.

VI. *Dynamic stability*

- (a) Any oscillation having a period of less than 5 seconds must damp to $\frac{1}{2}$ amplitude in not more than one cycle.
- (b) Any oscillation having a period of 5 seconds or more but less than 10 seconds must damp to $\frac{1}{2}$ amplitude in not more than two cycles.
- (c) Any oscillation having a period of 10 seconds or more but less than 20 seconds must be damped.
- (d) Any oscillation having a period of 20 seconds or more may not achieve double amplitude in less than 20 seconds.
- (e) Any aperiodic response may not achieve double amplitude in less than 9 seconds.

VII. *Stability augmentation system (SAS)*

- (a) If a SAS is used, the reliability of the SAS must be related to the effects of its failure. Any SAS failure condition that would prevent continued safe flight and landing must be extremely improbable. It must be shown that, for any failure condition of the SAS that is not shown to be extremely improbable:
 - (1) The helicopter is safely controllable when the failure or malfunction occurs at any speed or altitude within the approved IFR operating limitations; and
 - (2) The overall flight characteristics of the helicopter allow for prolonged instrument flight without undue pilot effort. Additional unrelated probable failures affecting the control system must be considered. In addition:
 - (i) The controllability and manoeuvrability requirements in Subpart B of CS-29 must be met throughout a practical flight envelope;
 - (ii) The flight control, trim, and dynamic stability characteristics must not be impaired below a level needed to allow continued safe flight and landing;
 - (iii) For Category A helicopters, the dynamic stability requirements of Subpart B of CS-29 must also be met throughout a practical flight envelope; and
 - (iv) The static longitudinal and static directional stability requirements of Subpart B of CS-29 must be met throughout a practical flight envelope.
- (b) The SAS must be designed so that it cannot create a hazardous deviation in flight path or produce hazardous loads on the helicopter during normal operation or in the event of malfunction or failure, assuming corrective action begins within an appropriate period of time. Where multiple systems are installed, subsequent malfunction conditions must be considered in sequence unless their occurrence is shown to be improbable.

VIII. *Equipment, systems, and installation.* The basic equipment and installation must comply with Subpart F of CS-29 with the following exceptions and additions:

(a) *Flight and navigation instruments*

- (1) A magnetic gyro-stabilised direction indicator instead of the gyroscopic direction indicator required by [CS 29.1303\(h\)](#); and
- (2) A standby attitude indicator which meets the requirements of [CS 29.1303\(g\)\(1\) to \(7\)](#), instead of a rate-of-turn indicator required by [CS 29.1303\(g\)](#). If standby batteries are provided, they may be charged from the aircraft electrical system if adequate isolation is incorporated. The system must be designed so that the standby batteries may not be used for engine starting.

(b) *Miscellaneous requirements*

- (1) Instrument systems and other systems essential for IFR flight that could be adversely affected by icing must be provided with adequate ice protection whether or not the rotorcraft is certificated for operation in icing conditions.
- (2) There must be means in the generating system to automatically de-energise and disconnect from the main bus any power source developing hazardous overvoltage.
- (3) Each required flight instrument using a power supply (electric, vacuum etc.) must have a visual means integral with the instrument to indicate the adequacy of the power being supplied.
- (4) When multiple systems performing like functions are required, each system must be grouped, routed, and spaced so that physical separation between systems is provided to ensure that a single malfunction will not adversely affect more than one system.
- (5) For systems that operate the required flight instruments at each pilot's station:
 - (i) Only the required flight instruments for the first pilot may be connected to that operating system;
 - (ii) Additional instruments, systems, or equipment may not be connected to an operating system for a second pilot unless provisions are made to ensure the continued normal functioning of the required instruments in the event of any malfunction of the additional instruments, systems, or equipment which is not shown to be extremely improbable;
 - (iii) The equipment, systems, and installations must be designed so that one display of the information essential to the safety of flight which is provided by the instruments will remain available to a pilot, without additional crew member action, after any single failure or combination of failures that is not shown to be extremely improbable; and
 - (iv) For single-pilot configurations, instruments which require a static source must be provided with a means of selecting an alternate source and that source must be calibrated.
- (6) In determining compliance with the requirements of [CS 29.1351\(d\)\(2\)](#), the supply of electrical power to all systems necessary for flight under IFR must be included in the evaluation.

- (c) *Thunderstorm lights.* In addition to the instrument lights required by [CS 29.1381\(a\)](#), thunderstorm lights which provide high intensity white flood lighting to the basic flight instruments must be provided. The thunderstorm lights must be installed to meet the requirements of [CS 29.1381\(b\)](#).
- IX. *Rotorcraft flight manual.* A rotorcraft flight manual or rotorcraft flight manual IFR Supplement must be provided and must contain –
- (a) *Limitations.* The approved IFR flight envelope, the IFR flightcrew composition, the revised kinds of operation, and the steepest IFR precision approach gradient for which the helicopter is approved;
- (b) *Procedures.* Required information for proper operation of IFR systems and the recommended procedures in the event of stability augmentation or electrical system failures; and
- (c) *Performance.* If V_{YI} differs from V_Y , climb performance at V_{YI} and with maximum continuous power throughout the ranges of weight, altitude, and temperature for which approval is requested.

[Amdt. No.: 29/1]

CS 29.143 Controllability and manoeuvrability

ED Decision 2008/010/R

- (a) The rotorcraft must be safely controllable and manoeuvrable:
- (1) During steady flight; and
 - (2) During any manoeuvre appropriate to the type, including:
 - (i) Take-off,
 - (ii) Climb;
 - (iii) Level flight;
 - (iv) Turning flight;
 - (v) Autorotation; and
 - (vi) Landing (power on and power off).
- (b) The margin of cyclic control must allow satisfactory roll and pitch control a V_{NE} with:
- (1) Critical weight;
 - (2) Critical centre of gravity;
 - (3) Critical rotor rpm; and
 - (4) Power off (except for helicopters demonstrating compliance with sub-paragraph (f) and power on).
- (c) Wind velocities from zero to at least 31 km/h (17 knots), from all azimuths, must be established in which the rotorcraft can be operated without loss of control on or near the ground in any manoeuvre appropriate to the type (such as crosswind take-offs, sideward flight, and rearward flight), with:
- (1) Critical weight;
 - (2) Critical centre of gravity;

- (3) Critical rotor rpm; and
 - (4) Altitude from standard sea-level conditions to the maximum take-off and landing altitude capability of the rotorcraft.
- (d) Wind velocities from zero to at least 31 km/h (17 knots), from all azimuths, must be established in which the rotorcraft can be operated without loss of control out-of-ground effect, with:
- (1) Weight selected by the applicant;
 - (2) Critical center of gravity;
 - (3) Rotor rpm selected by the applicant; and
 - (4) Altitude, from standard sea-level conditions to the maximum take-off and landing altitude capability of the rotorcraft.
- (e) The rotorcraft, after failure of one engine, in the case of multi-engine rotorcraft that meet Category A engine isolation requirements, or complete power failure in the case of other rotorcraft, must be controllable over the range of speeds and altitudes for which certification is requested when such power failure occurs with maximum continuous power and critical weight. No corrective action time delay for any condition following power failure may be less than:
- (1) For the cruise condition, one second, or normal pilot reaction time (whichever is greater); and
 - (2) For any other condition, normal pilot reaction time.
- (f) For helicopters for which a V_{NE} (power-off) is established under [CS 29.1505\(c\)](#), compliance must be demonstrated with the following requirements with critical weight, critical centre of gravity, and critical rotor rpm:
- (1) The helicopter must be safely slowed to V_{NE} (power-off), without exceptional pilot skill after the last operating engine is made inoperative at power-on V_{NE} .
 - (2) At a speed of $1.1 V_{NE}$ (power-off), the margin of cyclic control must allow satisfactory roll and pitch control with power off.

[Amdt. No.: 29/1]

[Amdt. No. 29/2]

CS 29.151 Flight controls

ED Decision 2003/16/RM

- (a) Longitudinal, lateral, directional, and collective controls may not exhibit excessive breakout force, friction, or preload.
- (b) Control system forces and free play may not inhibit a smooth, direct rotorcraft response to control system input.

CS 29.161 Trim control

ED Decision 2003/16/RM

The trim control:

- (a) Must trim any steady longitudinal, lateral, and collective control forces to zero in level flight at any appropriate speed; and
- (b) May not introduce any undesirable discontinuities in control force gradients.

CS 29.171 Stability: general

ED Decision 2003/16/RM

The rotorcraft must be able to be flown, without undue pilot fatigue or strain, in any normal manoeuvre for a period of time as long as that expected in normal operation. At least three landings and take-offs must be made during this demonstration.

CS 29.173 Static longitudinal stability

ED Decision 2007/014/R

- (a) The longitudinal control must be designed so that a rearward movement of the control is necessary to obtain an airspeed less than the trim speed, and a forward movement of the control is necessary to obtain an airspeed more than the trim speed.
- (b) Throughout the full range of altitude for which certification is requested, with the throttle and collective pitch held constant during the manoeuvres specified in [CS 29.175\(a\) through \(d\)](#), the slope of the control position versus airspeed curve must be positive. However, in limited flight conditions or modes of operation determined by the Agency to be acceptable, the slope of the control position versus airspeed curve may be neutral or negative if the rotorcraft possesses flight characteristics that allow the pilot to maintain airspeed within ± 9 km/h (± 5 knots) of the desired trim airspeed without exceptional piloting skill or alertness.

[Amdt. No.: 29/1]

CS 29.175 Demonstration of static longitudinal stability

ED Decision 2007/014/R

- (a) *Climb*. Static longitudinal stability must be shown in the climb condition at speeds from $V_Y - 19$ km/h (10 knots) to $V_Y + 19$ km/h (10 knots), with:
 - (1) Critical weight;
 - (2) Critical centre of gravity;
 - (3) Maximum continuous power;
 - (4) The landing gear retracted; and
 - (5) The rotorcraft trimmed at V_Y .
- (b) *Cruise*. Static longitudinal stability must be shown in the cruise condition at speeds from $0.8 V_{NE} - 19$ km/h (10 knots) to $0.8 V_{NE} + 19$ km/h (10 knots) or, if V_H is less than $0.8 V_{NE}$, from $0.8 V_{NE} - 19$ km/h (10 knots) to $0.8 V_{NE} + 19$ km/h (10 knots), with:
 - (1) Critical weight;
 - (2) Critical centre of gravity;
 - (3) Power for level flight at $0.8 V_{NE}$ or V_H , whichever is less;
 - (4) The landing gear retracted; and
 - (5) The rotorcraft trimmed at $0.8 V_{NE}$ or V_H , whichever is less.
- (c) V_{NE} . Static longitudinal stability must be shown at speeds from $V_{NE} - 37$ km/h (20 knots) to V_{NE} with:
 - (1) Critical weight;
 - (2) Critical center of gravity;

- (3) Power required for level flight at $V_{NE} - 19$ km/h (10 knots) or maximum continuous power, whichever is less;
 - (4) The landing gear retracted; and
 - (5) The rotorcraft trimmed at $V_{NE} - 19$ km/h (10 knots).
- (d) *Autorotation*. Static longitudinal stability must be shown in autorotation at:
- (1) Airspeeds from the minimum rate of descent airspeed $- 19$ km/h (10 knots) to the minimum rate of descent airspeed $+ 19$ km/h (10 knots), with:
 - (i) Critical weight;
 - (ii) Critical center of gravity;
 - (iii) The landing gear extended; and
 - (iv) The rotorcraft trimmed at the minimum rate of descent airspeed.
 - (2) Airspeeds from the best angle-of-glide airspeed $- 19$ km/h (10 knots) to the best angle-of-glide airspeed $+ 19$ km/h (10 knots), with:
 - (i) Critical weight;
 - (ii) Critical center of gravity;
 - (iii) The landing gear retracted; and
 - (iv) The rotorcraft trimmed at the best angle-of-glide airspeed.

[Amdt. No.: 29/1]

CS 29.177 Static directional stability

ED Decision 2007/014/R

- (a) The directional controls must operate in such a manner that the sense and direction of motion of the rotorcraft following control displacement are in the direction of the pedal motion with throttle and collective controls held constant at the trim conditions specified in [CS 29.175\(a\)](#), [\(b\)](#), [\(c\)](#) and [\(d\)](#). Sideslip angles must increase with steadily increasing directional control deflection for sideslip angles up to the lesser of:
 - (1) ± 25 degrees from trim at a speed of 28 km/h (15 knots) less than the speed for minimum rate of descent varying linearly to ± 10 degrees from trim at V_{NE} ;
 - (2) The steady state sideslip angles established by [CS 29.351](#);
 - (3) A sideslip angle selected by the applicant which corresponds to a sideforce of at least 0.1g; or,
 - (4) The sideslip angle attained by maximum directional control input.
- (b) Sufficient cues must accompany the sideslip to alert the pilot when approaching sideslip limits.
- (c) During the manoeuvre specified in sub-paragraph (a) of this paragraph, the sideslip angle versus directional control position curve may have a negative slope within a small range of angles around trim, provided the desired heading can be maintained without exceptional piloting skill or alertness.

[Amdt. No.: 29/1]

CS 29.181 Dynamic stability: Category A rotorcraft

ED Decision 2003/16/RM

Any short period oscillation occurring at any speed from V_Y to V_{NE} must be positively damped with the primary flight controls free and in a fixed position.

GROUND AND WATER HANDLING CHARACTERISTICS

CS 29.231 General

ED Decision 2003/16/RM

The rotorcraft must have satisfactory ground and water handling characteristics, including freedom from uncontrollable tendencies in any condition expected in operation.

CS 29.235 Taxying condition

ED Decision 2003/16/RM

The rotorcraft must be designed to withstand the loads that would occur when the rotorcraft is taxied over the roughest ground that may reasonably be expected in normal operation.

CS 29.239 Spray characteristics

ED Decision 2003/16/RM

If certification for water operation is requested, no spray characteristics during taxying, take-off, or landing may obscure the vision of the pilot or damage the rotors, propellers, or other parts of the rotorcraft.

CS 29.241 Ground resonance

ED Decision 2003/16/RM

The rotorcraft may have no dangerous tendency to oscillate on the ground with the rotor turning.

MISCELLANEOUS FLIGHT REQUIREMENTS

CS 29.251 Vibration

ED Decision 2003/16/RM

Each part of the rotorcraft must be free from excessive vibration under each appropriate speed and power condition.

SUBPART C — STRENGTH REQUIREMENTS

GENERAL

CS 29.301 Loads

ED Decision 2003/16/RM

- (a) Strength requirements are specified in terms of limit loads (the maximum loads to be expected in service) and ultimate loads (limit loads multiplied by prescribed factors of safety). Unless otherwise provided, prescribed loads are limit loads.
- (b) Unless otherwise provided, the specified air, ground, and water loads must be placed in equilibrium with inertia forces, considering each item of mass in the rotorcraft. These loads must be distributed to closely approximate or conservatively represent actual conditions.
- (c) If deflections under load would significantly change the distribution of external or internal loads, this redistribution must be taken into account.

CS 29.303 Factor of safety

ED Decision 2003/16/RM

Unless otherwise provided, a factor of safety of 1.5 must be used. This factor applies to external and inertia loads unless its application to the resulting internal stresses is more conservative.

CS 29.305 Strength and deformation

ED Decision 2003/16/RM

- (a) The structure must be able to support limit loads without detrimental or permanent deformation. At any load up to limit loads, the deformation may not interfere with safe operation.
- (b) The structure must be able to support ultimate loads without failure. This must be shown by:
 - (1) Applying ultimate loads to the structure in a static test for at least 3 seconds; or
 - (2) Dynamic tests simulating actual load application.

CS 29.307 Proof of structure

ED Decision 2003/16/RM

- (a) Compliance with the strength and deformation requirements of this Subpart must be shown for each critical loading condition accounting for the environment to which the structure will be exposed in operation. Structural analysis (static or fatigue) may be used only if the structure conforms to those for which experience has shown this method to be reliable. In other cases, substantiating load tests must be made.
- (b) Proof of compliance with the strength requirements of this Subpart must include:
 - (1) Dynamic and endurance tests of rotors, rotor drives, and rotor controls;
 - (2) Limit load tests of the control system, including control surfaces;
 - (3) Operation tests of the control system;

- (4) Flight stress measurement tests;
- (5) Landing gear drop tests; and
- (6) Any additional tests required for new or unusual design features.

CS 29.309 Design limitations

ED Decision 2003/16/RM

The following values and limitations must be established to show compliance with the structural requirements of this Subpart:

- (a) The design maximum and design minimum weights.
- (b) The main rotor rpm ranges, power on and power off.
- (c) The maximum forward speeds for each main rotor rpm within the ranges determined under sub-paragraph (b).
- (d) The maximum rearward and sideward flight speeds.
- (e) The centre of gravity limits corresponding to the limitations determined under sub-paragraphs (b), (c) and (d).
- (f) The rotational speed ratios between each powerplant and each connected rotating component.
- (g) The positive and negative limit manoeuvring load factors.

FLIGHT LOADS

CS 29.321 General

ED Decision 2003/16/RM

- (a) The flight load factor must be assumed to act normal to the longitudinal axis of the rotorcraft, and to be equal in magnitude and opposite in direction to the rotorcraft inertia load factor at the centre of gravity.
- (b) Compliance with the flight load requirements of this Subpart must be shown:
 - (1) At each weight from the design minimum weight to the design maximum weight; and
 - (2) With any practical distribution of disposable load within the operating limitations in the rotorcraft flight manual.

CS 29.337 Limit manoeuvring load factor

ED Decision 2003/16/RM

The rotorcraft must be designed for –

- (a) A limit manoeuvring load factor ranging from a positive limit of 3.5 to a negative limit of -1.0; or
- (b) Any positive limit manoeuvring load factor not less than 2.0 and any negative limit manoeuvring load factor of not less than -0.5 for which:
 - (1) The probability of being exceeded is shown by analysis and flight tests to be extremely remote; and
 - (2) The selected values are appropriate to each weight condition between the design maximum and design minimum weights.

CS 29.339 Resultant limit manoeuvring loads

ED Decision 2003/16/RM

The loads resulting from the application of limit manoeuvring load factors are assumed to act at the centre of each rotor hub and at each auxiliary lifting surface, and to act in directions and with distributions of load among the rotors and auxiliary lifting surfaces, so as to represent each critical manoeuvring condition, including power-on and power-off flight with the maximum design rotor tip speed ratio. The rotor tip speed ratio is the ratio of the rotorcraft flight velocity component in the plane of the rotor disc to the rotational tip speed of the rotor blades and is expressed as follows:

$$\mu = \frac{V \cos a}{\Omega R}$$

where:

- V = The airspeed along the flight path (m/s (fps));
- a = The angle between the projection, in the plane of symmetry, of the axis of no feathering and a line perpendicular to the flight path (radians, positive when axis is pointing aft);
- Ω = The angular velocity of rotor (radians per second); and
- R = The rotor radius (m (ft)).

CS 29.341 Gust loads

ED Decision 2003/16/RM

Each rotorcraft must be designed to withstand, at each critical airspeed including hovering, the loads resulting from vertical and horizontal gusts of 9.1 metres per second (30 ft/s).

CS 29.351 Yawing conditions

ED Decision 2003/16/RM

- (a) Each rotorcraft must be designed for the loads resulting from the manoeuvres specified in sub-paragraphs (b) and (c), with:
- (1) Unbalanced aerodynamic moments about the centre of gravity which the aircraft reacts to in a rational or conservative manner considering the principal masses furnishing the reacting inertia forces; and
 - (2) Maximum main rotor speed.
- (b) To produce the load required in sub-paragraph (a), in unaccelerated flight with zero yaw, at forward speeds from zero up to $0.6 V_{NE}$.
- (1) Displace the cockpit directional control suddenly to the maximum deflection limited by the control stops or by the maximum pilot force specified in [CS 29.397\(a\)](#);
 - (2) Attain a resulting sideslip angle or 90° , whichever is less; and
 - (3) Return the directional control suddenly to neutral.
- (c) To produce the load required in sub-paragraph (a), in unaccelerated flight with zero yaw, at forward speeds from $0.6 V_{NE}$ up to V_{NE} or V_H , whichever is less:
- (1) Displace the cockpit directional control suddenly to the maximum deflection limited by the control stops or by the maximum pilot force specified in [CS 29.397\(a\)](#);
 - (2) Attain a resulting sideslip angle or 15° , whichever is less, at the lesser speed of V_{NE} or V_H ;
 - (3) Vary the sideslip angles of sub-paragraphs (b)(2) and (c)(2) directly with speed; and
 - (4) Return the directional control suddenly to neutral.

AMC No 1 to CS 29.351 Yawing conditions

ED Decision 2016/025/R

- (a) Definitions
- (1) Suddenly. For the purpose of this AMC, 'suddenly' is defined as an interval not to exceed 0.2 seconds for a complete control input. A rational analysis may be used to substantiate an alternative value.
 - (2) Initial Trim Condition. Steady, 1G, level flight condition with zero bank angle or zero sideslip.
 - (3) 'Line'. The rotorcraft's sideslip envelope, defined by the rule, between 90° at $0.6V_{NE}$ and 15° at V_{NE} or V_H whichever is less (see Figure 1).
 - (4) Resulting Sideslip Angle. The rotorcraft's stabilised sideslip angle that results from a sustained maximum cockpit directional control deflection or as limited by pilot effort in the initial level flight power conditions.

- (b) Explanation. The rule requires a rotorcraft's 'structural' yaw or sideslip design envelope that must cover a minimum forward speed or hover to V_{NE} or V_H whichever is less. The scope of the rule is intended to cover structural components that are primarily designed for the critical combinations of tail rotor thrust, inertial and aerodynamic forces. This may include but is not limited to fuselage, tailboom and attachments, vertical control surfaces, tail rotor and tail rotor support structure.
- (1) The rotorcraft's structure must be designed to withstand the loads in the specified yawing conditions. The standard does not require a structural flight demonstration. It is a structural design standard.
 - (2) The standard applies only to power-on conditions. Autorotation need not be considered.
 - (3) This standard requires the maximum allowable rotor revolutions per minute (RPM) consistent with each flight condition for which certification is requested.
 - (4) For the purpose of this AMC, the analysis may be performed in international standard atmosphere (ISA) sea level conditions.
 - (5) Maximum displacement of the directional control, except as limited by pilot effort ([29.397\(a\)](#)), is required for the conditions cited in the rule. A control-system-limiting device may be used, however the probability of failure or malfunction of these system(s) should be considered (See [AMC No 2 to CS 29.351](#) Interaction of System and Structure).
 - (6) Both right and left yaw conditions should be evaluated.
 - (7) The airloads on the vertical stabilisers may be assumed independent of the tail rotor thrust.
 - (8) Loads associated with sideslip angles exceeding the values of the 'line', defined in Figure 1, do not need to be considered. The corresponding points of the manoeuvre may be deleted.
- (c) Procedure. The design loads should be evaluated within the limits of Figure 1 or the maximum yaw capability of the rotorcraft, whichever is less; at speeds from zero to V_H or V_{NE} , whichever is less, for the following phases of the manoeuvre (see Note 1):
- (1) With the rotorcraft at an initial trim condition, the cockpit directional control is suddenly displaced to the maximum deflection limited by the control stops or by the maximum pilot force specified in [29.397\(a\)](#). This is intended to generate a high tail rotor thrust.
 - (2) While maintaining maximum cockpit directional control deflection, within the limitation specified in (c)(1) of this AMC allow the rotorcraft to yaw to the maximum transient sideslip angle. This is intended to generate high aerodynamic loads that are determined based on the maximum transient sideslip angle or the value defined by the 'line' in Figure 1 whichever is less (see Note 1).
 - (3) Allow the rotorcraft to attain the resulting sideslip angle. In the event that the resulting sideslip angle is greater than the value defined by the 'line' in Figure 1, the rotorcraft should be trimmed to that value of the angle using less than maximum cockpit directional-control deflection by taking into consideration the manoeuvre's entry airspeed (see Note 2).
 - (4) With the rotorcraft yawed to the resulting sideslip angle specified in (c)(3) of this AMC the cockpit control is suddenly returned to its initial trim position. This is intended to combine a high tail rotor thrust and high aerodynamic restoring forces.

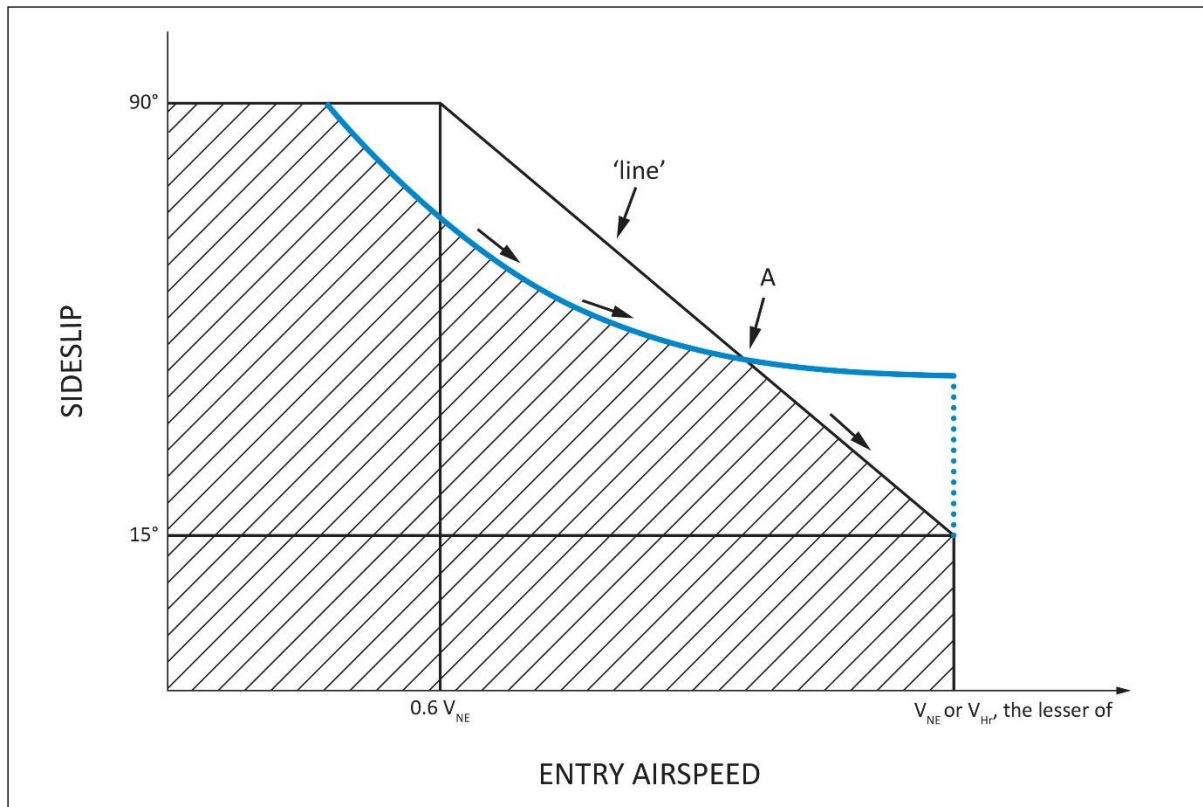


Figure 1 — YAW/FORWARD SPEED DIAGRAM

NOTE:

- (1) When comparing the rotorcraft's sideslip angle against the 'line' of Figure 1, the entry airspeed of the manoeuvre should be used.
 - (2) When evaluating the yawing condition against the 'line' of Figure 1, sufficient points should be investigated in order to determine the critical design conditions. This investigation should include the loads that result from the manoeuvre, specifically initiated at the intermediate airspeed which is coincident with the intersection of the 'line' and the resultant sideslip angle (point A in Figure 1).
- (d) Another method of compliance may be used with a rational analysis (dynamic simulation), acceptable to the Agency/Authority, performed up to V_H or V_{NE} whichever is less, to the maximum yaw capability of the rotorcraft with recovery initiated at the resulting sideslip angle at its associated airspeed. Loads should be considered for all portions of the manoeuvre.

[Amdt 29/4]

AMC No 2 to CS 29.351 Yaw manoeuvre conditions

ED Decision 2016/025/R

1. Introduction

This AMC provides further guidance and acceptable means of compliance to supplement FAA AC 29-2C § AC 29.351b. § 29.351 to meet the Agency's interpretation of [CS 29.351](#). As such it should be used in conjunction with the FAA AC but take precedence over it, where stipulated, in the showing of compliance.

Specifically, this AMC addresses two areas where the FAA AC has been deemed by the Agency as being unclear or at variance to the Agency's interpretation. These areas are as follows:

a. Aerodynamic Loads

The certification specification [CS 29.351](#) provides a minimum safety standard for the design of rotorcraft structural components that are subjected in flight to critical loads combinations of anti-torque system thrust (e.g. tail rotor), inertia and aerodynamics. A typical example of these structural components is the tailboom.

However, compliance with this standard according to FAA AC may not necessarily be adequate for the design of rotorcraft structural components that are principally subjected in flight to significant aerodynamic loads (e.g. vertical empennage, fins, cowlings and doors).

For these components and their supporting structure, suitable design criteria should be developed by the Applicant and agreed with the Agency.

In lieu of acceptable design criteria developed by the applicant, a suitable combination of sideslip angle and airspeed for the design of rotorcraft components subjected to aerodynamic loads may be obtained from a simulation of the yaw manoeuvre of [CS 29.351](#), starting from the initial directional control input specified in [CS 29.351\(b\)\(1\) and \(c\)\(1\)](#), until the rotorcraft reaches the maximum transient sideslip angle (overswing) resulting from its motion around the yaw axis.

b. Interaction of System and Structure

Maximum displacement of the directional control, except as limited by pilot effort ([CS 29.397\(a\)](#)), is required for the conditions cited in the certification specification. In the load evaluation credit may be taken for consideration of the effects of control system limiting devices.

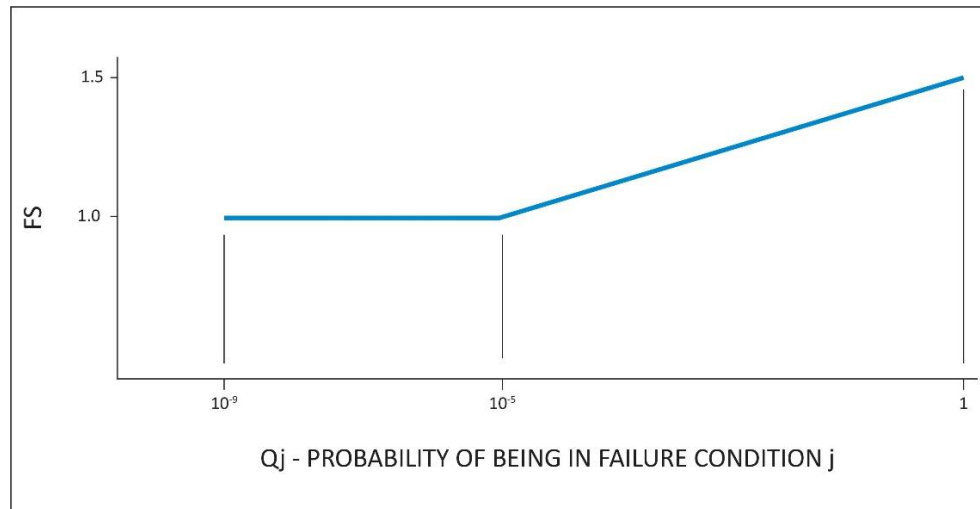
However, the probability of failure or malfunction of these system(s) should also be considered and if it is shown not to be extremely improbable then further load conditions with the system in the failed state should be evaluated. This evaluation may include Flight Manual Limitations, if failure of the system is reliably indicated to the crew.

A yaw limiting device is a typical example of a system whose failed condition should be investigated in the assessment of the loads requested by [CS 29.351](#).

An acceptable methodology to investigate the effects of all system failures not shown to be extremely improbable on the loading conditions of [CS 29.351](#) is as follows:

- (i) With the system in the failed state and considering any appropriate reconfiguration and flight limitations, it should be shown that the rotorcraft structure can withstand without failure the loading conditions of [CS 29.351](#), when the manoeuvre is performed in accordance with the provisions of the this AMC.

- (ii) The factor of safety to apply to the above specified loading conditions to comply with [CS 29.305](#) is defined in the figure below.



$$Q_j = (T_j)(P_j)$$

where:

T_j = Average flight time spent with a failed limiting system j (in hours)

P_j = Probability of occurrence of failure of control limiting system j (per hour)

Note: If P_j is greater than 1×10^{-3} per flight hour then a 1.5 factor of safety should be applied to all limit load conditions evaluated for the system failure under consideration.

[Amdt 29/2]

[Amdt 29/4]

CS 29.361 Engine torque

ED Decision 2003/16/RM

The limit engine torque may not be less than the following:

- (a) For turbine engines, the highest of:
- (1) The mean torque for maximum continuous power multiplied by 1.25;
 - (2) The torque required by [CS 29.923](#);
 - (3) The torque required by [CS 29.927](#); or
 - (4) The torque imposed by sudden engine stoppage due to malfunction or structural failure (such as compressor jamming).
- (b) For reciprocating engines, the mean torque for maximum continuous power multiplied by:
- (1) 1.33, for engines with five or more cylinders; and
 - (2) Two, three, and four, for engines with four, three, and two cylinders, respectively.

CONTROL SURFACE AND SYSTEM LOADS

CS 29.391 General

ED Decision 2003/16/RM

Each auxiliary rotor, each fixed or movable stabilising or control surface, and each system operating any flight control must meet the requirements of [CS 29.395](#) to [29.427](#).

CS 29.395 Control system

ED Decision 2003/16/RM

- (a) The reaction to the loads prescribed in [CS 29.397](#) must be provided by:
- (1) The control stops only;
 - (2) The control locks only;
 - (3) The irreversible mechanism only (with the mechanism locked and with the control surface in the critical positions for the effective parts of the system within its limit of motion);
 - (4) The attachment of the control system to the rotor blade pitch control horn only (with the control in the critical positions for the affected parts of the system within the limits of its motion); and
 - (5) The attachment of the control system to the control surface horn (with the control in the critical positions for the affected parts of the system within the limits of its motion).
- (b) Each primary control system, including its supporting structure, must be designed as follows:
- (1) The system must withstand loads resulting from the limit pilot forces prescribed in [CS 29.397](#);
 - (2) Notwithstanding sub-paragraph (b)(3), when power-operated actuator controls or power boost controls are used, the system must also withstand the loads resulting from the limit pilot forces prescribed in [CS 29.397](#) in conjunction with the forces output of each normally energised power device, including any single power boost or actuator system failure;
 - (3) If the system design or the normal operating loads are such that a part of the system cannot react to the limit pilot forces prescribed in [CS 29.397](#), that part of the system must be designed to withstand the maximum loads that can be obtained in normal operation. The minimum design loads must, in any case, provide a rugged system for service use, including consideration of fatigue, jamming, ground gusts, control inertia and friction loads. In the absence of a rational analysis, the design loads resulting from 0.60 of the specified limit pilot forces are acceptable minimum design loads; and
 - (4) If operational loads may be exceeded through jamming, ground gusts, control inertia, or friction, the system must withstand the limit pilot forces specified in [CS 29.397](#), without yielding.

CS 29.397 Limit pilot forces and torques

ED Decision 2003/16/RM

- (a) Except as provided in sub-paragraph (b), the limit pilot forces are as follows:
 - (1) For foot controls, 578 N (130 lbs).
 - (2) For stick controls, 445 N (100 lbs) fore and aft, and 298 N (67 lbs) laterally.
- (b) For flap, tab, stabiliser, rotor brake and landing gear operating controls, the following apply:
 - (1) Crank, wheel, and lever controls, $(25.4 + R) \times 2.919$ N, where R = radius in millimetres ($\left[\frac{1+R}{3}\right] \times 50$ lbs, where R = radius in inches), but not less than 222 N (50 lbs) nor more than 445 N (100 lbs) for hand-operated controls or 578 N (130 lbs) for foot-operated controls, applied at any angle within 20° of the plane of motion of the control.
 - (2) Twist controls, 356 x R Newton-millimetres, where R = radius in millimetres (80 x R inch-pounds where R = radius in inches).

CS 29.399 Dual control system

ED Decision 2003/16/RM

Each dual primary flight control system must be able to withstand the loads that result when pilot forces not less than 0.75 times those obtained under [CS 29.395](#) are applied:

- (a) In opposition; and
- (b) In the same direction.

CS 29.411 Ground clearance: tail rotor guard

ED Decision 2003/16/RM

- (a) It must be impossible for the tail rotor to contact the landing surface during a normal landing.
- (b) If a tail rotor guard is required to show compliance with sub-paragraph (a):
 - (1) Suitable design loads must be established for the guard; and
 - (2) The guard and its supporting structure must be designed to withstand those loads.

CS 29.427 Unsymmetrical loads

ED Decision 2003/16/RM

- (a) Horizontal tail surfaces and their supporting structure must be designed for unsymmetrical loads arising from yawing and rotor wake effects in combination with the prescribed flight conditions.
- (b) To meet the design criteria of sub-paragraph (a), in the absence of more rational data, both of the following must be met:
 - (1) 100% of the maximum loading from the symmetrical flight conditions acts on the surface on one side of the plane of symmetry, and no loading acts on the other side.
 - (2) 50% of the maximum loading from the symmetrical flight conditions acts on the surface on each side of the plane of symmetry, in opposite directions.

-
- (c) For empennage arrangements where the horizontal tail surfaces are supported by the vertical tail surfaces, the vertical tail surfaces and supporting structure must be designed for the combined vertical and horizontal surface loads resulting from each prescribed flight condition, considered separately. The flight conditions must be selected so that the maximum design loads are obtained on each surface. In the absence of more rational data, the unsymmetrical horizontal tail surface loading distributions described in this paragraph must be assumed.

GROUND LOADS

CS 29.471 General

ED Decision 2003/16/RM

- (a) *Loads and equilibrium.* For limit ground loads:
- (1) The limit ground loads obtained in the landing conditions in this CS-29 must be considered to be external loads that would occur in the rotorcraft structure if it were acting as a rigid body; and
 - (2) In each specified landing condition, the external loads must be placed in equilibrium with linear and angular inertia loads in a rational or conservative manner.
- (b) *Critical centres of gravity.* The critical centres of gravity within the range for which certification is requested must be selected so that the maximum design loads are obtained in each landing gear element.

CS 29.473 Ground loading conditions and assumptions

ED Decision 2003/16/RM

- (a) For specified landing conditions, a design maximum weight must be used that is not less than the maximum weight. A rotor lift may be assumed to act through the centre of gravity throughout the landing impact. This lift may not exceed two-thirds of the design maximum weight.
- (b) Unless otherwise prescribed, for each specified landing condition, the rotorcraft must be designed for a limit load factor of not less than the limit inertia load factor substantiated under [CS 29.725](#).
- (c) Triggering or actuating devices for additional or supplementary energy absorption may not fail under loads established in the tests prescribed in [CS 29.725](#) and [29.727](#), but the factor of safety prescribed in [CS 29.303](#) need not be used.

CS 29.475 Tyres and shock absorbers

ED Decision 2003/16/RM

Unless otherwise prescribed, for each specified landing condition, the tyres must be assumed to be in their static position and the shock absorbers to be in their most critical position.

CS 29.477 Landing gear arrangement

ED Decision 2003/16/RM

Paragraphs [CS 29.235](#), [29.479](#) to [29.485](#), and [29.493](#) apply to landing gear with two wheels aft, and one or more wheels forward, of the centre of gravity.

CS 29.479 Level landing conditions

ED Decision 2003/16/RM

- (a) *Attitudes.* Under each of the loading conditions prescribed in sub-paragraph (b), the rotorcraft is assumed to be in each of the following level landing attitudes:
- (1) An attitude in which each wheel contacts the ground simultaneously.

- (2) An attitude in which the aft wheels contact the ground with the forward wheels just clear of the ground.
- (b) *Loading conditions.* The rotorcraft must be designed for the following landing loading conditions:
 - (1) Vertical loads applied under [CS 29.471](#).
 - (2) The loads resulting from a combination of the loads applied under sub-paragraph (b)(1) with drag loads at each wheel of not less than 25% of the vertical load at that wheel.
 - (3) The vertical load at the instant of peak drag load combined with a drag component simulating the forces required to accelerate the wheel rolling assembly up to the specified ground speed, with:
 - (i) The ground speed for determination of the spin-up loads being at least 75% of the optimum forward flight speed for minimum rate of descent in autorotation; and
 - (ii) The loading conditions of sub-paragraph (b) applied to the landing gear and its attaching structure only.
 - (4) If there are two wheels forward, a distribution of the loads applied to those wheels under sub-paragraphs (b)(1) and (2) in a ratio of 40:60.
- (c) *Pitching moments.* Pitching moments are assumed to be resisted by:
 - (1) In the case of the attitude in sub-paragraph (a)(1), the forward landing gear; and
 - (2) In the case of the attitude in sub-paragraph (a)(2), the angular inertia forces.

CS 29.481 Tail-down landing conditions

ED Decision 2003/16/RM

- (a) The rotorcraft is assumed to be in the maximum nose-up attitude allowing ground clearance by each part of the rotorcraft.
- (b) In this attitude, ground loads are assumed to act perpendicular to the ground.

CS 29.483 One-wheel landing conditions

ED Decision 2003/16/RM

For the one-wheel landing condition, the rotorcraft is assumed to be in the level attitude and to contact the ground on one aft wheel. In this attitude:

- (a) The vertical load must be the same as that obtained on that side under [CS 29.479\(b\)\(1\)](#); and
- (b) The unbalanced external loads must be reacted by rotorcraft inertia.

CS 29.485 Lateral drift landing conditions

ED Decision 2003/16/RM

- (a) The rotorcraft is assumed to be in the level landing attitude, with:
 - (1) Side loads combined with one-half of the maximum ground reactions obtained in the level landing conditions of [CS 29.479\(b\)\(1\)](#); and
 - (2) The loads obtained under sub-paragraph (a)(1) applied:
 - (i) At the ground contact point; or

- (ii) For full-swivelling gear, at the centre of the axle.
- (b) The rotorcraft must be designed to withstand, at ground contact:
- (1) When only the aft wheels contact the ground, side loads of 0.8 times the vertical reaction acting inward on one side and 0.6 times the vertical reaction acting outward on the other side, all combined with the vertical loads specified in sub-paragraph (a); and
 - (2) When the wheels contact the ground simultaneously:
 - (i) For the aft wheels, the side loads specified in sub-paragraph (b)(1); and
 - (ii) For the forward wheels, a side load of 0.8 times the vertical reaction combined with the vertical load specified in sub-paragraph (a).

CS 29.493 Braked roll conditions

ED Decision 2003/16/RM

Under braked roll conditions with the shock absorbers in their static positions:

- (a) The limit vertical load must be based on a load factor of at least –
 - (1) 1.33, for the attitude specified in [CS 29.479\(a\)\(1\)](#); and
 - (2) 1.0, for the attitude specified in [CS 29.479\(a\)\(2\)](#); and
- (b) The structure must be designed to withstand, at the ground contact point of each wheel with brakes, a drag load of at least the lesser of:
 - (1) The vertical load multiplied by a coefficient of friction of 0.8; and
 - (2) The maximum value based on limiting brake torque.

CS 29.497 Ground loading conditions: landing gear with tail wheels

ED Decision 2003/16/RM

- (a) *General.* Rotorcraft with landing gear with two wheels forward and one wheel aft of the centre of gravity must be designed for loading conditions as prescribed in this paragraph..
- (b) *Level landing attitude with only the forward wheels contacting the ground.* In this attitude:
 - (1) The vertical loads must be applied under [CS 29.471](#) to [CS 29.475](#);
 - (2) The vertical load at each axle must be combined with a drag load at that axle of not less than 25% of that vertical load; and
 - (3) Unbalanced pitching moments are assumed to be resisted by angular inertia forces.
- (c) *Level landing attitude with all wheels contacting the ground simultaneously.* In this attitude, the rotorcraft must be designed for landing loading conditions as prescribed in sub-paragraph (b).
- (d) *Maximum nose-up attitude with only the rear wheel contacting the ground.* The attitude for this condition must be the maximum nose-up attitude expected in normal operation, including autorotative landings. In this attitude:
 - (1) The appropriate ground loads specified in sub-paragraphs (b)(1) and (2) must be determined and applied, using a rational method to account for the moment arm between the rear wheel ground reaction and the rotorcraft centre of gravity; or
 - (2) The probability of landing with initial contact on the rear wheel must be shown to be extremely remote.

-
- (e) *Level landing attitude with only one forward wheel contacting the ground.* In this attitude, the rotorcraft must be designed for ground loads as specified in sub-paragraphs (b)(1) and (3).
- (f) *Side loads in the level landing attitude.* In the attitudes specified in sub-paragraphs (b) and (c), the following apply:
- (1) The side loads must be combined at each wheel with one-half of the maximum vertical ground reactions obtained for that wheel under sub-paragraphs (b) and (c). In this condition, the side loads must be:
 - (i) For the forward wheels, 0.8 times the vertical reaction (on one side) acting inward and 0.6 times the vertical reaction (on the other side) acting outward; and
 - (ii) For the rear wheel, 0.8 times the vertical reaction.
 - (2) The loads specified in sub-paragraph (f)(1) must be applied:
 - (i) At the ground contact point with the wheel in the trailing position (for non-full swivelling landing gear or for full swivelling landing gear with a lock, steering device, or shimmy damper to keep the wheel in the trailing position); or
 - (ii) At the centre of the axle (for full swivelling landing gear without a lock, steering device, or shimmy damper).
- (g) *Braked roll conditions in the level landing attitude.* In the attitudes specified in sub-paragraphs (b) and (c), and with the shock absorbers in their static positions, the rotorcraft must be designed for braked roll loads as follows:
- (1) The limit vertical load must be based on a limit vertical load factor of not less than:
 - (i) 1.0, for the attitude specified in sub-paragraph (b); and
 - (ii) 1.33, for the attitude specified in sub-paragraph (c).
 - (2) For each wheel with brakes, a drag load must be applied, at the ground contact point, of not less than the lesser of:
 - (i) 0.8 times the vertical load; and
 - (ii) The maximum based on limiting brake torque.
- (h) *Rear wheel turning loads in the static ground attitude.* In the static ground attitude, and with the shock absorbers and tyres in their static positions, the rotorcraft must be designed for rear wheel turning loads as follows:
- (1) A vertical ground reaction equal to the static load on the rear wheel must be combined with an equal side load.
 - (2) The load specified in sub-paragraph (h)(1) must be applied to the rear landing gear:
 - (i) Through the axle, if there is a swivel (the rear wheel being assumed to be swivelled 90°, to the longitudinal axis of the rotorcraft); or
 - (ii) At the ground contact point if there is a lock, steering device or shimmy damper (the rear wheel being assumed to be in the trailing position).
- (i) *Taxying condition.* The rotorcraft and its landing gear must be designed for the loads that would occur when the rotorcraft is taxied over the roughest ground that may reasonably be expected in normal operation.

CS 29.501 Ground loading conditions: landing gear with skids

ED Decision 2003/16/RM

- (a) *General.* Rotorcraft with landing gear with skids must be designed for the loading conditions specified in this paragraph. In showing compliance with this paragraph, the following apply:
- (1) The design maximum weight, centre of gravity, and load factor must be determined under [CS 29.471](#) to [29.475](#).
 - (2) Structural yielding of elastic spring members under limit loads is acceptable.
 - (3) Design ultimate loads for elastic spring members need not exceed those obtained in a drop test of the gear with:
 - (i) A drop height of 1.5 times that specified in [CS 29.725](#); and
 - (ii) An assumed rotor lift of not more than 1.5 times that used in the limit drop tests prescribed in [CS 29.725](#).
 - (4) Compliance with sub-paragraphs (b) to (e) must be shown with:
 - (i) The gear in its most critically deflected position for the landing condition being considered; and
 - (ii) The ground reactions rationally distributed along the bottom of the skid tube.
- (b) *Vertical reactions in the level landing attitude.* In the level attitude, and with the rotorcraft contacting the ground along the bottom of both skids, the vertical reactions must be applied as prescribed in sub-paragraph (a).
- (c) *Drag reactions in the level landing attitude.* In the level attitude, and with the rotorcraft contacting the ground along the bottom of both skids, the following apply:
- (1) The vertical reactions must be combined with horizontal drag reactions of 50% of the vertical reaction applied at the ground.
 - (2) The resultant ground loads must equal the vertical load specified in sub-paragraph (b).
- (d) *Sideloads in the level landing attitude.* In the level attitude, and with the rotorcraft contacting the ground along the bottom of both skids, the following apply:
- (1) The vertical ground reaction must be:
 - (i) Equal to the vertical loads obtained in the condition specified in sub-paragraph (b); and
 - (ii) Divided equally among the skids.
 - (2) The vertical ground reactions must be combined with a horizontal sideload of 25% of their value.
 - (3) The total sideload must be applied equally between skids and along the length of the skids.
 - (4) The unbalanced moments are assumed to be resisted by angular inertia.
 - (5) The skid gear must be investigated for:
 - (i) Inward acting sideloads; and
 - (ii) Outward acting sideloads.

- (e) *One-skid landing loads in the level attitude.* In the level attitude, and with the rotorcraft contacting the ground along the bottom of one skid only, the following apply:
- (1) The vertical load on the ground contact side must be the same as that obtained on that side in the condition specified in sub-paragraph (b).
 - (2) The unbalanced moments are assumed to be resisted by angular inertia.
- (f) *Special conditions.* In addition to the specified in sub-paragraphs (b) and (c), the rotorcraft must be designed for the following ground reactions:
- (1) A ground reaction load acting up and aft at an angle of 45° , to the longitudinal axis of the rotorcraft. This load must be:
 - (i) Equal to 1.33 times the maximum weight;
 - (ii) Distributed symmetrically among the skids;
 - (iii) Concentrated at the forward end of the straight part of the skid tube; and
 - (iv) Applied only to the forward end of the skid tube and its attachment to the rotorcraft.
 - (2) With the rotorcraft in the level landing attitude, a vertical ground reaction load equal to one-half of the vertical load determined under sub-paragraph (b). This load must be:
 - (i) Applied only to the skid tube and its attachment to the rotorcraft; and
 - (ii) Distributed equally over 33.3% of the length between the skid tube attachments and centrally located midway between the skid tube attachments.

CS 29.505 Ski landing conditions

ED Decision 2003/16/RM

If certification for ski operation is requested, the rotorcraft, with skis, must be designed to withstand the following loading conditions (where P is the maximum static weight on each ski with the rotorcraft at design maximum weight, and n is the limit load factor determined under [CS 29.473\(b\)](#)):

- (a) Up-load conditions in which:
- (1) A vertical load of Pn and a horizontal load of $Pn/4$ are simultaneously applied at the pedestal bearings; and
 - (2) A vertical load of $1.33 P$ is applied at the pedestal bearings.
- (b) A side load condition in which a side load of $0.35 Pn$ is applied at the pedestal bearings in a horizontal plane perpendicular to the centreline of the rotorcraft.
- (c) A torque-load condition in which a torque load of $1.33 P$ (in foot-pounds) is applied to the ski about the vertical axis through the centreline of the pedestal bearings.

CS 29.511 Ground load: unsymmetrical loads on multiple-wheel units

ED Decision 2003/16/RM

- (a) In dual-wheel gear units, 60% of the total ground reaction for the gear unit must be applied to one wheel and 40% to the other.
- (b) To provide for the case of one deflated tyre, 60% of the specified load for the gear unit must be applied to either wheel, except that the vertical ground reaction may not be less than the full static value.
- (c) In determining the total load on a gear unit, the transverse shift in the load centroid, due to unsymmetrical load distribution on the wheels, may be neglected.

WATER LOADS

CS 29.519 Hull type rotorcraft: Water-based and amphibian

ED Decision 2003/16/RM

- (a) *General.* For hull type rotorcraft, the structure must be designed to withstand the water loading set forth in sub-paragraphs (b), (c), and (d) considering the most severe wave heights and profiles for which approval is desired. The loads for the landing conditions of sub-paragraphs (b) and (c) must be developed and distributed along and among the hull and auxiliary floats, if used, in a rational and conservative manner, assuming a rotor lift not exceeding two-thirds of the rotorcraft weight to act throughout the landing impact.
- (b) *Vertical landing conditions.* The rotorcraft must initially contact the most critical wave surface at zero forward speed in likely pitch and roll attitudes which result in critical design loadings. The vertical descent velocity may not be less than 1.98 metres per second (6.5 ft/s) relative to the mean water surface.
- (c) *Forward speed landing conditions.* The rotorcraft must contact the most critical wave at forward velocities from zero up to 56 km/h (30 knots) in likely pitch, roll, and yaw attitudes and with a vertical descent velocity of not less than 1.98 metres per second (6.5 ft/s) relative to the mean water surface. A maximum forward velocity of less than 56 km/h (30 knots) may be used in design if it can be demonstrated that the forward velocity selected would not be exceeded in a normal one-engine-out landing.
- (d) *Auxiliary float immersion condition.* In addition to the loads from the landing conditions, the auxiliary float, and its support and attaching structure in the hull, must be designed for the load developed by a fully immersed float unless it can be shown that full immersion of the float is unlikely, in which case the highest likely float buoyancy load must be applied that considers loading of the float immersed to create restoring moments compensating for upsetting moments caused by side wind, asymmetrical rotorcraft loading, water wave action and rotorcraft inertia.

CS 29.521 Float landing conditions

ED Decision 2003/16/RM

If certification for float operation (including float amphibian operation) is requested, the rotorcraft, with floats, must be designed to withstand the following loading conditions (where the limit load factor is determined under [CS 29.473\(b\)](#) or assumed to be equal to that determined for wheel landing gear):

- (a) Up-load conditions in which:
 - (1) A load is applied so that, with the rotorcraft in the static level attitude, the resultant water reaction passes vertically through the centre of gravity; and
 - (2) The vertical load prescribed in sub-paragraph (a)(1) is applied simultaneously with an aft component of 0.25 times the vertical component.

- (b) A side load condition in which:
- (1) A vertical load of 0.75 times the total vertical load specified in sub-paragraph (a)(1) is divided equally among the floats; and
 - (2) For each float, the load share determined under sub-paragraph (b)(1), combined with a total side load of 0.25 times the total vertical load specified in sub-paragraph (b)(1), is applied to that float only.

MAIN COMPONENT REQUIREMENTS

CS 29.547 Main and tail rotor structure

ED Decision 2003/16/RM

- (a) A rotor is an assembly of rotating components, which includes the rotor hub, blades, blade dampers, the pitch control mechanisms, and all other parts that rotate with the assembly.
- (b) Each rotor assembly must be designed as prescribed in this paragraph and must function safely for the critical flight load and operating conditions. A design assessment must be performed, including a detailed failure analysis to identify all failures that will prevent continued safe flight or safe landing, and must identify the means to minimise the likelihood of their occurrence.
- (c) The rotor structure must be designed to withstand the following loads prescribed in [CS 29.337](#) to [29.341](#), and [CS 29.351](#):
 - (1) Critical flight loads.
 - (2) Limit loads occurring under normal conditions of autorotation.
- (d) The rotor structure must be designed to withstand loads simulating:
 - (1) For the rotor blades, hubs and flapping hinges, the impact force of each blade against its stop during ground operation; and
 - (2) Any other critical condition expected in normal operation.
- (e) The rotor structure must be designed to withstand the limit torque at any rotational speed, including zero. In addition:
 - (1) The limit torque need not be greater than the torque defined by a torque limiting device (where provided), and may not be less than the greater of:
 - (i) The maximum torque likely to be transmitted to the rotor structure, in either direction, by the rotor drive or by sudden application of the rotor brake; and
 - (ii) For the main rotor, the limit engine torque specified in [CS 29.361](#).
 - (2) The limit torque must be equally and rationally distributed to the rotor blades.

AMC 29.547 Main rotor and tail rotor structure

ED Decision 2012/022/R

Where Vibration Health Monitoring is used as a compensating provision to meet [CS 29.547\(b\)](#), the design and performance of the vibration health monitoring system should be approved by requesting compliance with [CS 29.1465\(a\)](#).

[Amdt 29/3]

CS 29.549 Fuselage and rotor pylon structures

ED Decision 2003/16/RM

- (a) Each fuselage and rotor pylon structure must be designed to withstand:
- (1) The critical loads prescribed in [CS 29.337](#) to [29.341](#), and [CS 29.351](#);
 - (2) The applicable ground loads prescribed in [CS 29.235](#), [29.471](#) to [29.485](#), [CS 29.493](#), [29.497](#), [29.505](#), and [29.521](#); and
 - (3) The loads prescribed in [CS 29.547\(d\)\(1\)](#) and [\(e\)\(1\)\(i\)](#).
- (b) Auxiliary rotor thrust, the torque reaction of each rotor drive system, and the balancing air and inertia loads occurring under accelerated flight conditions, must be considered.
- (c) Each engine mount and adjacent fuselage structure must be designed to withstand the loads occurring under accelerated flight and landing conditions, including engine torque.
- (d) Reserved.
- (e) If approval for the use of 2½-minute OEI power is requested, each engine mount and adjacent structure must be designed to withstand the loads resulting from a limit torque equal to 1.25 times the mean torque for 2½-minute power OEI combined with 1g flight loads.

CS 29.551 Auxiliary lifting surfaces

ED Decision 2003/16/RM

Each auxiliary lifting surface must be designed to withstand:

- (a) The critical flight loads in [CS 29.337](#) to [29.341](#), and [CS 29.351](#);
- (b) The applicable ground loads in [CS 29.235](#), [29.471](#) to [29.485](#), [CS 29.493](#), [29.505](#), and [29.521](#); and
- (c) Any other critical condition expected in normal operation.

EMERGENCY LANDING CONDITIONS

CS 29.561 General

ED Decision 2003/16/RM

- (a) The rotorcraft, although it may be damaged in emergency landing conditions on land or water, must be designed as prescribed in this paragraph to protect the occupants under those conditions.
- (b) The structure must be designed to give each occupant every reasonable chance of escaping serious injury in a crash landing when:
- (1) Proper use is made of seats, belts, and other safety design provisions;
 - (2) The wheels are retracted (where applicable); and
 - (3) Each occupant and each item of mass inside the cabin that could injure an occupant is restrained when subjected to the following ultimate inertial load factors relative to the surrounding structure:
 - (i) Upward – 4 g
 - (ii) Forward – 16 g
 - (iii) Sideward – 8 g
 - (iv) Downward – 20 g, after the intended displacement of the seat device
 - (v) Rearward – 1.5 g.
- (c) The supporting structure must be designed to restrain under any ultimate inertial load factor up to those specified in this paragraph, any item of mass above and/or behind the crew and passenger compartment that could injure an occupant if it came loose in an emergency landing. Items of mass to be considered include, but are not limited to, rotors, transmission and engines. The items of mass must be restrained for the following ultimate inertial load factors:
- (1) Upward – 1.5 g
 - (2) Forward – 12 g
 - (3) Sideward – 6 g
 - (4) Downward – 12 g
 - (5) Rearward – 1.5 g.
- (d) Any fuselage structure in the area of internal fuel tanks below the passenger floor level must be designed to resist the following ultimate inertia factors and loads, and to protect the fuel tanks from rupture, if rupture is likely when those loads are applied to that area:
- (1) Upward – 1.5 g
 - (2) Forward – 4.0 g
 - (3) Sideward – 2.0 g
 - (4) Downward – 4.0 g

CS 29.562 Emergency landing dynamic conditions

ED Decision 2003/16/RM

- (a) The rotorcraft, although it may be damaged in a crash landing, must be designed to reasonably protect each occupant when:
- (1) The occupant properly uses the seats, safety belts, and shoulder harnesses provided in the design; and
 - (2) The occupant is exposed to loads equivalent to those resulting from the conditions prescribed in this paragraph.
- (b) Each seat type design or other seating device approved for crew or passenger occupancy during take-off and landing must successfully complete dynamic tests or be demonstrated by rational analysis based on dynamic tests of a similar type seat in accordance with the following criteria. The tests must be conducted with an occupant simulated by a 77 kg (170-pound) anthropomorphic test dummy (ATD), sitting in the normal upright position.
- (1) A change in downward velocity of not less than 9.1 metres per second (30 ft/s) when the seat or other seating device is oriented in its nominal position with respect to the rotorcraft's reference system, the rotorcraft's longitudinal axis is canted upward 60°, with respect to the impact velocity vector, and the rotorcraft's lateral axis is perpendicular to a vertical plane containing the impact velocity vector and the rotorcraft's longitudinal axis. Peak floor deceleration must occur in not more than 0.031 seconds after impact and must reach a minimum of 30 g.
 - (2) A change in forward velocity of not less than 12.8 metres per second (42 ft/s) when the seat or other seating device is oriented in its nominal position with respect to the rotorcraft's reference system, the rotorcraft's longitudinal axis is yawed 10°, either right or left of the impact velocity vector (whichever would cause the greatest load on the shoulder harness), the rotorcraft's lateral axis is contained in a horizontal plane containing the impact velocity vector, and the rotorcraft's vertical axis is perpendicular to a horizontal plane containing the impact velocity vector. Peak floor deceleration must occur in not more than 0.071 seconds after impact and must reach a minimum of 18.4 g.
 - (3) Where floor rails or floor or sidewall attachment devices are used to attach the seating devices to the airframe structure for the conditions of this paragraph, the rails or devices must be misaligned with respect to each other by at least 10° vertically (i.e. pitch out of parallel) and by at least a 10° lateral roll, with the directions optional, to account for possible floor warp.
- (c) Compliance with the following must be shown:
- (1) The seating device system must remain intact although it may experience separation intended as part of its design.
 - (2) The attachment between the seating device and the airframe structure must remain intact, although the structure may have exceeded its limit load.
 - (3) The ATD's shoulder harness strap or straps must remain on or in the immediate vicinity of the ATD's shoulder during the impact.
 - (4) The safety belt must remain on the ATD's pelvis during the impact.

- (5) The ATD's head either does not contact any portion of the crew or passenger compartment, or if contact is made, the head impact does not exceed a head injury criteria (HIC) of 1000 as determined by this equation.

$$HIC = (t_2 - t_1) \left[\frac{1}{(t_2 - t_1)} \int_{t_1}^{t_2} a(t) dt \right]^{2.5}$$

Where – a(t) is the resultant acceleration at the centre of gravity of the head form expressed as a multiple of g (the acceleration of gravity) and t_2-t_1 is the time duration, in seconds, of major head impact, not to exceed 0.05 seconds.

- (6) Loads in individual shoulder harness straps must not exceed 7784 N (1750 lbs). If dual straps are used for retaining the upper torso, the total harness strap loads must not exceed 8896 N (2000 lbs).
- (7) The maximum compressive load measured between the pelvis and the lumbar column of the ATD must not exceed 6674 N (1500 lbs).
- (d) An alternate approach that achieves an equivalent or greater level of occupant protection, as required by this paragraph, must be substantiated on a rational basis.

CS 29.563 Structural ditching and emergency flotation provisions

ED Decision 2018/007/R

If certification with ditching provisions or if certification with emergency flotation provisions is requested by the applicant, structural strength must meet the requirements of this CS. If certification with ditching provisions is requested by the applicant, the requirements of [CS 29.801\(f\)](#) must also be met. The loading conditions apply to all parts of the rotorcraft, unless otherwise stated by this CS and [CS 29.802\(b\)](#).

- (a) *Landing conditions.* The conditions considered must be those resulting from an emergency landing into the most severe sea conditions for which certification is requested by the applicant, at a forward ground speed not less than 15.4 m/s (30 knots), and a vertical speed not less than 1.5 m/s (5 ft/s), in likely pitch, roll and yaw attitudes. Rotor lift may be assumed to act through the centre of gravity during water entry. This lift may not exceed two-thirds of the design maximum weight.
- (b) *Loads.*
- (1) *Floats fixed or intended to be deployed before initial water contact.* The loads to be considered are those resulting from the rotorcraft entering the water, in the conditions defined in (a), and in accordance with flight manual procedures. In addition, each float, and its support and attaching structure, must be designed for the loads developed by a fully immersed float unless it can be shown that full immersion is unlikely. If full immersion is unlikely, the highest likely float buoyancy load must be applied. Appropriate air loads shall be used in substantiation of the floats and their attachment to the rotorcraft. For this purpose, the design airspeed for limit load is the float deployed airspeed operating limit multiplied by 1.11.

In the case of approval with ditching provisions, water entry with deployable floats in the unintended stowed position must also be accounted for. It must be established that in such a case, damage to the un-deployed floats, attachments or surrounding structure, that would prevent proper deployment and functioning of the floats, will not occur.

- (2) *Floats intended to be deployed after initial water contact.* The loads to be considered are those resulting from the rotorcraft entering the water, in the conditions defined in (a), and in accordance with flight manual procedures. In addition, each float and its support and attaching structure must be designed for combined vertical and drag loads. The vertical load must be that developed by a fully immersed float, unless it can be shown that full immersion is unlikely. If full immersion is unlikely, the highest likely float buoyancy load must be applied. The drag load must be determined assuming a relative speed of 10.3 m/s (20 knots) between the rotorcraft and the water.

[Amdt No: 29/5]

AMC 29.563 Structural ditching and emergency flotation provisions

ED Decision 2018/007/R

This AMC replaces FAA AC 29.563 and AC 29.563A.

- (a) Explanation.

This AMC contains specific structural conditions to be considered to support the ditching requirements of [CS 29.801](#), and the emergency flotation requirements of [CS 29.802](#).

For rotorcraft for which certification with ditching provisions is requested by the applicant, in accordance with [CS 29.801\(a\)](#), the structural conditions apply to the complete rotorcraft.

For rotorcraft for which certification with emergency flotation provisions is requested by the applicant, in accordance with [CS 29.802\(b\)](#): if the passenger capacity of the rotorcraft is less than 10 passengers, the structural conditions apply only to the flotation units and their attachments to the rotorcraft, otherwise they apply to the complete rotorcraft.

At Amendment 5, the requirement for flotation stability on waves was appreciably changed. A requirement for the substantiation of acceptable stability by means of scale model testing in irregular waves was introduced at this amendment. This change made the usage of Sea State (World Meteorological Organization) no longer appropriate. The sea conditions are now defined in terms of significant wave height (H_s) and mean wave period (T_z). These terms are therefore also used in this AMC when defining sea conditions.

- (1) The landing conditions specified in [29.563\(a\)](#) may be considered as follows:
- (i) The rotorcraft contacts the most severe sea conditions for which certification with ditching or emergency flotation provisions is requested by the applicant, selected in accordance with Table 1 of [AMC to CS 29.801\(e\) and 29.802\(c\)](#) and as illustrated in Figure 1 a). These conditions may be simulated considering the rotorcraft contacting a plane of stationary water as illustrated in Figure 1 b), inclined with a range of steepness from zero to the significant steepness given by $S_s = 2\pi H_s / (gT_z^2)$. Values of S_s are given in Table 1 of [AMC to 29.801\(e\) and 29.802\(c\)](#). The rotorcraft contacts the inclined plane of stationary water with a flight direction contained in a vertical plane. This vertical plane is perpendicular to the inclined plane, as illustrated in Figure 1 b). Likely rotorcraft pitch, roll and yaw attitudes at water entry that would reasonably be expected to occur in service, should also be considered. Autorotation, run-on landing, or one-engine-inoperative flight tests, or a validated simulation should be used to confirm the attitudes selected.

- (ii) The forward ground speed should not be less than 15.4 m/s (30 kt), and the vertical speed not less than 1.5 m/s (5 ft/s).
 - (iii) A rotor lift of not more than two-thirds of the design maximum weight may be assumed to act through the rotorcraft's centre of gravity during water entry.
 - (iv) The above conditions may be simulated or tested using a calm horizontal water surface with an equivalent impact angle and speed relative to the water surface as illustrated in Figure 1 c).
- (2) For floats that are fixed or intended to be deployed before water contact, [CS 29.563\(b\)\(1\)](#) defines the applicable load condition for entry into water, with the floats in their intended configuration.

[CS 29.563\(b\)\(1\)](#) also requires consideration of the following cases:

- The floats and their attachments to the rotorcraft should be designed for the loads resulting from a fully immersed float unless it is shown that full immersion is unlikely. If full immersion is shown to be unlikely, the determination of the highest likely buoyancy load should include consideration of a partially immersed float creating restoring moments to compensate for the upsetting moments caused by the side wind, unsymmetrical rotorcraft loading, water wave action, rotorcraft inertia, and probable structural damage and leakage considered under [CS 29.801\(e\)](#). The maximum roll and pitch angles established during compliance with [CS 29.801\(e\)](#) may be used to determine the extent of immersion of each float. When determining this, damage to the rotorcraft that could be reasonably expected should be accounted for.
 - To mitigate the case when the crew is unable to, or omits to, deploy a normally stowed emergency flotation system before entering the water, it should be substantiated that the floats will survive and function properly. The floats in their un-deployed condition, their attachments to the rotorcraft and the local structure should be designed to withstand the water entry loads without damage that would prevent the floats inflating as intended. Risks such as the splintering of surrounding components in a way that might damage the un-deployed or deploying floats should be considered. There is, however, no requirement to assess the expected loading on other parts of the rotorcraft when entering the water, with unintended un-deployed floats.
 - The floats and their attachments to the rotorcraft should be substantiated as capable of withstanding the loads generated in flight. The airspeed chosen for assessment of the loads should be the appropriate operating limitation multiplied by 1.11. For fixed floats, the operating limitation should be the rotorcraft VNE. For deployable floats, if an operating limitation for the deployment of floats and/or flight with floats deployed is given, the highest such limitation should be used, otherwise the rotorcraft VNE should be used.
- (3) For floats intended to be deployed after water contact, [CS 29.563\(b\)\(2\)](#) requires the floats and their attachments to the rotorcraft to be designed to withstand the loads generated when entering the water with the floats in their intended condition.

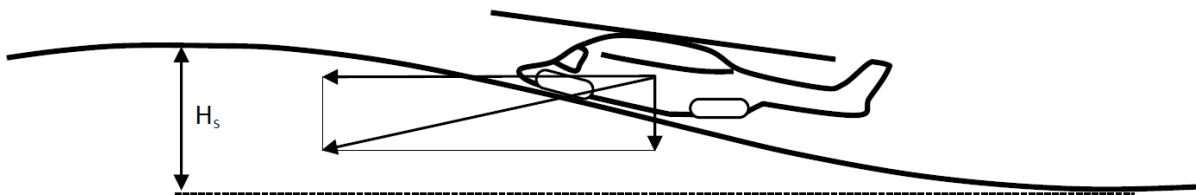
Simultaneous vertical and drag loading on the floats and their attachments should be considered to account for the rotorcraft moving forward through the water during float deployment.

The vertical loads should be those resulting from fully immersed floats unless it is shown that full immersion is unlikely. If full immersion is shown to be unlikely, the determination of the highest likely buoyancy load should include consideration of a partially immersed float creating restoring moments to compensate for the upsetting moments caused by side wind, unsymmetrical rotorcraft loading, water wave action, rotorcraft inertia, and probable structural damage and leakage considered under [CS 29.801\(e\)](#). The maximum roll and pitch angles established during compliance with [CS 29.801\(e\)](#) may be used, if significant, to determine the extent of immersion of each float. When determining this, damage to the rotorcraft that could be reasonably expected should be accounted for.

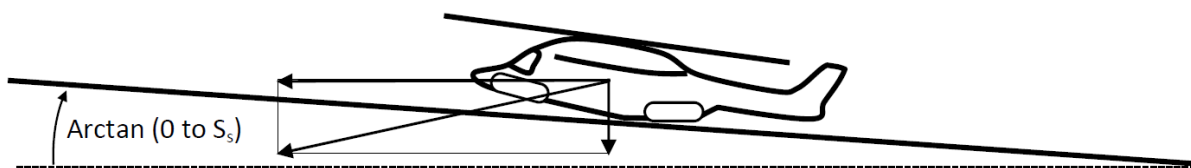
The drag loads should be those resulting from movement of the rotorcraft through the water at 10.3 m/s (20 knots).

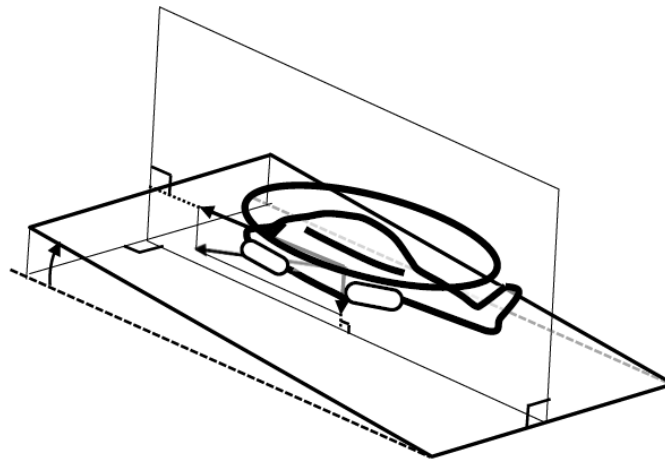
(b) Procedures

- (1) The floats and the float attachment structure should be substantiated for rational limit and ultimate loads.
- (2) The most severe sea conditions for which certification is requested by the applicant are to be considered. The sea conditions should be selected in accordance with the [AMC to 29.801\(e\) and 29.802\(c\)](#).
- (3) Landing load factors and the water load distribution may be determined by water drop tests or validated analysis.



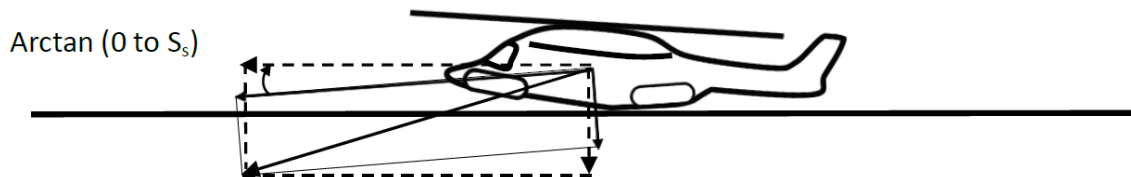
a) Water entry into wave





- b) Water entry into inclined plane of stationary water, steepness range - zero to significant steepness (S_s)

$$S_s = 2\pi H_s / (gT_z^2)$$



- c) Water entry into a stationary horizontal water surface using an equivalent water entry angle and velocity relative to the water surface
 (Dashed arrows show required horizontal and vertical speeds)

Figure 1 – Illustration of water entry test or simulation conditions which may be considered for structural provisions assessment.

[Amdt No: 29/5]

FATIGUE EVALUATION

CS 29.571 Fatigue Tolerance Evaluation of Metallic Structure

ED Decision 2012/022/R

- (a) A fatigue tolerance evaluation of each Principal Structural Element (PSE) must be performed, and appropriate inspections and retirement time or approved equivalent means must be established to avoid Catastrophic Failure during the operational life of the rotorcraft.
- (b) Reserved
- (c) Reserved
- (d) Each PSE must be identified. Structure to be considered must include the rotors, rotor drive systems between the engines and rotor hubs, controls, fuselage, fixed and movable control surfaces, engine and transmission mountings, landing gear, and their related primary attachments.
- (e) Each fatigue tolerance evaluation must include:
 - (1) In-flight measurements to determine the fatigue loads or stresses for the PSEs identified in sub-paragraph (d) in all critical conditions throughout the range of design limitations required in [CS 29.309](#) (including altitude effects), except that manoeuvring load factors need not exceed the maximum values expected in operations.
 - (2) The loading spectra as severe as those expected in operations based on loads or stresses determined under sub-paragraph (e)(1), including external load operations, if applicable, and other high frequency power-cycle operations.
 - (3) Take-off, landing, and taxi loads when evaluating the landing gear (including skis and floats) and other affected PSEs.
 - (4) For each PSE identified in sub-paragraph (d), a threat assessment, which includes a determination of the probable locations, types, and sizes of damage taking into account fatigue, environmental effects, intrinsic and discrete flaws, or accidental damage that may occur during manufacture or operation.
 - (5) A determination of the fatigue tolerance characteristics for the PSE with the damage identified in sub-paragraph (e)(4) that supports the inspection and retirement times, or other approved equivalent means.
 - (6) Analyses supported by test evidence and, if available, service experience.
- (f) A residual strength determination is required that substantiates the maximum damage size assumed in the fatigue tolerance evaluation. In determining inspection intervals based on damage growth, the residual strength evaluation must show that the remaining structure, after damage growth, is able to withstand design limit loads without failure.
- (g) The effect of damage on stiffness, dynamic behaviour, loads and functional performance must be considered.
- (h) The inspection and retirement times or approved equivalent means established under this paragraph must be included in the Airworthiness Limitation Section of the Instructions for Continued Airworthiness required by [CS 29.1529](#) and paragraph A29.4 of [Appendix A](#).

- (i) If inspections for any of the damage types identified in sub-paragraph (e)(4) cannot be established within the limitations of geometry, inspectability, or good design practice, then supplemental procedures, in conjunction with the PSE retirement time, must be established to minimize the risk of occurrence of these types of damage that could result in a catastrophic failure during the operational life of the rotorcraft.

[Amdt 29/3]

CS 29.573 Damage Tolerance and Fatigue Evaluation of Composite Rotorcraft Structures

ED Decision 2012/022/R

- (a) Composite rotorcraft structure must be evaluated under the damage tolerance requirements of sub-paragraph (d) unless the applicant establishes that a damage tolerance evaluation is impractical within the limits of geometry, inspectability, and good design practice. In such a case, the composite rotorcraft structure must undergo a fatigue evaluation in accordance with sub-paragraph (e)
- (b) Reserved
- (c) Reserved
- (d) Damage Tolerance Evaluation:
- (1) Damage tolerance evaluations of composite structures must show that Catastrophic Failure due to static and fatigue loads is avoided throughout the operational life or prescribed inspection intervals of the rotorcraft.
 - (2) The damage tolerance evaluation must include PSEs of the airframe, main and tail rotor drive systems, main and tail rotor blades and hubs, rotor controls, fixed and movable control surfaces, engine and transmission mountings, landing gear, and any other detail design points or parts whose failure or detachment could prevent continued safe flight and landing.
 - (3) Each damage tolerance evaluation must include:
 - (i) The identification of the structure being evaluated;
 - (ii) A determination of the structural loads or stresses for all critical conditions throughout the range of limits in [CS 29.309](#) (including altitude effects), supported by in-flight and ground measurements, except that manoeuvring load factors need not exceed the maximum values expected in service;
 - (iii) The loading spectra as severe as those expected in service based on loads or stresses determined under sub-paragraph (d)(3)(ii), including external load operations, if applicable, and other operations including high torque events;
 - (iv) A Threat Assessment for all structure being evaluated that specifies the locations, types, and sizes of damage, considering fatigue, environmental effects, intrinsic and discrete flaws, and impact or other accidental damage (including the discrete source of the accidental damage) that may occur during manufacture or operation;
 - (v) An assessment of the residual strength and fatigue characteristics of all structure being evaluated that supports the replacement times and inspection intervals established under sub-paragraph (d)(4); and

- (vi) allowances for the detrimental effects of material, fabrication techniques, and process variability.
- (4) Replacement times, inspections, or other procedures must be established to require the repair or replacement of damaged parts to prevent Catastrophic Failure. These replacement times, inspections, or other procedures must be included in the Airworthiness Limitations Section of the Instructions for Continued Airworthiness required by [CS 29.1529](#).
 - (i) Replacement times must be determined by tests, or by analysis supported by tests to show that throughout its life the structure is able to withstand the repeated loads of variable magnitude expected in-service. In establishing these replacement times, the following items must be considered:
 - (A) Damage identified in the Threat Assessment required by sub-paragraph (d)(3)(iv);
 - (B) Maximum acceptable manufacturing defects and in-service damage (i.e., those that do not lower the residual strength below ultimate design loads and those that can be repaired to restore ultimate strength); and
 - (C) Ultimate load strength capability after applying repeated loads.
 - (ii) Inspection intervals must be established to reveal any damage identified in the Threat Assessment required by sub-paragraph (d)(3)(iv) that may occur from fatigue or other in-service causes before such damage has grown to the extent that the component cannot sustain the required residual strength capability. In establishing these inspection intervals, the following items must be considered:
 - (A) The growth rate, including no-growth, of the damage under the repeated loads expected in-service determined by tests or analysis supported by tests; and
 - (B) The required residual strength for the assumed damage established after considering the damage type, inspection interval, detectability of damage, and the techniques adopted for damage detection. The minimum required residual strength is limit load.
- (5) The effects of damage on stiffness, dynamic behaviour, loads and functional performance must be taken into account when substantiating the maximum assumed damage size and inspection interval.
- (e) Fatigue Evaluation:

If an applicant establishes that the damage tolerance evaluation described in sub-paragraph (d) is impractical within the limits of geometry, inspectability, or good design practice, the applicant must do a fatigue evaluation of the particular composite rotorcraft structure and:

 - (1) Identify structure considered in the fatigue evaluation;
 - (2) Identify the types of damage considered in the fatigue evaluation;
 - (3) Establish supplemental procedures to minimise the risk of Catastrophic Failure associated with damage identified in sub-paragraph (e)(2); and
 - (4) Include these supplemental procedures in the Airworthiness Limitations section of the Instructions for Continued Airworthiness required by [CS 29.1529](#).

[Amdt 29/3]

SUBPART D — DESIGN AND CONSTRUCTION

GENERAL

CS 29.601 Design

ED Decision 2003/16/RM

- (a) The rotorcraft may have no design features or details that experience has shown to be hazardous or unreliable.
- (b) The suitability of each questionable design detail and part must be established by tests.

CS 29.602 Critical parts

ED Decision 2003/16/RM

- (a) Critical part - A critical part is a part, the failure of which could have a catastrophic effect upon the rotorcraft, and for which critical characteristics have been identified which must be controlled to ensure the required level of integrity.
- (b) If the type design includes critical parts, a critical parts list shall be established. Procedures shall be established to define the critical design characteristics, identify processes that affect those characteristics, and identify the design change and process change controls necessary for showing compliance with the quality assurance requirements of Part-21.

CS 29.603 Materials

ED Decision 2003/16/RM

The suitability and durability of materials used for parts, the failure of which could adversely affect safety, must –

- (a) Be established on the basis of experience or tests;
- (b) Meet approved specifications that ensure their having the strength and other properties assumed in the design data; and
- (c) Take into account the effects of environmental conditions, such as temperature and humidity, expected in service.

CS 29.605 Fabrication methods

ED Decision 2003/16/RM

- (a) The methods of fabrication used must produce consistently sound structures. If a fabrication process (such as gluing, spot welding, or heat-treating) requires close control to reach this objective, the process must be performed according to an approved process specification.
- (b) Each new aircraft fabrication method must be substantiated by a test program.

CS 29.607 Fasteners

ED Decision 2003/16/RM

- (a) Each removable bolt, screw, nut, pin or other fastener whose loss could jeopardise the safe operation of the rotorcraft must incorporate two separate locking devices. The fastener and its locking devices may not be adversely affected by the environmental conditions associated with the particular installation.
- (b) No self-locking nut may be used on any bolt subject to rotation in operation unless a non-friction locking device is used in addition to the self-locking device.

CS 29.609 Protection of structure

ED Decision 2003/16/RM

Each part of the structure must:

- (a) Be suitably protected against deterioration or loss of strength in service due to any cause, including:
 - (1) Weathering;
 - (2) Corrosion; and
 - (3) Abrasion; and
- (b) Have provisions for ventilation and drainage where necessary to prevent the accumulation of corrosive, flammable, or noxious fluids.

CS 29.610 Lightning and static electricity protection

ED Decision 2016/025/R

- (a) The rotorcraft structure must be protected against catastrophic effects from lightning.
- (b) For metallic components, compliance with sub-paragraph (a) may be shown by:
 - (1) Electrically bonding the components properly to the airframe; or
 - (2) Designing the components so that a strike will not endanger the rotorcraft.
- (c) For non-metallic components, compliance with sub-paragraph (a) may be shown by:
 - (1) Designing the components to minimise the effect of a strike; or
 - (2) Incorporating acceptable means of diverting the resulting electrical current to not endanger the rotorcraft.
- (d) The electrical bonding and protection against lightning and static electricity must:
 - (1) Minimise the accumulation of electrostatic charge;
 - (2) Minimise the risk of electrical shock to crew, passengers, and servicing and maintenance personnel using normal precautions;
 - (3) Provide an electrical return path, under both normal and fault conditions, on rotorcraft having grounded electrical systems; and
 - (4) Reduce to an acceptable level the effects of static electricity on the functioning of essential electrical and electronic equipment.

[Amdt 29/4]

CS 29.611 Inspection provisions

ED Decision 2003/16/RM

There must be means to allow close examination of each part that requires:

- (a) Recurring inspection;
- (b) Adjustment for proper alignment and functioning; or
- (c) Lubrication.

CS 29.613 Material strength properties and design values

ED Decision 2003/16/RM

- (a) Material strength properties must be based on enough tests of material meeting specifications to establish design values on a statistical basis.
- (b) Design values must be chosen to minimise the probability of structural failure due to material variability. Except as provided in subparagraphs (d) and (e), compliance with this paragraph must be shown by selecting design values that assure material strength with the following probability:
 - (1) Where applied loads are eventually distributed through a single member within an assembly, the failure of which would result in loss of structural integrity of the component, 99% probability with 95% confidence; and
 - (2) For redundant structures, those in which the failure of individual elements would result in applied loads being safely distributed to other load-carrying members, 90% probability with 95% confidence.
- (c) The strength, detail design, and fabrication of the structure must minimise the probability of disastrous fatigue failure, particularly at points of stress concentration.
- (d) Material specifications must be those contained in documents accepted by the Agency.
- (e) Other design values may be used if a selection of the material is made in which a specimen of each individual item is tested before use and it is determined that the actual strength properties of that particular item will equal or exceed those used in design.

CS 29.619 Special factors

ED Decision 2003/16/RM

- (a) The special factors prescribed in [CS 29.621](#) to [29.625](#) apply to each part of the structure whose strength is:
 - (1) Uncertain;
 - (2) Likely to deteriorate in service before normal replacement; or
 - (3) Subject to appreciable variability due to:
 - (i) Uncertainties in manufacturing processes; or
 - (ii) Uncertainties in inspection methods.

- (b) For each part of the rotorcraft to which [CS 29.621](#) to [29.625](#) apply, the factor of safety prescribed in [CS 29.303](#) must be multiplied by a special factor equal to:
- (1) The applicable special factors prescribed in [CS 29.621](#) to [29.625](#); or
 - (2) Any other factor great enough to ensure that the probability of the part being under strength because of the uncertainties specified in sub-paragraph (a) is extremely remote.

CS 29.621 Casting factors

ED Decision 2003/16/RM

- (a) *General.* The factors, tests, and inspections specified in sub-paragraphs (b) and (c) must be applied in addition to those necessary to establish foundry quality control. The inspections must meet approved specifications. Subparagraphs (c) and (d) apply to structural castings except castings that are pressure tested as parts of hydraulic or other fluid systems and do not support structural loads.
- (b) *Bearing stressed and surfaces.* The casting factors specified in sub-paragraphs (c) and (d):
- (1) Need not exceed 1.25 with respect to bearing stresses regardless of the method of inspection used; and
 - (2) Need not be used with respect to the bearing surfaces of a part whose bearing factor is larger than the applicable casting factor.
- (c) *Critical castings.* For each casting whose failure would preclude continued safe flight and landing of the rotorcraft or result in serious injury to any occupant, the following apply:
- (1) Each critical casting must:
 - (i) Have a casting factor of not less than 1.25; and
 - (ii) Receive 100% inspection by visual, radiographic, and magnetic particle (for ferromagnetic materials) or penetrant (for non ferromagnetic materials) inspection methods or approved equivalent inspection methods.
 - (2) For each critical casting with a casting factor less than 1.50, three sample castings must be static tested and shown to meet:
 - (i) The strength requirements of [CS 29.305](#) at an ultimate load corresponding to a casting factor of 1.25; and
 - (ii) The deformation requirements of [CS 29.305](#) at a load of 1.15 times the limit load.
- (d) *Non critical castings.* For each casting other than those specified in sub-paragraph (c), the following apply:
- (1) Except as provided in sub-paragraphs (d)(2) and (3), the casting factors and corresponding inspections must meet the following table:

Casting factor	Inspection
2.0 or greater	100% visual.
Less than 2.0 greater than 1.5	100% visual, and magnetic particle (ferromagnetic materials), penetrant (non ferro-magnetic materials), or approved equivalent inspection methods.
1.25 through 1.50.....	100% visual, and magnetic particle (ferromagnetic materials), penetrant (non ferro-magnetic materials), and radiographic or approved equivalent inspection methods.

- (2) The percentage of castings inspected by non visual methods may be reduced below that specified in sub-paragraph (d)(1) when an approved quality control procedure is established.
- (3) For castings procured to a specification that guarantees the mechanical properties of the material in the casting and provides for demonstration of these properties by test of coupons cut from the castings on a sampling basis:
 - (i) A casting factor of 1.0 may be used; and
 - (ii) The castings must be inspected as provided in sub-paragraph (d)(1) for casting factors of '1.25 to 1.50' and tested under sub-paragraph (c)(2).

CS 29.623 Bearing factors

ED Decision 2003/16/RM

- (a) Except as provided in sub-paragraph (b), each part that has clearance (free fit), and that is subject to pounding or vibration, must have a bearing factor large enough to provide for the effects of normal relative motion.
- (b) No bearing factor need be used on a part for which any larger special factor is prescribed.

CS 29.625 Fitting factors

ED Decision 2003/16/RM

For each fitting (part or terminal used to join one structural member to another) the following apply:

- (a) For each fitting whose strength is not proven by limit and ultimate load tests in which actual stress conditions are simulated in the fitting and surrounding structures, a fitting factor of at least 1.15 must be applied to each part of:
 - (1) The fitting;
 - (2) The means of attachment; and
 - (3) The bearing on the joined members.
- (b) No fitting factor need be used:
 - (1) For joints made under approved practices and based on comprehensive test data (such as continuous joints in metal plating, welded joints, and scarf joints in wood); and
 - (2) With respect to any bearing surface for which a larger special factor is used.
- (c) For each integral fitting, the part must be treated as a fitting up to the point at which the section properties become typical of the member.
- (d) Each seat, berth, litter, safety belt, and harness attachment to the structure must be shown by analysis, tests, or both, to be able to withstand the inertia forces prescribed in [CS 29.561\(b\)\(3\)](#) multiplied by a fitting factor of 1.33.

CS 29.629 Flutter and divergence

ED Decision 2003/16/RM

Each aerodynamic surface of the rotorcraft must be free from flutter and divergence under each appropriate speed and power condition.

CS 29.631 Birdstrike

ED Decision 2003/16/RM

The rotorcraft must be designed to assure capability of continued safe flight and landing (for Category A) or safe landing (for Category B) after impact with a 1 kg bird, when the velocity of the rotorcraft (relative to the bird along the flight path of the rotorcraft) is equal to V_{NE} or V_H (whichever is the lesser) at altitudes up to 2438 m (8 000 ft). Compliance must be shown by tests, or by analysis based on tests carried out on sufficiently representative structures of similar design.

ROTORS

CS 29.653 Pressure venting and drainage of rotor blades

ED Decision 2003/16/RM

- (a) For each rotor blade:
 - (1) There must be means for venting the internal pressure of the blade;
 - (2) Drainage holes must be provided for the blade; and
 - (3) The blade must be designed to prevent water from becoming trapped in it.
- (b) Sub-paragraphs (a)(1) and (2) do not apply to sealed rotor blades capable of withstanding the maximum pressure differentials expected in service.

CS 29.659 Mass balance

ED Decision 2003/16/RM

- (a) The rotor and blades must be mass balanced as necessary to:
 - (1) Prevent excessive vibration; and
 - (2) Prevent flutter at any speed up to the maximum forward speed.
- (b) The structural integrity of the mass balance installation must be substantiated.

CS 29.661 Rotor blade clearance

ED Decision 2003/16/RM

There must be enough clearance between the rotor blades and other parts of the structure to prevent the blades from striking any part of the structure during any operating condition.

CS 29.663 Ground resonance prevention means

ED Decision 2003/16/RM

- (a) The reliability of the means for preventing ground resonance must be shown either by analysis and tests, or reliable service experience, or by showing through analysis or tests that malfunction or failure of a single means will not cause ground resonance.
- (b) The probable range of variations, during service, of the damping action of the ground resonance prevention means must be established and must be investigated during the test required by [CS 29.241](#).

CONTROL SYSTEMS

CS 29.671 General

ED Decision 2003/16/RM

- (a) Each control and control system must operate with the ease, smoothness, and positiveness appropriate to its function.
- (b) Each element of each flight control system must be designed, or distinctively and permanently marked, to minimise the probability of any incorrect assembly that could result in the malfunction of the system.
- (c) A means must be provided to allow full control movement of all primary flight controls prior to flight, or a means must be provided that will allow the pilot to determine that full control authority is available prior to flight.

CS 29.672 Stability augmentation, automatic, and power-operated systems

ED Decision 2003/16/RM

If the functioning of stability augmentation or other automatic or power-operated system is necessary to show compliance with flight characteristics requirements of CS-29, the system must comply with [CS 29.671](#) and the following:

- (a) A warning which is clearly distinguishable to the pilot under expected flight conditions without requiring the pilot's attention must be provided for any failure in the stability augmentation system or in any other automatic or power-operated system which could result in an unsafe condition if the pilot is unaware of the failure. Warning systems must not activate the control systems.
- (b) The design of the stability augmentation system or of any other automatic or power-operated system must allow initial counteraction of failures without requiring exceptional pilot skill or strength, by overriding the failure by moving the flight controls in the normal sense, and by deactivating the failed system.
- (c) It must be shown that after any single failure of the stability augmentation system or any other automatic or power-operated system:
 - (1) The rotorcraft is safely controllable when the failure or malfunction occurs at any speed or altitude within the approved operating limitations;
 - (2) The controllability and manoeuvrability requirements of CS-29 are met within a practical operational flight envelope (for example, speed, altitude, normal acceleration, and rotorcraft configurations) which is described in the rotorcraft flight manual; and
 - (3) The trim and stability characteristics are not impaired below a level needed to allow continued safe flight and landing.

CS 29.673 Primary flight controls

ED Decision 2003/16/RM

Primary flight controls are those used by the pilot for immediate control of pitch, roll, yaw, and vertical motion of the rotorcraft.

CS 29.674 Interconnected controls

ED Decision 2003/16/RM

Each primary flight control system must provide for safe flight and landing and operate independently after a malfunction, failure, or jam of any auxiliary interconnected control.

CS 29.675 Stops

ED Decision 2003/16/RM

- (a) Each control system must have stops that positively limit the range of motion of the pilot's controls.
- (b) Each stop must be located in the system so that the range of travel of its control is not appreciably affected by:
 - (1) Wear;
 - (2) Slackness; or
 - (3) Take-up adjustments.
- (c) Each stop must be able to withstand the loads corresponding to the design conditions for the system.
- (d) For each main rotor blade:
 - (1) Stops that are appropriate to the blade design must be provided to limit travel of the blade about its hinge points; and
 - (2) There must be means to keep the blade from hitting the droop stops during any operation other than starting and stopping the rotor.

CS 29.679 Control system locks

ED Decision 2003/16/RM

If there is a device to lock the control system with the rotorcraft on the ground or water, there must be means to:

- (a) Automatically disengage the lock when the pilot operates the controls in a normal manner, or limit the operation of the rotorcraft so as to give unmistakable warning to the pilot before take-off, and
- (b) Prevent the lock from engaging in flight.

CS 29.681 Limit load static tests

ED Decision 2003/16/RM

- (a) Compliance with the limit load requirements of this Code must be shown by tests in which:
 - (1) The direction of the test loads produces the most severe loading in the control system; and
 - (2) Each fitting, pulley, and bracket used in attaching the system to the main structure is included.
- (b) Compliance must be shown (by analyses or individual load tests) with the special factor requirements for control system joints subject to angular motion.

CS 29.683 Operation tests

ED Decision 2003/16/RM

It must be shown by operation tests that, when the controls are operated from the pilot compartment with the control system loaded to correspond with loads specified for the system, the system is free from:

- (a) Jamming;
- (b) Excessive friction; and
- (c) Excessive deflection.

CS 29.685 Control system details

ED Decision 2003/16/RM

- (a) Each detail of each control system must be designed to prevent jamming, chafing, and interference from cargo, passengers, loose objects, or the freezing of moisture.
- (b) There must be means in the cockpit to prevent the entry of foreign objects into places where they would jam the system.
- (c) There must be means to prevent the slapping of cables or tubes against other parts.
- (d) Cable systems must be designed as follows:
 - (1) Cables, cable fittings, turnbuckles, splices, and pulleys must be of an acceptable kind.
 - (2) The design of cable systems must prevent any hazardous change in cable tension throughout the range of travel under any operating conditions and temperature variations.
 - (3) No cable smaller than 3.2 mm (1/8 inch) diameter may be used in any primary control system.
 - (4) Pulley kinds and sizes must correspond to the cables with which they are used.
 - (5) Pulleys must have close fitting guards to prevent the cables from being displaced or fouled.
 - (6) Pulleys must lie close enough to the plane passing through the cable to prevent the cable from rubbing against the pulley flange.
 - (7) No fairlead may cause a change in cable direction of more than 3°.
 - (8) No clevis pin subject to load or motion and retained only by cotter pins may be used in the control system.
 - (9) Turnbuckles attached to parts having angular motion must be installed to prevent binding throughout the range of travel.
 - (10) There must be means for visual inspection at each fairlead, pulley, terminal, and turnbuckle.

- (e) Control system joints subject to angular motion must incorporate the following special factors with respect to the ultimate bearing strength of the softest material used as a bearing:
 - (1) 3.33 for push-pull systems other than ball and roller bearing systems.
 - (2) 2.0 for cable systems.
- (f) For control system joints, the manufacturer's static, non-Brinell rating of ball and roller bearings may not be exceeded.

CS 29.687 Spring devices

ED Decision 2003/16/RM

- (a) Each control system spring device whose failure could cause flutter or other unsafe characteristics must be reliable.
- (b) Compliance with sub-paragraph (a) must be shown by tests simulating service conditions.

CS 29.691 Autorotation control mechanism

ED Decision 2003/16/RM

Each main rotor blade pitch control mechanism must allow rapid entry into autorotation after power failure.

CS 29.695 Power boost and power-operated control system

ED Decision 2003/16/RM

- (a) If a power boost or power-operated control system is used, an alternate system must be immediately available that allows continued safe flight and landing in the event of –
 - (1) Any single failure in the power portion of the system; or
 - (2) The failure of all engines.
- (b) Each alternate system may be a duplicate power portion or a manually operated mechanical system. The power portion includes the power source (such as hydraulic pumps), and such items as valves, lines, and actuators.
- (c) The failure of mechanical parts (such as piston rods and links), and the jamming of power cylinders, must be considered unless they are extremely improbable.

LANDING GEAR

CS 29.723 Shock absorption tests

ED Decision 2003/16/RM

The landing inertia load factor and the reserve energy absorption capacity of the landing gear must be substantiated by the tests prescribed in [CS 29.725](#) and [29.727](#), respectively. These tests must be conducted on the complete rotorcraft or on units consisting of wheel, tyre, and shock absorber in their proper relation.

CS 29.725 Limit drop test

ED Decision 2018/007/R

The limit drop test must be conducted as follows:

- (a) The drop height must be at least 20 cm (8 inches).
- (b) If considered, the rotor lift specified in [CS 29.473\(a\)](#) must be introduced into the drop test by appropriate energy absorbing devices or by the use of an effective mass.
- (c) Each landing gear unit must be tested in the attitude simulating the landing condition that is most critical from the standpoint of the energy to be absorbed by it.
- (d) When an effective mass is used in showing compliance with sub-paragraph (b), the following formulae may be used instead of more rational computations:

$$W_e = W \left(\frac{h + (1 - L)d}{h + d} \right); \text{ and}$$

$$n = n_j \frac{W_e}{W} + L$$

where:

W_e = the effective weight to be used in the drop test (N (lb)).

W = W_M for main gear units (N (lb)), equal to the static reaction on the particular unit with the rotorcraft in the most critical attitude. A rational method may be used in computing a main gear static reaction, taking into consideration the moment arm between the main wheel reaction and the rotorcraft centre of gravity.

W = W_N for nose gear units (N (lb)), equal to the vertical component of the static reaction that would exist at the nose wheel, assuming that the mass of the rotorcraft acts at the centre of gravity and exerts a force of 1.0 g downward and 0.25 g forward.

W = W_T for tailwheel units (N (lb)) equal to whichever of the following is critical:

- (1) The static weight on the tailwheel with the rotorcraft resting on all wheels; or
- (2) The vertical component of the ground reaction that would occur at the tailwheel assuming that the mass of the rotorcraft acts at the centre of gravity and exerts a force of 1 g downward with the rotorcraft in the maximum nose-up attitude considered in the nose-up landing conditions.

h = specified free drop height (m (inches)).

L = ratio of assumed rotor lift to the rotorcraft weight.

- d = deflection under impact of the tyre (at the proper inflation pressure) plus the vertical component of the axle travel (m (inches)) relative to the drop mass.
- n = limit inertia load factor.
- n_j = the load factor developed, during impact, on the mass used in the drop test (i.e., the acceleration dv/dt in g recorded in the drop test plus 1.0).

[Amdt No: 29/5]

CS 29.727 Reserve energy absorption drop test

ED Decision 2003/16/RM

The reserve energy absorption drop test must be conducted as follows:

- (a) The drop height must be 1.5 times that specified in [CS 29.725\(a\)](#).
- (b) Rotor lift, where considered in a manner similar to that prescribed in [CS 29.725\(b\)](#), may not exceed 1.5 times the lift allowed under that paragraph.
- (c) The landing gear must withstand this test without collapsing. Collapse of the landing gear occurs when a member of the nose, tail, or main gear will not support the rotorcraft in the proper attitude or allows the rotorcraft structure, other than landing gear and external accessories, to impact the landing surface.

CS 29.729 Retracting mechanism

ED Decision 2003/16/RM

For rotorcraft with retractable landing gear, the following apply:

- (a) *Loads*. The landing gear, retracting mechanism, wheel well doors, and supporting structure must be designed for:
 - (1) The loads occurring in any manoeuvring condition with the gear retracted;
 - (2) The combined friction, inertia, and air loads occurring during retraction and extension at any airspeed up to the design maximum landing gear operating speed; and
 - (3) The flight loads, including those in yawed flight, occurring with the gear extended at any airspeed up to the design maximum landing gear extended speed.
- (b) *Landing gear lock*. A positive means must be provided to keep the gear extended.
- (c) *Emergency operation*. When other than manual power is used to operate the gear, emergency means must be provided for extending the gear in the event of:
 - (1) Any reasonably probable failure in the normal retraction system; or
 - (2) The failure of any single source of hydraulic, electric, or equivalent energy.
- (d) *Operation tests*. The proper functioning of the retracting mechanism must be shown by operation tests.
- (e) *Position indicator*. There must be means to indicate to the pilot when the gear is secured in the extreme positions.
- (f) *Control*. The location and operation of the retraction control must meet the requirements of [CS 29.777](#) and [29.779](#).

- (g) *Landing gear warning.* An aural or equally effective landing gear warning device must be provided that functions continuously when the rotorcraft is in a normal landing mode and the landing gear is not fully extended and locked. A manual shutoff capability must be provided for the warning device and the warning system must automatically reset when the rotorcraft is no longer in the landing mode.

CS 29.731 Wheels

ED Decision 2003/16/RM

- (a) Each landing gear wheel must be approved.
- (b) The maximum static load rating of each wheel may not be less than the corresponding static ground reaction with:
- (1) Maximum weight; and
 - (2) Critical centre of gravity.
- (c) The maximum limit load rating of each wheel must equal or exceed the maximum radial limit load determined under the applicable ground load requirements of CS-29.

CS 29.733 Tyres

ED Decision 2003/16/RM

Each landing gear wheel must have a tyre:

- (a) That is a proper fit on the rim of the wheel; and
- (b) Of a rating that is not exceeded under:
- (1) The design maximum weight;
 - (2) A load on each main wheel tyre equal to the static ground reaction corresponding to the critical centre of gravity; and
 - (3) A load on nose wheel tyres to be compared with the dynamic rating established for those tyres equal to the reaction obtained at the nose wheel, assuming that the mass of the rotorcraft acts as the most critical centre of gravity and exerts a force of 1.0 g downward and 0.25 g forward, the reactions being distributed to the nose and main wheels according to the principles of statics with the drag reaction at the ground applied only at wheels with brakes.
- (c) Each tyre installed on a retractable landing gear system must, at the maximum size of the tyre type expected in service, have a clearance to surrounding structure and systems that is adequate to prevent contact between the tyre and any part of the structure or systems.

CS 29.735 Brakes

ED Decision 2003/16/RM

For rotorcraft with wheel-type landing gear, a braking device must be installed that is:

- (a) Controllable by the pilot;
- (b) Usable during power-off landings; and
- (c) Adequate to:
 - (1) Counteract any normal unbalanced torque when starting or stopping the rotor; and
 - (2) Hold the rotorcraft parked on a 10° slope on a dry, smooth pavement.

CS 29.737 Skis

ED Decision 2003/16/RM

- (a) The maximum limit load rating of each ski must equal or exceed the maximum limit load determined under the applicable ground load requirements of CS-29.
- (b) There must be a stabilising means to maintain the ski in an appropriate position during flight. This means must have enough strength to withstand the maximum aerodynamic and inertia loads on the ski.

FLOATS AND HULLS

CS 29.751 Main float buoyancy

ED Decision 2003/16/RM

- (a) For main floats, the buoyancy necessary to support the maximum weight of the rotorcraft in fresh water must be exceeded by:
 - (1) 50%, for single floats; and
 - (2) 60%, for multiple floats.
- (b) Each main float must have enough watertight compartments so that, with any single main float compartment flooded, the main floats will provide a margin of positive stability great enough to minimise the probability of capsizing.

CS 29.753 Main float design

ED Decision 2003/16/RM

- (a) *Bag floats.* Each bag float must be designed to withstand:
 - (1) The maximum pressure differential that might be developed at the maximum altitude for which certification with the float is requested; and
 - (2) The vertical loads prescribed in [CS 29.521\(a\)](#), distributed along the length of the bag over three-quarters of its projected area.
- (b) *Rigid floats.* Each rigid float must be able to withstand the vertical, horizontal, and side loads prescribed in [CS 29.521](#). An appropriate load distribution under critical conditions must be used.

CS 29.755 Hull buoyancy

ED Decision 2003/16/RM

Water-based and amphibian rotorcraft. The hull and auxiliary floats, if used, must have enough watertight compartments so that, with any single compartment of the hull or auxiliary floats flooded, the buoyancy of the hull and auxiliary floats, and wheel tyres if used, provides a margin of positive water stability great enough to minimise the probability of capsizing the rotorcraft for the worst combination of wave heights and surface winds for which approval is desired.

CS 29.757 Hull and auxiliary float strength

ED Decision 2003/16/RM

The hull, and auxiliary floats if used, must withstand the water loads prescribed by [CS 29.519](#) with a rational and conservative distribution of local and distributed water pressures over the hull and float bottom.

PERSONNEL AND CARGO ACCOMMODATIONS

CS 29.771 Pilot compartment

ED Decision 2003/16/RM

For each pilot compartment:

- (a) The compartment and its equipment must allow each pilot to perform his duties without unreasonable concentration or fatigue;
- (b) If there is provision for a second pilot, the rotorcraft must be controllable with equal safety from either pilot position. Flight and powerplant controls must be designed to prevent confusion or inadvertent operation when the rotorcraft is piloted from either position;
- (c) The vibration and noise characteristics of cockpit appurtenances may not interfere with safe operation;
- (d) Inflight leakage of rain or snow that could distract the crew or harm the structure must be prevented.

CS 29.773 Pilot compartment view

ED Decision 2003/16/RM

- (a) *Non precipitation conditions.* For non precipitation conditions, the following apply:
 - (1) Each pilot compartment must be arranged to give the pilots a sufficiently extensive, clear, and undistorted view for safe operation.
 - (2) Each pilot compartment must be free of glare and reflection that could interfere with the pilot's view. If certification for night operation is requested, this must be shown by night flight tests.
- (b) *Precipitation conditions.* For precipitation conditions, the following apply:
 - (1) Each pilot must have a sufficiently extensive view for safe operation:
 - (i) In heavy rain at forward speeds up to V_H ; and
 - (ii) In the most severe icing condition for which certification is requested.
 - (2) The first pilot must have a window that:
 - (i) Is openable under the conditions prescribed in sub-paragraph (b)(1); and
 - (ii) Provides the view prescribed in that paragraph.

CS 29.775 Windshields and windows

ED Decision 2003/16/RM

Windshields and windows must be made of material that will not break into dangerous fragments.

CS 29.777 Cockpit controls

ED Decision 2003/16/RM

Cockpit controls must be:

- (a) Located to provide convenient operation and to prevent confusion and inadvertent operation; and
- (b) Located and arranged with respect to the pilot's seats so that there is full and unrestricted movement of each control without interference from the cockpit structure or the pilot's clothing when pilots from 1.57 m (5ft 2ins) to 1.8 m (6ft) in height are seated.

CS 29.779 Motion and effect of cockpit controls

ED Decision 2003/16/RM

Cockpit controls must be designed so that they operate in accordance with the following movements and actuation:

- (a) Flight controls, including the collective pitch control, must operate with a sense of motion which corresponds to the effect on the rotorcraft.
- (b) Twist-grip engine power controls must be designed so that, for left-hand operation, the motion of the pilot's hand is clockwise to increase power when the hand is viewed from the edge containing the index finger. Other engine power controls, excluding the collective control, must operate with a forward motion to increase power.
- (c) Normal landing gear controls must operate downward to extend the landing gear.

CS 29.783 Doors

ED Decision 2018/007/R

- (a) Each closed cabin must have at least one adequate and easily accessible external door.
- (b) Each external door must be located, and appropriate operating procedures must be established, to ensure that persons using the door will not be endangered by the rotors, propellers, engine intakes, and exhausts when the operating procedures are used.
- (c) There must be means for locking crew and external passenger doors and for preventing their opening in flight inadvertently or as a result of mechanical failure. It must be possible to open external doors from inside and outside the cabin with the rotorcraft on the ground even though persons may be crowded against the door on the inside of the rotorcraft. The means of opening must be simple and obvious and so arranged and marked that it can be readily located and operated.
- (d) There must be reasonable provisions to prevent the jamming of any external door in a minor crash as a result of fuselage deformation under the following ultimate inertial forces except for cargo or service doors not suitable for use as an exit in an emergency:
 - (1) Upward – 1.5 g
 - (2) Forward – 4.0 g
 - (3) Sideward – 2.0 g
 - (4) Downward – 4.0 g
- (e) There must be means for direct visual inspection of the locking mechanism by crew members to determine whether the external doors (including passenger, crew, service, and cargo doors)

are fully locked. There must be visual means to signal to appropriate crew members when normally used external doors are closed and fully locked.

- (f) For outward opening external doors usable for entrance or egress, there must be an auxiliary safety latching device to prevent the door from opening when the primary latching mechanism fails. If the door does not meet the requirements of sub-paragraph (c) with this device in place, suitable operating procedures must be established to prevent the use of the device during take-off and landing.
- (g) If an integral stair is installed in a passenger entry door that is qualified as a passenger emergency exit, the stair must be designed so that under the following conditions the effectiveness of passenger emergency egress will not be impaired:
 - (1) The door, integral stair, and operating mechanism have been subjected to the inertial forces specified in sub-paragraph (d), acting separately relative to the surrounding structure.
 - (2) The rotorcraft is in the normal ground attitude and in each of the attitudes corresponding to collapse of one or more legs, or primary members, as applicable, of the landing gear.
- (h) Non jettisonable doors used as ditching emergency exits must have means to enable them to be secured in the open position and remain secure for emergency egress in all sea conditions for which ditching capability is requested by the applicant.

[Amdt No: 29/5]

CS 29.785 Seats, berths, safety belts, and harnesses

ED Decision 2003/16/RM

- (a) Each seat, safety belt, harness, and adjacent part of the rotorcraft at each station designated for occupancy during take-off and landing must be free of potentially injurious objects, sharp edges, protuberances, and hard surfaces and must be designed so that a person making proper use of these facilities will not suffer serious injury in an emergency landing as a result of the inertial factors specified in [CS 29.561\(b\)](#) and dynamic conditions specified in [CS 29.562](#).
- (b) Each occupant must be protected from serious head injury by a safety belt plus a shoulder harness that will prevent the head from contacting any injurious object except as provided for in [CS 29.562\(c\)\(5\)](#). A shoulder harness (upper torso restraint), in combination with the safety belt, constitutes a torso restraint system as described in ETSO-C114.
- (c) Each occupant's seat must have a combined safety belt and shoulder harness with a single-point release. Each pilot's combined safety belt and shoulder harness must allow each pilot when seated with safety belt and shoulder harness fastened to perform all functions necessary for flight operations. There must be a means to secure belts and harnesses, when not in use, to prevent interference with the operation of the rotorcraft and with rapid egress in an emergency.
- (d) If seat backs do not have a firm handhold, there must be hand grips or rails along each aisle to let the occupants steady themselves while using the aisle in moderately rough air.
- (e) Each projecting object that would injure persons seated or moving about in the rotorcraft in normal flight must be padded.
- (f) Each seat and its supporting structure must be designed for an occupant weight of at least 77 kg (170 pounds) considering the maximum load factors, inertial forces, and reactions between the

occupant, seat, and safety belt or harness corresponding with the applicable flight and ground load conditions, including the emergency landing conditions of [CS 29.561\(b\)](#). In addition:

- (1) Each pilot seat must be designed for the reactions resulting from the application of the pilot forces prescribed in [CS 29.397](#); and
 - (2) The inertial forces prescribed in [CS 29.561\(b\)](#) must be multiplied by a factor of 1.33 in determining the strength of the attachment of:
 - (i) Each seat to the structure; and
 - (ii) Each safety belt or harness to the seat or structure.
- (g) When the safety belt and shoulder harness are combined, the rated strength of the safety belt and shoulder harness may not be less than that corresponding to the inertial forces specified in [CS 29.561\(b\)](#), considering the occupant weight of at least 77 kg (170 pounds), considering the dimensional characteristics of the restraint system installation, and using a distribution of at least a 60% load to the safety belt and at least a 40% load to the shoulder harness. If the safety belt is capable of being used without the shoulder harness, the inertial forces specified must be met by the safety belt alone.
- (h) When a headrest is used, the headrest and its supporting structure must be designed to resist the inertia forces specified in [CS 29.561](#), with a 1.33 fitting factor and a head weight of at least 5.9 kg (13 pounds).
- (i) Each seating device system includes the device such as the seat, the cushions, the occupant restraint system, and attachment devices.
- (j) Each seating device system may use design features such as crushing or separation of certain parts of the seat in the design to reduce occupant loads for the emergency landing dynamic conditions of [CS 29.562](#); otherwise, the system must remain intact and must not interfere with rapid evacuation of the rotorcraft.
- (k) For the purposes of this paragraph, a litter is defined as a device designed to carry a non ambulatory person, primarily in a recumbent position, into and on the rotorcraft. Each berth or litter must be designed to withstand the load reaction of an occupant weight of at least 77 kg (170 pounds) when the occupant is subjected to the forward inertial factors specified in [CS 29.561\(b\)](#). A berth or litter installed within 15° or less of the longitudinal axis of the rotorcraft must be provided with a padded end-board, cloth diaphragm, or equivalent means that can withstand the forward load reaction. A berth or litter oriented greater than 15° with the longitudinal axis of the rotorcraft must be equipped with appropriate restraints, such as straps or safety belts, to withstand the forward reaction. In addition:
- (1) The berth or litter must have a restraint system and must not have corners or other protuberances likely to cause serious injury to a person occupying it during emergency landing conditions; and
 - (2) The berth or litter attachment and the occupant restraint system attachments to the structure must be designed to withstand the critical loads resulting from flight and ground load conditions and from the conditions prescribed in [CS 29.561\(b\)](#). The fitting factor required by [CS 29.625\(d\)](#) shall be applied.

CS 29.787 Cargo and baggage compartments

ED Decision 2003/16/RM

- (a) Each cargo and baggage compartment must be designed for its placarded maximum weight of contents and for the critical load distributions at the appropriate maximum load factors corresponding to the specified flight and ground load conditions, except the emergency landing conditions of [CS 29.561](#).
- (b) There must be means to prevent the contents of any compartment from becoming a hazard by shifting under the loads specified in subparagraph (a).
- (c) Under the emergency landing conditions of [CS 29.561](#), cargo and baggage compartments must:
 - (1) Be positioned so that if the contents break loose they are unlikely to cause injury to the occupants or restrict any of the escape facilities provided for use after an emergency landing; or
 - (2) Have sufficient strength to withstand the conditions specified in [CS 29.561](#), including the means of restraint and their attachments required by sub-paragraph (b). Sufficient strength must be provided for the maximum authorised weight of cargo and baggage at the critical loading distribution.
- (d) If cargo compartment lamps are installed, each lamp must be installed so as to prevent contact between lamp bulb and cargo.

CS 29.801 Ditching

ED Decision 2018/007/R

- (a) If certification with ditching provisions is requested by the applicant, the rotorcraft must meet the requirements of this CS and [CS 29.563](#), [CS 29.783\(h\)](#), [CS 29.803\(c\)](#), [CS 29.805\(c\)](#), [CS 29.807\(d\)](#), [CS 29.809\(j\)](#), [CS 29.811\(h\)](#), [CS 29.813\(d\)](#), [CS 29.1411](#), [CS 29.1415](#), [CS 29.1470](#), [CS 29.1555\(d\)\(3\)](#) and [CS 29.1561](#).
- (b) Each practicable design measure, compatible with the general characteristics of the rotorcraft, must be taken to minimise the probability that when ditching, the behaviour of the rotorcraft would cause immediate injury to the occupants or would make it impossible for them to escape.
- (c) An emergency flotation system that is stowed in a deflated condition during normal flight must:
 - (1) be designed such that the effects of a water impact (i.e. crash) on the emergency flotation system are minimised.
 - (2) have a means of automatic deployment following water entry. Automatic deployment must not rely on any pilot action during flight.
- (d) The probable behaviour of the rotorcraft during ditching water entry must be shown to exhibit no unsafe characteristics.
- (e) The rotorcraft must be shown to resist capsize in the sea conditions selected by the applicant. The probability of capsizing in a 5-minute exposure to the sea conditions must be substantiated to be less than or equal to 3.0 % with a fully serviceable emergency flotation system and 30.0 % with the critical float compartment failed, with 95 % confidence.
Allowances must be made for probable structural damage and leakage.

- (f) Unless the effects of the collapse of external doors and windows are accounted for in the investigation of the probable behaviour of the rotorcraft during ditching (as prescribed in subparagraphs (d) and (e)), the external doors and windows must be designed to withstand the probable maximum local pressures.
- (g) It must be shown that the rotorcraft will not sink following the functional loss of any single complete flotation unit.

[Amdt No: 29/5]

AMC 29.801 Ditching

ED Decision 2018/007/R

This AMC replaces FAA AC 29.801.

(a) Definitions

- (1) Ditching: a controlled emergency landing on the water, deliberately executed in accordance with rotorcraft flight manual (RFM) procedures, with the intent of abandoning the rotorcraft as soon as practicable.
- (2) Emergency flotation system (EFS): a system of floats and any associated parts (e.g. gas cylinders, means of deployment, pipework and electrical connections) that is designed and installed on a rotorcraft to provide buoyancy and flotation stability in a ditching.

(b) Explanation

- (1) Ditching certification is performed only if requested by the applicant.
- (2) For a rotorcraft to be certified for ditching, in addition to the other applicable requirements of CS-29, the rotorcraft must specifically meet [CS 29.801](#) together with the requirements referenced in [CS 29.801\(a\)](#).
- (3) Ditching certification encompasses four primary areas of concern: rotorcraft water entry and flotation stability (including loads and flotation system design), occupant egress, and occupant survival. CS-29 Amendment 5 has developed enhanced standards in all of these areas.
- (4) The scope of the ditching requirements is expanded at Amendment 5 through a change in the ditching definition. All potential failure conditions that could result in a controlled 'land immediately' action by the pilot are now included. This primarily relates to changes in water entry conditions. While the limiting conditions for water entry have been retained (15.4 m/s, 1.5 m/s), the alleviation that previously allowed less than 15.4 m/s (30 kt) forward speed to be substantiated as the maximum applicable value has been removed (also from [CS 29.563](#)).
- (5) Flotation stability is enhanced through the introduction of a new standard based on a probabilistic approach to capsizes.
- (6) Failure of the EFS to operate when required will lead to the rotorcraft rapidly capsizing and sinking. Operational experience has shown that localised damage or failure of a single component of an EFS, or the failure of the flight crew to activate or deploy the EFS, can lead to the loss of the complete system. Therefore, the design of the EFS needs careful consideration; automatic arming and deployment have been shown to be practicable and to offer a significant safety benefit.

- (7) The sea conditions, on which certification with ditching provisions is to be based, are selected by the applicant and should take into account the expected sea conditions in the intended areas of operation. The wave climate of the northern North Sea is adopted as the default wave climate as it represents a conservative condition. The applicant may also select alternative/additional sea areas with any associated certification then being limited to those geographical regions. The significant wave height, and any geographical limitations (if applicable – see the [AMC to CS 29.801\(e\) and 29.802\(c\)](#)) should be included in the RFM as performance information.
- (8) During scale model testing, appropriate allowances should be made for probable structural damage and leakage. Previous model tests and other data from rotorcraft of similar configurations that have already been substantiated based on equivalent test conditions may be used to satisfy the ditching requirements. In regard to flotation stability, the test conditions should be equivalent to those defined in [AMC to 29.801\(e\) and 29.802\(c\)](#).
- (9) CS 29.801(e) requires that after ditching in sea conditions for which certification with ditching provisions is requested by the applicant, the probability of capsizing in a 5 minute exposure is acceptably low in order to allow the occupants to leave the rotorcraft and enter life rafts. This should be interpreted to mean that up to and including the worst-case sea conditions for which certification with ditching provisions is requested by the applicant, the probability that the rotorcraft will capsize should be not higher than the target stated in the certification specification. An acceptable means of demonstrating post-ditching flotation stability is through scale model testing using irregular waves. The [AMC to CS 29.801\(e\) and 29.802\(c\)](#) contains a test specification that has been developed for this purpose.
- (10) Providing a ‘wet floor’ concept (water in the cabin) by positioning the floats higher on the fuselage sides and allowing the rotorcraft to float lower in the water, can be a way of increasing the stability of a ditched rotorcraft (although this would need to be verified for the individual rotorcraft type for all weight and loading conditions), or it may be desirable for other reasons. This is permissible provided that the mean static level of water in the cabin is limited to being lower than the upper surface of the seat cushion (for all rotorcraft mass and centre of gravity cases, with all flotation units intact), and that the presence of water will not unduly restrict the ability of occupants to evacuate the rotorcraft and enter the life raft.
- (11) It should be shown by analysis or other means that the rotorcraft will not sink following the functional loss of any single complete ditching flotation unit. Experience has shown that in water impact events, the forces exerted on the emergency flotation unit that first comes into contact with the water surface, together with structural deformation and other damage, can render the unit unusable. Maintenance errors may also lead to a flotation unit failing to inflate. The ability of occupants to egress successfully is significantly increased if the rotorcraft does not sink. However, this requirement is not intended for any other purpose, such as aiding salvage of the rotorcraft. Therefore, consideration of the remaining flotation units remaining inflated for an especially long period, i.e. longer than required in the upright floating case, is not required.
- (12) The sea conditions approved for ditching should be stated in the performance information section of the RFM.

-
- (13) Current practices allow wide latitude in the design of cabin interiors and, consequently, of stowage provisions for safety and ditching equipment. Rotorcraft manufacturers may deliver aircraft with unfinished (green) interiors that are to be completed by a modifier.
- (i) Segmented certification is permitted to accommodate this practice. That is, the rotorcraft manufacturer shows compliance with the flotation time, stability, and emergency exit requirements while a modifier shows compliance with the equipment and egress requirements with the interior completed. This procedure requires close cooperation and coordination between the manufacturer, modifier, and EASA.
 - (ii) The rotorcraft manufacturer may elect to establish a token interior for ditching certification. This interior may subsequently be modified by a supplemental type certificate (STC). The ditching provisions should be shown to be compliant with the applicable requirements after any interior configuration or limitation change.
 - (iii) The RFM and any RFM supplements deserve special attention if a segmented certification procedure is pursued.
- (c) Procedures
- (1) Flotation system design
 - (i) Structural integrity should be established in accordance with [CS 29.563](#).
 - (ii) Rotorcraft handling qualities should be verified to comply with the applicable certification specifications throughout the approved flight envelope with floats installed. Where floats are normally deflated, and deployed in flight, the handling qualities should be verified for the approved operating envelopes with the floats in:
 - (A) the deflated and stowed condition;
 - (B) the fully inflated condition; and
 - (C) the in-flight inflation condition; for float systems which may be inflated in flight, rotorcraft controllability should be verified by test or analysis, taking into account all possible emergency flotation system inflation failures.
 - (iii) Reliability should be considered in the basic design to assure approximately equal inflation of the floats to preclude excessive yaw, roll, or pitch in flight or in the water:
 - (A) Maintenance procedures should not degrade the flotation system (e.g. by introducing contaminants that could affect normal operation, etc.).
 - (B) The flotation system design should preclude inadvertent damage due to normal personnel traffic flow and wear and tear. Protection covers should be evaluated for function and reliability.
 - (C) The designs of the floats should provide means to minimise the likelihood of damage or tear propagation between compartments. Single compartment float designs should be avoided.

- (D) When showing compliance with [CS 29.801\(c\)\(1\)](#), and where practicable, the design of the flotation system should consider the likely effects of water impact (i.e. crash) loads. For example:
- (a) locate system components away from the major effects of structural deformation;
 - (b) use redundant or distributed systems;
 - (c) use flexible pipes/hoses; and
 - (d) avoid passing pipes/hoses or electrical wires through bulkheads that could act as a 'guillotine' when the structure is subject to water impact loads.
- (iv) The floats should be fabricated from highly conspicuous material to assist in the location of the rotorcraft following a ditching (and possible capsizing).
- (2) Flotation system inflation.
- Emergency flotation systems (EFSs) that are normally stowed in a deflated condition and are inflated either in flight or after contact with water should be evaluated as follows:
- (i) The emergency flotation system should include a means to verify its system integrity prior to each flight.
 - (ii) Means should be provided to automatically trigger the inflation of the EFS upon water entry, irrespective of whether or not inflation prior to water entry is the intended operation mode. If a manual means of inflation is provided, the float activation switch should be located on one of the primary flight controls and should be safeguarded against inadvertent actuation.
 - (iii) The inflation system should be shown to have an appropriately low probability of spontaneous or inadvertent actuation in flight conditions for which float deployment has not been demonstrated to be safe. If this is achieved by disarming of the inflation system, this should be achieved by the use of an automatic system employing appropriate input parameters. The choice of input parameters, and architecture of the system, should be such that rearming of the system occurs automatically in a manner that will assure the inflation system functions as intended in the event of a water impact. As required by [CS 29.801\(c\)](#), in achieving this, it is not acceptable to specify any pilot action during flight. Float disarming is typically required at high airspeeds, and could be achieved automatically using an airspeed switch. However, this would retain the possibility of inadvertent flight into the water at high airspeed, with the risk that the floats would not deploy. This scenario could be addressed by providing an additional or alternative means of rearming the floats as the aircraft descends through an appropriate height threshold. A height below that of the majority of offshore helidecks could be chosen in order to minimise exposure to inadvertent activation above the demonstrated float deployment airspeed.
 - (iv) The maximum airspeeds for intentional in-flight actuation of the emergency flotation system and for flight with the floats inflated should be established as limitations in the RFM unless in-flight actuation is prohibited by the RFM.

- (v) Activation of the emergency flotation system upon water entry (irrespective of whether or not inflation prior to water entry is the intended operation mode) should result in an inflation time short enough to prevent the rotorcraft from becoming excessively submerged.
- (vi) A means should be provided for checking the pressure of the gas storage cylinders prior to take-off. A table of acceptable gas cylinder pressure variation with ambient temperature and altitude (if applicable) should be provided.
- (vii) A means should be provided to minimise the possibility of over inflation of the flotation units under any reasonably probable actuation conditions.
- (viii) The ability of the floats to inflate without puncturing when subjected to actual water pressures should be substantiated. A demonstration of a full-scale float immersion in a calm body of water is one acceptable method of substantiation. Precautions should also be taken to avoid floats being punctured due to the proximity of sharp objects, during inflation in flight and with the helicopter in the water, and during subsequent movement of the helicopter in waves. Examples of objects that need to be considered are aerials, probes, overboard vents, unprotected split-pin tails, guttering and any projections sharper than a three-dimensional right-angled corner.
- (ix) The inflation system design should, where practicable, minimise the possibility of foreseeable damage preventing the operation or partial operation of the EFS (e.g. interruption of the electrical supply or pipework). This could be achieved through the use of redundant systems or through distributed systems where each flotation unit is capable of autonomous operation (i.e. through the provision of individual inflation gas sources, electrical power sources and float activation switches).
- (x) The inflation system design should minimise the probability that the floats do not inflate properly or inflate asymmetrically in the event of a ditching. This may be accomplished by interconnecting inflation gas sources, for which flexible hoses should be used to minimise potential damage, or by synchronising the deployment of autonomous flotation units. Note that the main concern in the event of a water impact is to prevent the rotorcraft from sinking; asymmetric deployment is a lesser concern.
- (xi) CS 29.801(g) requires it to be shown that the rotorcraft will not sink following the functional loss of any complete flotation unit. A 'complete flotation unit' shall be taken to mean a discrete, independently located float. The qualifying term 'complete' means that the entire structure of the flotation unit must be considered, not limited to any segregated compartments.

The loss of function of a flotation unit is most likely to be due to damage occurring in a water impact. However, there may be other reasons, such as undetected damage during maintenance, or incorrect maintenance. All reasonably probable causes for the loss of functionality of a flotation unit, and the resultant effect(s) on the remainder of the inflation system, should therefore be taken into account.

In the case of inflatable flotation units, irrespective of whether the intended operation is to deploy the system before or after water entry, the following shall be taken into account when assessing the ability of the rotorcraft to remain afloat;

- Following the functional loss of a deployed flotation unit, the capability to maintain pressure in the remaining inflation units should be justified on the basis of the inflation system design, for example:
 - Individual inflation gas sources per flotation unit,
 - Installation of non-return valves at appropriate locations.
 - Following the functional loss of a non-deployed flotation unit, the capability of the remaining flotation units to deploy should be justified on the basis of the inflation system design, for example:
 - The functionality of the inflation gas sources integrated with the functionally lost flotation unit in question should also either be assumed to be lost, or justification should otherwise be provided,
 - The degree of inflation of the remaining undamaged flotation units, which share parts of the inflation system with the damaged unit, bearing in mind that the damaged unit will be venting, should be determined.
- (3) Injury prevention during and following water entry.

An assessment of the cabin and cockpit layouts should be undertaken to minimise the potential for injury to occupants in a ditching. This may be performed as part of the compliance with [CS 29.785](#). Attention should be given to the avoidance of injuries due to arm/leg flailing, as these can be a significant impediment to occupant egress and subsequent survivability. Practical steps that could be taken include:

- (i) locating potentially hazardous equipment away from the occupants;
- (ii) installing energy-absorbing padding onto interior components;
- (iii) using frangible materials; and
- (iv) designs that exclude hard or sharp edges.

- (4) Water entry procedures.

Tests or simulations (or a combination of both) should be conducted to establish procedures and techniques to be used for water entry, based on the conditions given in (5). These tests/simulations should include determination of the optimum pitch attitude and forward velocity for ditching in a calm sea as well as entry procedures for the most severe sea condition to be certified. Procedures for all failure conditions that may lead to a 'land immediately' action (e.g. one engine inoperative, all engines inoperative, tail rotor/drive failure) should be established. However, only the procedures for the most critical all-engines-inoperative condition need be verified by water entry test data.

(5) Water entry behaviour.

CS 29.801(d) requires the probable behaviour of the rotorcraft to be shown to exhibit no unsafe characteristics, e.g. that would lead to an inability to remain upright.

This should be demonstrated by means of scale model testing, based on the following conditions:

- (i) For entry into a calm sea:
 - (A) the optimum pitch, roll and yaw attitudes determined in (c)(5) above, with consideration for variations that would reasonably be expected to occur in service;
 - (B) ground speeds from 0 to 15.4 m/s (0 to 30 kt); and
 - (C) descent rate of 1.5 m/s (5 ft/s) or greater;
- (ii) For entry into the most severe sea condition:
 - (A) the optimum pitch attitude and entry procedure as determined in (c)(5) above;
 - (B) ground speed of 15.4 m/s (30 kt);
 - (C) descent rate of 1.5 m/s (5 ft/s) or greater;
 - (D) likely roll and yaw attitudes; and
 - (E) sea conditions may be represented by regular waves having a height at least equal to the significant wave height (H_s), and a period no larger than the wave zero-crossing period (T_z) for the wave spectrum chosen for demonstration of rotorcraft flotation stability after water entry (see (c)(7) below and [AMC to CS 29.801\(e\) and 29.802\(c\)](#));
- (iii) Scoops, flaps, projections, and any other factors likely to affect the hydrodynamic characteristics of the rotorcraft should be considered;
- (iv) Probable damage to the structure due to water entry should be considered during the water entry evaluations (e.g. failure of windows, doors, skins, panels, etc.); and
- (v) Rotor lift does not have to be considered.

Alternatively, if scale model test data for a helicopter of a similar configuration has been previously successfully used to justify water entry behaviour, this data could form the basis for a comparative analytical approach.

(6) Flotation stability tests.

An acceptable means of flotation stability testing is contained in the [AMC to CS 29.801\(e\) and 29.802\(c\)](#). Note that model tests in a wave basin on a number of different rotorcraft types have indicated that an improvement in seakeeping performance can consistently be achieved by fitting float scoops.

(7) Occupant egress and survival.

The ability of the occupants to deploy life rafts, egress the rotorcraft, and board the life rafts (directly, in the case of passengers), should be evaluated. For configurations which are considered to have critical occupant egress capabilities due to the life raft locations or the ditching emergency exit locations and the proximity of the float (or a combination of both), an actual demonstration of egress may be required. When a demonstration is

required, it may be conducted on a full-scale rotorcraft actually immersed in a calm body of water or using any other rig or ground test facility shown to be representative. The demonstration should show that the floats do not impede a satisfactory evacuation. Service experience has shown that it is possible for occupants to have escaped from the cabin, but to have not been able to board a life raft and to have had difficulty in finding handholds to stay afloat and together. Handholds or lifelines should be provided on appropriate parts of the rotorcraft. The normal attitude of the rotorcraft and the possibility of capsizing should be considered when positioning the handholds or lifelines.

[Amdt No: 29/5]

AMC to CS 29.801(e) and 29.802(c) Model test method for flotation stability

ED Decision 2018/007/R

This AMC should be used when showing compliance with [CS 29.801\(e\)](#) or [CS 29.802\(c\)](#) as introduced at Amendment 5.

(a) Explanation

(1) Model test objectives

The objective of the model tests described in the certification specification is to establish the performance of the rotorcraft in terms of its stability in waves. The wave conditions in which the rotorcraft is to be certified should be selected according to the desired level of operability (see (a)(2) below).

This will enable the overall performance of the rotorcraft to be established for inclusion in the rotorcraft flight manual (RFM) as required by [CS 29.1587\(c\)](#). In the case of approval with ditching provisions, the wave conditions selected for substantiation of behaviour during the water entry phase must also be taken into account.

The rotorcraft design is to be tested, at each mass condition (see paragraph b(1)(ii) below), with its flotation system intact, and with its single most critical flotation compartment damaged (i.e. the single-puncture case which has the worst adverse effect on flotation stability).

(2) Model test wave conditions

The rotorcraft is to be tested in a single sea condition comprising a single combination of significant wave height (H_s) and zero-crossing period (T_z). The values of H_s and T_z should be no less than, and no more than, respectively, those chosen for certification, i.e. as selected from table 1. This approach is necessary in order to constrain the quantity of testing required within reasonable limits and is considered to be conservative. The justification is detailed in [Appendix 2](#).

The applicant is at liberty to certify the rotorcraft to any significant wave height H_s . This significant wave height will be noted as performance information in the RFM.

Using reliable wave climate data for an appropriate region of the ocean for the anticipated flight operations, a T_z is selected to accompany the H_s . This T_z should be typical of those occurring at H_s as determined in the wave scatter table for the region. The mode or median of the T_z distribution at H_s should be used.

It is considered that the northern North Sea represents a conservatively 'hostile' region of the ocean worldwide and should be adopted as the default wave climate for

certification. However, this does not preclude an applicant from certifying a rotorcraft specifically for a different region. Such a certification for a specific region would require the geographical limits of that certification region to be noted as performance information in the RFM. Certification for the default northern North Sea wave climate does not require any geographical limits.

In the case of an approval with emergency flotation provisions, operational limitations may limit flight to ‘non-hostile’ sea areas. For simplicity, the northern North Sea may still be selected as the wave climate for certification, or alternatively a wave climate derived from a non-hostile region’s data may be used. If the latter approach is chosen, and it is desired to avoid geographical limits, a ‘non-hostile’ default wave climate will need to be agreed with EASA.

Wave climate data for the northern North Sea were obtained from the United Kingdom Meteorological Office (UK Met Office) for a typical ‘hostile’ helicopter route. The route selected was from Aberdeen to Block 211/27 in the UK sector of the North Sea. Data tables were derived from a UK Met Office analysis of 34 years of 3-hourly wave data generated within an 8-km, resolved wave model hindcast for European waters. This data represents the default wave climate.

Table 1 below has been derived from this data and contains combinations of significant H_s and T_z . Table 1 also includes the probability of exceedance (P_e) of the H_s .

Table 1 — Northern North Sea wave climate

Spectrum shape: JONSWAP, peak enhancement factor $\gamma = 3.3$				
	Significant wave height H_s	Mean wave period T_z	Significant steepness $S_s = 2\pi H_s / (g T_z^2)$	H_s probability of exceedance P_e
Intact flotation system	6 m	7.9 s	1/16.2	1.2 %
	5.5 m	7.6 s	1/16.4	2 %
	5 m	7.3 s	1/16.6	3 %
	4.5 m	7.0 s	1/17.0	5 %
	4 m	6.7 s	1/17.5	8 %
	3.5 m	6.3 s	1/17.7	13 %
	3 m	5.9 s	1/18.1	20 %
	2.5 m	5.5 s	1/18.9	29 %
	2 m	5.1 s	1/20.3	43 %
	1.25 m	4.4 s	1/24.2	72 %

(3) Target probability of capsizing

Target probabilities of capsizing have been derived from a risk assessment. The target probabilities to be applied are stated in [CS 29.801\(e\)](#) and [29.802\(c\)](#), as applicable.

For ditching, the intact flotation system probability of capsizing of 3 % is derived from a historic ditching rate of 3.32×10^{-6} per flight hour and an AMC 29.1309 consequence of hazardous, which implies a frequency of capsizing of less than 10^{-7} per flight hour. The damaged flotation system probability of capsizing is increased by a factor of 10 to 30 % on the assumption that the probability of failure of the critical float compartment is 0.1; this probability has been estimated, as there is insufficient data on flotation system failure rates.

For emergency flotation equipment, an increase of half an order ($\sqrt{10}$) is allowed on the assumption of a reduced exposure to the risk, resulting in a probability of capsizing of 10 %. The probability of a capsizing with a damaged flotation system is consequently increased to 100 %, hence no test is required.

(4) Intact flotation system

For the case of an intact flotation system, if the northern North Sea default wave climate has been chosen for certification, the rotorcraft should be shown to resist capsize in a sea condition selected from Table 1. The probability of capsizing in a 5-minute exposure to the selected sea condition is to be demonstrated to be less than or equal to the value provided in [CS 29.801\(e\)](#) or [29.802\(c\)](#), as appropriate, with a confidence of 95 % or greater.

(5) Damaged flotation system

For the case of a damaged flotation compartment (see (1) above), the same sea condition may be used, but a 10-fold increased probability of capsizing is permitted. This is because it is assumed that flotation system damage will occur in approximately one out of ten emergency landings on water. Thus, the probability of capsizing in a 5-minute exposure to the sea condition is to be demonstrated to be less than or equal to 10 times the required probability for the intact flotation system case, with a confidence of 95 % or greater. Where a 10-times probability is equal to or greater than 100 %, it is not necessary to perform a model test to determine the capsize probability with a damaged flotation system.

Alternatively, the applicant may select a wave condition with 10 times the probability of exceedance P_e of the significant wave height (H_s) selected for the intact flotation condition. In this case, the probability of capsizing in a 5-minute exposure to the sea condition is to be demonstrated to be less than or equal to the required value (see [CS 29.801\(e\)](#) or [29.802\(c\)](#)), with a confidence of 95 % or greater.

(6) Long-crested waves

Whilst it is recognised that ocean waves are in general multidirectional (short-crested), the model tests are to be performed in unidirectional (long-crested) waves, this being regarded as a conservative approach to capsize probability.

(b) Procedures

(1) Rotorcraft model

(i) Construction and scale of the model

The rotorcraft model, including its emergency flotation, is to be constructed to be geometrically similar to the full-scale rotorcraft design at a scale that will permit the required wave conditions to be accurately represented in the model basin. It is recommended that the scale of the model should be not smaller than 1/15.

The construction of the model is to be sufficiently light to permit the model to be ballasted to achieve the desired weight and rotational inertias specified in the mass conditions (see (b)(1)(ii) below)¹.

¹ It should be noted that rotorcraft tend to have a high centre of gravity due to the position of the engines and gearbox on top of the cabin. It therefore follows that most of the ballast is likely to be required to be installed in these high locations of the model.

Where it is likely that water may flood into the internal spaces following an emergency landing on water, for example through doors opened to permit escape, or any other opening, the model should represent these internal spaces and openings as realistically as possible.

It is permissible to omit the main rotor(s) from the model, but its (their) mass is to be represented in the mass and inertia conditions¹.

(ii) Mass conditions

As it is unlikely that the most critical condition can be determined reliably prior to testing, the model is to be tested in two mass conditions:

- (A) maximum mass condition, mid C of G; and
- (B) minimum mass condition, mid C of G.

(iii) Mass properties

The model is to be ballasted in order to achieve the required scale weight, centre of gravity, roll and yaw inertia for each of the mass conditions to be tested.

Once ballasted, the model's floating draft and trim in calm water is to be checked and compared with the design floating attitude.

The required mass properties and floating draft and trim, and those measured during model preparation, are to be fully documented and compared in the report.

(iv) Model restraint system

The primary method of testing is with a restrained model, but an alternative option is for a free-floating model (See (3)(iii) below).

For the primary restrained method, a flexible restraint or mooring system is to be provided to restrain the model in order for it to remain beam-on to the waves in the model basin².

This restraint system should fulfil the following criteria:

- (A) be attached to the model on the centre line at the front and rear of the fuselage in such a position that roll motion coupling is minimised; an attachment at or near the waterline is preferred; and
- (B) be sufficiently flexible that the natural frequencies of the model surging/swaying on this restraint system are much lower than the lowest wave frequencies in the spectrum.

(v) Sea anchor

¹ Rotors touching the waves can promote capsizing, but they can also be a stabilising influence depending on the exact circumstances. Furthermore, rotor blades are often lost during ditching due to contact with the sea. It is therefore considered acceptable to omit them from the model.

² In general the model cannot be permitted to float freely in the basin because in the necessarily long wave test durations, the model would otherwise drift down the basin and out of the calibrated wave region. Constraining the model to remain beam-on to the waves and not float freely is regarded as a conservative approach to the capsizing test. A free-floating test is optional after a specific capsizing event, in order to investigate whether the restraint system contributed to the event. It may also be possible to perform a complete free-floating test campaign by combining many short exposures in a wave basin capable of demonstrating a large calibrated wave region.

Whether or not the rotorcraft is to be fitted with a sea anchor, such an anchor is not to be represented in these model tests¹.

(2) Test facility

The model test facility is to have the capability to generate realistic long non-repeating sequences of unidirectional (long-crested) irregular waves, as well as the characteristic wave condition at the chosen model scale. The facility is to be deep enough to ensure that the waves are not influenced by the depth (i.e. deep-water waves).

The dimensions of the test facility are to be sufficiently large to avoid any significant reflection/refraction effects influencing the behaviour of the rotorcraft model.

The facility is to be fitted with a high-quality wave-absorbing system or beach.

The model basin is to provide full details of the performance of the wave maker and the wave absorption system prior to testing.

(3) Model test set-up

(i) General

The model is to be installed in the wave facility in a location sufficiently distant from the wave maker, tank walls and beach/absorber such that the wave conditions are repeatable and not influenced by the boundaries.

The model is to be attached to the model restraint system (see (b)(1)(iv) above).

(ii) Instrumentation and visual records

During wave calibration tests, three wave elevation probes are to be installed and their outputs continuously recorded. These probes are to be installed at the intended model location, a few metres to the side and a few metres ahead of this location.

The wave probe at the model location is to be removed during tests with the rotorcraft model present.

All tests are to be continuously recorded on digital video. It is required that at least two simultaneous views of the model are to be recorded. One is to be in line with the model axis (i.e. viewing along the wave crests), and the other is to be a three-quarter view of the model from the up-wave direction. Video records are to incorporate a time code to facilitate synchronisation with the wave elevation records in order to permit the investigation of the circumstances and details of a particular capsizing event.

(iii) Wave conditions and calibration

Prior to the installation of the rotorcraft model in the test facility, the required wave conditions are to be pre-calibrated.

Wave elevation probes are to be installed at the model location, alongside and ahead of the intended model location.

¹ A sea anchor deployed from the rotorcraft nose is intended to improve stability by keeping the rotorcraft nose into the waves. However, such devices take a significant time to deploy and become effective, and so, their beneficial effect is to be ignored. The rotorcraft model will be restrained to remain beam-on to the waves.

The intended wave spectrum is to be run for the full exposure duration required to demonstrate the required probability of capsizing. The analysis of these wave calibration runs is to be used to:

- (A) confirm that the required wave spectrum has been obtained at the model location; and
- (B) verify that the wave spectrum does not deteriorate appreciably during the run in order to help establish the maximum duration test that can be run before the test facility must be allowed to become calm again.

It should be demonstrated that the wave spectrum measured at each of the three locations is the same.

If a free-floating model is to be used, then the waves are to be calibrated for a range of locations down the basin, and the spectrum measured in each of these locations should be shown to be the same. The length of the basin covered by this range will be the permitted test region for the free-floating model, and the model will be recovered when it drifts outside this region (See paragraph 4 below). It should be demonstrated that the time series of the waves measured at the model location does not repeat during the run. Furthermore, it should be demonstrated that one or more continuation runs can be performed using exactly the same wave spectrum and period, but with different wave time series. This is to permit a long exposure to the wave conditions to be built up from a number of separate runs without any unrealistic repetition of the time series.

No wind simulation is to be used¹.

(iv) Required wave run durations

The total duration of runs required to demonstrate that the required probability of capsizing has been achieved (or bettered) is dependent on that probability itself, and on the reliability or confidence of the capsize probability required to be demonstrated.

With the assumption that each 5-minute exposure to the wave conditions is independent, the equations provided in (b)(5) below can be used to determine the duration without a capsize that is required to demonstrate the required performance². (See [Appendix 1](#) below for examples.)

(4) Test execution and results

Tests are to start with the model at rest and the wave basin calm.

Following the start of the wave maker, sufficient time is to elapse to permit the slowest (highest-frequency) wave components to arrive at the model, before data recording starts.

Wave runs are to continue for the maximum permitted duration determined in the wave calibration test, or in the free-floating option for as long as the model remains in the calibrated wave region. Following sufficient time to allow the basin to become calm again,

¹ Wind generally has a tendency to redirect the rotorcraft nose into the wind/waves, thus reducing the likelihood of capsize. Therefore, this conservative testing approach does not include a wind simulation.

² Each 5-minute exposure might not be independent if, for example, there was flooding of the rotorcraft, progressively degrading its stability. However, in this context, it is considered that the assumption of independence is conservative.

additional runs are to be conducted until the necessary total exposure duration (T_{Test}) has been achieved (see (b)(5) below).

In the case of the free-floating option, the model may be recovered and relaunched without stopping the wave maker, provided that the maximum permitted duration has not been exceeded. See paragraph (4)(iv) for requirements regarding relaunching the free-floating model.

If and when a model capsize occurs, the time of the capsize from the start of the run is to be recorded, and the run stopped. The model is to be recovered, drained of any water, and reset in the basin for a continuation run to be performed.

There are a number of options that may be taken following a capsize event:

(i) Continuing with the same model configuration

If the test is to be continued with the same model configuration, the test can be restarted with a different wave time series, or continued from the point of capsizing in a pseudorandom time series.

(ii) Reducing the wave severity to achieve certification at a lower significant wave height.

Provided that the same basic pseudorandom wave time series can be reproduced by the wave basin at a lower wave height and corresponding period, it is permitted to restart the wave maker time series at a point at least 5 minutes prior to the capsize event, and if the model is now seen to survive the wave sequence that caused a capsize in the more severe condition, then credit can then be taken for the run duration successfully achieved prior to the capsize. Clearly, such a restart is only possible with a model basin using pseudorandom wave generation.

This method is only permitted if the change in significant wave height and period is sufficiently small that the same sequence of capsizing waves, albeit at a lower amplitude, can be seen in the wave basin. If this is not the case, then credit cannot be taken for the exposure time prior to capsize, and the wave time series must be restarted from the beginning.

(iii) Modifying the model with the intention of avoiding a capsize

If it is decided to modify the model flotation with the intention of demonstrating that the modified model does not capsize in the wave condition, then the pseudorandom wave maker time series should be restarted at a point at least 5 minutes prior to the capsize event so that the model is seen to survive the wave that caused a capsize prior to the modification. Credit can then be taken for the duration of the run successfully achieved prior to the capsize.

(iv) Repeating a restrained capsize event with a free-floating model

If it is suspected that the model restraint system might have contributed to the capsize, then it is permitted to repeat that part of the pseudorandom time series with a free-floating model. The model is to be temporally restrained with light lines and then released beam-on to the waves such that the free-floating model is seen to experience the same wave time series that caused a capsize in exactly the same position in the basin. It is accepted that it might require several attempts to find the precise model release time and position to achieve this.

If the free-floating, model having been launched beam-on to the waves, is seen to yaw into a more beneficial heading once released, and seen to survive the wave that caused a capsize in the restrained model, then this is accepted as negating the capsize seen with the restrained model.

The test may then continue with a restrained model as with (i) above.

- (v) Special considerations regarding relaunching a free-floating model into the calibrated wave region

If a free-floating model is being used for the tests, then it is accepted that the model will need to be recovered as it leaves the calibrated wave region, and then relaunched at the top of that region. It is essential that this process does not introduce any statistical or other bias into the behaviour of the model. For example, there might be a natural tendency to wait for a spell of calmer waves into which to launch the model. This particular bias is to be avoided by strictly obeying a fixed time delay between recovery and relaunch.

Any water accumulated inside the model is not to be drained prior to the relaunch.

If the model has taken up a heading to the waves that is not beam-on, then it is permissible to relaunch the model at that same heading.

In all the above cases continuation runs are to be performed until the total duration of exposure to the wave condition is sufficient to establish that the 5-minute probability of capsizing has been determined with the required confidence of 95 %.

- (5) Results analysis

Given that it has been demonstrated that the wave time series are non-repeating and statistically random, the results of the tests may be analysed on the assumption that each five-minute element of the total time series is independent.

If the model rotorcraft has not capsized during the total duration of the tests, the confidence that the probability of capsizing within 5 minutes is less than the target value of $P_{\text{capsize(target)}}$, as shown below:

$$C = 1 - (1 - P_{\text{capsize(target)}})^{\lceil T_{\text{test}}/T_{\text{criterion}} \rceil}$$

$$\approx 1 - \exp\left(-\frac{P_{\text{capsize(target)}}T_{\text{test}}}{T_{\text{criterion}}}\right)$$

and so the total duration of the model test required without capsize is provided by:

$$T_{\text{test}} \approx -\frac{T_{\text{criterion}} \ln(1 - C)}{P_{\text{capsize(target)}}$$

where:

- (A) T_{test} is the required full-scale duration of the test (in seconds);
- (B) $P_{\text{capsize(target)}}$ is the required maximum probability of capsizing within 5 minutes;
- (C) $T_{\text{criterion}}$ is the duration (in seconds) in which the rotorcraft must meet the no-capsize probability (= 5 x 60 s), as defined in [CS 29.801\(e\)](#); and

- (D) C is the required confidence that the probability of capsizing has been achieved (0.95).

If the rotorcraft has capsized N_{capsize} times during the tests, the probability of capsizing within 5 minutes can be estimated as:

$$P_{\text{capsize}} = \frac{N_{\text{capsize}} T_{\text{criterion}}}{T_{\text{test}}}$$

and the confidence that the required capsize criteria have been met is:

$$C = 1 - \sum_{k=0}^{N_{\text{capsize}}} \frac{([T_{\text{test}}/T_{\text{criterion}}])!}{([T_{\text{test}}/T_{\text{criterion}}] - k)!} \left\{ (P_{\text{capsize(target)}})^k (1 - P_{\text{capsize(target)}})^{([T_{\text{test}}/T_{\text{criterion}}] - k)} \right\}$$

$$\approx 1 - \left\{ \sum_{k=0}^{N_{\text{capsize}}} \frac{1}{k!} \left(\frac{P_{\text{capsize(target)}} T_{\text{test}}}{T_{\text{criterion}}} \right)^k \right\} \exp \left(- \frac{P_{\text{capsize}} T_{\text{test}}}{T_{\text{criterion}}} \right)$$

It should be noted that, if the rotorcraft is permitted to fly over sea conditions with significant wave heights above the certification limit, then $P_{\text{capsize(target)}}$ should be reduced by the probability of exceedance of the certification limit for the significant wave height (P_e) (see [Appendix 2](#) below).

(c) Deliverables

- (1) A comprehensive report describing the model tests, the facility they were performed in, the model properties, the wave conditions used, the results of the tests, and the method of analysis to demonstrate compliance with [CS 29.801\(d\) and \(e\)](#).
- (2) Conclusions in this report are to clarify the compliance (or otherwise) with those requirements.
- (3) Digital video and data records of all tests performed.
- (4) A specification for a certification model test should also be expected to include:
 - (i) an execution plan and time scale;
 - (ii) formal progress reports on content and frequency; and
 - (iii) quality assurance requirements.

[Amdt No: 29/5]

Appendix 1 — Worked example

ED Decision 2018/007/R

The target 5-minute capsizing probabilities for a rotorcraft certified to [CS 29.801](#) are:

Certification with ditching provisions;

Fully serviceable emergency flotation system (EFS)	- 3 %
Critical flotation compartment failed	- 30 %

Certification with emergency flotation provisions;

Fully serviceable emergency flotation system (EFS)	- 10 %
Critical flotation compartment failed	- no demonstration required

One option available to the rotorcraft designer is to test at the selected wave height and demonstrate a probability of capsizing no greater than these values. However, to enhance offshore helicopter safety, some national aviation authorities (NAAs) have imposed restrictions that prevent normal operations (i.e. excluding emergencies, search and rescue (SAR), etc.) over sea conditions that are more severe than those for which performance has been demonstrated. In such cases, the helicopter may be operationally limited.

These operational restrictions may be avoided by accounting for the probability of exposure to sea conditions that exceed the selected wave height by certifying the rotorcraft for a lower probability of capsizing. Since it is conservatively assumed that the probability of capsizing in sea conditions that exceed the certified wave height is unity, the lower capsizing probability required to be met is the target value minus the probability of the selected wave height being exceeded. However, it should also be noted that, in addition to restricting normal helicopter overwater operations to the demonstrated capability, i.e. the applicant's chosen significant wave height limit ($H_{s(\text{limit})}$), an NAA may declare a maximum limit above which all operations will be suspended due to the difficulty of rescuing persons from the sea in extreme conditions. There will, therefore, be no operational benefit in certifying a rotorcraft for sea conditions that exceed the national limits for rescue.

In the following examples, we shall use the three target probabilities of capsizing without any reduction to avoid operational restrictions. The test times quoted are full-scale times; to obtain the actual model test run time, these times should be divided by the square root of the model scale.

Certification with ditching provisions — fully serviceable EFS

Taking this first case, we need to demonstrate a $\leq 3\%$ probability of capsizing with a 95 % confidence. Applying equation (5)(i) above, this can be achieved with a 499-minute (full-scale time) exposure to the sea condition without a capsizing.

Rearranging this equation, we have:

$$T_{test} \approx -\ln(1 - C) \frac{T_{criterion}}{P_{capsize(target)}}$$

$$T_{test} \approx -\ln(1 - 0.95) \frac{5 \times 60}{0.03} = 29957 \text{ s} = 499 \text{ min}$$

Alternatively, applying equation (5)(ii) above, the criterion would also be met if the model were seen to capsize just three times (for example) in a total 21.5 hours of exposure to the sea condition, or four times (for example) in a total of 25.5 hours of exposure.

Equation (ii) cannot be readily rearranged to solve T_{test} , so the easiest way to solve it is by using a spreadsheet on a trial-and-error method. For the four-capsize case, we find that a 25.5-hour exposure gives a confidence of 0.95.

$$C \approx 1 - \left\{ \sum_{k=0}^{4_e} \frac{1}{k!} \left(\frac{0.03 \times 25.5 \times 60 \times 60}{5 \times 60} \right)^k \right\} \exp \left(- \frac{0.03 \times 25.5 \times 60 \times 60}{5 \times 60} \right) = 0.95$$

Certification with ditching provisions — critical flotation compartment failed

In this case, we need to demonstrate a $\leq 30\%$ probability of capsizing with a 95% confidence. This can be achieved with a 50-minute (full-scale time) exposure to the sea condition without a capsize.

$$T_{test} \approx -\ln(1 - 0.95) \frac{5 \times 60}{0.30} = 2996 \text{ s} = 50 \text{ min}$$

As above, the criterion would also be met if the model were seen to capsize just three times (for example) in a total 2.2 hours of exposure to the sea condition, or four times (for example) in a total of 2.6 hours of exposure.

Solving by trial and error in a spreadsheet, we find that a 2.6-hour exposure with no more than four capsizes gives a confidence of 0.95.

$$C \approx 1 - \left\{ \sum_{k=0}^{4_e} \frac{1}{k!} \left(\frac{0.30 \times 2.6 \times 60 \times 60}{5 \times 60} \right)^k \right\} \exp \left(- \frac{0.30 \times 2.6 \times 60 \times 60}{5 \times 60} \right) = 0.95$$

Certification with emergency flotation provisions — fully serviceable EFS

In this case, we need to demonstrate a $\leq 10\%$ probability of capsizing with a 95% confidence. By solving the equations as above, this can be achieved with a 150-minute (full-scale time) exposure to the sea condition without a capsize.

$$T_{test} \approx -\ln(1 - 0.95) \frac{5 \times 60}{0.10} = 8987 \text{ s} = 150 \text{ min}$$

As above, the criterion would also be met if the model were seen to capsize just three times (for example) in a total 6.5 hours of exposure to the sea condition, or four times (for example) in a total of 7.6 hours of exposure.

Solving by trial and error in a spreadsheet we find that a 7.6-hour exposure with no more than four capsizes gives a confidence of 0.95.

$$C \approx 1 - \left\{ \sum_{k=0}^{4_e} \frac{1}{k!} \left(\frac{0.10 \times 7.6 \times 60 \times 60}{5 \times 60} \right)^k \right\} \exp \left(- \frac{0.10 \times 7.6 \times 60 \times 60}{5 \times 60} \right) = 0.95$$

Certification with ditching provisions — critical flotation compartment failed

As stated in [CS 29.802\(c\)](#), no demonstration of capsize resistance is required for the case of the critical float compartment having failed.

This is because the allowed factor of ten increase in the probability of capsizing, as explained in (a)(3) above, results in a probability of 100 %.

[Amdt No: 29/5]

Appendix 2 — Test specification rationale

ED Decision 2018/007/R

(a) Introduction

The overall risk of capsizing within the 5-minute exposure period consists of two components: the probability of capsizing in a given wave condition, and the probability of experiencing that wave condition in an emergency landing on water.

If it is assumed that an emergency landing on water occurs at random and is not linked with weather conditions, the overall risk of a capsizing can be established by combining two pieces of information:

- (1) The wave climate scatter table, which shows the probability of meeting any particular combination of H_s and T_z . An example scatter table is shown below in **Figure 1 — Example of all-year wave scatter table**. Each cell of the table contains the probability of experiencing a wave condition with H_s and T_z in the range provided. Thus, the total of all cells in the table adds up to unity.
- (2) The probability of a capsizing in a 5-minute exposure for each of these height/period combinations. This probability of capsizing is different for each helicopter design and for each wave height/period combination, and is to be established through scale model testing using the method defined above.

In theory, a model test for the rotorcraft design should be performed in the full range of wave height/period combinations covering all the cells in the scatter table. Clearly, wave height/period combinations with zero or very low probabilities of occurrence might be ignored. It might also be justifiably assumed that the probability of a capsizing at very high wave heights is unity, and at very low wave heights, it is zero. However, there would still remain a very large number of intermediate wave height/period combinations that would need to be investigated in model tests, and it is considered that such a test programme would be too lengthy and costly to be practicable.

The objective here is therefore to establish a justifiable method of estimating the overall 5-minute capsizing probability using model test results for a single-wave condition. That is a single combination of H_s and T_z . Such a method can never be rigorously linked with the safety objective, but it is proposed that it may be regarded as a conservative approximation.

(b) Test methodology

The proposed test methodology is as follows:

The rotorcraft designer selects a desired significant wave height limit $H_{s(\text{limit})}$ for the certification of his helicopter. Model tests are performed in the sea condition $H_{s(\text{limit})}$.

$T_{z(\text{limit})}$ (where $T_{z(\text{limit})}$ is the zero-crossing period most likely to accompany $H_{s(\text{limit})}$) with the selected spectrum shape using the method specified above, and the 5-minute probability of capsizing (P_{capsize}) established in this sea condition.

The way in which P_{capsize} varies for other values of H_s and T_z is not known because it is not proposed to perform model tests in all the other possible combinations. Furthermore, there is no theoretical method to translate a probability of capsizing from one sea condition to another.

However, it is known that the probability of capsizing is related to the exposure to breaking waves of sufficient height, and that this is in turn linked with wave steepness. Hence:

CS 29.802 Emergency Flotation

ED Decision 2018/007/R

If operational rules allow, and only certification for emergency flotation equipment is requested by the applicant, the rotorcraft must be designed as follows;

- (a) The rotorcraft must be equipped with an approved emergency flotation system.
- (b) For a rotorcraft with a passenger seating capacity of 9 or less, the flotation units and their attachments to the rotorcraft must comply with [CS 29.563](#). For a rotorcraft with a passenger seating capacity of 10 or more, the rotorcraft must comply with [CS 29.563](#).
- (c) The rotorcraft must be shown to resist capsize in the sea conditions selected by the applicant. The probability of capsizing in a 5-minute exposure to the sea conditions must be demonstrated to be less than or equal to 10.0 % with a fully serviceable emergency flotation system, with 95 % confidence. No demonstration of capsize resistance is required for the case of the critical float compartment having failed.

Allowances must be made for probable structural damage and leakage.

- (d) It must be shown that the rotorcraft will not sink following the functional loss of any single complete flotation unit.

[Amdt No: 29/5]

AMC 29.802 Emergency Flotation

ED Decision 2018/007/R

This AMC replaces FAA AC 29 MG 10.

- (a) Definitions
 - (1) Ditching: a controlled emergency landing on water, deliberately executed in accordance with rotorcraft flight manual (RFM) procedures, with the intent of abandoning the rotorcraft as soon as practicable.

NOTE: Although the term ‘ditching’ is most commonly associated with the design standards related to [CS 29.801](#), a rotorcraft equipped to the less demanding requirements of [CS 29.802](#), when performing an emergency landing on water, would nevertheless be commonly described as carrying out the process of ditching. The term ‘ditching’ is therefore used in this AMC in this general sense.
 - (2) Emergency flotation system (EFS): a system of floats and any associated parts (e.g. gas cylinders, means of deployment, pipework and electrical connections) that is designed and installed on a rotorcraft to provide buoyancy and flotation stability in a ditching.
- (b) Explanation
 - (1) Approval of emergency flotation equipment is performed only if requested by the applicant. Operational rules may accept that a helicopter conducts flights over certain sea areas provided it is fitted with approved emergency flotation equipment (i.e. an EFS), rather than being certified with full ditching provisions.
 - (2) Emergency flotation certification encompasses emergency flotation system loads (as specified in [CS 29.802](#)) and design, and rotorcraft flotation stability.
 - (3) Failure of the EFS to operate when required will lead to the rotorcraft rapidly capsizing and sinking. Operational experience has shown that localised damage or failure of a single

component of an EFS can lead to the loss of the complete system. Therefore, the design of the EFS needs careful consideration.

- (4) The sea conditions on which certification with emergency flotation is to be based are selected by the applicant and should take into account the expected sea conditions in the intended areas of operation. Capsize resistance is required to meet the same requirements as for full ditching approval, but with the allowable capsize probability being set at 10 %. The default wave climate specified in this requirement is that of the northern North Sea, as it represents a conservative condition. This might be considered inappropriate in so far as it represents a hostile sea area. The applicant may therefore propose a different wave climate based on data from a non-hostile sea area. The associated certification will then be limited to the geographical region(s) thus represented. Alternatively, a non-hostile default wave climate might be agreed, with no associated need for geographical limits to the certification. The significant wave height, and any geographical limitations (if applicable, see the [AMC to 29.801\(e\) and 29.802\(c\)](#)) should be included in the RFM as performance information.
- (5) During scale model testing, appropriate allowances should be made for probable structural damage and leakage. Previous model tests and other data from rotorcraft of similar configurations that have already been substantiated based on equivalent test conditions may be used to satisfy the emergency flotation requirements. In regard to flotation stability, test conditions should be equivalent to those defined in the [AMC to 29.801\(e\) and 29.802\(c\)](#).
- (6) [CS 29.802](#) requires that in sea conditions for which certification with emergency flotation is requested by the applicant, the probability of capsizing in a 5-minute exposure is acceptably low in order to allow the occupants to leave the rotorcraft and enter the life rafts. This should be interpreted to mean that up to and including the worst-case sea conditions for which certification with emergency flotation is requested by the applicant, the probability that the rotorcraft will capsize should be not higher than the target stated in [CS 29.802\(c\)](#). An acceptable means of demonstrating post-ditching flotation stability is through scale model testing using irregular waves. The [AMC to 29.801\(e\) and 29.802\(c\)](#) contains a test specification that has been developed for this purpose.
- (7) Providing a 'wet floor' concept (water in the cabin) by positioning the floats higher on the fuselage sides and allowing the rotorcraft to float lower in the water can be a way of increasing the stability of a ditched rotorcraft (although this would need to be verified for the individual rotorcraft type for all weight and loading conditions), or it may be desirable for other reasons. This is permissible provided that the mean static level of water in the cabin is limited to being lower than the upper surface of the seat cushion (for all rotorcraft mass and centre of gravity cases, with all flotation units intact), and that the presence of water will not unduly restrict the ability of occupants to evacuate the rotorcraft and enter the life raft.
- (8) The sea conditions approved for ditching should be stated in the performance information section of the RFM.
- (9) It should be shown by analysis or other means that the rotorcraft will not sink following the functional loss of any single complete ditching flotation unit. Experience has shown that in water-impact events, the forces exerted on the emergency flotation unit that first comes into contact with the water surface, together with structural deformation and other damage, can render the unit unusable. Maintenance errors may also lead to a flotation unit failing to inflate. The ability of occupants to egress successfully is

significantly increased if the rotorcraft does not sink. However, this requirement is not intended for any other purpose, such as aiding in the salvage of the rotorcraft. Therefore, consideration of the remaining flotation units remaining inflated for an especially long period, i.e. longer than required in the upright floating case, is not required.

(c) Procedures

(1) Flotation system design

- (i) Structural integrity should be established in accordance with [CS 29.563](#). For a rotorcraft with a seating capacity of maximum 9 passengers, [CS 29.802\(a\)](#) only requires the floats and their attachments to the rotorcraft to be designed to withstand the load conditions defined in [CS 29.563](#). Other parts of the rotorcraft (e.g. fuselage underside structure, chin windows, doors) do not need to be shown to be capable of withstanding these load conditions. All parts of rotorcraft with a seating capacity of 10 passengers or more should be designed to withstand the load conditions defined in [CS 29.563](#) (i.e. the same design standards as for full ditching approval).
- (ii) Rotorcraft handling qualities should be verified to comply with the applicable certification specifications throughout the approved flight envelope with floats installed. Where floats are normally deflated and deployed in flight, the handling qualities should be verified for the approved operating envelopes with the floats in:
 - (A) the deflated and stowed condition;
 - (B) the fully inflated condition; and
 - (C) the in-flight inflation condition; for float systems which may be inflated in flight, rotorcraft controllability should be verified by test or analysis taking into account all possible emergency flotation system inflation failures.
- (iii) Reliability should be considered in the basic design to assure approximately equal inflation of the floats to preclude excessive yaw, roll, or pitch in flight or in the water:
 - (A) Maintenance procedures should not degrade the flotation system (e.g. introducing contaminants that could affect normal operation, etc.).
 - (B) The flotation system design should preclude inadvertent damage due to normal personnel traffic flow and wear and tear. Protection covers should be evaluated for function and reliability.
 - (C) The designs of the floats should provide means to minimise the likelihood of damage or tear propagation between compartments. Single compartment float designs should be avoided.
- (iv) The floats should be fabricated from highly conspicuous material to assist in locating the rotorcraft following a ditching (and possible capsizing).

(2) Flotation system inflation

Emergency flotation systems (EFSs) which are normally stowed in a deflated condition and are inflated either in flight or after water contact should be evaluated as follows:

- (i) The emergency flotation system should include a means to verify system integrity prior to each flight.

- (ii) If a manual means of inflation is provided, the float activation switch should be located on one of the primary flight controls and should be safeguarded against inadvertent actuation.
- (iii) The maximum airspeeds for intentional in-flight actuation of the emergency flotation system and for flight with the floats inflated should be established as limitations in the RFM unless in-flight actuation is prohibited by the RFM.
- (iv) Activation of the emergency flotation system upon water entry (irrespective of whether or not inflation prior to water entry is the intended operation mode) should result in an inflation time short enough to prevent the rotorcraft from becoming excessively submerged.
- (v) A means should be provided for checking the pressure of the gas stowage cylinders prior to take-off. A table of acceptable gas cylinder pressure variation with ambient temperature and altitude (if applicable) should be provided.
- (vi) A means should be provided to minimise the possibility of over-inflation of the flotation units under any reasonably probable actuation conditions.
- (vii) The ability of the floats to inflate without puncturing when subjected to actual water pressures should be substantiated. A demonstration of a full-scale float immersion in a calm body of water is one acceptable method of substantiation. Precautions should also be taken to avoid floats being punctured due to the proximity of sharp objects, during inflation in flight or with the helicopter in the water, and during subsequent movement of the helicopter in waves. Examples of objects that need to be considered are aerials, probes, overboard vents, unprotected split-pin tails, guttering and any projections sharper than a three dimensional right angled corner.
- (viii) [CS 29.802\(d\)](#) requires the rotorcraft to not sink following the functional loss of any complete flotation unit. Complete flotation unit shall be taken to mean a discrete, independently located float. The qualifying term 'complete' means that the entire structure of the flotation unit must be considered, not limited to any segregated compartments.

The loss of function of a flotation unit is most likely to be due to damage that occurs in a water impact. However, there may be other reasons, such as undetected damage during maintenance, or incorrect maintenance. All reasonably probable causes for the loss of functionality of a flotation unit, and the resultant effect(s) on the remainder of the inflation system, should therefore be taken into account.

In the case of inflatable flotation units, irrespective of whether the intended operation is to deploy the system before or after water entry, the following shall be taken into account when assessing the ability of the rotorcraft to remain afloat;

- Following the functional loss of a deployed flotation unit, the capability to maintain pressure in the remaining inflation units should be justified on the basis of the design of the inflation system, for example:
 - individual inflation gas sources per flotation unit;
 - installation of non-return valves at appropriate locations.
- Following the functional loss of a non-deployed flotation unit, the capability of the remaining flotation units to deploy should be justified on the basis of the design of the inflation system, for example:

- functionality of inflation gas sources integrated with the functionally lost flotation unit in question should also either be assumed to be lost, or justification for otherwise provided;
 - the degree of inflation of remaining undamaged flotation units, which share parts of the inflation system with the damaged unit, bearing in mind the damaged unit will be venting, should be determined.
- (3) Injury prevention during and following water entry.

An assessment of the cabin and cockpit layouts should be undertaken to minimise the potential for injury to occupants in a ditching. This may be performed as part of the compliance with [CS 29.785](#). Attention should be given to the avoidance of injuries due to leg/arm flailing, as these can be a significant impediment to occupant egress and subsequent survivability. Practical steps that could be taken include:

- (i) locating potentially hazardous items away from the occupants;
- (ii) installing energy-absorbing padding onto interior components;
- (iii) using frangible materials; and
- (iv) designs that exclude hard or sharp edges.

- (4) Water entry procedures.

Tests or simulations (or a combination of both) should be conducted to establish procedures and techniques to be used for water entry. These tests/simulations should include determination of the optimum pitch attitude and forward velocity for ditching in a calm sea, as well as entry procedures for the most severe sea condition to be certified. Procedures for all failure conditions that may lead to a 'land immediately' action (e.g. one engine inoperative, all engines inoperative, tail rotor/drive failure) should be established.

- (5) Flotation stability tests.

An acceptable means of flotation stability testing is contained in [AMC to 29.801\(e\) and 29.802\(c\)](#). Note that model tests in a wave basin on a number of different rotorcraft types have indicated that an improvement in seakeeping performance can consistently be achieved by fitting float scoops.

- (6) Occupant egress and survival.

The ability of the occupants to deploy life rafts, egress the rotorcraft, and board the life rafts should be evaluated. For configurations which are considered to have critical occupant egress capabilities due to the life raft locations or the emergency exit locations and proximity of the float (or a combination of both), an actual demonstration of egress may be required. When a demonstration is required, it may be conducted on a full-scale rotorcraft actually immersed in a calm body of water or using any other rig or ground test facility shown to be representative. The demonstration should show that floats do not impede a satisfactory evacuation. Service experience has shown that it is possible for occupants to have escaped from the cabin but to have not been able to board a life raft and to have had difficulty in finding handholds to stay afloat and together. Handholds or lifelines should be provided on appropriate parts of the rotorcraft. The normal attitude of the rotorcraft and the possibility of a capsize should be considered when positioning the handholds or lifelines.

[Amdt No: 29/5]

CS 29.803 Emergency evacuation

ED Decision 2018/007/R

- (a) Each crew and passenger area must have means for rapid evacuation in a crash landing, with the landing gear:
- (1) extended; and
 - (2) retracted;
- considering the possibility of fire.
- (b) Passenger entrance, crew, and service doors may be considered as emergency exits if they meet the requirements of this paragraph and of [CS 29.805](#) to [29.815](#).
- (c) If certification with ditching provisions is requested by the applicant:
- (1) ditching emergency exits must be provided such that following a ditching, in all sea conditions for which ditching capability is requested by the applicant, passengers are able to evacuate the rotorcraft and step directly into any of the required life rafts;
 - (2) any exit provided for compliance with (1), irrespective of whether it is also required by any of the requirements of [CS 29.807](#), must meet all the requirements of [CS 29.809\(c\)](#), [CS 29.811\(a\)](#), (c), (d), (e) and [CS 29.812\(b\)](#); and
 - (3) flotation devices, whether stowed or deployed, may not interfere with or obstruct the ditching emergency exits.
- (d) Except as provided in sub-paragraph (e), the following categories of rotorcraft must be tested in accordance with the requirements of [Appendix D](#) to demonstrate that the maximum seating capacity, including the crew-members required by the operating rules, can be evacuated from the rotorcraft to the ground within 90 seconds:
- (1) Rotorcraft with a seating capacity of more than 44 passengers.
 - (2) Rotorcraft with all of the following:
 - (i) Ten or more passengers per passenger exit as determined under [CS 29.807\(b\)](#).
 - (ii) No main aisle, as described in [CS 29.815](#), for each row of passenger seats.
 - (iii) Access to each passenger exit for each passenger by virtue of design features of seats, such as folding or break-over seat backs or folding seats.
- (e) A combination of analysis and tests may be used to show that the rotorcraft is capable of being evacuated within 90 seconds under the conditions specified in [CS 29.803\(d\)](#) if the Agency finds that the combination of analysis and tests will provide data, with respect to the emergency evacuation capability of the rotorcraft, equivalent to that which would be obtained by actual demonstration.

[Amdt No: 29/5]

Appendix D – Criteria for demonstration of emergency evacuation procedures under CS 29.803

ED Decision 2003/16/RM

- (a) The demonstration must be conducted either during the dark of the night or during daylight with the dark of night simulated. If the demonstration is conducted indoors during daylight hours, it must be conducted inside a darkened hangar having doors and windows covered. In addition, the doors and windows of the rotorcraft must be covered if the hangar illumination exceeds that of a moonless night. Illumination on the floor or ground may be used, but it must be kept low and shielded against shining into the rotorcraft's windows or doors.
- (b) The rotorcraft must be in a normal attitude with landing gear extended.
- (c) Safety equipment such as mats or inverted liferafts may be placed on the floor or ground to protect participants. No other equipment that is not part of the rotorcraft's emergency evacuation equipment may be used to aid the participants in reaching the ground.
- (d) Except as provided in paragraph (a), only the rotorcraft's emergency lighting system may provide illumination.
- (e) All emergency equipment required for the planned operation of the rotorcraft must be installed.
- (f) Each external door and exit and each internal door or curtain must be in the take-off configuration.
- (g) Each crewmember must be seated in the normally assigned seat for take-off and must remain in that seat until receiving the signal for commencement of the demonstration. For compliance with this paragraph, each crewmember must be:
 - (1) A member of a regularly scheduled line crew; or
 - (2) A person having knowledge of the operation of exits and emergency equipment.
- (h) A representative passenger load of persons in normal health must be used as follows:
 - (1) At least 25% must be over 50 years of age, with at least 40% of these being females.
 - (2) The remaining 75% or less, must be 50 years of age or younger, with at least 30% of these being females.
 - (3) Three life-size dolls, not included as part of the total passenger load, must be carried by passengers to simulate live infants 2 years old or younger, except for a total passenger load of fewer than 44 but more than 19, one doll must be carried. A doll is not required for a 19 or fewer passenger load.
 - (4) Crewmembers, mechanics, and training personnel who maintain or operate the rotorcraft in the normal course of their duties may not be used as passengers.
- (i) No passenger may be assigned a specific seat except as the Agency may require. Except as required by paragraph (g), no employee of the applicant may be seated next to an emergency exit, except as allowed by the Agency.
- (j) Seat belts and shoulder harnesses (as required) must be fastened.
- (k) Before the start of the demonstration, approximately one-half of the total average amount of carry-on baggage, blankets, pillows and other similar articles must be distributed at several locations in the aisles and emergency exit access ways to create minor obstructions.

- (l) No prior indication may be given to any crewmember or passenger of the particular exits to be used in the demonstration.
- (m) There must not be any practising, rehearsing or description of the demonstration for the participants nor may any participant have taken part in this type of demonstration within the preceding 6 months.
- (n) A pre-take-off passenger briefing may be given. The passengers may also be advised to follow directions of crewmembers, but not be instructed on the procedures to be followed in the demonstration.
- (o) If safety equipment, as allowed by paragraph (c), is provided, either all passenger and cockpit windows must be blacked out or all emergency exits must have safety equipment to prevent disclosure of the available emergency exits.
- (p) Not more than 50% of the emergency exits in the sides of the fuselage of a rotorcraft that meet all of the requirements applicable to the required emergency exits for that rotorcraft may be used for demonstration. Exits that are not to be used for the demonstration must have the exit handle deactivated or must be indicated by red lights, red tape, or other acceptable means placed outside the exits to indicate fire or other reasons why they are unusable. The exits to be used must be representative of all the emergency exits on the rotorcraft and must be designated subject to approval by the Agency. If installed, at least one floor level exit (Type I; [CS 29.807\(a\)\(1\)](#)) must be used as required by [CS 29.807\(c\)](#).
- (q) All evacuees must leave the rotorcraft by a means provided as part of the rotorcraft's equipment.
- (r) Approved procedures must be fully utilised during the demonstration.
- (s) The evacuation time period is completed when the last occupant has evacuated the rotorcraft and is on the ground.

AMC 29.803(c) Emergency evacuation

ED Decision 2018/007/R

This AMC supplements FAA AC 29.803 and AC 29.803A.

(a) Explanation

At Amendment 5, the usage of the term 'ditching emergency exit' was changed.

[CS 29.803\(c\)](#) was created with the intention that the rotorcraft design will allow all passengers to egress the rotorcraft and enter a life raft without undue effort or skill, and with a very low risk of falling and entering the water surrounding of the ditched rotorcraft. Boarding a life raft from the water is difficult, even in ideal conditions, and survival time is significantly increased once aboard a life raft, particularly if the survivor has remained at least partly dry. [CS 29.803\(c\)](#) requires that ditching emergency exits be provided to facilitate boarding into each of the required life rafts.

(b) Procedures

- (1) The general arrangement of most rotorcraft and the location of the deployed life rafts may be such that the normal entry/egress doors will best facilitate entry to a life raft. It should also be substantiated that the life rafts can be restrained in a position that allows passengers to step directly from the cabin into the life rafts. This is expected to require provisions to enable a cabin occupant to pull the deployed life raft to the exit, using the retaining line, and maintain it in that position while others board.

- (2) It is not considered disadvantageous if opening the normal entry/egress doors will result in water entering the cabin provided that the depth of water would not be such as to hinder evacuation. However, it should be substantiated that water pressure on the door will not excessively increase operating loads.
- (3) If exits such as normal entry/egress doors, which are not already being used to meet the requirements for emergency exits or underwater emergency exits (or both), are used for compliance with [CS 29.803\(c\)\(1\)](#), they should be designed to meet certain of the standards applied to emergency exits. Their means of opening should be simple and obvious and not require exceptional effort (see [CS 29.809\(c\)](#)), their means of access and opening should be conspicuously marked, including in the dark (see [CS 29.811\(a\)](#)), their location should be indicated by signs (see CS 29.811(c) and (d)), and their operating handles should be clearly marked (see CS 29.811(e)).

[Amdt No: 29/5]

CS 29.805 Flight crew emergency exits

ED Decision 2018/007/R

- (a) For rotorcraft with passenger emergency exits that are not convenient to the flight crew, there must be flight crew emergency exits, on both sides of the rotorcraft or as a top hatch, in the flight crew area.
- (b) Each flight crew emergency exit must be of sufficient size and must be located so as to allow rapid evacuation of the flight crew. This must be shown by test.
- (c) *Underwater emergency exits for flight crew.* If certification with ditching provisions is requested by the applicant, none of the flight crew emergency exits required by (a) and (b) may be obstructed by water or flotation devices after a ditching and each exit must be shown by test, demonstration, or analysis to provide for rapid escape when the rotorcraft is in the upright floating position or capsized. Each operational device (pull tab(s), operating handle, 'push here' decal, etc.) must be shown to be accessible for the range of flight crew heights as required by [CS 29.777\(b\)](#) and for both the case of an un-deformed seat and a seat with any deformation resulting from the test conditions required by [CS 29.562](#).

[Amdt No: 29/5]

AMC 29.805(c) Flight crew emergency exits

ED Decision 2018/007/R

This AMC supplements FAA AC 29.805 and replaces AC 29.805A.

- (a) Explanation

To facilitate a rapid escape, flight crew underwater emergency exits should be designed for use with the rotorcraft in both the upright position and in any foreseeable floating attitude. The flight crew underwater emergency exits should not be obstructed during their operation by water or floats to the extent that rapid escape would not be possible or that damage to the flotation system may occur. This should be substantiated for any rotorcraft floating attitude, upright or capsized, and with the emergency flotation system intact and with any single compartment failed. With the rotorcraft capsized and floating, the flight crew emergency exits should be usable with the cabin flooded.

(b) Procedures

- (1) It should be shown by test, demonstration or analysis that there is no interference with the flight crew underwater emergency exits from water or from any stowed or deployed emergency flotation devices, with the rotorcraft in any foreseeable floating attitude.
- (2) Flight crew should be able to reach the operating device for their underwater emergency exit, whilst seated, with restraints fastened, with seat energy absorption features at any design position, and with the rotorcraft in any attitude.
- (3) Likely damage sustained during a ditching should be considered.
- (4) It is acceptable for the underwater emergency exit threshold to be below the waterline when the rotorcraft is floating upright, but in such a case, it should be substantiated that there is no obstruction to the use of the exit and that no excessive force (see FAA AC 29.809) is required to operate the exit.
- (5) It is permissible for flight crew to be unable to directly enter life rafts from the flight crew underwater emergency exits and to have to take a more indirect route, e.g. by climbing over a forward flotation unit. In such a case, the feasibility of the exit procedure should be assessed. Handholds may need to be provided on the rotorcraft.
- (6) To make it easier to recognise underwater, the operating device for the underwater emergency exit should have black and yellow markings with at least two bands of each colour of approximately equal widths. Any other operating feature, e.g. highlighted 'push here' decal(s) for openable windows, should also incorporate black-and-yellow-striped markings.

[Amdt No: 29/5]

CS 29.807 Passenger emergency exits

ED Decision 2018/007/R

- (a) *Type.* For the purpose of this CS-29, the types of passenger emergency exit are as follows:
- (1) *Type I.* This type must have a rectangular opening of not less than 0.61 m wide by 1.22 m (24 inches wide by 48 inches) high, with corner radii not greater than one-third the width of the exit, in the passenger area in the side of the fuselage at floor level and as far away as practicable from areas that might become potential fire hazards in a crash.
 - (2) *Type II.* This type is the same as Type I, except that the opening must be at least 0.51 m wide by 1.12 m (20 inches wide by 44 inches) high.
 - (3) *Type III.* This type is the same as Type I, except that:
 - (i) The opening must be at least 0.51 m wide by 0.91 m (20 inches wide by 36 inches) high; and
 - (ii) The exits need not be at floor level.
 - (4) *Type IV.* This type must have a rectangular opening of not less than 0.48 m wide by 0.66 m (19 inches wide by 26 inches) high, with corner radii not greater than one-third the width of the exit, in the side of the fuselage with a step-up inside the rotorcraft of not more than 0.74 m (29 inches).
- Openings with dimensions larger than those specified in this paragraph may be used, regardless of shape, if the base of the opening has a flat surface of not less than the specified width.

- (b) *Passenger emergency exits: side-of fuselage.* Emergency exits must be accessible to the passengers and, except as provided in sub-paragraph (d), must be provided in accordance with the following table:

Passenger seating capacity	Emergency exits for each side of the fuselage			
	(Type I)	(Type II)	(Type III)	(Type IV)
1 to 10				1
11 to 19			1 or	2
20 to 39		1		1
40 to 59	1			1
60 to 79	1		1 or	2

- (c) *Passenger emergency exits; other than side of-fuselage.* In addition to the requirements of subparagraph (b):
- (1) There must be enough openings in the top, bottom, or ends of the fuselage to allow evacuation with the rotorcraft on its side; or
 - (2) The probability of the rotorcraft coming to rest on its side in a crash landing must be extremely remote.
- (d) *Underwater emergency exits for passengers.* If certification with ditching provisions is requested by the applicant, underwater emergency exits must be provided in accordance with the following requirements and must be proven by test, demonstration, or analysis to provide for rapid escape with the rotorcraft in the upright floating position or capsized.
- (1) One underwater emergency exit in each side of the rotorcraft, meeting at least the dimensions of a Type IV exit for each unit (or part of a unit) of four passenger seats. However, the passenger seat-to-exit ratio may be increased for exits large enough to permit the simultaneous egress of two passengers side by side.
 - (2) Flotation devices, whether stowed or deployed, may not interfere with or obstruct the underwater emergency exits.
- (e) *Ramp exits.* One Type I exit only, or one Type II exit only, that is required in the side of the fuselage under subparagraph (b), may be installed instead in the ramp of floor ramp rotorcraft if:
- (1) Its installation in the side of the fuselage is impractical; and
 - (2) Its installation in the ramp meets [CS 29.813](#).
- (f) *Tests.* The proper functioning of each emergency exit must be shown by test.

[Amdt No: 29/5]

AMC 29.807(d) Underwater emergency exits for passengers

ED Decision 2018/007/R

This AMC replaces FAA AC 29.807 and AC 29.807A.

(a) Explanation

CS-29 Amendment 5 re-evaluates the need for and the concept behind emergency exits for rotorcraft approved with ditching provisions. Prior to CS-29 Amendment 5, rotorcraft that had a passenger seating configuration, excluding pilots' seats, of nine seats or less were required to have one emergency exit above the waterline in each side of the rotorcraft, having at least the dimensions of a Type IV exit. For rotorcraft that had a passenger seating configuration, excluding pilots' seats, of 10 seats or more, one emergency exit was required to be located above the waterline in one side of the rotorcraft and to have at least the dimensions of a Type III exit, for each unit (or part of a unit) of 35 passenger seats, but no less than two such exits in the passenger cabin, with one on each side of the rotorcraft. These exits were referred to as 'ditching emergency exits'.

Operational experience has shown that in a ditching in which the rotorcraft remains upright, use of the passenger doors can be very beneficial in ensuring a rapid and orderly evacuation onto the life raft(s). However, when a rotorcraft capsizes, doors may be unusable and the number and availability of emergency exits that can be readily used underwater will be crucial to ensuring that passengers are able to escape in a timely manner. Experience has shown that the number of emergency exits required in the past by design requirements has been inadequate in a capsized situation, and a common design solution has been to use the passenger cabin windows as additional emergency egress means by including a jettison feature. The jettison feature has commonly been provided by modifying the elastomeric window seal such that its retention strength is either reduced, or can be reduced by providing a removable part of its cross section, i.e. the so called 'push out' window, although other design solutions have been employed. The provision of openable windows has been required by some air operations regulations.

In recognition of this identified need for an increased number of exits for underwater escape, Amendment 5 created a new set of exit terminology and [CS 29.807\(d\)\(1\)](#) was revised to require one pair of 'underwater emergency exits', i.e. one on each side of the rotorcraft, to be provided for each unit, or part of a unit, of four passenger seats.

This new terminology was seen as better describing the real intent of this higher number of required emergency exits for rotorcraft approved with ditching provisions.

Furthermore, [CS 29.813\(d\)\(1\)](#) requires passenger seats to be located relative to these exits in a way that best facilitates escape. The objective is for no passenger to be in a worse position than the second person to egress through an exit. The size of each underwater emergency exit should at least have the dimensions of a Type IV exit (0.48 m x 0.66 m or 19 in. x 26 in.).

The term 'ditching emergency exit' is retained for the exits required by the newly created [CS 29.803\(c\)](#). These exits are required to enable passengers to step directly into the life rafts when the rotorcraft remains upright. This is the normally expected case in a ditching and thus it is considered that this term is appropriate to describe these exits.

It is intended that training and briefing materials for passengers carried on helicopters that meet these new requirements will be designed to reflect the two types of emergency exits (ditching and underwater emergency exits) and the two associated scenarios that are assumed for their intended use (directly boarding a life raft from an upright helicopter following ditching, and immediate underwater escape should the helicopter capsize, respectively).

- (b) Procedures
- (1) The number and the size of underwater emergency exits should be as specified in paragraph (a) above.
 - (2) Care should be taken regarding oversized exits to avoid them becoming blocked if more than one passenger attempts to use the same exit simultaneously.
 - (3) A higher seat-to-exit ratio may be accepted if the exits are large enough to allow the simultaneous escape of more than one passenger. For example, a pair of exits may be approved for eight passengers if the size of each exit provides an unobstructed area that encompasses two ellipses of 0.48 m x 0.66 m (19 in. x 26 in.) side by side.
 - (4) Test, demonstration, compliance inspection, or analysis is required to substantiate that an exit is free from interference from stowed or deployed emergency flotation devices. In the event that an analysis or inspection is insufficient or that a given design is questionable, a test or demonstration may be required. Such a test or demonstration would consist of an accurate, full-size replica (or true representation) of the rotorcraft and its flotation devices, both while stowed and after their deployment.
 - (5) The cabin layout should be designed so that the seats are located relative to the underwater emergency exits in compliance with [CS 29.813\(d\)\(1\)](#).

[Amdt No: 29/5]

CS 29.809 Emergency exit arrangement

ED Decision 2018/007/R

- (a) Each emergency exit must consist of a door, openable window, or hatch in the external walls of the fuselage and must provide an unobstructed opening to the outside.
- (b) Each emergency exit must be openable from the inside and from the outside.
- (c) The means of opening each emergency exit must be simple and obvious and may not require exceptional effort.
- (d) There must be means for locking each emergency exit and for preventing opening in flight inadvertently or as a result of mechanical failure.
- (e) There must be means to minimise the probability of the jamming of any emergency exit in a minor crash landing as a result of fuselage deformation under the ultimate inertial forces in [CS 29.783\(d\)](#).
- (f) Except as provided in sub-paragraph (h), each land-based rotorcraft emergency exit must have an approved slide as stated in sub-paragraph (g), or its equivalent, to assist occupants in descending to the ground from each floor level exit and an approved rope, or its equivalent, for all other exits, if the exit threshold is more than 1.8 m (6 ft) above the ground:
 - (1) With the rotorcraft on the ground and with the landing gear extended;
 - (2) With one or more legs or part of the landing gear collapsed, broken, or not extended; and
 - (3) With the rotorcraft resting on its side, if required by [CS 29.803\(d\)](#).
- (g) The slide for each passenger emergency exit must be a self-supporting slide or equivalent, and must be designed to meet the following requirements:
 - (1) It must be automatically deployed, and deployment must begin during the interval between the time the exit opening means is actuated from inside the rotorcraft and the

time the exit is fully opened. However, each passenger emergency exit which is also a passenger entrance door or a service door must be provided with means to prevent deployment of the slide when the exit is opened from either the inside or the outside under non-emergency conditions for normal use.

- (2) It must be automatically erected within 10 seconds after deployment is begun.
 - (3) It must be of such length after full deployment that the lower end is self-supporting on the ground and provides safe evacuation of occupants to the ground after collapse of one or more legs or part of the landing gear.
 - (4) It must have the capability, in 12.9 m/s (25-knot) winds directed from the most critical angle, to deploy and, with the assistance of only one person, to remain usable after full deployment to evacuate occupants safely to the ground.
 - (5) Each slide installation must be qualified by five consecutive deployment and inflation tests conducted (per exit) without failure, and at least three tests of each such five-test series must be conducted using a single representative sample of the device. The sample devices must be deployed and inflated by the system's primary means after being subjected to the inertia forces specified in [CS 29.561\(b\)](#). If any part of the system fails or does not function properly during the required tests, the cause of the failure or malfunction must be corrected by positive means and after that, the full series of five consecutive deployment and inflation tests must be conducted without failure.
- (h) For rotorcraft having 30 or fewer passenger seats and having an exit threshold of more than 1.8 m (6 ft) above the ground, a rope or other assist means may be used in place of the slide specified in sub-paragraph (f), provided an evacuation demonstration is accomplished as prescribed in [CS 29.803\(d\) or \(e\)](#).
- (i) If a rope, with its attachment, is used for compliance with sub-paragraph (f), (g) or (h), it must -
- (1) Withstand a 182 kg (400-pound) static load; and
 - (2) Attach to the fuselage structure at or above the top of the emergency exit opening, or at another approved location if the stowed rope would reduce the pilot's view in flight.
- (j) If certification with ditching provisions is requested by the applicant, each underwater emergency exit must meet the following:
- (1) means of operation, markings, lighting and accessibility, must be designed for use in a flooded and capsized cabin;
 - (2) it must be possible for each passenger to egress the rotorcraft via the nearest underwater emergency exit, when capsized, with any door in the open and secured position; and
 - (3) a suitable handhold, or handholds, adjacently located inside the cabin to assist passengers in locating and operating the exit, as well as in egressing from the exit, must be provided.

[Amdt No: 29/5]

AMC 29.809 Emergency exit arrangement

ED Decision 2018/007/R

This AMC supplements FAA AC 29.809 and AC 29.809A.

(a) Explanation

[CS 29.809](#) covers all types of emergency exit. These may be a door, openable window or hatch. These terms are used to cover the three generic types expected. The term door implies a floor level, or close to floor level, opening. Openable window is self-explanatory, and hatch is used for any other configuration, irrespective of its location or orientation, e.g. located in the cabin ceiling, side wall or floor.

CS-29 Amendment 5 added a new requirement (j) to [CS 29.809](#) related to the design, installation and operation of underwater emergency exits. Underwater emergency exits should be optimised for use with the rotorcraft capsized and flooded.

So-called 'push-out' windows (see [AMC 29.807\(d\)](#)) have some advantages in that they are not susceptible to jamming and may open by themselves in a water impact due to flexing of the fuselage upon water entry and/or external water pressure.

Openable windows might require an appreciable pushing force from the occupant. When floating free inside a flooded cabin, and perhaps even if still seated, generation of this force may be difficult. An appropriately positioned handhold or handholds adjacent to the underwater emergency exit(s) should be provided to facilitate an occupant in generating the opening force. Additionally, in the design of the handhold, consideration should be given to it assisting in locating the underwater emergency exit and in enabling buoyancy forces to be overcome during egress.

Consideration should be given to reducing the potential confusion caused by the lack of standardisation of the location of the operating devices (pull tab, handle) for underwater emergency exits. For instance, the device could be located next to the handhold. The occupant then has only to find the handhold to locate the operating device. Each adjacent occupant should be able to reach the handhold and operating device whilst seated, with restraints fastened, with seat energy absorption features in any design position, and with the rotorcraft in any attitude. If a single underwater emergency exit is designed for the simultaneous egress of two occupants side by side, a handhold and an operating device should be within reach of each occupant seated adjacent to the exit.

The risk of a capsize during evacuation onto the life rafts can be mitigated to some extent by instructing passengers to open all the underwater emergency exits as a matter of course soon after the helicopter has alighted on the water, thus avoiding the delay due to opening the exits in the event that the exits are needed. This may be of particular benefit where the helicopter has a ditching emergency exit which overlaps one or more underwater emergency exits when open (e.g. a sliding door). Such advice should be considered for inclusion in the documentation provided to the helicopter operator.

(b) Procedures

- (1) Underwater emergency exits should be shown to be operable with the rotorcraft in any foreseeable floating attitude, including with the rotorcraft capsized.

A particular issue exists in regard to doors (e.g. a sliding door) which overlap underwater emergency exits when open, and which are designated as the ditching emergency exits as required by [CS 29.803\(c\)](#). In the case of a rotorcraft with such an arrangement, it should be substantiated that passengers could still have a viable egress route should the

helicopter capsize after the door has been opened but before all occupants have egressed.

Where the open door does not offer an opening of sufficient size and location to provide immediate and usable underwater egress possibility for all occupants, wherever they are located, the intent could be achieved by opening two push-out windows, one in the fuselage and one in the open door. Such a solution will depend on the rotorcraft design ensuring that the windows will be sufficiently aligned when the door is fully opened and secured (the resultant unobstructed opening should permit at least an ellipse of 0.48 m x 0.66 m (19 in. x 26 in.) to pass through it). Availability of such an opening is more likely if the windows are opened by cabin occupants as a matter of course following a ditching, as explained in (a) above.

- (2) Underwater emergency exits should be designed so that they are optimised for use with the rotorcraft capsized. For example, the handhold(s) should be located close to the bottom of the window (top if inverted) to assist an occupant in overcoming the buoyancy loads of an immersion suit, and it should be ensured that markings and lighting will help identify the exit(s) and readily assist in an escape.
- (3) The means to open an underwater emergency exit should be simple and obvious and should not require any exceptional effort. Designs with any of the following characteristics (non-exhaustive list) are considered to be non-compliant:
 - (i) more than one hand is needed to operate the exit itself (use of the handhold may occupy the other hand);
 - (ii) any part of the opening means, e.g. an operating handle or control, is located remotely from the exit such that it would be outside of a person's direct vision when looking directly at the exit, or that the person should move away from the immediate vicinity of the exit in order to reach it; and
 - (iii) the exit does not meet the opening effort limitations set by FAA AC 29.809.
- (4) It should be possible to readily grasp and operate any operating handle or control using either a bare or a gloved hand.
- (5) Handholds, as required by CS 29.809(j)(3), should be mounted close to the bottom of each underwater emergency exit such that they fall easily to hand for a normally seated occupant. In the case of exits between face-to-face seating, the provision of two handholds is required. Handholds should be designed such that the risk is low of escapees' clothing or emergency equipment snagging on them.
- (6) The operating handle or tab for underwater emergency exits should be located next to the handhold.

[Amdt No: 29/5]

CS 29.811 Emergency exit marking

ED Decision 2018/007/R

- (a) Each emergency exit, its means of access, and its means of opening must be conspicuously marked for the guidance of occupants using the exits in daylight or in the dark.
- (b) The identity and location of each passenger emergency exit must be recognisable from a distance equal to the width of the cabin.
- (c) The location of each passenger emergency exit must be indicated by a sign visible to occupants approaching along the main passenger aisle. There must be a locating sign:
 - (1) Next to or above the aisle near each floor emergency exit, except that one sign may serve two exits if both exits can be seen readily from that sign; and
 - (2) On each bulkhead or divider that prevents fore and aft vision along the passenger cabin, to indicate emergency exits beyond and obscured by it, except that if this is not possible the sign may be placed at another appropriate location.
- (d) Each passenger emergency exit marking and each locating sign must have white letters 25 mm (1 inch) high on a red background 51 mm (2 inches) high, be self or electrically illuminated, and have a minimum luminescence (brightness) of at least 0.51 candela/m² (160 microlamberts). The colours may be reversed if this will increase the emergency illumination of the passenger compartment.
- (e) The location of each passenger emergency exit operating handle and instructions for opening must be shown:
 - (1) For each emergency exit, by a marking on or near the exit that is readable from a distance of 0.76 m (30 inches); and
 - (2) For each Type I or Type II emergency exit with a locking mechanism released by rotary motion of the handle, by:
 - (i) A red arrow, with a shaft at least 19 mm ($\frac{3}{4}$ inch) wide and a head twice the width of the shaft, extending along at least 70° of arc at a radius approximately equal to three-fourths of the handle length; and
 - (ii) The word 'open' in red letters 25 mm (1 inch) high, placed horizontally near the head of the arrow.
- (f) Each emergency exit, and its means of opening, must be marked on the outside of the rotorcraft. In addition, the following apply:
 - (1) There must be a 51 mm (2-inch) coloured band outlining each passenger emergency exit, except small rotorcraft with a maximum weight of 5 670 kg (12 500 pounds) or less may have a 51 mm (2-inch) coloured band outlining each exit release lever or device of passenger emergency exits which are normally used doors.
 - (2) Each outside marking, including the band, must have colour contrast to be readily distinguishable from the surrounding fuselage surface. The contrast must be such that, if the reflectance of the darker colour is 15% or less, the reflectance of the lighter colour must be at least 45%. 'Reflectance' is the ratio of the luminous flux reflected by a body to the luminous flux it receives. When the reflectance of the darker colour is greater than 15%, at least a 30% difference between its reflectance and the reflectance of the lighter colour must be provided.

- (g) Exits marked as such, though in excess of the required number of exits, must meet the requirements for emergency exits of the particular type. Emergency exits need only be marked with the word 'Exit'.
- (h) If certification with ditching provisions is requested by the applicant, in addition to the markings required by (a) above:
- (1) each underwater emergency exit required by [CS 29.805\(c\)](#) or [CS 29.807\(d\)](#), its means of access and its means of opening, must be provided with highly conspicuous illuminated markings that illuminate automatically and are designed to remain visible with the rotorcraft capsized and the cabin or cockpit, as appropriate, flooded; and
 - (2) each operational device (pull tab(s), operating handle, 'push here' decal, etc.) for these emergency exits must be marked with black and yellow stripes.

[Amdt No: 29/5]

AMC 29.811(h) Underwater emergency exit markings

ED Decision 2018/007/R

This AMC supplements FAA AC 29.811 and AC 29.811A.

(a) Explanation

This AMC provides additional means of compliance and guidance material relating to underwater emergency exit markings.

CS-29 Amendment 5 extended the requirements for exit markings to remain visible in a submerged cabin. CS 29.811(h) requires all underwater emergency exits (i.e. for both passengers and flight crew) and the exits and doors for use when boarding life rafts (as required by [CS 29.803\(c\)](#)) to be provided with additional conspicuous illuminated markings that will continue to function underwater.

Disorientation of occupants may result in the normal emergency exit markings in the cockpit and passenger cabin being ineffective following the rotorcraft capsizing and the cabin flooding. Additional and more highly conspicuous illuminated markings should be provided along the periphery of each underwater emergency exit, giving a clear indication of the aperture.

(b) Procedures

- (1) The additional markings of underwater emergency exits should be in the form of illuminated strips that give a clear indication in all environments (e.g. at night, underwater) of the location of an underwater emergency exit. The markings should be sufficient to highlight the full periphery.
- (2) The additional illuminated markings should function automatically, when needed, and remain visible for at least 10 minutes following rotorcraft flooding. The method chosen to automatically activate the system (e.g. water immersion switch(es), tilt switch(es), etc.) should be such as to ensure that the markings are illuminated immediately, or are already illuminated, when the rotorcraft reaches a point where a capsize is inevitable.
- (3) The location of the operating device for an underwater emergency exit (e.g. a handle, or pull tab in the case of a 'push-out' window) should be distinctively illuminated. The illumination should provide sufficient lighting to illuminate the handle or tab itself in order to assist in its identification. In the case of openable windows, the optimum place(s) for pushing out (e.g. in a corner) should be illuminated.

- (4) To make it easier to recognise underwater, the operating device for the underwater emergency exit should have black and yellow markings with at least two bands of each colour of approximately equal widths. Any other operating features, e.g. highlighted ‘push here’ decal(s) for openable windows, should also incorporate black- and yellow-striped markings.

[Amdt No: 29/5]

CS 29.812 Emergency lighting

ED Decision 2018/007/R

For Category A rotorcraft, the following apply:

- (a) A source of light with its power supply independent of the main lighting system must be installed to:
- (1) Illuminate each passenger emergency exit marking and locating sign; and
 - (2) Provide enough general lighting in the passenger cabin so that the average illumination, when measured at 1.02 m (40-inch) intervals at seat armrest height on the centre line of the main passenger aisle, is at least 0.5 lux (0.05 foot-candle).
- (b) Exterior emergency lighting must be provided at each emergency exit as required by [CS 29.807\(a\)](#) and at each ditching emergency exit required by [CS 29.803\(c\)\(1\)](#). The illumination may not be less than 0.5 lux (0.05 foot-candle) (measured normal to the direction of incident light) for a minimum width equal to the width of the emergency exit on the ground surface where an evacuee is likely to make first contact outside the cabin, with landing gear extended, and if applicable, on the raft surface where an evacuee is likely to make first contact when boarding the life raft. The exterior emergency lighting may be provided by either interior or exterior sources with light intensity measurements made with the emergency exits open.
- (c) Each light required by sub-paragraph (a) or (b) must be operable manually from the cockpit station and from a point in the passenger compartment that is readily accessible. The cockpit control device must have an ‘on’, ‘off’, and ‘armed’ position so that when turned on at the cockpit or passenger compartment station or when armed at the cockpit station, the emergency lights will either illuminate or remain illuminated upon interruption of the rotorcraft’s normal electric power.
- (d) Any means required to assist the occupants in descending to the ground must be illuminated so that the erected assist means is visible from the rotorcraft.
- (1) The assist means must be provided with an illumination of not less than 0.3 lux (0.03 foot-candle) (measured normal to the direction of the incident light) at the ground end of the erected assist means where an evacuee using the established escape route would normally make first contact with the ground, with the rotorcraft in each of the attitudes corresponding to the collapse of one or more legs of the landing gear.
 - (2) If the emergency lighting subsystem illuminating the assist means is independent of the rotorcraft’s main emergency lighting system, it:
 - (i) Must automatically be activated when the assist means is erected;
 - (ii) Must provide the illumination required by sub-paragraph (d)(1); and
 - (iii) May not be adversely affected by stowage.

- (e) The energy supply to each emergency lighting unit must provide the required level of illumination for at least 10 minutes at the critical ambient conditions after an emergency landing.
- (f) If storage batteries are used as the energy supply for the emergency lighting system, they may be recharged from the rotorcraft's main electrical power system provided the charging circuit is designed to preclude inadvertent battery discharge into charging circuit faults.

[Amdt No: 29/5]

CS 29.813 Emergency exit access

ED Decision 2018/007/R

- (a) Each passageway between passenger compartments, and each passageway leading to Type I and Type II emergency exits, must be:
 - (1) Unobstructed; and
 - (2) At least 0.51 m (20 inches) wide.
- (b) For each emergency exit covered by [CS 29.809\(f\)](#), there must be enough space adjacent to that exit to allow a crew member to assist in the evacuation of passengers without reducing the unobstructed width of the passageway below that required for that exit.
- (c) There must be access from each aisle to each Type III and Type IV exit; and
 - (1) For rotorcraft that have a passenger seating configuration, excluding pilot seats, of 20 or more, the projected opening of the exit provided must not be obstructed by seats, berths, or other protrusions (including seatbacks in any position) for a distance from that exit of not less than the width of the narrowest passenger seat installed on the rotorcraft;
 - (2) For rotorcraft that have a passenger seating configuration, excluding pilot seats, of 19 or less, there may be minor obstructions in the region described in sub-paragraph (1), if there are compensating factors to maintain the effectiveness of the exit.
- (d) If certification with ditching provisions is requested:
 - (1) passenger seats must be located in relation to the underwater emergency exits provided in accordance with [CS 29.807\(d\)\(1\)](#) in a way to best facilitate escape with the rotorcraft capsized and the cabin flooded; and
 - (2) means must be provided to assist cross-cabin escape when capsized.

[Amdt No: 29/5]

AMC 29.813 Emergency exit access

ED Decision 2018/007/R

This AMC supplements FAA AC 29.813.

(a) Explanation

The provision for underwater emergency exits for passengers (see [CS 29.807\(d\)](#)) is based on the need to facilitate egress in the case of a capsizing occurring soon after the rotorcraft has alighted on the water or in the event of a survivable water impact in which the cabin may be immediately flooded. The time available for evacuation is very short in such situations, and therefore, CS-29 Amendment 5 has increased the safety level by mandating additional exits, in the form of underwater emergency exits, to both shorten available escape routes and to ensure that no occupant should need to wait for more than one other person to escape before being able to make their own escape. The provision of an underwater emergency exit in each side of the fuselage of at least the size of a Type IV exit for each unit (or part of a unit) of four passenger seats will make this possible, provided that seats are positioned relative to the exits in a favourable manner.

Critical factors in an evacuation are the distance to an emergency exit and how direct and obvious the exit route is, taking into account that the passengers are likely to be disorientated.

Furthermore, consideration should be given to occupants having to make a cross-cabin escape due to the nearest emergency exit being blocked or otherwise unusable.

(b) Procedures

- (1) The most obvious layout that maximises achievement of the objective that no passenger is in a worse position than the second person to egress through an exit is a four-abreast arrangement with all the seats in each row located appropriately and directly next to the emergency exits. However, this might not be possible in all rotorcraft designs due to issues such as limited cabin width, the need to locate seats such as to accommodate normal boarding and egress, and the installation of items other than seats in the cabin. Notwithstanding this, an egress route necessitating movement such as along an aisle, around a cabin item, or in any way other than directly towards the nearest emergency exit, to escape the rotorcraft, is not considered to be compliant with [CS 29.813\(d\)](#).
- (2) If overall rotorcraft configuration constraints do not allow for easy and direct achievement of the above, one alternative may be to provide one or more underwater emergency exits larger than a Type IV in each side of the fuselage.
- (3) The means provided to facilitate cross-cabin egress should be accessible to occupants floating freely in the cabin, should be easy to locate and should, as far as practicable, provide continuous visual and tactile cues to guide occupants to an exit. An effective solution could take the form of guide bars/ropes fitted to the front of the seat row structure below seat cushion height, in order to be accessible to passengers floating freely inside a capsized cabin. Where it is impractical for guide bars to be run across the full width of the cabin, e.g. due to the presence of an aisle, the ends of the guide bars should be designed to make them easier to find, e.g. enlarged and highlighted/lit end fittings to provide additional visual and tactile location cues. The provisions should be designed to minimise the risk of escapees' clothing or emergency equipment snagging on them.

[Amdt No: 29/5]

CS 29.815 Main aisle width

ED Decision 2003/16/RM

The main passenger aisle width between seats must equal or exceed the values in the following table:

	Minimum main passenger aisle width	
	Less than 0.64 m (25 in) from floor m (in)	0.64 m (25 in) and more from floor m (in)
10 or less	0.30 (12)*	0.38 (15)
11 to 19	0.30 (12)	0.51 (20)
20 or more	0.38 (15)	0.51 (20)

* A narrower width not less than 0.23 m (9 inches) may be approved when substantiated by tests found necessary by the Agency.

CS 29.831 Ventilation

ED Decision 2003/16/RM

- (a) Each passenger and crew compartment must be ventilated, and each crew compartment must have enough fresh air (but not less than 0.3 m³ (10 cu ft) per minute per crew member) to let crew members perform their duties without undue discomfort or fatigue.
- (b) Crew and passenger compartment air must be free from harmful or hazardous concentrations of gases or vapours.
- (c) The concentration of carbon monoxide may not exceed one part in 20 000 parts of air during forward flight. If the concentration exceeds this value under other conditions, there must be suitable operating restrictions.
- (d) There must be means to ensure compliance with sub-paragraphs (b) and (c) under any reasonably probable failure of any ventilating, heating, or other system or equipment.

CS 29.833 Heaters

ED Decision 2003/16/RM

Each combustion heater must be approved.

FIRE PROTECTION

CS 29.851 Fire extinguishers

ED Decision 2003/16/RM

- (a) *Hand fire extinguishers.* For hand fire extinguishers the following apply:
- (1) Each hand fire extinguisher must be approved.
 - (2) The kinds and quantities of each extinguishing agent used must be appropriate to the kinds of fires likely to occur where that agent is used.
 - (3) Each extinguisher for use in a personnel compartment must be designed to minimise the hazard of toxic gas concentrations.
- (b) *Built-in fire extinguishers.* If a built-in fire extinguishing system is required:
- (1) The capacity of each system, in relation to the volume of the compartment where used and the ventilation rate, must be adequate for any fire likely to occur in that compartment.
 - (2) Each system must be installed so that:
 - (i) No extinguishing agent likely to enter personnel compartments will be present in a quantity that is hazardous to the occupants; and
 - (ii) No discharge of the extinguisher can cause structural damage.

AMC 29.851 Fire extinguishers

ED Decision 2012/022/R

Based on EU legislation¹, in new installations of hand fire extinguishers for which the certification application is submitted after 31 December 2014, Halon 1211, 1301 and Halon 2402 are unacceptable extinguishing agents.

The guidance regarding hand fire extinguishers in FAA Advisory Circular AC 20-42D is considered acceptable by the Agency. See [AMC 29.1197](#) for more information on Halon alternatives.

[Amdt 29/3]

CS 29.853 Compartment interiors

ED Decision 2003/16/RM

For each compartment to be used by the crew or passengers:

- (a) The materials (including finishes or decorative surfaces applied to the materials) must meet the following test criteria as applicable:
- (1) Interior ceiling panels, interior wall panels, partitions, galley structure, large cabinet walls, structural flooring, and materials used in the construction of stowage compartments (other than underseat stowage compartments and compartments for stowing small items such as magazines and maps) must be self-extinguishing when tested vertically in accordance with the applicable portions of Appendix F of CS-25, or other approved

¹ Commission Regulation (EU) No 744/2010 of 18 August 2010 amending Regulation (EC) No 1005/2009 of the European Parliament and of the Council on substances that deplete the ozone layer, with regard to the critical uses of halon (OJ L 218, 19.8.2010, p. 2).

equivalent methods. The average burn length may not exceed 0.15 m (6 in) and the average flame time after removal of the flame source may not exceed 15 seconds. Drippings from the test specimen may not continue to flame for more than an average of 3 seconds after falling.

- (2) Floor covering, textiles (including draperies and upholstery), seat cushions, padding, decorative and non-decorative coated fabrics, leather, trays and galley furnishings, electrical conduit, thermal and acoustical insulation and insulation covering, air ducting, joint and edge covering, cargo compartment liners, insulation blankets, cargo covers, and transparencies, moulded and thermoformed parts, air ducting joints, and trim strips (decorative and chafing) that are constructed of materials not covered in sub-paragraph (a)(3), must be self-extinguishing when tested vertically in accordance with the applicable portion of Appendix F of CS-25, or other approved equivalent methods. The average burn length may not exceed 0.20 m (8 in) and the average flame time after removal of the flame source may not exceed 15 seconds. Drippings from the test specimen may not continue to flame for more than an average of 5 seconds after falling.
 - (3) Acrylic windows and signs, parts constructed in whole or in part of elastomeric materials, edge lighted instrument assemblies consisting of two or more instruments in a common housing, seat belts, shoulder harnesses, and cargo and baggage tiedown equipment, including containers, bins, pallets, etc., used in passenger or crew compartments, may not have an average burn rate greater than 64 mm (2.5 in) per minute when tested horizontally in accordance with the applicable portions of Appendix F of CS-25, or other approved equivalent methods.
 - (4) Except for electrical wire and cable insulation, and for small parts (such as knobs, handles, rollers, fasteners, clips, grommets, rub strips, pulleys, and small electrical parts) that the Agency finds would not contribute significantly to the propagation of a fire, materials in items not specified in sub-paragraphs (a)(1), (a)(2), or (a)(3) may not have a burn rate greater than 0.10 m (4 in) per minute when tested horizontally in accordance with the applicable portions of Appendix F of CS-25, or other approved equivalent methods.
- (b) In addition to meeting the requirements of sub-paragraph (a)(2), seat cushions, except those on flight-crew member seats, must meet the test requirements of Part II of Appendix F of CS-25, or equivalent.
 - (c) If smoking is to be prohibited, there must be a placard so stating, and if smoking is to be allowed:
 - (1) There must be an adequate number of self-contained, removable ashtrays; and
 - (2) Where the crew compartment is separated from the passenger compartment, there must be at least one illuminated sign (using either letters or symbols) notifying all passengers when smoking is prohibited. Signs which notify when smoking is prohibited must:
 - (i) When illuminated, be legible to each passenger seated in the passenger cabin under all probable lighting conditions; and
 - (ii) Be so constructed that the crew can turn the illumination on and off.
 - (d) Each receptacle for towels, paper, or waste must be at least fire-resistant and must have means for containing possible fires;
 - (e) There must be a hand fire extinguisher for the flight-crew members; and

- (f) At least the following number of hand fire extinguishers must be conveniently located in passenger compartments:

Passenger capacity	Fire extinguishers
7 to 30	1
31 to 60	2
61 or more	3

CS 29.855 Cargo and baggage compartments

ED Decision 2003/16/RM

- (a) Each cargo and baggage compartment must be constructed of, or lined with, materials in accordance with the following:
- (1) For accessible and inaccessible compartments not occupied by passengers or crew, the material must be at least fire-resistant.
 - (2) Materials must meet the requirements in [CS 29.853\(a\)\(1\)](#), [\(a\)\(2\)](#), and [\(a\)\(3\)](#) for cargo or baggage compartments in which:
 - (i) The presence of a compartment fire would be easily discovered by a crew member while at the crew member's station;
 - (ii) Each part of the compartment is easily accessible in flight;
 - (iii) The compartment has a volume of 5.6 m³ (200 cu ft) or less; and
 - (iv) Notwithstanding [CS 29.1439\(a\)](#), protective breathing equipment is not required.
- (b) No compartment may contain any controls, wiring, lines, equipment, or accessories whose damage or failure would affect safe operation, unless those items are protected so that:
- (1) They cannot be damaged by the movement of cargo in the compartment; and
 - (2) Their breakage or failure will not create a fire hazard.
- (c) The design and sealing of inaccessible compartments must be adequate to contain compartment fires until a landing and safe evacuation can be made.
- (d) Each cargo and baggage compartment that is not sealed so as to contain cargo compartment fires completely without endangering the safety of a rotorcraft or its occupants must be designed, or must have a device, to ensure detection of fires or smoke by a crew member while at his station and to prevent the accumulation of harmful quantities of smoke, flame, extinguishing agents, and other noxious gases in any crew or passenger compartment. This must be shown in flight.
- (e) For rotorcraft used for the carriage of cargo only, the cabin area may be considered a cargo compartment and, in addition to sub-paragraphs (a) to (d), the following apply:
- (1) There must be means to shut off the ventilating airflow to or within the compartment. Controls for this purpose must be accessible to the flight crew in the crew compartment.
 - (2) Required crew emergency exits must be accessible under all cargo loading conditions.
 - (3) Sources of heat within each compartment must be shielded and insulated to prevent igniting the cargo.

CS 29.859 Combustion heater fire protection

ED Decision 2003/16/RM

- (a) *Combustion heater fire zones.* The following combustion heater fire zones must be protected against fire under the applicable provisions of [CS 29.1181](#) to [29.1191](#), and [CS 29.1195](#) to [29.1203](#):
- (1) The region surrounding any heater, if that region contains any flammable fluid system components (including the heater fuel system), that could:
 - (i) Be damaged by heater malfunctioning; or
 - (ii) Allow flammable fluids or vapours to reach the heater in case of leakage.
 - (2) Each part of any ventilating air passage that:
 - (i) Surrounds the combustion chamber; and
 - (ii) Would not contain (without damage to other rotorcraft components) any fire that may occur within the passage.
- (b) *Ventilating air ducts.* Each ventilating air duct passing through any fire zone must be fireproof. In addition –
- (1) Unless isolation is provided by fireproof valves or by equally effective means, the ventilating air duct downstream of each heater must be fireproof for a distance great enough to ensure that any fire originating in the heater can be contained in the duct; and
 - (2) Each part of any ventilating duct passing through any region having a flammable fluid system must be so constructed or isolated from that system that the malfunctioning of any component of that system cannot introduce flammable fluids or vapours into the ventilating airstream.
- (c) *Combustion air ducts.* Each combustion air duct must be fireproof for a distance great enough to prevent damage from backfiring or reverse flame propagation. In addition:
- (1) No combustion air duct may communicate with the ventilating airstream unless flames from backfires or reverse burning cannot enter the ventilating airstream under any operating condition, including reverse flow or malfunction of the heater or its associated components; and
 - (2) No combustion air duct may restrict the prompt relief of any backfire that, if so restricted, could cause heater failure.
- (d) *Heater controls; general.* There must be means to prevent the hazardous accumulation of water or ice on or in any heater control component, control system tubing, or safety control.
- (e) *Heater safety controls.* For each combustion heater, safety control means must be provided as follows:
- (1) Means independent of the components provided for the normal continuous control of air temperature, airflow, and fuel flow must be provided, for each heater, to automatically shut off the ignition and fuel supply of that heater at a point remote from that heater when any of the following occurs:
 - (i) The heat exchanger temperature exceeds safe limits.
 - (ii) The ventilating air temperature exceeds safe limits.
 - (iii) The combustion airflow becomes inadequate for safe operation.

- (iv) The ventilating airflow becomes inadequate for safe operation.
- (2) The means of complying with sub-paragraph (e)(1) for any individual heater must:
 - (i) Be independent of components serving any other heater whose heat output is essential for safe operation; and
 - (ii) Keep the heater off until restarted by the crew.
- (3) There must be means to warn the crew when any heater whose heat output is essential for safe operation has been shut off by the automatic means prescribed in sub-paragraph (e)(1).
- (f) *Air intakes.* Each combustion and ventilating air intake must be where no flammable fluids or vapours can enter the heater system under any operating condition:
 - (1) During normal operation; or
 - (2) As a result of the malfunction of any other component.
- (g) *Heater exhaust.* Each heater exhaust system must meet the requirements of [CS 29.1121](#) and [29.1123](#). In addition:
 - (1) Each exhaust shroud must be sealed so that no flammable fluids or hazardous quantities of vapours can reach the exhaust systems through joints; and
 - (2) No exhaust system may restrict the prompt relief of any backfire that, if so restricted, could cause heater failure.
- (h) *Heater fuel systems.* Each heater fuel system must meet the powerplant fuel system requirements affecting safe heater operation. Each heater fuel system component in the ventilating airstream must be protected by shrouds so that no leakage from those components can enter the ventilating airstream.
- (i) *Drains.* There must be means for safe drainage of any fuel that might accumulate in the combustion chamber or the heat exchanger. In addition –
 - (1) Each part of any drain that operates at high temperatures must be protected in the same manner as heater exhausts; and
 - (2) Each drain must be protected against hazardous ice accumulation under any operating condition.

CS 29.861 Fire protection of structure, controls, and other parts

ED Decision 2003/16/RM

Each part of the structure, controls, and the rotor mechanism, and other parts essential to controlled landing and (for Category A) flight that would be affected by powerplant fires must be isolated under [CS 29.1191](#), or must be:

- (a) For Category A rotorcraft, fire-proof; and
- (b) For Category B rotorcraft, fire-proof or protected so that they can perform their essential functions for at least 5 minutes under any foreseeable powerplant fire conditions.

CS 29.863 Flammable fluid fire protection

ED Decision 2003/16/RM

- (a) In each area where flammable fluids or vapours might escape by leakage of a fluid system, there must be means to minimise the probability of ignition of the fluids and vapours, and the resultant hazards if ignition does occur.
- (b) Compliance with sub-paragraph (a) must be shown by analysis or tests, and the following factors must be considered:
 - (1) Possible sources and paths of fluid leakage, and means of detecting leakage.
 - (2) Flammability characteristics of fluids, including effects of any combustible or absorbing materials.
 - (3) Possible ignition sources, including electrical faults, overheating of equipment, and malfunctioning of protective devices.
 - (4) Means available for controlling or extinguishing a fire, such as stopping flow of fluids, shutting down equipment, fireproof containment, or use of extinguishing agents.
 - (5) Ability of rotorcraft components that are critical to safety of flight to withstand fire and heat.
- (c) If action by the flight crew is required to prevent or counteract a fluid fire (e.g. equipment shutdown or actuation of a fire extinguisher), quick acting means must be provided to alert the crew.
- (d) Each area where flammable fluids or vapours might escape by leakage of a fluid system must be identified and defined.

EXTERNAL LOADS

CS 29.865 External loads

ED Decision 2018/007/R

- (a) It must be shown by analysis, test, or both, that the rotorcraft external load attaching means for rotorcraft-load combinations to be used for non-human external cargo applications can withstand a limit static load equal to 2.5, or some lower load factor approved under [CS 29.337](#) through [29.341](#), multiplied by the maximum external load for which authorisation is requested. It must be shown by analysis, test, or both that the rotorcraft external-load attaching means and any complex personnel-carrying device system for rotorcraft-load combinations to be used for human external cargo applications can withstand a limit static load equal to 3.5 or some lower load factor, not less than 2.5, approved under [CS 29.337](#) through [29.341](#), multiplied by the maximum external load for which authorisation is requested. The load for any rotorcraft-load combination class, for any external cargo type, must be applied in the vertical direction. For jettisonable rotorcraft-load combinations, for any applicable external cargo type, the load must also be applied in any direction making the maximum angle with the vertical that can be achieved in service but not less than 30°. However, the 30° angle may be reduced to a lesser angle if:
- (1) An operating limitation is established limiting external load operations to those angles for which compliance with this paragraph has been shown; or
 - (2) It is shown that the lesser angle cannot be exceeded in service.
- (b) The external-load attaching means, for jettisonable rotorcraft-load combinations, must include a quick-release system (QRS) to enable the pilot to release the external load quickly during flight. The QRS must consist of a primary quick-release subsystem and a backup quick-release subsystem that are isolated from one another. The QRS, and the means by which it is controlled, must comply with the following:
- (1) A control for the primary quick-release subsystem must be installed either on one of the pilot's primary controls or in an equivalently accessible location and must be designed and located so that it may be operated by either the pilot or a crew member without hazardously limiting the ability to control the rotorcraft during an emergency situation.
 - (2) A control for the backup quick-release subsystem, readily accessible to either the pilot or another crew member, must be provided.
 - (3) Both the primary and backup quick-release subsystems must:
 - (i) Be reliable, durable, and function properly with all external loads up to and including the maximum external limit load for which authorisation is requested.
 - (ii) Be protected against electromagnetic interference (EMI) from external and internal sources and against lightning to prevent inadvertent load release.
 - (A) The minimum level of protection required for jettisonable rotorcraft-load combinations used for non-human external cargo is a radio frequency field strength of 20 volts per metre.
 - (B) The minimum level of protection required for jettisonable rotorcraft-load combinations used for human external cargo is a radio frequency field strength of 200 volts per metre.

- (iii) Be protected against any failure that could be induced by a failure mode of any other electrical or mechanical rotorcraft system.
- (c) For rotorcraft-load combinations to be used for human external cargo applications, the rotorcraft must:
 - (1) For jettisonable external loads, have a QRS that meets the requirements of sub-paragraph (b) and that:
 - (i) Provides a dual actuation device for the primary quick-release subsystem, and
 - (ii) Provides a separate dual actuation device for the backup quick-release subsystem.
 - (2) Enable the safe utilisation of complex personnel-carrying device systems to transport occupants external to the helicopter or to restrain occupants inside the cabin. A personnel-carrying device system is considered complex if:
 - (i) it does not meet an European Norm (EN) standard under Directive 89/686/EEC¹ or Regulation (EU) 2016/425², as applicable, or subsequent revision;
 - (ii) it is designed to restrain more than a single person (e.g. a hoist or cargo hook operator, photographer, etc.) inside the cabin, or to restrain more than two persons outside the cabin; or
 - (iii) it is a rigid structure such as a cage, a platform or a basket.

Complex personnel-carrying device systems shall be reliable and have the structural capability and personnel safety features essential for external occupant safety through compliance with the specific requirements of [CS 29.865](#), [CS 29.571](#) and other relevant requirements of CS-29 for the proposed operating envelope.
 - (3) Have placards and markings at all appropriate locations that clearly state the essential system operating instructions and, for complex personnel-carrying device systems, ingress and egress instructions,
 - (4) Have equipment to allow direct intercommunication among required crew members and external occupants,
 - (5) Have the appropriate limitations and procedures incorporated in the flight manual for conducting human external cargo operations, and
 - (6) For human external cargo applications requiring use of Category A rotorcraft, have one-engine-inoperative hover performance data and procedures in the flight manual for the weights, altitudes, and temperatures for which external load approval is requested.
- (d) The critically configured jettisonable external loads must be shown by a combination of analysis, ground tests, and flight tests to be both transportable and releasable throughout the approved operational envelope without hazard to the rotorcraft during normal flight conditions. In addition, these external loads must be shown to be releasable without hazard to the rotorcraft during emergency flight conditions.

¹ Council Directive 89/686/EEC of 21 December 1989 on the approximation of the laws of the Member States relating to personal protective equipment (OJ L 399, 30.12.1989, p. 18).

² Regulation (EU) 2016/425 of the European Parliament and of the Council of 9 March 2016 on personal protective equipment and repealing Council Directive 89/686/EEC (OJ L 81, 31.3.2016, p. 51).

- (e) A placard or marking must be installed next to the external-load attaching means clearly stating any operational limitations and the maximum authorised external load as demonstrated under [CS 29.25](#) and this paragraph.
- (f) The fatigue evaluation of [CS 29.571](#) does not apply to rotorcraft-load combinations to be used for non-human external cargo except for the failure of critical structural elements that would result in a hazard to the rotorcraft. For rotorcraft-load combinations to be used for human external cargo, the fatigue evaluation of [CS 29.571](#) applies to the entire quick-release and complex personnel-carrying device structural systems and their attachments.

[Amdt No: 29/5]

AMC 29.865 External Loads

ED Decision 2018/015/R

This AMC provides further guidance and acceptable means of compliance to supplement FAA AC 29-2C Change 7 AC 29.865B § 29.865 (Amendment 29-43) EXTERNAL LOADS to meet EASA's interpretation of [CS 29.865](#). As such, it should be used in conjunction with the FAA AC but should take precedence over it, where stipulated, in the showing of compliance.

[AMC No 1](#) below addresses the specificities of complex personnel-carrying device systems for human external cargo applications.

[AMC No 2](#) below contains a recognised approach to the approval of simple PCDSs if required by the applicable operating rule or if an applicant elects to include simple PCDSs within the scope of type certification.

[Amdt No: 29/5]

[Amdt No: 29/6]

AMC No 1 to CS 29.865 External loads

ED Decision 2018/015/R

a. Explanation

- (1) This AMC contains guidance for the certification of helicopter external-load attaching means and load-carrying systems to be used in conjunction with operating rules such as Regulation (EU) No 965/2012 on Air Operations¹. [CS 29.25](#) also concerns, in part, jettisonable external cargo.
- (2) CS 29.865 provides a minimum level of safety for large category rotorcraft designs to be used with operating rules, such as Regulation (EU) No 965/2012 on Air Operations. Certain aspects of operations, such as microwave tower and high-line wirework, may also be regulated separately by other agencies or entities. For applications that could come under the regulations of more than one agency or entity, special certification emphasis will be required by both the applicant and the approving authority to assure all relevant safety requirements are identified and met. Potential additional requirements, where thought to exist, are noted herein.
- (3) The CS provisions for external loads ([29.865](#)) do not discern the difference between a crew member and a compensating passenger when either is carried external to the rotorcraft. Both are considered to be HEC.

¹ Commission Regulation (EU) No 965/2012 of 5 October 2012 laying down technical requirements and administrative procedures related to air operations pursuant to Regulation (EC) No 216/2008 of the European Parliament and of the Council (OJ L 296, 25.10.2012, p. 1).

b. Definitions

- (1) Backup quick-release subsystem (BQRS): the secondary or ‘second choice’ subsystem used to perform a normal or emergency jettison of external cargo.
- (2) Cargo: the part of any rotorcraft-load combination that is removable, changeable, and is attached to the rotorcraft by an approved means. For certification purposes, ‘cargo’ applies to HEC and non-human external cargo (NHEC).
- (3) Cargo hook: a hook that can be rated for both HEC and NHEC. It is typically used by being fixed directly to a designated hard point on the rotorcraft.
- (4) Dual actuation device (DAD): this is a sequential control that requires two distinct actions in series for actuation. One example is the removal of a lock pin followed by the activation of a ‘then free’ switch or lever for load release to occur (in this scenario, a load release switch protected only by an uncovered switch guard is not acceptable). For jettisonable HEC applications, a simple, covered switch does not qualify as a DAD. Familiarity with covered switches allows the pilot to both open and activate the switch in one motion. This has led to inadvertent load release.
- (5) Emergency jettison (or complete load release): the intentional, instantaneous release of NHEC or HEC in a preset sequence by the quick-release system (QRS) that is normally performed to achieve safer aircraft operation in an emergency.
- (6) External fixture: a structure external to and in addition to the basic airframe that does not have true jettison capability and has no significant payload capability in addition to its own weight. An example is an agricultural spray boom. These configurations are not approvable as ‘External Loads’ under [CS 29.865](#).
- (7) External Load System. The entire installation related to the carriage of external loads to include not only the hoist or hook, but also the structural provisions and release systems. A complex PCDS is also considered to be part of the external load system.
- (8) Hoist: a hoist is a device that exerts a vertical pull, usually through a cable and drum system (i.e. a pull that does not typically exceed a 30-degree cone measured around the z-rotorcraft axis).
- (9) Hoist demonstration cycle (or ‘one cycle’): the complete extension and retraction of at least 95 % of the actual cable length, or 100 % of the cable length capable of being used in service (i.e. that would activate any extension or retraction limiting devices), whichever is greater.
- (10) Hoist load-speed combinations: some hoists are designed so that the extension and retraction speed slows as the load increases or nears the end of a cable extension. Other hoist designs maintain a constant speed as the load is varied. In the latter designs, the load-speed combination simply means the variation in load at the constant design speed of the hoist.
- (11) Human external cargo (HEC): a person (or persons) who, at some point in the operation, is (are) carried external to the rotorcraft.
- (12) Non-human external cargo (NHEC): any external cargo operation that does not at any time involve a person (or persons) carried external to the rotorcraft.
- (13) Normal jettison (or selective load release): the intentional release, normally at optimum jettison conditions, of NHEC.

- (14) Personnel-carrying device system (PCDS) is a device that has the structural capability and features needed to transport occupants external to the helicopter during HEC or helicopter hoist operations. A PCDS includes but is not limited to life safety harnesses (including, if applicable, a quick-release and strop with a connector ring), rigid baskets and cages that are either attached to a hoist or cargo hook or mounted to the rotorcraft airframe.
- (15) Primary quick-release subsystem (PQRS): the primary or 'first choice' subsystem used to perform a normal or emergency jettison of external cargo.
- (16) Quick-release system (QRS): the entire release system for jettisonable external cargo (i.e. the sum total of both the primary and backup quick-release subsystem). The QRS consists of all the components including the controls, the release devices, and everything in between.
- (17) Rescue hook (or hook): a hook that can be rated for both HEC and NHEC. It is typically used in conjunction with a hoist or equivalent system.
- (18) Rotorcraft-load combination (RLC): the combination of a rotorcraft and an external load, including the external-load attaching means.
- (19) Spider: a spider is a system of attaching a lowering cable or rope or a harness to an NHEC (or HEC) RLC to eliminate undesirable flight dynamics during operations. A spider usually has four or more legs (or load paths) that connect to various points of a PCDS to equalise loading and prevent spinning, twisting, or other undesirable flight dynamics.
- (20) True jettison capability: the ability to safely release an external load using an approved QRS in 30 seconds or less.

NOTE: In all cases, a PQRS should release the external load in less than 5 seconds. Many PQRSs will release the external load in milliseconds, once the activation device is triggered. However, a manual BQRS, such as a set of cable cutters, could take as much as 30 seconds to release the external load. The 30 seconds would be measured starting from the time the release command was given and ending when the external load was cut loose.

- (21) True payload capability: the ability of an external device or tank to carry a significant payload in addition to its own weight. If little or no payload can be carried, the external device or tank is an external fixture (see definition above).
- (22) Winch: a winch is a device that can employ a cable and drum or other means to exert a horizontal (i.e. x-rotorcraft axis) pull. However, in designs that utilise a winch to perform a hoist function by use of a 90-degree cable direction change device (such as a pulley or pulley system), the winch system is considered to be a hoist.

c. Procedures

The following certification procedures are provided in the most general form. Where there are significant differences between the cargo types, the differences are highlighted.

- (1) General Compliance Procedures for [CS 29.865](#): The applicant should clearly identify both the RLC and the applicable cargo types (NHEC or HEC) for which an application is being made. The structural loads and operating envelopes for each applicable cargo type should be determined and used to formulate the flight manual supplement and basic loads report. The applicant should show by analysis, test, or both, that the rotorcraft structure, the external-load attaching means, and the complex PCDS, if applicable, meet the specific

requirements of [CS 29.865](#) and any other relevant requirements of CS-29 for the proposed operating envelope.

NOTE: the approved maximum internal gross weight should never be exceeded for any approved HEC configuration (or simultaneous NHEC and HEC configuration).

- (2) Reliability of the external load system, including the QRS.
- (i) The hoist, QRS, and rescue hook system should be reliable for all phases of flight and the applicable configurations for those phases (i.e. operating, stowed, or unstowed) for which approval is sought. The hoist should be disabled (or an overriding, fail-safe mechanical safety device such as either a flagged removable shear pin or a load-lowering brake should be utilised) to prevent inadvertent load unspooling or release during any extended flight phases in which hoist operation is not intended. Loss of hoist operational control should also be considered.
 - (ii) A failure of the external load system (including QRS, hook, complex PCDS where applicable, and attachments to the rotorcraft) should be shown to be extremely improbable (i.e. 1×10^{-9} failures per flight) for all failure modes that could cause a catastrophic failure, serious injury or a fatality anywhere in the total airborne system. Uncontrolled high-speed descent of the hoist cable would fall into this category. All significant failure modes of lesser consequence should be evaluated and shown to be at least improbable (i.e. 1×10^{-5} failures per flight).
 - (iii) The reliability of the system should be demonstrated by completion and approval of the following:
 - (A) A functional hazard assessment (FHA) to determine the hazard severity of failures associated with the external load system. The effect of the flailing cable after a load release should be considered.
 - (B) A fault tree analysis (FTA) or equivalent to verify that the hazard classification of the FHA has been met.
 - (C) A system safety assessment (SSA) to demonstrate compliance with the applicable certification requirements.
 - (D) An analysis of the non-redundant external load system components that constitute the primary load path (e.g. beam, cable, hook), to demonstrate compliance with the applicable structural requirements.
 - (E) A repetitive test of all functional devices that cycles these devices under critical structural conditions, operational conditions, or a combination of both at least 10 times each for NHEC and 30 times for HEC. This is applicable to both primary and backup subsystems. It is assumed that only one hoist cycle will typically occur per flight. This rationale has been used to determine the 10 demonstration cycles for NHEC applications and 30 demonstration cycles for HEC applications. However, if a particular application requires more than one hoist cycle per flight, then the number of demonstration cycles should be increased accordingly by multiplying the test cycles by the intended higher cycle number per flight. These repetitive tests may be conducted on the rotorcraft or by using a bench simulation that accurately replicates the rotorcraft installation.
 - (F) An environmental qualification for the proposed operating environment. This review includes consideration of low and high temperatures (typically –

40 °C (– 40 °F) to + 65.6 °C (+ 150 °F), altitudes to 12 000 feet, humidity, salt spray, sand and dust, vibration, shock, rain, fungus, and acceleration. The appropriate rotorcraft sections of RTCA Document DO-160/ EUROCAE ED-14 for high and low temperature and vibration are considered to be acceptable for environmental qualification. The environmental qualification will address icing for those external load systems installed on rotorcraft approved for flight into icing conditions.

- (G) Qualification of the hoist itself to the appropriate electromagnetic interference (EMI) and lightning threat levels specified for NHEC or HEC, as applicable. This qualification can occur separately or as part of the entire on-board QRS.
- (3) Testing.
- (i) Hoist system load-speed combination ground tests. The load versus-speed combinations of the hoist should be demonstrated on the ground (either using an accurate engineering mock-up or a rotorcraft) by showing repeatability of the no load-speed combination, the 50 per cent load-speed combination, the 75 per cent load-speed combination, and the 100 per cent (i.e. system rated limit) load-speed combination. If more than one operational speed range exists, the preceding tests should be performed at the most critical speed.
 - (A) At least 1/10 of the hoist demonstration cycles (see definition) should include the maximum aft angular displacement of the load from the vertical, applied for under [CS 29.865\(a\)](#).
 - (B) A minimum of six consecutive, complete operation cycles should be conducted at the system's 100 per cent (i.e. system limit rated) load-speed combination.
 - (C) In addition, the demonstration should cover all normal and emergency modes of intended operation and should include operation of all control devices such as limit switches, braking devices, and overload sensors in the system.
 - (D) All quick disconnect devices and cable cutters should be demonstrated at 0 per cent, 25 per cent, 50 per cent, 75 per cent, and 100 per cent of system limit load or at the most critical percentage of limit load. Note: some hoist designs have built-in cable tensioning devices that function at the no load-speed combination, as well as at other load-speed combinations. This device should work during the no load-speed and other load-speed cable-cutting combinations.
 - (E) Any devices or methods used to increase the mechanical advantage of the hoist should also be demonstrated.
 - (F) During a portion of each demonstration cycle, the hoist should be operated from each station from which it can be controlled.
 - (ii) Hoist and rescue hook systems or cargo hook systems flight test: an in-flight demonstration test of the hoist system should be conducted for helicopters designed to carry NHEC or HEC. The rotorcraft should be flown to the extremes of the applicable manoeuvre flight envelope and to all conditions that are critical to strength, manoeuvrability, stability, and control, or any other factor affecting airworthiness. Unless a lesser load is determined to be more critical for either

dynamic stability or other reasons, the maximum hoist system rated load or, if less, the maximum load requested for approval (and the associated limit load data placards) should be used for these tests. The minimum hoist system load (or zero load) should also be demonstrated in these tests.

- (iii) CS 29.865(d) Flight test Verification Work: flight test verification work that thoroughly examines the operational envelope should be conducted with the external cargo carriage device for which approval is requested (especially those that involve HEC). The flight test programme should show that all aspects of the operations applied for are safe, uncomplicated, and can be conducted by a qualified flight crew under the most critical service environment and, in the case of HEC, under emergency condition. Flight tests should be conducted for the simulated representative NHEC and HEC loads to demonstrate their in-flight handling and separation characteristics. Each placard, marking, and flight manual supplement should be validated during flight testing.
 - (A) General: flight testing or an equivalent combination of analysis, ground tests, and flight tests should be conducted under the critical combinations of configurations and operating conditions for which basic type certification approval is sought. The critical load condition of the intended cargo (e.g. rocks, lumber, radio towers, HEC) may be defined by a heavy weight and low area cargo or a low weight and high area cargo. The effects of these load conditions should be evaluated throughout the operational aspects of cargo loading, take-off, cruise up to maximum allowable speed with cargo, jettison, and landing. The helicopter handling with different cable conditions should include lateral transitions and quick stops up to the helicopter approved low airspeed limitations. Additional combinations of external load and operating conditions may be subsequently approved under relevant operational requirements as long as the structural limits and reliability considerations of the basic certification approval are not exceeded (i.e. equivalent safety is maintained). The qualification flight test of this subparagraph is intended to be accomplished primarily by analysis or bench testing. However, at least one in-flight, limit load drop test should be conducted for the critical load case. If one critical load case cannot be clearly identified, then more than one drop test might be necessary. Also, in-flight tests for the minimum load case (i.e. typically the cable hook itself) with the load trailing both in the minimum and maximum cable length configurations should be conducted. Any safety-of-flight limitations should be documented and placed in the RFM or RFMS. In certain low-gross weight, jettisonable HEC configurations, the complex PCDS may act as a trailing aerofoil that could result in entangling the complex PCDS with the rotorcraft. These configurations should be assessed on a case-by-case basis by analysis or flight test to ensure that any safety-of-flight limitations are clearly identified and placed in the RFM or RFMS (also see PCDS).
 - (B) Separation characteristics of jettisonable external loads. For all jettisonable RLCs of any applicable cargo type, satisfactory post-jettison separation characteristics of all loads should meet the minimum criteria that follow:
 - (1) Separate functioning of the PQRS and BQRS resulting in a complete, immediate release of the external load without interference by the rotorcraft or external load system.

- (2) No damage to the helicopter during or following actuation of the QRS and load jettisoning.
 - (3) A jettison trajectory that is clear of the helicopter.
 - (4) No inherent instability of the jettisonable (or just jettisoned) HEC or NHEC while in proximity to the helicopter.
 - (5) No adverse or uncontrollable helicopter reactions at the time of jettison.
 - (6) Stability and control characteristics after jettison that are within the originally approved limits.
 - (7) No adverse degradation on helicopter performance characteristics after jettison.
- (C) Jettison requirements for jettisonable external loads: for representative cargo types (low, medium, and high density loads on long and short lines), emergency and normal jettison procedures should be demonstrated (by a combination of analysis, ground tests, and flight tests) in sufficient combinations of flight conditions to establish a jettison envelope that should be placed in the flight manual.
- (D) QRS demonstration. Repetitive jettison demonstrations that use the PQRS, which may be accomplished during ground or flight tests, should be conducted. The BQRS should be utilised at least once.
- (E) QRS reliability (i.e. failure modes) affecting flight performance. The FHA of the QRS (see paragraph c.(2) above) should show that any single system failure will not result in unsatisfactory flight characteristics, including any QRS failures resulting in asymmetric loading conditions.
- (F) Flight test weight and CG locations: all flight tests should be conducted at the extreme or critical combinations of weight and longitudinal and lateral CG conditions within the applied for flight envelope. Typically the two load conditions would be a heavy weight and low area cargo, and a low weight and high area cargo. The rotorcraft should remain within approved weight and CG limits, both with the external load applied, and after jettison of the load.
- (G) Jettison Envelopes. Emergency and normal jettison demonstrations should be performed at sufficient airspeeds and descent rates to establish any restrictions for satisfactory separation characteristics. Both the maximum and minimum airspeed limits and the maximum descent rate for safe separation should be determined. The sideslip envelope as a function of airspeed should be determined.
- (H) Altitude. Emergency and normal jettison demonstrations should be performed at altitudes that are consistent with the approvable operational envelope and with the manoeuvres necessary to overcome any adverse effects of the jettison.
- (I) Attitude. Emergency and normal jettison demonstrations should be performed from all attitudes that are appropriate to normal and emergency operational usage. Where the attitudes of HEC or NHEC with respect to the

helicopter may be varied, the most critical attitude should be demonstrated. This demonstration would normally be accomplished by bench testing.

- (4) Rotorcraft Flight Manual (RFM) and Rotorcraft Flight Manual Supplement (RFMS):
- (i) General.
 - (A) Present appropriate flight manual procedures and limitations for all HEC operations.
 - (1) The approval of an external loads equipment design in accordance with [CS 29.865](#) does not provide an approval to conduct external loads operations. Therefore, the following should be included as a limitation in the RFM or RFMS:
 - *The external load equipment certification approval does not constitute an operational approval; an operational approval for external load operations must be granted by the competent authority.*
 - (2) The RFM or RFMS that will be approved through the certification activity should not contain any references to the previously used RLC classes.
 - (B) For non-HEC designs, the following limitation should be included within the RFM or RFMS:
 - *The external load system does not comply with the CS-29 certification provisions for Human External Cargo (HEC).*
 - (C) The RFM or RFMS may contain suitable text to clarify whether the external load system meets the applicable certification provisions for lifting an external load free of land or water and whether the load is jettisonable.
 - (D) The RFM or RFMS should contain emergency procedures detailing the steps to be taken by the flight crew during emergencies such as an engine failure, hoist failure, flight director or autopilot failure, etc.
 - (E) The RFM or RFMS normal procedures should explain the required procedures to conduct a safe external load operation. Such information may include the methods for attachment and normal release of the external load.
 - (ii) HEC installations.
 - (A) For HEC installations, the following additional information/limitation should be included in the RFM or RFMS:
 - (1) That the external load system meets the CS-29 certification specifications for Human External Cargo (HEC).
 - (2) Operation of the external load equipment with HEC requires the use of an approved Personnel Carrying Device Systems (PCDS). NOTE: for a simple PCDS, also refer to [AMC No. 2 to 29.865](#)
 - (B) Crew member communications.
 - (1) The flight manual should clearly define the method of communication between the flight crew and the HEC. These instructions and manuals should be validated during flight testing.

-
- (2) If the external load system does not include equipment to allow direct intercommunication among required crew members and external occupants, the following limitation may be included within the limitations section of the RFM or RFMS:
- *This external load system does not include equipment to allow direct intercommunication among required crew members and external occupants. Operating this external load equipment with HEC is not authorised unless appropriate equipment to allow direct intercommunication between required crew members and external occupants has an airworthiness approval.*
- (iii) Additional RFM or RFMS requirements are contained within each applicable paragraph of this AMC.
- (5) Continued airworthiness.
- (i) Instructions for Continued Airworthiness: maintenance manuals (and RFM supplements) developed by applicants for external load applications should be presented for approval and should include all appropriate inspection and maintenance procedures. The applicant should provide sufficient data and other information to establish the frequency, extent, and methods of inspection of critical structure, systems, and components. [CS 29.1529](#) and [Appendix A](#) to CS-29 requires this information to be included in the maintenance manual. For example, maintenance requirements for sensitive QRS squibs should be carefully determined, documented, approved during certification, and included as specific mandatory scheduled maintenance requirements that may require either ‘daily’ or ‘pre-flight’ checks (especially for HEC applications).
 - (ii) Hoist system continued airworthiness. The design life of the hoist system and any limited life components should be clearly identified, and the Airworthiness Limitations Section of the maintenance manual should include these requirements. For STCs, a maintenance manual supplement should be provided that includes these requirements. Note: the design life of a hoist and cable system is typically between 5 000 and 8 000 cycles. Some hoist systems have usage time meters installed. Others may have cycle counters installed. Cycle counters should be considered for HEC operations and high-load or other operations that may cause low-cycle fatigue failures.
- (6) [CS 29.865\(a\)](#) Static Structural Substantiation and [CS 29.865\(f\)](#) Fatigue Substantiation Procedures: The following static structural substantiation methods and fatigue substantiation should be used:
- (i) Critical Basic Load Determination. The critical basic loads and corresponding flight envelope are determined by statically substantiating the gross weight range limits, the corresponding vertical limit load factors (N_{ZW}) and the safety factors applicable for the type of external load for which the application is being made.
- NOTE: in cases where NHEC or HEC can have more than one shape, centre of gravity, centre of lift, or be carried at more than one distance in-flight from the rotorcraft attachment, a critical configuration for certification purposes may not be determinable. If such a critical configuration can be determined, it may be examined for approval as a ‘worst case’ to satisfy a particular certification criterion or several criteria, as appropriate. If such a critical configuration cannot be

determined, the extreme points of the operational external load configuration envelope should be examined, with consideration given to any other points within the envelope that experience or any other rationale indicates as points that need to be investigated.

- (ii) Vertical Limit and Ultimate Load Factors. The basic N_{ZW} is converted to the ultimate load by multiplying the maximum vertical limit load by the appropriate safety factor (for restricted category approvals, see the guidance in paragraph AC 29 MG 5 of FAA AC 29-2C Change 7). This ultimate load is used to substantiate all the existing structure affected by, and all the added structure associated with, the load-carrying device, its attachments and its cargo. Casting factors, fitting factors, and other dynamic load factors should be applied where appropriate.
 - (A) NHEC applications. In most cases, it is acceptable to perform a standard static analysis to show compliance. A vertical limit load factor (N_{ZW}) of 2.5 g is typical for heavy gross weight NHEC hauling configurations (ref.: [CS 29.337](#)). This vertical load factor should be applied to the maximum external load for which the application is being made, together with a minimum safety factor of 1.5.
 - (B) HEC applications.
 - (1) If a safety factor of 3.0 or more is used, it is acceptable to perform a standard static analysis to show compliance. The safety factor should be applied to the yield strength of the weakest component in the system (QRS, complex PCDS, and attachment load path). If a safety factor of less than 3.0 is used, both an analysis and a full-scale ultimate load test of the relevant parts of the system should be performed.
 - (2) Since HEC applications typically involve lower gross weight configurations, a higher vertical limit load factor is required to assure that the limit load is not exceeded in service. The applicant should use either the conservative value of 3.5 g or an analytically derived maximum vertical limit load factor for the requested operating envelope. Linear interpolation between the vertical load factors of the maximum and minimum design weights may be used. However, in no case may the vertical limit load factor be less than 2.5 g for any HEC application.
 - (3) For the purpose of structural analysis or test, applicants should assume a 101.2-kg (223-pound) man as the minimum weight of each occupant carried as HEC.

NOTE: if the HEC is engaged in work tasks that employ devices of significant added weight (e.g. heavy backpacks, tools, fire extinguishers, etc.), the total weight of the 101.2-kg (223-pound) man and their equipment should be assumed in the structural analysis or test.
- (iii) Critical Structural Case. For applications involving more than one RLC class or cargo type, the structural substantiation is required only for the most critical case. The most critical case should be determined by rational analysis.

(iv) Jettisonable Loads. For the substantiating analyses or tests of all jettisonable external loads, including HEC, the maximum external load should be applied at the maximum angle that can be achieved in service, but not less than 30 degrees. The angle should be measured from the sling-load-line to the rotorcraft vertical axis (z axis) and may be in any direction that can be achieved in service. The 30-degree angle may be reduced in some or all directions if it is impossible to obtain due to physical constraints or operating limitations. The maximum allowable cable angle should be determined and approved. The angle approved should be based on structural requirements, mechanical interference limits, and flight-handling characteristics over the most critical conditions and combinations of conditions in the approved flight envelope.

(v) Hoist System Limit Load.

NOTE: if a hoist cable or a long-line cable is utilised, a new dynamic system is established. The characteristics of the system should be evaluated to assure that either no hazardous failure modes exist or that they are acceptably minimised. For example, the hoist cable or long-line cable may exhibit a natural frequency that could be excited by sources internal to the overall structural system (i.e. the rotorcraft) or by sources external to the system. Another example is the loading effect of the cable acting as a spring between the rotorcraft and the suspended external load.

(A) Determine the basic loads that would result in the failure or unspooling of the hoist or its installation, respectively.

NOTE: this determination should be based on static strength and any significant dynamic load magnification factors.

(B) Select the lower of the two values as the ultimate load of the hoist system installation.

(C) Divide the selected ultimate load by 1.5 to determine the true structural limit load of the system.

(D) Determine the manufacturer's approved 'limit design safety factor' (or that which the applicant has applied for). Divide this factor into the true structural limit load (from (C) above) to determine the hoist system's working (or placarded) limit load.

(E) Compare the system's derived limit load to the applied for one 'g' payload multiplied by the maximum downward vertical load factor (N_{ZWMAX}) to determine the critical payload's limit value.

(F) The critical payload limit should be equal to or less than the system's derived limit load for the installation to be approvable.

(vi) Fatigue Substantiation Procedures

NOTE: the term 'hazard to the rotorcraft' is defined to include all hazards to either the rotorcraft, to the occupants thereof, or both.

(A) Fatigue evaluation of NHEC applications. Any critical components of the suspended system and their attachments (e.g. the cargo hook, or bolted or pinned truss attachments), the failure of which could result in a hazard to the rotorcraft, should be included in an acceptable fatigue analysis.

- (B) Fatigue evaluation of HEC applications. The entire external load system, including the complex PCDS, should be reviewed on a component-by-component basis to determine which, if any, components are fatigue critical. These components should be analysed or tested to ensure that their fatigue life limits are properly determined, and the limits should then be placed in the limited life section of the maintenance manual.
- (7) CS 29.865(b) and CS 29.865(c) Procedures for Quick-Release Systems and Cargo Hooks: for jettisonable RLCs of any applicable cargo type, both a primary quick-release system (PQRS) and a backup quick-release system (BQRS) are required. Features that should be considered are:
- (i) The PQRS, BQRS and their load-release devices and subsystems (such as electronically actuated guillotines) should be separate (i.e. physically, systematically, and functionally redundant).
 - (ii) The controls for the PQRS should be installed on one of the pilot's primary controls, or in an equivalently accessible location. The use of an 'equivalent accessible location' should be reviewed on a case-by-case basis and utilised only where equivalent safety is clearly maintained.
 - (iii) The controls for the BQRS may be less sophisticated than those of the PQRS. For instance, manual cable cutters are acceptable provided they are listed in the flight manual as a required device and have a dedicated, placarded storage location.
 - (iv) The PQRS should release the external load in less than 5 seconds. The BQRS should release the external load in less than 30 seconds. This time interval begins the moment an emergency is declared and ends when the load is released.
 - (v) Each quick-release device should be designed and located to allow the pilot or a crew member to accomplish external cargo release without hazardously limiting the ability to control the rotorcraft during emergency situations. The flight manual should reflect the requirement for a crew member and their related functions.
 - (vi) CS 29.865(c)(1) QRS Requirements for Jettisonable HEC Operations.
 - (A) For jettisonable HEC operations, both the PQRS and BQRS are required to have a dual activation device (DAD) for external cargo release. The DAD should be designed to require two actions with a definite change of direction of movement, such as opening a switch or pushbutton cover followed by a definite change of direction in order to activate the release switch or pushbutton. Any possibility of opening the switch cover and inadvertently releasing the load with a single motion is not acceptable. An additional level of safety may also be provided through the use of Advisory and Caution messages. For example, an advisory 'ON' message might be illuminated when the pilot energises (but not arms) the system with a master switch. A cautionary 'ARMED' message would then illuminate when the pilot opens the switch guard. In this case, a possible unwanted flip of the switch guard would be immediately recognised by the crew. The switch design should be evaluated by ground or flight test. The RFM or RFMS should contain a clear description of the DAD functionality that includes the associated safety features, normal and emergency procedures, and applicable advisory and caution messages.

- (B) The DAD is intended for emergency use during the phases of flight in which the HEC is carried or retrieved. The DAD can be used for both NHEC and HEC operations. However, because it can be used for HEC, the instructions for continued airworthiness should be carefully reviewed and documented. The DAD can be operated by the pilot from a primary control or, after a command is given by the pilot, by a crew member from a remote location. Additional safety precautions (such as a lock wire) should be considered for remote hoist console in the cabin. Any emergency release function provided by a remote hoist console should also be designed to protect against inadvertent activation during the hoist operation. If the backup DAD is a cable cutter, it should be properly secured, placarded and readily accessible to the crew member who is intended to use it.
- (vii) CS 29.865(b)(3)(ii) Electromagnetic Interference. Protection of the QRS against potential internal and external sources of EMI and lightning is required. This is necessary to prevent an inadvertent load release from sources such as lightning strikes, stray electromagnetic signals, and static electricity.
- (A) Jettisonable NHEC systems should not be adversely affected when exposed to the electrical field of a minimum of 20 volts per metre (i.e. CAT U or equivalent) radio-frequency (RF) field strength per RTCA Document DO-160/ EUROCAE ED-14.
- (B) Jettisonable HEC systems should not be adversely affected when exposed to the electrical field of a minimum of 200 volts per metre (i.e. CAT Y) RF field strength per RTCA Document DO-160/ EUROCAE ED-14.
- (1) These RF field threat levels may need to be increased for certain special applications such as microwave tower and high voltage high line repairs. Separate criteria for special applications under multi-agency regulation (such as IEEE or OSHA standards) should also be addressed, as applicable, during certification. When necessary, the Special Condition process can be used to establish a practicable level of safety for specific high voltage or other special application conditions. The helicopter High-intensity Radiated Fields (HIRF) safety assessment should consider the effects on helicopter flight safety due to a HIRF-induced failure or malfunction of external load systems, such as an uncommanded hoist winch activation without the ability to jettison, or an uncommanded load jettison. The appropriate failure effect classification should be assigned based on this assessment, and compliance should be demonstrated with [CS 29.1317](#) and the guidance in AMC 20-158. This should not be limited to the cable cutter devices or load jettison subsystems only. In some designs, an uncommanded load release or a hoist winch activation could also result from a failure of the command and control circuits of the system.
- (2) An approved standard rotorcraft test, which includes the full HIRF frequency and amplitude external and internal environments, on the QRS and any applicable complex PCDS, or the entire rotorcraft including the QRS and any applicable complex PCDS, could be substituted for the jettisonable NHEC and HEC systems tests as long as the RF field strengths directly on the QRS and PCDS are shown to

- equal or exceed those defined by paragraphs c.(7)(vii)(A) and c.(7)(vii)(B) above for NHEC and HEC respectively.
- (3) The EMI levels specified in paragraphs c.(7)(vii)(A) and c.(7)(vii)(B) above are total EMI levels to be applied to the QRS (and affected QRS component) boundary. The total EMI level applied should include the effects of both external EMI sources and internal EMI sources. All aspects of internally generated EMI should be carefully considered including peaks that could occur from time-to-time due to any combination of on-board systems being operated. For example, special attention should be given to EMI from hoist operations that involve the switching of very high currents. Those currents can generate significant voltages in closely spaced wiring that, if allowed to reach some squib designs, could activate the device. Shielding, bonding, and grounding of wiring associated with operation of the hoist and the quick-release mechanism should be clearly and adequately evaluated in design and certification. When recognised good practices for such installation are applied, an analysis may be sufficient to highlight that the maximum possible pulse generated into the squib circuit will have an energy content orders of magnitude below the squib no-fire energy. If insufficient data is available for the installation and/or the squib no fire energy, this evaluation may require testing. One acceptable test method to demonstrate the adequacy of QRS shielding, bonding, and grounding would be to actuate the hoist under maximum load, together with likely critical combinations of other aircraft electrical loads, and demonstrate that the test squibs (which are more EMI sensitive than the squibs specified for use in the QRS) do not inadvertently operate during the test.
- (8) Cargo Hooks or Equivalent Devices and their Related Systems. All cargo hooks or equivalent devices should be approved to acceptable aircraft industry standards. The applicant should present these standards, and any related manufacturer's certificates of production or qualification, as part of the approval package.
- (i) General. Cargo hook systems should have the same reliability goals and should be functionally demonstrated under the critical loads for NHEC and HEC, as appropriate. All engagement and release modes should be demonstrated. If the hook is used as a quick-release device, then the release of critical loads should be demonstrated under conditions that simulate the maximum allowable bank angles and speeds and any other critical operating conditions. Demonstration of any re-latching features and any safety or warning devices should also be conducted. Demonstration of actual in-flight emergency quick-release capability may not be necessary if the quick-release capability can be acceptably simulated by other means.
- NOTE: Cargo hook manufacturers specify particular shapes, sizes, and cross sections for lifting eyes to assure compatibility with their hook design (e.g. Breeze Eastern Service Bulletin CAB-100-41). Experience has shown that, under certain conditions, a load may inadvertently hang up because of improper geometry at the hook-to-eye interface that will not allow the eye to slide off an open hook as intended.

For both NHEC and HEC designs, the phenomenon of hook dynamic roll-out (inadvertent opening of the hook latch and subsequent release of the load) should be considered to assure that QRS reliability goals are not compromised. This is of particular concern for HEC applications. Hook dynamic roll-out occurs during certain ground-handling and flight conditions that may allow the lifting eye to work its way out of the hook.

Hook dynamic roll-out typically occurs when either the RLC's sling or harness is not properly attached to the hook, is blown by down draft, is dragged along the ground or through water, or is otherwise placed into a dangerous hook-to-eye configuration.

The potential for hook dynamic roll-out can be minimised in design by specifying particular hook-and-eye shape and cross-section combinations. For non-jettisonable RLCs, a pin can be used to lock the hook-keeper in place during operations.

Some cargo hook systems may employ two or more cargo hooks for safety. These systems are approvable. However, a loss of any load by a single hook should be shown to not result in a loss of control of the rotorcraft. In a dual hook system, if the hook itself is the quick-release device (i.e. if a single release point does not exist in the load path between the rotorcraft and the dual hooks), the pilot should have a dual PQRS that includes selectable, co-located individual quick releases that are independent for each hook used. A BQRS should also be present for each hook. For cargo hook systems with more than two hooks, either a single release point should be present in the load path between the rotorcraft and the multiple hook system, or multiple PQRSs and BQRSs should be present.

- (ii) Jettisonable Cargo Hook Systems. For jettisonable applications, each cargo hook:
 - (A) should have a sufficient amount of slack in the control cable to permit cargo hook movement without tripping the hook release;
 - (B) should be shown to be reliable.
 - (C) For HEC systems, unless the cargo hook is to be the primary quick-release device, each cargo hook should be designed so that operationally induced loads cannot inadvertently release the load. For example, a simple cargo hook should have a one-way, spring-loaded gate (i.e. 'snap hook') that allows load attachment going into the gate but does not allow the gate to open (and subsequently lose the HEC) when an operationally induced load is applied in the opposite direction. For HEC applications, cargo hooks that also serve as quick-release devices should be carefully reviewed to assure they are reliable.
- (iii) Other Load Release Types. In some current configurations, such as those used for high-line operations, a load release may be present that is not on the rotorcraft but is on the PCDS itself. Examples are a tension-release device that lets out line under an operationally induced load, or a personal rope cutter. For long-line/sling operations, a load release may also be present that is not on the rotorcraft but is a remote release system. The long-line remote release allows the pilot to not release the line itself during repetitive loading operations. The release of the load by a dedicated switch at the pilot controls, through the secondary hook on a long line, presents additional risks due to the possibility of the long line impacting the tail or the main rotor after a release, due to its elasticity. These devices are acceptable if:

- (A) The off-rotorcraft release is considered to be a 'third release' means. This type of release is not a substitute for a required release (i.e. PQRS or BQRS);
- (B) The cargo hook release, and the long line remote release are placed on the primary controls in a way that avoids confusion during operation. One example of compliance would be to place the cargo hook release on the cyclic, and the long line remote release on the collective, to avoid any possible confusion in the operation;
- (C) The RFM or RFMS includes a description of the new control in the cockpit, and its function and an RFM or RFMS note to the pilot is included, indicating that the helicopter hook emergency release procedures are fully applicable;
- (D) The release meets all the other relevant requirements of [CS 29.865](#) and the methods of this AMC or equivalent methods; and
- (E) The release has no operational or failure modes that would affect continued safe flight and landing under any operations, critical failure modes, conditions, or combinations of these.

For long-line remote release, the following points should be considered:

- (1) The long line should not be of an elastic material that allows spring up/rebound when unloaded or elevated dynamics when loaded.
 - (2) The long line should have a residual weight that allows its release from the helicopter hook when the long line is unloaded.
 - (3) The RFM or RFMS should include all operating procedures to ensure that the long line does not impact the rotors after cargo release or during unloaded flight phases.
 - (4) The hook should be designed to minimise inadvertent activation. An example may be a protective device (cage) around the locking mechanism of the long line hook.
 - (5) A means should be provided to prevent any fouling of cables in the event of a rotation of the external load. An example may be the inclusion of a swivel or slip ring.
 - (6) Installation of a long line that is provided with electrical wiring to control the hook will generally represent a new electromagnetic coupling path from the external area to the internal systems that may not have been considered for type certification. As such, the impact of this installation on the coupling to helicopter systems, due to direct connection or cross talk to wiring, should be addressed as part of compliance with [CS 29.610](#), [29.1316](#) and [29.1317](#).
- (9) Cable
- (i) Cable attachment. Either the cable should be positively attached to the hoist drum and this attachment should have ultimate load capability or an equivalent means should be provided to minimise the possibility of inadvertent, complete cable unspooling.
 - (ii) Cable length and marking. A length of cable closest to the cable's attachment to the hoist drum should be visually marked to indicate to the operator that the cable is near full extension. The length of the cable to be marked is a function of the

maximum extension speed of the system and the operator's reaction time needed to prevent cable run out. It should be determined during certification demonstration tests. In no case should the length be less than 3.5 drum circumferences.

- (iii) Cable stops. Means should be present to automatically stop cable movement quickly when the system's extension and retraction operational limits are reached.
- (10) CS 29.865(c)(2) PCDS: for all HEC applications that use complex PCDSs, an approval is required. The complex PCDS may be either previously approved or is required to be approved during certification. In either case, its installation should be approved.

NOTE: Complex PCDS designs can include relatively complex devices such as multiple occupant cages or gondolas. The purpose of the PCDS is to provide a minimum acceptable level of safety for personnel being transported outside the rotorcraft. The personnel being transported may be healthy or injured, conscious or unconscious.

- (i) Regulation (EU) No 965/2012 on Air Operations contains the minimum performance specifications and standards for simple PCDSs, such as HEC body harnesses.
- (ii) Static Strength. The complex PCDS should be substantiated for the allowable ultimate load and loading conditions as determined under paragraph c(6) above.
- (iii) Fatigue. The complex PCDSs should be substantiated for fatigue as determined under paragraph c(6) above.
- (iv) Personnel Safety. For each complex PCDS design, the applicant should submit a design evaluation that assures the necessary level of personnel safety is provided. As a minimum, the following should be evaluated.
 - (A) The complex PCDS should be easily and readily entered or exited.
 - (B) It should be placarded with its proper capacity, the internal arrangement and location of occupants, and ingress and egress instructions.
 - (C) For door latch fail-safety, more than one fastener or closure device should be used. The latch device design should provide direct visual inspectability to assure it is fastened and secured.
 - (D) Any fabric used should be durable and should be at least flame-resistant.
 - (E) Reserved
 - (F) Occupant retention devices and the related design safety features should be used as necessary. In simple designs, rounded corners and edges with adequate strapping (or other means of HEC retention relative to the complex PCDS) and head supports or pads may be all the safety features that are necessary. Complex PCDS designs may require safety features such as seat belts, handholds, shoulder harnesses, placards, or other personnel safety standards.
- (v) EMI and Lightning Protection. All essential, affected components of the complex PCDS, such as intercommunication equipment, should be protected against RF field strengths to a minimum of RTCA Document DO-160/ EUROCAE ED-14 CAT Y.
- (vi) Instructions for Continued Airworthiness. All instructions and documents necessary for continued airworthiness, normal operations and emergency

operations should be completed, reviewed and approved during the certification process. There should be clear instructions to describe when the complex PCDS is no longer serviceable and should be replaced in part or as a whole due to wear, impact damage, fraying of fibres, or other forms of degradation. In addition, any life limitations resulting from compliance with paragraphs c.(10)(ii) and (iii) should be provided.

- (vii) Flotation Devices. Complex PCDSs that are intended to have a dual role as flotation devices or life preservers should meet the relevant requirements for 'Life Preservers'. Also, any complex PCDS design to be used in the water should have a flotation kit. The flotation kit should support the weight of the maximum number of occupants and the complex PCDS in the water and minimise the possibility of the occupants floating face down.
- (viii) Considerations for flight testing. It should be shown by flight tests that the device is safely controllable and manoeuvrable during all requested flight regimes without requiring exceptional piloting skill. The flight tests should entail the complex PCDS weighted to the most critical weight. Some complex PCDS designs may spin, twist or otherwise respond unacceptably in flight. Each of these designs should be structurally restrained with a device such as a spider, a harness, or an equivalent device to minimise undesirable flight dynamics.
- (ix) Medical Design Considerations. Complex PCDSs should be designed to the maximum practicable extent and placarded to maximise the HEC's protection from medical considerations such as blocked air passages induced by improper body configurations and excessive losses of body heat during operations. Injured or water-soaked persons may be exposed to high body heat losses from sources such as rotor washes and airstreams. The safety of occupants of complex PCDSs from transit-induced medical considerations can be greatly increased by proper design.
- (x) Hoist operator safety device. When hoisting operations require the presence of a hoist operator on board, appropriate provisions should be provided to allow the hoist operator to perform their task safely. These provisions shall include an appropriate hoist operator restraint system. This safety device is typically composed of a safety harness and a strap attached to the cabin used to adequately restrain the hoist operator inside the cabin while operating the hoist. For certification approval, the hoist operator safety device should comply with [CS 29.561\(b\)\(3\)](#) for personnel safety. The applicant should submit a design evaluation that assures the necessary level of personnel safety is provided. As a minimum, the following should be evaluated:
 - (A) The strap attaching point on the body harness should be appropriately located in order to minimise as far as is practicable the likelihood of injury to the wearer in the case of a fall or crash.
 - (B) The safety device should be designed to be adjustable so that the strap is tightened behind the hoist operator.
 - (C) The strap should allow the hoist operator to detach themselves quickly from the cabin in emergency conditions (e.g. crash, ditching). For that purpose, it should include a QRS including a DAD.
 - (D) The safety device should be easily and readily donned or doffed.
 - (E) It should be placarded with its proper capacity and lifetime limitation.

- (F) Any fabric used should be durable and should be at least flame resistant.
- (11) CS 29.865(c)(4) Intercom Systems for HEC Operations: for all HEC operations, the rotorcraft is required to be equipped for, or otherwise allow, direct intercommunication under any operational conditions among crew members and the HEC. An intercommunications system may also be approved as part of the external load system, or alternatively, a limitation may be placed in the RFM or RFMS as described under paragraph c.(4)(ii)(B)(2) of this AMC.
- (12) CS 29.865(c)(6) Limitations for HEC Operations: for jettisonable HEC operations, a rotorcraft may be required by operations requirements to meet the Category A engine isolation requirements of CS-29 and to have one-engine-inoperative/out-of-ground effect (OEI/OGE) hover performance capability in its approved, jettisonable HEC weight, altitude, and temperature envelope.
- (i) In determining OEI hover performance, dynamic engine failures should be considered. Each hover verification test should begin from a stabilised hover at the maximum OEI hover weight, at the requested in-ground-effect (IGE) or OGE skid or wheel height, and with all engines operating. At this point, the critical engine should be failed and the aircraft should remain in a stabilised hover condition without exceeding any rotor limits or engine limits for the operating engine(s). As with all performance testing, engine power should be limited to the minimum specification power.
- (ii) Normal pilot reaction time should be used, following the engine failure, to maintain the stabilised hover flight condition. When hovering OGE or IGE at the maximum OEI hover weight, an engine failure should not result in an altitude loss of more than 10 per cent or 4 feet, whichever is greater, of the altitude established at the time of engine failure. In either case, a sufficient power margin should be available from the operating engine(s) to regain the altitude lost during the dynamic engine failure and to transition to forward flight.
- (iii) Consideration should also be given to the time required to recover (winch up and bring aboard) the human external cargo and to transition to forward flight. This time increment may limit the use of short-duration OEI power ratings. For example, for a helicopter that sustains an engine failure at a height of 40 feet, the time required to re-stabilise in a hover, recover the external load (given the hoist speed limitations), and then transition to forward flight (with minimal altitude loss) would likely preclude the use of the 30-second engine ratings and may encroach upon the 2 ½-minute ratings. Such an encroachment into the 2 ½-minute ratings is not acceptable.
- (iv) The rotorcraft flight manual (RFM) should contain information that describes the expected altitude loss, any special recovery techniques, and the time increment used for recovery of the external load when establishing maximum weights and wheel or skid heights. The OEI hover chart should be placed in the performance section of the RFM or RFM supplement. The allowable altitude extrapolation for the hover data should not exceed 2 000 feet.

-
- (13) For helicopters that incorporate engine-driven generators, the hoist should remain operational following an engine or generator failure. A hoist should not be powered from a bus that is automatically shed following the loss of an engine or generator. Maximum two-engine generator loads should be established so that when one engine or generator fails, the remaining generator can assume the entire rotorcraft electrical load (including the maximum hoist electrical load) without exceeding the approved limitations.
- (14) CS 29.865(e) External Loads Placards and Markings: placards and markings should be installed next to the external-load attaching means, in a clearly noticeable location, that state the primary operational limitations — specifically including the maximum authorised external load. Not all operational limitations need be stated on the placard (or equivalent markings); only those that are clearly necessary for immediate reference in operations. Other more detailed operational limitations of lesser immediate importance should be stated either directly in the RFM or in an RFM supplement.
- (15) Other Considerations
- (i) Agricultural Installations (AIs): AIs can be approved for either jettisonable or non-jettisonable NHEC or HEC operations as long as they meet relevant certification and operations requirements and follow appropriate compliance methods. However, most current AI designs are external fixtures (see definition), not external loads. External fixtures are not approvable as jettisonable external cargo because they do not have a true payload (see definition), true jettison capability (see definition), or a complete QRS. Many AI designs can dump their solid or liquid chemical loads by use of a ‘purge port’ release over a relatively long time period (i.e. greater than 30 seconds). This is not considered to be a true jettison capability (see definition) since the external load is not released by a QRS and since the release time span is typically greater than 30 seconds (ref.: b(20) and c(7)). Thus, these types of AIs should be approved as non-jettisonable external loads. However, other designs that have the entire AI (or significant portions thereof) attached to the rotorcraft, that have short time frame jettison (or release) capabilities provided by QRSs that meet the definitions herein and that have no post-jettison characteristics that would endanger continued safe flight and landing may be approved as jettisonable external loads. For example, if all the relevant criteria are properly met, a jettisonable fluid load can be approved as an NHEC external cargo. FAA AC 29-2C Change 7 AC 29 MG 5 discusses other AI certification methodologies.
 - (ii) External Tanks: external tank configurations that have true payload (see definition) and true jettison capabilities (see definition) should be approved as jettisonable NHEC. External tank configurations that have true payload capabilities but do not have true jettison capabilities should be approved as non-jettisonable NHEC. An external tank that has neither a true payload capability nor true jettison capability is an external fixture; it should not be approved as an external load under [CS 29.865](#). If an external tank is to be jettisoned in flight, it should have a QRS that is approved for the maximum jettisonable external tank payload and is either inoperable or is otherwise rendered reliable to minimise inadvertent jettisons above the maximum jettisonable external tank payload.

- (iii) **Logging Operations:** These operations are very susceptible to low-cycle fatigue because of the large loads and relatively high load cycles that are common to this industry. It is recommended that load-measuring devices (such as load cells) be used to assure that no unrecorded overloads occur and to assure that cycles producing high fatigue damage are properly considered. Cycle counters are recommended to assure that acceptable cumulative fatigue damage levels are identifiable and are not exceeded. As either a supplementary method or an alternate method, maintenance instructions should be considered to assure proper cycle counting and load recording during operations.

[Amdt No: 29/5]

[Amdt No: 29/6]

AMC No 2 to CS 29.865 External loads operations using simple personnel-carrying device systems

ED Decision 2018/015/R8/015/R

If required by the applicable operating rule or if an applicant elects to, this AMC provides a means of compliance for the airworthiness certification of a simple personnel-carrying device system (PCDS) and attaching means to the hook, providing safety factors and consideration of calendar life replacement limits in lieu of a dedicated fatigue analysis and test.

A PCDS is considered to be simple if:

- (a) it meets an EN standard under EC Directive 89/686/EEC, or Regulation (EU) 2016/425, as applicable, or subsequent revision;
- (b) it is designed to restrain no more than a single person (e.g. hoist or cargo hook operator, photographer, etc.) inside the cabin, or to restrain no more than two persons outside the cabin;
- (c) it is not a rigid structure such as a cage, a platform or a basket.

PCDSs that cannot be considered to be simple are considered to be complex.

Note 1: EASA or the relevant Authority should be contacted to confirm the classification in the event that:

- a PCDS includes new or novel features;
- a PCDS has not been proven by appreciable and satisfactory service experience; or
- there is any doubt in the classification.

Approval of Simple PCDSs

If the approval of a simple PCDS is requested, then Directive 89/686/EEC, or Regulation (EU) 2016/425 are an acceptable basis for the certification of a simple PCDS provided that:

- (a) the applicable Directive 89/686/EEC or Regulation (EU) 2016/425, as applicable, or subsequent revision and corresponding EN standards for the respective components are complied with (EC Type Examination Certificate);
- (b) the applicant for the minor change has obtained from the manufacturer and keeps on record the applicable EC Conformity Certificate(s).

Note 2: A simple PCDS has an EC Type Examination Certificate (similar to an STC), issued by a Notified Certification Body and, for the production and marketing, an EC Conformity Certificate (similar to an EASA Form 1) issued by the manufacturer.

Note 3: In cases where ropes or elements connect simple PCDSs to the hoist/cargo hook or internal helicopter cabin, the EN certification can be achieved by a body meeting the transposition into national law of the applicable EC/EU regulation.

The EC-certified components are appropriately qualified for the intended use and the environmental conditions.

Note 4: The intended use and corresponding risks must be considered when selecting EN standards. For example hoist operators and rescuers that have to work at the edge of the cabin or outside should have full body harnesses to address the risk of inversion. Litters and the corresponding restraint systems should be adequately designed for the loads that can be generated during spinning.

Note 5: The assembly of the different components should also consider the intended use. For example, the attachment of the tethering strap to the harness of a hoist operator should be of a DAD quick-release type to allow quick detachment from the aircraft following a ditching or emergency landing. The tethering strap should also be adjustable to take up slack and avoid shock loads being transmitted to other components.

- (c) The maximum load applied to each component between the HEC and the hook is conservatively estimated. This is particularly important when more than one person is attached by a single system to the cargo hook/ hoist. Appendix 1 defines the appropriate minimum ultimate load (U_{Lmin}). If U_{Lmin} is above the static strength currently declared by the supplier of the PCDS or of a component of the attachments, through compliance with an EN standard, then proof of sufficient strength is to be provided by static tests. All possible service load cases (including asymmetric load distribution) are to be considered. In this case, the PCDS and/or the attaching means (e.g. rope, carabineer, shackles, etc.) must be capable of supporting U_{Lmin} for a minimum of 3 minutes without failure. There should be no deformation of components that could allow the release of the HEC. Components and details added to the EN-approved equipment (such as splicing, knots, stitching, seams, press fits, etc.) or the materials used (textiles, composites, etc.) that might reduce the strength of a product or could (in combination) have other detrimental effects have been investigated by the applicant and accounted for in the substantiation.
- (d) The effects of ageing (due to sunlight, temperature, water immersion, etc.) and other operational factors that may affect the strength of the PCDS are accounted for through appropriate inspections and the application of a calendar life limit as appropriate. The PCDS and the related attachment elements are limited to the carriage of HEC.
- (e) The risk of fatigue failure is minimised. See section below for further details.
- (f) Instructions for Continued Airworthiness (ICA) should be provided. Typically, the ICA would comprise an inspection programme and maintenance instructions based on the applicable manufacturer's data. The ICA should ensure that specific operational uses of the system that might affect its strength are accounted for. A calendar life limit should be applied when appropriate.
- (g) When the harness is not designed to transport an incapacitated or untrained person, then the labelling and/or the user/flight manual should include a specific limitation of use as applicable.

Note 6: The following considerations and corresponding instructions/limitations should be taken for EN 1498 Type A and C rescue loops due to their potential detrimental physiological effects and the risk falling out:

- (a) whether life is in imminent risk;

- (b) the physical condition of the person to be hoisted, particularly whether the rescuee will remain conscious and coherent during the hoist process;
- (c) the potential for the person to remain compliant with the brief given prior to hoisting;
- (d) alternative methods and devices to recover the person; and
- (e) whether the risk of falling from the device would result in further serious injury or death.

Simple PCDS Helicopter Compatibility

The ingress/egress of the simple PCDS in the cabin should be verified on the specific rotorcraft by means of a test. The compatibility with the hoist hook, unless the ring is already specified in the RFM, should also be verified by means of a test.

The verification of the hook and simple PCDS compatibility should also verify the absence of any roll-out/jamming phenomenon in order to:

- (a) prevent any inadvertent release of the load from the cargo hook; and/or
- (b) prevent the ring from jamming on the load beam during the release.

Manufacturing and Identification

Simple PCDSs that comply with Directive 89/686/EEC, or Regulation (EU) 2016/425, as applicable, or subsequent revision and the corresponding EN standards for the respective components are labelled by the manufacturer according to the applicable standard. If not already contained in the manufacturer labelling, the following additional information, as applicable, should be made visible on labelling on simple PCDSs:

- (a) manufacturing date;
- (b) life-limit date (if different from any existing one marked on the personal protective equipment (PPE));
- (c) manufacturer's identification;
- (d) part number;
- (e) serial number or unique identification of the single PCDS;
- (f) STC/minor change approval number (if applicable);
- (g) authorised load in kg;
- (h) authorised number of persons;
- (i) Any other limitation not recorded in the manufacturer labelling.

Simple PCDS Static Strength

The PCDS should be substantiated for the loading conditions determined under the applicable paragraphs of FAA AC 29.865. For a PCDS to be certified separately from the hoist, using the guidance of this certification memo, the minimum ultimate load (U_{Lmin}) to be substantiated is defined as follows:

$$U_{Lmin} = M \times n \times j \times jf \times K \times g \text{ (units are Newtons)}$$

Where:

M is the total mass of the PCDS equipment/component and persons restrained by the part being substantiated (this is equivalent to the working load rating of an EN). The mass of each person should be assumed to be 100 kg.

NOTE: If the person(s) or their task requires the personal carriage of heavy items (backpacks, tools, fire extinguishers, etc.), these must be accounted for in the total mass M , in addition to the person's mass of 100 kg.

n is the helicopter manoeuvring limit load factor and must be assumed = 3.5 ([CS 29.337](#) and [29.865](#)).

j is the ultimate load factor of safety for all parts = 1.5 ([CS 29.303](#)).

K is an additional safety factor for textiles = 2.0 (see NOTE 1) ([CS 29.619](#)).

jf is an additional fitting factor = 1.33 applying to all joints, fittings, etc. ([CS 29.619](#)).

g is the acceleration due to gravity of 9.81 m/s^2 .

The resulting values to ensure compliance with the CS-29 static strength requirements are:

U_{Lmin} for metallic elements with a fitting factor (needed for all joints and fittings): = 7 Mg.

(NOTE: To address fatigue, a value of 10 Mg may be required; see the section below on fatigue.)

U_{Lmin} for textiles (webbing, ropes, etc.) with fitting factor: = 14 Mg (see NOTE 1).

U_{Lmin} may be compared to the strength of the PCDS components already substantiated according to Directive 89/686/EEC, or Regulation (EU) 2016/425, as applicable, or subsequent revision and the corresponding EN Standards or Directive 2006/42/EC Annex I Point 6. Where U_{Lmin} is greater than that laid down in the Directives/EN requirements, a static test to not less than U_{Lmin} will be necessary. The test load must be sustained for 3 minutes. In addition, there should be no detrimental or permanent deformation of the metallic components at 3.5 Mg ([CS 29.305](#)).

NOTE 7: Directive 2006/42/EC Annex I Point 6 recommends a safety factor of 14 (2×7) for textiles applied to the working load (equivalent to 14 M above) for equipment lifting humans, whereas for a rescue harness, EN 1497 requires a static test load of not less than the greater of either 15 kN or 10 times the working load. Considering this difference, for each textile component within the PCDS certified to one of the following ENs, the value of K may be reduced, such that U_{Lmin} is not less than 10 Mg, where M is not more than 150 kg:

For harnesses, EN 361, EN 1497 or EN 12277A, EN 813 or EN 12277C apply; for belts or straps and for lanyards, EN 354 applies. This allowance is not applicable to ropes.

Furthermore, to allow this reduced value of U_{Lmin} and to address any potential deterioration of textiles due to environmental and other hidden damage, the ICA must include a life limitation of 5 years (or the life indicated by the PCDS manufacturer, if less) and an annual detailed inspection of the general condition of the harness.

Simple PCDS Fatigue

When the simple PCDS and the related attachment elements are limited to the carriage of HEC only, no further specific fatigue substantiation is necessary for each part of the simple PCDS that is either:

- (a) certified in accordance with an applicable EN that is referenced in this AMC for which the allowable working load is not exceeded by the mass M ; or
- (b) substantiated for static strength as described above with U_{Lmin} not less than 10 Mg.

[Amdt No: 29/5]

[Amdt No: 29/6]

MISCELLANEOUS

CS 29.871 Levelling marks

ED Decision 2003/16/RM

There must be reference marks for levelling the rotorcraft on the ground.

CS 29.873 Ballast provisions

ED Decision 2003/16/RM

Ballast provisions must be designed and constructed to prevent inadvertent shifting of ballast in flight.

SUBPART E — POWERPLANT

GENERAL

CS 29.901 Installation

ED Decision 2003/16/RM

- (a) For the purpose of this Code, the powerplant installation includes each part of the rotorcraft (other than the main and auxiliary rotor structures) that:
 - (1) Is necessary for propulsion;
 - (2) Affects the control of the major propulsive units; or
 - (3) Affects the safety of the major propulsive units between normal inspections or overhauls.
- (b) For each powerplant installation:
 - (1) The installation must comply with:
 - (i) The installation instructions provided under CS-E; and
 - (ii) The applicable provisions of this Subpart.
 - (2) Each component of the installation must be constructed, arranged, and installed to ensure its continued safe operation between normal inspections or overhauls for the range of temperature and altitude for which approval is requested.
 - (3) Accessibility must be provided to allow any inspection and maintenance necessary for continued airworthiness.
 - (4) Electrical interconnections must be provided to prevent differences of potential between major components of the installation and the rest of the rotorcraft.
 - (5) Axial and radial expansion of turbine engines may not affect the safety of the installation; and
 - (6) Design precautions must be taken to minimise the possibility of incorrect assembly of components and equipment essential to safe operation of the rotorcraft, except where operation with the incorrect assembly can be shown to be extremely improbable.
- (c) For each powerplant and auxiliary power unit installation, it must be established that no single failure or malfunction or probable combination of failures will jeopardise the safe operation of the rotorcraft except that the failure of structural elements need not be considered if the probability of any such failure is extremely remote.
- (d) Each auxiliary power unit installation must meet the applicable provisions of this Subpart.

CS 29.903 Engines

ED Decision 2003/16/RM

- (a) *(Reserved)*
- (b) *Category A; engine isolation.* For each Category A rotorcraft, the powerplants must be arranged and isolated from each other to allow operation, in at least one configuration, so that the failure or malfunction of any engine, or the failure of any system that can affect any engine, will not –
 - (1) Prevent the continued safe operation of the remaining engines; or
 - (2) Require immediate action, other than normal pilot action with primary flight controls, by any crew member to maintain safe operation.
- (c) *Category A; control of engine rotation.* For each Category A rotorcraft, there must be a means for stopping the rotation of any engine individually in flight, except that, for turbine engine installations, the means for stopping the engine need be provided only where necessary for safety. In addition –
 - (1) Each component of the engine stopping system that is located on the engine side of the firewall, and that might be exposed to fire, must be at least fire resistant; or
 - (2) Duplicate means must be available for stopping the engine and the controls must be where all are not likely to be damaged at the same time in case of fire.
- (d) *Turbine engine installation.* For turbine engine installations,
 - (1) Design precautions must be taken to minimise the hazards to the rotorcraft in the event of an engine rotor failure; and,
 - (2) The powerplant systems associated with engine control devices, systems, and instrumentation must be designed to give reasonable assurance that those engine operating limitations that adversely affect engine rotor structural integrity will not be exceeded in service.
- (e) *Restart capability:*
 - (1) A means to restart any engine in flight must be provided.
 - (2) Except for the in-flight shutdown of all engines, engine restart capability must be demonstrated throughout a flight envelope for the rotorcraft.
 - (3) Following the in-flight shutdown of all engines, in-flight engine restart capability must be provided.

CS 29.907 Engine vibration

ED Decision 2003/16/RM

- (a) Each engine must be installed to prevent the harmful vibration of any part of the engine or rotorcraft.
- (b) The addition of the rotor and the rotor drive system to the engine may not subject the principal rotating parts of the engine to excessive vibration stresses. This must be shown by a vibration investigation.

CS 29.908 Cooling fans

ED Decision 2003/16/RM

For cooling fans that are a part of a powerplant installation the following apply:

- (a) *Category A.* For cooling fans installed in Category A rotorcraft, it must be shown that a fan blade failure will not prevent continued safe flight either because of damage caused by the failed blade or loss of cooling air.
- (b) *Category B.* For cooling fans installed in Category B rotorcraft, there must be means to protect the rotorcraft and allow a safe landing if a fan blade fails. It must be shown that :
 - (1) The fan blade would be contained in the case of a failure;
 - (2) Each fan is located so that a fan blade failure will not jeopardise safety; or
 - (3) Each fan blade can withstand an ultimate load of 1.5 times the centrifugal force expected in service, limited by either:
 - (i) The highest rotational speeds achievable under uncontrolled conditions; or
 - (ii) An overspeed limiting device.
- (c) *Fatigue evaluation.* Unless a fatigue evaluation under [CS 29.571](#) is conducted, it must be shown that cooling fan blades are not operating at resonant conditions within the operating limits of the rotorcraft.

ROTOR DRIVE SYSTEM

CS 29.917 Design

ED Decision 2018/007/R

- (a) *General.* The rotor drive system includes any part necessary to transmit power from the engines to the rotor hubs. This includes gearboxes, shafting, universal joints, couplings, rotor brake assemblies, clutches, supporting bearings for shafting, any attendant accessory pads or drives, lubricating systems for drive system gearboxes, oil coolers and any cooling fans that are a part of, attached to, or mounted on the rotor drive system.
- (b) *Design assessment.* A design assessment must be performed to ensure that the rotor drive system functions safely over the full range of conditions for which certification is sought. The design assessment must include a detailed failure analysis to identify all failures that will prevent continued safe flight or safe landing, and must identify the means to minimise the likelihood of their occurrence.
- (c) *Arrangement.* Rotor drive systems must be arranged as follows:
- (1) Each rotor drive system of multi-engine rotorcraft must be arranged so that each rotor necessary for operation and control will continue to be driven by the remaining engines if any engine fails.
 - (2) For single-engine rotorcraft, each rotor drive system must be so arranged that each rotor necessary for control in autorotation will continue to be driven by the main rotors after disengagement of the engine from the main and auxiliary rotors.
 - (3) Each rotor drive system must incorporate a unit for each engine to automatically disengage that engine from the main and auxiliary rotors if that engine fails.
 - (4) If a torque limiting device is used in the rotor drive system, it must be located so as to allow continued control of the rotorcraft when the device is operating.
 - (5) If the rotors must be phased for intermeshing, each system must provide constant and positive phase relationship under any operating condition.
 - (6) If a rotor dephasing device is incorporated, there must be means to keep the rotors locked in proper phase before operation.

[Amdt No: 29/5]

AMC 29.917 Rotor drive system design

ED Decision 2018/007/R

This AMC provides further guidance and acceptable means of compliance to supplement FAA AC 29-2C § AC 29.917, to meet EASA's interpretation of CS 29.917. As such it should be used in conjunction with the FAA AC.

Vibration Health Monitoring: Where Vibration Health Monitoring is used as a compensating provision to meet [CS 29.917\(b\)](#), the design and performance of the vibration health monitoring system should be approved by requesting compliance with [CS 29.1465\(a\)](#).

For lubrication systems: a dedicated safety assessment should be performed that addresses all the lubrication systems of rotor drive system gearboxes and, in particular, the following:

-
- (a) Identification of any single failure, malfunction, or reasonably conceivable combinations of failures that may result in a loss of oil pressure, a loss of oil supply to the dynamic components or a loss of the oil scavenge function. This normally takes the form of a failure mode and effects analysis. Compensating provisions should be identified to minimise the likelihood of occurrence of these failures. The safety assessment should also consider potential assembly or maintenance errors that cannot be readily detected during specified functional checks.
- (b) The safety assessment should consider any specific design features which are subject to variability in manufacture or wear/degradation in service and which could have an appreciable effect on the maximum period of operation following loss of lubrication. Any features that may have a significant influence on the behaviour of the residual oil or the auxiliary lubrication system should be taken into account when determining the configuration of test articles.
- (c) Identification of the most severe failure mode that results in the shortest duration of time in which the gearbox should be able to operate following the indication to the flight crew of a normal-use lubrication system failure. This should be used for simulating lubrication failure during the CS 29.927(c) loss of lubrication test.
- (d) Auxiliary lubrication system: Where compliance with [CS 29.927\(c\)](#) is reliant upon the operation of an auxiliary lubrication system, sufficient independence between the normal-use and auxiliary lubrication systems should be substantiated. Common-cause failure analysis, including common-mode, particular-risk, and zonal safety analyses, should be performed. It should be established that no single failure or identified common-cause failure will prevent the operation of both the normal-use and the auxiliary lubrication systems, apart from any failures that are determined to be extremely remote lubrication failures. The effects of inadvertent operation of the auxiliary lubrication system should also be considered.
- (e) Definitions
- (1) Lubrication System Failure: in the context of [CS 29.917\(b\)](#), references to a failure of the lubrication system should be interpreted as any failure that results in a loss of pressure and an associated low oil pressure warning, within the duration of one flight.
 - (2) Most severe failure mode: the failure mode of the normal use lubrication system that results in the shortest duration of time in which the gearbox is expected to operate following an indication to the flight crew.
 - (3) Normal-use lubrication system: the lubrication system relied upon during normal operation.
 - (4) Auxiliary lubrication system: any lubrication system that is independent of the normal-use lubrication system.
 - (5) Independent: an auxiliary lubrication system should be able to function after a failure of the normal-use lubrication system. Failure modes which may result in the subsequent failure of both the auxiliary and the normal-use lubrication systems and which may prevent continued safe flight or safe landing should be shown to be extremely remote lubrication failures.
 - (6) Extremely remote lubrication failure: a lubrication failure where the likelihood of occurrence has been minimised, either by structural analysis in accordance with [CS 29.571](#) or laboratory testing. Alternatively, service experience or other means can be used which indicate a level of reliability comparable with one failure per 10 million hours. Failure modes including failures of external pipes, fittings, coolers, or hoses, and any components that require periodic removal by maintainers, should not be considered as extremely remote lubrication failures.

(f) Determination of the Most Severe Failure Mode

- (1) The objective of the loss of lubrication test is to demonstrate the operation of a rotor drive system gearbox following the most severe failure mode of the normal-use lubrication system. The determination of the most severe failure mode may not be immediately obvious, as leakage rates vary, and system performance following leaks from different areas varies as well. Thus, a careful analysis of the potential failure modes should be conducted, taking into account the effects of flight conditions if relevant.
- (2) The starting point for the determination of the most severe failure mode should be an assessment of all the potential lubrication system failure modes. This should be accomplished as part of the [CS 29.917\(b\)](#) design assessment, and include leaks from any connections between components that are assembled together, such as threaded connections, hydraulic inserts, gaskets, seals, and packing (O-rings). Failure modes, such as failures of external lines, failures of component retention hardware and wall-through cracks that have not been substantiated for [CS 29.307](#), [CS 29.571](#) and [CS 29.923\(m\)](#) should also be considered. The determination that a failure is an extremely remote lubrication failure, when used to eliminate a potential failure mode from being considered as a candidate most severe failure mode, should be substantiated. Where leakage rates or the effect of failure modes cannot be easily determined, then a laboratory test should be conducted. Once the most severe failure mode has been determined, this should form the basis of the conditions for the start of the test.

(g) Use of an auxiliary lubrication system

Use of an auxiliary lubrication system may be an acceptable means of providing extended operating time after a loss of lubrication. The auxiliary lubrication system should be designed to provide sufficient independence from the normal-use lubrication system. Since the auxiliary lubrication system is by definition integral to the same gearbox as the normal-use lubrication system, it may be impractical for it to be completely independent. Therefore, designs should be conceived such that shared components or interfaces between the normal-use and auxiliary lubrication systems are minimised and comply with the design assessment provisions of [CS 29.917\(b\)](#). A failure of any common feature shared by both the normal-use and auxiliary lubrication systems that could result in the failure of both systems, and would consequently reduce the maximum period of operation following loss of lubrication, should be shown to be an extremely remote lubrication failure. If compliance with [CS 29.927\(c\)](#) is reliant on the functioning of an auxiliary lubrication system, then:

- (1) in the unlikely event of a combined failure of both the normal-use lubrication system and the auxiliary lubrication system, the RFM emergency procedures should instruct the flight crew to 'Land immediately' unless testing representing this failure mode has been performed in order to substantiate that an increased duration is justified; and
- (2) a means of verifying that the auxiliary lubrication system is functioning properly should be provided during normal operation of the rotorcraft on either a periodic, pre-flight or continual basis. Following failure of the normal use lube system and activation of an auxiliary lubrication system the flight crew should be alerted in the event of any system malfunction.

- (h) Independence of the auxiliary lubrication system.
- (1) In order to ensure that the auxiliary lubrication system is sufficiently independent:
- (i) a failure of any pressurised portion of the normal-use lubrication system should not result in a subsequent failure of the auxiliary lubrication system;
 - (ii) common failure modes shown to defeat both the normal-use and the auxiliary lubrication systems should be shown to be extremely remote lubrication failures, unless it is demonstrated by testing conducted to comply with 29.927(c) that the failure mode does not compromise the 'Maximum period of operation following loss of lubrication'; and
 - (iii) control systems, logic and health-reporting systems should not be shared; consideration should be given to the design process to ensure appropriate segregation of the control and warning systems in the system architecture.
- (2) Methods which should be used to demonstrate that failure modes of common areas are extremely remote include:
- (i) field experience of the exact design with an exact application;
 - (ii) field experience with a similar design/application with supporting test data to allow a comparison;
 - (iii) demonstration by test of extremely low leakage rates;
 - (iv) redundancy of design;
 - (v) structural substantiation with a high safety margin for elements of the lubrication systems assessed against [CS 29.571](#); and
 - (vi) assessment of the potential dormant failure modes of the auxiliary lubrication system, and in order to minimise the risk of dormant failures, determination of the health of the auxiliary lubrication system prior to each flight.

[Amdt No: 29/3]

[Amdt No: 29/5]

CS 29.921 Rotor brake

ED Decision 2003/16/RM

If there is a means to control the rotation of the rotor drive system independently of the engine, any limitations on the use of that means must be specified, and the control for that means must be guarded to prevent inadvertent operation.

CS 29.923 Rotor drive system and control mechanism tests

ED Decision 2003/16/RM

- (a) *Endurance tests, general.* Each rotor drive system and rotor control mechanism must be tested, as prescribed in sub-paragraphs (b) to (n) and (p), for at least 200 hours plus the time required to meet the requirements of sub-paragraphs (b)(2), (b)(3) and (k). These tests must be conducted as follows:
- (1) Ten-hour test cycles must be used, except that the test cycle must be extended to include the OEI test of sub-paragraphs (b)(2) and (k), if OEI ratings are requested.
 - (2) The tests must be conducted on the rotorcraft.

- (3) The test torque and rotational speed must be:
 - (i) Determined by the powerplant limitations; and
 - (ii) Absorbed by the rotors to be approved for the rotorcraft.
- (b) *Endurance tests, take-off run.* The take-off run must be conducted as follows:
 - (1) Except as prescribed in sub-paragraphs (b)(2) and (b)(3), the take-off torque run must consist of 1 hour of alternate runs of 5 minutes at take-off torque and the maximum speed for use with take-off torque, and 5 minutes at as low an engine idle speed as practicable. The engine must be declutched from the rotor drive system, and the rotor brake, if furnished and so intended, must be applied during the first minute of the idle run. During the remaining 4 minutes of the idle run, the clutch must be engaged so that the engine drives the rotors at the minimum practical rpm. The engine and the rotor drive system must be accelerated at the maximum rate. When declutching the engine, it must be decelerated rapidly enough to allow the operation of the overrunning clutch.
 - (2) For helicopters for which the use of a 2½-minute OEI rating is requested, the take-off run must be conducted as prescribed in subparagraph (b)(1), except for the third and sixth runs for which the take-off torque and the maximum speed for use with take-off torque are prescribed in that paragraph. For these runs, the following apply:
 - (i) Each run must consist of at least one period of 2½ minutes with take-off torque and the maximum speed for use with take-off torque on all engines.
 - (ii) Each run must consist of at least one period, for each engine in sequence, during which that engine simulates a power failure and the remaining engines are run at the 2½-minute OEI torque and the maximum speed for use with 2½-minute OEI torque for 2½ minutes.
 - (3) For multi-engine, turbine-powered rotorcraft for which the use of 30-second/2-minute OEI power is requested, the take-off run must be conducted as prescribed in subparagraph (b)(1) except for the following:
 - (i) Immediately following any one 5-minute power-on run required by subparagraph (b)(1), simulate a failure, for each power source in turn, and apply the maximum torque and the maximum speed for use with the 30-second OEI power to the remaining affected drive system power inputs for not less than 30 seconds. Each application of 30-second OEI power must be followed by two applications of the maximum torque and the maximum speed for use with the 2 minute OEI power for not less than 2 minutes each; the second application must follow a period at stabilised continuous or 30-minute OEI power (whichever is requested by the applicant.) At least one run sequence must be conducted from a simulated 'flight idle' condition. When conducted on a bench test, the test sequence must be conducted following stabilisation at take-off power.
 - (ii) For the purpose of this paragraph, an affected power input includes all parts of the rotor drive system which can be adversely affected by the application of higher or asymmetric torque and speed prescribed by the test.
 - (iii) This test may be conducted on a representative bench test facility when engine limitations either preclude repeated use of this power or would result in premature engine removals during the test. The loads, the vibration frequency, and the methods of application to the affected rotor drive system components must be

representative of rotorcraft conditions. Test components must be those used to show compliance with the remainder of this paragraph.

- (c) *Endurance tests, maximum continuous run.* Three hours of continuous operation at maximum continuous torque and the maximum speed for use with maximum continuous torque must be conducted as follows:
- (1) The main rotor controls must be operated at a minimum of 15 times each hour through the main rotor pitch positions of maximum vertical thrust, maximum forward thrust component, maximum aft thrust component, maximum left thrust component, and maximum right thrust component, except that the control movements need not produce loads or blade flapping motion exceeding the maximum loads of motions encountered in flight.
 - (2) The directional controls must be operated at a minimum of 15 times each hour through the control extremes of maximum right turning torque, neutral torque as required by the power applied to the main rotor, and maximum left turning torque.
 - (3) Each maximum control position must be held for at least 10 seconds, and the rate of change of control position must be at least as rapid as that for normal operation.
- (d) *Endurance tests: 90% of maximum continuous run.* One hour of continuous operation at 90% of maximum continuous torque and the maximum speed for use with 90% of maximum continuous torque must be conducted.
- (e) *Endurance tests; 80% of maximum continuous run.* One hour of continuous operation at 80% of maximum continuous torque and the minimum speed for use with 80% of maximum continuous torque must be conducted.
- (f) *Endurance tests; 60% of maximum continuous run.* Two hours or, for helicopters for which the use of either 30-minute OEI power or continuous OEI power is requested, 1 hour of continuous operation at 60% of maximum continuous torque and the minimum speed for use with 60% of maximum continuous torque must be conducted.
- (g) *Endurance tests: engine malfunctioning run.* It must be determined whether malfunctioning of components, such as the engine fuel or ignition systems, or whether unequal engine power can cause dynamic conditions detrimental to the drive system. If so, a suitable number of hours of operation must be accomplished under those conditions, 1 hour of which must be included in each cycle, and the remaining hours of which must be accomplished at the end of the 20 cycles. If no detrimental condition results, an additional hour of operation in compliance with subparagraph (b) must be conducted in accordance with the run schedule of subparagraph (b)(1) without consideration of subparagraph (b)(2).
- (h) *Endurance tests; overspeed run.* One hour of continuous operation must be conducted at maximum continuous torque and the maximum power-on overspeed expected in service, assuming that speed and torque limiting devices, if any, function properly.
- (i) *Endurance tests: rotor control positions.* When the rotor controls are not being cycled during the endurance tests, the rotor must be operated, using the procedures prescribed in subparagraph (c), to produce each of the maximum thrust positions for the following percentages of test time (except that the control positions need not produce loads or blade flapping motion exceeding the maximum loads or motions encountered in flight):
- (1) For full vertical thrust, 20%.
 - (2) For the forward thrust component, 50%

- (3) For the right thrust component, 10%.
- (4) For the left thrust component, 10%.
- (5) For the aft thrust component, 10%.
- (j) *Endurance tests, clutch and brake engagements.* A total of at least 400 clutch and brake engagements, including the engagements of sub-paragraph (b), must be made during the take-off torque runs and, if necessary, at each change of torque and speed throughout the test. In each clutch engagement, the shaft on the driven side of the clutch must be accelerated from rest. The clutch engagements must be accomplished at the speed and by the method prescribed by the applicant. During deceleration after each clutch engagement, the engines must be stopped rapidly enough to allow the engines to be automatically disengaged from the rotors and rotor drives. If a rotor brake is installed for stopping the rotor, the clutch, during brake engagements, must be disengaged above 40% of maximum continuous rotor speed and the rotors allowed to decelerate to 40% of maximum continuous rotor speed, at which time the rotor brake must be applied. If the clutch design does not allow stopping the rotors with the engine running, or if no clutch is provided, the engine must be stopped before each application of the rotor brake, and then immediately be started after the rotors stop.
- (k) *Endurance tests, OEI power run.*
 - (1) For rotorcraft for which the use of 30-minute OEI power is requested, a run at 30-minute OEI torque and the maximum speed for use with 30-minute OEI torque must be conducted as follows. For each engine, in sequence, that engine must be inoperative and the remaining engines must be run for a 30-minute period.
 - (2) For rotorcraft for which the use of continuous OEI power is requested, a run at continuous OEI torque and the maximum speed for use with continuous OEI torque must be conducted as follows. For each engine, in sequence, that engine must be inoperative and the remaining engines must be run for 1 hour.
 - (3) The number of periods prescribed in sub-paragraph (k)(1) or (k)(2) may not be less than the number of engines, nor may it be less than two.
- (l) Reserved.
- (m) Any components that are affected by manoeuvring and gust loads must be investigated for the same flight conditions as are the main rotors, and their service lives must be determined by fatigue tests or by other acceptable methods. In addition, a level of safety equal to that of the main rotors must be provided for:
 - (1) Each component in the rotor drive system whose failure would cause an uncontrolled landing;
 - (2) Each component essential to the phasing of rotors on multi-rotor rotorcraft, or that furnishes a driving link for the essential control of rotors in autorotation; and
 - (3) Each component common to two or more engines on multi-engine rotorcraft.
- (n) *Special tests.* Each rotor drive system designed to operate at two or more gear ratios must be subjected to special testing for durations necessary to substantiate the safety of the rotor drive system.
- (o) Each part tested as prescribed in this paragraph must be in a serviceable condition at the end of the tests. No intervening disassembly which might affect test results may be conducted.

- (p) *Endurance tests; operating lubricants.* To be approved for use in rotor drive and control systems, lubricants must meet the specifications of lubricants used during the tests prescribed by this paragraph. Additional or alternate lubricants may be qualified by equivalent testing or by comparative analysis of lubricant specifications and rotor drive and control system characteristics. In addition:
- (1) At least three 10-hour cycles required by this paragraph must be conducted with transmission and gearbox lubricant temperatures, at the location prescribed for measurement, not lower than the maximum operating temperature for which approval is requested;
 - (2) For pressure lubricated systems, at least three 10-hour cycles required by this paragraph must be conducted with the lubricant pressure, at the location prescribed for measurement, not higher than the minimum operating pressure for which approval is requested; and
 - (3) The test conditions of sub-paragraphs (p)(1) and (p)(2) must be applied simultaneously and must be extended to include operation at any one-engine-inoperative rating for which approval is requested.

CS 29.927 Additional tests

ED Decision 2018/007/R

- (a) Any additional dynamic, endurance, and operational tests, and vibratory investigations necessary to determine that the rotor drive mechanism is safe, must be performed.
- (b) If turbine engine torque output to the transmission can exceed the highest engine or transmission torque limit, and that output is not directly controlled by the pilot under normal operating conditions (such as where the primary engine power control is accomplished through the flight control), the following test must be made:
 - (1) Under conditions associated with all engines operating, make 200 applications, for 10 seconds each, of torque that is at least equal to the lesser of:
 - (i) The maximum torque used in meeting [CS 29.923](#) plus 10%; or
 - (ii) The maximum torque attainable under probable operating conditions, assuming that torque limiting devices, if any, function properly.
 - (2) For multi-engine rotorcraft under conditions associated with each engine, in turn, becoming inoperative, apply to the remaining transmission torque inputs the maximum torque attainable under probable operating conditions, assuming that torque limiting devices, if any, function properly. Each transmission input must be tested at this maximum torque for at least 15 minutes.
- (c) *Lubrication system failure.* For rotor drive system gearboxes required for continued safe flight or safe landing which have a pressurised normal-use lubrication system, the following apply:
 - (1) Category A. Confidence shall be established that the rotor drive system has an in-flight operational endurance capability of at least 30 minutes following a failure of any one pressurised normal-use lubrication system.

For each rotor drive system gearbox necessary for continued safe flight or safe landing, a test shall be conducted simulating the effect of the *most severe failure mode of the normal-use lubrication system* as determined by the failure analysis of [CS 29.917\(b\)](#). The duration of the test shall be dependent upon the number of tests and the component

condition after the test. The test shall be conducted such that it begins upon the indication to the flight crew that a lubrication failure has occurred, and its loading is consistent with 1 minute at maximum continuous power, followed by the minimum power needed for continued flight at the rotorcraft maximum gross weight. The test shall end with a 45-second out of ground effect (OGE) hover to simulate a landing phase. Test results must substantiate the *maximum period of operation following loss of lubrication* by means of an extended test duration, multiple test specimens, or another approach prescribed by the applicant and accepted by EASA, and must support the procedures published in the rotorcraft flight manual (RFM). Flight durations longer than 30 minutes may be demonstrated by means of a correspondingly longer test with appropriate margin and substantiation.

- (2) Category B. Confidence shall be established that the rotor drive system has an in-flight operational endurance capability to complete an autorotation descent and landing following a failure of any one pressurised *normal-use lubrication system*.

For each rotor drive system gearbox necessary for safe autorotation descent or safe landing, a test of at least 16 minutes and 15 seconds following the *most severe failure mode of the normal-use lubrication system* as determined by the failure analysis of [CS 29.917\(b\)](#) shall be conducted. The test shall be conducted such that it begins upon the indication to the flight crew that a lubrication failure has occurred and its loading is consistent with 1 minute at maximum continuous power, after which the input torque should be reduced to simulate autorotation for 15 minutes. The test shall be completed by the application of an input torque to simulate a minimum power landing for approximately 15 seconds.

- (d) *Overspeed test*. The rotor drive system must be subjected to 50 overspeed runs, each 30 ± 3 seconds in duration, at not less than either the higher of the rotational speed to be expected from an engine control device failure or 105% of the maximum rotational speed, including transients, to be expected in service. If speed and torque limiting devices are installed, are independent of the normal engine control, and are shown to be reliable, their rotational speed limits need not be exceeded. These runs must be conducted as follows:
- (1) Overspeed runs must be alternated with stabilising runs of from 1 to 5 minutes duration each at 60 to 80% of maximum continuous speed.
 - (2) Acceleration and deceleration must be accomplished in a period not longer than 10 seconds (except where maximum engine acceleration rate will require more than 10 seconds), and the time for changing speeds may not be deducted from the specified time for the overspeed runs.
 - (3) Overspeed runs must be made with the rotors in the flattest pitch for smooth operation.
- (e) The tests prescribed in sub-paragraphs (b) and (d) must be conducted on the rotorcraft and the torque must be absorbed by the rotors to be installed, except that other ground or flight test facilities with other appropriate methods of torque absorption may be used if the conditions of support and vibration closely simulate the conditions that would exist during a test on the rotorcraft.
- (f) Each test prescribed by this paragraph must be conducted without intervening disassembly and, except for the lubrication system failure test required by sub-paragraph (c), each part tested must be in a serviceable condition at the conclusion of the test.

[Amdt No: 29/5]

AMC 29.927 Additional tests

ED Decision 2018/007/R

This AMC replaces item a. (Section 29.927(c)) of FAA AC 29.927 (Amendment 29-26).

(a) Explanation

- (1) AMC 29.927 revises the rotor drive systems loss of lubrication test provisions for Category A rotorcraft, as defined in [CS 29.927\(c\)](#). This changes the related requirement to show a capability through testing of at least 36 minutes' duration. Additionally, minimum periods and load conditions are now defined directly in the provision. The failure condition to be simulated is the most severe loss of lubrication failure mode of the normal-use lubrication system, which is defined in [AMC 29.917](#). In addition, the term 'unless such failures are extremely remote' has been removed from the requirement. Assessment of the lubrication system reliability is now addressed under 29.917(b).
- (2) CS 29.927(c) is intended to apply to pressurised lubrication systems, as the likelihood of loss of lubrication is significantly greater for gearboxes that use pressurised lubrication and external cooling. This is due to the increased complexity of the lubrication system, the external components that circulate oil outside the gearbox, and the resultant rapid leakages that may occur with a pressurised system. A pressurised lubrication system is more commonly used in the rotorcraft's main gearbox, but one may also be used in other rotor drive system gearboxes. The need for dedicated loss of lubrication testing for gearboxes using non-pressurised (splash) lubrication systems is determined by the design assessment carried out in accordance with 29.917(b).
- (3) This provision is applicable to any pressurised lubrication gearbox that is necessary for continued safe flight or safe landing. Accordingly, this provision is not applicable to gearboxes that are not essential for continued safe flight or safe landing and which have a lubrication system which is independent of other essential gearboxes.
- (4) The lubricating system has two primary functions. The first is to provide lubricating oil to contacting or rubbing surfaces to reduce the heat energy generated by friction. The second is to dissipate the heat energy generated by the friction of meshing gears and bearings, thus maintaining surface and component temperatures. Accordingly, a loss of lubrication leads to increased friction between components and increased component surface temperatures. With increased component surface temperatures, surface hardness may be lost, resulting in the inability of the component to carry or transmit loads appropriately. Thermal expansion in gearbox components may eventually lead to the mechanical failure of bearings, journals, gears, shafts, and clutches that are subjected to high loads and rotational speeds. A loss of lubrication may result from either internal or external failures.
- (5) The intent of the rule change for Category A rotorcraft is to provide confidence in the continued flight capability of the rotorcraft, which should be of at least 30 minutes' duration after the loss of lubricant pressure in any single rotorcraft drive system gearbox, with the aim of optimising the eventual landing opportunities. In order to enable the crew to determine the safest action in the event of a loss of gearbox oil, the emergency procedures of the rotorcraft flight manual (RFM) should include instructions that define the maximum time period within which the rotorcraft should land. This AMC provides guidance for the completion of the loss of lubrication test and for how to demonstrate confidence in the margin of safety associated with the maximum period of operation following loss of lubrication, and associated period defined in the RFM emergency

procedures. This margin of safety is intended to substantiate a period of operation that has been evaluated as likely to be safer than making a forced landing over hostile terrain.

(b) Procedures

- (1) CS 29.927(c) prescribes a test that is intended to demonstrate that no hazardous failure or malfunction will occur within a defined period, and in a specified reduced-power condition, in the event of a significant failure of the rotor drive lubrication system. The failure of the lubrication system should not impair the ability of the crew to continue the safe operation of Category A rotorcraft for the defined period after an indication of the failure has been provided to the flight crew. For Category B rotorcraft, safe operation under autorotative conditions should be possible for a period of at least 15 minutes. For both Category A and B rotorcraft, some damage to the rotor drive system components is acceptable after completion of the lubrication system testing. However, the condition of the components will influence the maximum period of operation following loss of lubrication.
- (2) Since this is a test of the capability of the gearbox to operate with residual oil or oil supplied from an auxiliary lubrication system, the method for draining the oil and the operating conditions are also defined in the provision. The entry condition for the test should also be representative, and is defined in this AMC. For Category B rotorcraft, it is necessary to simulate an autorotation for a period of 15 minutes, followed by a minimum-power landing.

(c) Definitions

For the purposes of this test and the assessment of continued operation after a loss of lubrication, the following definitions apply:

- (1) Maximum period of operation following loss of lubrication: The maximum period of time following a loss of oil pressure warning, within which the rotorcraft should land. The period stated in the associated RFM emergency procedures should not exceed the maximum period of operation following loss of lubrication.
- (2) Residual oil: the oil present in the gearbox after experiencing the most severe failure mode, beginning at the time the pilot receives an indication of the failure. (Note: the amount of residual oil may decrease with time, and test conditions should take into account the possible effects of flight conditions where relevant. Also, when the lubrication system incorporates an auxiliary lubrication system, this will supplement the residual oil in the event of a failure of the normal-use lubrication system).

(d) Certification test configuration

Each gearbox lubricated by a pressurised system that is necessary for continued safe flight or safe landing should be tested. Deviations from the gearbox configuration being certified may be allowed where necessary for the installation of test instrumentation or equipment to facilitate simulation of the most severe failure mode. If any specific design features are identified in the safety assessment that may have a significant influence on the behaviour of the residual oil or the auxiliary lubrication system, they should be taken into account when determining the configuration of the test articles.

- (e) Loss of lubrication test
- (1) Category A rotorcraft
- (i) Test entry condition: the test starting condition should be 100 % of the torque associated with all engines operative (AEO) maximum continuous power (MCP) and at the nominal speed for use with MCP. In addition, the torque necessary for the anti-torque function should be simulated for straight and level flight at the same flight conditions. The oil temperature should be stabilised at the maximum oil temperature limit for normal operation.
 - (ii) Draining of oil: once the oil temperature has stabilised at the maximum declared oil temperature limit for normal operation, the oil should be drained simulating the most severe failure mode of the normal-use lubrication system. The most severe failure mode should be determined by the failure analysis of CS 29.917(b). The location and rate of oil drainage should be representative of the mode being simulated and the drainage should continue throughout the test.
 - (iii) Depleted-oil run: upon illumination of the ‘low oil pressure’ warning or other indication, as required by [CS 29.1305](#), continue to operate at AEO MCP and the nominal speed for use in this condition for 1 minute. Then, reduce the torque values to be greater than or equal to those necessary to sustain flight at the maximum gross weight and the most efficient flight conditions under standard atmospheric conditions (V_y). This condition should be maintained during the time determined necessary by the applicant to justify the maximum period of operation following loss of lubrication taking into account the applicable reduction factors. When determining the torque values to sustain flight at the maximum gross weight and the most efficient flight conditions (V_y), it should be assumed that the condition starts at 100 % maximum take-off weight (MTOW), and, thereafter, consideration for the fuel burn during the test is allowed.
 - (iv) Simulated landing: to complete the test, power should be applied to the gearbox for at least 45 seconds to simulate an out of ground effect (OGE) hover.
 - (v) Test conditions: for (i) to (iv) above, the input and output shaft torques should be reacted appropriately and the corresponding input and output shaft loads should be applied. As the efficiency of the gearbox may change during the test, the input loads may need to be adjusted in order to maintain the correct output shaft torque during the test. The vertical load of the main gearbox should be applied at the mast, and should be equal to the maximum gross weight of the rotorcraft at 1 g.
 - (vi) This test may be conducted on a representative bench test rig. The test should be performed with all the accessory loads represented by a load associated with normal cruise conditions. The test should not be performed with an ambient temperature in the test cell lower than ISA conditions. No additional ventilation that could reduce the gearbox temperature should be used which could result in temperatures which are lower than those which are likely to be experienced on the helicopter operating at ISA conditions.
 - (vii) A successful demonstration may involve limited damage to the rotor drive system; however, the gearbox should continue to transmit the necessary torque to the output shafts throughout the duration of the test. The loss of drive to accessories that are necessary for continued safe flight or safe landing should constitute a test failure.

- (2) Category B rotorcraft
 - (i) The provisions for Category A apply, except that the rotor drive system need only perform a depleted-oil run for 15 minutes operating at a torque and speed to simulate autorotative conditions.
 - (ii) A successful demonstration may involve limited damage to the rotor drive system provided that it is established that the autorotative capabilities of the rotorcraft would not be significantly impaired. If compliance with Category A provisions is demonstrated, Category B provisions will be considered to have been met.
 - (3) The test parameters described in (e)(1) above have been chosen to represent an occurrence of loss of oil in flight, namely a reaction/transition period for the crew to be able to reduce power, followed by an extended period at reduced power for continued flight at V_y . When determining the torque necessary for the reduced-power segment of this test, an international standard atmosphere (ISA) sea level condition is considered to be acceptable.
 - (4) Should the applicant wish to establish a positive safety margin for a Category A rotorcraft for a maximum period of operation following loss of lubrication longer than 30 minutes, it will be necessary to extend the test duration representing flight at V_y , described in (e)(1)(iii) above.
- (f) Determination of the maximum period of operation following loss of lubrication

In order to enable the flight crew to determine the safest action in the event of a loss of gearbox oil, the RFM emergency procedures should include instructions defining the maximum period of time, for each gearbox subject to 29.927(c), within which the rotorcraft should land. This period starts at the low pressure warning. Specific instructions can be prescribed by the applicant as an alternative to, or in addition to, defining the maximum period of operation following loss of lubrication, in order to maintain a continued safe flight and safe landing capability. The flight time allowance listed in the RFM should be based on the OEM's determination of what is appropriate, using guidance from the available test data, but it should be no greater than what is substantiated per the acceptable means of compliance (AMC) prescribed below. Accordingly, it is necessary to demonstrate reasonable confidence in the ability of the gearbox to continue operation enabling safe flight and safe landing after experiencing a loss of oil or a lubrication failure. (f)(1) to (f)(4) below describe acceptable means of compliance (AMC) to demonstrate this level of confidence, for a specified period at given operating conditions. This AMC explains how the test duration, the number of tests, the condition of the gearbox components upon completion of the tests, and the behaviour of the gearbox during these tests may be combined to establish a positive safety margin when determining the maximum period of operation following loss of lubrication.

(1) Certification test duration

The duration of the loss of lubrication certification test, as defined in (e) above, should be used as the starting point for the determination of the maximum period of operation following loss of lubrication and should be reduced as described in the following paragraphs as appropriate. The start of the test is considered to be the time at which the lubrication failure is indicated to the pilot.

(2) Reduction factor

In order to substantiate the maximum period of operation following loss of lubrication, a suitable reduction factor should be applied to correlate the test duration with the

maximum period of operation following loss of lubrication. Suitable reduction factors should be used as follows:

- (i) 0.6 where the certification test has no supporting data to provide understanding of the gearbox behaviour and confidence in the repeatability of the certification test data.
- (ii) 0.8 where the certification test is corroborated by one representative full-scale test (certification or development test). The corroborating test results should show consistency of the temperature history, and demonstrate good correlation with the certification test.
- (iii) 0.9 where the certification test is corroborated by two or more representative full-scale tests (certification or development tests) or by one representative full scale and one or more modular tests, historical data, or simulation results. The corroborating data should show consistency of the temperature history, and demonstrate good correlation with the certification test. In addition the behaviour of the limiting design characteristics is established and supported by repeatable test data.

Note: Specific testing, simulation or representative development test data from other programmes are examples of data that can be used to support the application of this K_r factor.

- (iv) When two or more tests are submitted to show compliance with this provision, the test of shortest duration will be considered to be the certification test and should be used as the basis for demonstrating the maximum period of operation following loss of lubrication. If excessive variation is experienced between tests, it should be investigated and explained.
- (v) The intent of using data from multiple tests is that the parts replaced between tests are those that potentially limit the performance of the gearbox when operating under residual oil or oil supplied from an auxiliary lubrication system. Where particular design characteristics are known to be critical to residual oil performance, parts should be selected at the most severe end of the tolerance range of the dimensions/specifications impacting these characteristics. Additionally, the objective of multiple tests is to evaluate the consistency between tests (using different gearbox components). When using multiple (full scale or modular) test results to corroborate the certification test duration and, thus, support the determination of the maximum period of operation following loss of lubrication, the criteria for the reconciliation between the corroborating test data and an official certification test should include:
 - a. the test conditions, i.e. loads, entry point and test profile, should be duplicated on the development test as for the official test, and any deviations should be substantiated;
 - b. the representativeness of parts should be demonstrated and documented;
 - c. the test equipment and instrumentation should be qualified and calibrated;
 - d. the correlation between development and official test should be demonstrated by absolute temperatures and temperature rates of change; and

- e. in addition for modular tests, the lubrication conditions should be conservatively simulated to avoid that the isolated module benefits from secondary lubrication from the boundaries of the module, which may not be representative of the module conditions in a full test.
- (vi) When determining the appropriate reduction factor, consideration should be given to any factors that may reflect the health or stability of gearbox components during the test(s). These factors are addressed below and include: temperature history, maximum temperatures achieved with respect to physical limitations of the material, simulation results, and the time difference between the demonstrated duration up to a test failure and the duration of the certification test.
- a. Temperature rate of change during test. Gearboxes operating after loss of lubrication sometimes exhibit portions of the test where the thermal response is either stable (approaching to zero rate of change) or meta-stable (with a ‘small’ rate of change). It is considered that confidence in the behaviour of the gearbox may be greater for a maximum absolute temperature measured under these conditions in the context of the certification test or an official test. Portions of the test that exhibit a larger temperature rate of change should be investigated and substantiated.
 - b. Maximum temperature reached during test. Similarly to the rate of temperature change, general experience from ‘total loss of lubrication’ tests performed has shown that successful tests do not exceed certain values of temperature measured at critical locations of the gearbox. The applicant should record temperature measurements from critical points of the gearbox or at related locations in order to compare with previous experience. This data should be used to validate analysis models and to support the application of a high K_r value when determining the maximum period of operation following loss of lubrication.
 - c. Models/simulations. Numerical simulation of loss of lubrication conditions is not considered sufficient to demonstrate confidence in absolute temperature values achieved during the certification test, when applied to the prediction of the maximum period of operation following loss of lubrication. However, it may be possible to apply numerical simulation (0-3 dimensional) to extrapolate test results to other boundary or entry conditions.
 - d. Extended operation. The applicant is encouraged to perform tests in order to evaluate the time difference between the point at which the certification test was concluded and the likely time of gearbox failure (if the certification test had continued). Of equal importance is the identification of the gearbox design features which are most likely to initiate gearbox failure in the event of extended operation after loss of lubrication.

Note: if, at the completion of the certification test landing simulation phase, the gearbox continues to transmit the necessary torque, it is acceptable to consider that the classification of component condition is Class 3 and can thus be considered a valid certification test result. Further component degradation resulting from continued running of the same test will not invalidate this result with respect to compliance with this requirement. Should an extended test be completed with a successful second landing

simulation, the total duration can be considered applicable to the certification test result.

(3) Fixed time penalty.

Based on the condition of components necessary for continued safe flight or landing at the end of the certification test a fixed time penalty should be applied in accordance with the definitions below. This fixed time penalty should be 2 minutes for CLASS 1 ('Good' condition), 5 minutes for CLASS 2 ('Fair' condition), and 10 minutes for CLASS 3 ('Imminent failure' condition) with the CLASS defined based upon the following criteria.

CLASS 0 — Intact/serviceable

Parts in new condition. It is impractical to expect components to be in this condition after the test, but this classification is stated for reference only.

CLASS 1 — Good

- Parts are still well oil-wetted with little or no discolouration (light yellow to light/local blue).
- Local moderate scuffing of gear teeth and/or local moderate scorings on bearing-active surfaces is present.
- Hardened surfaces (gear teeth and bearing-active surfaces) may show slight/local reduction in hardness (maximum 2 points on the Rockwell C Hardness (HRC) scale).
- Normally, operation in these conditions should not significantly alter the vibration and noise signatures of the gearbox during test.
- Gearbox still transmits the required torque and rotates smoothly.

CLASS 2 — Fair

- Parts are almost completely dry, little residual oil in localised areas.
- Dark blue to brown discolouration is present, showing signs of uniform wear.
- Coatings such as silver plating are still visible but may be worn out locally or discoloured.
- Heavy localised scuffing on gear teeth as well wear on active surfaces of gear teeth are visible.
- Surface hardness may have been reduced more significantly (up to a maximum of 4 points on the HRC scale).
- Normally, operation in these conditions could cause moderate changes to the vibration and noise signatures of the gearbox during test.
- Gearbox still transmits the required torque.

CLASS 3 — Imminent failure

- Parts show evidence of plastic deformation or melting in local areas due to high temperatures.
- Macroscopic wear of some of the rolling elements of bearings and gear teeth, with appreciable alteration of dimensions and associated increases in clearances and play.
- Bearing cages are worn or with incipient breakage.

- Normally, operation in these conditions causes significant and audible changes to the vibration and noise signatures of the gearbox during test.
- The gearbox still transmits the required torque and is still capable of rotating immediately after test (after it has cooled down, it may be more difficult to rotate).

CLASS 4 — Failed

In this case, there is a complete and gross plastic deformation of parts, and bearing balls and rollers are melted. Parts in this conditions mean that the test specimen has failed, hence, this classification is also provided for reference only.

(4) Calculation of the maximum period of operation following loss of lubrication

Application of the factors described in (2) and (3) above can be represented by the following formula:

$$T_d = (K_r \times T_c) - T_p$$

where:

- T_d is the Maximum Period of Operation Following Loss of Lubrication, for which confidence has been established and which is to be used as the basis for the period stated in the RFM emergency procedures. This period should not exceed T_d ;
- K_r is the confidence/reliability reduction factor defined in (2) above;
- T_c is the duration of the certification test (from low-pressure indication to end of test); and
- T_p is a fixed-time penalty to account for condition at the end of the test, as defined in (3) above.

(5) Secondary indication

Another possible means to increase confidence in the ability of the gearbox to continue to operate safely after suffering a loss of lubrication is to provide a secondary indication, which may indicate when the most critical mode of degradation has progressed to a level where gearbox functional failure may be imminent. If such a design feature is selected, the following considerations are necessary:

- (i) evidence should be available, preferably from multiple tests, to provide confidence that the failure mode being monitored is always the most critical failure mode after a loss of lubrication, and that the rate of degradation up to the point of failure is understood;
- (ii) if the oil pressure is normal, inhibition of the warning to the flight crew may be considered in order to reduce the likelihood of a false warning resulting in an instruction to 'land immediately'; and
- (iii) the availability/reliability of the warning should be justified; it should be possible to test the correct functioning of the sensor or warning during pre-flight/start-up checks or during routine maintenance.
- (iv) noise and/or vibration detected by the crew should not be considered to be reliable secondary indications on their own.

[Amdt No: 29/5]

CS 29.931 Shafting critical speed

ED Decision 2003/16/RM

- (a) The critical speeds of any shafting must be determined by demonstration except that analytical methods may be used if reliable methods of analysis are available for the particular design.
- (b) If any critical speed lies within, or close to, the operating ranges for idling, power-on, and autorotative conditions, the stresses occurring at that speed must be within safe limits. This must be shown by tests.
- (c) If analytical methods are used and show that no critical speed lies within the permissible operating ranges, the margins between the calculated critical speeds and the limits of the allowable operating ranges must be adequate to allow for possible variations between the computed and actual values.

CS 29.935 Shafting joints

ED Decision 2003/16/RM

Each universal joint, slip joint, and other shafting joints whose lubrication is necessary for operation must have provision for lubrication.

CS 29.939 Turbine engine operating characteristics

ED Decision 2003/16/RM

- (a) Turbine engine operating characteristics must be investigated in flight to determine that no adverse characteristics (such as stall, surge, or flameout) are present, to a hazardous degree, during normal and emergency operation within the range of operating limitations of the rotorcraft and of the engine.
- (b) The turbine engine air inlet system may not, as a result of airflow distortion during normal operation, cause vibration harmful to the engine.
- (c) For governor-controlled engines, it must be shown that there exists no hazardous torsional instability of the drive system associated with critical combinations of power, rotational speed, and control displacement.

FUEL SYSTEMS

CS 29.951 General

ED Decision 2003/16/RM

- (a) Each fuel system must be constructed and arranged to ensure a flow of fuel at a rate and pressure established for proper engine and auxiliary power unit functioning under any likely operating conditions, including the manoeuvres for which certification is requested and during which the engine or auxiliary power unit is permitted to be in operation.
- (b) Each fuel system must be arranged so that:
 - (1) No engine or fuel pump can draw fuel from more than one tank at a time; or
 - (2) There are means to prevent introducing air into the system.
- (c) Each fuel system for a turbine engine must be capable of sustained operation throughout its flow and pressure range with fuel initially saturated with water at 27°C (80°F) and having 0.20 cm³ of free water per litre (0.75 cc per US-gallon) added and cooled to the most critical condition for icing likely to be encountered in operation.

CS 29.952 Fuel system crash resistance

ED Decision 2003/16/RM

Unless other means acceptable to the Agency are employed to minimise the hazard of fuel fires to occupants following an otherwise survivable impact (crash landing), the fuel systems must incorporate the design features of this paragraph. These systems must be shown to be capable of sustaining the static and dynamic deceleration loads of this paragraph, considered as ultimate loads acting alone, measured at the system component's centre of gravity without structural damage to the system components, fuel tanks, or their attachments that would leak fuel to an ignition source.

- (a) *Drop test requirements.* Each tank, or the most critical tank, must be drop-tested as follows:
 - (1) The drop height must be at least 15.2m (50 ft).
 - (2) The drop impact surface must be non deforming.
 - (3) The tanks must be filled with water to 80% of the normal, full capacity.
 - (4) The tank must be enclosed in a surrounding structure representative of the installation unless it can be established that the surrounding structure is free of projections or other design features likely to contribute to rupture of the tank.
 - (5) The tank must drop freely and impact in a horizontal position $\pm 10^\circ$.
 - (6) After the drop test, there must be no leakage.
- (b) *Fuel tank load factors.* Except for fuel tanks located so that tank rupture with fuel release to either significant ignition sources, such as engines, heaters, and auxiliary power units, or occupants is extremely remote, each fuel tank must be designed and installed to retain its contents under the following ultimate inertial load factors, acting alone.
 - (1) For fuel tanks in the cabin –
 - (i) Upward – 4 g.
 - (ii) Forward – 16 g.
 - (iii) Sideward – 8 g.

- (iv) Downward – 20 g.
- (2) For fuel tanks located above or behind the crew or passenger compartment that, if loosened, could injure an occupant in an emergency landing –
 - (i) Upward – 1.5 g.
 - (ii) Forward – 8 g.
 - (iii) Sideward – 2 g.
 - (iv) Downward – 4 g.
- (3) For fuel tanks in other areas –
 - (i) Upward – 1.5 g.
 - (ii) Forward – 4 g.
 - (iii) Sideward – 2 g.
 - (iv) Downward – 4 g.
- (c) *Fuel line self-sealing breakaway couplings.* Self-sealing breakaway couplings must be installed unless hazardous relative motion of fuel system components to each other or to local rotorcraft structure is demonstrated to be extremely improbable or unless other means are provided. The couplings or equivalent devices must be installed at all fuel tank- to-fuel line connections, tank-to-tank interconnects, and at other points in the fuel system where local structural deformation could lead to release of fuel.
 - (1) The design and construction of self- sealing breakaway couplings must incorporate the following design features:
 - (i) The load necessary to separate a breakaway coupling must be between 25 and 50% of the minimum ultimate failure load (ultimate strength) of the weakest component in the fluid-carrying line. The separation load must in no case be less than 1334 N (300 pounds), regardless of the size of the fluid line.
 - (ii) A breakaway coupling must separate whenever its ultimate load (as defined in subparagraph (c)(1)(i)) is applied in the failure modes most likely to occur.
 - (iii) All breakaway coupling must incorporate design provisions to visually ascertain that the coupling is locked together (leak-free) and is open during normal installation and service.
 - (iv) All breakaway couplings must incorporate design provisions to prevent uncoupling or unintended closing due to operational shocks, vibrations, or accelerations.
 - (v) No breakaway coupling design may allow the release of fuel once the coupling has performed its intended function.
 - (2) All individual breakaway couplings, coupling fuel feed systems, or equivalent means must be designed, tested, installed, and maintained so inadvertent fuel shutoff in flight is improbable in accordance with [CS 29.955\(a\)](#) and must comply with the fatigue evaluation requirements of [CS 29.571](#) without leaking.
 - (3) Alternate, equivalent means to the use of breakaway couplings must not create a survivable impact-induced load on the fuel line to which it is installed greater than 25 to 50% of the ultimate load (strength) of the weakest component in the line and must comply with the fatigue requirements of [CS 29.571](#) without leaking.

- (d) *Frangible or deformable structural attachments.* Unless hazardous relative motion of fuel tanks and fuel system components to local rotorcraft structure is demonstrated to be extremely improbable in an otherwise survivable impact, frangible or locally deformable attachments of fuel tanks and fuel system components to local rotorcraft structure must be used. The attachment of fuel tanks and fuel system components to local rotorcraft structure, whether frangible or locally deformable, must be designed such that its separation or relative local deformation will occur without rupture or local tearout of the fuel tank or fuel system component that will cause fuel leakage. The ultimate strength of frangible or deformable attachments must be as follows:
- (1) The load required to separate a frangible attachment from its support structure, or deform a locally deformable attachment relative to its support structure, must be between 25 and 50% of the minimum ultimate load (ultimate strength) of the weakest component in the attached system. In no case may the load be less than 1334 N (300 pounds).
 - (2) A frangible or locally deformable attachment must separate or locally deform as intended whenever its ultimate load (as defined in sub-paragraph (d)(1)) is applied in the modes most likely to occur.
 - (3) All frangible or locally deformable attachments must comply with the fatigue requirements of [CS 29.571](#).
- (e) *Separation of fuel and ignition sources.* To provide maximum crash resistance, fuel must be located as far as practicable from all occupiable areas and from all potential ignition sources.
- (f) *Other basic mechanical design criteria.* Fuel tanks, fuel lines, electrical wires and electrical devices must be designed, constructed, and installed, as far as practicable, to be crash resistant.
- (g) *Rigid or semi-rigid fuel tanks.* Rigid or semi-rigid fuel tank or bladder walls must be impact and tear resistant.

CS 29.953 Fuel system independence

ED Decision 2003/16/RM

- (a) For Category A rotorcraft:
- (1) The fuel system must meet the requirements of [CS 29.903\(b\)](#); and
 - (2) Unless other provisions are made to meet sub-paragraph (a)(1), the fuel system must allow fuel to be supplied to each engine through a system independent of those parts of each system supplying fuel to other engines.
- (b) Each fuel system for a multi-engine Category B rotorcraft must meet the requirements of sub-paragraph (a)(2). However, separate fuel tanks need not be provided for each engine.

CS 29.954 Fuel system lightning protection

ED Decision 2003/16/RM

The fuel system must be designed and arranged to prevent the ignition of fuel vapour within the system by:

- (a) Direct lightning strikes to areas having a high probability of stroke attachment;
- (b) Swept lightning strokes to areas where swept strokes are highly probable; and
- (c) Corona and streamering at fuel vent outlets.

CS 29.955 Fuel flow

ED Decision 2012/022/R

- (a) *General.* The fuel system for each engine must provide the engine with at least 100% of the fuel required under all operating and manoeuvring conditions to be approved for the rotorcraft, including, as applicable, the fuel required to operate the engines under the test conditions required by [CS 29.927](#). Unless equivalent methods are used, compliance must be shown by test during which the following provisions are met, except that combinations of conditions which are shown to be improbable need not be considered.
- (1) The fuel pressure, corrected for accelerations (load factors), must be within the limits specified by the engine type certificate data sheet.
 - (2) The fuel level in the tank may not exceed that established as the unusable fuel supply for that tank under [CS 29.959](#), plus that necessary to conduct the test.
 - (3) The fuel head between the tank and the engine must be critical with respect to rotorcraft flight attitudes.
 - (4) The fuel flow transmitter, if installed, and the critical fuel pump (for pump-fed systems) must be installed to produce (by actual or simulated failure) the critical restriction to fuel flow to be expected from component failure.
 - (5) Critical values of engine rotational speed, electrical power, or other sources of fuel pump motive power must be applied.
 - (6) Critical values of fuel properties which adversely affect fuel flow are applied during demonstrations of fuel flow capability.
 - (7) The fuel filter required by [CS 29.997](#) is blocked to the degree necessary to simulate the accumulation of fuel contamination required to activate the indicator required by [CS 29.1305\(a\)\(18\)](#).
- (b) *Fuel transfer system.* If normal operation of the fuel system requires fuel to be transferred to another tank, the transfer must occur automatically via a system which has been shown to maintain the fuel level in the receiving tank within acceptable limits during flight or surface operation of the rotorcraft.
- (c) *Multiple fuel tanks.* If an engine can be supplied with fuel from more than one tank, the fuel system, in addition to having appropriate manual switching capability, must be designed to prevent interruption of fuel flow to the engine, without attention by the flight crew, when any tank supplying fuel to that engine is depleted of usable fuel during normal operation and any other tank that normally supplies fuel to that engine alone contains usable fuel.

[Amdt 29/3]

CS 29.957 Flow between inter-connected tanks

ED Decision 2003/16/RM

- (a) Where tank outlets are interconnected and allow fuel to flow between them due to gravity or flight accelerations, it must be impossible for fuel to flow between tanks in quantities great enough to cause overflow from the tank vent in any sustained flight condition.
- (b) If fuel can be pumped from one tank to another in flight:
 - (1) The design of the vents and the fuel transfer system must prevent structural damage to tanks from overflowing; and
 - (2) There must be means to warn the crew before overflow through the vents occurs.

CS 29.959 Unusable fuel supply

ED Decision 2003/16/RM

The unusable fuel supply for each tank must be established as not less than the quantity at which the first evidence of malfunction occurs under the most adverse fuel feed condition occurring under any intended operations and flight manoeuvres involving that tank.

CS 29.961 Fuel system hot weather operation

ED Decision 2003/16/RM

Each suction lift fuel system and other fuel systems conducive to vapour formation must be shown to operate satisfactorily (within certification limits) when using fuel at the most critical temperature for vapour formation under critical operating conditions including, if applicable, the engine operating conditions defined by [CS 29.927\(b\)\(1\) and \(b\)\(2\)](#).

CS 29.963 Fuel tanks: general

ED Decision 2003/16/RM

- (a) Each fuel tank must be able to withstand, without failure, the vibration, inertia, fluid, and structural loads to which it may be subjected in operation.
- (b) Each flexible fuel tank bladder or liner must be approved or shown to be suitable for the particular application and must be puncture resistant. Puncture resistance must be shown by meeting the ETSO-C80, paragraph 16.0, requirements using a minimum puncture force of 1646 N (370 pounds).
- (c) Each integral fuel tank must have facilities for inspection and repair of its interior.
- (d) The maximum exposed surface temperature of all components in the fuel tank must be less by a safe margin than the lowest expected auto-ignition temperature of the fuel or fuel vapour in the tank. Compliance with this requirement must be shown under all operating conditions and under all normal or malfunction conditions of all components inside the tank.
- (e) Each fuel tank installed in personnel compartments must be isolated by fume-proof and fuel-proof enclosures that are drained and vented to the exterior of the rotorcraft. The design and construction of the enclosures must provide necessary protection for the tank, must be crash resistant during a survivable impact in accordance with [CS 29.952](#), and must be adequate to withstand loads and abrasions to be expected in personnel compartments.

CS 29.965 Fuel tank tests

ED Decision 2003/16/RM

- (a) Each fuel tank must be able to withstand the applicable pressure tests in this paragraph without failure or leakage. If practicable, test pressures may be applied in a manner simulating the pressure distribution in service.
- (b) Each conventional metal tank, each non-metallic tank with walls that are not supported by the rotorcraft structure, and each integral tank must be subjected to a pressure of 24 kPa (3.5 psi) unless the pressure developed during maximum limit acceleration or emergency deceleration with a full tank exceeds this value, in which case a hydrostatic head, or equivalent test, must be applied to duplicate the acceleration loads as far as possible. However, the pressure need not exceed 24 kPa (3.5 psi) on surfaces not exposed to the acceleration loading.
- (c) Each non-metallic tank with walls supported by the rotorcraft structure must be subjected to the following tests:
 - (1) A pressure test of at least 14 kPa (2.0 psi). This test may be conducted on the tank alone in conjunction with the test specified in subparagraph (c)(2).
 - (2) A pressure test, with the tank mounted in the rotorcraft structure, equal to the load developed by the reaction of the contents, with the tank full, during maximum limit acceleration or emergency deceleration. However, the pressure need not exceed 14 kPa (2.0 psi) on surfaces not exposed to the acceleration loading.
- (d) Each tank with large unsupported or unstiffened flat areas, or with other features whose failure or deformation could cause leakage, must be subjected to the following test or its equivalent:
 - (1) Each complete tank assembly and its supports must be vibration tested while mounted to simulate the actual installation.
 - (2) The tank assembly must be vibrated for 25 hours while two-thirds full of any suitable fluid. The amplitude of vibration may not be less than 0.8 mm (one thirty-second of an inch), unless otherwise substantiated.
 - (3) The test frequency of vibration must be as follows:
 - (i) If no frequency of vibration resulting from any rpm within the normal operating range of engine or rotor system speeds is critical, the test frequency of vibration, in number of cycles per minute, must, unless a frequency based on a more rational analysis is used, be the number obtained by averaging the maximum and minimum power-on engine speeds (rpm) for reciprocating engine powered rotorcraft or 2000 cpm for turbine engine powered rotorcraft.
 - (ii) If only one frequency of vibration resulting from any rpm within the normal operating range of engine or rotor system speeds is critical, that frequency of vibration must be the test frequency.
 - (iii) If more than one frequency of vibration resulting from any rpm within the normal operating range of engine or rotor system speeds is critical, the most critical of these frequencies must be the test frequency.
 - (4) Under sub-paragraph (d)(3)(ii) and (iii), the time of test must be adjusted to accomplish the same number of vibration cycles as would be accomplished in 25 hours at the frequency specified in sub-paragraph (d)(3)(i).
 - (5) During the test the tank assembly must be rocked at the rate of 16 to 20 complete cycles per minute through an angle of 15° on both sides of the horizontal (30° total), about the

most critical axis, for 25 hours. If motion about more than one axis is likely to be critical, the tank must be rocked about each critical axis for 12½ hours.

CS 29.967 Fuel tank installation

ED Decision 2003/16/RM

- (a) Each fuel tank must be supported so that tank loads are not concentrated on unsupported tank surfaces. In addition:
- (1) There must be pads, if necessary, to prevent chafing between each tank and its supports;
 - (2) The padding must be non-absorbent or treated to prevent the absorption of fuel;
 - (3) If flexible tank liners are used, they must be supported so that they are not required to withstand fluid loads; and
 - (4) Each interior surface of tank compartments must be smooth and free of projections that could cause wear of the liner, unless:
 - (i) There are means for protection of the liner at those points; or
 - (ii) The construction of the liner itself provides such protection.
- (b) Any spaces adjacent to tank surfaces must be adequately ventilated to avoid accumulation of fuel or fumes in those spaces due to minor leakage. If the tank is in a sealed compartment, ventilation may be limited to drain holes that prevent clogging and that prevent excessive pressure resulting from altitude changes. If flexible tank liners are installed, the venting arrangement for the spaces between the liner and its container must maintain the proper relationship to tank vent pressures for any expected flight condition.
- (c) The location of each tank must meet the requirements of [CS 29.1185\(b\) and \(c\)](#).
- (d) No rotorcraft skin immediately adjacent to a major air outlet from the engine compartment may act as the wall of an integral tank.

CS 29.969 Fuel tank expansion space

ED Decision 2003/16/RM

Each fuel tank or each group of fuel tanks with interconnected vent systems must have an expansion space of not less than 2% of the combined tank capacity. It must be impossible to fill the fuel tank expansion space inadvertently with the rotorcraft in the normal ground attitude.

CS 29.971 Fuel tank sump

ED Decision 2003/16/RM

- (a) Each fuel tank must have a sump with a capacity of not less than the greater of:
- (1) 0.10% of the tank capacity; or
 - (2) 0.24 litres (0.05 Imperial gallon/one sixteenth US gallon).
- (b) The capacity prescribed in sub-paragraph (a) must be effective with the rotorcraft in any normal attitude, and must be located so that the sump contents cannot escape through the tank outlet opening.

- (c) Each fuel tank must allow drainage of hazardous quantities of water from each part of the tank to the sump with the rotorcraft in any ground attitude to be expected in service.
- (d) Each fuel tank sump must have a drain that allows complete drainage of the sump on the ground.

CS 29.973 Fuel tank filler connection

ED Decision 2003/16/RM

- (a) Each fuel tank filler connection must prevent the entrance of fuel into any part of the rotorcraft other than the tank itself during normal operations and must be crash resistant during a survivable impact in accordance with [CS 29.952\(c\)](#). In addition:
 - (1) Each filler must be marked as prescribed in [CS 29.1557\(c\)\(1\)](#);
 - (2) Each recessed filler connection that can retain any appreciable quantity of fuel must have a drain that discharges clear of the entire rotorcraft; and
 - (3) Each filler cap must provide a fuel-tight seal under the fluid pressure expected in normal operation and in a survivable impact.
- (b) Each filler cap or filler cap cover must warn when the cap is not fully locked or seated on the filler connection.

CS 29.975 Fuel tank vents and carburetor vapour vents

ED Decision 2003/16/RM

- (a) *Fuel tank vents.* Each fuel tank must be vented from the top part of the expansion space so that venting is effective under normal flight conditions. In addition:
 - (1) The vents must be arranged to avoid stoppage by dirt or ice formation;
 - (2) The vent arrangement must prevent siphoning of fuel during normal operation;
 - (3) The venting capacity and vent pressure levels must maintain acceptable differences of pressure between the interior and exterior of the tank, during:
 - (i) Normal flight operation;
 - (ii) Maximum rate of ascent and descent; and
 - (iii) Refuelling and defuelling (where applicable);
 - (4) Airspaces of tanks with interconnected outlets must be interconnected;
 - (5) There may be no point in any vent line where moisture can accumulate with the rotorcraft in the ground attitude or the level flight attitude, unless drainage is provided;
 - (6) No vent or drainage provision may end at any point:
 - (i) Where the discharge of fuel from the vent outlet would constitute a fire hazard; or
 - (ii) From which fumes could enter personnel compartments; and
 - (7) The venting system must be designed to minimise spillage of fuel through the vents to an ignition source in the event of a rollover during landing, ground operations, or a survivable impact.

- (b) *Carburettor vapour vents.* Each carburettor with vapour elimination connections must have a vent line to lead vapours back to one of the fuel tanks. In addition –
- (1) Each vent system must have means to avoid stoppage by ice; and
 - (2) If there is more than one fuel tank, and it is necessary to use the tanks in a definite sequence, each vapour vent return line must lead back to the fuel tank used for take-off and landing.

CS 29.977 Fuel tank outlet

ED Decision 2003/16/RM

- (a) There must be a fuel strainer for the fuel tank outlet or for the booster pump. This strainer must:
- (1) For reciprocating engine powered rotorcraft, have 3 to 6 meshes per cm (8 to 16 meshes per inch); and
 - (2) For turbine engine powered rotorcraft, prevent the passage of any object that could restrict fuel flow or damage any fuel system component.
- (b) The clear area of each fuel tank outlet strainer must be at least five times the area of the outlet line.
- (c) The diameter of each strainer must be at least that of the fuel tank outlet.
- (d) Each finger strainer must be accessible for inspection and cleaning.

CS 29.979 Pressure refuelling and fuelling provisions below fuel level

ED Decision 2003/16/RM

- (a) Each fuelling connection below the fuel level in each tank must have means to prevent the escape of hazardous quantities of fuel from that tank in case of malfunction of the fuel entry valve.
- (b) For systems intended for pressure refuelling, a means in addition to the normal means for limiting the tank content must be installed to prevent damage to the tank in case of failure of the normal means.
- (c) The rotorcraft pressure fuelling system (not fuel tanks and fuel tank vents) must withstand an ultimate load that is 2.0 times the load arising from the maximum pressure, including surge, that is likely to occur during fuelling. The maximum surge pressure must be established with any combination of tank valves being either intentionally or inadvertently closed.
- (d) The rotorcraft defuelling system (not including fuel tanks and fuel tank vents) must withstand an ultimate load that is 2.0 times the load arising from the maximum permissible defuelling pressure (positive or negative) at the rotorcraft fuelling connection.

FUEL SYSTEM COMPONENTS

CS 29.991 Fuel pumps

ED Decision 2003/16/RM

- (a) Compliance with [CS 29.955](#) must not be jeopardised by failure of:
 - (1) Any one pump except pumps that are approved and installed as parts of a type certificated engine; or
 - (2) Any component required for pump operation except the engine served by that pump.
- (b) The following fuel pump installation requirements apply:
 - (1) When necessary to maintain the proper fuel pressure:
 - (i) A connection must be provided to transmit the carburettor air intake static pressure to the proper fuel pump relief valve connection; and
 - (ii) The gauge balance lines must be independently connected to the carburettor inlet pressure to avoid incorrect fuel pressure readings.
 - (2) The installation of fuel pumps having seals or diaphragms that may leak must have means for draining leaking fuel.
 - (3) Each drain line must discharge where it will not create a fire hazard.

CS 29.993 Fuel system lines and fittings

ED Decision 2003/16/RM

- (a) Each fuel line must be installed and supported to prevent excessive vibration and to withstand loads due to fuel pressure, valve actuation, and accelerated flight conditions.
- (b) Each fuel line connected to components of the rotorcraft between which relative motion could exist must have provisions for flexibility.
- (c) Each flexible connection in fuel lines that may be under pressure or subjected to axial loading must use flexible hose assemblies.
- (d) Flexible hose must be approved.
- (e) No flexible hose that might be adversely affected by high temperatures may be used where excessive temperatures will exist during operation or after engine shutdown.

CS 29.995 Fuel valves

ED Decision 2003/16/RM

In addition to meeting the requirements of [CS 29.1189](#), each fuel valve must:

- (a) Reserved.
- (b) Be supported so that no loads resulting from their operation or from accelerated flight conditions are transmitted to the lines attached to the valve.

CS 29.997 Fuel strainer or filter

ED Decision 2003/16/RM

There must be a fuel strainer or filter between the fuel tank outlet and the inlet of the first fuel system component which is susceptible to fuel contamination, including but not limited to the fuel metering device or an engine positive displacement pump, whichever is nearer the fuel tank outlet. This fuel strainer or filter must:

- (a) Be accessible for draining and cleaning and must incorporate a screen or element which is easily removable;
- (b) Have a sediment trap and drain, except that it need not have a drain if the strainer or filter is easily removable for drain purposes;
- (c) Be mounted so that its weight is not supported by the connecting lines or by the inlet or outlet connections of the strainer or filter itself, unless adequate strength margins under all loading conditions are provided in the lines and connections; and
- (d) Provide a means to remove from the fuel any contaminant which would jeopardise the flow of fuel through rotorcraft or engine fuel system components required for proper rotorcraft or engine fuel system operation.

CS 29.999 Fuel system drains

ED Decision 2003/16/RM

- (a) There must be at least one accessible drain at the lowest point in each fuel system to completely drain the system with the rotorcraft in any ground attitude to be expected in service.
- (b) Each drain required by sub-paragraph (a) including the drains prescribed in [CS 29.971](#) must:
 - (1) Discharge clear of all parts of the rotorcraft;
 - (2) Have manual or automatic means to ensure positive closure in the off position; and
 - (3) Have a drain valve:
 - (i) That is readily accessible and which can be easily opened and closed; and
 - (ii) That is either located or protected to prevent fuel spillage in the event of a landing with landing gear retracted.

CS 29.1001 Fuel jettisoning

ED Decision 2003/16/RM

If a fuel jettisoning system is installed, the following apply:

- (a) Fuel jettisoning must be safe during all flight regimes for which jettisoning is to be authorised.
- (b) In showing compliance with sub-paragraph (a), it must be shown that:
 - (1) The fuel jettisoning system and its operation are free from fire hazard;
 - (2) No hazard results from fuel or fuel vapours which impinge on any part of the rotorcraft during fuel jettisoning; and
 - (3) Controllability of the rotorcraft remains satisfactory throughout the fuel jettisoning operation.

-
- (c) Means must be provided to automatically prevent jettisoning fuel below the level required for an all-engine climb at maximum continuous power from sea-level to 1524 m (5000 ft) altitude and cruise thereafter for 30 minutes at maximum range engine power.
 - (d) The controls for any fuel jettisoning system must be designed to allow flight personnel (minimum crew) to safely interrupt fuel jettisoning during any part of the jettisoning operation.
 - (e) The fuel jettisoning system must be designed to comply with the powerplant installation requirements of [CS 29.901\(c\)](#).
 - (f) An auxiliary fuel jettisoning system which meets the requirements of sub-paragraphs (a), (b), (d) and (e) may be installed to jettison additional fuel provided it has separate and independent controls.

OIL SYSTEM

CS 29.1011 Engines: General

ED Decision 2003/16/RM

- (a) Each engine must have an independent oil system that can supply it with an appropriate quantity of oil at a temperature not above that safe for continuous operation.
- (b) The usable oil capacity of each system may not be less than the product of the endurance of the rotorcraft under critical operating conditions and the maximum allowable oil consumption of the engine under the same conditions, plus a suitable margin to ensure adequate circulation and cooling. Instead of a rational analysis of endurance and consumption, a usable oil capacity of 3.8 litres (0.83 Imperial gallon/1 US gallon) for each 151 litres (33.3 Imperial gallons/40 US gallons) of usable fuel may be used for reciprocating engine installations.
- (c) Oil-fuel ratios lower than those prescribed in sub-paragraph (b) may be used if they are substantiated by data on the oil consumption of the engine.
- (d) The ability of the engine oil cooling provisions to maintain the oil temperature at or below the maximum established value must be shown under the applicable requirements of [CS 29.1041](#) to [29.1049](#).

CS 29.1013 Oil tanks

ED Decision 2003/16/RM

- (a) *Installation.* Each oil tank installation must meet the requirements of [CS 29.967](#).
- (b) *Expansion space.* Oil tank expansion space must be provided so that –
 - (1) Each oil tank used with a reciprocating engine has an expansion space of not less than the greater of 10% of the tank capacity or 1.9 litres (0.42 Imperial gallon/0.5 US gallon), and each oil tank used with a turbine engine has an expansion space of not less than 10% of the tank capacity;
 - (2) Each reserve oil tank not directly connected to any engine has an expansion space of not less than 2% of the tank capacity; and
 - (3) It is impossible to fill the expansion space inadvertently with the rotorcraft in the normal ground attitude.
- (c) *Filler connections.* Each recessed oil tank filler connection that can retain any appreciable quantity of oil must have a drain that discharges clear of the entire rotorcraft. In addition –
 - (1) Each oil tank filler cap must provide an oil-tight seal under the pressure expected in operation;
 - (2) For Category A rotorcraft, each oil tank filler cap or filler cap cover must incorporate features that provide a warning when caps are not fully locked or seated on the filler connection; and
 - (3) Each oil filler must be marked under [CS 29.1557\(c\)\(2\)](#).
- (d) *Vent.* Oil tanks must be vented as follows:
 - (1) Each oil tank must be vented from the top part of the expansion space so that venting is effective under all normal flight conditions.

- (2) Oil tank vents must be arranged so that condensed water vapour that might freeze and obstruct the line cannot accumulate at any point.
- (e) *Outlet.* There must be means to prevent entrance into the tank itself, or into the tank outlet, of any object that might obstruct the flow of oil through the system. No oil tank outlet may be enclosed by a screen or guard that would reduce the flow of oil below a safe value at any operating temperature. There must be a shutoff valve at the outlet of each oil tank used with a turbine engine unless the external portion of the oil system (including oil tank supports) is fireproof.
- (f) *Flexible liners.* Each flexible oil tank liner must be approved or shown to be suitable for the particular installation.

CS 29.1015 Oil tank tests

ED Decision 2003/16/RM

Each oil tank must be designed and installed so that –

- (a) It can withstand, without failure, any vibration, inertia, and fluid loads to which it may be subjected in operation; and
- (b) It meets the requirements of [CS 29.965](#), except that instead of the pressure specified in [CS 29.965\(b\)](#) –
 - (1) For pressurised tanks used with a turbine engine, the test pressure may not be less than 34 kPa (5 psi) plus the maximum operating pressure of the tank; and
 - (2) For all other tanks, the test pressure may not be less than 34 kPa (5 psi).

CS 29.1017 Oil lines and fittings

ED Decision 2003/16/RM

- (a) Each oil line must meet the requirements of [CS 29.993](#).
- (b) Breather lines must be arranged so that –
 - (1) Condensed water vapour that might freeze and obstruct the line cannot accumulate at any point;
 - (2) The breather discharge will not constitute a fire hazard if foaming occurs, or cause emitted oil to strike the pilot's windshield; and
 - (3) The breather does not discharge into the engine air induction system.

CS 29.1019 Oil strainer or filter

ED Decision 2003/16/RM

- (a) Each turbine engine installation must incorporate an oil strainer or filter through which all of the engine oil flows and which meets the following requirements:
 - (1) Each oil strainer or filter that has a bypass must be constructed and installed so that oil will flow at the normal rate through the rest of the system with the strainer or filter completely blocked.
 - (2) The oil strainer or filter must have the capacity (with respect to operating limitations established for the engine) to ensure that engine oil system functioning is not impaired

when the oil is contaminated to a degree (with respect to particle size and density) that is greater than that established for the engine under CS-E.

- (3) The oil strainer or filter, unless it is installed at an oil tank outlet, must incorporate a means to indicate contamination before it reaches the capacity established in accordance with subparagraph (a)(2).
 - (4) The bypass of a strainer or filter must be constructed and installed so that the release of collected contaminants is minimised by appropriate location of the bypass to ensure that collected contaminants are not in the bypass flow path.
 - (5) An oil strainer or filter that has no bypass, except one that is installed at an oil tank outlet, must have a means to connect it to the warning system required in [CS 29.1305\(a\)\(18\)](#).
- (b) Each oil strainer or filter in a powerplant installation using reciprocating engines must be constructed and installed so that oil will flow at the normal rate through the rest of the system with the strainer or filter element completely blocked.

CS 29.1021 Oil system drains

ED Decision 2003/16/RM

A drain (or drains) must be provided to allow safe drainage of the oil system. Each drain must –

- (a) Be accessible; and
- (b) Have manual or automatic means for positive locking in the closed position.

CS 29.1023 Oil radiators

ED Decision 2003/16/RM

- (a) Each oil radiator must be able to withstand any vibration, inertia, and oil pressure loads to which it would be subjected in operation.
- (b) Each oil radiator air duct must be located, or equipped, so that, in case of fire, and with the airflow as it would be with and without the engine operating, flames cannot directly strike the radiator.

CS 29.1025 Oil valves

ED Decision 2003/16/RM

- (a) Each oil shutoff must meet the requirements of [CS 29.1189](#).
- (b) The closing of oil shutoffs may not prevent autorotation.
- (c) Each oil valve must have positive stops or suitable index provisions in the 'on' and 'off' positions and must be supported so that no loads resulting from its operation or from accelerated flight conditions are transmitted to the lines attached to the valve.

CS 29.1027 Transmissions and gearboxes: General

ED Decision 2003/16/RM

- (a) The oil system for components of the rotor drive system that require continuous lubrication must be sufficiently independent of the lubrication systems of the engine(s) to ensure:
 - (1) Operation with any engine inoperative; and
 - (2) Safe autorotation.

-
- (b) Pressure lubrication systems for transmissions and gearboxes must comply with the requirements of [CS 29.1013](#), sub-paragraphs (c), (d) and (f) only, [CS 29.1015](#), [29.1017](#), [29.1021](#), [29.1023](#) and [29.1337\(d\)](#). In addition, the system must have:
- (1) An oil strainer or filter through which all the lubricant flows, and must:
 - (i) Be designed to remove from the lubricant any contaminant which may damage transmission and drive system components or impede the flow of lubricant to a hazardous degree; and
 - (ii) Be equipped with a bypass constructed and installed so that:
 - (A) The lubricant will flow at the normal rate through the rest of the system with the strainer or filter completely blocked; and
 - (B) The release of collected contaminants is minimised by appropriate location of the bypass to ensure that collected contaminants are not in the bypass flow path;
 - (iii) Be equipped with a means to indicate collection of contaminants on the filter or strainer at or before opening of the bypass;
 - (2) For each lubricant tank or sump outlet supplying lubrication to rotor drive systems and rotor drive system components, a screen to prevent entrance into the lubrication system of any object that might obstruct the flow of lubricant from the outlet to the filter required by sub-paragraph (b)(1). The requirements of sub-paragraph (b)(1) do not apply to screens installed at lubricant tank or sump outlets.
- (c) Splash type lubrication systems for rotor drive system gearboxes must comply with [CS 29.1021](#) and [29.1337\(d\)](#).

COOLING

CS 29.1041 General

ED Decision 2003/16/RM

- (a) The powerplant and auxiliary power unit cooling provisions must be able to maintain the temperatures of powerplant components, engine fluids, and auxiliary power unit components and fluids within the temperature limits established for these components and fluids, under ground, water, and flight operating conditions for which certification is requested, and after normal engine or auxiliary power shut-down, or both.
- (b) There must be cooling provisions to maintain the fluid temperatures in any power transmission within safe values under any critical surface (ground or water) and flight operating conditions.
- (c) Except for ground-use-only auxiliary power units, compliance with sub-paragraphs (a) and (b) must be shown by flight tests in which the temperatures of selected powerplant component and auxiliary power unit component, engine, and transmission fluids are obtained under the conditions prescribed in those paragraphs.

CS 29.1043 Cooling tests

ED Decision 2003/16/RM

- (a) *General.* For the tests prescribed in [CS 29.1041\(c\)](#), the following apply:
 - (1) If the tests are conducted under conditions deviating from the maximum ambient atmospheric temperature specified in sub-paragraph (b), the recorded powerplant temperatures must be corrected under sub-paragraphs (c) and (d), unless a more rational correction method is applicable.
 - (2) No corrected temperature determined under sub-paragraph (a)(1) may exceed established limits.
 - (3) The fuel used during the cooling tests must be of the minimum grade approved for the engines, and the mixture settings must be those used in normal operation.
 - (4) The test procedures must be as prescribed in [CS 29.1045](#) to [29.1049](#).
 - (5) For the purposes of the cooling tests, a temperature is 'stabilised' when its rate of change is less than 1°C (2°F) per minute.
- (b) *Maximum ambient atmospheric pressure.* A maximum ambient atmospheric temperature corresponding to sea-level conditions of at least 38°C (100°F) must be established. The assumed temperature lapse rate is 2.0°C (3.6°F) per thousand feet of altitude above sea-level until a temperature of -56.5°C (-69.7°F) is reached, above which altitude the temperature is considered constant at -56.5°C (-69.7°F). However, for winterisation installations, the applicant may select a maximum ambient atmospheric temperature corresponding to sea-level conditions of less than 38°C (100°F).
- (c) *Correction factor (except cylinder barrels).* Unless a more rational correction applies, temperatures of engine fluids and powerplant components (except cylinder barrels) for which temperature limits are established, must be corrected by adding to them the difference between the maximum ambient atmospheric temperature and the temperature of the ambient air at the time of the first occurrence of the maximum component or fluid temperature recorded during the cooling test.

- (d) *Correction factor for cylinder barrel temperatures.* Cylinder barrel temperatures must be corrected by adding to them 0.7 times the difference between the maximum ambient atmospheric temperature and the temperature of the ambient air at the time of the first occurrence of the maximum cylinder barrel temperature recorded during the cooling test.

CS 29.1045 Climb cooling test procedures

ED Decision 2003/16/RM

- (a) Climb cooling tests must be conducted under this paragraph for:
- (1) Category A rotorcraft; and
 - (2) Multi-engine Category B rotorcraft for which certification is requested under the Category A powerplant installation requirements, and under the requirements of [CS 29.861\(a\)](#) at the steady rate of climb or descent established under [CS 29.67\(b\)](#).
- (b) The climb or descent cooling tests must be conducted with the engine inoperative that produces the most adverse cooling conditions for the remaining engines and powerplant components.
- (c) Each operating engine must:
- (1) For helicopters for which the use of 30-minute OEI power is requested, be at 30-minute OEI power for 30 minutes, and then at maximum continuous power (or at full throttle, when above the critical altitude);
 - (2) For helicopters for which the use of continuous OEI power is requested, be at continuous OEI power (or at full throttle when above the critical altitude); and
 - (3) For other rotorcraft, be at maximum continuous power (or at full throttle when above the critical altitude).
- (d) After temperatures have stabilised in flight, the climb must be:
- (1) Begun from an altitude not greater than the lower of:
 - (i) 305 m (1000 ft) below the engine critical altitude; and
 - (ii) 305 m (1000 ft) below the maximum altitude at which the rate of climb is 0.76 m/s (150 fpm); and
 - (2) Continued for at least 5 minutes after the occurrence of the highest temperature recorded, or until the rotorcraft reaches the maximum altitude for which certification is requested.
- (e) For Category B rotorcraft without a positive rate of climb, the descent must begin at the all-engine-critical altitude and end at the higher of:
- (1) The maximum altitude at which level flight can be maintained with one engine operative; and
 - (2) Sea-level.
- (f) The climb or descent must be conducted at an airspeed representing a normal operational practice for the configuration being tested. However, if the cooling provisions are sensitive to rotorcraft speed, the most critical airspeed must be used, but need not exceed the speeds established under [CS 29.67\(a\)\(2\)](#) or [29.67\(b\)](#). The climb cooling test may be conducted in conjunction with the take-off cooling test of [CS 29.1047](#).

CS 29.1047 Take-off cooling test procedures

ED Decision 2003/16/RM

- (a) *Category A.* For each Category A rotorcraft, cooling must be shown during take-off and subsequent climb as follows:
- (1) Each temperature must be stabilised while hovering in ground effect with:
 - (i) The power necessary for hovering;
 - (ii) The appropriate cowl flap and shutter settings; and
 - (iii) The maximum weight.
 - (2) After the temperatures have stabilised, a climb must be started at the lowest practicable altitude and must be conducted with one engine inoperative.
 - (3) The operating engines must be at the greatest power for which approval is sought (or at full throttle when above the critical altitude) for the same period as this power is used in determining the take-off climbout path under [CS 29.59](#).
 - (4) At the end of the time interval prescribed in sub-paragraph (b)(3), the power must be changed to that used in meeting [CS 29.67\(a\)\(2\)](#) and the climb must be continued for:
 - (i) 30 minutes, if 30-minute OEI power is used; or
 - (ii) At least 5 minutes after the occurrence of the highest temperature recorded, if continuous OEI power or maximum continuous power is used.
 - (5) The speeds must be those used in determining the take-off flight path under [CS 29.59](#).
- (b) *Category B.* For each Category B rotorcraft, cooling must be shown during take-off and subsequent climb as follows:
- (1) Each temperature must be stabilised while hovering in ground effect with:
 - (i) The power necessary for hovering;
 - (ii) The appropriate cowl flap and shutter settings; and
 - (iii) The maximum weight.
 - (2) After the temperatures have stabilised, a climb must be started at the lowest practicable altitude with take-off power.
 - (3) Take-off power must be used for the same time interval as take-off power is used in determining the take-off flight path under [CS 29.63](#).
 - (4) At the end of the time interval prescribed in sub-paragraph (a)(3), the power must be reduced to maximum continuous power and the climb must be continued for at least 5 minutes after the occurrence of the highest temperature recorded.
 - (5) The cooling test must be conducted at an airspeed corresponding to normal operating practice for the configuration being tested. However, if the cooling provisions are sensitive to rotorcraft speed, the most critical airspeed must be used, but need not exceed the speed for best rate of climb with maximum continuous power.

CS 29.1049 Hovering cooling test procedures

ED Decision 2003/16/RM

The hovering cooling provisions must be shown –

- (a) At maximum weight or at the greatest weight at which the rotorcraft can hover (if less), at sea-level, with the power required to hover but not more than maximum continuous power, in the ground effect in still air, until at least 5 minutes after the occurrence of the highest temperature recorded; and
- (b) With maximum continuous power, maximum weight, and at the altitude resulting in zero rate of climb for this configuration, until at least 5 minutes after the occurrence of the highest temperature recorded.

INDUCTION SYSTEM

CS 29.1091 Air induction

ED Decision 2003/16/RM

- (a) The air induction system for each engine and auxiliary power unit must supply the air required by that engine and auxiliary power unit under the operating conditions for which certification is requested.
- (b) Each engine and auxiliary power unit air induction system must provide air for proper fuel metering and mixture distribution with the induction system valves in any position.
- (c) No air intake may open within the engine accessory section or within other areas of any powerplant compartment where emergence of backfire flame would constitute a fire hazard.
- (d) Each reciprocating engine must have an alternate air source.
- (e) Each alternate air intake must be located to prevent the entrance of rain, ice, or other foreign matter.
- (f) For turbine engine powered rotorcraft and rotorcraft incorporating auxiliary power units:
 - (1) There must be means to prevent hazardous quantities of fuel leakage or overflow from drains, vents, or other components of flammable fluid systems from entering the engine or auxiliary power unit intake system; and
 - (2) The air inlet ducts must be located or protected so as to minimise the ingestion of foreign matter during take-off, landing, and taxiing.

CS 29.1093 Induction system icing protection

ED Decision 2003/16/RM

- (a) *Reciprocating engines.* Each reciprocating engine air induction system must have means to prevent and eliminate icing. Unless this is done by other means, it must be shown that, in air free of visible moisture at a temperature of -1°C (30°F) and with the engines at 60% of maximum continuous power –
 - (1) Each rotorcraft with sea-level engines using conventional venturi carburetors has a preheater that can provide a heat rise of 50°C (90°F);
 - (2) Each rotorcraft with sea-level engines using carburetors tending to prevent icing has a preheater that can provide a heat rise of 39°C (70°F);
 - (3) Each rotorcraft with altitude engines using conventional venturi carburetors has a preheater that can provide a heat rise of 67°C (120°F); and
 - (4) Each rotorcraft with altitude engines using carburetors tending to prevent icing has a preheater that can provide a heat rise of 56°C (100°F).
- (b) *Turbine engines:*
 - (1) It must be shown that each turbine engine and its air inlet system can operate throughout the flight power range of the engine (including idling):
 - (i) Without accumulating ice on engine or inlet system components that would adversely affect engine operation or cause a serious loss of power under the icing conditions specified in [Appendix C](#); and

- (ii) In snow, both falling and blowing, without adverse effect on engine operation, within the limitations established for the rotorcraft.
- (2) Each turbine engine must idle for 30 minutes on the ground, with the air bleed available for engine icing protection at its critical condition, without adverse effect, in an atmosphere that is at a temperature between -9°C and -1°C (between 15°F and 30°F) and has a liquid water content not less than 0.3 grams per cubic meter in the form of drops having a mean effective diameter not less than 20 microns, followed by momentary operation at take-off power or thrust. During the 30 minutes of idle operation, the engine may be run up periodically to a moderate power or thrust setting in a manner acceptable to the Agency.
- (c) *Supercharged reciprocating engines.* For each engine having a supercharger to pressurise the air before it enters the carburettor, the heat rise in the air caused by that supercharging at any altitude may be utilised in determining compliance with subparagraph (a) if the heat rise utilised is that which will be available, automatically, for the applicable altitude and operation condition because of supercharging.

CS 29.1101 Carburettor air preheater design

ED Decision 2003/16/RM

Each carburettor air preheater must be designed and constructed to:

- (a) Ensure ventilation of the preheater when the engine is operated in cold air;
- (b) Allow inspection of the exhaust manifold parts that it surrounds; and
- (c) Allow inspection of critical parts of the preheater itself.

CS 29.1103 Induction systems ducts and air duct systems

ED Decision 2003/16/RM

- (a) Each induction system duct upstream of the first stage of the engine supercharger and of the auxiliary power unit compressor must have a drain to prevent the hazardous accumulation of fuel and moisture in the ground attitude. No drain may discharge where it might cause a fire hazard.
- (b) Each duct must be strong enough to prevent induction system failure from normal backfire conditions.
- (c) Each duct connected to components between which relative motion could exist must have means for flexibility.
- (d) Each duct within any fire zone for which a fire-extinguishing system is required must be at least:
 - (1) Fireproof, if it passes through any firewall; or
 - (2) Fire resistant, for other ducts, except that ducts for auxiliary power units must be fireproof within the auxiliary power unit fire zone.
- (e) Each auxiliary power unit induction system duct must be fireproof for a sufficient distance upstream of the auxiliary power unit compartment to prevent hot gas reverse flow from burning through auxiliary power unit ducts and entering any other compartment or area of the rotorcraft in which a hazard would be created resulting from the entry of hot gases. The materials used to form the remainder of the induction system duct and plenum chamber of the auxiliary power unit must be capable of resisting the maximum heat conditions likely to occur.

- (f) Each auxiliary power unit induction system duct must be constructed of materials that will not absorb or trap hazardous quantities of flammable fluids that could be ignited in the event of a surge or reverse flow condition.

CS 29.1105 Induction system screens

ED Decision 2003/16/RM

If induction system screens are used:

- (a) Each screen must be upstream of the carburettor;
- (b) No screen may be in any part of the induction system that is the only passage through which air can reach the engine, unless it can be deiced by heated air;
- (c) No screen may be deiced by alcohol alone; and
- (d) It must be impossible for fuel to strike any screen.

CS 29.1107 Inter-coolers and after-coolers

ED Decision 2003/16/RM

Each inter-cooler and after-cooler must be able to withstand the vibration, inertia, and air pressure loads to which it would be subjected in operation.

CS 29.1109 Carburettor air cooling

ED Decision 2003/16/RM

It must be shown under [CS 29.1043](#) that each installation using two-stage superchargers has means to maintain the air temperature, at the carburettor inlet, at or below the maximum established value.

EXHAUST SYSTEM

CS 29.1121 General

ED Decision 2003/16/RM

For powerplant and auxiliary power unit installations the following apply:

- (a) Each exhaust system must ensure safe disposal of exhaust gases without fire hazard or carbon monoxide contamination in any personnel compartment.
- (b) Each exhaust system part with a surface hot enough to ignite flammable fluids or vapours must be located or shielded so that leakage from any system carrying flammable fluids or vapours will not result in a fire caused by impingement of the fluids or vapours on any part of the exhaust system including shields for the exhaust system.
- (c) Each component upon which hot exhaust gases could impinge, or that could be subjected to high temperatures from exhaust system parts, must be fireproof. Each exhaust system component must be separated by a fireproof shield from adjacent parts of the rotorcraft that are outside the engine and auxiliary power unit compartments.
- (d) No exhaust gases may discharge so as to cause a fire hazard with respect to any flammable fluid vent or drain.
- (e) No exhaust gases may discharge where they will cause a glare seriously affecting pilot vision at night.
- (f) Each exhaust system component must be ventilated to prevent points of excessively high temperature.
- (g) Each exhaust shroud must be ventilated or insulated to avoid, during normal operation, a temperature high enough to ignite any flammable fluids or vapours outside the shroud.
- (h) If significant traps exist, each turbine engine exhaust system must have drains discharging clear of the rotorcraft, in any normal ground and flight attitudes, to prevent fuel accumulation after the failure of an attempted engine start.

CS 29.1123 Exhaust piping

ED Decision 2003/16/RM

- (a) Exhaust piping must be heat and corrosion resistant, and must have provisions to prevent failure due to expansion by operating temperatures.
- (b) Exhaust piping must be supported to withstand any vibration and inertia loads to which it would be subjected in operation.
- (c) Exhaust piping connected to components between which relative motion could exist must have provisions for flexibility.

CS 29.1125 Exhaust heat exchangers

ED Decision 2003/16/RM

For reciprocating engine powered rotorcraft the following apply:

- (a) Each exhaust heat exchanger must be constructed and installed to withstand the vibration, inertia, and other loads to which it would be subjected in operation. In addition:
 - (1) Each exchanger must be suitable for continued operation at high temperatures and resistant to corrosion from exhaust gases;
 - (2) There must be means for inspecting the critical parts of each exchanger;
 - (3) Each exchanger must have cooling provisions wherever it is subject to contact with exhaust gases; and
 - (4) No exhaust heat exchanger or muff may have stagnant areas or liquid traps that would increase the probability of ignition of flammable fluids or vapours that might be present in case of the failure or malfunction of components carrying flammable fluids.
- (b) If an exhaust heat exchanger is used for heating ventilating air used by personnel –
 - (1) There must be a secondary heat exchanger between the primary exhaust gas heat exchanger and the ventilating air system; or
 - (2) Other means must be used to prevent harmful contamination of the ventilating air.

POWERPLANT CONTROLS AND ACCESSORIES

CS 29.1141 Powerplant controls: general

ED Decision 2003/16/RM

- (a) Powerplant controls must be located and arranged under [CS 29.777](#) and marked under [CS 29.1555](#).
- (b) Each control must be located so that it cannot be inadvertently operated by persons entering, leaving or moving normally in the cockpit.
- (c) Each flexible powerplant control must be approved.
- (d) Each control must be able to maintain any set position without:
 - (1) Constant attention; or
 - (2) Tendency to creep due to control loads or vibration.
- (e) Each control must be able to withstand operating loads without excessive deflection.
- (f) Controls of powerplant valves required for safety must have:
 - (1) For manual valves, positive stops or in the case of fuel valves suitable index provisions, in the open and closed position; and
 - (2) For power-assisted valves, a means to indicate to the flight crew when the valve:
 - (i) Is in the fully open or fully closed position; or
 - (ii) Is moving between the fully open and fully closed position.

CS 29.1142 Auxiliary power unit controls

ED Decision 2003/16/RM

Means must be provided on the flight deck for starting, stopping, and emergency shutdown of each installed auxiliary power unit.

CS 29.1143 Engine controls

ED Decision 2003/16/RM

- (a) There must be a separate power control for each engine.
- (b) Power controls must be arranged to allow ready synchronisation of all engines by:
 - (1) Separate control of each engine; and
 - (2) Simultaneous control of all engines.
- (c) Each power control must provide a positive and immediately responsive means of controlling its engine.
- (d) Each fluid injection control other than fuel system control must be in the corresponding power control. However, the injection system pump may have a separate control.
- (e) If a power control incorporates a fuel shutoff feature, the control must have a means to prevent the inadvertent movement of the control into the shutoff position. The means must –
 - (1) Have a positive lock or stop at the idle position; and

- (2) Require a separate and distinct operation to place the control in the shutoff position.
- (f) For rotorcraft to be certificated for a 30-second OEI power rating, a means must be provided to automatically activate and control the 30-second OEI power and prevent any engine from exceeding the installed engine limits associated with the 30-second OEI power rating approved for the rotorcraft.

CS 29.1145 Ignition switches

ED Decision 2003/16/RM

- (a) Ignition switches must control each ignition circuit on each engine.
- (b) There must be means to quickly shut off all ignition by the grouping of switches or by a master ignition control.
- (c) Each group of ignition switches, except ignition switches for turbine engines for which continuous ignition is not required, and each master ignition control, must have a means to prevent its inadvertent operation.

CS 29.1147 Mixture controls

ED Decision 2003/16/RM

- (a) If there are mixture controls, each engine must have a separate control, and the controls must be arranged to allow:
 - (1) Separate control of each engine; and
 - (2) Simultaneous control of all engines.
- (b) Each intermediate position of the mixture controls that corresponds to a normal operating setting must be identifiable by feel and sight.

CS 29.1151 Rotor brake controls

ED Decision 2003/16/RM

- (a) It must be impossible to apply the rotor brake inadvertently in flight.
- (b) There must be means to warn the crew if the rotor brake has not been completely released before take-off.

CS 29.1157 Carburettor air temperature controls

ED Decision 2003/16/RM

There must be a separate carburettor air temperature control for each engine.

CS 29.1159 Supercharger controls

ED Decision 2003/16/RM

Each supercharger control must be accessible to:

- (a) The pilots; or
- (b) (If there is a separate flight engineer station with a control panel) the flight engineer.

CS 29.1163 Powerplant accessories

ED Decision 2003/16/RM

- (a) Each engine-mounted accessory must:
 - (1) Be approved for mounting on the engine involved;
 - (2) Use the provisions on the engine for mounting; and
 - (3) Be sealed in such a way as to prevent contamination of the engine oil system and accessory system.
- (b) Electrical equipment subject to arcing or sparking must be installed, to minimise the probability of igniting flammable fluids or vapours.
- (c) If continued rotation of an engine-driven cabin supercharger or any remote accessory driven by the engine will be a hazard if they malfunction, there must be means to prevent their hazardous rotation without interfering with the continued operation of the engine.
- (d) Unless other means are provided, torque limiting means must be provided for accessory drives located on any component of the transmission and rotor drive system to prevent damage to these components from excessive accessory load.

CS 29.1165 Engine ignition systems

ED Decision 2003/16/RM

- (a) Each battery ignition system must be supplemented with a generator that is automatically available as an alternate source of electrical energy to allow continued engine operation if any battery becomes depleted.
- (b) The capacity of batteries and generators must be large enough to meet the simultaneous demands of the engine ignition system and the greatest demands of any electrical system components that draw from the same source.
- (c) The design of the engine ignition system must account for:
 - (1) The condition of an inoperative generator;
 - (2) The condition of a completely depleted battery with the generator running at its normal operating speed; and
 - (3) The condition of a completely depleted battery with the generator operating at idling speed, if there is only one battery.
- (d) Magneto ground wiring (for separate ignition circuits) that lies on the engine side of any firewall must be installed, located, or protected, to minimise the probability of the simultaneous failure of two or more wires as a result of mechanical damage, electrical fault or other cause.
- (e) No ground wire for any engine may be routed through a fire zone of another engine unless each part of that wire within that zone is fireproof.
- (f) Each ignition system must be independent of any electrical circuit that is not used for assisting, controlling, or analysing the operation of that system.
- (g) There must be means to warn appropriate crew members if the malfunctioning of any part of the electrical system is causing the continuous discharge of any battery necessary for engine ignition.

POWERPLANT FIRE PROTECTION

CS 29.1181 Designated fire zones: regions included

ED Decision 2003/16/RM

- (a) Designated fire zones are:
- (1) The engine power section of reciprocating engines;
 - (2) The engine accessory section of reciprocating engines;
 - (3) Any complete powerplant compartment in which there is no isolation between the engine power section and the engine accessory section, for reciprocating engines;
 - (4) Any auxiliary power unit compartment;
 - (5) Any fuel-burning heater and other combustion equipment installation described in [CS 29.859](#);
 - (6) The compressor and accessory sections of turbine engines; and
 - (7) The combustor, turbine, and tailpipe sections of turbine engine installations except sections that do not contain lines and components carrying flammable fluids or gases and are isolated from the designated fire zone prescribed in sub-paragraph (a)(6) by a firewall that meets [CS 29.1191](#).
- (b) Each designated fire zone must meet the requirements of [CS 29.1183](#) to [29.1203](#).

CS 29.1183 Lines, fittings, and components

ED Decision 2003/16/RM

- (a) Except as provided in sub-paragraph (b), each line, fitting, and other component carrying flammable fluid in any area subject to engine fire conditions and each component which conveys or contains flammable fluid in a designated fire zone must be fire resistant, except that flammable fluid tanks and supports in a designated fire zone must be fireproof or be enclosed by a fireproof shield unless damage by fire to any non-fireproof part will not cause leakage or spillage of flammable fluid. Components must be shielded or located so as to safeguard against the ignition of leaking flammable fluid. An integral oil sump of less than 24 litres (5.2 Imperial gallons/25 US-quart) capacity on a reciprocating engine need not be fireproof nor be enclosed by a fireproof shield.
- (b) Sub-paragraph (a) does not apply to:
- (1) Lines, fittings, and components which are already approved as part of a type certificated engine; and
 - (2) Vent and drain lines, and their fittings, whose failure will not result in or add to, a fire hazard.

CS 29.1185 Flammable fluids

ED Decision 2003/16/RM

- (a) No tank or reservoir that is part of a system containing flammable fluids or gases may be in a designated fire zone unless the fluid contained, the design of the system, the materials used in the tank and its supports, the shutoff means, and the connections, lines, and controls provide a degree of safety equal to that which would exist if the tank or reservoir were outside such a zone.
- (b) Each fuel tank must be isolated from the engines by a firewall or shroud.
- (c) There must be at least 13 mm (½ inch) of clear airspace between each tank or reservoir and each firewall or shroud isolating a designated fire zone, unless equivalent means are used to prevent heat transfer from the fire zone to the flammable fluid.
- (d) Absorbent material close to flammable fluid system components that might leak must be covered or treated to prevent the absorption of hazardous quantities of fluids.

CS 29.1187 Drainage and ventilation of fire zones

ED Decision 2003/16/RM

- (a) There must be complete drainage of each part of each designated fire zone to minimise the hazards resulting from failure or malfunction of any component containing flammable fluids. The drainage means must be:
 - (1) Effective under conditions expected to prevail when drainage is needed; and
 - (2) Arranged so that no discharged fluid will cause an additional fire hazard.
- (b) Each designated fire zone must be ventilated to prevent the accumulation of flammable vapours.
- (c) No ventilation opening may be where it would allow the entry of flammable fluids, vapours, or flame from other zones.
- (d) Ventilation means must be arranged so that no discharged vapours will cause an additional fire hazard.
- (e) For Category A rotorcraft there must be means to allow the crew to shut off the sources of forced ventilation in any fire zone (other than the engine power section of the powerplant compartment) unless the amount of extinguishing agent and the rate of discharge are based on the maximum airflow through that zone.

CS 29.1189 Shutoff means

ED Decision 2003/16/RM

- (a) There must be means to shut off or otherwise prevent hazardous quantities of fuel, oil, de-icing fluid, and other flammable fluids from flowing into, within, or through any designated fire zone, except that this means need not be provided:
 - (1) For lines, fittings, and components forming an integral part of an engine;
 - (2) For oil systems for turbine engine installations in which all components of the oil system, including oil tanks, are fireproof or located in areas not subject to engine fire conditions;or

- (3) For engine oil systems in Category B rotorcraft using reciprocating engines of less than 8195 cm³ (500 cubic inches) displacement.
- (b) The closing of any fuel shutoff valve for any engine may not make fuel unavailable to the remaining engines.
- (c) For Category A rotorcraft no hazardous quantity of flammable fluid may drain into any designated fire zone after shutoff has been accomplished, nor may the closing of any fuel shutoff valve for an engine make fuel unavailable to the remaining engines.
- (d) The operation of any shutoff may not interfere with the later emergency operation of any other equipment, such as the means for declutching the engine from the rotor drive.
- (e) Each shutoff valve and its control must be designed, located, and protected to function properly under any condition likely to result from fire in a designated fire zone.
- (f) Except for ground-use-only auxiliary power unit installations, there must be means to prevent inadvertent operation of each shutoff and to make it possible to re-open it in flight after it has been closed.

CS 29.1191 Firewalls

ED Decision 2003/16/RM

- (a) Each engine, including the combustor, turbine, and tailpipe sections of turbine engine installations, must be isolated by a firewall, shroud, or equivalent means, from personnel compartments, structures, controls, rotor mechanisms, and other parts that are:
 - (1) Essential to controlled flight and landing; and
 - (2) Not protected under [CS 29.861](#).
- (b) Each auxiliary power unit, combustion heater, and other combustion equipment to be used in flight, must be isolated from the rest of the rotorcraft by firewalls, shrouds, or equivalent means.
- (c) Each firewall or shroud must be constructed so that no hazardous quantity of air, fluid, or flame can pass from any engine compartment to other parts of the rotorcraft.
- (d) Each opening in the firewall or shroud must be sealed with close-fitting fireproof grommets, bushings, or firewall fittings.
- (e) Each firewall and shroud must be fireproof and protected against corrosion.
- (f) In meeting this paragraph, account must be taken of the probable path of a fire as affected by the airflow in normal flight and in autorotation.

CS 29.1193 Cowling and engine compartment covering

ED Decision 2003/16/RM

- (a) Each cowling and engine compartment covering must be constructed and supported so that it can resist the vibration, inertia and air loads to which it may be subjected in operation.
- (b) Cowling must meet the drainage and ventilation requirements of [CS 29.1187](#).

- (c) On rotorcraft with a diaphragm isolating the engine power section from the engine accessory section, each part of the accessory section cowling subject to flame in case of fire in the engine power section of the powerplant must:
 - (1) Be fireproof; and
 - (2) Meet the requirements of [CS 29.1191](#).
- (d) Each part of the cowling or engine compartment covering subject to high temperatures due to its nearness to exhaust system parts or exhaust gas impingement must be fireproof.
- (e) Each rotorcraft must:
 - (1) Be designed and constructed so that no fire originating in any fire zone can enter, either through openings or by burning through external skin, any other zone or region where it would create additional hazards;
 - (2) Meet the requirements of sub-paragraph (e)(1) with the landing gear retracted (if applicable); and
 - (3) Have fireproof skin in areas subject to flame if a fire starts in or burns out of any designated fire zone.
- (f) A means of retention for each openable or readily removable panel, cowling, or engine or rotor drive system covering must be provided to preclude hazardous damage to rotors or critical control components in the event of:
 - (1) Structural or mechanical failure of the normal retention means, unless such failure is extremely improbable; or
 - (2) Fire in a fire zone, if such fire could adversely affect the normal means of retention.

CS 29.1194 Other surfaces

ED Decision 2003/16/RM

All surfaces aft of, and near, engine compartments and designated fire zones, other than tail surfaces not subject to heat, flames, or sparks emanating from a designated fire zone or engine compartment, must be at least fire resistant.

CS 29.1195 Fire extinguishing systems

ED Decision 2003/16/RM

- (a) Each turbine engine powered rotorcraft and Category A reciprocating engine powered rotorcraft, and each Category B reciprocating engine powered rotorcraft with engines of more than 24 581 cm³ (1500 cubic inches) must have a fire extinguishing system for the designated fire zones. The fire extinguishing system for a powerplant must be able to simultaneously protect all zones of the powerplant compartment for which protection is provided.
- (b) For multi-engine powered rotorcraft, the fire extinguishing system, the quantity of extinguishing agent, and the rate of discharge must:
 - (1) For each auxiliary power unit and combustion equipment, provide at least one adequate discharge; and
 - (2) For each other designated fire zone, provide two adequate discharges.
- (c) For single engine rotorcraft, the quantity of extinguishing agent and the rate of discharge must provide at least one adequate discharge for the engine compartment.

- (d) It must be shown by either actual or simulated flight tests that under critical airflow conditions in flight the discharge of the extinguishing agent in each designated fire zone will provide an agent concentration capable of extinguishing fires in that zone and of minimising the probability of re-ignition.

CS 29.1197 Fire extinguishing agents

ED Decision 2003/16/RM

- (a) Fire extinguishing agents must:
- (1) Be capable of extinguishing flames emanating from any burning of fluids or other combustible materials in the area protected by the fire extinguishing system; and
 - (2) Have thermal stability over the temperature range likely to be experienced in the compartment in which they are stored.
- (b) If any toxic extinguishing agent is used, it must be shown by test that entry of harmful concentrations of fluid or fluid vapours into any personnel compartment (due to leakage during normal operation of the rotorcraft, or discharge on the ground or in flight) is prevented, even though a defect may exist in the extinguishing system.

AMC 29.1197 Fire extinguishing agents

ED Decision 2012/022/R

1. This AMC addresses alternatives to Halon and provides further guidance and acceptable means of compliance to supplement FAA AC 29-2C AC 29.1197. As such it should be used in conjunction with the FAA AC and take precedence over it in the showing of compliance.
2. The Montreal Protocol, in existence since 1987, is an international agreement to phase out production and use of ozone-depleting substances, including halogenated hydrocarbons also known as Halon. A European regulation¹ governing substances that deplete the ozone layer was published in 2000 containing initial provisions for Halon phase-out, but also exemptions for critical uses of Halon, including fire extinguishing in aviation.
3. 'Cut-off' dates (i.e. Halon no longer acceptable in new applications for type certification) and 'end' dates (i.e. Halon no longer acceptable for use in rotorcraft) have been subsequently established by a new regulation in 2010², as presented in Table 3.1 below:

¹ Regulation (EC) No 2037/2000 of the European Parliament and of the Council of 29 June 2000 on substances that deplete the ozone layer.

² Commission Regulation (EU) No 744/2010 of 18 August 2010 amending Regulation (EC) No 1005/2009 of the European Parliament and of the Council on substances that deplete the ozone layer, with regard to the critical uses of halon (OJ L 218, 19.8.2010, p. 2).

Table 3.1: ‘Cut-off’ and ‘end’ dates

Rotorcraft compartment	Type of extinguisher	Type of halon	Dates	
			Cut-off	End
Lavatory waste receptacles	Built-in	1301 1211 2402	31 December 2011	31 December 2020
Cabins and crew compartments	Hand (portable)	1211 2402	31 December 2014	31 December 2025
Propulsion systems and Auxiliary Power Units	Built-in	1301 1211 2402	31 December 2014	31 December 2040
Normally unoccupied cargo compartments	Built-in	1301 1211 2402	31 December 2018	31 December 2040

- In the course of Halon replacement, novel agent types such as fluorine ketone liquids and aerosols are being developed. In contrast to the gaseous agents, e.g. Halon 1301, which disperse more or less easily inside a given volume when released, liquid and powder-type substances require the evaluation of precise spray vectors and more complex piping configurations inside the compartment in order to achieve the concentration-over-time certification limits as required to act as an effective fire agent.

- Hand fire extinguishers and agents

Historically, Halon 1211 has been the most widespread agent in hand (portable) fire extinguishers to be used in rotorcraft compartments and cabins. Minimum Performance Standards (MPS) for the agents are laid down in Appendix A to Report DOT/FAA/AR-01/37 of August 2002, while acceptable criteria to select the fire extinguishers containing said agents are laid down in the FAA Advisory Circular AC 20-42D. Three agent alternatives to Halon are presently known to meet the MPS: HFC-227ea, HFC-236fa and HFC Blend B. However, these agents are significantly heavier and occupy a greater volume than Halon 1211. This may indirectly (i.e. additional weight of the fire extinguisher and additional weight of the structures supporting it), increase CO₂ emissions. Furthermore some of these agents have also been identified for having a global warming potential much higher than Halon. Therefore, further research is underway to develop additional alternatives to Halon 1211 for hand fire extinguishers.

Should an applicant wish to propose, even before the end of 2014, any alternative agent for hand fire extinguishers meeting the mentioned MPS, the Agency will initiate a Certification Review Item addressing the use of such an alternate fire extinguishing agent.

- Fire protection of propulsion systems and APU

Historically, Halon 1301 has been the most widespread agent used in engine or APU compartments to protect against Class B fires (i.e. fuel or other flammable fluids). The MPS for agents to be used in these compartments are particularly demanding, because of the presence of fuel and other volatile fluids in close proximity to high temperature surfaces. Various alternatives are being developed (e.g. FK-5-1-12), while the FAA is aiming at issuing a report containing the MPS.

Should an applicant wish to propose, even before the end of 2014, any alternative agent for Class B fire extinction in engine or APU compartments, even in the absence of a published MPS, the Agency will initiate a Certification Review Item addressing the use of such an alternate fire extinguishing agent.

[Amdt 29/3]

CS 29.1199 Extinguishing agent containers

ED Decision 2003/16/RM

- (a) Each extinguishing agent container must have a pressure relief to prevent bursting of the container by excessive internal pressures.
- (b) The discharge end of each discharge line from a pressure relief connection must be located so that discharge of the fire extinguishing agent would not damage the rotorcraft. The line must also be located or protected to prevent clogging caused by ice or other foreign matter.
- (c) There must be a means for each fire extinguishing agent container to indicate that the container has discharged or that the charging pressure is below the established minimum necessary for proper functioning.
- (d) The temperature of each container must be maintained, under intended operating conditions, to prevent the pressure in the container from:
 - (1) Falling below that necessary to provide an adequate rate of discharge; or
 - (2) Rising high enough to cause premature discharge.

CS 29.1201 Fire extinguishing system materials

ED Decision 2003/16/RM

- (a) No materials in any fire extinguishing system may react chemically with any extinguishing agent so as to create a hazard.
- (b) Each system component in an engine compartment must be fireproof.

CS 29.1203 Fire detector systems

ED Decision 2003/16/RM

- (a) For each turbine engine powered rotorcraft and Category A reciprocating engine powered rotorcraft, and for each Category B reciprocating engine powered rotorcraft with engines of more than 14 748 cm³ (900 cubic inches) displacement there must be approved, quick-acting fire detectors in designated fire zones and in the combustor, turbine, and tailpipe sections of turbine installations (whether or not such sections are designated fire zones) in numbers and locations ensuring prompt detection of fire in those zones.
- (b) Each fire detector must be constructed and installed to withstand any vibration, inertia and other loads to which it would be subjected in operation.
- (c) No fire detector may be affected by any oil, water, other fluids, or fumes that might be present.
- (d) There must be means to allow crew members to check, in flight, the functioning of each fire detector system electrical circuit.
- (e) The wiring and other components of each fire detector system in an engine compartment must be at least fire resistant.

- (f) No fire detector system component for any fire zone may pass through another fire zone, unless –
- (1) It is protected against the possibility of false warnings resulting from fires in zones through which it passes; or
 - (2) The zones involved are simultaneously protected by the same detector and extinguishing systems.

SUBPART F — EQUIPMENT

GENERAL

CS 29.1301 Function and installation

ED Decision 2003/16/RM

Each item of installed equipment must:

- (a) Be of a kind and design appropriate to its intended function;
- (b) Be labelled as to its identification, function, or operating limitations, or any applicable combination of these factors;
- (c) Be installed according to limitations specified for that equipment; and
- (d) Function properly when installed.

CS 29.1302 Installed systems and equipment for use by the crew members

ED Decision 2021/010/R

(See [AMC 29.1302](#), [GM1](#) and [GM2 29.1302](#))

This paragraph applies to installed systems and equipment intended to be used by the crew members when operating the rotorcraft from their normal seating positions in the cockpit or their operating positions in the cabin. The installed systems and equipment must be shown, individually and in combination with other such systems and equipment, to be designed so that trained crew members can safely perform their tasks associated with the intended function of the systems and equipment by meeting the following requirements:

- (a) The controls and information necessary for the accomplishment of the tasks must be provided.
- (b) The controls and information required by paragraph (a), which are intended for use by the crew members, must:
 - (1) be presented in a clear and unambiguous form, at a resolution and with a precision appropriate to the crew member tasks;
 - (2) be accessible and usable by the crew members in a manner appropriate to the urgency, frequency, and duration of their tasks; and
 - (3) make the crew members aware of the effects their actions may have on the rotorcraft or its systems, if they require awareness for the safe operation of the rotorcraft.
- (c) Operationally relevant behaviour of the installed systems and equipment must be:
 - (1) predictable and unambiguous; and
 - (2) designed to enable the crew members to intervene in a manner that is appropriate to accomplish their tasks.

- (d) The installed systems and equipment must enable the crew members to manage the errors that result from the kinds of crew member interactions with the system and equipment that can be reasonably expected in service, assuming the crew member acts in good faith. Paragraph (d) does not apply to skill-related errors associated with the manual control of the rotorcraft.

[Amdt 29/9]

AMC 29.1302 Installed systems and equipment for use by the crew members

ED Decision 2021/010/R

Table of Contents

1) INTRODUCTION

- 1.1 Background
- 1.2 Applicability
- 1.3 Definitions
- 1.4 Abbreviations

2) RELATION BETWEEN CS 29.1302 AND OTHER SPECIFICATIONS, AND ASSUMPTIONS

- 2.1 The relation of CS 29.1302 to other specifications
- 2.2 crew member capabilities

3) HUMAN FACTORS CERTIFICATION

- 3.1 Overview
 - 3.2.1 Identification of the cockpit and cabin controls, information and systems that involve crew member interaction
 - 3.2.2 The intended function of the equipment and the associated crew member tasks
 - 3.2.3 Determining the level of scrutiny
 - 3.2.4 Determining the level of scrutiny — EASA's familiarity with the project
 - 3.2.5 Applicable HFs design requirements
 - 3.2.6 Selecting the appropriate means of compliance
 - 3.2.7 Certification programme
 - 3.2.8 Other deliverables
 - 3.2.9 Proportional approach in the compliance demonstration
- 3.3.1 Certification strategy
- 3.3.2 Methodological considerations applicable to HFs assessments

4) DESIGN CONSIDERATIONS AND GUIDANCE

- 4.1 Overview
- 4.2 Controls
- 4.3 The presentation of information
- 4.4 System behaviour

4.5 Crew member error management

4.6 Integration

5) MEANS OF COMPLIANCE

5.1 Overview

5.2 List of the means of compliance

5.3 Selecting the means of compliance

AMC 29.1302 APPENDIX 1: Related regulatory material and documents

1) INTRODUCTION

1.1 Background

Demonstrating compliance with the design requirements that relate to human abilities and limitations is subject to interpretation. Findings may vary depending on the novelty, complexity or integration of the system design. EASA considers that describing a structured approach to selecting and developing acceptable means of compliance is useful in supporting the standardisation of compliance demonstration practices.

1.2 Applicability

- (a) This acceptable means of compliance (AMC) provides the means for demonstrating compliance with [CS 29.1302](#) and complements the means of compliance (MoC) for several other paragraphs in CS-29 (refer to paragraph 2, Table 1 of this AMC) that relate to the installed systems and equipment used by the crew members for the operation of a rotorcraft. In particular, this AMC addresses the design and approval of installed systems and equipment intended for use by the crew members from their normal seating positions in the cockpit, or their normal operating positions in the cabin.
- (b) This AMC applies to crew member interfaces and system behaviour for all the installed systems and equipment used by the crew members in the cockpit and the cabin while operating the rotorcraft in normal, abnormal/malfunction and emergency conditions. The functions of the crew members that operate from the cabin need to be considered in case they may interfere with the ones under the responsibility of the cockpit crew, or in case dedicated certification specifications are included in CS-29.
- (c) This AMC does not apply to crew member training, qualification or licensing requirements.
- (d) EASA recognises that when Part 21 requires 29.1302 to be part of the certification basis, the amount of effort the applicant has to make for demonstrating compliance with it may vary and not all the material contained within this AMC should be systematically followed. A proportionate approach is embedded within the AMC and is described in paragraph 3.2.9. The proportionate approach affects the demonstration of compliance and depends on criteria such as the rotorcraft category (A or B), the type of operation (VFR, IFR), and the classification of the change.

1.3 Definitions

For the purposes of this AMC, the following definitions apply:

- **alert:** a cockpit indication that is meant to attract the attention of the crew, and identify to them an operational or aircraft system condition. Warnings, cautions, and advisories are considered alerts.

- **assessment:** the process of finding and interpreting evidence to be used by the applicant in order to establish compliance with a specification. For the purposes of this AMC, the term ‘assessment’ may refer to both evaluations and tests. Evaluations are intended to be conducted using partially representative test means, whereas tests make use of conformed test articles.
- **automation:** the technique of controlling an apparatus, a process or a system by means of electronic and/or mechanical devices, which replaces the human organism in the sensing, decision-making and deliberate output.
- **cabin:** the area of the aircraft, excluding the cockpit, where the crew members can operate the rotorcraft systems; for the purposes of this AMC, the scope of the cabin is limited to the areas used by the crew members to operate:
 - the systems that share controls and information with the cockpit;
 - the systems which have controls and information with similar direct or indirect consequences other than the one in the cockpit (e.g. precision hovering).
- **catachresis:** applied to the area of tools, ‘catachresis’ means the use of a tool for a function other than the one planned by the designer of the tool; for instance, the use of a circuit breaker as a switch.
- **clutter:** an excessive number and/or variety of symbols, colours, or other information that may reduce the access to the relevant information, increase interpretation time and the likelihood of interpretation error.
- **cockpit:** the area of the aircraft where the flight crew members work and where the primary flight controls are located.
- **conformity:** official verification that the cockpit/system/product conforms to the type design data.
- **cockpit controls:** the interaction with a control means that the crew manipulates in order to operate, configure, and manage the aircraft or its flight control surfaces, systems, and other equipment.

This may include equipment in the cockpit such as:

- control devices,
 - buttons,
 - switches,
 - knobs,
 - flight controls, and
 - levers.
- **control device:** a control device is a piece of equipment that allows the crew to interact with the virtual controls, typically used with the graphical user interface; control devices may include the following:
 - keyboards,
 - touchscreens,
 - cursor-control devices (keypads, trackballs, pointing devices),
 - knobs, and

- voice-activated controls.
- **crew member**: a person that is involved in the operation of the aircraft and its systems; in the case of rotorcraft, the operator in the cabin that can interfere with the cockpit-crew tasks (for instance, the operator in the cabin assigned to operate the rescue hoist or to help the cockpit-crew control the aircraft in a hover is considered a crew member).
- **cursor-control device**: a control device for interacting with the virtual controls, typically used with a graphical user interface on an electro-optical display.
- **design eye reference point (DERP)**: a point in the cockpit that provides a finite reference enabling the precise determination of geometric entities that define the layout of the cockpit.
- **design feature**: a design feature is an attribute or a characteristic of a design.
- **design item**: a design item is a system, an equipment, a function, a component or a design feature.
- **design philosophy**: a high-level description of the human-centred design principles that guide the designer and aid in ensuring that a consistent, coherent user interface is presented to the crew.
- **design-related human performance issue**: a deficiency that results from the interaction between the crew and the system. It includes human errors, but also encompasses other kinds of shortcomings such as hesitation, doubt, difficulty in finding information, suboptimal strategies, inappropriate levels of workload, or any other observable item that cannot be considered to be a human error, but still reveals a design-related concern.
- **display**: a device that transmits data or information from the aircraft to the crew.
- **flight crew member**: a licensed crew member charged with duties that are essential for the operation of an aircraft during a flight duty period.
- **human error**: a deviation from what is considered correct in some context, especially in the hindsight of the analysis of accidents, incidents, or other events of interest. Some types of human error may be the following: an inappropriate action, a difference from what is expected in a procedure, an incorrect decision, an incorrect keystroke, or an omission. In the context of this AMC, human error is sometimes referred to as ‘crew error’ or ‘pilot error’.
- **multifunction control**: a control device that can be used for many functions, as opposed to a control device with a single dedicated function.
- **abnormal/malfunction or emergency conditions**: for the purposes of this AMC, abnormal/malfunction or emergency operating conditions refer to conditions that do require the crew to apply procedures different from the normal procedures included in the rotorcraft flight manual (RFM).
- **operationally relevant behaviour**: operationally relevant behaviour is meant to convey the net effect of the system logic, controls, and displayed information of the equipment upon the awareness of the crew or their perception of the operation of the system to the extent necessary for planning actions or operating the system. The intent is to distinguish such system behaviour from the functional logic within the system design, much of which the crew does not know or does not need to know, and which should be transparent to them.
- **system function allocation**: a human factors (HFs) method for deciding whether a particular function will be accomplished by a person, technology (hardware or software) or some mix of a person and technology (also referred to as ‘task allocation’).

- **task analysis:** a formal analytical method used to describe the nature and relationships of complex tasks involving a human operator.

1.4 Abbreviations

The following is a list of abbreviations used in this AMC:

AC	advisory circular
AMC	acceptable means of compliance
CAM	cockpit area microphone
CRM	crew resource management
CVR	cockpit voice recorder
CS	certification specification
DLR	data link recorder
DOT	Department of Transportation
EASA	European Union Aviation Safety Agency
ED	EUROCAE Document
FAA	Federal Aviation Administration
FMS	flight management system
GM	guidance material
HFs	human factors
HMI	human–machine interface
ICAO	International Civil Aviation Organization
ISO	International Standards Organization
LoI	level of involvement
MoC	means of compliance
PA	public address
RFM	rotorcraft flight manual
SAE	Society of Automotive Engineers
STC	supplemental type certificate
TAWS	terrain awareness and warning system
TCAS	traffic alert and collision avoidance system
TSO	technical standard order
VOR	very high frequency omnidirectional range

2) RELATION BETWEEN CS 29.1302 AND OTHER SPECIFICATIONS, AND ASSUMPTIONS

2.1 The relation of [CS 29.1302](#) to other specifications

- a) CS-29 Book 2 establishes that the AMC for CS-29 is the respective FAA AC 29-2 revision adopted by EASA with the changes/additions included within Book 2. AC 29-2 includes the Miscellaneous Guidance MG-20 ‘Human Factors’. MG-20 aims to assist the applicant in understanding the HF implications of the CS-29 paragraphs. In order to achieve this objective, MG-20 provides a list of all CS-29 HF-related specifications, including those relevant to the performance and handling qualities, and helps to address within the certification plan some of the specifications that deal with the system design with additional guidance. However, MG-20 does not include specific guidance on how to perform a comprehensive HF assessment as required by 29.1302. Therefore, adherence to the guidance material included within AC 29-2 and the associated MG-20 is not sufficient to demonstrate compliance with CS 29.1302.
- (b) This AMC provides dedicated guidance for demonstrating compliance with CS 29.1302. To help the applicant reach the objectives of CS 29.1302, some additional guidance related to other specifications associated with the installed equipment that the crew members use to operate the rotorcraft is also provided in Section 4. Table 1 below contains a list of these specifications related to cockpit design and crew member interfaces for which this AMC provides additional design guidance. Note that this AMC does not provide a comprehensive means of compliance for any of the specifications beyond [CS 29.1302](#).

Paragraph 2 — Table 1: Certification specifications relevant to this AMC

CS-29 BOOK 1 references	General topic	Referenced material in this AMC
CS 29.771(a)	Unreasonable concentration or fatigue	Error, 4.5. Integration, 4.6. Controls, 4.2. System behaviour, 4.4.
CS 29.771(b)	Controllable from either pilot seat	Controls, 4.2. Integration, 4.6.
CS 29.773	Pilot compartment view	Integration, 4.6.
CS 29.777(a)	Convenient operation of the controls	Controls, 4.2. Integration, 4.6.
CS 29.777(b)	Fully and unrestricted movement	Controls, 4.2. Integration, 4.6.
CS 29.779	Motion and effect of cockpit controls	Controls, 4.2
CS 29.1301(a)	Intended function of installed systems	Error, 4.5. Integration, 4.6. Controls, 4.2. Presentation of information, 4.3. System behaviour, 4.4.
CS 29.1302	Crew error	Error, 4.5. Integration, 4.6. Controls, 4.2. Presentation of information, 4.3. System behaviour, 4.4.
CS 29.1309(a)	Intended function of required equipment under all operating conditions	Controls, 4.2. Integration, 4.6.

CS 29.1309(c)	Unsafe system operating conditions and minimising crew errors which could create additional hazards	Presentation of information, 4.3. Errors, 4.5.
CS 29.1321	Visibility of instruments	Integration, 4.6.
CS 29.1322	Warning caution and advisory lights	Integration, 4.6.
CS 29.1329 and Appendix B VII	Automatic pilot system	System behaviour, 4.4.
CS 29.1335	Flight director systems	System behaviour, 4.4
CS 29.1523	Minimum crew	Controls, 4.2. Integration, 4.6.
CS 29.1543(b)	Visibility of instrument markings	Presentation of information, 4.3.
CS 29.1549	Powerplant instruments	Presentation of information, 4.3.
CS 29.1555(a)	Control markings	Controls, 4.2.
CS 29.1557	Miscellaneous marking and placards	Presentation of information, 4.3.

- (c) Where means of compliance in other AMC's are provided for specific equipment and systems, those means are assumed to take precedence if a conflict exists with the means provided here.

2.2 Crew member capabilities

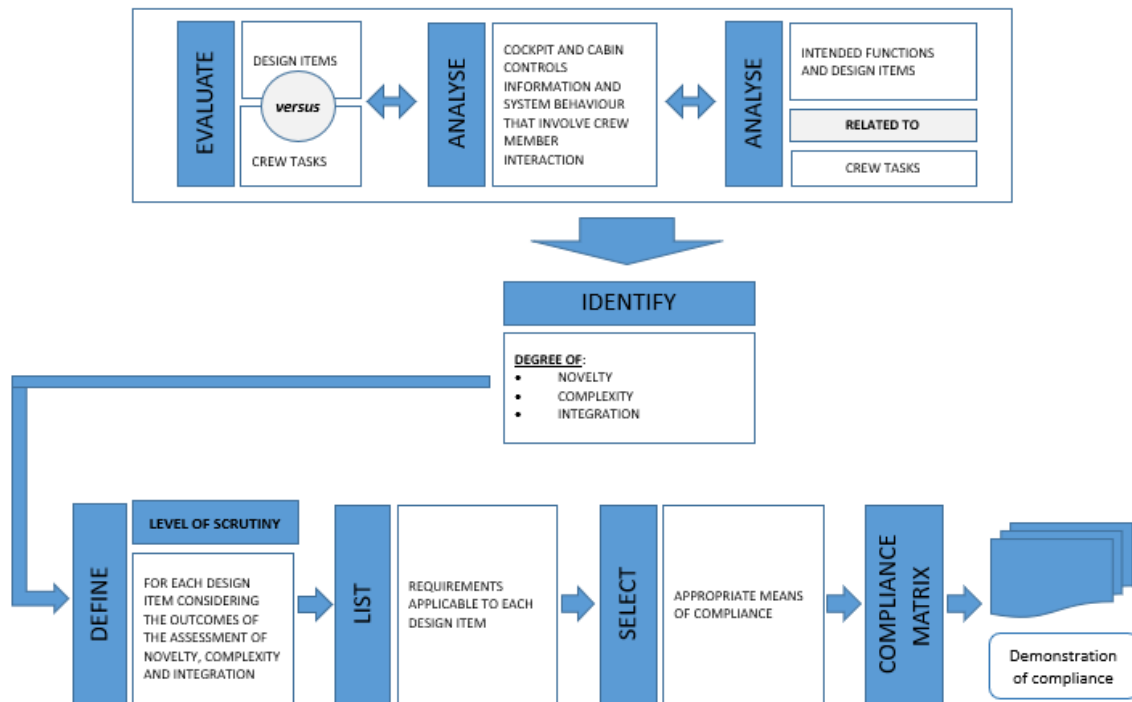
In order to demonstrate compliance with all the specifications referenced by this AMC, all the certification activities should be based on the assumption that the rotorcraft will be operated by qualified crew members who are trained in the use of the installed systems and equipment.

3) HUMAN FACTORS CERTIFICATION

3.1 Overview

- (a) This paragraph provides an overview of the human factors (HFs) certification process that is acceptable to demonstrate compliance with [CS 29.1302](#). This includes a description of the recommended applicant activities, the communication between the applicant and EASA, and the expected deliverables.
- (b) Figure 1 illustrates the main steps in the HFs certification process.

Paragraph 3 — Figure 1: Methodical approach to the certification for design related human performance issues



3.2 Certification steps and deliverables

3.2.1 Identification of the cockpit and cabin controls, information and systems that involve crew member interaction

- (a) As an initial step, the applicant should consider all the design items used by the crew members with the aim of identifying the controls, information and system behaviour that involve crew member interaction.
- (b) In case of a modification, the scope of the functions to be analysed is limited to the design items affected by the modification and its integration.
- (c) The objective is to analyse and document the crew member tasks to be performed, or how tasks might be changed or modified as a result of introducing a new design item(s).
- (d) Rotorcraft can be operated in different environments and types of missions. Therefore, while mapping the cockpit and the applicable crew member interfaces in the cabin or, in case of modification, the modified design items versus the crew member tasks and the design item intended functions, the type of approvals under the type design applicable to the rotorcraft under assessment should be considered and documented.

For instance, approvals for:

- VFR,
- IFR,
- NVIS,
- SAR,

- aerial work (cargo hook or rescue hoist), or
- flight in known icing conditions

require different equipment to be installed or a different use of the same equipment. Therefore, the applicant should clarify the assumptions made when the assessment of the cockpit and the cabin functions is carried out.

3.2.2 The intended function of the equipment and the associated crew member tasks

- (a) [CS 29.1301\(a\)](#) requires that ‘each item of installed equipment must be of a kind and design appropriate to its intended function’. [CS 29.1302](#) establishes the requirements to ensure that the design supports the ability of the crew members to perform the tasks associated with the intended function of a system. In order to demonstrate compliance with CS 29.1302, the intended function of a system and the tasks expected to be performed by the crew members must be known.
- (b) An applicant’s statement of the intended function should be sufficiently specific and detailed so that it is possible to evaluate whether the system is appropriate for the intended function(s) and the associated crew member tasks. For example, a statement that a new display system is intended to ‘enhance situational awareness’ should be further explained. A wide variety of different displays enhance the situational awareness in different ways. Some examples are terrain awareness, vertical profiles, and even the primary flight displays. The applicant may need to provide more detailed descriptions for designs with greater levels of novelty, complexity, or integration.
- (c) The applicant should describe the intended function(s) and associated task(s) for:
- (1) each design item affected by the modification and its integration;
 - (2) crew indications and controls for that equipment; and
 - (3) the prominent characteristics of those indications and controls.

This type of information is of the level typically provided in a pilot handbook or an operations manual. It would describe the indications, controls, and crew member procedures.

- (d) The applicant may evaluate whether the statement of the intended function(s) and the associated task(s) is sufficiently specific and detailed by using the following questions:
- (1) Does each design item have a stated intent?
 - (2) Are the crew member tasks associated with the function(s) described?
 - (3) What assessments, decisions, and actions are crew members expected to make based on the information provided by the system?
 - (4) What other information is assumed to be used in combination with the system?
 - (5) Will the installation or use of the system interfere with the ability of the crew members to operate other cockpit systems?
 - (6) Are any assumptions made about the operational environment in which the equipment will be used?
 - (7) What assumptions are made about the attributes or abilities of the crew members beyond those required in the regulations governing operations, training, or qualification?
- (e) The output of this step is a list of design items, with each of the associated intended functions that has been related to the crew member tasks.

3.2.3 Determining the level of scrutiny

- (a) The depth and extent of the HF investigation to be performed in order to demonstrate compliance with [CS 29.1302](#) is driven by the level of scrutiny.

The level of scrutiny is determined by analysing the design items using the criteria described in the following subparagraph:

- (1) **Integration.** The level of the systems' integration refers to the extent to which there are interdependencies between the systems that affect the operation of the rotorcraft by the crew members. The applicant should describe the integration between systems because it may affect the means of compliance. Paragraph 4.6 also refers to integration. In the context of that paragraph, 'integration' defines how specific systems are integrated into the cockpit and how the level of integration may affect the means of compliance.
- (2) **Complexity.** The level of complexity of the system design from the crew members' perspective is an important factor that may also affect the means of compliance. Complexity has multiple dimensions, for instance:
 - the number, the accessibility and the level of integration of information that the crew members have to use (the number of items of information on a display, the number of colours), alerts, or voice messages may be an indication of the complexity;
 - the number, the location and the design of the cockpit controls associated with each system and the logic associated with each of the controls; and
 - the number of steps required to perform a task, and the complexity of the workflows.
- (3) **Novelty.** The novelty of a design item is an important factor that may also affect the means of compliance. The applicant should characterise the degree of novelty on the basis of the answers to the following questions:
 - (i) Are any new functions introduced into the cockpit design?
 - (ii) Does the design introduce a new intended function for an existing or a new design item?
 - (iii) Are any new technologies introduced that affect the way the crew members interact with the systems?
 - (iv) Are any new design items introduced at aircraft level that affect crew member tasks?
 - (v) Are any unusual procedures needed as a result of the introduction of a new design item?
 - (vi) Does the design introduce a new way for the crew members to interact with the system?

While answering the above questions, each negative response should be justified by the applicant identifying the reference product as well that has been considered. The reference product can be an avionics suite or an entire flight deck previously certified by the same applicant.

The degree of novelty should be proportionate to the number of positive answers to the above questions.

- (b) All the affected design items (refer to point 3.2.1) are expected to be scrutinised. If none of the criteria in point (a) above is met, the related design item is candidate for a low level of scrutiny.

The level of scrutiny performed by the applicant should be proportionate to the number of the above criteria which are met by each design item. Applicants should be aware that the impact of a complex design item might also be affected by its novelty and the extent of its integration with other elements of the cockpit. For example, a complex but not novel design item is likely to require a lower level of scrutiny than one that is both complex and novel. The applicant is expected to include in the certification plan all the items that have been analysed with the associated level of scrutiny.

- (c) The applicant may use a simpler approach for design items that have been assigned a low level of scrutiny.

3.2.4 Determining the level of scrutiny — EASA's familiarity with the project

The assessment of the classifications of the level of scrutiny proposed by the applicant requires the EASA flight and HFs panels to be familiar with the project, making use of the available material and tools.

3.2.5 Applicable HFs design requirements

- (a) The applicant should identify the HFs design requirements applicable to each design item for which compliance must be demonstrated. This may be accomplished by identifying the design characteristics of the design items that could adversely affect the performance of the crew members, or that pertain to the avoidance and management of crew member errors. Specific design considerations for the requirements that involve human performance are discussed in paragraph 4.
- (b) The expected output of this step is a compliance matrix that links the design items and the HFs design requirements that are deemed to be relevant and applicable so that a detailed assessment objective can be derived from each pair of a design item and a HFs design requirement. That objective will have then to be verified using the most appropriate means of compliance, or a combination of means of compliance. [GM2 29.1302](#) provides one possible example of this matrix.

3.2.6 Selecting the appropriate means of compliance

- (a) The applicant should review paragraph 5.2 for guidance on the selection of the means of compliance, or multiple means of compliance, appropriate to the design. In general, it is expected that the level of scrutiny should increase with higher levels of novelty, complexity or integration of the design. It is also expected that the amount of effort dedicated to the demonstration of compliance should increase with higher levels of scrutiny (e.g. by using multiple means of compliance and/or multiple HFs assessments on the same topic).
- (b) The output of this step will consist of the list of means of compliance that will be used to verify the HFs objectives.

3.2.7 Certification programme

The applicant should document the certification process, outputs and agreements described in the previous paragraphs. This may be done in a separate plan or incorporated into a higher-level certification programme.

3.2.8 Other deliverables

- (a) A HFs test programme should be produced for each assessment and should describe the experimental protocol (the number of scenarios, the number and profiles of the crew members,

practical organisation of the assessment, etc.), the HF objectives that are meant to be addressed, the expected crew member behaviour, and the scenarios expected to be run. When required by the Lol, the HF test programme should be provided well in advance to EASA.

- (b) A HF test report should be produced including at least the following information:
- (1) A summary of:
 - (i) the test vehicle configuration,
 - (ii) of test vehicle limitations/representativeness,
 - (iii) the detailed HF objectives, and
 - (iv) the HF test protocol, including the number of sessions and crew members, type of crews (test or operational pilots from the applicant, authority pilots, customer pilots), a description of the scenarios, the organisation of the session (training, briefing, assessment, debriefing), and the observers;
 - (2) A description of the data gathered with the link to the HF objectives;
 - (3) In-depth analyses of the observed HF findings;
 - (4) Conclusions regarding the related HF test objectives; and
 - (5) A description of the proposed way to mitigate the HF findings (by a design modification, improvements in procedures, and/or training actions).

If EASA has retained the review of the test report as part of its Lol, then the applicant should deliver it following every HF assessment.

3.2.9 Proportional approach in the compliance demonstration

In order to determine the certification programme, some alleviations (in terms of certification strategy and deliverables) may be granted by EASA for the compliance demonstration. For new types, the alleviation criteria are based on the rotorcraft category and types of operation while for changes on change classification, as described below:

- (a) New types
- (1) An applicant that seeks an approval for a CS-29 rotorcraft for IFR or CAT A operations should follow this AMC in its entirety.
 - (2) An applicant that seeks an approval for a CS-29 rotorcraft only for CAT B and VFR operations should follow the same criteria as those applicable to (a)(1) above. However, if the specific characteristics or the types of operations for which the rotorcraft is designed justify it, the applicant may propose to EASA the use of appropriate alleviations.
- (b) Significant and non-significant changes
- (1) An applicant for a significant change should follow the criteria established in (a)(1) or (a)(2) above, depending on the case.
 - (2) An applicant for a non-significant change (refer to classification in point 21.A.101 of Part 21 and the related GM):
 - (i) is not required to develop a dedicated HF test programme; and
 - (ii) is allowed to use a single occurrence of a test for compliance demonstration.

3.3 Certification strategy and methodologies

3.3.1 Certification strategy

- (a) The HFs assessment should follow an iterative process. Consequently, where appropriate, there may be several iterations of the same system-specific assessment allowing the applicant to reassess the system if the previous campaigns resulted in design modifications.
- (b) A HFs certification strategy based only on one assessment, aiming to demonstrate that the design assumptions are valid, is generally not sufficient (i.e. one final exercise proposed for compliance demonstration at the very end of the process).
- (c) In order to allow a sufficient amount of design and assessment iterations, it is suggested that the applicant initiate the certification process as early as possible starting from the early development phase. The certification process could include familiarisation sessions that would allow EASA to become familiar with the proposed design, but also participate in assessments that would possibly allow early credits to be granted. Potential issues may be identified early on by using this approach, thus reducing the risk of a late redesign of design items that may not be acceptable to EASA. Both parties may have an interest in authority early involvement, as the authority is continuously gaining experience and confidence in the HFs process and the compliance of the cockpit design. The representativeness of the systems and of the simulation means in the early stages of the development is not a key driver, and will not prevent EASA's involvement as long as the representativeness issues do not compromise the validity of the data to be collected.
- (d) If an applicant plans to use data provided by a supplier for compliance demonstration, the approach and the criteria for accepting that data will have to be shared and agreed with EASA as part of the HFs certification plan.

3.3.2 Methodological considerations applicable to HFs assessments

Various means of compliance may be selected, as described in paragraph 5.

For the highest level of scrutiny, the 'scenario-based' approach is likely to be the most appropriate methodology for some means of compliance.

The purpose of the following points is to provide guidelines on how to implement the scenario-based approach.

- (a) The scenario-based approach is intended to substantiate the compliance of human-machine interfaces (HMIs). It is based on a methodology that involves a sample of various crews that are representative of the future users, being exposed to real operational conditions in a test bench or a simulator, or in the rotorcraft. The scenarios are designed to show compliance with selected rules and to identify any potential deviations between the expected behaviour of the crew members and the activities of the crew members that are actually observed. The scenario designers can make use of triggering events or conditions (e.g. a system failure, an ATC request, weather conditions, etc.) in order to build operational situations that are likely to trigger observable crew member errors, difficulties or misunderstandings. The scenarios need to be well consolidated before the test campaign begins. A dry-run session should be performed by the applicant before any HFs campaign in order to validate the operational relevance of the scenarios. This approach should be used for both system- and rotorcraft level assessments.
- (b) System-level assessments focus on a specific design item and are intended for an in-depth assessment of the related functional and operational aspects, including all the operational procedures. The representativeness of the test article is to be evaluated taking into account the

scope of the assessment. Rotorcraft-level assessments consider the scope of the full cockpit, and focus on integration and interdependence issues.

- (c) The scenarios are expected to cover a subset of the detailed HFs test objectives. The link between each scenario and the test objectives should be substantiated. This rationale should be described in the certification test plan or in any other relevant document.
- (d) The criteria used to select the crew members involved in the HFs assessments with certification credit should be adequate to the scope of the tests to be conducted and the selection process of the crew members should be recorded. The applicant should ensure that the test participants are representative of the end users.
- (e) Due to interindividual variability, HFs scenario-based assessments performed with a single crew member are not acceptable. The usually accepted number of different crew members used for a given campaign varies from three to five, including the authority crew, if applicable. In the case of a crew of two with HFs objectives focused on the duties of only one of the crew members, it is fully acceptable for the applicant to use the same pilot flying or monitoring (the one who is not expected to produce any HFs data) throughout the campaign.
- (f) In addition to the test report, and in order to reduce the certification risk, it is recommended that the preliminary analyses resulting from recorded observations and comments should be presented by the applicant to EASA soon after the simulator/flight sessions in order to allow expert discussions to take place.
- (g) An initial briefing should be given to the crew members at the beginning of each session to present the following general information:
 - (1) A detailed schedule describing the type and duration of the activities (the duration of the session, the organisation of briefing and debriefings, breaks, etc.);
 - (2) What is expected from the crew members: it has to be clearly mentioned that the purpose of the assessment is to assess the design of the cockpit, not the performance of the pilot;
 - (3) The policy for simulator occupancy: how many people should be in the simulator versus the number of people in the control room, and who they should be; and
 - (4) The roles of the crew members: if crew members from the applicant participate in the assessment, they should be made aware that their role differs significantly from their typical expert pilot role in the development process. For the process to be valid without significant bias, they are expected to react and behave in the cockpit as standard operational pilots.
 - (5) However, the crew members that participate in the assessment should not be:
 - (i) briefed in advance about the details of the failures and events to be simulated; this is to avoid an obvious risk of experimental bias; nor
 - (ii) asked before the assessment for their opinion about the scenarios to be flown.
- (h) The crew members need to be properly trained prior to every assessment so that during the analysis, the 'lack of training' factor can be excluded to the maximum extent possible from the set of potential causes of any observed design-related human performance issue. Furthermore, for operational representativeness purposes, realistic crew member task sharing, from normal to emergency workflows and checklists, should be respected during HFs assessments. The applicant should make available any draft or final RFM, procedures and checklists sufficiently in advance for the crew members to prepare.

-
- (i) When using simulation, the immersion feeling of the crew should be maximised in order to increase the validity of the data. This generally leads to recommendations about a sterile environment (with no outside noise or visual perturbation), no intervention by observers, no interruptions in the scenarios unless required by the nature of the objectives, realistic simulation of ATC communications, pilots wearing headsets, etc.
- (j) The method used to collect HF data needs to take into account the following principles:
- (1) Principles applicable to the collection of HF-related data
 - (i) In order to substantiate compliance with [CS 29.1302](#), it is necessary to collect both objective and related subjective data.
 - (A) **Objective data** on crew member performance and behaviour should be collected through direct observation. The observables should not be limited to human errors, but should also include pilot verbalisations in addition to behavioural indicators such as hesitation, suboptimal or unexpected strategies, catachresis, etc.
 - (B) **Subjective data** should be collected during the debriefing by the observer through an interactive dialogue with the observed crew members. The debriefing should be led using a neutral and critical positioning from the observer.

This subjective data is typically data that cannot be directly observed (e.g. pilot intention, pilot reasoning, etc.) and facilitate better understanding of the observed objective data from (i).
 - (ii) Other tools such as questionnaires and rating scales could be used as complementary means. However, it is never sufficient to rely solely on self-administered questionnaires due to the fact that crew members are not necessarily aware of all their errors, or of deviations with respect to the intended use.
 - (2) The HF assessment should be systematically video recorded (both ambient camera and displays). Records may be used by the applicant as a complementary observation means, and by the authority for verification purposes, when required.
 - (3) It is very important to conduct debriefings after the HF assessments. They allow the applicant's HF observers to gather all the necessary data that has to be used in the subsequent HF analyses.
 - (4) HF observers should respect the best practices with regard to observation and debriefing techniques.
 - (5) Debriefings should be based on non-directive or semidirective interviewing techniques and should avoid the experimental biases that are well described in the literature in the field of social sciences (e.g. the expected answer contained in the question, non-neutral attitude of the interviewer, etc.).
- (k) If HF-related concerns are raised that are not directly related to the objective of the assessment, they should nevertheless be recorded, adequately investigated and analysed in the test report.

-
- (l) Every design-related human performance issue observed or reported by the crew members should be analysed following the assessment. In the case of a human error, the analysis should provide information about at least the following:
- (1) The type of error;
 - (2) The observed operational consequences, and any reductions in the safety margins;
 - (3) The description of the operational context at the time of observation;
 - (4) Was the error detected? By whom, when and how?
 - (5) Was the error recovered? By whom, when and how?
 - (6) Existing means of mitigation;
 - (7) Possible effects of the representativeness of the test means on the validity of the data; and
 - (8) The possible causes of the error.
- (m) The analysis of design-related human performance issues has to be concluded by detailing the appropriate way forward, which is one of the following:
- (1) No action required;
 - (2) An operational recommendation (for a procedural improvement or a training action);
 - (3) A recommendation for a design improvement; or
 - (4) A combination of items (2) and (3).
- (n) Workload assessment is considered and addressed in different ways through several requirements within CS-29.
- (1) The intent of [CS 29.1523](#) is to evaluate the workload with the objective of demonstrating compliance with the minimum flight crew requirements.
 - (2) The intent of [CS 29.1302](#) is to identify design-related human performance issues.
 - (3) As per CS 29.1302, the acceptability of workload levels is one parameter among many to be investigated in order to highlight potential usability problems. The CS 29.1302 evaluations should not be limited to the workload alone. Workload ratings should be complementary to other data from observations of crew member behaviour or other types.
 - (4) The techniques used to collect data in the context of the CS 29.1302 evaluations could make use of workload rating scales, but in that case no direct conclusion should be made from the results about the compliance with CS 29.1302.

4) DESIGN CONSIDERATIONS AND GUIDANCE

4.1 Overview

- (a) This material provides the standard which should be applied in order to design a cockpit that is in line with the objectives of CS 29.1302. Not all the criteria can or should be met by all systems. Applicants should use their judgment and experience in determining which design standard should apply to each part of the design in each situation.
- (b) The following provide a cross reference between this paragraph and the requirements listed in [CS 29.1302](#):
- (1) ‘Controls’ mainly relates to [1302\(a\) and \(b\)](#);

- (2) 'Presentation of information' mainly relates to [1302\(a\) and \(b\)](#);
- (3) 'System behaviour' mainly relates to [1302\(c\)](#); and
- (4) 'Error management' mainly relates to [1302\(d\)](#).

Additionally, specific considerations on integration are given in paragraph 4.6.

4.2 Controls

- (a) Applicants should show that in the proposed design, as defined in [CS 29.777](#), [CS 29.779](#), [CS 29.1543](#) and [CS 29.1555](#), the controls comply with [CS 1302\(a\) and \(b\)](#).
- (b) Each function, method of operating a control, and result of actuating a control should comply with the requirements. Each control must be shown to be:
 - (1) clear,
 - (2) unambiguous,
 - (3) appropriate in resolution and precision,
 - (4) accessible, and
 - (5) usable.
 - (6) It must also enable crew member awareness, including the provision of adequate feedback.
- (c) For each of these design requirements, consideration should be given to the following control characteristics for each control individually and in relation to other controls:
 - (1) The physical location of the control;
 - (2) The physical characteristics of the control (e.g. its shape, dimensions, surface texture, range of motion, and colour);
 - (3) The equipment or system(s) that the control directly affects;
 - (4) How the control is labelled;
 - (5) The available settings of the control;
 - (6) The effect of each possible actuation or setting, as a function of the initial control setting or other conditions;
 - (7) Whether there are other controls that can produce the same effect (or can affect the same target parameter), and the conditions under which this will happen; and
 - (8) The location and nature of the feedback that shows the control was actuated.

The following provides additional guidance for the design of controls that comply with [CS 29.1302](#).

- (d) The clear and unambiguous presentation of control-related information
 - (1) Distinguishable and predictable controls ([CS 29.1301\(a\)](#), [CS 29.1302](#))
 - (i) Each crew member should be able to identify and select the current function of the control with the speed and accuracy appropriate to the task. The function of a control should be readily apparent so that little or no familiarisation is required.
 - (ii) The applicant should evaluate the consequences of actuating each control and show they are predictable and obvious to each crew member. This includes the

control of multiple displays with a single device, and shared display areas that crew members may access with individual controls. The use of a single control should also be assessed.

- (iii) Controls should be made distinguishable and/or predictable by differences in form, colour, location, motion, effect and/or labelling. For example, the use of colour alone as an identifying feature is usually not sufficient.

(2) Labelling ([CS 29.1301\(b\)](#), [CS 29.1302\(a\)](#) and (b), [CS 29.1543\(b\)](#), [CS 29.1555\(a\)](#))

- (i) For the general marking of controls, see CS 29.1555(a).

Labels should be readable from the crew member's normal seating positions, including the marking used by the crew member from their operating positions in the cabin (if applicable) in all lighting and environmental conditions.

Labelling should include all the intended functions unless the function of the control is obvious. Labels of graphical controls accessed by a cursor-control device, such as a trackball, should be included on the graphical display. If menus lead to additional choices (submenus), the menu label should provide a reasonable description of the next submenu.

- (ii) The applicant can label the controls with text or icons. The text and the icons should be shown to be distinct and meaningful for the function that they label. The applicant should use standard or unambiguous abbreviations, nomenclature, or icons, consistent within a function and across the cockpit. ICAO Doc 8400 'Procedures for Air Navigation Services (PANS) — ICAO Abbreviations and Codes' provides standard abbreviations, and is an acceptable basis for selecting labels.

- (iii) If an icon is used instead of a text label, the applicant should show that the crew members require only a brief exposure to the icon to determine the function of the control and how it operates. Based on design experience, the following guidelines for icons have been shown to lead to usable designs:

- (A) The icon should be analogous to the object it represents;
- (B) The icon should be generally used in aviation and well known to crews, or has been validated during a HFs assessment; and
- (C) The icon should be based on established standards, if they exist, and on conventional meanings.

(3) Interactions of multiple controls ([CS 29.1302\(b\)\(3\)](#))

If multiple controls for one function are provided to the crew members, the applicant should show that there is sufficient information to make the crew members aware of which control is currently functioning. As an example, crew members need to know which crew member's input has priority when two cursor-control devices can access the same display. Designers should use caution for dual controls that can affect the same parameter simultaneously.

(e) The accessibility of controls ([CS 29.777\(a\)](#), [CS 29.777\(b\)](#), [CS 29.1302](#))

- (1) Any control required for crew member operation (in normal, abnormal/malfunction and emergency conditions) should be shown to be visible, reachable, and operable by the crew members with the stature specified in [CS 29.777\(b\)](#), from the seated position with shoulder restraints on. If the shoulder restraints are lockable, the applicant should show

that the pilots can reach and actuate high-priority controls needed for the safe operation of the aircraft with the shoulder harnesses locked.

- (2) Layering of information, as with menus or multiple displays, should not hinder the crew members from identifying the location of the desired control. Evaluating the location and accessibility of a control requires the consideration of more than just the physical aspects of the control. Other location and accessibility considerations include where the control functions may be located within various menu layers, and how the crew member navigates those layers to access the functions. Accessibility should be shown in conditions of system failures and of a master minimum equipment list (MMEL) dispatch.
 - (3) The position and direction of motion of a control should be oriented according to [CS 29.777](#).
- (f) The use of controls
- (1) Environmental factors affecting the controls ([CS 29.1301\(a\)](#) and [CS 29.1302](#))
 - (i) If the use of gloves is anticipated, the cockpit design should allow their use with adequate precision as per CS 29.1302(b)(2) and (c)(2).
 - (ii) The sensitivity of the controls should provide sufficient precision (without being overly sensitive) to perform tasks even in adverse environments as defined for the rotorcraft's operational envelope per CS 29.1302(c)(2) and (d). The analysis of the environmental factors as a means of compliance is necessary, but not sufficient, for new control types or technologies, or for novel use of the controls that are themselves not new or novel.
 - (iii) The applicant should show that the controls required to regain control of the rotorcraft or system and the controls required to continue operating the rotorcraft in a safe manner are usable in conditions with extreme lighting conditions and severe vibration levels and should not prevent the crew members from performing all their tasks with an acceptable level of performance and workload.
 - (2) Control display compatibility ([CS 29.777](#) and [CS 29.779](#))

CS 29.779 describes the direction of movement of the cockpit controls.

 - (i) To ensure that a control is unambiguous per CS 29.1302(b)(1), the relationship and interaction between a control and its associated display or indications should be readily apparent, understandable, and logical. For example, the applicant should specifically assess any rotary knob that has no obvious 'increase' or 'decrease' function with regard to the crew members' expectations and its consistency with the other controls in the cockpit. The Society of Automotive Engineers' (SAE) publication ARP4102, Chapter 5, is an acceptable means of compliance for controls used in cockpit equipment.
 - (ii) CS 29.777(a) requires each cockpit control to be located so that it provides convenient operation and prevents confusion and inadvertent operation. The controls associated with a display should be located so that they do not interfere with the performance of the crew members' tasks. Controls whose function is specific to a particular display surface should be mounted near to the display or the function being controlled. Locating controls immediately below a display is generally preferable, as mounting controls immediately above a display has, in many cases, caused the crew member's hand to obscure their view of the display

when operating the controls. However, controls on the bezel of multifunction displays have been found to be acceptable.

- (iii) Spatial separation between a control and its display may be necessary. This is the case with a control of a system that is located with other controls for that same system, or when it is one of several controls on a panel dedicated to controls for that multifunction display. When there is a large spatial separation between a control and its associated display, the applicant should show that the use of the control for the associated task(s) is acceptable in accordance with [29.777\(a\)](#) and [29.1302](#).
 - (iv) In general, the design and placement of controls should avoid the possibility that the visibility of information could be blocked. If the range of movement of a control temporarily blocks the crew members' view of information, the applicant should show that this information is either not necessary at that time or is available in another accessible location (CS 29.1302(b)(2) requires the information intended for use by the crew members to be accessible and useable by the crew members in a manner appropriate to the urgency, frequency, and duration of the crew members' tasks).
 - (v) Annunciations/labels on electronic displays should be identical to the labels on the related switches and buttons located elsewhere on the cockpit. If display labels are not identical to those on the related controls, the applicant should show that crew members can quickly, easily, and accurately identify the associated controls so they can safely perform all the tasks associated with the intended function of the systems and equipment (29.1302).
- (3) Control display design
- (i) Controls of a variable nature that use a rotary motion should move clockwise from the OFF position, through an increasing range, to the full ON position.
- (g) Adequacy of feedback (CS 29.771(a), [CS 29.1301\(a\)](#), CS 29.1302)
- (1) Feedback for the operation of the controls is necessary to give the crew members awareness of the effects of their actions. The meaning of the feedback should be clear and unambiguous. For example, if the intent of the feedback is to indicate a commanded event versus system state. Additionally, provide feedback when a crew member's input is not accepted or not followed by the system (29.1302(b)(1)). This feedback can be visual, auditory, or tactile.
 - (2) To meet the objectives of CS 29.1302, the applicant should show that feedback in all forms is obvious and unambiguous to the crew members when performing their tasks associated with the intended function of the equipment. Feedback, in an appropriate form, should be provided to inform the crew members that:
 - (i) a control has been activated (commanded state/value);
 - (ii) the function is in process (given an extended processing time);
 - (iii) the action associated with the control has been initiated (actual state/value if different from the commanded state); or
 - (iv) when a control is used to move an actuator through its range of travel, the equipment should provide, if needed (for example, fly-by-wire system), within the time required for the relevant task, operationally significant feedback of the actuator's position within its range. Examples of information that could appear

relative to an actuator's range of travel include the target speed, and the state of the valves of various systems.

- (3) The type, duration and appropriateness of the feedback will depend upon the crew member's task and the specific information required for successful operation. As an example, the switch position alone is insufficient feedback if awareness of the actual system response or the state of the system as a result of an action is required in accordance with CS 29.1302(b)(3).
- (4) Controls that may be used while the user is looking outside or at unrelated displays should provide tactile feedback. Keypads should provide tactile feedback for any key depression. In cases when this is omitted, it should be replaced with appropriate visual or other feedback indicating that the system has received the inputs and is responding as expected.
- (5) The equipment should provide appropriate visual feedback, not only for knob, switch, and push-button positions, but also for graphical control methods such as pull-down menus and pop-up windows. The user interacting with a graphical control should receive a positive indication that a hierarchical menu item has been selected, a graphical button has been activated, or another input has been accepted.

4.3 The presentation of information

(a) Introduction

- (1) The presentation of information to the crew members can be visual (for instance, on a display), auditory (a 'talking' checklist), or tactile (for example, control feel). The presentation of information in the integrated cockpit, regardless of the medium used, should meet all of the requirements bulleted above. For visual displays, this AMC addresses mainly display format issues and not display hardware characteristics. The following provides design considerations for the requirements found in [CS 29.1301\(a\)](#), CS 29.1301(b), [CS 29.1302](#), and [CS 29.1543\(b\)](#).
- (2) Applicants should show that, in the proposed design, as defined in CS 29.1301, [29.771\(a\)](#) and [29.771\(b\)](#), the presented information is:
 - clear,
 - unambiguous,
 - appropriate in resolution and precision,
 - accessible,
 - usable, and
 - able to provide adequate feedback for crew member awareness.

(b) The clear and unambiguous presentation of information

Qualitative and quantitative display formats (CS 29.1301(a) and CS 29.1302)

- (1) Applicants should show, as per CS 29.1302(b), that display formats include the type of information the crew member needs for the task, specifically with regard to the required speed and precision of reading. For example, the information could be in the form of a text message, numerical value, or a graphical representation of state or rate information. State information identifies the specific value of a parameter at a particular time. Rate information indicates the rate of change of that parameter.

-
- (2) If the crew member's sole means of detecting abnormal values is by monitoring the values presented on the display, the equipment should offer qualitative display formats. Analogue displays of data are best for conveying rate and trend information. If this is not practical, the applicant should show that the crew members can perform the tasks for which the information is used. Digital presentations of information are better for tasks requiring precise values. Refer to [CS 29.1322](#) when an abnormal value is associated with a crew alert.
- (c) Display readability ([CS 29.1301\(b\)](#) and [CS 29.1543\(b\)](#))
- Crew members, seated at their stations and using normal head movement, should be able to see and read display format features such as fonts, symbols, icons and markings. In some cases, cross-cockpit readability may be required to meet the intended function that both pilots must be able to access and read the display. Examples of situations where this might be needed are cases of display failures or when cross-checking flight instruments. Readability must be maintained in sunlight viewing conditions (as per [CS 29.773\(a\)](#)) and under other adverse conditions such as vibration. Figures and letters should subtend not less than the visual angles defined in SAE ARP4102-7 at the design eye position of the crew member that normally uses the information.
- (d) Colour ([CS 29.1302](#))
- (1) The use of many different colours to convey meaning on displays should be avoided. However, if thoughtfully used, colour can be very effective in minimising the workload and response time associated with display interpretation. Colour can be used to group functions or data types in a logical way. A common colour philosophy across the cockpit is desirable.
 - (2) Applicants should show that the chosen colour set is not susceptible to confusion or misinterpretation due to differences in colour coordinates between the displays.
 - (3) Improper colour-coding increases the response times for display item recognition and selection, and increases the likelihood of errors, which is particularly true in situations where the speed of performing a task is more important than the accuracy, so the compatibility of colours with the background should be verified in all the foreseeable lighting conditions. The use of the red and amber colours for other than alerting functions or potentially unsafe conditions is discouraged. Such use diminishes the attention-getting characteristics of true warnings and cautions.
 - (4) The use of colour as the sole means of characterising an item of information is also discouraged. It may be acceptable, however, to indicate the criticality of the information in relation to the task. Colour, as a graphical attribute of an essential item of information, should be used in addition to other coding characteristics such as texture or differences in luminance. FAA AC 29-2C Change 7, MG-19, contains recommended colour sets for specific display features.
 - (5) Applicants should show that the layering of information on a display does not add to confusion or clutter as a result of the colour standards and symbols used. Designs that require crew members to manually declutter such displays should also be avoided.
- (e) Symbology, text, and auditory messages (CS 29.1302)
- (1) Designs can base many elements of electronic display formats on established standards and conventional meanings. For example, ICAO Doc 8400 'Procedures for Air Navigation Services (PANS) — ICAO Abbreviations and Codes' provides abbreviations, and is one standard that could be applied to the textual material used in the cockpit.

- SAE ARP4102 7, Appendices A to C, and SAE ARP5289A are acceptable standards for avionics display symbols.
- (2) The position of a message or symbol within a display also conveys meaning to the crew members. Without the consistent or repeatable location of a symbol in a specific area of the electronic display, interpretation errors and response times may increase.
 - (3) Applicants should give careful attention to symbol priority (the priority of displaying one symbol overlaying another symbol by editing out the secondary symbol) to ensure that higher-priority symbols remain viewable.
 - (4) New symbols (a new design or a new symbol for a function which historically had an associated symbol) should be assessed for their distinguishability and for crew understanding and retention.
 - (5) Applicants should show that displayed text and auditory messages are distinct and meaningful for the information presented. CS 29.1302 requires the information intended for use by the crew members to be provided in a clear and unambiguous format in a resolution and precision appropriate to the task, and the information to convey the intended meaning. The equipment should display standard and/or unambiguous abbreviations and nomenclature, consistent within a function and across the cockpit.
- (f) The accessibility and usability of information
- (1) The accessibility of information ([CS 29.1302](#))
 - (i) Information intended for the crew members must be accessible and useable by the crew members in a manner appropriate to the urgency, frequency, and duration of their tasks, as per CS 29.1302(b)(2). The crew members may, at certain times, need some information immediately, while other information may not be necessary during all phases of flight. The applicant should show that the crew members can access and manage (configure) all the necessary information on the dedicated and multifunction displays for the given phase of flight. The applicant should show that any information required for continued safe flight and landing is accessible in the relevant degraded display modes following failures as defined by [CS 29.1309](#). The applicant should specifically assess what information is necessary in those conditions, and how such information will be simultaneously displayed. The applicant should also show that supplemental information does not displace or otherwise interfere with the required information.
 - (ii) Analysis as the sole means of compliance is not sufficient for new or novel display management schemes. The applicant should use simulation of typical operational scenarios to validate the crew member's ability to manage the available information.
 - (2) Clutter (CS 29.1302)
 - (i) Visual or auditory clutter is undesirable. To reduce the crew member's interpretation time, the equipment should present information simply and in a well ordered way. Applicants should show that an information delivery method (whether visual or auditory) presents the information that the crew member actually requires to perform the task at hand. Crew members can use their own discretion to limit the amount of information that needs to be presented at any point in time. For instance, a design might allow the crew members to program a system so that it displays the most important information all the time, and less

important information on request. When a design allows the crew members to select additional information, the basic display modes should remain uncluttered.

- (ii) Display options that automatically hide information for the purpose of reducing visual clutter may hide needed information from the crew member. If the equipment uses automatic deselection of data to enhance the crew member's performance in certain emergency conditions, the applicant must show, as per CS 29.1302(a), that it provides the information the crew member needs. The use of part-time displays depends not only on the removal of clutter from the information, but also on the availability and criticality of the display. Therefore, when designing such design items, the applicant should follow the guidance in CS-29 Book 2 (e.g. FAA AC 29, MG-19).
- (iii) Because of the transient nature of the auditory information presentation, designers should be careful to avoid the potential for competing auditory presentations that may conflict with each other and hinder their interpretation. Prioritisation and timing may be useful to avoid this potential problem.
- (iv) Information should be prioritised according to the criticality of the task. Lower-priority information should not mask higher-priority information, and higher-priority information should be available, readily detectable, easily distinguishable and usable.

(3) System response time.

Long or variable response times between a control input and the system response can adversely affect the usability of the system. The applicant should show that the response to a control input, such as setting values, displaying parameters, or moving a cursor symbol on a graphical display, is fast enough to allow the crew members to complete the task at an acceptable level of performance. For actions that require a noticeable system processing time, the equipment should indicate that the system response is pending.

4.4 System behaviour

(a) Introduction

The demands of the crew members' tasks vary depending on the characteristics of the system design. Systems differ in their responses to relevant crew member inputs. The response can be direct and unique, as in mechanical systems, or it can vary as a function of an intervening subsystem (such as hydraulics or electrics). Some systems even automatically vary their responses to capture or maintain a desired rotorcraft or system state.

- (1) [CS 29.1302\(c\)](#) states that the installed equipment must be designed so that the behaviour of the equipment that is operationally relevant to the crew members' tasks is: (1) predictable and unambiguous, and (2) designed to enable the crew members to intervene in a manner appropriate to the task (and intended function).
- (2) The requirement for operationally relevant system behaviour to be predictable and unambiguous will enable the crew members to know what the system is doing and what they did to enable/disable the behaviour. This distinguishes the system behaviour from the functional logic within the system design, much of which the crew members do not know or do not need to know.
- (3) If crew member intervention is part of the intended function, or part of the abnormal/malfunction or emergency procedures for the system, the crew member may need to take some action, or change an input to the system. The system must be designed

accordingly. The requirement for crew member intervention capabilities recognises this reality.

- (4) Improved technologies, which have increased safety and performance, have also introduced the need to ensure proper cooperation between the crew members and the integrated, complex information and control systems. If the system behaviour is not understood or expected by the crew members, confusion may result.
- (5) Some automated systems involve tasks that require crew members' attention for effective and safe performance. Examples include flight management systems (FMSs) or flight guidance systems. Alternatively, systems designed to operate autonomously, in the sense that they require very limited or no human interaction, are referred to as 'automatic systems'. Such systems are switched 'ON' or 'OFF' or run automatically, and, when operating in normal conditions, the guidance material of this paragraph is not applicable to them. Examples include full authority digital engine controls (FADECs). Detailed specific guidance for automatic systems can be found in the relevant parts of CS-29.

- (b) The allocation of functions between crew members and automation.

The applicant should show that the allocation of functions is conducted in such a way that:

- (1) the crew members are able to perform all the tasks allocated to them, considering normal, abnormal/malfunction and emergency operating conditions, within the bounds of an acceptable workload and without requiring undue concentration or causing undue fatigue (see [CS 29.1523](#) and [29.771\(a\)](#) for workload assessment); and
- (2) the system enables the crew members to understand the situation, and enables timely failure detection and crew member intervention when appropriate.

- (c) The functional behaviour of a system

- (1) The functional behaviour of an automated system results from the interaction between the crew members and the automated system, and is determined by:
 - (i) the functions of the system and the logic that governs its operation; and
 - (ii) the user interface, which consists of the controls that communicate the crew members' inputs to the system, and the information that provides feedback to the crew members on the behaviour of the system.
- (2) The design should consider both the functions of the system and the user interface together. This will avoid a design in which the functional logic governing the behaviour of the system can have an unacceptable effect on the performance of the crew members. Examples of system functional logic and behavioural issues that may be associated with errors and other difficulties for the crew members are the following:
 - (i) The complexity of the crew members' interface for both control actuation and data entry, and the complexity of the corresponding system indications provided to the crew members;
 - (ii) The crew members having inadequate understanding and incorrect expectations of the behaviour of the system following mode selections and transitions; and
 - (iii) The crew members having inadequate understanding and incorrect expectations of what the system is preparing to do next, and how it is behaving.

(3) Predictable and unambiguous system behaviour ([CS 29.1302\(c\)\(1\)](#))

Applicants should detail how they will show that the behaviour of the system or the system mode in the proposed design is predictable and unambiguous to the crew members.

- (i) System or system mode behaviour that is ambiguous or unpredictable to the crew members has been found to cause or contribute to crew errors. It can also potentially degrade the crew's ability to perform their tasks in normal, abnormal/malfunction and emergency conditions. Certain design characteristics have been found to minimise crew errors and other crew performance problems.
- (ii) The following design considerations are applicable to operationally relevant systems and to the modes of operation of the systems:
 - (A) The system behaviour should be simple (for example, the number of modes, or mode transitions).
 - (B) Mode annunciation should be clear and unambiguous. For example, a mode engagement or arming selection by the crew members should result in annunciation, indication or display feedback that is adequate to provide awareness of the effect of their action. Additionally, any change in the mode as a result of the rotorcraft changing from one operational mode (for instance, on an approach) to another should be clearly and unambiguously annunciated and fed back to the crew members.
 - (C) Methods of mode arming, engagement and deselection should be accessible and usable. For example, the control action necessary to arm, engage, disarm or disengage a mode should not depend on the mode that is currently armed or engaged, on the setting of one or more other controls, or on the state or status of that or another system.
 - (D) Uncommanded mode changes and reversions should have sufficient annunciation, indication, or display information to provide awareness of any uncommanded changes of the engaged or armed mode of a system.

'Uncommanded' could refer both to a mode change not commanded by the pilot but by the automation as part of its normal operation, or to a mode change resulting from a malfunction.
 - (E) The current mode should remain identified and displayed at all times.

(4) Crew member intervention ([CS 29.1302\(c\)\(2\)](#))

- (i) Applicants should propose the means that they will use to show that the behaviour of the systems in the proposed design allows the crew members to intervene in the operation of the systems without compromising safety. This should include descriptions of how they will determine that the functions and conditions in which intervention should be possible have been addressed.
- (ii) The methods proposed by the applicants should describe how they would determine that each means of intervention is appropriate to the task.

(5) Controls for automated systems

Automated systems can perform various tasks selected by and under the supervision of the crew members. Controls should be provided for managing the functionality of such a system or set of systems. The design of such ‘automation-specific’ controls should enable the crew members to:

- (i) safely prepare the system for the immediate task to be executed or the subsequent task to be executed; preparation of a new task (for example, a new flight trajectory) should not interfere, or be confused, with the task being executed by the automated system;
- (ii) activate the appropriate system function and clearly understand what is being controlled; for example, the crew members must clearly understand that they can set either the vertical speed or the flight path angle when they operate a vertical speed indicator;
- (iii) manually intervene in any system function, as required by the operational conditions, or revert to manual control; for example, manual intervention might be necessary if a system loses functions, operates abnormally, or fails.

(6) Displays for automated systems

Automated systems can perform various tasks with minimal crew member intervention, but under the supervision of the crew members. To ensure effective supervision and maintain crew member awareness of the system state and system ‘intention’ (future states), displays should provide recognisable feedback on:

- (i) the entries made by the crew members into the system so that the crew members can detect and correct errors;
- (ii) the present state of the automated system or its mode of operation (What is it doing?);
- (iii) the actions taken by the system to achieve or maintain a desired state (What is it trying to do?);
- (iv) future states scheduled by the automation (What is it going to do next?); and
- (v) transitions between system states.

(7) The applicant should consider the following aspects of automated system designs:

- (i) Indications of the commanded and actual values should enable the crew members to determine whether the automated systems will perform according to the crew members’ expectations;
- (ii) If the automated system nears its operational authority or is operating abnormally for the given conditions, or is unable to perform at the selected level, it should inform the crew members, as appropriate for the task;
- (iii) The automated system should support crew coordination and cooperation by ensuring that there is shared awareness of the system status and the crew members’ inputs to the system; and
- (iv) The automated system should enable the crew to review and confirm the accuracy of the commands before they are activated. This is particularly important for automated systems because they can require complex input tasks.

4.5 Crew member error management

(a) Meeting the objective of [CS 29.1302\(d\)](#)

- (1) CS 29.1302(d) addresses the fact that crews will make errors, even when they are well trained, experienced, rested, and use well-designed systems.

CS 29.1302(d) addresses errors that are design related only. It is not intended to require consideration of errors resulting from acts of violence, sabotage or threats of violence.

- (2) To meet the objective of CS 29.1302(d), the applicant should consider the following:
- (i) enable the crew members to detect (see 4.5(b)) and recover from errors (see 4.5(c));
 - (ii) ensure that the effects of crew errors on the rotorcraft functions or capabilities are evident to the crew members, and continued safe flight and landing is possible (see 4.5(d));
 - (iii) prevent crew errors by using switch guards, interlocks, confirmation actions, or similar means;
 - (iv) preclude the effects of errors through system logic and/or redundant, robust, or fault tolerant system designs (see 4.5(e)).
- (3) The strategies described in (2) above:
- (i) recognise and assume that crew member errors cannot be entirely prevented, and that no validated methods exist to reliably predict either their probability or all the sequences of events with which they may be associated;
 - (ii) call for means of compliance that are methodical and complementary to, and separate and distinct from, rotorcraft system analysis methods such as system safety assessments.
- (4) When demonstrating compliance, the applicant should consider the crew members' tasks in all operating conditions, considering that many of the same design characteristics are relevant in each case. For example, under abnormal/malfunction or emergency conditions, the flying tasks (navigation, communication and monitoring) are generally still present, although they may be more difficult. So, the tasks associated with the abnormal/malfunction or emergency conditions should be considered as additive. The applicant should not expect the errors considered to be different from those in normal conditions, but any assessment should account for the change in the expected tasks.
- (5) To demonstrate compliance with [CS 29.1302\(d\)](#), the applicant may employ any of the general types of methods of compliance discussed in paragraph 5, individually or in combination. These methods must be consistent with an approved certification plan as discussed in paragraph 3, and account for the objectives above and the considerations described below. When using some of these methods, it may be helpful for some applicants to refer to other references related to understanding the occurrence of errors. Here is a brief summary of those methods and how they can be applied to address crew member error considerations:
- (i) Statement of similarity (paragraph 5.3): A statement of similarity may be used to substantiate that the design has sufficient certification precedent to conclude that the ability of the crew members to manage errors has not significantly changed. Applicants may also use in-service data to identify errors known to commonly occur for similar crew member interfaces or system behaviour. As part of

compliance demonstration, the applicant should identify the steps taken in the new design to avoid or mitigate similar errors. However, the absence of in-service events related to a particular design item cannot be considered to be an acceptable means of demonstrating compliance with CS 29.1302.

- (ii) Design descriptions (paragraph 5.3): Applicants may structure design descriptions and rationales to show how various types of errors are considered in the design and addressed, mitigated or managed. Applicants can also use a description of how the design adheres to an established and valid design philosophy to substantiate that the design enables crews to manage errors.
 - (iii) Calculation and engineering analysis (paragraph 5.3): As one possible means of demonstrating compliance with CS 29.1302(d), an applicant may document the means of error management through the analysis of controls, indications, system behaviour, and related crew member tasks. This would need to be done in conjunction with an understanding of the potential error opportunities and the means available for the crew members to manage those errors. In most cases, it is not considered feasible to predict the probability of crew member errors with sufficient validity or precision to support a means of compliance. If an applicant chooses to use a quantitative approach, the validity of the approach should be established.
 - (iv) Assessments (paragraph 5.3): For compliance purposes, assessments are intended to identify error possibilities that may be considered for mitigation in design or training. In any case, scenario objectives and assumptions should be clearly stated before running the evaluations or tests. In that way, any discrepancy in those expectations can be discussed and explained in the analysis of the results.
- (6) As discussed further in paragraph 5, these evaluations or tests should use appropriate scenarios that reflect the intended functions and tasks, including the use of the equipment in normal, abnormal/malfunction and emergency conditions. Scenarios should be designed to consider crew member errors. If inappropriate scenarios are used or important conditions are not considered, incorrect conclusions can result. For example, if no errors occur during an assessment, it may only mean that the scenarios are too simple, incomplete, or not fully representative. On the other hand, if some errors do occur, it may mean any of the following:
- (i) The design, procedures, or training should be modified;
 - (ii) The scenarios are unrealistically challenging; or
 - (iii) Insufficient training was delivered prior to the assessment.
- (7) In such assessments, it is not considered feasible to establish criteria for the frequency of errors.
- (b) Error detection
- (1) Applicants should design equipment to provide information to the crew members so that they can become aware of an error. Applicants should show that this information is available to the crew members, is adequately detectable, and it shows a clear relationship between the crew member action and the error so a recovery can be made in a timely manner.

- (2) The information for error detection may take three basic forms:
- (i) Indications provided to the crew members during normal monitoring tasks.
 - (A) As an example, if an incorrect knob was used, resulting in an unintended heading change, the change would be detected through the display of target values. The presentation of a temporary flight plan for crew review before accepting it would be another way of providing crew awareness of errors.
 - (B) Indications on instruments in the primary field of view that are used during normal operations may be adequate if the indications themselves contain information used on a regular basis and are provided in a readily accessible form. These may include mode annunciations and normal rotorcraft state information such as the altitude or heading. Other locations for the information may be appropriate depending on the crew's tasks and the importance of the information, such as on the control display unit when the task involves dealing with a flight plan. Paragraph 5.4 'Presentation of information' contains additional guidance to determine whether the information is adequately detectable.
 - (ii) Indications to the crew members that provide information of an error or a resulting rotorcraft system condition.
 - (A) An alert that activates following a crew member error may be sufficient to show an error is detectable and provides sufficient information. The alert should directly relate to the error or be easily assessed by the crew members as related to the error. Alerts should not be confusing leading the crew members to believe there may be non-error causes for the annunciated condition.
 - (B) If a crew member error is only one of several possible causes for an alert about a system, then the information that the alert provides is insufficient. If, on the other hand, additional information is available that would allow the crew to identify and correct the error, then the alert, in combination with the additional information, would be sufficient to comply with [CS 29.1302\(d\)](#) for that error.
 - (C) An error that is detectable by the system should provide an alert and provide sufficient information that a crew member error has occurred, such as in the case of a take off configuration warning. On the other hand, an alert about the system state resulting from accidentally shutting down a hydraulic pump, for example, may not provide sufficient information to the crew members to enable them to distinguish an error from a system fault. In this case, flight manual procedures may provide the error detection means as the crew performs the 'loss of hydraulic system' procedures.
 - (D) If the system can detect pilot error, the system could be designed to prevent pilot errors. For example, if the system can detect an incorrect frequency entry by the pilot, then the system should be able to disallow that entry and provide appropriate feedback to the pilot. Examples are automated error checking and filters that prevent the entry of unallowable or illogical entries.
 - (iii) 'Global' alerts cover a multitude of possible errors by annunciating external hazards, the envelope of the rotorcraft, or operational conditions. Examples include monitoring systems such as a terrain awareness and warning system

(TAWS) and a traffic alert and collision avoidance system (TCAS). An example would be a TAWS alert resulting from turning in the wrong direction in a holding pattern in mountainous terrain.

- (3) The applicant should consider the following when establishing whether the level or type of information available to the crew members is adequately detectable and clearly related to the error:
 - (i) The effects of some errors are easily and reliably determined by the system because of its design, and some are not. For those that cannot be sensed by the system, the design and arrangement of the information monitored and scanned by the crew members can facilitate error detection.

An example would be the alignment of engine speed indicator needles in the same direction during normal operations. In the event of an engine asymmetrical thrust linked to crew member error, which manifested itself in a change in the rpm on one engine, the spatial misalignment of the needles could assist the pilots in diagnosing the issue and identifying asymmetrical thrust-lever position.
 - (ii) Rotorcraft alerting and indication systems may not detect whether an action is erroneous because the systems cannot know the intent of the crew in many operational circumstances. For crew member errors of this nature, error detection depends on the crew's interpretation of the available information. Training, crew resource management (CRM), and monitoring systems (such as TAWS and TCAS) are examples of ways to provide a redundant level of safety.
 - (4) The applicant may establish that information is available and clearly related to the error by using a design description when a precedent exists or when a reasonable case may be made that the content of the information is clearly related to the error that caused it. In some cases, a crew member assessment (see 5.3) may be needed to assess whether the information provided is adequately available and detectable.
- (c) Error recovery
- (1) When an error or its effects are detected, the next logical step is to ensure that the error can be reversed, or that the effect of the error can be mitigated in some way so that the rotorcraft is returned to a safe state.
 - (2) An acceptable means to establish that an error is recoverable is to show that:
 - (i) controls and indications exist that can be used either to reverse an erroneous action directly so that the rotorcraft or system is returned to the original state, or to mitigate the effect so that the rotorcraft or system is returned to a safe state; and
 - (ii) those controls and indications can be expected to be used by the crew members to accomplish the corrective actions in a timely manner.
 - (3) For simple or familiar types of system interfaces, or systems that are not novel, even if they are complex, a statement of similarity or a description of the design of the crew member interfaces and the procedures associated with the indications may be an acceptable means of compliance.
 - (4) To establish that the crew members can be expected to use those controls and indications to accomplish corrective actions in a timely manner, an assessment of the crew member procedures in a simulated cockpit environment can be highly effective. This assessment should include an examination of the nomenclature used in alert messages, controls, and

other indications. It should also include the logical flow of procedural steps and the effects that executing the procedures have on other systems.

(d) Error effects

- (1) Another means of satisfying the objective of error mitigation is to ensure that the effects of the error or the relevant effects on the state of the rotorcraft:
 - (i) are evident to the crew; and
 - (ii) do not adversely impact on safety.
- (2) Piloted assessments in the rotorcraft or in simulation may be relevant if crew member performance issues are in question for determining whether a state following an error permits continued safe flight and landing. Assessments and/or analyses may be used to show that, following an error, the crew member has the information in an effective form and has the rotorcraft capability required for continued safe flight and landing.

(e) Precluding errors or their effects

- (1) For irreversible errors that have potential safety implications, means to prevent errors are recommended. Acceptable ways to prevent errors include switch guards, interlocks, or confirmation actions. For example, generator drive controls on many rotorcraft have guards over the switches to prevent their inadvertent actuation, because once disengaged, the drives cannot be re-engaged while in flight or with the engine running. An example of confirmation action would be the presentation of a flight plan modification in a temporary flight plan, where the crew members will activate the flight plan through a confirmation action.
- (2) Another way of avoiding crew member error is to design systems to remove misleading or inaccurate information (e.g. sensor failures) from displays. An example would be a system that removes the flight director bars from a primary flight display or removes the 'own ship' position from an airport surface map display when the data driving the symbols is incorrect.
- (3) The applicant should avoid applying an excessive number of protections for a given error. The excessive use of protections could have unintended safety consequences. They might hamper the crew member's ability to use judgment and take action in the best interest of safety in situations that were not predicted by the applicant. If protections become a nuisance in daily operation, crews may use well-intentioned and inventive means to circumvent them. This could have further effects that were not anticipated by the operator or the designer.

4.6 Integration

(a) Introduction

- (1) Many systems, such as flight management systems (FMSs), are integrated physically and functionally into the cockpit and may interact with other cockpit systems. It is important to consider a design not just in isolation, but in the context of the overall cockpit. Integration issues include where a display or control is installed, how it interacts with other systems, and whether there is internal consistency across functions within a multi function display, as well as consistency with the rest of the cockpit equipment.

-
- (2) Analyses, evaluations, tests and other data developed to establish compliance with each of the specific requirements in [CS 29.1302\(a\)](#) to (d) should address the integration of new design items. It should include consideration of the following integration factors:
- (i) consistency (see 4.6(b)),
 - (ii) consistency trade-offs (see 4.6(c)),
 - (iii) the cockpit environment (see 4.6(d)), and
 - (iv) integration-related workload and error (see 4.6(e)).
- (b) Consistency
- (1) If similar information is presented in multiple locations or modes (both visual and auditory, for example), the consistent presentation of the information is desirable. If information cannot be presented consistently within the cockpit, the applicant should show that the differences do not increase the error rates or task times, which would lead to a significant reduction in the safety margins or an increase in the crew members' workload, and do not cause confusion to crew members.
- (2) Consistency needs to be considered within a given system and across the cockpit. Inconsistencies may result in vulnerabilities that may lead to human performance issues, such as increased workload and errors, especially during stressful situations. For example, in some flight management systems (FMSs), the format for entering the latitude and longitude differs between the display pages. This may induce crew member errors, or at least increase the crew's workload. Additionally, errors may result if the latitude and longitude are displayed in a format that differs from the formats used on the most commonly used paper charts. Because of this, it is desirable to use formats that are consistent with other media whenever possible. One way in which the applicant can achieve consistency within a given system, as well as within the overall cockpit, is to adhere to a comprehensive cockpit design philosophy. The following are design attributes to consider for their consistency within and across systems:
- (i) Symbology, data entry conventions, formatting, the colour philosophy, terminology, and labelling.
 - (ii) Function and logic. For example, when two or more systems are active and perform the same function, they should operate consistently and use an interface in the same style.
 - (iii) Information presented with other information of the same type that is used in the cockpit. It is important that functions that convey the same information be consistent. One example is symbol sets. Traffic or terrain awareness systems should display consistent symbol sets if generated by separate installed systems.
- (3) Another way to demonstrate consistency is to show that certain aspects of the design are consistent with accepted, published standards such as the labels and abbreviations recommended in ICAO Doc 8400 'Procedures for Air Navigation Services (PANS) - ICAO Abbreviations and Codes' or in SAE ARP4105C 'Abbreviations, Acronyms, and Terms for Use on the Flight Deck'. The applicant might standardise the symbols used to depict navigation aids (very high frequency omnidirectional range (VOR), for example), by following the conventions recommended in SAE ARP5289A 'Electronic Aeronautical Symbols'. However, inappropriate standardisation, rigidly applied, can be a barrier to innovation and product improvement. Thus, the guidance in this paragraph promotes consistency rather than rigid standardisation.

(c) Consistency trade-offs

It is recognised that it is not always possible or desirable to provide a consistent crew member interface. Despite conformance with the cockpit design philosophy, principles of consistency, etc., it is possible to negatively impact on the crew's workload. For example, all the auditory alerts may adhere to a cockpit alerting philosophy, but the number of alerts may be unacceptable. The use of a consistent format across the cockpit may not work when individual task requirements necessitate the presentation of data in two significantly different formats. An example is a weather radar display formatted to show a sector of the environment, while a moving-map display shows a 360-degree view. In such cases, it should be demonstrated that the design of the interface is compatible with the requirements of the piloting task, and that it can be used individually and in combination with other interfaces without interference with either the system or the function.

Additionally:

- (1) The applicant should provide an analysis identifying each piece of information or data presented in multiple locations, and show that the data is presented in a consistent manner or, where that is not true, justify why that is not appropriate.
- (2) Where information is inconsistent, that inconsistency should be obvious or annunciated, and should not contribute to errors in the interpretation of information.
- (3) There should be a rationale for instances where the design of a system diverges from the cockpit design philosophy. Applicants should consider any impact on the workload and on errors as a result of such divergences.
- (4) The applicant should describe what conclusion the crew members are expected to draw and what action should be taken when information on the display conflicts with other information in the cockpit (either with or without a failure).

(d) Cockpit environment

- (1) The cockpit system is influenced by the physical characteristics of the rotorcraft into which a system is integrated, as well as by the characteristics of the operational environment. The system is subject to such influences on the cockpit as turbulence, noise, ambient light, smoke, and vibrations (such as those that may result from ice or the loss of a fan blade). The design of the system should recognise the effect of such influences on usability, workload, and crew member task performance. Turbulence and ambient light, for example, may affect the readability of a display. Cockpit noise may affect the audibility of aural alerts. The applicant should also consider the impact of the cockpit environment for abnormal situations, such as recovery from an unusual attitude or regaining control of the rotorcraft or system.
- (2) The cockpit environment includes the layout, or the physical arrangement of the controls and information displays. Layouts should take into account the crew member requirements in terms of:
 - (i) access and reach (to the controls);
 - (ii) visibility and readability of the displays and labels; and
 - (iii) the task-oriented location and grouping of HMI elements.

An example of poor physical integration would be a required piece of information that is obscured by a control in its normal operating position.

- (e) Integration-related workload and error
- (1) When integrating functions and/or equipment, designers should be aware of the potential effects, both positive and negative, that integration can have on the workload of the crew members and its subsequent impact on error management. Systems must be designed and assessed, both in isolation and in combination with other cockpit systems, to ensure that the crew members are able to detect, reverse, or recover from errors. This may be more challenging when integrating systems that employ higher levels of automation or have a high degree of interaction and dependency on other cockpit systems.
 - (2) Applicants should show that the integrated design does not adversely impact on the workload or errors in the context of the entire flight regime. Examples of such impacts would be taking more time to:
 - (i) interpret a function;
 - (ii) make a decision; or
 - (iii) take appropriate action.
 - (3) Controls, particularly multi-function controls and/or novel types of control, may present the potential for misidentification and increased response times. Designs should generally avoid multi-function controls with hidden functions, because they increase both the workload of the crew members and the potential for error.
 - (4) Two examples of integrated design items that may or may not impact on errors and the workload are as follows:
 - (i) Presenting the same information in two different formats. This may increase the workload, such as when altitude information is presented concurrently in both tape and round-dial formats. However, different formats may be suitable, depending on the design and the crew task. For example, an analogue display of engine revolutions per minute (rpm) can facilitate a quick scan, whereas a digital numeric display can facilitate precise inputs. The applicant is responsible for demonstrating compliance with [CS 29.1523](#) and showing that the differences in the formats do not result in unacceptable levels of workload.
 - (ii) Presenting conflicting information. Increases in workload and error may result from two displays depicting conflicting altitude information on the cockpit concurrently, regardless of the formats. Systems may exhibit minor differences between each crew member station, but all such differences should be assessed specifically to ensure that the potential for interpretation error is minimised, or that a method exists for the crew members to detect any incorrect information, or that the effects of these errors can be precluded.
 - (iii) The applicant should show that the proposed function will not inappropriately draw attention away from other cockpit information and tasks in a way that degrades the performance of the crew members and decreases the overall level of safety. There are some cases in which it may be acceptable for the system design to increase the workload. For example, adding a display into the cockpit may increase the workload by virtue of the additional time crew members spend looking at it, but the safety benefit that the additional information provides may make it an acceptable trade-off.

- (iv) Since each new system integrated into the cockpit may have a positive or negative effect on the workload, each must be assessed in isolation and in combination with the other systems for compliance with CS 29.1523. This is to ensure that the overall workload is acceptable, i.e. that the performance of flight tasks is not adversely impacted, and that the crew's detection and interpretation of information does not lead to unacceptable response times. Special attention should be paid to items that are workload factors. They include the 'accessibility, ease, and simplicity of operation of all necessary flight, power, and equipment controls'.

5) MEANS OF COMPLIANCE

5.1 Overview

This paragraph provides considerations the applicant should use when selecting the means of compliance. It discusses seven types of means of compliance and provides specific HFs considerations for their use.

The applicant should determine the means of compliance to be used on a given project on a case-by-case basis, taking into account the specific compliance issues. In any case, the nature of the HFs objective to be assessed should drive the selection of the appropriate means of compliance.

Some certification projects may necessitate more than one means of demonstrating compliance with a particular CS. For example, when flight testing in a conforming rotorcraft is not possible, a combination of a design review and a part-task evaluation may be proposed. In this context, part-task evaluation focuses only on specific sub-functions of the design item.

The uses and limitations of each type of means of compliance are provided in paragraph 5.3.

5.2 List of the means of compliance

The most common means of compliance that are used to demonstrate compliance with HFs certification specifications are discussed in this paragraph and include:

- (a) MC0: Compliance statements,
- (b) MC1: Design review,
- (c) MC2: Calculations and analyses,
- (d) MC4: Laboratory tests,
- (e) MC5: Ground tests,
- (f) MC6: Flight tests,
- (g) MC8: Simulation.

When the 'scenario-based' methodology is used as part of the above-listed means of compliance, additional guidance can be found in paragraph 3.3.2.

5.3 Selecting the means of compliance

5.3.1 Credit from previous compliance certification processes

When determining the level of scrutiny applicable to each design item, the applicant should identify a reference product.

The reference product can also play a role in the compliance demonstration process if data from previous certification exercises is used. However, the following two dimensions should be taken into account when assessing the extent to which certification credits can be granted:

- The reference product from which the applicant intends to claim compliance;

- The certification basis that was used to certify that reference product.

The applicant is then expected to gain more certification credits from the equipment installed on one of its rotorcraft already certified under CS 27/29.1302.

Fewer certification credits can be requested when the equipment installed on a rotorcraft was certified by the applicant under a HF's regulatory material different from [CS 29.1302](#). The acceptability of this approach will be evaluated on a case-by-case basis by assessing the compatibility of the reference regulatory material and the methods used at the time of the initial certification.

As a general principle, no certification credit can be claimed when the design item installed on a rotorcraft was certified by another design organisation or when it was not certified by EASA. However, in accordance with 3.3.1(d), the applicant might take credit for the activities carried out by an equipment supplier that performed certain HF's assessments on a voluntary basis.

5.3.2 Representativeness of the test article

Means of compliance MC4, MC5, MC6 and MC8 require the use of a test article (benches, mock-ups, the actual rotorcraft, or a simulator).

As explained in paragraph 3.3.1, in order to achieve its objectives, the HF's assessment should be started in the early stage of the project and follow an iterative process. This iterative nature of the process may require the applicant to perform assessments in the early stage of the project when the design is still likely to change. On the other hand, test articles that are not fully representative of the final design can be available later on during the certification process and may be the only available ones to actually perform some assessments (for example, a bench or a simulator may be the only means to assess the behaviour for failures that cannot be simulated in flight).

Therefore, the verification of the test article's representativeness, with its deviations from the intended final standard, is a step of paramount importance for the HF's assessment. These deviations should be evaluated taking into account the objectives of the assessment.

For example:

- If a ground test is carried out to assess the controls reachability, specific attention should be paid at the cockpit geometry being representative of the design under certification while the conformity of the avionics is not required.
- If a simulator is used, the required functional and physical representativeness of the simulation (or degree of realism) will typically depend on the configurations, design items, and crew tasks to be assessed.

As a general principle, as long as the deviations from the intended final standard are known and monitored and do not compromise the validity of the data to be collected, the lack of full representativeness should not prevent the use of a test article. In such cases, partial certification credits may still be granted, provided that the applicant can show that the deviations do not affect the test results.

5.3.3 Presentation of the means of compliance

a) MCO Compliance statement based on similarity

Description
A statement of similarity is a declaration of (full or partial) compliance based on a description of the system to be approved compared to a description of a previously approved system, detailing the physical, logical, and operational similarities relevant for the regulation the applicant wishes to demonstrate compliance with.
Use
A statement of similarity can be sufficient or used in combination with other means of compliance.
Limitations
A statement of similarity, for the purpose of compliance demonstration, should be used with care. The cockpit should be assessed as a whole, not merely as a set of individual functions or systems. Two design items previously approved on separate programmes may be incompatible when combined in a single cockpit. Also, changing one feature in the cockpit may necessitate corresponding changes in other features, to maintain consistency and prevent confusion.
Example
If the window design in a new rotorcraft is identical to that in an existing rotorcraft, a statement of similarity may be an acceptable means of compliance to meet CS 29.773 .

b) MC1 Design review

The applicant may elect to substantiate that the design meets the objectives of a specific paragraph by describing the design. The applicant has traditionally used drawings, configuration descriptions, and/or design philosophies to demonstrate compliance.

1) Drawings

Description
Drawings depicting the physical arrangement of hardware or display graphics.
Use
Applicants can use drawings for very simple certification programmes when the change to the cockpit is very simple and straightforward. Drawings can also be used to support compliance findings for more complex interfaces.
Limitations
The use of drawings is limited to physical arrangements and graphical concerns.

2) Configuration description

Description
A configuration description is a description of the layout, general arrangement, direction of movement, etc., of a design item. It can also be a reference to documentation that provides such a description. It could be used to show the relative locations of flight instruments, groupings of control functions, the allocation of colour codes to displays and alerts, etc.
Use
Configuration descriptions are generally less formalised than engineering drawings. They are developed to point out features of the design that support a finding of compliance. In some cases, such configuration descriptions may provide sufficient information for a finding of compliance. More often, however, they provide important background information, while the final confirmation of compliance is found through other means, such as demonstrations or tests. The background information provided by configuration descriptions may significantly reduce the risk associated with demonstrations or tests. The applicant will have already communicated how a system works with the configuration description, and any discussions or assumptions may have already been coordinated.
Limitations
Configuration descriptions may provide sufficient information for a finding of compliance only with a specific requirement.

3) Design philosophy

Description
A design philosophy approach can be used to demonstrate that an overall safety-centred philosophy, as detailed in the design specifications for the product/system or cockpit, has been applied.
Use
It documents that the design qualifies to meet the objectives of a specific paragraph.
Limitations
In most cases, this means of compliance will be insufficient as the sole means to demonstrate compliance.
Example
The design philosophy may be used as a means of compliance when a new alert is added to the cockpit provided the new alert is consistent with the acceptable, existing alerting philosophy.

c) MC2 Calculations/analyses

Description
Calculations or engineering analyses ('paper and pencil' assessments) that do not require direct participant interaction with a physical representation of the equipment.
Use
Provides a systematic analysis of specific or overall aspects of the human interface part of the product/system/cockpit.
Limitations
The applicant should carefully consider the validity of the assessment technique if the analyses are not based on recognised industry standard methods. The applicant may be asked to validate any computational tools used in such analyses. If the analysis involves comparing measured characteristics with recommendations derived from pre-existing research (internal or public domain), the applicant may be asked to justify the applicability of the data to the project. While analyses are useful to start investigating the potential for design-related human errors, as well as the theoretical efficiency of the available means of protection, this demonstration should be complemented by observations through other means of compliance when required. Analysis cannot be used to assess complex cognitive issues.
Example
An applicant may conduct a vision analysis to demonstrate that the crew member has a clear and undistorted view out of the windshield. Similarly, an analysis may also demonstrate that flight, navigation

and power plant instruments are plainly visible from the crew member stations. The applicant may need to validate the results of the analysis in a ground or flight test, or by using a means of simulation that is geometrically representative. An applicant may also conduct an analysis based on evidence collected during similar previous HF assessments.

d) MC4 Laboratory tests

Description
An assessment made using a bench test representing the HMI. This can be conducted on an avionics bench when the purpose is to assess the information, or on a mock-up when the purpose is to assess the cockpit geometry.
Bench or laboratory assessment
The applicant can conduct an assessment using devices emulating crew member interfaces for a single system or a group of related systems. The applicant can use flight hardware, simulated systems, or combinations of these.
Example of a bench or laboratory assessment
A bench assessment for an integrated system could be conducted using an avionics suite installed in a mock-up of a cockpit, with the main displays and autopilot controls included. Such a tool may be valuable during development and for making EASA familiar with the system. However, in a highly integrated architecture, it may be difficult or impossible to assess how well the avionics system will fit into the overall cockpit without more complete simulation or use of the actual rotorcraft.
Mock-up evaluation
A mock-up is a full-scale, static representation of the physical configuration (form and fit). It does not include functional aspects of the cockpit and its installed equipment. Mock-ups can be used as representations of the design, allowing participants to physically interact with the design. Three-dimensional representations of the design in a CAD system, in conjunction with three-dimensional models of the cockpit occupants, have also been used as 'virtual' mock-ups for certain limited types of evaluations. Reachability, for example, can be addressed using either type of mock-up.
Example of a mock-up evaluation
An analysis to demonstrate that the controls are arranged so that crew members from 1.57 m (5 ft 2 in) to 1.8 m (6 ft) in height can reach all controls. This analysis may use computer-generated data based on engineering drawings. The applicant may demonstrate the results of the analysis in the actual rotorcraft.
Limitations
Bench tests or mock-ups cannot be used to assess complex cognitive issues.

e) MC5 Ground tests

Description
An assessment conducted on a flight test article on ground.
Limitations
Ground tests cannot be used to assess complex cognitive issues.
Example
An example of a ground test is the assessment of the displays' potential for reflections on the windshield and on the windows. Such an assessment involves covering the cockpit windows to simulate darkness and setting the cockpit lighting to the desired levels. This particular assessment may not be possible in a simulator because of differences in the light sources, display hardware, and/or construction of the windows.

f) MC6 Flight tests and MC8 Simulation

The applicant may use a wide variety of part-task to full-installation representations of the product/system or cockpit for assessment purposes. The representation of the HMI does not necessarily conform to the final design. The paragraphs below address both system- and rotorcraft-level evaluations that typically make up this group of means of compliance.

Description
As soon as the maturity of the design allows pilots to take part in the compliance demonstration, HFs assessments are conducted in a dynamic operational context. Depending on the HFs objectives to be addressed, and according to the HFs test programme, those assessments can be either conducted at the system level or the rotorcraft level. Both simulators and real rotorcraft can be used, but the selection of the MoC depends on the nature of the test objectives.
Use
Traditionally, these types of activities are part of the design process. They allow applicants to continuously improve their designs thanks to the application of an iterative approach.

(f)(i)MC8 Simulation

Simulator assessment
A simulator assessment uses devices that present an integrated emulation (using flight hardware, simulated systems, or combinations of these) of the cockpit and the operational environment. These devices can also be ‘flown’ with response characteristics that replicate, to some extent, the responses of the rotorcraft.

(f)(ii)MC6 Flight tests

In-flight assessment
<p>Flight testing during certification is the final compliance demonstration of the design, and is conducted in a conforming rotorcraft during flight. The rotorcraft and its components (cockpit) are the most representative of the type design to be certified and will be the closest to real operations of the equipment. In-flight testing is the most realistic testing environment, although it is limited to those tests that can be conducted safely. Flight testing can be used to validate and verify other assessments previously conducted during the development and certification programme. It is often best to use flight testing as the final confirmation of data collected using other means of compliance, including analyses and assessments.</p> <p>Flights tests carried out for areas of investigation outside the HFs scope can be given partial credit for demonstrating compliance with 29.1302. The acceptability of this approach has, however, to be assessed by EASA on a case-by-case basis. A prerequisite for acceptance by EASA is the respect of the basic HFs methodical principles for data collection and processing. These flight tests should only be used as a complementary approach to dedicated HFs assessments.</p>

(f)(iii)MC6 versus MC8

MC6 versus MC8:

The selection of the flight test as a means of assessment should not be exclusively motivated by the absence of any other available means, but should be duly justified, taking into account its inherent limitations:

- Due to safety reasons, the actual testing on a rotorcraft may be inappropriate for the malfunction assessment.
- Flight test does not normally allow the manipulation of the operational environment which may be needed to apply the scenario-based approach.
- HFs in-flight scenarios may be challenging to replicate due to the difficulty in reproducing the operational context. For example, events like ATC communications, weather, etc., which are expected to trigger a crew reaction to be tested may not be repeatable. This may hamper the collection of homogeneous data and may adversely affect its validity.

However, flight test is deemed adequate when the operational and/or system representativeness is a key driver for the validity of HFs data. For example, an in-flight assessment is typically more adequate when dealing with workload determination.

[Amdt 29/9]

AMC 29.1302 APPENDIX 1: Related regulatory material and documents

ED Decision 2021/010/R

EASA AMC:

- AC 29-2C Change 7 MG-19 *Electronic Display Systems and MG-20 Human Factors*
- PS-ANM100-01-03A, *Factors to Consider When Reviewing an Applicant's Proposed Human Factors Methods for Compliance for Flight Deck Certification*

Other documents:

The following is a list of other documents relevant to cockpit design and crew member interfaces that may be useful when applying this AMC. Some are not aviation specific, such as International Standard ISO 9241-4, which, however, provides useful guidance. When using that document, applicants should consider environmental factors such as the intended operational environment, turbulence, and lighting, as well as cross-side reach.

- Policy Memo ANM-99-2, *Guidance for Reviewing Certification Plans to Address Human Factors for Certification of Transport Airplane Flight Decks*
- AMC 25-11, *Electronic Flight Deck Displays*, November 2018
- SAE ARP4033, *Pilot-System Integration*, August 1995
- SAE ARP5289A, *Electronic Aeronautical Symbols*
- SAE ARP4102/7, *Electronic Displays*
- SAE ARP4105C, *Abbreviations, Acronyms, and Terms for Use on the Flight Deck*
- ICAO Doc 8400, *Procedures for Air Navigation Services — ICAO Abbreviations and Codes*, Ninth Edition, 2016
- AO Doc 9683 – AN/950, *Human Factors Training Manual*, First Edition, 1998

- International Standards ISO 9241-4, *Ergonomic Requirements for Office Work with Visual Display Terminals (VDTs)*
- FAA Human Factors Team report on: *The Interfaces Between Flight crews and Modern Flight Deck Systems*, 1996
- DOT/FAA/RD-93/5: *Human Factors for Flight Deck Certification Personnel*, 1993
- FAA AC 20-175 *Controls for Flight Deck Systems*, 2011
- FAA AC 00-74 *Avionics Human Factors Considerations for Design and Evaluation*, 2019
- DOT/FAA/TC-13/44 *Human Factors Considerations in the Design and Evaluation of Flight Deck Displays and Controls*, 2016

[Amdt 29/9]

GM1 29.1302 Explanatory material

ED Decision 2021/010/R

1 Introduction

- (a) Accidents most often result from a sequence or combination of different errors and safety-related events (e.g. equipment failures and weather conditions). Analyses show that the design of the cockpit and other systems can influence the crew's task performance and the occurrence and effects of some crew member errors.
- (b) Crew members make a positive contribution to the safety of the aviation system because of their ability to continuously assess changing conditions and situations, analyse potential actions, and make reasoned decisions. However, even well-trained, qualified, healthy, alert crew members make errors. Some of these errors may be induced or influenced by the designs of the systems and their crew interfaces, even with those that are carefully designed. Most of these errors have no significant safety effects, or are detected and mitigated in the normal course of events. However, some of them may lead or contribute to the occurrence of unsafe conditions. Accident analyses have identified crew member performance and errors as recurrent factors in the majority of accidents involving rotorcraft.
- (c) Some current requirements are intended to improve safety by requiring the cockpit and its equipment to be designed with certain capabilities and characteristics. The approval of cockpit systems with respect to design-related crew member error has typically been addressed by referring to system-specific or general applicability requirements, such as [CS 29.1301\(a\)](#), [CS 29.771\(a\)](#), and [CS 29.1523](#). However, little or no guidance exists to show how the applicant may address potential crew member limitations and errors. That is why [CS 29.1302](#) and this guidance material have been developed.
- (d) CS 29.1302 was developed to provide a basis for addressing the design-related aspects of the avoidance and management of crew member errors by taking the following approach.
 - (i) Firstly, by providing means to address the design characteristics that are known to reduce or avoid crew member error and that address crew member capabilities and limitations. CS 29.1302(a) to (c) are intended to reduce the design contribution to such errors by ensuring that the information and controls needed by the crew members to perform the tasks associated with the intended function of installed equipment are provided, and that they are provided in a usable form.

In addition, operationally relevant system behaviour must be understandable, predictable, and supportive of the crew's tasks. Guidance is provided in this paragraph on the avoidance of design-induced crew member errors.

- (ii) Secondly, CS 29.1302(d) addresses the fact that since crew member errors will occur, even with a well trained and proficient crew operating well-designed systems, the design must support the management of those errors to avoid any safety consequences. Paragraph 5.7 below on crew member error management provides the relevant guidance.
- (e) EASA would like to bring the applicants' attention to the fact that the implementation of the CS 29.1302 process may require up to several years, depending on the characteristics of the project. However, STCs may require much less time.

2 CS 29.1302: applicability and explanatory material

- (a) CS-29 contains certification specifications for the design of cockpit equipment that is system specific (refer to AMC 29.1302, Table 1, in paragraph 2), generally applicable (e.g. CS 29.1301(a), [CS 29.1309\(c\)](#), [CS 29.771\(a\)](#)), and establishes minimum crew requirements (e.g. [CS 29.1523](#)). [CS 29.1302](#) complements the generally applicable requirements by adding more explicit objectives for the design attributes related to the avoidance and management of crew member errors. Other ways to avoid and manage crew member errors are regulated through the requirements governing the licensing and qualifications of crew members and rotorcraft operations. Taken together, these complementary approaches provide an adequate level of safety.
- (b) The complementary approach is important. It is based upon the recognition that equipment design, training/licensing/qualifications and operations/procedures each provide safety contributions to risk mitigation. An appropriate balance is needed between them. There have been cases in the past where design characteristics known to contribute to crew member errors were accepted based upon the rationale that training or procedures would mitigate that risk. We now know that this can often be an inappropriate approach. Similarly, due to unintended consequences, it would not be appropriate to require equipment design to provide total risk mitigation.
- (c) A proper balance is needed between certification specifications in CS-29 and the requirements for training/licensing/qualifications and operations/procedures. CS 29.1302 and this GM were developed with the intent of achieving that appropriate balance.
 - (1) Introduction. The introductory sentence of CS 29.1302 states that 'this paragraph applies to installed systems and equipment intended to be used by the crew members when operating the rotorcraft from their normal seating positions in the cockpit or their operating positions in the cabin'.
 - (i) 'Intended to be used by the crew members when operating the rotorcraft from their normal seating positions in the cockpit or their operating positions in the cabin' means that the intended function of the installed equipment includes its use by the crew members when operating the rotorcraft. An example of such installed equipment would be a display that provides information enabling the crew to navigate. The term 'crew members' is intended to include any or all individuals comprising the minimum crew as determined for compliance with CS 29.1523. The phrase 'from their normal seating positions in the cockpit' means that the crew members are seated at their normal duty stations for operating the rotorcraft.

- (ii) The phrase ‘from their normal seating positions in the cockpit or their operating positions in the cabin’ means that the crew members are positioned at their normal duty stations in the cabin. These phrases are intended to limit the scope of this requirement so that it does not address the systems or equipment that are/is not used by the crew members while performing their duties in operating the rotorcraft in normal, abnormal/malfunction and emergency conditions. For example, this paragraph is not intended to apply to design items such as certain circuit breakers or maintenance controls intended for use by the maintenance crew (or by the crew when not operating the rotorcraft).
- (iii) The phrase ‘The installed systems and equipment must be shown [...]’ in the first paragraph means that the applicant must provide sufficient evidence to support compliance determinations for each of the CS 29.1302 objectives. This is not intended to require a demonstration of compliance beyond that required by point 21.A.21(a) of Part 21. Accordingly, for simple design items or items similar to previously approved equipment and installations, the demonstrations, assessments or data needed to demonstrate compliance with CS 29.1302 are not expected to entail more extensive or onerous efforts than are necessary to demonstrate compliance with the previous requirements.
- (iv) The phrase ‘individually and in combination with other such equipment’ means that the objectives of this paragraph must be met when equipment is installed in the cockpit with other equipment. The installed equipment must not prevent other equipment from complying with these objectives. For example, applicants must not design a display so that the information it provides is inconsistent or is in conflict with information provided from other installed equipment.
- (v) In addition, this paragraph presumes a qualified crew member that is trained to use the installed equipment. This means that the design must meet these objectives for crew members who are allowed to fly the rotorcraft by meeting the qualification requirements of the operating rules. If the applicant seeks a type design or supplemental type design approval before a training programme is accepted, the applicant should document any novel, complex or highly integrated design items and assumptions made during the design phase that have the potential to affect the training time or the crew member procedures. The certification specification and associated material are written assuming that either these design items and assumptions or the knowledge of a training programme (proposed or in the process of being developed) will be coordinated with the appropriate operational approval organisation when assessing the adequacy of the design.
- (vi) The objective for the equipment to be designed so that the crew members can safely perform their tasks associated with the intended function of the equipment applies in normal, abnormal/malfunction and emergency conditions. The tasks intended to be performed under all the above conditions are generally those prescribed by the crew member procedures. The phrase ‘safely perform their tasks’ is intended to describe one of the safety objectives of this certification specification. The objective is for the equipment design to enable the crew members to perform their tasks with sufficient accuracy and in a timely manner, without unduly interfering with their other required tasks. The phrase ‘tasks associated with its intended function’ is intended to characterise either the tasks

required to operate the equipment or the tasks for which the intended function of the equipment provides support.

- (2) [CS 29.1302\(a\)](#) requires the applicant to install the appropriate controls and provide the necessary information for any cockpit equipment identified in the first paragraph of CS 29.1302. The controls and the information displays must be sufficient to allow the crew members to accomplish their tasks. Although this may seem obvious, this objective is included because a review of CS-29 on the subject of HFs revealed that a specific objective for cockpit controls and information to meet the crew member needs is necessary. This objective is not reflected in other parts of the rules, so it is important to be explicit.
- (3) CS 29.1302(b) addresses the objective for cockpit controls and information that are/is necessary and appropriate for the crew members to accomplish their tasks, as determined in (a) above. The intent is to ensure that the design of the controls and information devices makes them usable by the crew members. This subparagraph seeks to reduce design induced crew member errors by imposing design objectives for cockpit information presentation and controls. Subparagraphs (1) through (3) specify these design objectives. The design objectives for information and controls are necessary to:
 - (i) properly support the crew members in planning their tasks;
 - (ii) make available to the crew members appropriate, effective means to carry out planned actions; and
 - (iii) enable the crew members to have appropriate feedback information about the effects of their actions on the rotorcraft.
- (4) [CS 29.1302\(b\)\(1\)](#) specifically requires controls and information to be designed in a clear and unambiguous form, at a resolution and precision appropriate to the task.
 - (i) As applied to information, ‘clear and unambiguous’ means that it can be perceived correctly (is legible) and can be comprehended in the context of the crew member tasks associated with the intended functions of the equipment, such that the crew members can perform all the associated tasks.
 - (ii) For controls, the objective for ‘clear and unambiguous’ presentation means that the crew members must be able to use them appropriately to achieve the intended functions of the equipment. The general intent is to foster the design of equipment controls whose operation is intuitive, consistent with the effects on the parameters or states that they affect, and compatible with the operation of the other controls in the cockpit.
 - (iii) 29.1302(b)(1) also requires the information or control to be provided, or to operate, at a level of detail and accuracy appropriate for accomplishing the task. Insufficient resolution or precision would mean the crew members could not perform the task adequately. Conversely, excessive resolution has the potential to make a task too difficult because of poor readability or the implication that the task should be accomplished more precisely than is actually necessary.
- (5) CS 29.1302(b)(2) requires controls and information to be accessible and usable by the crew members in a manner appropriate to the urgency, frequency, and duration of their tasks. For example, controls that are used more frequently or urgently must be readily accessible, or require fewer steps or actions to perform the task. Less accessible controls may be acceptable if they are needed less frequently or less urgently. Controls that are used less frequently or less urgently should not interfere with those used more urgently

or more frequently. Similarly, tasks requiring a longer time for interaction should not interfere with the accessibility to information required for urgent or frequent tasks.

- (6) CS 29.1302(b)(3) requires equipment to present information that makes the crew members aware of the effects of their actions on the rotorcraft or systems, if that awareness is required for the safe operation of the rotorcraft. The intent is for the crew members to be aware of the system or rotorcraft states resulting from crew actions, permitting them to detect and correct their own errors. This subparagraph is included because new technology enables new kinds of crew member interfaces that previous objectives did not address. Specific deficiencies of existing objectives in addressing HFIs are described below:
- (i) [CS 29.771\(a\)](#) addresses this topic for controls, but does not include criteria for the presentation of information;
 - (ii) [CS 29.777\(a\)](#) addresses controls, but only their location;
 - (iii) CS 29.777(b) and [CS 25.779](#) address the direction of motion and actuation but do not encompass new types of controls, such as cursor-control devices. These requirements also do not encompass types of control interfaces that can be incorporated into displays via menus, for example, thus affecting their accessibility;
 - (iv) [CS 29.1523](#) has a different context and purpose (determining the minimum crew), so it does not address these requirements in a sufficiently general way.
- (7) CS 29.1302(c) requires installed equipment to be designed so that its behaviour that is operationally relevant to crew member tasks is:
- (i) predictable and unambiguous, and
 - (ii) designed to enable the crew members to intervene in a manner appropriate to the task (and intended function).

Other related considerations are the following:

- (iii) Improved cockpit technologies involving integrated and complex information and control systems have increased safety and performance. However, they have also introduced the need to ensure proper interactions between the crew and those systems. In-service experience has shown that some equipment behaviour (especially from automated systems) is excessively complex or dependent upon logical states or mode transitions that are not well understood or expected by the crew members. Such design characteristics can confuse the crew members and have been determined to contribute to incidents and accidents.
- (8) [CS 29.1302\(c\)\(1\)](#) requires the behaviour of a system to be such that a qualified crew member knows what the system is doing and why it is doing it. It requires operationally relevant system behaviour to be 'predictable and unambiguous'. This means that a crew can retain enough information about what their action or a changing situation will cause the system to do under foreseeable circumstances, so they can operate the system safely.
- The behaviour of a system must be unambiguous because the actions of the crew may have different effects on the rotorcraft, depending on its current state or operational circumstances.
- (9) CS 29.1302(c)(2) requires the design to be such that the crew members will be able to take some action, or change or alter an input to the system, in a manner appropriate to the task.

- (10) CS 29.1302(d) addresses the reality that even well-trained, proficient crews using well designed systems will make errors. It requires the equipment to be designed such in order to enable the crew members to manage such errors. For the purpose of this CS, errors ‘resulting from crew interaction with the equipment’ are those errors that are in some way attributable, or related, to the design of the controls, the behaviour of the equipment, or the information presented. Examples of designs or information that could cause errors are indications and controls that are complex and inconsistent with each other or with other systems on the cockpit. Another example is a procedure that is inconsistent with the design of the equipment. Such errors are considered to be within the scope of this CS and the related AMC.
- (i) What is meant by a design which enables the crew members to ‘manage errors’ is that:
- (A) the crew members must be able to detect and/or recover from errors resulting from their interaction with the equipment; or
 - (B) the effects of such crew member errors on the rotorcraft functions or capabilities must be evident to the crew members, and continued safe flight and landing must be possible; or
 - (C) crew member errors must be prevented by switch guards, interlocks, confirmation actions, or other effective means; or
 - (D) the effects of errors must be precluded by system logic or redundant, robust, or fault-tolerant system design.
- (ii) The objective to manage errors applies to those errors that can be reasonably expected in service from qualified and trained crews. The term ‘reasonably expected in service’ means errors that have occurred in service with similar or comparable equipment. It also means errors that can be predicted to occur based on general experience and knowledge of human performance capabilities and limitations related to the use of the type of controls, information, or system logic being assessed.
- (iii) [CS 29.1302\(d\)](#) includes the following statement: ‘This subparagraph does not apply to skill-related errors associated with the manual control of the rotorcraft.’ That statement is intended to exclude errors resulting from the crew’s proficiency in the control of the flight path and attitude with the primary roll, pitch, yaw and thrust controls, and which are related to the design of the flight control systems. These issues are considered to be adequately addressed by the existing certification specifications, such as CS-29 Subpart B and [CS 29.671\(a\)](#). It is not intended that the design should be required to compensate for deficiencies in crew training or experience. This assumes at least the minimum crew requirements for the intended operation, as discussed at the beginning of paragraph 5.1 above.
- (iv) This objective is intended to exclude the management of errors resulting from crew member decisions, acts or omissions that are not in good faith. It is intended to avoid imposing requirements on the design to accommodate errors committed with malicious or purely contrary intent. CS 29.1302 is not intended to require applicants to consider errors resulting from acts of violence or threats of violence. This ‘good faith’ exclusion is also intended to avoid imposing requirements on designs to accommodate errors due to a crew member’s obvious disregard for safety. However, it is recognised that errors committed intentionally may still be in

good faith, but could be influenced by the characteristics of the design under certain circumstances. An example would be a poorly designed procedure that is not compatible with the controls or information provided to the crew members.

Imposing requirements without considering their economic feasibility or the commensurate safety benefits should be avoided. Operational practicability should also be addressed, such as the need to avoid introducing error management features into the design that would inappropriately impede crew actions or decisions in normal, abnormal/malfunction and emergency conditions. For example, it is not intended to require so many guards or interlocks on the means to shut down an engine that the crew members would be unable to do this reliably within the available time. Similarly, it is not intended to reduce the authority or means for the crew to intervene or carry out an action when it is their responsibility to do so using their best judgment in good faith.

This subparagraph is included because managing errors (which can be reasonably expected in service) that result from crew member interactions with the equipment is an important safety objective. Even though the scope of applicability of this material is limited to errors for which there is a contribution from or a relationship to the design, CS 29.1302(d) is expected to result in design changes that will contribute to safety. One example, among others, would be the use of 'undo' functions in certain designs.

[Amdt 29/9]

GM2 29.1302 Examples of compliance matrices

ED Decision 2021/010/R

The compliance matrix developed by the applicant should provide the essential information in order to understand the relationship between the following elements:

- the design items,
- the applicable certification specifications,
- the test objectives,
- the means of compliance, and
- the deliverables.

The two matrices below are provided as examples only. The applicant might present the necessary information through any format that meets the above objectives.

An example with a *design item* entry:

Function	Sub-function	Focus	CS reference	CS description	Assessed dimension	MoC	Reference to the related deliverable
Electronic checklist (ECL) function	Display electronic checklist (ECL)	Electronic checklist quick access keys (ECL QAKs)	CS 29.777(a)	The cockpit controls must be: (a) located so in order to provide convenient operation and to prevent confusion and inadvertent operation;	Assess the ECL QAKs location for convenient operation and prevention of inadvertent operation.	MoC8 HFs campaign #2 Scenario #4	HFs Test Report XXX123
			CS29.777(b)	The cockpit controls must be: (b) located and arranged with respect to the pilot seats so that there is full and unrestricted movement of each control without interference from the cockpit structure or the pilot clothing when pilots from 1.57 m (5ft 2in) to 1.8 m (6 ft) in height are seated.	Assess accessibility to control the ECL QAKs.	MoC4 HFs Reachability Analysis MoC5 HFs Reachability and Accessibility Campaign	HFs Reachability and Accessibility Assessment Report XXX123
			[...]	[...]	[...]	[...]	[...]
			CS 29.1302(a)	All the controls and information necessary to accomplish these tasks must be provided;	Assess that appropriate controls are provided in order to display ECL.	MoC1 ECL implementation description for XXXX	ECL implementation description document for XXXX
			CS 29.1302(b)(1)	(b) All the controls and information required by paragraph (a), which are intended for use by the crew members, must:	Assess the appropriateness of the ECL QAKs labels.	MoC8 HFs campaign #4 Scenario #1	HFs Test Report XXX345

Function	Sub-function	Focus	CS reference	CS description	Assessed dimension	MoC	Reference to the related deliverable
				(1) be presented in a clear and unambiguous form, at a resolution and with a precision appropriate to the task;			

Another example with a *certification specification* entry:

CS reference	CS description	Focus	Assessed dimension	MoC	Reference to the related deliverable
CS 29.777(a)	The cockpit controls must be: (a) Located so in order to provide convenient operation and to prevent confusion and inadvertent operation;	All cockpit controls	Assess the locations of all cockpit controls for convenient operation and prevention of inadvertent operation.	MoC8 All HFs simulator evaluations	HFs Test Reports XXX123 XXX456 XXX789
		ECL QAKs	Assess the location of the ECL QAKs for convenient operation and prevention of inadvertent operation.	MoC8 HFs campaign #2 Scenario #4	HFs Test Report XXX123
CS 29.777(b)	The cockpit controls must be: (b) located and arranged with respect to the pilot seats so that there is full and unrestricted movement of each control without interference from the cockpit structure or the pilot clothing when pilots from 1.57 m (5ft 2in) to 1.8 m (6ft) in height are seated.	All cockpit controls	Assess the accessibility of all cockpit controls.	MoC4 HFs Reachability Analysis MoC5 HFs Reachability and Accessibility Campaign	HFs Reachability and Accessibility Assessment Report XXX123
		ECL QAKs	Assess the accessibility to control the ECL QAKs.	MoC4 HFs Reachability Analysis MoC5 HFs Reachability and Accessibility Campaign	HFs Reachability and Accessibility Assessment Report XXX123

[...]	[...]				
CS 29.1302(a)	All the controls and information necessary to accomplish these tasks must be provided;				
CS 29.1302(b) (1)	(b) All the controls and information required by paragraph (a), which are intended for use by the crew members, must: (1) be presented in a clear and unambiguous form, at a resolution and with a precision appropriate to the task;				

[Amdt 29/9]

CS 29.1303 Flight and navigation instruments

ED Decision 2003/16/RM

The following are required flight and navigational instruments:

- (a) An airspeed indicator. For Category A rotorcraft with V_{NE} less than a speed at which unmistakable pilot cues provide overspeed warning, a maximum allowable airspeed indicator must be provided. If maximum allowable airspeed varies with weight, altitude, temperature, or rpm, the indicator must show that variation.
- (b) A sensitive altimeter.
- (c) A magnetic direction indicator.
- (d) A clock displaying hours, minutes, and seconds with a sweep-second pointer or digital presentation.
- (e) A free-air temperature indicator.
- (f) A non-tumbling gyroscopic bank and pitch indicator.
- (g) A gyroscopic rate-of-turn indicator combined with an integral slip-skid indicator (turn-and-bank indicator) except that only a slip-skid indicator is required on rotorcraft with a third attitude instrument system that:
 - (1) Is usable through flight attitudes of $\pm 80^\circ$ of pitch and $\pm 120^\circ$ of roll;
 - (2) Is powered from a source independent of the electrical generating system;
 - (3) Continues reliable operation for a minimum of 30 minutes after total failure of the electrical generating system;
 - (4) Operates independently of any other attitude indicating system;
 - (5) Is operative without selection after total failure of the electrical generating system;
 - (6) Is located on the instrument panel in a position acceptable to the Agency that will make it plainly visible to and usable by any pilot at his station; and

- (7) Is appropriately lighted during all phases of operation.
- (h) A gyroscopic direction indicator.
- (i) A rate-of-climb (vertical speed) indicator.
- (j) For Category A rotorcraft, a speed warning device when V_{NE} is less than the speed at which unmistakable overspeed warning is provided by other pilot cues. The speed warning device must give effective aural warning (differing distinctly from aural warnings used for other purposes) to the pilots whenever the indicated speed exceeds V_{NE} plus 5.6 km/h (3 knots) and must operate satisfactorily throughout the approved range of altitudes and temperatures.

AMC 29.1303 Flight and navigation instruments

ED Decision 2018/015/R15/R

This AMC provides further guidance and acceptable means of compliance to supplement FAA AC 29-2C Change 7 AC 29.1303. § 29.1303 which is the EASA acceptable means of compliance, as provided for in [AMC 29 General](#). However, some aspects of the FAA AC are deemed by EASA to be at variance with EASA's interpretation or its regulatory system. EASA's interpretation of these aspects is described below. Paragraphs of FAA AC 29.1303. § 29.1303 that are not amended below are considered to be EASA acceptable means of compliance.

a. Explanation

[...]

- (2) For rotorcraft, loss of or misleading primary flight information (attitude, altitude, and airspeed) is considered to be a catastrophic failure condition in instrument meteorological conditions. For an attitude instrument to be usable, it should be capable of providing the pilot with reliable references to pitch and roll attitudes throughout the possible rotorcraft angular position and rotational operating ranges so that a pilot can correctly recognise the extent of the unusual or extreme attitude and initiate an appropriate recovery manoeuvre. As indicated previously in paragraph a., an ETSO approval does not ensure compliance with the CS-29 installation requirements, including those requirements in CS 29.1303(g)(1).
 - (i) The minimum usability requirements for the aircraft attitude systems are defined in CS 29.1303(g)(1). The phrase in CS 29.1303(g)(1) '...is usable through +/-80 degrees of pitch and +/-120 degrees of roll' means that the pilot should be able to quickly and accurately determine the aircraft's pitch attitudes up to 80 degrees nose up and 80 degrees nose down. The ADI should also allow the pilot to quickly and accurately determine the aircraft's roll attitude to 120 degrees of left and right roll.
 - (ii) The minimum usability requirement for the aircraft attitude system defined in CS 29.1303(g)(1) applies to all attitude systems installed in the aircraft. Attitude systems that do not meet the minimum usability requirements can provide misleading information to the pilot.

[Amdt No: 29/6]

CS 29.1305 Power plant instruments

ED Decision 2008/010/R

The following are required power plant instruments:

- (a) For each rotorcraft:
- (1) A carburettor air temperature indicator for each reciprocating engine;
 - (2) A cylinder head temperature indicator for each air-cooled reciprocating engine, and a coolant temperature indicator for each liquid-cooled reciprocating engine;
 - (3) A fuel quantity indicator for each fuel tank;
 - (4) A low fuel warning device for each fuel tank which feeds an engine. This device must:
 - (i) Provide a warning to the crew when approximately 10 minutes of usable fuel remains in the tank; and
 - (ii) Be independent of the normal fuel quantity indicating system.
 - (5) A manifold pressure indicator, for each reciprocating engine of the altitude type;
 - (6) An oil pressure indicator for each pressure-lubricated gearbox;
 - (7) An oil pressure warning device for each pressure-lubricated gearbox to indicate when the oil pressure falls below a safe value;
 - (8) An oil quantity indicator for each oil tank and each rotor drive gearbox, if lubricant is self-contained;
 - (9) An oil temperature indicator for each engine;
 - (10) An oil temperature warning device to indicate unsafe oil temperatures in each main rotor drive gearbox, including gearboxes necessary for rotor phasing;
 - (11) A gas temperature indicator for each turbine engine;
 - (12) A gas producer rotor tachometer for each turbine engine;
 - (13) A tachometer for each engine that, if combined with the applicable instrument required by sub-paragraph (a)(14), indicates rotor rpm during autorotation;
 - (14) At least one tachometer to indicate, as applicable:
 - (i) The rpm of the single main rotor;
 - (ii) The common rpm of any main rotors whose speeds cannot vary appreciably with respect to each other; and
 - (iii) The rpm of each main rotor whose speed can vary appreciably with respect to that of another main rotor;
 - (15) A free power turbine tachometer for each turbine engine;
 - (16) A means, for each turbine engine, to indicate power for that engine;
 - (17) For each turbine engine, an indicator to indicate the functioning of the power plant ice protection system;
 - (18) An indicator for the fuel filter required by [CS 29.997](#) to indicate the occurrence of contamination of the filter to the degree established in compliance with [CS 29.955](#);

-
- (19) For each turbine engine, a warning means for the oil strainer or filter required by [CS 29.1019](#), if it has no bypass, to warn the pilot of the occurrence of contamination of the strainer or filter before it reaches the capacity established in accordance with [CS 29.1019\(a\)\(2\)](#);
 - (20) An indicator to indicate the functioning of any selectable or controllable heater used to prevent ice clogging of fuel system components;
 - (21) An individual fuel pressure indicator for each engine, unless the fuel system which supplies that engine does not employ any pumps, filters, or other components subject to degradation or failure which may adversely affect fuel pressure at the engine;
 - (22) A means to indicate to the flight crew the failure of any fuel pump installed to show compliance with [CS 29.955](#);
 - (23) Warning or caution devices to signal to the flight crew when ferromagnetic particles are detected by the chip detector required by [CS 29.1337\(e\)](#); and
 - (24) For auxiliary power units, an individual indicator, warning or caution device, or other means to advise the flight crew that limits are being exceeded, if exceeding these limits can be hazardous, for:
 - (i) Gas temperature;
 - (ii) Oil pressure; and
 - (iii) Rotor speed.
 - (25) For rotorcraft for which a 30-second/2-minute OEI power rating is requested, a means must be provided to alert the pilot when the engine is at the 30-second and 2-minute OEI power levels, when the event begins, and when the time interval expires.
 - (26) For each turbine engine utilising 30-second/2-minute OEI power, a device or system must be provided for use by ground personnel which:
 - (i) Automatically records each usage and duration of power at the 30-second and 2-minute OEI levels;
 - (ii) Permits retrieval of the recorded data;
 - (iii) Can be reset only by ground maintenance personnel; and
 - (iv) Has a means to verify proper operation of the system or device.
- (b) For Category A rotorcraft:
- (1) An individual oil pressure indicator for each engine, and either an independent warning device for each engine or a master warning device for the engines with means for isolating the individual warning circuit from the master warning device;
 - (2) An independent fuel pressure warning device for each engine or a master warning device for all engines with provision for isolating the individual warning device from the master warning device; and
 - (3) Fire warning indicators.

- (c) For Category B rotorcraft:
- (1) An individual oil pressure indicator for each engine; and
 - (2) Fire warning indicators, when fire detection is required.

[Amdt. No. 29/2]

CS 29.1307 Miscellaneous equipment

ED Decision 2003/16/RM

The following is required miscellaneous equipment:

- (a) An approved seat for each occupant.
- (b) A master switch arrangement for electrical circuits other than ignition.
- (c) Hand fire extinguishers.
- (d) A windshield wiper or equivalent device for each pilot station.
- (e) A two-way radio communication system.

CS 29.1309 Equipment, systems, and installations

ED Decision 2016/025/R

- (a) The equipment, systems, and installations whose functioning is required by this CS-29 must be designed and installed to ensure that they perform their intended functions under any foreseeable operating condition.
- (b) The rotorcraft systems and associated components, considered separately and in relation to other systems, must be designed so that –
 - (1) For Category B rotorcraft, the equipment, systems, and installations must be designed to prevent hazards to the rotorcraft if they malfunction or fail; or
 - (2) For Category A rotorcraft:
 - (i) The occurrence of any failure condition which would prevent the continued safe flight and landing of the rotorcraft is extremely improbable; and
 - (ii) The occurrence of any other failure conditions which would reduce the capability of the rotorcraft or the ability of the crew to cope with adverse operating conditions is improbable.
- (c) Warning information must be provided to alert the crew to unsafe system operating conditions and to enable them to take appropriate corrective action. Systems, controls, and associated monitoring and warning means must be designed to minimise crew errors which could create additional hazards.
- (d) Compliance with the requirements of sub-paragraph (b)(2) must be shown by analysis and, where necessary, by appropriate ground, flight, or simulator tests. The analysis must consider:
 - (1) Possible modes of failure, including malfunctions and damage from external sources;
 - (2) The probability of multiple failures and undetected failures;
 - (3) The resulting effects on the rotorcraft and occupants, considering the stage of flight and operating conditions; and
 - (4) The crew warning cues, corrective action required, and the capability of detecting faults.

- (e) For Category A rotorcraft, each installation whose functioning is required by this CS-29 and which requires a power supply is an ‘essential load’ on the power supply. The power sources and the system must be able to supply the following power loads in probable operating combinations and for probable durations:
- (1) Loads connected to the system with the system functioning normally.
 - (2) Essential loads, after failure of any one prime mover, power converter, or energy storage device.
 - (3) Essential loads, after failure of:
 - (i) Any one engine, on rotorcraft with two engines; and
 - (ii) Any two engines, on rotorcraft with three or more engines.
- (f) In determining compliance with sub-paragraphs (e)(2) and (3), the power loads may be assumed to be reduced under a monitoring procedure consistent with safety in the kinds of operations authorised. Loads not required for controlled flight need not be considered for the two-engine-inoperative condition on rotorcraft with three or more engines.
- (g) In showing compliance with sub-paragraphs (a) and (b) with regard to the electrical system and to equipment design and installation, critical environmental conditions must be considered. For electrical generation, distribution and utilisation equipment required by or used in complying with this CS-29, except equipment covered by European Technical Standard Orders containing environmental test procedures, the ability to provide continuous, safe service under foreseeable environmental conditions may be shown by environmental tests, design analysis, or reference to previous comparable service experience on other aircraft.

[Amdt 29/4]

CS 29.1316 Electrical and electronic system lightning protection

ED Decision 2016/025/R

- (a) Each electrical and electronic system that performs a function whose failure would prevent the continued safe flight and landing of the rotorcraft, must be designed and installed in a way that:
- (1) the function is not adversely affected during and after the time the rotorcraft’s exposure to lightning; and
 - (2) the system automatically recovers normal operation of that function, in a timely manner, after the rotorcraft’s exposure to lightning, unless the system’s recovery conflicts with other operational or functional requirements of the system that would prevent continued safe flight and landing of the rotorcraft.
- (b) For rotorcraft approved for instrument flight rules operation, each electrical and electronic system that performs a function whose failure would reduce the capability of the rotorcraft or the ability of the flight crew to respond to an adverse operating condition, must be designed and installed in a way that the function recovers normal operation in a timely manner after the rotorcraft’s exposure to lightning.

[Amdt 29/4]

CS 29.1317 High-Intensity Radiated Fields (HIRF) protection

ED Decision 2016/025/R

- (a) Each electrical and electronic system that performs a function whose failure would prevent the continued safe flight and landing of the rotorcraft, must be designed and installed in a way that:
- (1) the function is not adversely affected during and after the time the rotorcraft's exposure to HIRF environment I as described in [Appendix E](#);
 - (2) the system automatically recovers normal operation of that function, in a timely manner after the rotorcraft's exposure to a HIRF environment I as described in Appendix E unless the system's recovery conflicts with other operational or functional requirements of the system that would prevent continued safe flight and landing of the rotorcraft;
 - (3) the system is not adversely affected during and after the time the rotorcraft's exposure to a HIRF environment II as described in [Appendix E](#); and
 - (4) each function required during operation under visual flight rules is not adversely affected during and after the time the rotorcraft's exposure to a HIRF environment III as described in [Appendix E](#).
- (b) Each electrical and electronic system that performs a function whose failure would significantly reduce the capability of the rotorcraft or the ability of the flight crew to respond to an adverse operating condition must be designed and installed in a way that the system is not adversely affected when the equipment providing the function is exposed to equipment HIRF test level 1 or 2, as described in [Appendix E](#).
- (c) Each electrical and electronic system that performs a function whose failure would reduce the capability of the rotorcraft or the ability of the flight crew to respond to an adverse operating condition must be designed and installed in a way that the system is not adversely affected when the equipment providing the function is exposed to equipment HIRF test level 3, as described in [Appendix E](#).

[Amdt 29/4]

Appendix E – HIRF Environments and Equipment HIRF Test Levels

ED Decision 2016/025/R

This Appendix specifies the HIRF environments and equipment HIRF test levels for electrical and electronic systems under [CS 29.1317](#). The field strength values for the HIRF environments and equipment HIRF test levels are expressed in root-mean-square units measured during the peak of the modulation cycle.

- (a) HIRF environment I is specified in the following table:

Table 1 — HIRF Environment I

FREQUENCY	FIELD STRENGTH (V/m)	
	PEAK	AVERAGE
10 kHz–2 MHz	50	50
2–30 MHz	100	100
30–100 MHz	50	50
100–400 MHz	100	100
400–700 MHz	700	50
700 MHz–1 GHz	700	100
1–2 GHz	2000	200

FREQUENCY	FIELD STRENGTH (V/m)	
	PEAK	AVERAGE
2–6 GHz	3000	200
6–8 GHz	1000	200
8–12 GHz	3000	300
12–18 GHz	2000	200
18–40 GHz	600	200

In this table, the higher field strength applies to the frequency band edges.

- (b) HIRF environment II is specified in the following table:

Table II — HIRF Environment II

FREQUENCY	FIELD STRENGTH (V/m)	
	PEAK	AVERAGE
10–500 kHz	20	20
500 kHz–2 MHz	30	30
2–30 MHz	100	100
30–100 MHz	10	10
100–200 MHz	30	10
200–400 MHz	10	10
400 MHz–1 GHz	700	40
1–2 GHz	1300	160
2–4 GHz	3000	120
4–6 GHz	3000	160
6–8 GHz	400	170
8–12 GHz	1230	230
12–18 GHz	730	190
18–40 GHz	600	150

In this table, the higher field strength applies to the frequency band edges.

- (c) HIRF environment III is specified in the following table:

Table III — HIRF Environment III

FREQUENCY	FIELD STRENGTH (V/m)	
	PEAK	AVERAGE
10–100 kHz	150	150
100 kHz–400 MHz	200	200
400–700 MHz	730	200
700 MHz–1 GHz	1400	240
1–2 GHz	5000	250
2–4 GHz	6000	490
4–6 GHz	7200	400
6–8 GHz	1100	170
8–12 GHz	5000	330
12–18 GHz	2000	330
18–40 GHz	1000	420

In this table, the higher field strength applies at the frequency band edges.

(d) Equipment HIRF Test Level 1

- (1) From 10 kilohertz (kHz) to 400 megahertz (MHz), use conducted susceptibility tests with continuous wave (CW) and 1 kHz square wave modulation with 90 % depth or greater. The conducted susceptibility current must start at a minimum of 0.6 milliamperes (mA) at 10 kHz, increasing 20 decibels (dB) per frequency decade to a minimum of 30 mA at 500 kHz.
- (2) From 500 kHz to 40 MHz, the conducted susceptibility current must be at least 30 mA.
- (3) From 40 MHz to 400 MHz, use conducted susceptibility tests, starting at a minimum of 30 mA at 40 MHz, decreasing 20 dB per frequency decade to a minimum of 3 mA at 400 MHz.
- (4) From 100 MHz to 400 MHz, use radiated susceptibility tests at a minimum of 20 volts per meter (V/m) peak with CW and 1 kHz square wave modulation with 90 % depth or greater.
- (5) From 400 MHz to 8 gigahertz (GHz), use radiated susceptibility tests at a minimum of 150 V/m peak with pulse modulation of 4 % duty cycle with a 1 kHz pulse repetition frequency. This signal must be switched on and off at a rate of 1 Hz with a duty cycle of 50 %.

(e) Equipment HIRF Test Level 2. Equipment HIRF Test Level 2 is HIRF environment II in Table II of this Appendix reduced by acceptable aircraft transfer function and attenuation curves. Testing must cover the frequency band of 10 kHz to 8 GHz.

(f) Equipment HIRF Test Level 3

- (1) From 10 kHz to 400 MHz, use conducted susceptibility tests, starting at a minimum of 0.15 mA at 10 kHz, increasing 20 dB per frequency decade to a minimum of 7.5 mA at 500 kHz.
- (2) From 500 kHz to 40 MHz, use conducted susceptibility tests at a minimum of 7.5 mA.
- (3) From 40 MHz to 400 MHz, use conducted susceptibility tests, starting at a minimum of 7.5 mA at 40 MHz, decreasing 20 dB per frequency decade to a minimum of 0.75 mA at 400 MHz.
- (4) From 100 MHz to 8 GHz, use radiated susceptibility tests at a minimum of 5 V/m.

[Amdt 29/4]

CS 29.1319 Equipment, systems and network information security protection

ED Decision 2020/006/R

- (a) Rotorcraft equipment, systems and networks, considered separately and in relation to other systems, must be protected from intentional unauthorised electronic interactions (IUEIs) that may result in adverse effects on the safety of the rotorcraft. Protection must be ensured by showing that the security risks have been identified, assessed and mitigated as necessary.
- (b) When required by paragraph (a), the applicant must make procedures and Instructions for Continued Airworthiness (ICA) available that ensure that the security protections of the rotorcraft equipment, systems and networks are maintained.

[Amdt No: 29/8]

AMC 29.1319 Equipment, systems and network information security protection

ED Decision 2020/006/R

In showing compliance with [CS 29.1319](#), the applicant may consider AMC 20-42, which provides acceptable means, guidance and methods to perform security risk assessments and mitigation for aircraft information systems.

The term ‘mitigated as necessary’ clarifies that the applicant has the discretion to establish appropriate means of mitigation against security risks.

[Amdt No: 29/8]

INSTRUMENTS: INSTALLATION

CS 29.1321 Arrangement and visibility

ED Decision 2003/16/RM

- (a) Each flight, navigation, and powerplant instrument for use by any pilot must be easily visible to him from his station with the minimum practicable deviation from his normal position and line of vision when he is looking forward along the flight path.
- (b) Each instrument necessary for safe operation, including the airspeed indicator, gyroscopic direction indicator, gyroscopic bank-and-pitch indicator, slip-skid indicator, altimeter, rate-of-climb indicator, rotor tachometers, and the indicator most representative of engine power, must be grouped and centred as nearly as practicable about the vertical plane of the pilot's forward vision. In addition, for rotorcraft approved for IFR flight:
 - (1) The instrument that most effectively indicates attitude must be on the panel in the top centre position;
 - (2) The instrument that most effectively indicates direction of flight must be adjacent to and directly below the attitude instrument;
 - (3) The instrument that most effectively indicates airspeed must be adjacent to and to the left of the attitude instrument; and
 - (4) The instrument that most effectively indicates altitude or is most frequently utilised in control of altitude must be adjacent to and to the right of the attitude instrument.
- (c) Other required powerplant instruments must be closely grouped on the instrument panel.
- (d) Identical powerplant instruments for the engines must be located so as to prevent any confusion as to which engine each instrument relates.
- (e) Each powerplant instrument vital to safe operation must be plainly visible to appropriate crew members.
- (f) Instrument panel vibration may not damage, or impair the readability or accuracy of, any instrument.
- (g) If a visual indicator is provided to indicate malfunction of an instrument, it must be effective under all probable cockpit lighting conditions.

CS 29.1322 Warning, caution, and advisory lights

ED Decision 2003/16/RM

If warning, caution or advisory lights are installed in the cockpit they must, unless otherwise approved by the Agency, be:

- (a) Red, for warning lights (lights indicating a hazard which may require immediate corrective action);
- (b) Amber, for caution lights (lights indicating the possible need for future corrective action);
- (c) Green, for safe operation lights; and
- (d) Any other colour, including white, for lights not described in sub-paragraphs (a) to (c), provided the colour differs sufficiently from the colours prescribed in sub-paragraphs (a) to (c) to avoid possible confusion.

CS 29.1323 Airspeed indicating system

ED Decision 2003/16/RM

For each airspeed indicating system, the following apply:

- (a) Each airspeed indicating instrument must be calibrated to indicate true airspeed (at sea-level with a standard atmosphere) with a minimum practicable instrument calibration error when the corresponding pitot and static pressures are applied.
- (b) Each system must be calibrated to determine system error excluding airspeed instrument error. This calibration must be determined:
 - (1) In level flight at speeds of 37 km/h (20 knots) and greater, and over an appropriate range of speeds for flight conditions of climb and autorotation; and
 - (2) During take-off, with repeatable and readable indications that ensure:
 - (i) Consistent realisation of the field lengths specified in the Rotorcraft Flight Manual; and
 - (ii) Avoidance of the critical areas of the height-velocity envelope as established under [CS 29.87](#).
- (c) For Category A rotorcraft:
 - (1) The indication must allow consistent definition of the take-off decision point; and
 - (2) The system error, excluding the airspeed instrument calibration error, may not exceed –
 - (i) 3% or 9.3 km/h (5 knots), whichever is greater, in level flight at speeds above 80% of take-off safety speed; and
 - (ii) 19 km/h (10 knots) in climb at speeds from 19 km/h (10 knots) below take-off safety speed to 19 km/h (10 knots) above V_Y .
- (d) For Category B rotorcraft, the system error, excluding the airspeed instrument calibration error, may not exceed 3% or 9.3 km/h (5 knots), whichever is greater, in level flight at speeds above 80% of the climbout speed attained at 15 m (50 ft) when complying with [CS 29.63](#).
- (e) Each system must be arranged, so far as practicable, to prevent malfunction or serious error due to the entry of moisture, dirt, or other substances.
- (f) Each system must have a heated pitot tube or an equivalent means of preventing malfunction due to icing.

CS 29.1325 Static pressure and pressure altimeter systems

ED Decision 2003/16/RM

- (a) Each instrument with static air case connections must be vented to the outside atmosphere through an appropriate piping system.
- (b) Each vent must be located where its orifices are least affected by airflow variation, moisture, or other foreign matter.
- (c) Each static pressure port must be designed and located in such manner that the correlation between air pressure in the static pressure system and true ambient atmospheric static pressure is not altered when the rotorcraft encounters icing conditions. An anti-icing means or an alternate source of static pressure may be used in showing compliance with this requirement.

If the reading of the altimeter, when on the alternate static pressure system, differs from the reading of the altimeter when on the primary static system by more than 15 m (50 ft), a correction card must be provided for the alternate static system.

- (d) Except for the vent into the atmosphere, each system must be airtight.
- (e) Each pressure altimeter must be approved and calibrated to indicate pressure altitude in a standard atmosphere with a minimum practicable calibration error when the corresponding static pressures are applied.
- (f) Each system must be designed and installed so that an error in indicated pressure altitude, at sea-level, with a standard atmosphere, excluding instrument calibration error, does not result in an error of more than ± 9 m (± 30 ft) per 185 km/h (100 knots) speed. However, the error need not be less than ± 9 m (± 30 ft).
- (g) Except as provided in sub-paragraph (h) if the static pressure system incorporates both a primary and an alternate static pressure source, the means for selecting one or the other source must be designed so that:
 - (1) When either source is selected, the other is blocked off; and
 - (2) Both sources cannot be blocked off simultaneously.
- (h) For unpressurised rotorcraft, sub-paragraph (g)(1) does not apply if it can be demonstrated that the static pressure system calibration, when either static pressure source is selected, is not changed by the other static pressure source being open or blocked.

CS 29.1327 Magnetic direction indicator

ED Decision 2003/16/RM

- (a) Each magnetic direction indicator must be installed so that its accuracy is not excessively affected by the rotorcraft's vibration or magnetic fields.
- (b) The compensated installation may not have a deviation, in level flight, greater than 10° on any heading.

CS 29.1329 Automatic pilot system

ED Decision 2003/16/RM

- (a) Each automatic pilot system must be designed so that the automatic pilot can:
 - (1) Be sufficiently overpowered by one pilot to allow control of the rotorcraft; and
 - (2) Be readily and positively disengaged by each pilot to prevent it from interfering with the control of the rotorcraft.
- (b) Unless there is automatic synchronisation, each system must have a means to readily indicate to the pilot the alignment of the actuating device in relation to the control system it operates.
- (c) Each manually operated control for the system's operation must be readily accessible to the pilots.
- (d) The system must be designed and adjusted so that, within the range of adjustment available to the pilot, it cannot produce hazardous loads on the rotorcraft, or create hazardous deviations in the flight path, under any flight condition appropriate to its use, either during normal operation or in the event of a malfunction, assuming that corrective action begins within a reasonable period of time.

- (e) If the automatic pilot integrates signals from auxiliary controls or furnishes signals for operation of other equipment, there must be positive interlocks and sequencing of engagement to prevent improper operation.
- (f) If the automatic pilot system can be coupled to airborne navigation equipment, means must be provided to indicate to the pilots the current mode of operation. Selector switch position is not acceptable as a means of indication.

CS 29.1331 Instruments using a power supply

ED Decision 2003/16/RM

For Category A rotorcraft:

- (a) Each required flight instrument using a power supply must have –
 - (1) Two independent sources of power;
 - (2) A means of selecting either power source; and
 - (3) A visual means integral with each instrument to indicate when the power adequate to sustain proper instrument performance is not being supplied. The power must be measured at or near the point where it enters the instrument. For electrical instruments, the power is considered to be adequate when the voltage is within approved limits; and
- (b) The installation and power supply system must be such that failure of any flight instrument connected to one source, or of the energy supply from one source, or a fault in any part of the power distribution system does not interfere with the proper supply of energy from any other source.

CS 29.1333 Instrument systems

ED Decision 2003/16/RM

For systems that operate the required flight instruments which are located at each pilot's station, the following apply:

- (a) Only the required flight instruments for the first pilot may be connected to that operating system.
- (b) The equipment, systems, and installations must be designed so that one display of the information essential to the safety of flight which is provided by the flight instruments remains available to a pilot, without additional crew member action, after any single failure or combination of failures that are not shown to be extremely improbable.
- (c) Additional instruments, systems, or equipment may not be connected to the operating system for a second pilot unless provisions are made to ensure the continued normal functioning of the required flight instruments in the event of any malfunction of the additional instruments, systems, or equipment which is not shown to be extremely improbable.

CS 29.1335 Flight director systems

ED Decision 2003/16/RM

If a flight director system is installed, means must be provided to indicate to the flight crew its current mode of operation. Selector switch position is not acceptable as a means of indication.

CS 29.1337 Powerplant instruments

ED Decision 2003/16/RM

- (a) *Instruments and instrument lines*
- (1) Each powerplant and auxiliary power unit instrument line must meet the requirements of [CS 29.993](#) and [29.1183](#).
 - (2) Each line carrying flammable fluids under pressure must:
 - (i) Have restricting orifices or other safety devices at the source of pressure to prevent the escape of excessive fluid if the line fails; and
 - (ii) Be installed and located so that the escape of fluids would not create a hazard.
 - (3) Each power plant and auxiliary power unit instrument that utilises flammable fluids must be installed and located so that the escape of fluid would not create a hazard.
- (b) *Fuel quantity indicator.* There must be means to indicate to the flight-crew members the quantity, in US-gallons or equivalent units, of usable fuel in each tank during flight. In addition:
- (1) Each fuel quantity indicator must be calibrated to read ‘zero’ during level flight when the quantity of fuel remaining in the tank is equal to the unusable fuel supply determined under [CS 29.959](#);
 - (2) When two or more tanks are closely interconnected by a gravity feed system and vented, and when it is impossible to feed from each tank separately, at least one fuel quantity indicator must be installed;
 - (3) Tanks with interconnected outlets and airspaces may be treated as one tank and need not have separate indicators; and
 - (4) Each exposed sight gauge used as a fuel quantity indicator must be protected against damage.
- (c) *Fuel flowmeter system.* If a fuel flowmeter system is installed, each metering component must have a means for bypassing the fuel supply if malfunction of that component severely restricts fuel flow.
- (d) *Oil quantity indicator.* There must be a stick gauge or equivalent means to indicate the quantity of oil:
- (1) In each tank; and
 - (2) In each transmission gearbox.
- (e) Rotor drive system transmissions and gearboxes utilising ferromagnetic materials must be equipped with chip detectors designed to indicate the presence of ferromagnetic particles resulting from damage or excessive wear within the transmission or gearbox. Each chip detector must:
- (1) Be designed to provide a signal to the indicator required by [CS 29.1305\(a\)\(23\)](#); and
 - (2) Be provided with a means to allow crew members to check, in flight, the function of each detector electrical circuit and signal.

ELECTRICAL SYSTEMS AND EQUIPMENT

CS 29.1351 General

ED Decision 2003/16/RM

- (a) *Electrical system capacity.* The required generating capacity and the number and kind of power sources must:
- (1) Be determined by an electrical load analysis; and
 - (2) Meet the requirements of [CS 29.1309](#).
- (b) *Generating system.* The generating system includes electrical power sources, main power busses, transmission cables, and associated control, regulation, and protective devices. It must be designed so that:
- (1) Power sources function properly when independent and when connected in combination;
 - (2) No failure or malfunction of any power source can create a hazard or impair the ability of remaining sources to supply essential loads;
 - (3) The system voltage and frequency (as applicable) at the terminals of essential load equipment can be maintained within the limits for which the equipment is designed, during any probable operating condition;
 - (4) System transients due to switching, fault clearing, or other causes do not make essential loads inoperative, and do not cause a smoke or fire hazard;
 - (5) There are means accessible in flight to appropriate crew members for the individual and collective disconnection of the electrical power sources from the main bus; and
 - (6) There are means to indicate to appropriate crew members the generating system quantities essential for the safe operation of the system, such as the voltage and current supplied by each generator.
- (c) *External power.* If provisions are made for connecting external power to the rotorcraft, and that external power can be electrically connected to equipment other than that used for engine starting, means must be provided to ensure that no external power supply having a reverse polarity, or a reverse phase sequence, can supply power to the rotorcraft's electrical system.
- (d) *Operation with the normal electrical power generating system inoperative.*
- (1) It must be shown by analysis, tests, or both, that the rotorcraft can be operated safely in VFR conditions, for a period of not less than five minutes, with the normal electrical power generating system inoperative, with critical type fuel (from the stand-point of flameout and restart capability), and with the rotorcraft initially at the maximum certificated altitude. Parts of the electrical system may remain on if:
 - (i) A single malfunction, including a wire bundle or junction box fire, cannot result in loss of the part turned off and the part turned on; and
 - (ii) The parts turned on are electrically and mechanically isolated from the parts turned off.

- (2) Additional requirements for Category A Rotorcraft
 - (i) Unless it can be shown that the loss of the normal electrical power generating system is extremely improbable, an emergency electrical power system, independent of the normal electrical power generating system, must be provided with sufficient capacity to power all systems necessary for continued safe flight and landing.
 - (ii) Failures, including junction box, control panel or wire bundle fires, which would result in the loss of the normal and emergency systems must be shown to be extremely improbable.
 - (iii) Systems necessary for immediate safety must continue to operate following the loss of the normal electrical power generating system, without the need for flight crew action.

CS 29.1353 Electrical equipment and installations

ED Decision 2003/16/RM

- (a) Electrical equipment, controls, and wiring must be installed so that operation of any one unit or system of units will not adversely affect the simultaneous operation of any other electrical unit or system essential to safe operation.
- (b) Cables must be grouped, routed, and spaced so that damage to essential circuits will be minimised if there are faults in heavy current-carrying cables.
- (c) Storage batteries must be designed and installed as follows:
 - (1) Safe cell temperatures and pressures must be maintained during any probable charging and discharging condition. No uncontrolled increase in cell temperature may result when the battery is recharged (after previous complete discharge):
 - (i) At maximum regulated voltage or power;
 - (ii) During a flight of maximum duration; and
 - (iii) Under the most adverse cooling condition likely in service.
 - (2) Compliance with sub-paragraph (c)(1) must be shown by test unless experience with similar batteries and installations has shown that maintaining safe cell temperatures and pressures presents no problem.
 - (3) No explosive or toxic gases emitted by any battery in normal operation, or as the result of any probable malfunction in the charging system or battery installation, may accumulate in hazardous quantities within the rotorcraft.
 - (4) No corrosive fluids or gases that may escape from the battery may damage surrounding structures or adjacent essential equipment.
 - (5) Each nickel cadmium battery installation capable of being used to start an engine or auxiliary power unit must have provisions to prevent any hazardous effect on structure or essential systems that may be caused by the maximum amount of heat the battery can generate during a short circuit of the battery or of its individual cells.

- (6) Nickel cadmium battery installations capable of being used to start an engine or auxiliary power unit must have:
- (i) A system to control the charging rate of the battery automatically so as to prevent battery overheating;
 - (ii) A battery temperature sensing and over-temperature warning system with a means for disconnecting the battery from its charging source in the event of an over- temperature condition; or
 - (iii) A battery failure sensing and warning system with a means for disconnecting the battery from its charging source in the event of battery failure.

CS 29.1355 Distribution system

ED Decision 2003/16/RM

- (a) The distribution system includes the distribution busses, their associated feeders, and each control and protective device.
- (b) If two independent sources of electrical power for particular equipment or systems are required by any applicable CS or operating rule, in the event of the failure of one power source for such equipment or system, another power source (including its separate feeder) must be provided automatically or be manually selectable to maintain equipment or system operation.

CS 29.1357 Circuit protective devices

ED Decision 2003/16/RM

- (a) Automatic protective devices must be used to minimise distress to the electrical system and hazard to the rotorcraft in the event of wiring faults or serious malfunction of the system or connected equipment.
- (b) The protective and control devices in the generating system must be designed to de-energise and disconnect faulty power sources and power transmission equipment from their associated busses with sufficient rapidity to provide protection from hazardous overvoltage and other malfunctioning.
- (c) Each resettable circuit protective device must be designed so that, when an overload or circuit fault exists, it will open the circuit regardless of the position of the operating control.
- (d) If the ability to reset a circuit breaker or replace a fuse is essential to safety in flight, that circuit breaker or fuse must be located and identified so that it can be readily reset or replaced in flight.
- (e) Each essential load must have individual circuit protection. However, individual protection for each circuit in an essential load system (such as each position light circuit in a system) is not required.
- (f) If fuses are used, there must be spare fuses for use in flight equal to at least 50% of the number of fuses of each rating required for complete circuit protection.
- (g) Automatic reset circuit breakers may be used as integral protectors for electrical equipment provided there is circuit protection for the cable supplying power to the equipment.

CS 29.1359 Electrical system fire and smoke protection

ED Decision 2003/16/RM

- (a) Components of the electrical system must meet the applicable fire and smoke protection provisions of [CS 29.831](#) and [29.863](#).
- (b) Electrical cables, terminals, and equipment, in designated fire zones, and that are used in emergency procedures, must be at least fire resistant.
- (c) Insulation on electrical wire and cable installed in the rotorcraft must be self-extinguishing when tested in accordance with CS-25, Appendix F, Part I (a)(3).

CS 29.1363 Electrical system tests

ED Decision 2003/16/RM

- (a) When laboratory tests of the electrical system are conducted:
 - (1) The tests must be performed on a mock-up using the same generating equipment used in the rotorcraft;
 - (2) The equipment must simulate the electrical characteristics of the distribution wiring and connected loads to the extent necessary for valid test results; and
 - (3) Laboratory generator drives must simulate the prime movers on the rotorcraft with respect to their reaction to generator loading, including loading due to faults.
- (b) For each flight condition that cannot be simulated adequately in the laboratory or by ground tests on the rotorcraft, flight tests must be made.

LIGHTS

CS 29.1381 Instrument lights

ED Decision 2003/16/RM

The instrument lights must:

- (a) Make each instrument, switch, and other device for which they are provided easily readable; and
- (b) Be installed so that:
 - (1) Their direct rays are shielded from the pilot's eyes; and
 - (2) No objectionable reflections are visible to the pilot.

CS 29.1383 Landing lights

ED Decision 2003/16/RM

- (a) Each required landing or hovering light must be approved.
- (b) Each landing light must be installed so that:
 - (1) No objectionable glare is visible to the pilot;
 - (2) The pilot is not adversely affected by halation; and
 - (3) It provides enough light for night operation, including hovering and landing.
- (c) At least one separate switch must be provided, as applicable:
 - (1) For each separately installed landing light; and
 - (2) For each group of landing lights installed at a common location.

CS 29.1385 Position light system installation

ED Decision 2003/16/RM

- (a) *General.* Each part of each position light system must meet the applicable requirements of this paragraph and each system as a whole must meet the requirements of [CS 29.1387](#) to [29.1397](#).
- (b) *Forward position lights.* Forward position lights must consist of a red and a green light spaced laterally as far apart as practicable and installed forward on the rotorcraft so that, with the rotorcraft in the normal flying position, the red light is on the left side, and the green light is on the right side. Each light must be approved.
- (c) *Rear position light.* The rear position light must be a white light mounted as far aft as practicable, and must be approved.
- (d) *Circuit.* The two forward position lights and the rear position light must make a single circuit.
- (e) *Light covers and colour filters.* Each light cover or colour filter must be at least flame resistant and may not change colour or shape or lose any appreciable light transmission during normal use.

CS 29.1387 Position light system dihedral angles

ED Decision 2003/16/RM

- (a) Except as provided in sub-paragraph (e), each forward and rear position light must, as installed, show unbroken light within the dihedral angles described in this paragraph.
- (b) Dihedral angle L (left) is formed by two intersecting vertical planes, the first parallel to the longitudinal axis of the rotorcraft, and the other at 110° to the left of the first, as viewed when looking forward along the longitudinal axis.
- (c) Dihedral angle R (right) is formed by two intersecting vertical planes, the first parallel to the longitudinal axis of the rotorcraft, and the other at 110° to the right of the first, as viewed when looking forward along the longitudinal axis.
- (d) Dihedral angle A (aft) is formed by two intersecting vertical planes making angles of 70° to the right and to the left, respectively, to a vertical plane passing through the longitudinal axis, as viewed when looking aft along the longitudinal axis.
- (e) If the rear position light, when mounted as far aft as practicable in accordance with [CS 29.1385\(c\)](#), cannot show unbroken light within dihedral angle A (as defined in sub-paragraph (d)), a solid angle or angles of obstructed visibility totalling not more than 0.04 steradians is allowable within that dihedral angle, if such solid angle is within a cone whose apex is at the rear position light and whose elements make an angle of 30° with a vertical line passing through the rear position light.

CS 29.1389 Position light distribution and intensities

ED Decision 2003/16/RM

- (a) *General.* The intensities prescribed in this paragraph must be provided by new equipment with light covers and colour filters in place. Intensities must be determined with the light source operating at a steady value equal to the average luminous output of the source at the normal operating voltage of the rotorcraft. The light distribution and intensity of each position light must meet the requirements of sub-paragraph (b).
- (b) *Forward and rear position lights.* The light distribution and intensities of forward and rear position lights must be expressed in terms of minimum intensities in the horizontal plane, minimum intensities in any vertical plane, and maximum intensities in overlapping beams, within dihedral angles, L, R and A, and must meet the following requirements:
 - (1) *Intensities in the horizontal plane.* Each intensity in the horizontal plane (the plane containing the longitudinal axis of the rotorcraft and perpendicular to the plane of symmetry of the rotorcraft), must equal or exceed the values in [CS 29.1391](#).
 - (2) *Intensities in the vertical plane.* Each intensity in any vertical plane (the plane perpendicular to the horizontal plane) must equal or exceed the appropriate value in [CS 29.1393](#) where I is the minimum intensity prescribed in [CS 29.1391](#) for the corresponding angles in the horizontal plane.
 - (3) *Intensities in overlaps between adjacent signals.* No intensity in any overlap between adjacent signals may exceed the values in [CS 29.1395](#), except that higher intensities in overlaps may be used with the use of main beam intensities substantially greater than the minima specified in [CS 29.1391](#) and [29.1393](#) if the overlap intensities in relation to the main beam intensities do not adversely affect signal clarity.

CS 29.1391 Minimum intensities in the horizontal plane of forward and rear position lights

ED Decision 2003/16/RM

Each position light intensity must equal or exceed the applicable values in the following table:

Dihedral angle (light included)	Angle from right or left of longitudinal axis, measured from dead ahead	Intensity (candelas)
L and R (forward red and green)	0° to 10°	40
	10° to 20°	30
	20° to 110°	5
A (rear white)	110° to 180°	20

CS 29.1393 Minimum intensities in any vertical plane of forward and rear position lights

ED Decision 2003/16/RM

Each position light intensity must equal or exceed the applicable values in the following table:

Angle above or below the horizontal plane	Intensity
0°	1.00 I
0° to 5°	0.90 I
5° to 10°	0.80 I
10° to 15°	0.70 I
15° to 20°	0.50 I
20° to 30°	0.30 I
30° to 40°	0.10 I
40° to 90°	0.05 I

CS 29.1395 Maximum intensities in overlapping beams of forward and rear position lights

ED Decision 2003/16/RM

No position light intensity may exceed the applicable values in the following table, except as provided in [CS 29.1389\(b\)\(3\)](#):

Overlaps	Maximum intensity	
	Area A (candelas)	Area B (candelas)
Green in dihedral angle L	10	1
Red in dihedral angle R	10	1
Green in dihedral angle A	5	1
Red in dihedral angle A	5	1
Rear white in dihedral angle L	5	1
Rear white in dihedral angle R	5	1

Where:

- (a) Area A includes all directions in the adjacent dihedral angle that pass through the light source and intersect the common boundary plane at more than 10° but less than 20°; and
- (b) Area B includes all directions in the adjacent dihedral angle that pass through the light source and intersect the common boundary plane at more than 20°.

CS 29.1397 Colour specifications

ED Decision 2003/16/RM

Each position light colour must have the applicable International Commission on Illumination chromaticity co-ordinates as follows:

- (a) Aviation Red:
 - 'y' is not greater than 0.335; and
 - 'z' is not greater than 0.002.
- (b) Aviation green:
 - 'x' is not greater than $0.440 - 0.320y$;
 - 'x' is not greater than $y - 0.170$; and
 - 'y' is not less than $0.390 - 0.170x$.
- (c) Aviation white:
 - 'x' is not less than 0.300 and not greater than 0.540;
 - 'y' is not less than 'x-0.040' or 'y_o-0.010', whichever is the smaller; and
 - 'y' is not greater than 'x+0.020' nor '0.636-0.400x'.

Where 'y_o' is the 'y' co-ordinate of the Planckian radiator for the value of 'x' considered.

CS 29.1399 Riding light

ED Decision 2003/16/RM

- (a) Each riding light required for water operation must be installed so that it can:
 - (1) Show a white light for at least 4 km (two miles) at night under clear atmospheric conditions; and
 - (2) Show a maximum practicable unbroken light with the rotorcraft on the water.
- (b) Externally hung lights may be used.

CS 29.1401 Anti-collision light system

ED Decision 2003/16/RM

- (a) *General.* If certification for night operation is requested, the rotorcraft must have an anti-collision light system that:
 - (1) Consists of one or more approved anti-collision lights located so that their emitted light will not impair the crew's vision or detract from the conspicuity of the position lights; and
 - (2) Meets the requirements of sub-paragraphs (b) to (f).

- (b) *Field of coverage.* The system must consist of enough lights to illuminate the vital areas around the rotorcraft, considering the physical configuration and flight characteristics of the rotorcraft. The field of coverage must extend in each direction within at least 30° above and 30° below the horizontal plane of the rotorcraft, except that there may be solid angles of obstructed visibility totalling not more than 0.5 steradians.
- (c) *Flashing characteristics.* The arrangement of the system, that is, the number of light sources, beam width, speed of rotation, and other characteristics, must give an effective flash frequency of not less than 40, nor more than 100, cycles per minute. The effective flash frequency is the frequency at which the rotorcraft's complete anti-collision light system is observed from a distance, and applies to each sector of light including any overlaps that exist when the system consists of more than one light source. In overlaps, flash frequencies may exceed 100, but not 180, cycles per minute.
- (d) *Colour.* Each anti-collision light must be aviation red and must meet the applicable requirements of [CS 29.1397](#).
- (e) *Light intensity.* The minimum light intensities in any vertical plane, measured with the red filter (if used) and expressed in terms of 'effective' intensities, must meet the requirements of subparagraph (f). The following relation must be assumed:

$$I_e = \frac{\int_{t_1}^{t_2} I(t) dt}{0 \cdot 2 + (t_2 - t_1)}$$

where:

I_e = effective intensity (candelas).

$I(t)$ = instantaneous intensity as a function of time.

$t_2 - t_1$ = flash time interval (seconds).

Normally, the maximum value of effective intensity is obtained when t_2 and t_1 are chosen so that the effective intensity is equal to the instantaneous intensity at t_2 and t_1 .

- (f) *Minimum effective intensities for anti-collision light.* Each anti-collision light effective intensity must equal or exceed the applicable values in the following table:

$I_e = \frac{\int_{t_1}^{t_2} I(t) dt}{0 \cdot 2 + (t_2 - t_1)}$ Angle above or below the horizontal plane	Effective intensity (candelas)
0° to 5°	150
5° to 10°	90
10° to 20°	30
20° to 30°	15

SAFETY EQUIPMENT

CS 29.1411 General

ED Decision 2018/007/R

- (a) *Accessibility.* Required safety equipment to be used by the crew in an emergency must be readily accessible.
- (b) *Stowage provisions.* Stowage provisions for required safety equipment must be furnished and must:
 - (1) Be arranged so that the equipment is directly accessible and its location is obvious; and
 - (2) Protect the safety equipment from inadvertent damage.
- (c) *Emergency exit descent device.* The stowage provisions for the emergency exit descent device required by [CS 29.809\(f\)](#) must be at the exits for which they are intended.

[Amdt No: 29/5]

AMC 29.1411 Safety equipment — General

ED Decision 2018/007/R

This AMC replaces FAA AC 29.1411.

(a) Explanation

CS-29 Amendment 5 introduced changes related to ditching and associated equipment. In particular, it defined a standard set of terminology, it simplified [CS 29.1411](#) in line with it being a general certification specification for safety equipment, reorganised [CS 29.1415](#) specifically for ditching equipment, and created a new [CS 29.1470](#) on the installation and carriage of emergency locator transmitters (ELTs). All requirements relating to life raft installations are now co-located in [CS 29.1415](#).

- (1) The safety equipment should be accessible and appropriately stowed, and it should be ensured that:
 - (i) locations for stowage of all required safety equipment have been provided;
 - (ii) safety equipment is readily accessible to both crew members and passengers, as appropriate, during any reasonably probable emergency situation;
 - (iii) stowage locations for all required safety equipment will adequately protect such equipment from inadvertent damage during normal operations; and
 - (iv) safety equipment stowage provisions will protect the equipment from damage during emergency landings when subjected to the inertia loads specified in [CS 29.561](#).

(b) Procedures

- (1) A cockpit evaluation should be conducted to demonstrate that all required emergency equipment to be used by the flight crew will be readily accessible during any foreseeable emergency situation. This evaluation should include, for example, emergency flotation equipment actuation devices, remote life raft releases, door jettison handles, handheld fire extinguishers, and protective breathing equipment.

- (2) Stowage provisions for safety equipment shown to be compatible with the vehicle configuration presented for certification should be provided and identified so that:
 - (i) equipment is readily accessible regardless of the operational configuration;
 - (ii) stowed equipment is free from inadvertent damage from passengers and handling; and
 - (iii) stowed equipment is adequately restrained to withstand the inertia forces specified in CS 29.561(b)(3) without sustaining damage.
- (3) For rotorcraft required to have an emergency descent slide or rope according to [CS 29.809\(f\)](#), the stowage provisions for these devices should be located at the exits where those devices are intended to be used.

[Amdt No: 29/5]

CS 29.1413 Safety belts: passenger warning device

ED Decision 2003/16/RM

- (a) If there are means to indicate to the passengers when safety belts should be fastened, they must be installed to be operated from either pilot seat.
- (b) Each safety belt must be equipped with a metal to metal latching device.

CS 29.1415 Ditching equipment

ED Decision 2018/007/R

If certification with ditching provisions or emergency flotation provisions is requested by the applicant, the additional safety equipment required by any applicable operating rule must meet the requirements of this CS.

- (a) All equipment must be approved.
- (b) Life rafts.
 - (1) Required life raft(s) must be remotely deployable for use in an emergency. Remote controls capable of deploying the life raft(s) must be located within easy reach of the flight crew, occupants of the passenger cabin and survivors in the water, with the rotorcraft in the upright floating or capsized position. It must be substantiated that life raft(s) sufficient to accommodate all rotorcraft occupants, without exceeding the rated capacity of any life raft, can be reliably deployed with the rotorcraft in any reasonably foreseeable floating attitude, including capsized, and in the sea conditions chosen for demonstrating compliance with [CS 29.801\(e\)](#).
 - (2) Each life raft must have a short retaining line designed to hold the life raft near the rotorcraft and a long retaining line designed to keep the life raft attached to the rotorcraft. Both retaining lines must be designed to break before submerging the empty raft to which they are attached if the rotorcraft becomes totally submerged. The long retaining line must be of sufficient length that a drifting life raft will not be drawn towards any part of the rotorcraft that would pose a danger to the life raft itself or the persons on board.
 - (3) Each life raft must be substantiated as suitable for use in all sea conditions covered by the certification with ditching or emergency flotation provisions.

- (4) The number of life rafts installed must be no less than two. The life rafts must be of an approximately equal rated capacity and buoyancy to accommodate all the occupants of the rotorcraft and unless excess life rafts of sufficient capacity are provided, the buoyancy and seating capacity beyond the rated capacity of each life raft (overload rating) must accommodate all occupants of the rotorcraft in the event of loss of one life raft of the largest rated capacity.
- (c) Life preservers.
- If the applicable operating rule allows for life preservers not to be worn at all times, stowage provisions must be provided that accommodate one life preserver for each occupant for which certification with ditching provisions is requested. A life preserver must be within easy reach of each occupant while seated.
- (d) Survival equipment.
- Approved survival equipment must be attached to each liferaft.

[Amdt No: 29/5]

AMC 29.1415 Ditching equipment

ED Decision 2018/007/R

This AMC replaces FAA AC 29.1415.

- (a) Explanation
- (1) Additional safety equipment is not required for all rotorcraft overwater operations. However, if such equipment is required by the applicable operating rule, the equipment supplied should satisfy this AMC.
- NOTE: Although the term ‘ditching’ is most commonly associated with the design standards related to [CS 29.801](#) (ditching approval), a rotorcraft equipped to the less demanding requirements of [CS 29.802](#) (emergency flotation approval), when performing an emergency landing on to water, would nevertheless be commonly described as carrying out the process of ditching. The term ‘ditching equipment’ is therefore to be considered to apply to any safety equipment required by operational rule for operation over water.
- It is a frequent practice for the rotorcraft manufacturer to provide the substantiation for only those portions of the ditching requirements relating to rotorcraft flotation and emergency exits. Completion of the ditching certification to include the safety equipment installation and stowage provisions is then left to the affected operator so that those aspects can best be adapted to the selected cabin interior. In such cases, the ‘Limitations’ section of the rotorcraft flight manual (RFM) should identify the substantiations yet to be provided in order to justify the full certification with ditching provisions. The modifier performing these final installations is then concerned directly with the details of this AMC. Any issues arising from aspects of the basic rotorcraft flotation and emergency exits certification that are not compatible with the modifier’s proposed safety equipment provisions should be resolved between the type certificate (TC) holder and the modifier prior to the certifying authority’s certification with ditching provisions (see [AMC 29.801\(b\)\(13\)](#) and [AMC 29.1415\(a\)\(2\)\(ii\)](#)).

-
- (2) Compliance with the requirements of [CS 29.801](#) for rotorcraft ditching requires compliance with the safety equipment stowage requirements and ditching equipment requirements of [CS 29.1411](#) and [CS 29.1415](#), respectively.
- (i) Ditching equipment installed to complete ditching certification, or required by the applicable operating rule, should be compatible with the basic rotorcraft configuration presented for ditching certification. It is satisfactory if the ditching equipment is not incorporated at the time of the original rotorcraft type certification provided that suitable information is included in the ‘Limitations’ section of the rotorcraft flight manual (RFM) to identify the extent of ditching certification not yet completed.
 - (ii) When ditching equipment is being installed by a person other than the applicant who provided the rotorcraft flotation system and emergency exits, special care should be taken to avoid degrading the functioning of those items, and to make the ditching equipment compatible with them (see [AMC 29.801\(b\)\(13\)](#)).
- (b) Procedures
- All ditching equipment, including life rafts, life preservers, immersion suits, emergency breathing systems etc., should be of an approved type. Life rafts should be chosen to be suitable for use in all sea conditions covered by the certification with ditching provisions.
- (1) Life rafts
- (i) Life rafts are rated during their certification according to the number of people that can be carried under normal conditions and the number that can be accommodated in an overload condition. Only the normal rating may be used in relation to the number of occupants permitted to fly in the rotorcraft.
 - (ii) The life rafts should deploy on opposite sides of the rotorcraft in order to minimise the probability that all may be damaged during water entry/impact, and to provide the maximum likelihood that at least half of those provided will be useable in any wind condition.
 - (iii) Successful deployment of life raft installations should be demonstrated in all representative conditions. Testing should be performed, including underwater deployment, if applicable, to demonstrate that life rafts sufficient to accommodate all rotorcraft occupants, without exceeding the rated capacity of any life raft, will deploy reliably with the rotorcraft in any reasonably foreseeable floating attitude, including capsized. It should also be substantiated that reliable deployment will not be compromised by inertial effects from the rolling/pitching/heaving of the rotorcraft in the sea conditions chosen for the demonstration of compliance with the flotation/trim requirements of CS 29.801(e), or by intermittent submerging of the stowed raft location (if applicable) and the effects of wind. This substantiation should also consider all reasonably foreseeable rotorcraft floating attitudes, including capsized. Reasonably foreseeable floating attitudes are considered to be, as a minimum, upright, with and without loss of the critical emergency flotation system (EFS) compartment, and capsized, also with and without loss of the critical EFS compartment. Consideration should also be given towards maximising, where practicable, the likelihood of life raft deployment for other cases of EFS damage.

- (iv) Rotorcraft fuselage attachments for the life raft retaining lines should be provided.
 - (A) Each life raft should be equipped with two retaining lines to be used for securing the life raft to the rotorcraft. The short retaining line should be of such a length as to hold the raft at a point next to an upright floating rotorcraft such that the occupants can enter the life raft directly without entering the water. If the design of the rotorcraft is such that the flight crew cannot enter the passenger cabin, it is acceptable that they would need to take a more indirect route when boarding the life raft. After life raft boarding is completed, the short retaining line may be cut and the life raft then remain attached to the rotorcraft by means of the long retaining line.
 - (B) Attachments on the rotorcraft for the retaining lines should not be susceptible to damage when the rotorcraft is subjected to the maximum water entry loads established by [CS 29.563](#).
 - (C) Attachments on the rotorcraft for the retaining lines should be structurally adequate to restrain a fully loaded life raft.
 - (D) Life rafts should be attached to the rotorcraft by the required retaining lines after deployment without further action from the crew or passengers.
 - (E) It should be verified that the length of the long retaining line will not result in the life raft taking up a position which could create a potential puncture risk or hazard to the occupants, such as directly under the tail boom, tail rotor or main rotor disc.
- (v) Life raft stowage provisions should be sufficient to accommodate rafts for the maximum number of occupants for which certification for ditching is requested by the applicant.
- (vi) Life raft activation

The following should be provided for each life raft:

- (A) primary activation: manual activation control(s), readily accessible to each pilot on the flight deck whilst seated;
- (B) secondary activation: activation control(s) accessible from the passenger cabin with the rotorcraft in the upright or capsized position; if any control is located within the cabin, it should be protected from inadvertent operation; and
- (C) tertiary activation: activation control(s) accessible to a person in the water, with the rotorcraft in any foreseeable floating attitude, including capsized.

It is acceptable for two of these manual activation functions to be incorporated into one control.

Automatic life raft activation is not prohibited (e.g. it could be triggered by water immersion). However, such a capability should be provided in addition to the above manual activation controls, not instead of them, and issues such as inadvertent deployment in flight and the potential for damage from turning rotors during deployment on the water should be mitigated.

Placards should be installed, of appropriate size, number and location, to highlight the location of each of the above life raft activation controls. All reasonably foreseeable rotorcraft floating attitudes should be considered.

(vii) Protection of life rafts from damage

Service experience has shown that following deployment, life rafts are susceptible to damage while in the water adjacent to the rotorcraft due to projections on the exterior of the rotorcraft such as antennas, overboard vents, unprotected split pin tails, guttering, etc. and any projections sharper than a three dimensional right angled corner. Projections likely to cause damage to a deployed life raft should be avoided by design, or suitably protected to minimise the likelihood of their causing damage to a deployed life raft. In general, projections on the exterior surface of the helicopter, that are located in a zone delineated by boundaries that are 1.22 m (4 ft) above and 0.61 m (2 ft) below the established static water line should be assessed. Relevant maintenance information should also provide procedures for maintaining such protection for rotorcraft equipped with life rafts. Furthermore, due account should be taken of the likely damage that may occur (e.g. disintegration of carbon-fibre panels or structure) during water entry and its potential hazard to deployed life rafts.

(2) Life preservers.

No provision for the stowage of life preservers is necessary if the applicable operating rule mandates the need for constant-wear life preservers.

(3) Emergency signalling equipment

Emergency signalling equipment required by the applicable operating rule should be free from hazards in its operation, and operable using either bare or gloved hands. Required signalling equipment should be easily accessible to the passengers or crew and located near a ditching emergency exit or included in the survival equipment attached to the life rafts.

[Amdt No: 29/5]

CS 29.1419 Ice protection

ED Decision 2003/16/RM

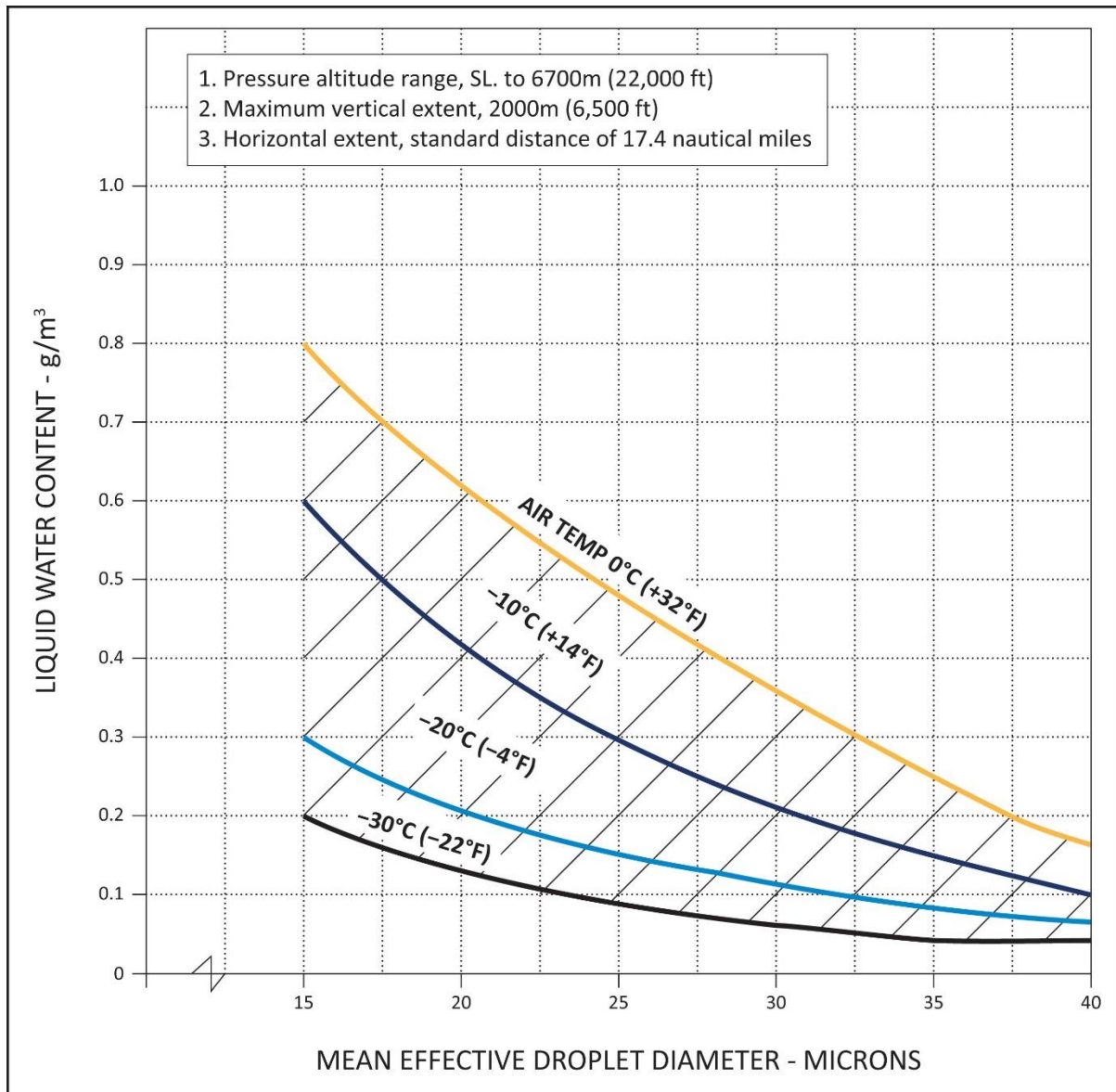
- (a) To obtain certification for flight into icing conditions, compliance with this paragraph must be shown.
- (b) It must be demonstrated that the rotorcraft can be safely operated in the continuous maximum and intermittent maximum icing conditions determined under [Appendix C](#) within the rotorcraft altitude envelope. An analysis must be performed to establish, on the basis of the rotorcraft's operational needs, the adequacy of the ice protection system for the various components of the rotorcraft.
- (c) In addition to the analysis and physical evaluation prescribed in sub-paragraph (b), the effectiveness of the ice protection system and its components must be shown by flight tests of the rotorcraft or its components in measured natural atmospheric icing conditions and by one or more of the following tests as found necessary to determine the adequacy of the ice protection system:
- (1) Laboratory dry air or simulated icing tests, or a combination of both, of the components or models of the components.
 - (2) Flight dry air tests of the ice protection system as a whole, or its individual components.
 - (3) Flight tests of the rotorcraft or its components in measured simulated icing conditions.

- (d) The ice protection provisions of this paragraph are considered to be applicable primarily to the airframe. Powerplant installation requirements are contained in Subpart E of this CS-29.
- (e) A means must be identified or provided for determining the formation of ice on critical parts of the rotorcraft. Unless otherwise restricted, the means must be available for night- time as well as daytime operation. The rotorcraft flight manual must describe the means of determining ice formation and must contain information necessary for safe operation of the rotorcraft in icing conditions.

Appendix C – Icing Certification

ED Decision 2003/16/RM

- (a) The maximum continuous intensity of atmospheric icing conditions (continuous maximum icing) is defined by the variables of the cloud liquid water content, the mean effective diameter of the cloud droplets, the ambient air temperature, and the interrelationship of these three variables as shown in figure 1 of this appendix. The limiting icing envelope in terms of altitude and temperature is given in figure 2 of this appendix. The interrelationship of cloud liquid water content with drop diameter and altitude is determined from figures 1 and 2. The cloud liquid water content for continuous maximum icing conditions of a horizontal extent, other than 32.2 km (17.4 nautical miles), is determined by the value of liquid water content of figure 1, multiplied by the appropriate factor from figure 3 of this appendix.
- (b) The intermittent maximum intensity of atmospheric icing conditions (intermittent maximum icing) is defined by the variables of the cloud liquid water content, the mean effective diameter of the cloud droplets, the ambient air temperature, and the interrelationship of these three variables as shown in figure 4 of this appendix. The limiting icing envelope in terms of altitude and temperature is given in figure 5 of this appendix. The interrelationship of cloud liquid water content with drop diameter and altitude is determined from figures 4 and 5. The cloud liquid water content for intermittent maximum icing conditions of a horizontal extent, other than 4.8 km (2.6 nautical miles), is determined by the value of cloud liquid water content of figure 4 multiplied by the appropriate factor in figure 6 of this appendix.


FIGURE 1
CONTINUOUS MAXIMUM (STRATIFORM CLOUDS) ATMOSPHERIC ICING CONDITIONS
LIQUID WATER CONTENT VS MEAN EFFECTIVE DROP DIAMETER

Source of data – NACA TN No. 1855, Class III - M, Continuous Maximum.

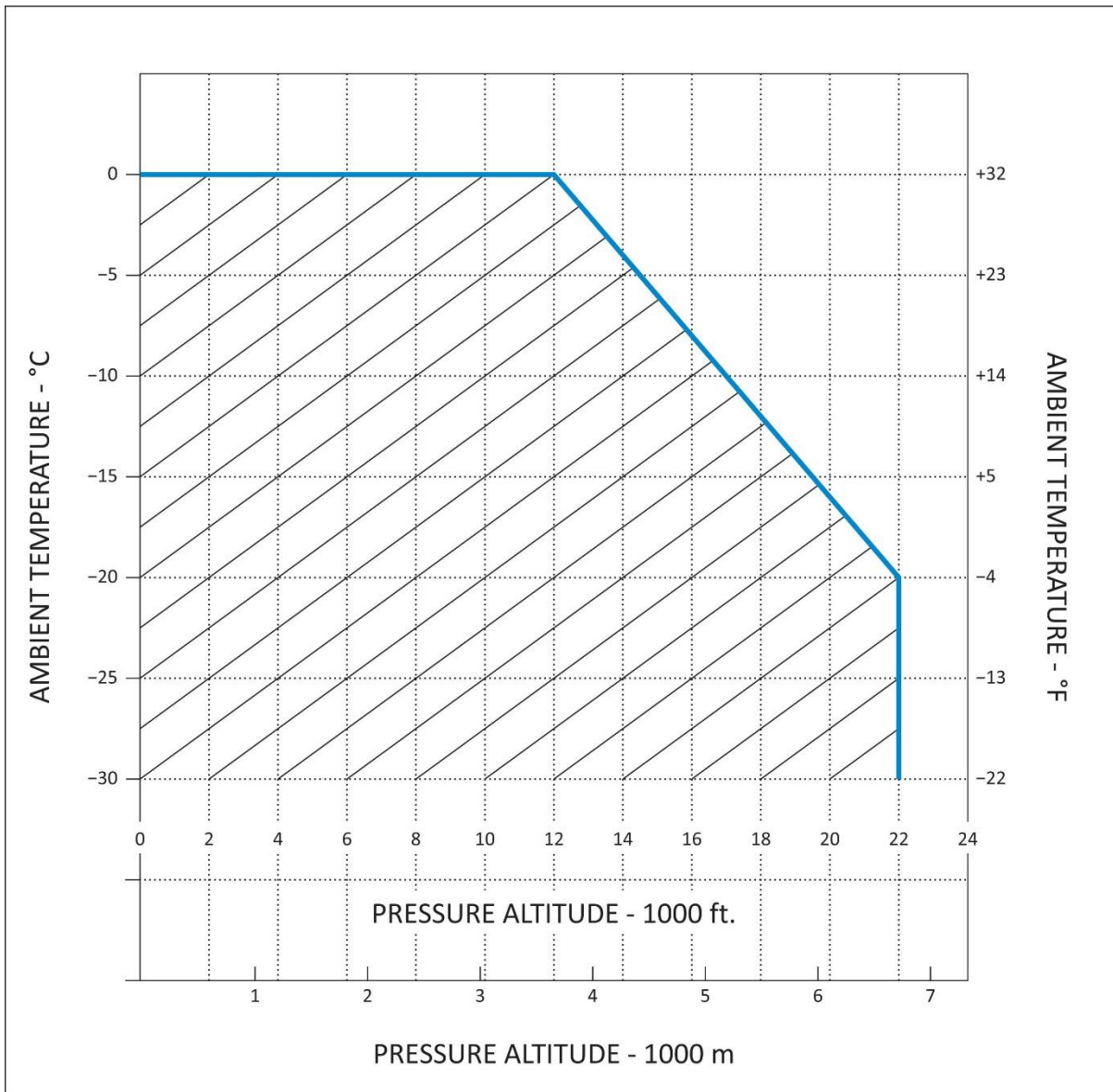
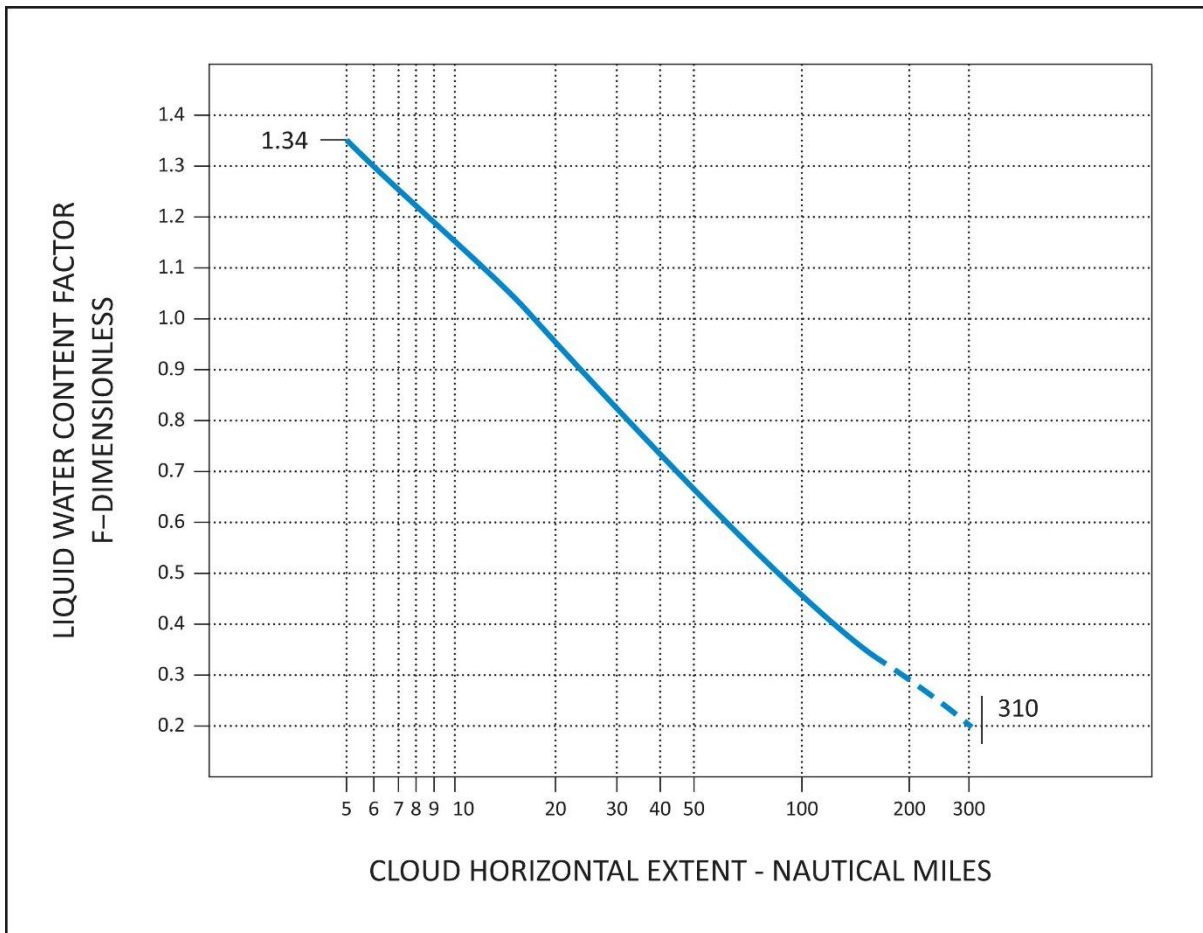


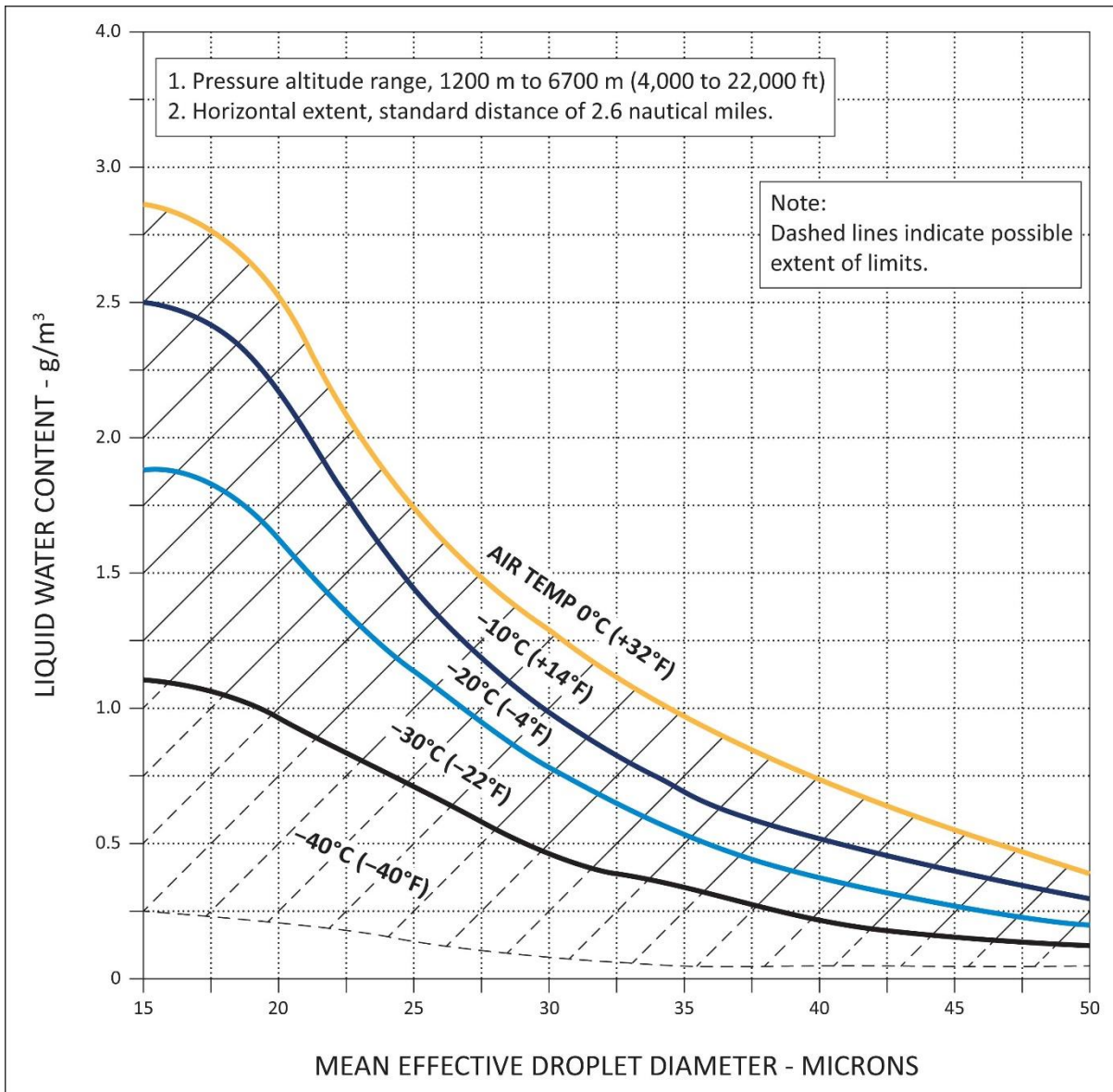
FIGURE 2

CONTINUOUS MAXIMUM (STRATIFORM CLOUDS) ATMOSPHERIC ICING CONDITIONS

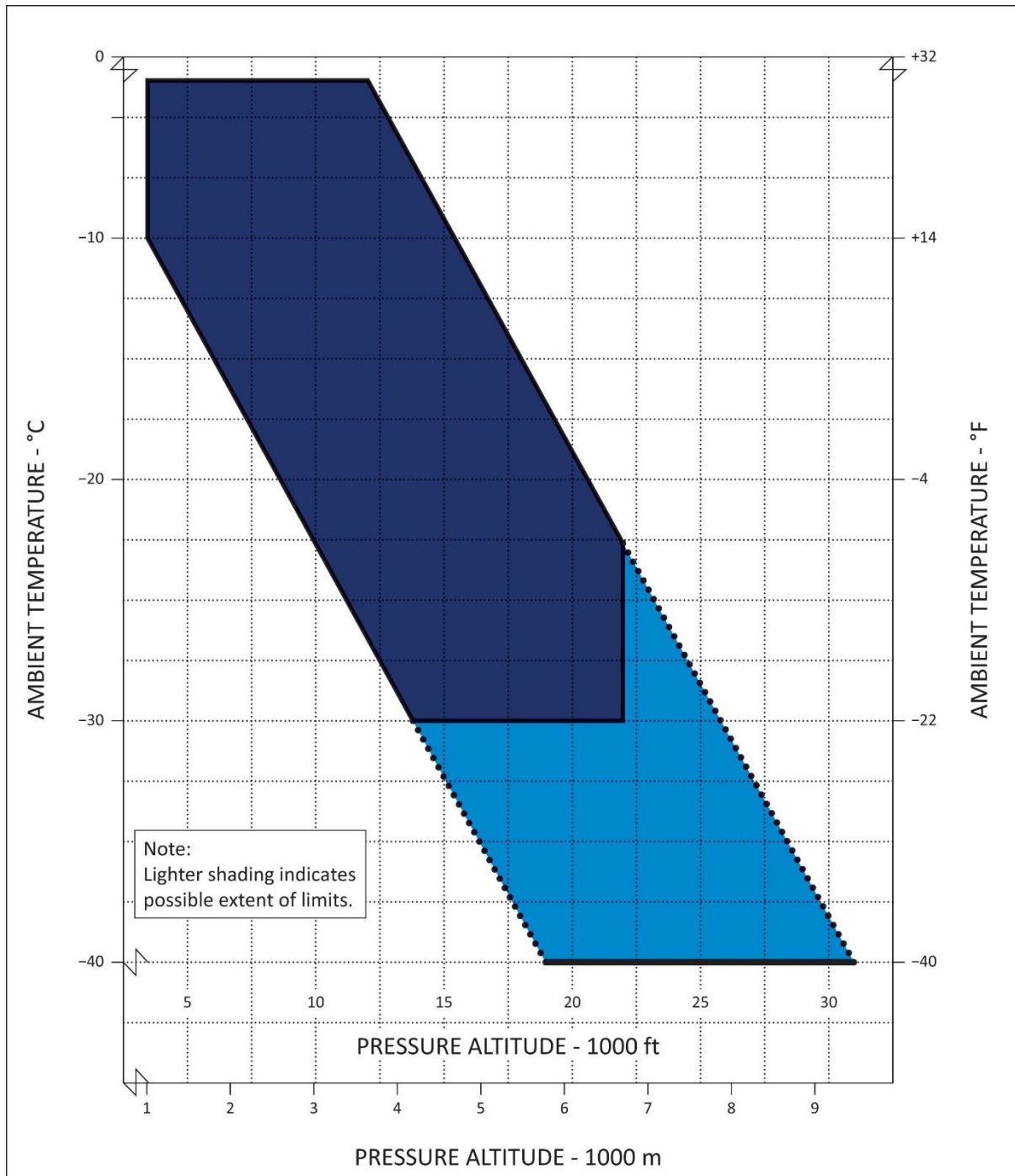
AMBIENT TEMPERATURE VS PRESSURE ALTITUDE

Source of data – NACA TN No. 2569.

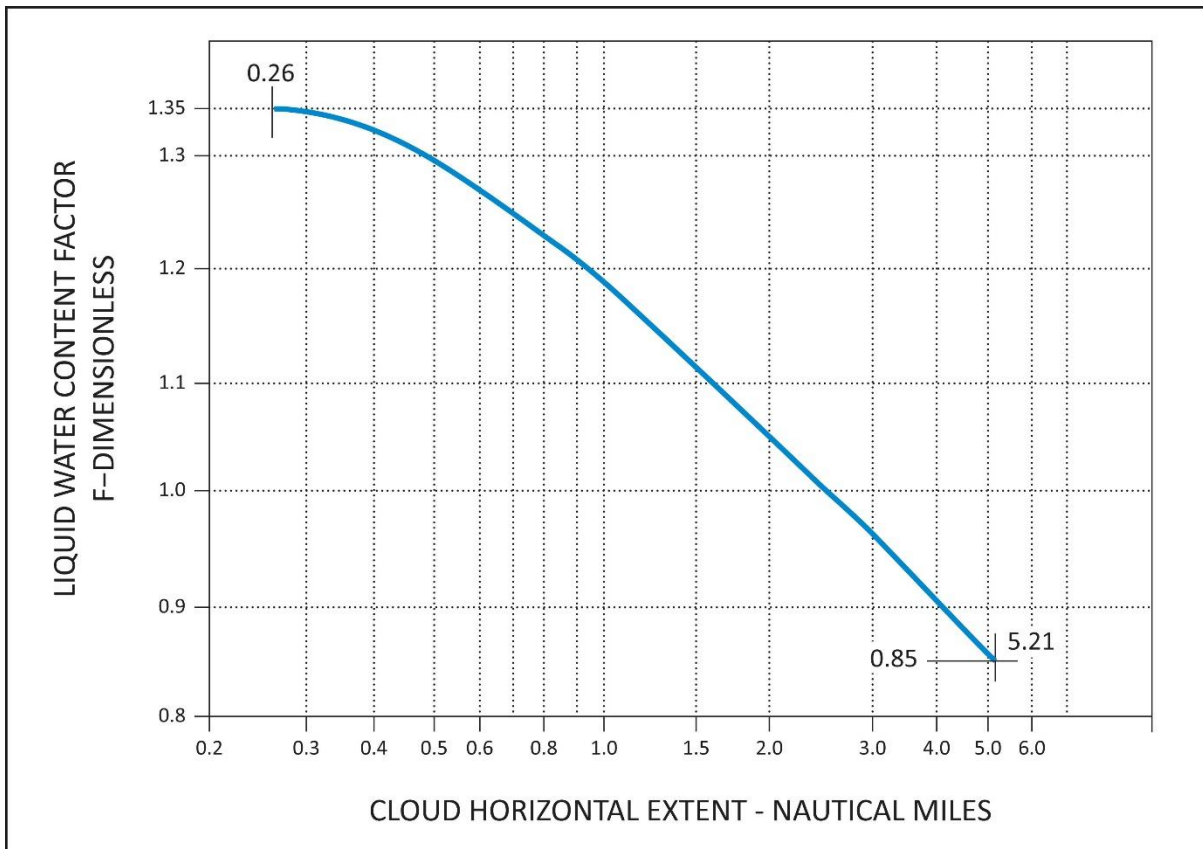

FIGURE 3
CONTINUOUS MAXIMUM (STRATIFORM CLOUDS) ATMOSPHERIC ICING CONDITIONS
LIQUID WATER CONTENT FACTOR VS CLOUD HORIZONTAL DISTANCE
Source of data – NACA TN No. 2738.


FIGURE 4
INTERMITTENT MAXIMUM (CUMULIFORM CLOUDS) ATMOSPHERIC ICING CONDITIONS
LIQUID WATER CONTENT VS MEAN EFFECTIVE DROP DIAMETER

Source of data – NACA TN No. 1855, Class II - M, Intermittent Maximum.


FIGURE 5
INTERMITTENT MAXIMUM (CUMULIFORM CLOUDS) ATMOSPHERIC ICING CONDITIONS
AMBIENT TEMPERATURE VS PRESSURE ALTITUDE

Source of data – NACA TN No. 2569.


FIGURE 6

**INTERMITTENT MAXIMUM (CUMULIFORM CLOUDS) ATMOSPHERIC ICING CONDITIONS
 VARIATION OF LIQUID WATER CONTENT FACTOR WITH CLOUD HORIZONTAL EXTENT**

Source of data – NACA TN No. 2738.

MISCELLANEOUS EQUIPMENT

CS 29.1431 Electronic equipment

ED Decision 2003/16/RM

- (a) Radio communication and navigation installations must be free from hazards in themselves, in their method of operation, and in their effects on other components, under any critical environmental conditions.
- (b) Radio communication and navigation equipment, controls, and wiring must be installed so that operation of any one unit or system of units will not adversely affect the simultaneous operation of any other radio or electronic unit, or system of units, required by any applicable CS or operating rule.

CS 29.1433 Vacuum systems

ED Decision 2003/16/RM

- (a) There must be means, in addition to the normal pressure relief, to automatically relieve the pressure in the discharge lines from the vacuum air pump when the delivery temperature of the air becomes unsafe.
- (b) Each vacuum air system line and fitting on the discharge side of the pump that might contain flammable vapours or fluids must meet the requirements of [CS 29.1183](#) if they are in a designated fire zone.
- (c) Other vacuum air system components in designated fire zones must be at least fire resistant.

CS 29.1435 Hydraulic systems

ED Decision 2003/16/RM

- (a) *Design.* Each hydraulic system must be designed as follows:
 - (1) Each element of the hydraulic system must be designed to withstand, without detrimental, permanent deformation, any structural loads that may be imposed simultaneously with the maximum operating hydraulic loads.
 - (2) Each element of the hydraulic system must be designed to withstand pressures sufficiently greater than those prescribed in sub-paragraph (b) to show that the system will not rupture under service conditions.
 - (3) There must be means to indicate the pressure in each main hydraulic power system.
 - (4) There must be means to ensure that no pressure in any part of the system will exceed a safe limit above the maximum operating pressure of the system, and to prevent excessive pressures resulting from any fluid volumetric change in lines likely to remain closed long enough for such a change to take place. The possibility of detrimental transient (surge) pressures during operation must be considered.
 - (5) Each hydraulic line, fitting, and component must be installed and supported to prevent excessive vibration and to withstand inertia loads. Each element of the installation must be protected from abrasion, corrosion, and mechanical damage.
 - (6) Means for providing flexibility must be used to connect points, in a hydraulic fluid line, between which relative motion or differential vibration exists.

- (b) *Tests.* Each element of the system must be tested to a proof pressure of 1.5 times the maximum pressure to which that element will be subjected in normal operation, without failure, malfunction, or detrimental deformation of any part of the system.
- (c) *Fire protection.* Each hydraulic system using flammable hydraulic fluid must meet the applicable requirements of [CS 29.861](#), [29.1183](#), [29.1185](#), and [29.1189](#).

CS 29.1439 Protective breathing equipment

ED Decision 2003/16/RM

- (a) If one or more cargo or baggage compartments are to be accessible in flight, protective breathing equipment must be available for an appropriate crew member.
- (b) For protective breathing equipment required by sub-paragraph (a) or by any applicable operating rule:
 - (1) That equipment must be designed to protect the crew from smoke, carbon dioxide, and other harmful gases while on flight deck duty;
 - (2) That equipment must include:
 - (i) Masks covering the eyes, nose, and mouth; or
 - (ii) Masks covering the nose and mouth, plus accessory equipment to protect the eyes; and
 - (3) That equipment must supply protective oxygen of 10 minutes duration per crew member at a pressure altitude of 2438 m (8000 ft) with a respiratory minute volume of 30 litres per minute BTPD.

CS 29.1457 Cockpit voice recorders

ED Decision 2021/010/R

(See [AMC 29.1457](#))

- (a) Each cockpit voice recorder required by the applicable operating rules must be approved, and must be installed so that it will record the following:
 - (1) Voice communications transmitted from or received in the rotorcraft by radio.
 - (2) Voice communications of flight-crew members on the flight deck.
 - (3) Voice communications of flight-crew members on the flight deck, using the rotorcraft's inter-phone system.
 - (4) Voice or audio signals identifying navigation or approach aids introduced into a headset or speaker.
 - (5) Voice communications of flight-crew members using the passenger loudspeaker system, if there is such a system, and if the fourth channel is available in accordance with the requirements of sub-paragraph (c)(4)(ii).
- (b) The recording requirements of sub-paragraph (a)(2) may be met:
 - (1) By installing a cockpit-mounted area microphone, located in the best position for recording voice communications originating at the first and second pilot stations and voice communications of other crew members on the flight deck when directed to those stations; or

- (2) By installing a continually energised or voice-actuated lip microphone at the first and second pilot stations.

The microphone specified in this paragraph must be so located and, if necessary, the preamplifiers and filters of the recorder must be so adjusted or supplemented, that the recorded communications are intelligible when recorded under flight cockpit noise conditions and played back. The level of intelligibility must be approved by the Agency. Repeated aural or visual playback of the record may be used in evaluating intelligibility.

- (c) Each cockpit voice recorder must be installed so that the part of the communication or audio signals specified in sub-paragraph (a) obtained from the following sources is recorded on at least four separate channels:

- (1) From each microphone, headset, or speaker used at the first pilot station.
- (2) From each microphone, headset, or speaker used at the second pilot station.
- (3) From the cockpit-mounted area microphone, or the continually energised or voice-actuated lip microphones at the first and second pilot stations.
- (4) From:
 - (i) each microphone, headset, or speaker used at the stations for the third and fourth crew members; or
 - (ii) if the stations specified in sub-paragraph (c)(4)(i) are not required or if the signal at such a station is picked up by another channel, each microphone on the flight deck that is used with the passenger loudspeaker system if its signals are not picked up by another channel.
 - (iii) Each microphone on the flight deck that is used with the rotorcraft's loudspeaker system, if its signals are not picked up by another channel.

No channel shall record communication or audio signals from more than one of the following sources: the first pilot station, second pilot station, cockpit-mounted area microphone, and additional crew member stations.

- (d) Each cockpit voice recorder must be installed so that:
 - (1) (i) It receives its electrical power from the bus that provides the maximum reliability for operation of the recorder without jeopardising service to essential or emergency loads; and
 - (ii) It remains powered for as long as possible without jeopardising the emergency operation of the rotorcraft;
 - (2) There is an automatic means to stop the recording within 10 minutes after crash impact;
 - (3) There is an aural or visual means for pre-flight checking of the recorder for proper operation.
 - (4) Any single electrical failure that is external to the recorder does not disable both the cockpit voice recorder function and the flight data recorder function;
 - (5) There is a means for the flight crew to stop the cockpit voice recorder function upon completion of the flight in a way such that re-enabling the cockpit voice recorder function is only possible by dedicated manual action; and
 - (6) It has an alternate power source:

- that provides 10 minutes of electrical power to operate both the recorder and the cockpit-mounted area microphone; and
 - to which the recorder and the cockpit-mounted area microphone are switched automatically in the event that all other power to the recorder is interrupted either by a normal shutdown or by any other loss of power.
- (e) The container of the recording medium must be located and mounted so as to minimise the probability of the container rupturing, the recording medium being destroyed, or the underwater locating device failing as a result of any possible combinations of:
- impact with the Earth's surface;
 - the heat damage caused by a post-impact fire; and
 - immersion in water.
- (f) If the cockpit voice recorder has an erasure device or function, the installation must be designed to minimise the probabilities of inadvertent operation and of actuation of the erasure device or function during crash impact.
- (g) The recorder container of the cockpit voice recorder must:
- (1) be bright orange;
 - (2) have reflective tape affixed to its external surface to facilitate locating it; and
 - (3) have an underwater locating device on or adjacent to the container which is secured in such a manner that they are not likely to be separated during crash impact.

[Amdt 29/7]

[Amdt 29/9]

AMC 29.1457 Cockpit Voice Recorders

ED Decision 2021/010/R

This AMC provides further guidance and acceptable means of compliance to supplement FAA AC 29-2C § AC 29.1457. § 29.1457, to meet EASA's interpretation of [CS 29.1457](#). As such, it should be used in conjunction with the FAA AC.

1. General

The installation of a recorder with an ETSO authorisation against ETSO-C123c (or equivalent standard accepted by EASA) satisfies the approval requirement in CS 29.1457(a).

In showing compliance with CS 29.1457, the applicant should take into account EUROCAE Document ED 112A 'MOPS for Crash-Protected Airborne Recorder Systems' or a later revision.

'CVR system' designates the cockpit voice recorder (CVR) and its dedicated equipment (e.g. dedicated sensors or transducers, amplifiers, dedicated data buses, dedicated power source).

2. Automatic means to stop the recording after a crash impact

The automatic means to stop the recording within 10 minutes after a crash impact may rely on:

- a. Dedicated crash impact detection sensors. In this case, negative acceleration sensors (also called 'g-switches') should not be used as the sole means of detecting a crash impact; or
- b. The recording start-and-stop logic, provided that this start-and-stop logic stops the recording 10 ± 1 minutes after the loss of power on all engines.

3. Means for the flight crew to stop the cockpit voice recorder

The means for the flight crew to stop the cockpit voice recorder function after the completion of the flight is needed in order to preserve the recording for the purpose of investigating accidents and serious incidents. In fulfilling this requirement, it is acceptable to use circuit breakers to remove the power to the equipment. Such a means to stop the cockpit voice recorder function is not in contradiction with FAA AC 29-2C, § AC 29.1357, § 29.1357, point b.(6), because it would not be used under normal operating conditions, but only after an accident or a serious incident has occurred.

4. Power sources

The alternate power source is a power source that is different from the source(s) that normally provides (provide) power to the cockpit voice recorder. In CS 29.1457(d)(6), a 'normal shutdown' of power to the recorder means a commanded interruption of the power supply from the normal cockpit voice recorder power bus; for example, after the termination of a normal flight. The following applies to the installation of an alternate power source:

- a. A tolerance of 1 minute on the 10 minutes minimum power requirement of CS 29.1457(d)(6) is acceptable;
- b. The use of helicopter batteries or other power sources is acceptable, provided that electrical power to the essential and critical loads is not compromised;
- c. If the alternate power source relies on dedicated stand-alone batteries (such as a recorder independent power supply), then these batteries should be located as close as practicable to the recorder;
- d. If the cockpit voice recorder function is combined with other recording functions within the same unit, the alternate power source may also power the other recording functions; and
- e. The means for performing a pre-flight check of the recorder for proper operation should include a check of the availability of the alternate power source.

5. Combination recorder

In cases where the recorder performs several recording functions, the means for pre-flight checking of the recorder for proper operation should indicate which recording functions (e.g. FDR, CVR, data-link recording, etc.) have failed.

6. Evaluation of the CVR recording

The following acceptable means of compliance with [CS 29.1457\(b\)](#) is provided to demonstrate that the performance of a new or modified CVR system is acceptable and that the quality of the CVR recording is acceptable. Inspections of the CVR recording that are part of the instructions for continued airworthiness (ICAs) are not within the scope of this paragraph.

- a. The CVR system should be installed in accordance with the recommendations made in EUROCAE Document ED-112A, in particular:
 - Chapter 2-5 'Equipment installation and installed performance', and
 - Part I 'Cockpit Voice Recorder System', Chapter I-6.1.1 'Interface design', I-6.1.2 'Recorder Operation' and I-6.1.3 'Bulk Erasure Interlocks'.

Particular attention should be given to the location of the cockpit area microphone (CAM).

ED-112A, Chapter I-6.2. 'Equipment location', provides guidance on this topic.

It should be noted that the CVR may record on more than four channels, and that this may help to avoid superimposition between signal sources recorded on the same CVR channel.

- b. To ensure that the CVR system is properly installed, and to verify that the audio signals recorded on all channels achieve the acceptable level of quality, the applicant should conduct a flight test. The recording obtained should be evaluated to confirm an acceptable level of quality during all normal phases of flight (including taxi-out, hover, take-off, climb, cruise, descent, approach, landing, taxi-in) and autorotation. ED-112A provides guidance for testing a new CVR installation (refer to Chapter I-6.3).
- c. The evaluation of the CVR recording should include:
 - i. the tasks described in ED-112A, Annex I-A, Chapter I-A.3;
 - ii. checking that the vocal signal sources are intelligible and that non-vocal alerts on headsets or speakers can be identified;
 - iii. checking that the levels of side tone signals (e.g. radio) and public address (PA) are adjusted so that these signals are audible and do not mask the signals from the flight crew microphones (refer to ED-112A, Part I, Chapter I-6.1.1);
 - iv. checking the start-and-stop function of the CVR system. The CVR should begin to operate no later than when power from sources other than from the alternate power source is available and the pre-flight checklist is started. The CVR should continue to operate either until the completion of the final post-flight checklist or until 10 minutes after power is lost on all engines; and
 - v. checking for the presence of any fault in the memory of the built-in test feature of the CVR, if applicable.
- d. The evaluation of the CVR recording should fulfil all of the conditions below:
 - i. The equipment used for the CVR recording replay should meet the specifications of Chapter I-A.2 of Annex I-A of ED-112A, or a higher standard;
 - ii. The replay and evaluation of CVR recordings should be performed by personnel with adequate knowledge of CVR systems and aircraft operations, and who have the appropriate experience with the techniques used to evaluate recordings;
 - iii. The observations from the evaluation should be documented in an evaluation report. An example of an evaluation report is provided in ED-112A, Annex I-A; and
 - iv. The evaluation report should indicate the quality of each audio signal that is required to be recorded by [CS 29.1457\(c\)](#) according to defined criteria. For example, the following audio quality rating scale may be used:

GOOD:

 - 1. When considering a vocal signal source (crew voice, radio reception, radio side tone, interphone, public address, synthetic voice in call-outs, warnings and alerts) recorded on a channel other than the CAM channel, the signal is intelligible without using any signal post-processing techniques, and no significant issue (e.g. saturation, noise, interference, or inadequate signal level of a source) affects the quality of this signal;
 - 2. When considering non-vocal alerts recorded on a channel other than the CAM channel, the sounds are accurately identifiable in the recording without

using any signal post-processing techniques, and no significant issue affects the quality of the sound recording;

3. When considering the CAM, the recording is representative of the actual ambient sound, conversations and alerts as if an observer were listening in the cockpit, and no significant issue affects the quality of the signal; and
4. No ‘medium’ or ‘major’ issue is identified on any channel (see Table 1 below for examples).

FAIR: A significant issue affects the signal source being considered. However, the related signal can still be analysed without signal post-processing, or by using signal post-processing techniques provided by standard audio analysis tools (e.g. audio level adjustment, notch filter, etc.). The severity of the identified issues is not rated higher than ‘medium’ (see Table 1 below for examples).

POOR: The signal source being considered is not intelligible or not identifiable, and this cannot be corrected even with the use of signal post-processing techniques. The severity of the identified issues is not necessarily rated as ‘major’; it may also be rated as ‘medium’ depending on the consequence for the required signal sources (see Table 1 below for examples); and

- v. the audio quality rating of a CVR channel required by CS 29.1457(c) should be the same as the worst audio quality rating among the signal sources to be recorded on this channel.
- e. The performance of the CVR system should be considered acceptable by the applicant only if, for none of the signal sources required by CS 29.1457(c) or by the applicable operating rules, the audio quality of the recording was rated as ‘POOR’. In addition, if the CVR system is part of a new aircraft type, the performance of the CVR system should be considered acceptable by the applicant only if for all of the signal sources required by [CS 25.1457\(c\)](#) and by the applicable operating rules, the quality of the audio recording was rated as ‘GOOD’.

Table 1: Examples of issues affecting a signal source and of the associated severity

Issue severity rating	Examples of issues
MAJOR — leading to a ‘POOR’ rating for the affected signal	<ul style="list-style-type: none"> — One or more warnings or call-outs are not recorded — Uncommanded interruption of the CAM signal — Unexplained variation of the CAM dynamic range — Hot-microphone function not operative — CVR time code not available — CAM saturation (due to low-frequency vibration) — Radio side tone is missing — One required signal source is missing from the recording (e.g. one microphone signal not recorded) — Poor intelligibility of one microphone source (e.g. speech through oxygen mask microphone) — Quasi-permanent physical saturation of the CAM due to its excessive sensitivity — Quasi-permanent electrical saturation of a CVR channel

	<ul style="list-style-type: none"> — Mechanical and/or electrical interference making the transcription of signals difficult or impossible — Insufficient CAM sensitivity — Fault in the start/stop sequence
MEDIUM — leading to a ‘POOR’ or ‘FAIR’ rating for the affected signals, depending on the duration and the occurrence rate of the issues	<ul style="list-style-type: none"> — Inappropriate level balance between signal sources on a CVR channel, which results in a signal source masking other signal sources — Electrical interference caused by either the aircraft or the recorder power supply — Low dynamic range of the recording on a CVR channel — Low recording level of alert and/or call-out — Oversensitivity of the CAM line* to electromagnetic interference in the HF, UHF or EHF domain (Wi-Fi, GSM, 5G, etc.) — Oversensitivity of the CAM line* to electrostatic discharge (ESD) phenomena — Oversensitivity of the CAM to air flow or air-conditioning noise (bleed air) — Phasing anomaly between CVR channels — Side tone recorded with low level — Transitory saturation

*CAM line: microphone+control or preamplifier unit+wiring to the CVR

7. Instructions for continued airworthiness (ICAs)

When developing the ICAs for the CVR system, required by [CS 29.1529](#) and its Appendix A, the applicant should address all failures that may affect the correct functioning of the CVR system or the quality of the recorded audio signals.

Examples of failures (indicative and non-exhaustive list):

- The loss of the recording function or of the acquisition function of the CVR.
- Any communication or audio signal (required by [CS 29.1457\(c\)](#) or by the applicable air operations regulations) is missing, or is recorded with an audio quality that is rated ‘POOR’ (refer to the example of audio quality rating provided in Section 6 of this AMC).
- The failure of a sensor, transducer or amplifier dedicated to the CVR system (e.g. failure of the cockpit area microphone).
- The failure of a means to facilitate the finding of the CVR recording medium after an accident (e.g. an underwater locating device or an emergency locator transmitter attached to the recorder).
- The failure of any power source dedicated to the CVR (e.g. dedicated battery).
- The failure of the start-and-stop function.
- The failure of a means to detect a crash impact (for the purpose of stopping the recording after a crash impact, or for the purpose of deploying the recorder if it is deployable).

[Amdt 29/7]

[Amdt 29/9]

CS 29.1459 Flight data recorders

ED Decision 2021/010/R

(See [AMC 29.1459](#))

- (a) Each flight data recorder required by the applicable operating rules must be approved and must be installed so that:
- (1) It is supplied with airspeed, altitude, and directional data obtained from sources that meet the accuracy requirements of [CS 29.1323](#), [29.1325](#), and [29.1327](#), as applicable;
 - (2) The vertical acceleration sensor is rigidly attached, and located longitudinally within the approved centre of gravity limits of the rotorcraft;
 - (3)
 - (i) It receives its electrical power from the bus that provides the maximum reliability for operation of the flight recorder without jeopardising service to essential or emergency loads; and
 - (ii) It remains powered for as long as possible without jeopardising the emergency operation of the rotorcraft;
 - (4) There is an aural or visual means for pre-flight checking of the recorder for proper recording of data in the storage medium;
 - (5) Except for recorders powered solely by the engine-driven electrical generator system, there is an automatic means to stop the recording within 10 minutes after any crash impact;
 - (6) If the cockpit voice recorder function is also performed by the recorder and no other recorder is installed on board the rotorcraft, any single electrical failure that is external to the recorder does not disable both the cockpit voice recorder function and the flight data recorder function; and
 - (7) If another recorder is installed on board the rotorcraft to perform the cockpit voice recorder function, any single electrical failure that is external to the recorder dedicated to the flight data recorder function does not disable both the recorders.
- (b) The container of the recording medium must be located and mounted so as to minimise the probability of the container rupturing, the recording medium being destroyed, or the underwater locating device failing, as a result of any possible combinations of:
- impact with the Earth's surface;
 - the heat damage caused by post-impact fire; and
 - immersion in water.
- (c) A correlation must be established between the flight data recorder readings of airspeed, altitude, and heading and the corresponding readings (taking into account correction factors) of the first pilot's instruments. This correlation must cover the airspeed range over which the aircraft is to be operated, the range of altitude to which the aircraft is limited, and 360° of heading. Correlation may be established on the ground as appropriate.
- (d) The container of the flight data recorder must comply with the specifications in [CS 29.1457\(g\)](#) that are applicable to the container of the cockpit voice recorder.

[Amdt No: 29/7]

[Amdt No: 29/9]

AMC 29.1459 Flight Data Recorders

ED Decision 2021/010/R

This AMC provides further guidance and acceptable means of compliance to supplement FAA AC 29-2C § AC 29.1459. § 29.1459, to meet EASA's interpretation of [CS 29.1459](#). As such, it should be used in conjunction with the FAA AC.

1. General

The installation of a recorder with an ETSO authorisation against ETSO-C124 (or equivalent standard accepted by EASA) satisfies the approval requirement in CS 29.1459(a).

In showing compliance with [CS 29.1459](#), the applicant should take into account EUROCAE Document ED-112A 'MOPS for Crash-Protected Airborne Recorder Systems' or a later revision.

'FDR system' designates the flight data recorder (FDR) and its dedicated equipment. It may include the following items as appropriate to the aircraft:

- a. Equipment necessary to:
 - i. acquire and process analogue and digital sensor signals;
 - ii. store the recorded data in a crash-survivable recording medium; and
 - iii. when necessary, support dedicated sensors.
- b. Digital data buses and/or networks providing communications between the elements of the system.

2. Automatic means to stop the recording after a crash impact

Refer to the Section of [AMC 29.1457](#) titled 'Automatic means to stop the recording after a crash impact'.

3. Combination recorder

Refer to the Section of [AMC 29.1457](#) titled 'Combination recorder'.

4. Instructions for continued airworthiness (ICAs)

When developing the ICAs for the FDR system, required by CS 29.1529 and its Appendix A, the applicant should address all failures that may affect the correct functioning of the FDR system or the quality of the recorded data.

Examples of failures (indicative and non-exhaustive list):

- The loss of the recording function or of the acquisition function of the FDR.

Any parameter (required by CS 29.1459(a)(1) or by the applicable air operations regulations) is missing or is not correctly recorded.

- The failure of a sensor dedicated to the FDR system.
- The failure of a means to facilitate the finding of the FDR recording medium after an accident (e.g. an underwater locating device or an emergency locator transmitter attached to the recorder).
- The failure of the start-and-stop function.
- The failure of a means to detect a crash impact (for the purpose of stopping the recording after a crash impact, or for the purpose of deploying the recorder if it is deployable).

In addition, the ICAs should include the following items, unless the applicant shows that this is not applicable:

- Calibration checks of the parameters from sensors dedicated to the FDR to verify the accuracy of these parameters; and
- FDR decoding documentation:

i. Definitions

FDR decoding documentation: a document that presents the information necessary to retrieve the raw binary data of an FDR data file and convert it into engineering units and textual interpretations.

Fixed frame recording format: a recording format organised in frames and subframes of a fixed length and that are recorded chronologically. ARINC specifications 573 and 717 provide an example of a fixed frame recording format.

Variable frame recording format: a recording format based on recording frames which are individually identified and time stamped, so that their order in the recording file is not important. ARINC specification 767 provides an example of variable frame recording format.

ii. Content of the FDR decoding documentation

The FDR decoding documentation should at least contain information on the following:

- the aircraft make and model;
- the document modification date and time;
- in the case of a fixed-frame recording format:
 - the sync pattern sequence;
 - the number of bits per word, of words per subframe and of subframes per frame; and
 - the time duration of a subframe;
- in the case of a variable-frame recording format, the list of frames, and for each frame:
 - its identification;
 - information on whether the frame is scheduled or event triggered;
 - the recording rate (for a scheduled frame);
 - the frame event condition (for an event-triggered frame); and
 - the list of parameters, by order of recording;
- for every parameter:
 - the identification: name (and mnemonic code or other identification if applicable);
 - the sign convention and the units of the converted values (if applicable);
 - the location of each parameter component in the data frame;

- instructions and equations to assemble the parameter components and convert the raw binary values into engineering units (if applicable); and
 - the conversion to text or the discrete decipher logic (if applicable).
- iii. Format of the FDR decoding documentation
- The FDR decoding documentation should:
- be provided in an electronic format;
 - contain all the information described in paragraph (ii) above; and
 - comply with the standard of ARINC Specification 647A or a later equivalent industry standard.

[Amdt 29/7]

[Amdt 29/9]

CS 29.1460 Data link recorders

ED Decision 2021/010/R

(See [AMC 29.1460](#))

- (a) Each recorder performing the data link recording function required by the operating rules must be approved and must be installed so that it will record the data link communication messages related to air traffic service (ATS) communications to and from the rotorcraft.
- (b) Each data link recorder must be installed so that:
- (1)(i) it receives its electrical power from the bus that provides the maximum reliability for the operation of the recorder without jeopardising service to essential or emergency loads; and
 - (1)(ii) it remains powered for as long as possible without jeopardising the emergency operation of the rotorcraft; and
 - (2) there is an aural or visual means for pre-flight checking of the recorder for the proper recording of data in the storage medium.
- (c) The container of the recording medium must be located and mounted so as to minimise the probability of the container rupturing, the recording medium being destroyed, or the underwater locating device failing as a result of any possible combinations of:
- impact with the Earth's surface;
 - the heat damage caused by a post-impact fire; and
 - immersion in water.
- (d) The container of the data link recorder must comply with the specifications applicable to the container of the cockpit voice recorder in [CS 29.1457\(g\)](#).

[Amdt 29/9]

AMC 29.1460 Data link recorders

ED Decision 2021/010/R

1. General

The installation of a recorder with an ETSO authorisation against ETSO-C177 (or equivalent standard accepted by EASA) satisfies the approval requirement in [CS 29.1460\(a\)](#).

In showing compliance with CS 29.1460, the applicant should take into account EUROCAE Document ED-112A, 'Minimum Operational Performance Specification for Crash Protected Airborne Recorder Systems', dated September 2013, or standard later revision.

'DLR system' designates the data link recorder (DLR) and its dedicated equipment. It may include the following items as appropriate to the aircraft:

- a. A crash-protected recorder.
- b. Digital interface equipment suitable for converting a data link communication message into a format which is to be recorded.
- c. Digital data buses and/or networks providing communications between the elements of the system.

The data link recording function may be performed by:

- a. a cockpit voice recorder;
- b. a flight data recorder;
- c. a flight data and cockpit voice combination recorder; or
- d. a dedicated data link recorder.

2. Combination recorders

Refer to the paragraph of [AMC 29.1457](#) titled 'Combination recorder'.

3. Recorded data

The recorded data should be sufficient to allow investigators, in the framework of an accident or incident investigation, to accurately reconstruct the sequence of data link communications between the aircraft and the air traffic service units, other aircraft and other entities. For this purpose, the data link recording should comply with the following:

- a. EUROCAE Document ED-93, 'Minimum Aviation System Performance Specification for CNS/ATM Message Recording Systems', Section 2.3.1, 'Choice of recording points', and Section 2.3.2, 'Choice of data to be recorded on board the aircraft'; and
- b. EUROCAE Document ED-112A, 'Minimum Operational Performance Specification for Crash Protected Airborne Recorder Systems' (dated September 2013), Part IV, Chapter IV-2, Section IV-2.1.6, 'Data to be recorded'.

4. Instructions for continued airworthiness (ICAs)

When developing the ICAs for the DLR system, required by [CS 29.1529](#) and its [Appendix A](#), the applicant should address all failures that may affect the correct functioning of the DLR system or the integrity of the recorded information.

Examples of failures (indicative and non-exhaustive list):

- The loss of the recording function or of the acquisition function of the DLR.

- Part of the data link communication (required by [CS 29.1460\(a\)](#) or by the Air Operations Regulation) is missing or is corrupted.
- The failure of a means to facilitate the finding of the DLR recording medium after an accident (e.g. an underwater locating device or an emergency locator transmitter attached to the recorder).
- The failure of a means to detect a crash impact (for the purpose of stopping the recording after a crash impact, or for the purpose of deploying the recorder if it is deployable).

In addition, the ICAs should include the following, unless the applicant shows that this is not applicable:

- Documentation to perform the following:
 - i. convert the recorded data back to the original format of the data link communication messages;
 - ii. retrieve the time and the priority of each recorded message; and
 - iii. correlate the recorded messages with the FDR and CVR recordings.

[Amdt 29/9]

CS 29.1461 Equipment containing high energy rotors

ED Decision 2003/16/RM

- (a) Equipment containing high energy rotors must meet sub-paragraphs (b), (c), or (d).
- (b) High energy rotors contained in equipment must be able to withstand damage caused by malfunctions, vibration, abnormal speeds, and abnormal temperatures. In addition:
 - (1) Auxiliary rotor cases must be able to contain damage caused by the failure of high energy rotor blades; and
 - (2) Equipment control devices, systems, and instrumentation must reasonably ensure that no operating limitations affecting the integrity of high energy rotors will be exceeded in service.
- (c) It must be shown by test that equipment containing high energy rotors can contain any failure of a high energy rotor that occurs at the highest speed obtainable with the normal speed control devices inoperative.
- (d) Equipment containing high energy rotors must be located where rotor failure will neither endanger the occupants nor adversely affect continued safe flight.

CS 29.1465 Vibration Health Monitoring

ED Decision 2012/022/R

- (a) If certification of a rotorcraft with vibration health monitoring of the rotors and/or rotor drive systems is requested by the applicant, then the design and performance of an installed system must provide a reliable means of early detection for the identified failure modes being monitored.
- (b) If a vibration health monitoring system of the rotors and/or rotor drive systems is required by the applicable operating rules, then the design and performance of the vibration health monitoring system must, in addition, meet the requirements of this paragraph.

- (1) A safety analysis must be used to identify all component failure modes that could prevent continued safe flight or safe landing, for which vibration health monitoring could provide a reliable means of early detection;
- (2) All typical VHM indicators and signal processing techniques should be considered in the VHM System design;
- (3) Vibration health monitoring must be provided as identified in subparagraph (1) and (2), unless other means of health monitoring can be substantiated.

[Amdt 29/3]

AMC 29.1465 Vibration health monitoring

ED Decision 2012/022/R

a. Explanation

- (1) The purpose of this AMC is to provide an Acceptable Means of Compliance and Guidance Material for the design and certification of Vibration Health Monitoring (VHM) applications. VHM is used to increase the likelihood of detection of dynamic component incipient faults in the rotors and rotor drive systems that could prevent continued safe flight or safe landing, by providing timely indications of potential failures to maintenance personnel.
- (2) Designing a VHM system in accordance with this AMC is expected to achieve the required performance together with acceptable levels of system integrity and reliability for compliance with type certification and/or operational regulations that require VHM of rotor and/or rotor drive systems.
- (3) This AMC defines terms, processes, performance and standards that a VHM system should meet and also the support that a VHM approval holder should provide after the system has entered into service.
- (4) VHM systems which satisfy this AMC and that perform functions, the failure of which are categorised as Minor or No Safety Effect (see paragraph p.), can be accepted without the need for additional compliance with AC 29-2C MG15.

Note 1: FAA AC 29-2C Miscellaneous Guidance (MG)15, which addresses the use of HUMS in Maintenance, is complementary to this AMC.

Note 2: If an applicant wishes to install a VHM system that is not compliant with CS 29.1465(a), it may still be accepted for installation on a “No hazard/No credit” basis. However, it cannot replace any existing type-design maintenance instructions or change the established methods of complying with CS-29.

b. Procedures

- (1) [CS 29.1465](#) does not mandate the fitment of VHM systems. However, if a VHM system is installed on the rotorcraft to meet a type-certification or operational rule, then compliance is required. Three typical scenarios are foreseen as to when compliance by the applicant may be requested. The three scenarios in question are:
 - (i) as a means of demonstrating compliance with an operational rule requiring helicopters be fitted with a VHM system and that operators of such helicopters implement procedures covering data collection, analysis and determination of serviceability;

-
- (ii) as a selected compensating provision to mitigate the probability of a failure condition, identified from the design assessments of [CS 29.547\(b\)](#) and/or [CS 29.917\(b\)](#), from arising;
 - (iii) on a voluntary basis to meet a customer requirement or company objective.
- (2) [CS 29.1465\(a\)](#) allows non-required and/or partial VHM applications with limited capability to monitor specific failure modes to be approved. Such systems can offer safety benefits and it is not the intention here to discourage their installation and use. However, any installed system must meet [CS 29.1301](#) and be of a kind and design appropriate to its intended function and function properly when installed. The guidance given in this AMC is therefore considered to be applicable to these types of VHM systems.
 - (3) Where an operating rule mandates installation of a VHM system, [CS 29.1465\(b\)](#) aims to provide a VHM system capability that maximises the safety benefit. All typical VHM indicators and signal processing techniques should be considered in the VHM design and a system safety assessment undertaken to identify failure modes where VHM could provide early detection of incipient failures. VHM must be provided for all potential failure modes unless other means of health monitoring can be substantiated.
 - (4) The safety analysis required by [CS 29.1465\(b\)\(1\)](#) is limited to rotors and rotor drive systems. The existing design assessments of [CS 29.547](#) and [CS 29.917](#) can be used for this purpose. All component failure modes that could prevent continued safe flight or safe landing (Catastrophic and Hazardous failure conditions) and for which vibration health monitoring could provide a reliable means of early detection must be identified. Previous experience together with the guidance in this AMC can be used to determine failure modes that could benefit from VHM and the applicable techniques that can produce reliable indications of incipient failures.
 - (5) [CS 29.1465\(b\)\(2\)](#) requires the design and performance of the VHM system to consider indicators and processing techniques used on typical existing VHM installations. A non-exhaustive list is provided in Table 1 of this AMC.
 - (6) [CS 29.1465\(b\)\(3\)](#) states that VHM must be provided as identified in subparagraph (b)(1) and (b)(2), unless other means of health monitoring can be substantiated. For many failure modes, there may be other compensating provisions which are capable of providing protection against the risk of premature failure. In such cases, the added benefit of VHM in increasing the likelihood of early detection should be assessed. It will not be necessary to implement VHM for a given failure mode if no safety benefit can be established.
- c. Definitions
- (1) **Alarm:** An Alert that, following additional processing or investigation, has resulted in a maintenance action being required.
 - (2) **Alert:** An indication produced by the VHM system that requires further processing or investigation by the operator to determine if corrective maintenance action is required.
 - (3) **Commercial Off-the-Shelf (COTS):** This term defines equipment hardware and software that is not qualified to aircraft standards.
 - (4) **Controlled Service Introduction (CSI):** A period in-service where capabilities and functions that could not be verified prior to entry into service (including support functions) are evaluated.

- (5) **False Alarm:** An Alert that after further processing or investigation has resulted in unnecessary maintenance action.
 - (6) **False Alert:** This is an Alert that after further processing or investigation has been determined to not require any further action.
 - (7) **Ground-Based System:** A means of access to VHM data, including Alerts, for immediate post-flight fault diagnosis by the responsible maintenance staff.
 - (8) **Prognostic Interval:** The predicted time between an Alarm and the component becoming unairworthy.
 - (9) **Vibration Health Monitoring (VHM):** Use of data generated by processing vibration signals to detect incipient failure or degradation of mechanical integrity.
 - (10) **VHM Application:** A VHM function implemented for a defined purpose.
 - (11) **VHM Indicator:** A VHM Indicator is the result of processing sampled data by applying an algorithm to achieve a single value, which relates to the health of a component with respect to a particular failure mode.
 - (12) **VHM System:** Typically comprises vibration sensors and associated wiring, data acquisition and processing hardware, the means of downloading data from the rotorcraft, the Ground-Based System and all associated instructions for operation of the system.
- d. Component Monitoring Capability
- The scope of the VHM capability is determined by the range of components monitored and their incipient failures which can be detected. For each component to be monitored the range of potential damage being diagnosed should be declared and the principles of the monitoring techniques applied should be described. The health monitoring effectiveness should be demonstrable (see paragraph o).
- e. System Design Considerations
- (1) **Sensors:** They are the hardware that measures vibration. They should provide a reliable signal with an appropriate and defined performance. The position and installation of a vibration sensor is as critical as its performance. Sensor selection, positioning and installation should be designed to enable analysis of the processed signals to discriminate the vibration characteristics of the declared monitored component failure modes. Built-In Test capability is necessary to determine the correct functioning of the sensor. Maintenance instructions should ensure that the correct function, and any calibration, of sensors and their installation are adequately controlled.
 - (2) **Signal Acquisition:** It is likely that processed VHM data will be sensitive to the flight regime of the rotorcraft. For this reason it is desirable to focus data acquisition to particular operating conditions or phases of flight. Consideration should be given to the likely operation of rotorcraft that may utilise the VHM system and the practicality of acquiring adequate data from each flight to permit the Alert and Alarm processing to be performed to the required standard. The method of vibration signal acquisition should be designed so that:
 - (i) The vibration signal sampling rate is sufficient for the required bandwidth and to avoid aliasing with an adequate dynamic range and sensitivity.
 - (ii) The data acquired from the vibration signal should be automatically gathered in specifically defined regimes at an appropriate rate and quantity for the VHM signal processing to produce robust data for defect detection.

- (iii) If the mission profile does not allow regular acquisition of complete data sets, then the data acquisition regimes should be capable of reconfiguration appropriate to particular flight operations.
 - (iv) The acquisition cycle should be designed in such a way that all selected components and their defects are monitored with an adequate frequency irrespective of any interruptions in the cycle due to the operational profile.
- (3) **Signal Processing:** The helicopter’s rotor and rotor drive systems are a mixture of complex and simple mechanical elements. Therefore, the signal processing or the analysis techniques utilised should reflect the complexity of the mechanical elements being monitored as well as the transmission path of the signal and should be demonstrated as being appropriate to the failure modes to be detected. The objective of processing the sampled data should be to produce VHM Indicators that clearly relate to vibration characteristics of the monitored components, from which the health of these components can be determined. A key part of the success of in-service VHM is the signal-to-noise enhancement techniques such as vibration signal averaging for gears and signal band-pass filtering and enveloping for bearings. These techniques are used to generate enhanced component vibration signatures prior to the calculation of the VHM Indicators. Accordingly, the method of signal enhancement should be shown to be effective. The method of signal processing and the analysis techniques utilised to generate the data used for defect detection should be defined for the claimed defect detection capability (see Table 1 below).

Table 1: Typical Vibration Health Monitoring Indicators & Signal Processing Techniques

Assembly	Component Type	Types of VHM indicators used
Engine to main gearbox input drive shafts	Shafts	Fundamental shaft order and harmonics
Gearboxes	Shafts	Fundamental shaft order and harmonics
	Gears	Gear meshing frequency and harmonics, modulation of meshing waveform, impulse detection and energy measurement, non-mesh-related energy content
	Bearings	High frequency energy content, impulse detection, signal envelope modulation patterns and energies correlated with bearing defect frequencies
Tail rotor drive shaft	Shafts	Fundamental shaft order and harmonics
	Hangar Bearings	As for gearbox bearings, but can utilise simple band-passed signal energy measurements
Oil cooler	Oil Cooler Blower and Drive Shaft	Fundamental shaft order and harmonics, blade pass frequency
Main and Tail rotor	Rotors	Fundamental shaft order and harmonics up to blade pass frequency, plus multiples of this.

Recording and storing of some raw vibration data and the processed vibration signal, from which the Indicators are derived, may also be of significant diagnostic value. Typical signal processing techniques include;

- (i) Asynchronous Power Spectrum where phase information or frequency tracking is not required.
- (ii) Synchronous Spectrum where phase information or frequency tracking is required.
- (iii) Band-pass filtered signal Envelope Power Spectrum Analysis (a recommended technique for gearbox bearings).
- (iv) Synchronous Averaging for time and frequency domain signal analysis (a recommended technique for gearbox gears).
- (v) Band-pass filtering and the measurement of filtered signal statistics, including crest factor (can be used for bearings not within engines or gearboxes).
- (vi) Further signal enhancement techniques are typically required in the calculation of certain VHM indicators targeted at detecting specific defect-related features (e.g. localised signal distortion associated with a gear tooth crack).

Note 1: When showing compliance to [CS 29.1465\(a\)](#), for non-required and/or partial VHM applications with limited capability to monitor specific failure modes, it is not necessary to address the scope of VHM capability stated in Table 1.

Note 2: When showing compliance to [CS 29.1465\(b\)](#), it is not always necessary for the VHM system to cover the complete capability defined in Table 1. However, absence of any of these areas, and/or techniques, should be substantiated. It is acknowledged that the above provides a prescriptive scope for monitoring rotor and rotor drive system components. If alternative methods are proposed, which can be shown to be as effective and reliable as those prescribed and which are to the satisfaction of the Agency, then these can also be accepted.

f. Data Management

The data transfer process from the rotorcraft to the maintenance personnel interface should be sufficient to determine all the VHM Indicators post flight. The upload/download should have minimal impact on flight operations. VHM data should be accessible in order to permit alternative analysis and comparison. The following should be specified:

- (1) Data transfer, processing, networking, data integrity assurance.
- (2) Methods to ensure the reliability of this process.
- (3) The time for upload/download and retrieval of data and/or health report.
- (4) Facilities for the warehousing of all of the data downloaded from the VHM systems and to permit timely access to the data.

g. Alert Management

- (1) VHM Alert Generation: VHM Alert criteria should be applied to every monitored component. VHM Alerts are produced to indicate possible anomalous behaviour or a specific defect.

Note: The fixed or learnt thresholds for each individual health monitoring indicator may have a limited capability to detect incipient failures in a timely manner. This is because the process for threshold setting is sometimes a compromise between increasing sensitivity and incurring a higher risk of false alarms, or reducing sensitivity, which will

delay the point at which a rising indicator value will trigger an alert. In-service experience has shown that MGB component fatigue failures can propagate from initiation to failure in a relatively short period of time, thus the use of fixed thresholds alone may not provide a timely indication of impending failure. One characteristic that can often provide an earlier indication of anomalous behaviour is the rate of change of a health monitoring indicator, and automatic trend detection software has been developed and shown to be effective. Another method, commonly referred to as Advanced Anomaly Detection (AAD), combines numerous indicators into multi-dimensional parameters, whereby simultaneous changes of multiple indicators can provide increased confidence of the anomalous behaviour at an earlier point in the failure process. (Further information on AAD can be found in Related documents v.(3)).

- (2) VHM Alert Management: Diagnostic processes are required to determine if VHM driven maintenance of the rotorcraft is necessary.

h. Pilot Interface

Pilot interaction with the VHM system, if any, should be specified and should not adversely impact on pilot workload.

Note: The level of system integrity for VHM provided under this AMC is not sufficient to support the provision of in-flight cockpit VHM alerts.

i. Maintenance Personnel Interface

The person responsible for releasing a rotorcraft into service should be provided with VHM data, maintenance recommendations and VHM system Built-In Test data necessary to release that rotorcraft. This should include the ability to view VHM Indicators, trend data and detection criteria, including thresholds, for relevant VHM parameters from that rotorcraft. These capabilities should be available locally to maintenance personnel for immediate post flight fault diagnosis.

j. Fleet Diagnostic Support Interface

Where an operator has multiple rotorcraft of the same type, facilities should be made available to the operator to support the analysis of all data acquired by the VHM systems in the operator's fleet. The operator and all parties supporting the operator should have remote, multi-user and timely access to the data and the diagnostic processes in order to assist in determining the continued airworthiness of their fleet.

k. VHM system installation

The VHM system installation must comply with CS-29, as applicable to the specific rotorcraft type.

l. Ground-Based System Architecture

Any Ground-Based System Architecture requirements should be specified (see paragraph q. Technical Publications). The Ground-Based System may include COTS hardware, software and services, compatible with the Data Management objectives of paragraph (f) above.

m. Software

- (1) For the case where the VHM system is stand alone

All software that makes up the VHM processing, whether airborne or ground-based, is to be produced to the software quality standard required to achieve the necessary level of system integrity.

All COTS software should be identified and should be of a quality standard that does not compromise the overall system's integrity.

All ground-based system software (specifically developed for VHM processing and COTS) should be developed to EUROCAE ED-109A/RTCA DO-278A Assurance Level 5 (AL5). DO 278 Assurance Level 5 (AL5) provides an acceptable method for acceptance of ground-based systems which include COTS.

VHM applications with hazard severity level Major or higher are addressed by MG15 and not AMC 29.1465.

Note: EUROCAE ED-12C/RTCA DO-178C Level D software for airborne systems and EUROCAE ED-109A/RTCA DO-278A Assurance Level 5 for non-airborne systems can be applied where VHM is utilised in addition to traditional helicopter design provisions. This will not require certification to a level any higher than Minor, based on the required reliability for these VHM applications. Should a design be proposed where greater reliance was placed solely on VHM, this would not be in compliance with the "minimise" target of CS 29.917(b) and CS 29.547(b).

- (2) For the case where the VHM is integrated into a system with other functions

Software partitioning is addressed in both EUROCAE ED-12C/RTCA DO-178C and EUROCAE ED-109A/RTCA DO-278A.

n. Performance Criteria

- (1) Signal Acquisition

The applicant for VHM system certification should specify the rate of acquisition of data sets for defect diagnostics in consistent flight regimes.

As a target, the total data set acquired in a flight should be sufficient for complete and reliable diagnostics to be produced for every flight above a defined duration in stabilised conditions. As a minimum, at least the data set for all components should be automatically obtained on each flight of greater than 30 minutes in stabilised conditions without the need for in-flight pilot action. For operations which do not contain periods of stabilised operation of greater than 30 minutes, alternative procedures need to be incorporated to ensure that the total data set is recorded within a specified number of flying hours related to the minimum adequate frequency of data collection determined under AMC 29.1465(e)(2), and in any case no longer than 25 flying hours.

Where subsystem performance is critical or relied upon to achieve the quoted defect probability of detection or False Alert rate, such as sensor accuracy, dynamic range or bandwidth, then this should be quoted.

- (2) Data transfer and Storage Capability

The VHM defect status data should be capable of being downloaded during rotors running turnarounds.

All the data sets acquired should be stored until successfully transferred to the Ground-Based System. The storage capacity should not be less than 25 flying hours.

The applicant should describe the maximum interval between data downloads for which the system memory capacity is not exceeded.

In the event that a complete data set is not recorded, the data transfer process should be capable of downloading a partial data set to the Ground-Based System. In such a case,

the ground station should alert maintenance personnel of a missing maintenance log or that the data set provided is incomplete.

(3) VHM Alert generation and fault detection performance

The Alert and Alarm generation processing should be designed to achieve a claimed probability of detection that is acceptable to the Agency for each component defect being monitored. Processing to isolate False Alerts and False Alarms should not result in an unacceptable workload. Also this processing should not compromise the verification and validating evidence of claimed defect detection performance. This workload should be assessed prior to completion of the Controlled Service Introduction (CSI) phase.

o. Performance Validation

The applicant should demonstrate how the VHM system provides an acceptable defect detection performance. Experiences gained during the CSI phase should be reviewed to confirm that this is the case.

(1) Validation methodology

It is not practical to verify predicted component defect detection performance for all failure modes by in-service experience or by trials. Therefore it is necessary that the methodology employed can be clearly substantiated from an understanding of how the failure mechanisms affect vibration and how the diagnostic processing will generate appropriate Alarms. Direct or indirect evidence should be provided as follows:

(i) Direct evidence includes:

- (A) Actual service experience on VHM equipped rotorcraft of the same or of similar type and configuration, including information from module strips, component removals, inspections and other investigations which is relevant to the review of VHM system performance.
- (B) Test rig results.
- (C) Rotorcraft trials, investigating cause and effect (for example, introducing degrees of imbalance or mal-alignment and calibrating the techniques response). This should be supported by flight experience to demonstrate that the False Alert criterion can be met and that all the diagnostic indicators lie within reasonable ranges.

Note: A mechanism should be established for requesting maintenance feedback with respect to component failure/degradation and VHM indication. The cases are as follows:

- to verify component condition following rejection after an Alarm, in order to establish the diagnostic accuracy, probability of detection and the False Alarm rate.
- to inform the TC holder in the event that a failure occurs which is monitored by VHM, where the VHM fails to provide an Alarm. This will provide the missed Alarm rate.

(ii) Indirect evidence includes:

- (A) Evidence as to the provenance of the technology and its suitability for application to rotorcraft.
- (B) Reference to adequate performance in other applications.

(C) Modelling of the processes

The types of evidence stated in (i) and (ii) above can be used to substantiate:

- (A) That the Alert processing methodology can deliver an adequate False Alarm rate, Prognostic Interval and probability of detection.
- (B) Data acquired in a flight is sufficient for complete and reliable diagnostics to be produced for every flight above a minimum duration in stabilised conditions.
- (C) The sensitivity, dynamic range and bandwidth of the signal acquisition are adequate.
- (D) That the processed vibration signal-to-noise ratio is acceptable and that it is capable of discriminating the features required to identify potential incipient defects for the monitored components.

Typically, the False Alarm Rate and Alert Management performance will be validated during the CSI phase.

p. VHM System Criticality

- (1) It is necessary to understand the criticality of a VHM function in order to determine the appropriate level of integrity required. Criticality describes the severity of the end result of a VHM application failure/malfunction and is determined by an assessment that considers the safety effect that the VHM application can have on the rotorcraft.

Note: The criticality of the VHM function relates only to its contribution to the overall integrity of the component being monitored.

- (2) The criticality categories are defined in FAA AC 29.1309. In order to determine the appropriate level of criticality of the VHM function, it will be necessary to perform a safety assessment or functional hazard analysis on the rotorcraft systems affected. This should be carried out in accordance with standard safety assessment requirements such as CS 29.1309. In performing this assessment it will be necessary to consider the possibility of dormant and common mode failures and the possibility of the VHM system introducing additional risks, e.g. due to the False Alarm rate.
- (3) Different VHM Systems have functions that can have different levels of criticality, such as those described below:
 - (i) Many VHM applications provide a method of enhanced health monitoring which adds to traditional techniques that have been used to establish an acceptable level of component integrity. Where a VHM application is not necessary for compliance with [CS 29.547\(b\)](#) and/or [CS 29.917\(b\)](#), the failure effect of these functions is considered to be 'No Safety Effect' when there have been no changes to the traditional techniques.
 - (ii) Where a VHM application is identified as a compensating provision in order to comply with [CS 29.547\(b\)](#) and/or [CS 29.917\(b\)](#), then the failure criticality is considered to be 'Minor'. A proposed design that places greater reliance on VHM would not be deemed compliant with the "minimise" target of [CS 29.547\(b\)](#) and [CS 29.917\(b\)](#).
 - (iii) When an on-board VHM system is used to replace existing portable test equipment, and is performing an identical function, (though not necessarily utilising the same method of detection), this can be classified as 'No Safety Effect', providing that in such cases there will be no reduction in scheduled component

inspection, or extension of overhaul or replacement intervals. A level of system integrity related to Minor criticality supports the reduction or elimination of check flights after standard vibration reduction checks and/or adjustments (rotor track and balance, balancing, absorber tuning, etc.).

As this equipment is airborne equipment, it is considered that a quality standard for the software used is necessary. For this reason software to EUROCAE ED-12C/RTCA DO-178C Level D is necessary.

Note: As there should be no effect on safety of the helicopter as a result of utilising the airborne system, it will not be necessary to carry out recurring independent verification means.

- (iv) When a validated on-board VHM system is used to replace an existing maintenance task, this can be considered to be minor if the validated detection capability and integrity is better than the maintenance task being replaced. For example, VHM system monitoring of grease packed bearings which results in modification to manual inspection intervals.

For use of EUROCAE ED-12C/RTCA DO-178C level D software, it will be necessary to carry out periodic functional verification of the VHM system for dormant hardware or software failure or following a hardware or software change. An alternative approach to periodic functional verification is the retention of the original inspection at an increased interval. These instructions will need to be specified in the ICA.

Note: In cases (iii) and (iv), it is essential that the reliability and accuracy of the VHM must be equal to or better than that of the process it is replacing. This will require direct or indirect verification such as seeded fault testing (bench) or operational experience in accordance with paragraph (o) of this AMC. Compliance with paragraph (o) may require access to the design data and MSG3 analysis (or equivalent) used during substantiation of the original maintenance task.

q. Technical Publications

Appropriate Instructions for Continued Airworthiness (ICA) are required by [CS 29.1529](#) and Appendix A. ICA and other supporting data should be available to operators and maintenance organisations before entry into service and should be updated whenever necessary during the service life of the system.

ICA should include the following:

- (1) Guidance for the interpretation of the diagnostic information produced by the VHM system for all components monitored, to include Alert and Alarm management, a description of the indicators, and Alert generation methods.
- (2) Maintenance instructions defining the actions to be taken in the event of all Alarms, including the appropriate rotorcraft inspections (or other maintenance) necessary for fault-finding to verify the Alarm.
- (3) Scheduled maintenance to be carried out on the VHM system itself, including inspections to confirm sensor performance and system functionality.
- (4) Instructions for all maintenance of the VHM System, including Illustrated Parts Catalogue/Illustrated Parts Breakdown and wiring diagrams.

- (5) Installation instructions for retrofit VHM systems addressing all aspects of VHM system integration with the rotorcraft.
- (6) A recommendation of the maximum period of unavailability of VHM functions for inclusion in the rotorcraft Master Minimum Equipment List (MMEL) or maintenance instructions, as required.
- (7) Operating Instructions detailing the operation of the VHM system including any ground-based elements or functions.
- (8) Required Flight Manual instructions.

r. Training

Suitable training should be made available with respect to operation and maintenance of the VHM system. This training should be made available prior to initial delivery of the VHM system. Training material and training courses should evolve to include lessons learned from service experience and appropriate diagnostic case studies. Training material and training courses should cover:

- (1) Installation of the VHM system.
- (2) Line maintenance of the VHM system (including VHM system fault-finding, any calibration necessary).
- (3) Use of the VHM System during Line maintenance to monitor the rotorcraft, including the data transfer, interface with data analysis, response to Alerts and Alarm processing, rotorcraft fault-finding and other Line diagnostic actions.
- (4) Necessary system administration functions, covering operational procedures relating to data transfer and storage, recovery from failed down loads and the introduction of hardware and software modifications.
- (5) Any data analysis and reporting functions that are expected to be performed by the operator.

s. Product Support — System Data and Diagnostic Support

The necessary support should be provided to operators to ensure that the VHM system remains effective and compliant with any applicable requirements throughout its service life. The support provided should cover both the VHM system itself (i.e. system support), and the data generated (data and diagnostic support).

The data and diagnostic support provided should ensure that:

- (1) The operator has timely access to approved external data interpretation and diagnostic advice. It is the responsibility of the approval holder to provide this information; however, this may also involve.

t. Minimum Equipment List (MEL) Recommendation

The MEL should address the Airborne Element of the VHM system. The maximum period for absence of an assessment of any VHM indicator, to which Alert criteria are applied, should be limited to a suitable period and should not exceed 25 hours.

Note: If the VHM data is subject to close monitoring due to an increased likelihood of a developing mechanical problem, the maximum alleviation of 25 hours provided by the MMEL should be reduced or removed.

It is recommended that the VHM system automatically generates an indication to the operator if no VHM data has been gathered for a particular component for longer than a certain number of hours.

In the absence of any VHM data, reversion to the standard procedures used to ensure component integrity should be made.

u. Controlled Service Introduction

- (1) When a VHM system initially enters into service or it is adapted to a new application on a different rotorcraft type, then a Controlled Service Introduction (CSI) phase is usually necessary in order to fully validate the system performance.
- (2) If a CSI phase is considered to be necessary, then this activity should be detailed in a CSI plan to be approved prior to release to service, detailing the VHM applications being developed and the criteria for the successful completion of the CSI. Such criteria should address:
 - (i) The number of rotorcraft, number of operators, calendar time and flying hours.
 - (ii) Validation of specific sensor performance.
 - (iii) If targeted failures or defects occur during the CSI phase, it should be verified that the applicable VHM system applications provide an accurate timely Alarm. (iv) Validate the False Alarm rate.
 - (v) Evolution of Alert criteria.
 - (vi) Validate the timeliness and integrity of the end-to-end data transfer and analysis process.
 - (vii) Demonstration of specific support processes.
 - (viii) System hardware reliability.
 - (ix) System maintainability.
 - (x) System usability (including rotorcraft and ground based man-machine interfaces).
 - (xi) ICA usability.
 - (xii) Effectiveness of training.
 - (xiii) Effectiveness and timeliness of diagnostic support.
- (3) A CSI Plan should be agreed between the applicant for VHM system certification and the Agency prior to initial approval of the VHM system. This plan should then be implemented by the VHM approval holder and the operator(s) and monitored periodically by the Agency. Prior to any VHM function replacing an existing maintenance task, it may be necessary to complete a period of in-service operation. The validation and improvement activities should be detailed in this plan which should also detail the objectives that must be achieved before the CSI can be considered to be completed.
- (4) Formal CSI meetings should take place in order to review service experience against the CSI criteria. They should involve the VHM system approval holder, the Agency (as applicable), and the operators.
- (5) Once all parties agree that the intent of the CSI has been satisfied, the CSI phase will be considered closed. The process of review and closure should be recorded.

v. Related documents

- (1) Federal Aviation Administration (FAA) AC 29-2C MG 15 'Airworthiness Approval of Rotorcraft Health Usage Monitoring Systems (HUMS)'
http://www.faa.gov/regulations_policies/advisory_circulars/
- (2) CAP 753: Helicopter Vibration Health Monitoring (VHM) — Guidance Material for Operators Utilising VHM in Rotor and Rotor Drive Systems of Helicopters
<http://www.caa.co.uk/docs/33/CAP753.pdf>
- (3) CAA Paper 2011/01: Intelligent Management of Helicopter Vibration Health Monitoring Data
http://www.caa.co.uk/docs/33/2011_01RFS.pdf

[Amdt 29/3]

CS 29.1470 Emergency locator transmitter (ELT)

ED Decision 2018/007/R

Each emergency locator transmitter, including sensors and antennae, required by the applicable operating rule, must be installed so as to minimise damage that would prevent its functioning following an accident or incident.

[Amdt No: 29/5]

AMC 29.1470 Emergency locator transmitters (ELTs)

ED Decision 2018/007/R

(a) Explanation

The purpose of this AMC is to provide specific guidance for compliance with [CS 29.1301](#), [CS 29.1309](#), [CS 29.1470](#), [CS 29.1529](#) and [CS 29.1581](#) regarding emergency locator transmitters (ELT) and their installation.

An ELT is considered to be a passive and dormant device whose status is unknown until it is required to perform its intended function. As such, its performance is highly dependent on proper installation and post-installation testing.

(b) References

Further guidance on this subject can be found in the following references:

- (1) ETSO-C126b 406 and 121.5 MHz Emergency Locator Transmitter;
- (2) ETSO-C126b 406 MHz Emergency Locator Transmitter;
- (3) FAA TSO-C126b 406 MHz Emergency Locator Transmitter (ELT);
- (4) EUROCAE ED-62A MOPS for aircraft emergency locator transmitters (406 MHz and 121.5 MHz (optional 243 MHz));
- (5) RTCA DO-182 Emergency Locator Transmitter (ELT) Equipment Installation and Performance; and
- (6) RTCA DO-204A Minimum Operational Performance Standards for 406 MHz Emergency Locator Transmitters (ELTs).

(c) Definitions

- (1) ELT (AF): an ELT (automatic fixed) is intended to be permanently attached to the rotorcraft before and after a crash, is automatically activated by the shock of the crash, and is designed to aid search and rescue (SAR) teams in locating a crash site.
- (2) ELT (AP): an ELT (automatic portable) is intended to be rigidly attached to the rotorcraft before a crash and is automatically activated by the shock of the crash, but is readily removable from the rotorcraft after a crash. It functions as an ELT (AF) during the crash sequence. If the ELT does not employ an integral antenna, the rotorcraft-mounted antenna may be disconnected and an auxiliary antenna (stowed in the ELT case) connected in its place. The ELT can be tethered to a survivor or a life raft. This type of ELT is intended to assist SAR teams in locating the crash site or survivor(s).
- (3) ELT (S): an ELT (survival) should survive the crash forces, be capable of transmitting a signal, and have an aural or visual indication (or both) that power is on. Activation of an ELT (S) usually occurs by manual means but automatic activation (e.g. activation by water) may also apply.
 - (i) ELT (S) Class A (buoyant): this type of ELT is intended to be removed from the rotorcraft, deployed and activated by survivors of a crash. It can be tethered to a life raft or a survivor. The equipment should be buoyant and it should be designed to operate when floating in fresh or salt water, and should be self-righting to establish the antenna in its nominal position in calm conditions.
 - (ii) ELT (S) Class B (non-buoyant): this type of ELT should be integral to a buoyant device in the rotorcraft, deployed and activated by the survivors of a crash.
- (4) ELT (AD) or automatically deployable emergency locator transmitter (ADELT): this type of automatically deployable ELT is intended to be rigidly attached to the rotorcraft before a crash and automatically deployed after the crash sensor determines that a crash has occurred or after activation by a hydrostatic sensor. This type of ELT should float in water and is intended to aid SAR teams in locating the crash site.
- (5) A crash acceleration sensor (CAS) is a device that detects an acceleration and initiates the transmission of emergency signals when the acceleration exceeds a predefined threshold (Gth). It is also often referred to as a 'g switch'.

(d) Procedures

(1) Installation aspects of ELTs

The installation of the equipment should be designed in accordance with the ELT manufacturer's instructions.

(i) Installation of the ELT transmitter unit and crash acceleration sensors

The location of the ELT should be chosen to minimise the potential for inadvertent activation or damage by impact, fire, or contact with passengers, baggage or cargo.

The ELT transmitter unit should ideally be mounted on primary rotorcraft load-carrying structures such as trusses, bulkheads, longerons, spars, or floor beams (not rotorcraft skin). Alternatively, the structure should meet the requirements of the test specified in 6.1.8 of ED-62A. For convenience, the requirements of this test are reproduced here, as follows:

'The mounts shall have a maximum static local deflection no greater than 2.5 mm when a force of 450 Newtons (100 lbf) is applied to the mount in the most flexible

direction. Deflection measurements shall be made with reference to another part of the airframe not less than 0.3 m or more than 1.0 m from the mounting location.'

However, this does not apply to an ELT (S), which should be installed or stowed in a location that is conspicuously marked and readily accessible, or should be integral to a buoyant device such as a life raft, depending on whether it is of Class A or B.

A poorly designed crash acceleration sensor installation can be a source of problems such as nuisance triggers, failures to trigger and failures to deploy.

Nuisance triggers can occur when the crash acceleration sensor does not work as expected or is installed in a way that exposes it to shocks or vibration levels outside those assumed during equipment qualification. This can also occur as a result of improper handling and installation practices.

A failure to trigger can occur when an operational ELT is installed such that the crash sensor is prevented from sensing the relevant crash accelerations.

Particular attention should be paid to the installation orientation of the crash acceleration sensor. If the equipment contains a crash sensor with particular installation orientation needs, the part of the equipment containing the crash sensor will be clearly marked by the ELT manufacturer to indicate the correct installation orientation(s).

The design of the installation should follow the instructions contained in the installation manual provided by the equipment manufacturer. In the absence of an installation manual, in general, in the case of a helicopter installation, if the equipment has been designed to be installed on fixed-wing aircraft, it may nevertheless be acceptable for a rotorcraft application. In such cases, guidance should be sought from the equipment manufacturer. This has typically resulted in a recommendation to install the ELT with a different orientation, e.g. of 45 degrees with respect to the main longitudinal axis (versus zero degrees for a fixed wing application). This may help the sensor to detect forces in directions other than the main longitudinal axis, since, during a helicopter crash, the direction of the impact may differ appreciably from the main aircraft axis. However, some ELTs are designed specifically for helicopters or designed to sense forces in several axes.

(ii) Use of hook and loop style fasteners

In several recent aircraft accidents, ELTs mounted with hook and loop style fasteners, commonly known by the brand name Velcro[®], have detached from their aircraft mountings. The separation of the ELT from its mount could cause the antenna connection to be severed, rendering the ELT ineffective.

Inconsistent installation and reinstallation practices can lead to the hook and loop style fastener not having the necessary strength to perform its intended function. Furthermore, the retention capability of the hook and loop style fastener may degrade over time, due to wear and environmental factors such as vibration, temperature, or contamination. The safety concern about these attachments increases when the ELT manufacturer's instructions for continued airworthiness (ICA) do not contain specific instructions for regularly inspecting the hook and loop style fasteners, or a replacement interval (e.g. Velcro life limit). This concern applies, regardless of how the hook and loop style fastener is installed in the aircraft.

Separation of ELTs has occurred, even though the associated hook and loop style fastener design was tested during initial European Technical Standard Order (ETSO) compliance verification against crash shock requirements.

Therefore, it is recommended that when designing an ELT installation, the ELT manufacturer's ICA is reviewed and it is ensured that the ICA for the rotorcraft (or the modification, as applicable) appropriately addresses the in-service handling of hook and loop style fasteners.

It is to be noted that ETSO/TSO-C126b states that the use of hook and loop fasteners is not an acceptable means of attachment for automatic fixed (AF) and automatic portable (AP) ELTs.

(iii) ELT antenna installation

This section does not apply to the ELT (S) or ELT (AD) types of ELT.

The most recurrent issue found during accident investigations concerning ELTs is the detachment of the antenna (coaxial cable), causing the transmission of the ELT unit to be completely ineffective.

Chapter 6 of ED-62A addresses the installation of an external antenna and provides guidance, in particular, on:

- (A) the location of the antenna;
- (B) the position of the antenna relative to the ELT transmission unit;
- (C) the characteristics of coaxial-cables; and
- (D) the installation of coaxial-cables.

Any ELT antenna should be located away from other antennas to avoid disruption of the antenna radiation patterns. In any case, during installation of the antenna, it should be ensured that the antenna has a free line of sight to the orbiting COSPAS-SARSAT satellites at most times when the aircraft is in the normal flight attitude.

Ideally, for the 121.5 MHz ELT antenna, a separation of 2.5 metres from antennas receiving very high frequency (VHF) communications and navigation data is sufficient to minimise unwanted interference. The 406 MHz ELT antenna should be positioned at least 0.8 metres from antennas receiving VHF communications and navigation data to minimise interference.

External antennas which have been shown to be compatible with a particular ELT will either be part of the ETSO/TSO-approved ELT or will be identified in the ELT manufacturer's installation instructions. Recommended methods for installing antennas are outlined in FAA AC 43.13-2B.

The antenna should be mounted as close to the respective ELT as practicable. Provision should be taken to protect coaxial cables from disconnection or from being cut. Therefore, installation of the external antenna close to the ELT unit is recommended. Coaxial cables connecting the antenna to the ELT unit should not cross rotorcraft production breaks.

In the case of an external antenna installation, ED-62A recommends that its mounting surface should be able to withstand a static load equal to 100 times the antenna's weight applied at the antenna mounting base along the longitudinal axis

of the rotorcraft. This strength can be substantiated by either test or conservative analysis.

If the antenna is installed within a fin cap, the fin cap should be made of an RF-transparent material that will not severely attenuate the radiated transmission or adversely affect the antenna radiation pattern shape.

In the case of an internal antenna location, the antenna should be installed as close to the ELT unit as practicable, insulated from metal window casings and restrained from movement within the cabin area. The antenna should be located such that its vertical extension is exposed to an RF-transparent window. The antenna's proximity to the vertical sides of the window and to the window pane and casing as well as the minimum acceptable window dimensions should be in accordance with the equipment manufacturer's instructions.

The voltage standing wave ratio (VSWR) of the installed external antenna should be checked at all working frequencies, according to the test equipment manufacturer's recommendations, during the first certification exercise for installation on a particular rotorcraft type.

Coaxial cables between the antenna and the ELT unit should be provided on each end with an RF connector that is suitable for the vibration environment of the particular installation application. When the coaxial cable is installed and the connectors mated, each end should have some slack in the cable, and the cable should be secured to rotorcraft structures for support and protection.

In order to withstand exposure to fire or flames, the use of fire-resistant coaxial cables or the use of fire sleeves compliant to SAE AS1072 is recommended.

(2) Deployment aspects of ELTs

Automatically deployable emergency locator transmitters (ADELTs) have particularities in their designs and installations that need to be addressed independently of the general recommendations.

The location of an ADELT and its manner of installation should minimise the risk of injury to persons or damage to the rotorcraft in the event of its inadvertent deployment. The means to manually deploy the ADELT should be located in the cockpit, and be guarded, such that the risk of inadvertent manual deployment is minimised.

Automatically deployable ELTs should be located so as to minimise any damage to the structure and surfaces of the rotorcraft during their deployment. The deployment trajectory of the ELT should be demonstrated to be clear of interference from the airframe or any other parts of the rotorcraft, or from the rotor in the case of helicopters. The installation should not compromise the operation of emergency exits or of any other safety features.

In some helicopters, where an ADELT is installed aft of the transport joint in the tail boom, any disruption of the tail rotor drive shaft has the potential to disrupt or disconnect the ADELT wiring. From accident investigations, it can be seen that if a tail boom becomes detached, an ADELT that is installed there, aft of the transport joint, will also become detached before signals from sensors that trigger its deployment can be received.

Therefore, it is recommended to install the ADELT forward of the transport joint of the tail boom. Alternatively, it should be assured that ELT system operation will not be impacted by the detachment of the structural part on which it is installed.

The hydrostatic sensor used for automatic deployment should be installed in a location shown to be immersed in water within a short time following a ditching or water impact, but not subject to water exposure in the expected rotorcraft operations. This assessment should include the most probable rotorcraft attitude when crashed, i.e. its capability to keep an upright position after a ditching or a crash into water.

The installation supporting the deployment feature should be demonstrated to be robust to immersion. Assuming a crash over water or a ditching, water may immerse not only the beacon and the hydrostatic sensor, which is designed for this, but also any electronic component, wires and the source of power used for the deployment.

(3) Additional considerations

(i) Human factors (HF)

The ELT controls should be designed and installed so that they are not activated unintentionally. These considerations should address the control panel locations, which should be clear from normal flight crew movements when getting into and out of the cockpit and when operating the rotorcraft, and the control itself. The means for manually activating the ELT should be guarded in order to avoid unintentional activation.

(ii) The rotorcraft flight manual (RFM) should document the operation of the ELT, and in particular, any feature specific to the installed model.

(iii) Batteries

An ELT operates using its own power source. The ELT manufacturer indicates the useful life and expiration date of the batteries by means of a dedicated label. The installation of the ELT should be such that the label indicating the battery expiration date is clearly visible without requiring the removal of the ELT or other LRU from the rotorcraft.

(4) Maintenance and inspection aspects

This Chapter provides guidance for the applicant to produce ICA related to ELT systems. The guidance is based on Chapter 7 of ED-62A.

(i) The ICA should explicitly mention that:

(A) The self-test function should be performed according to the manufacturer's recommendation but no less than once every 6 months. Regulation at the place of operation should be considered when performing self-tests, as national aviation authorities (NAAs) may have established specific procedures to perform self-tests.

(B) As a minimum, a periodic inspection should occur at every battery replacement unless an inspection is required more frequently by the airworthiness authorities or the manufacturer.

(ii) Each inspection should include:

(A) the removal of all interconnections to the ELT antenna, and inspection of the cables and terminals;

(B) the removal of the ELT unit, and inspection of the mounting;

(C) access to the battery to check that there is no corrosion;

- (D) a check of all the sensors as recommended by Chapter 7.6 of ED-62A — Periodic inspection; and
 - (E) measurement of the transmission frequencies and the power output.
- (5) Rotorcraft flight manual/flight manual supplement (RFM/RFMS)

The rotorcraft flight manual (RFM) or supplement (RFMS), as appropriate, should contain all the pertinent information related to the operation of the ELT, including the use of the remote control panel in the cockpit. If there are any limitations on its use, these should be declared in the 'Limitations' section.

Detailed instructions for pre-flight and post-flight checks should be provided. As a pre-flight check, the ELT remote control should be checked to ensure that it is in the armed position. Post-flight, the ELT should be checked to ensure that it does not transmit, by activating the indicator on the remote control or monitoring 121.5 MHz.

Information on the location and deactivation of ELTs should also be provided. Indeed, accident investigations have shown that following aircraft ground impact, the remote control switch on the instrument panel may become inoperative, and extensive fuselage disruption may render the localisation of, and the access to, the ELT unit difficult. As a consequence, in the absence of information available to the accident investigators and first responders, this has led to situations where the ELT transmitted for a long time before being shut down, thus blocking the SAR channel for an extended time period. It is therefore recommended that information explaining how to disarm or shut down the ELT after an accident, including when the remote control switch is inoperative, should be included.

[Amdt No: 29/5]

SUBPART G — OPERATING LIMITATIONS AND INFORMATION

GENERAL

CS 29.1501 General

ED Decision 2016/025/R

- (a) Each operating limitation specified in [CS 29.1503](#) to [29.1525](#) and other limitations and information necessary for safe operation must be established.
- (b) The operating limitations and other information necessary for safe operation must be made available to the crew members as prescribed in [CS 29.1541](#) to [29.1593](#).

[Amdt 29/4]

OPERATING LIMITATIONS

CS 29.1503 Airspeed limitations: general

ED Decision 2003/16/RM

- (a) An operating speed range must be established.
- (b) When airspeed limitations are a function of weight, weight distribution, altitude, rotor speed, power, or other factors, airspeed limitations corresponding with the critical combinations of these factors must be established.

CS 29.1505 Never-exceed speed

ED Decision 2003/16/RM

- (a) The never-exceed speed, V_{NE} , must be established so that it is:
 - (1) Not less than 74 km/h (40 knots) (CAS); and
 - (2) Not more than the lesser of:
 - (i) 0.9 times the maximum forward speeds established under [CS 29.309](#);
 - (ii) 0.9 times the maximum speed shown under [CS 29.251](#) and [29.629](#); or
 - (iii) 0.9 times the maximum speed substantiated for advancing blade tip mach number effects under critical altitude conditions.
- (b) V_{NE} may vary with altitude, rpm, temperature, and weight, if:
 - (1) No more than two of these variables (or no more than two instruments integrating more than one of these variables) are used at one time; and
 - (2) The ranges of these variables (or of the indications on instruments integrating more than one of these variables) are large enough to allow an operationally practical and safe variation of V_{NE} .
- (c) For helicopters, a stabilised power-off V_{NE} denoted as V_{NE} (power-off) may be established at a speed less than V_{NE} established pursuant to sub-paragraph (a), if the following conditions are met:
 - (1) V_{NE} (power-off) is not less than a speed midway between the power-on V_{NE} and the speed used in meeting the requirements of:
 - (i) [CS 29.67\(a\)\(3\)](#) for Category A helicopters;
 - (ii) [CS 29.65\(a\)](#) for Category B helicopters, except multi-engine helicopters meeting the requirements of [CS 29.67\(b\)](#); and
 - (iii) [CS 29.67\(b\)](#) for multi-engine Category B helicopters meeting the requirements of [CS 29.67\(b\)](#).
 - (2) V_{NE} (power-off) is:
 - (i) A constant airspeed;
 - (ii) A constant amount less than power-on V_{NE} ; or

- (iii) A constant airspeed for a portion of the altitude range for which certification is requested, and a constant amount less than power-on V_{NE} for the remainder of the altitude range.

CS 29.1509 Rotor speed

ED Decision 2003/16/RM

- (a) *Maximum power-off (autorotation).* The maximum power-off rotor speed must be established so that it does not exceed 95% of the lesser of:
 - (1) The maximum design rpm determined under [CS 29.309\(b\)](#); and
 - (2) The maximum rpm shown during the type tests,
- (b) *Minimum power-off.* The minimum power-off rotor speed must be established so that it is not less than 105% of the greater of:
 - (1) The minimum shown during the type tests; and
 - (2) The minimum determined by design substantiation.
- (c) *Minimum power-on.* The minimum power-on rotor speed must be established so that it is:
 - (1) Not less than the greater of:
 - (i) The minimum shown during the type tests; and
 - (ii) The minimum determined by design substantiation; and
 - (2) Not more than a value determined under [CS 29.33\(a\)\(1\)](#) and [\(c\)\(1\)](#).

CS 29.1517 Limiting height-speed envelope

ED Decision 2003/16/RM

For Category A rotorcraft, if a range of heights exists at any speed, including zero, within which it is not possible to make a safe landing following power failure, the range of heights and its variation with forward speed must be established, together with any other pertinent information, such as the kind of landing surface.

CS 29.1519 Weight and centre of gravity

ED Decision 2003/16/RM

The weight and centre of gravity limitations determined under [CS 29.25](#) and [29.27](#), respectively, must be established as operating limitations.

CS 29.1521 Powerplant limitations

ED Decision 2003/16/RM

- (a) *General.* The powerplant limitations prescribed in this paragraph must be established so that they do not exceed the corresponding limits for which the engines are type certificated.
- (b) *Take-off operation.* The powerplant take-off operation must be limited by:
 - (1) The maximum rotational speed, which may not be greater than:
 - (i) The maximum value determined by the rotor design; or
 - (ii) The maximum value shown during the type tests;

- (2) The maximum allowable manifold pressure (for reciprocating engines);
 - (3) The maximum allowable turbine inlet or turbine outlet gas temperature (for turbine engines);
 - (4) The maximum allowable power or torque for each engine, considering the power input limitations of the transmission with all engines operating;
 - (5) The maximum allowable power or torque for each engine considering the power input limitations of the transmission with one engine inoperative;
 - (6) The time limit for the use of the power corresponding to the limitations established in sub-paragraphs (b)(1) to (5); and
 - (7) If the time limit established in sub-paragraph (b)(6) exceeds 2 minutes:
 - (i) The maximum allowable cylinder head or coolant outlet temperature (for reciprocating engines); and
 - (ii) The maximum allowable engine and transmission oil temperatures.
- (c) *Continuous operation.* The continuous operation must be limited by:
- (1) The maximum rotational speed, which may not be greater than:
 - (i) The maximum value determined by the rotor design; or
 - (ii) The maximum value shown during the type tests;
 - (2) The minimum rotational speed shown under the rotor speed requirements in [CS 29.1509\(c\)](#);
 - (3) The maximum allowable manifold pressure (for reciprocating engines);
 - (4) The maximum allowable turbine inlet or turbine outlet gas temperature (for turbine engines);
 - (5) The maximum allowable power or torque for each engine, considering the power input limitations of the transmission with all engines operating;
 - (6) The maximum allowable power or torque for each engine, considering the power input limitations of the transmission with one engine inoperative; and
 - (7) The maximum allowable temperatures for –
 - (i) The cylinder head or coolant outlet (for reciprocating engines);
 - (ii) The engine oil; and
 - (iii) The transmission oil.
- (d) *Fuel grade or designation.* The minimum fuel grade (for reciprocating engines) or fuel designation (for turbine engines) must be established so that it is not less than that required for the operation of the engines within the limitations in sub-paragraphs (b) and (c).
- (e) *Ambient temperature.* Ambient temperature limitations (including limitations for winterization installations if applicable) must be established as the maximum ambient atmospheric temperature at which compliance with the cooling provisions of [CS 29.1041](#) to [29.1049](#) is shown.
- (f) *Two and one-half minute OEI power operation.* Unless otherwise authorised, the use of 2½-minute OEI power must be limited to engine failure operation of multi-engine, turbine powered

rotorcraft for not longer than 2½ minutes for any period in which that power is used. The use of 2½-minute OEI power must also be limited by:

- (1) The maximum rotational speed, which may not be greater than:
 - (i) The maximum value determined by the rotor design; or
 - (ii) The maximum value shown during the type tests;
 - (2) The maximum allowable gas temperature;
 - (3) The maximum allowable torque; and
 - (4) The maximum allowable oil temperature.
- (g) *Thirty-minute OEI power operation.* Unless otherwise authorised, the use of 30-minute OEI power must be limited to multi-engine, turbine-powered rotorcraft for not longer than 30 minutes after failure of an engine. The use of 30-minute OEI power must also be limited by:
- (1) The maximum rotational speed, which may not be greater than:
 - (i) The maximum value determined by the rotor design; or
 - (ii) The maximum value shown during the type tests;
 - (2) The maximum allowable gas temperature;
 - (3) The maximum allowable torque; and
 - (4) The maximum allowable oil temperature.
- (h) *Continuous OEI power operation.* Unless otherwise authorised, the use of continuous OEI power must be limited to multi-engine, turbine-powered rotorcraft for continued flight after failure of an engine. The use of continuous OEI power must also be limited by:
- (1) The maximum rotational speed, which may not be greater than:
 - (i) The maximum value determined by the rotor design; or
 - (ii) The maximum value shown during the type tests.
 - (2) The maximum allowable gas temperature;
 - (3) The maximum allowable torque; and
 - (4) The maximum allowable oil temperature.
- (i) *Rated 30-second OEI power operation.* Rated 30-second OEI power is permitted only on multi-engine, turbine-powered rotorcraft also certificated for the use of rated 2-minute OEI power, and can only be used for continued operation of the remaining engine(s) after a failure or precautionary shutdown of an engine. It must be shown that following application of 30-second OEI power, any damage will be readily detectable by the applicable inspections and other related procedures furnished in accordance with paragraph A29.4 of [Appendix A](#) of CS-29. The use of 30-second OEI power must be limited to not more than 30 seconds for any period in which the power is used and by:
- (1) The maximum rotational speed which may not be greater than:
 - (i) The maximum value determined by the rotor design: or
 - (ii) The maximum value demonstrated during the type tests;
 - (2) The maximum allowable gas temperature; and

- (3) The maximum allowable torque.
- (j) *Rated 2-minute OEI power operation.* Rated 2-minute OEI power is permitted only on multi-engine, turbine-powered rotorcraft, also certificated for the use of rated 30-second OEI power, and can only be used for continued operation of the remaining engine(s) after a failure or precautionary shutdown of an engine. It must be shown that following application of 2-minute OEI power, any damage will be readily detectable by the applicable inspections and other related procedures furnished in accordance with paragraph A29.4 of [Appendix A](#) of CS-29. The use of 2-minute OEI power must be limited to not more than 2 minutes for any period in which that power is used, and by:
- (1) The maximum rotational speed, which may not be greater than:
 - (i) The maximum value determined by the rotor designs; or
 - (ii) The maximum value demonstrated during the type tests;
 - (2) The maximum allowable gas temperature; and
 - (3) The maximum allowable torque.

CS 29.1522 Auxiliary power unit limitations

ED Decision 2003/16/RM

If an auxiliary power unit that meets the requirements of CS-APU is installed in the rotorcraft, the limitations established for that auxiliary power unit including the categories of operation must be specified as operating limitations for the rotorcraft.

CS 29.1523 Minimum flight crew

ED Decision 2003/16/RM

The minimum flight crew must be established so that it is sufficient for safe operation, considering:

- (a) The workload on individual crew members;
- (b) The accessibility and ease of operation of necessary controls by the appropriate crew member; and
- (c) The kinds of operation authorised under [CS 29.1525](#).

CS 29.1525 Kinds of operation

ED Decision 2003/16/RM

The kinds of operations (such as VFR, IFR, day, night, or icing) for which the rotorcraft is approved are established by demonstrated compliance with the applicable certification requirements and by the installed equipment.

CS 29.1527 Maximum operating altitude

ED Decision 2003/16/RM

The maximum altitude up to which operation is allowed, as limited by flight, structural, powerplant, functional, or equipment characteristics, must be established.

CS 29.1529 Instructions for Continued Airworthiness

ED Decision 2003/16/RM

Instructions for continued airworthiness in accordance with [Appendix A](#) to CS-29 must be prepared.

Appendix A – Instructions for Continued Airworthiness

ED Decision 2020/006/R

A29.1 General

- (a) This appendix specifies requirements for the preparation of instructions for continued airworthiness as required by [CS 29.1529](#).
- (b) The instructions for continued airworthiness for each rotorcraft must include the instructions for continued airworthiness for each engine and rotor (hereinafter designated 'products'), for each appliance required by any applicable CS or operating rule, and any required information relating to the interface of those appliances and products with the rotorcraft. If instructions for continued airworthiness are not supplied by the manufacturer of an appliance or product installed in the rotorcraft, the instructions for continued airworthiness for the rotorcraft must include the information essential to the continued airworthiness of the rotorcraft.

A29.2 Format

- (a) The instructions for continued airworthiness must be in the form of a manual or manuals as appropriate for the quantity of data to be provided.
- (b) The format of the manual or manuals must provide for a practical arrangement.

A29.3 Content

The contents of the manual or manuals must be prepared in a language acceptable to the Agency. The instructions for continued airworthiness must contain the following manuals or sections, as appropriate, and information:

- (a) *Rotorcraft maintenance manual or section.*
 - (1) Introduction information that includes an explanation of the rotorcraft's features and data to the extent necessary for maintenance or preventive maintenance.
 - (2) A description of the rotorcraft and its systems and installations including its engines, rotors, and appliances.
 - (3) Basic control and operation information describing how the rotorcraft components and systems are controlled and how they operate, including any special procedures and limitations that apply.
 - (4) Servicing information that covers details regarding servicing points, capacities of tanks, reservoirs, types of fluids to be used, pressures applicable to the various systems, location of access panels for inspection and servicing, locations of lubrication points, the lubricants to be used, equipment required for servicing, tow instructions and limitations, mooring, jacking, and levelling information.

(b) *Maintenance Instructions.*

- (1) Scheduling information for each part of the rotorcraft and its engines, auxiliary power units, rotors, accessories, instruments, and equipment that provides the recommended periods at which they should be cleaned, inspected, adjusted, tested, and lubricated, and the degree of inspection, the applicable wear tolerances, and work recommended at these periods. However, it is allowed to refer to an accessory, instrument, or equipment manufacturer as the source of this information if it is shown that the item has an exceptionally high degree of complexity requiring specialised maintenance techniques, test equipment, or expertise. The recommended overhaul periods and necessary cross references to the airworthiness limitations section of the manual must also be included. In addition, an inspection program that includes the frequency and extent of the inspections necessary to provide for the continued airworthiness of the rotorcraft must be included.
 - (2) Trouble-shooting information describing probable malfunctions, how to recognise those malfunctions, and the remedial action for those malfunctions.
 - (3) Information describing the order and method of removing and replacing products and parts with any necessary precautions to be taken.
 - (4) Other general procedural instructions including procedures for system testing during ground running, symmetry checks, weighing and determining the centre of gravity, lifting and shoring, and storage limitations.
- (c) Diagrams of structural access plates and information needed to gain access for inspections when access plates are not provided.
- (d) Details for the application of special inspection techniques including radiographic and ultrasonic testing where such processes are specified.
- (e) Information needed to apply protective treatments to the structure after inspection.
- (f) All data relative to structural fasteners such as identification, discard recommendations, and torque values.
- (g) A list of special tools needed.

A29.4 Airworthiness Limitations Section

The instructions for continued airworthiness must contain a section titled airworthiness limitations that is segregated and clearly distinguishable from the rest of the document. This section must set forth each mandatory replacement time, structural inspection interval, and related structural inspection required for type-certification. If the instructions for continued airworthiness consist of multiple documents, the section required by this paragraph must be included in the principal manual. This section must contain a legible statement in a prominent location that reads – ‘The airworthiness limitations section is approved and variations must also be approved’.

A29.5 Information system security Instructions for Continued Airworthiness

The applicant must prepare Instructions for Continued Airworthiness (ICA) that are applicable to aircraft information system security protection as required by [CS 29.1319](#) (see AMC 20-42 Section 9).

[Amdt No: 29/2]

[Amdt No: 29/3]

[Amdt No: 29/8]

MARKINGS AND PLACARDS

CS 29.1541 General

ED Decision 2003/16/RM

- (a) The rotorcraft must contain:
 - (1) The markings and placards specified in [CS 29.1545](#) to [29.1565](#); and
 - (2) Any additional information, instrument markings, and placards required for the safe operation of the rotorcraft if it has unusual design, operating or handling characteristics.
- (b) Each marking and placard prescribed in sub-paragraph (a):
 - (1) Must be displayed in a conspicuous place; and
 - (2) May not be easily erased, disfigured, or obscured.

CS 29.1543 Instrument markings: general

ED Decision 2003/16/RM

For each instrument:

- (a) When markings are on the cover glass of the instrument there must be means to maintain the correct alignment of the glass cover with the face of the dial; and
- (b) Each arc and line must be wide enough, and located to be clearly visible to the pilot.

CS 29.1545 Airspeed indicator

ED Decision 2003/16/RM

- (a) Each airspeed indicator must be marked as specified in sub-paragraph (b), with the marks located at the corresponding indicated airspeeds.
- (b) The following markings must be made:
 - (1) A red radial line:
 - (i) For rotorcraft other than helicopters, at V_{NE} ; and
 - (ii) For helicopters, at V_{NE} (power-on).
 - (2) A red, cross-hatched radial line at V_{NE} (power-off) for helicopters, if V_{NE} (power-off) is less than V_{NE} (power-on).
 - (3) For the caution range, a yellow arc.
 - (4) For the safe operating range, a green arc.

CS 29.1547 Magnetic direction indicator

ED Decision 2003/16/RM

- (a) A placard meeting the requirements of this paragraph must be installed on or near the magnetic direction indicator.
- (b) The placard must show the calibration of the instrument in level flight with the engines operating.
- (c) The placard must state whether the calibration was made with radio receivers on or off.
- (d) Each calibration reading must be in terms of magnetic heading in not more than 45° increments.

CS 29.1549 Powerplant instruments

ED Decision 2003/16/RM

For each required powerplant instrument, as appropriate to the type of instruments –

- (a) Each maximum and, if applicable, minimum safe operating limit must be marked with a red radial or a red line;
- (b) Each normal operating range must be marked with a green arc or green line, not extending beyond the maximum and minimum safe limits;
- (c) Each take-off and precautionary range must be marked with a yellow arc or yellow line;
- (d) Each engine or propeller range that is restricted because of excessive vibration stresses must be marked with red arcs or red lines; and
- (e) Each OEI limit or approved operating range must be marked to be clearly differentiated from the markings of sub-paragraphs (a) to (d) except that no marking is normally required for the 30-second OEI limit.

CS 29.1551 Oil quantity indicator

ED Decision 2003/16/RM

Each oil quantity indicator must be marked with enough increments to indicate readily and accurately the quantity of oil.

CS 29.1553 Fuel quantity indicator

ED Decision 2003/16/RM

If the unusable fuel supply for any tank exceeds 3.8 litres (0.8 Imperial gallon/1 US gallon), or 5% of the tank capacity, whichever is greater, a red arc must be marked on its indicator extending from the calibrated zero reading to the lowest reading obtainable in level flight.

CS 29.1555 Control markings

ED Decision 2018/007/R

- (a) Each cockpit control, other than primary flight controls or control whose function is obvious, must be plainly marked as to its function and method of operation.
- (b) For powerplant fuel controls:
 - (1) Each fuel tank selector valve control must be marked to indicate the position corresponding to each tank and to each existing cross feed position;

- (2) If safe operation requires the use of any tanks in a specific sequence, that sequence must be marked on, or adjacent to, the selector for those tanks; and
 - (3) Each valve control for any engine of a multi-engine rotorcraft must be marked to indicate the position corresponding to each engine controlled.
- (c) Usable fuel capacity must be marked as follows:
- (1) For fuel systems having no selector controls, the usable fuel capacity of the system must be indicated at the fuel quantity indicator.
 - (2) For fuel systems having selector controls, the usable fuel capacity available at each selector control position must be indicated near the selector control.
- (d) For accessory, auxiliary, and emergency controls:
- (1) Each essential visual position indicator, such as those showing rotor pitch or landing gear position, must be marked so that each crew member can determine at any time the position of the unit to which it relates; and
 - (2) Each emergency control must be marked as to method of operation and be red unless it may need to be operated underwater, in which case it must be marked with yellow and black stripes.
- (e) For rotorcraft incorporating retractable landing gear, the maximum landing gear operating speed must be displayed in clear view of the pilot.

[Amdt No: 29/5]

AMC 29.1555 Control markings

ED Decision 2018/007/R

This AMC supplements FAA AC 29.1555.

- (a) Explanation
- CS-29 Amendment 5 introduced the need to mark emergency controls for use following a ditching or water impact with black and yellow stripes, instead of red, to make them more conspicuous when viewed underwater.
- (b) Procedures
- (1) Any emergency control that may be required to be operated underwater (e.g. an emergency flotation system deployment switch, a life raft deployment switch or handle) should be coloured with black and yellow stripes.
 - (2) Black and yellow markings should consist of at least two bands of each colour of approximately equal widths.

[Amdt No: 29/5]

CS 29.1557 Miscellaneous markings and placards

ED Decision 2003/16/RM

- (a) *Baggage and cargo compartments, and ballast location.* Each baggage and cargo compartment, and each ballast location must have a placard stating any limitations on contents, including weight, that are necessary under the loading requirements.
- (b) *Seats.* If the maximum allowable weight to be carried in a seat is less than 77 kg (170 pounds), a placard stating the lesser weight must be permanently attached to the seat structure.
- (c) *Fuel and oil filler openings.* The following apply:
 - (1) Fuel filler openings must be marked at or near the filler cover with:
 - (i) The word 'fuel';
 - (ii) For reciprocating engine powered rotorcraft, the minimum fuel grade;
 - (iii) For turbine-engine-powered rotorcraft, the permissible fuel designations, except that if impractical, this information may be included in the rotorcraft flight manual, and the fuel filler may be marked with an appropriate reference to the flight manual; and
 - (iv) For pressure fueling systems, the maximum permissible fueling supply pressure and the maximum permissible defueling pressure.
 - (2) Oil filler openings must be marked at or near the filler cover with the word 'oil'.
- (d) *Emergency exit placards.* Each placard and operating control for each emergency exit must differ in colour from the surrounding fuselage surface as prescribed in [CS 29.811\(f\)\(2\)](#). A placard must be near each emergency exit control and must clearly indicate the location of that exit and its method of operation.

CS 29.1559 Limitations placard

ED Decision 2003/16/RM

There must be a placard in clear view of the pilot that specifies the kinds of operations (VFR, IFR, day, night or icing) for which the rotorcraft is approved.

CS 29.1561 Safety equipment

ED Decision 2018/007/R

- (a) Each safety equipment control to be operated by the crew or passenger in an emergency must be plainly marked with its identification and its method of operation.
- (b) Each location, such as a locker or compartment, that carries any fire extinguishing, signalling, or other safety equipment, must be appropriately marked in order to identify the contents and if necessary indicate how to remove the equipment
- (c) Each item of safety equipment carried must be marked with its identification and must have obviously marked operating instructions.

[Amdt No: 29/5]

AMC 29.1561 Safety Equipment

ED Decision 2018/007/R

This AMC supplements FAA AC 29.1561.

(a) Explanation

[CS 29.1561](#) requires each safety equipment control that can be operated by a crew member or passenger to be plainly marked to identify its function and method of operation. (Note that the marking of safety equipment controls located within the cockpit and intended for use by the flight crew is addressed in [CS 29.1555](#).)

In addition, a location marking for each item of stowed safety equipment should be provided that identifies the contents and how to remove them. All safety equipment, including ditching and survival equipment, should be clearly identifiable and provided with operating instructions. Markings and placards should be conspicuous and durable as per [CS 29.1541](#). Both passengers and crew should be able to easily identify and then use the safety equipment.

(b) Procedures

- (1) Release devices such as levers or latch handles for life rafts and other safety equipment should be plainly marked to identify their function and method of operation. Stencils, permanent decals, placards, or other permanent labels or instructions may be used.
- (2) Lockers, compartments, or pouches used to contain safety equipment such as life preservers, etc., should be marked to identify the equipment therein and to also identify, if not obvious, the method or means of accessing or releasing the equipment.
- (3) Safety equipment should be labelled and provided with operating instructions for its use or operation.
- (4) Locating signs for safety equipment should be legible in daylight from the furthest seated point in the cabin or recognisable from a distance equal to the width of the cabin. Letters, 2.5 cm (1 in) high, should be acceptable to satisfy the recommendation. Operating instructions should be legible from a distance of 76 cm (30 in). These recommendations are based on the exit requirements of [CS 29.811\(b\)](#) and (e)(1).
- (5) As prescribed, each life raft and its installed equipment should be provided with clear operating instruction markings that cannot be easily erased or disfigured and are readable at low levels of illumination.
- (6) Easily recognised or identified and easily accessible safety equipment located in sight of the occupants, such as a passenger compartment fire extinguisher that all passengers can see, may not require locating signs, stencils, or decals. However, operating instructions are required.

[Amdt No: 29/5]

CS 29.1565 Tail rotor

ED Decision 2003/16/RM

Each tail rotor must be marked so that its disc is conspicuous under normal daylight ground conditions.

ROTORCRAFT FLIGHT MANUAL

CS 29.1581 General

ED Decision 2003/16/RM

- (a) *Furnishing information.* A Rotorcraft Flight Manual must be furnished with each rotorcraft, and it must contain the following:
 - (1) Information required by [CS 29.1583](#) to [29.1589](#).
 - (2) Other information that is necessary for safe operation because of design, operating, or handling characteristics.
- (b) *Approved information.* Each part of the manual listed in [CS 29.1583](#) to [29.1589](#) that is appropriate to the rotorcraft, must be furnished, verified, and approved, and must be segregated, identified, and clearly distinguished from each unapproved part of that manual.
- (c) Reserved.
- (d) *Table of contents.* Each Rotorcraft Flight Manual must include a table of contents if the complexity of the manual indicates a need for it.

CS 29.1583 Operating limitations

ED Decision 2003/16/RM

- (a) *Airspeed and rotor limitations.* Information necessary for the marking of airspeed and rotor limitations on or near their respective indicators must be furnished. The significance of each limitation and of the colour coding must be explained.
- (b) *Powerplant limitations.* The following information must be furnished:
 - (1) Limitations required by [CS 29.1521](#).
 - (2) Explanation of the limitations, when appropriate.
 - (3) Information necessary for marking the instruments required by [CS 29.1549](#) to [29.1553](#).
- (c) *Weight and loading distribution.* The weight and centre of gravity limits required by [CS 29.25](#) and [CS 29.27](#), respectively, must be furnished. If the variety of possible loading conditions warrants, instructions must be included to allow ready observance of the limitations.
- (d) *Flight crew.* When a flight crew of more than one is required, the number and functions of the minimum flight crew determined under [CS 29.1523](#) must be furnished.
- (e) *Kinds of operation.* Each kind of operation for which the rotorcraft and its equipment installations are approved must be listed.
- (f) *Limiting heights.* Enough information must be furnished to allow compliance with [CS 29.1517](#).
- (g) *Maximum allowable wind.* For Category A rotorcraft, the maximum allowable wind for safe operation near the ground must be furnished.
- (h) *Altitude.* The altitude established under [CS 29.1527](#) and an explanation of the limiting factors must be furnished.
- (i) *Ambient temperature.* Maximum and minimum ambient temperature limitations must be furnished.

AMC 29.1583 Operating limitations

ED Decision 2016/025/R

This AMC provides further guidance and acceptable means of compliance to supplement FAA AC 29-2C Change 4 (AC 29.1583 § 29.1583 (Amendment 29-24) OPERATING LIMITATIONS), to meet the Agency's interpretation of [CS 29.1583](#). As such it should be used in conjunction with the FAA AC but take precedence over it, where stipulated, in the showing of compliance.

Specifically, this AMC addresses an area where the FAA AC has been deemed by the Agency as being at variance to the Agency's interpretation. This being as follows:

b. Procedures.

- (7) Kinds of operations are established under [CS 29.1525](#). This section should contain the following preamble: 'This rotorcraft is certified in the Large Category (category B or category A and category B) and is eligible for the following kinds of operations when the appropriate instruments and equipment required by the airworthiness and operating rules are installed and approved and are in an operable condition.' The following, and any other kinds of operations that are applicable, should be listed.

- (i) Day and night VFR.
- (ii) Approved to operate in known icing conditions.
- (iii) IFR.
- (iv) Category A vertical operations from ground level or elevated heliports.
- (v) Extended overwater operations (ditching).
- (vi) External load operation.

Each operating limitation must be clear, unambiguous, and consistent with any other applicable limitation or regulatory requirement.

[Amdt 29/4]

CS 29.1585 Operating procedures

ED Decision 2018/007/R

- (a) The parts of the manual containing operating procedures must have information concerning any normal and emergency procedures, and other information necessary for safe operation, including the applicable procedures, such as those involving minimum speeds, to be followed if an engine fails.
- (b) For multi-engine rotorcraft, information identifying each operating condition in which the fuel system independence prescribed in [CS 29.953](#) is necessary for safety must be furnished, together with instructions for placing the fuel system in a configuration used to show compliance with that paragraph.
- (c) For helicopters for which a V_{NE} (power-off) is established under [CS 29.1505\(c\)](#), information must be furnished to explain the V_{NE} (power-off) and the procedures for reducing airspeed to not more than the V_{NE} (power-off) following failure of all engines.
- (d) For each rotorcraft showing compliance with [CS 29.1353\(c\)\(6\)\(ii\) or \(c\)\(6\)\(iii\)](#), the operating procedures for disconnecting the battery from its charging source must be furnished.

- (e) If the unusable fuel supply in any tank exceeds 5% of the tank capacity, or 3.8 litres (0.8 Imperial gallon/1 US gallon), whichever is greater, information must be furnished which indicates that when the fuel quantity indicator reads 'zero' in level flight, any fuel remaining in the fuel tank cannot be used safely in flight.
- (f) Information on the total quantity of usable fuel for each fuel tank must be furnished.
- (g) For Category B rotorcraft, the airspeeds and corresponding rotor speeds for minimum rate of descent and best glide angle as prescribed in [CS 29.71](#) must be provided.
- (h) The maximum duration of operation after a failure resulting in a loss of lubrication of a rotor drive system gearbox and an associated oil pressure warning must be furnished and must not exceed the maximum period substantiated in accordance with [CS 29.927\(c\)](#).

[Amdt No: 29/5]

AMC 29.1585 Operating Procedures

ED Decision 2018/007/R

[CS 29.927\(c\)](#) provides guidance for the completion of testing to simulate a loss of lubrication and on how to demonstrate confidence in the margin of safety associated with the maximum period of operation following loss of lubrication. This margin of safety is intended to substantiate a period of operation that has been evaluated as likely to be safer than making a forced landing over hostile terrain. Accordingly, the need to 'Land as Soon as Possible', which may include ditching where circumstances permit, should be reflected in the associated RFM emergency procedures. This can be supplemented with 'Land Immediately' in the event of additional conditions to that of low oil pressure being present.

Emergency procedures should identify the need to minimise the power that is used for yaw and accessories following a loss of oil pressure warning.

[Amdt No: 29/5]

CS 29.1587 Performance information

ED Decision 2018/007/R

Flight manual performance information which exceeds any operating limitation may be shown only to the extent necessary for presentation clarity or to determine the effects of approved optional equipment or procedures. When data beyond operating limits are shown, the limits must be clearly indicated. The following must be provided:

- (a) *Category A.* For each Category A rotorcraft, the rotorcraft flight manual must contain a summary of the performance data, including data necessary for the application of any applicable operating rule, together with descriptions of the conditions, such as airspeeds, under which this data was determined, and must contain –
 - (1) The indicated airspeeds corresponding with those determined for take-off and the procedures to be followed if the critical engine fails during take-off;
 - (2) The airspeed calibrations;
 - (3) The techniques, associated airspeeds, and rates of descent for autorotative landings;
 - (4) The rejected take-off distance determined under [CS 29.62](#) and the take-off distance determined under [CS 29.61](#);
 - (5) The landing data determined under [CS 29.81](#) and [29.85](#);

-
- (6) The steady gradient of climb for each weight, altitude, and temperature for which take-off data are to be scheduled, along the take-off path determined in the flight conditions required in [CS 29.67\(a\)\(1\) and \(a\)\(2\)](#):
- (i) In the flight conditions required in [CS 29.67\(a\)\(1\)](#) between the end of the take-off distance and the point at which the rotorcraft is 61 m (200 ft) above the take-off surface (or 61 m (200 ft) above the lowest point of the take-off profile for elevated heliports).
 - (ii) In the flight conditions required in [CS 29.67\(a\)\(2\)](#) between the points at which the rotorcraft is 61 m (200 ft) and 305 m (1000 ft) above the take-off surface (or 61 m (200 ft) and 305 m (1000 ft) above the lowest point of the take-off profile for elevated heliports).
- (7) Hover performance determined under [CS 29.49](#) and the maximum weight for each altitude and temperature condition at which the rotorcraft can safely hover in-ground effect and out-of-ground effect in winds of not less than 31 km/h (17 knots) from all azimuths. This data must be clearly referenced to the appropriate hover charts.
- (b) *Category B.* For each Category B rotorcraft, the Rotorcraft Flight Manual must contain:
- (1) The take-off distance and the climbout speed together with the pertinent information defining the flight path with respect to autorotative landing if an engine fails, including the calculated effects of altitude and temperature;
 - (2) The steady rates of climb and hovering ceiling, together with the corresponding airspeeds and other pertinent information, including the calculated effects of altitude and temperature;
 - (3) The landing distance, appropriate airspeed and type of landing surface, together with any pertinent information that might affect this distance, including the effects of weight, altitude and temperature;
 - (4) The maximum safe wind for operation near the ground;
 - (5) The airspeed calibrations;
 - (6) The height-speed envelope except for rotorcraft incorporating this as an operating limitation;
 - (7) Glide distance as a function of altitude when autorotating at the speeds and conditions for minimum rate of descent and best glide angle, as determined in [CS 29.71](#);
 - (8) Hover performance determined under [CS 29.49](#) and the maximum safe wind demonstrated under the ambient conditions for data presented. In addition, the maximum weight for each altitude and temperature condition at which the rotorcraft can safely hover in-ground effect and out-of-ground effect in winds of not less than 31 km/h (17 knots) from all azimuths. This data must be clearly referenced to the appropriate hover charts; and

- (9) Any additional performance data necessary for the application of any applicable operating rule.
- (c) The RFM must contain the substantiated sea conditions and any associated information relating to the certification obtained with ditching or emergency flotation provisions.

[Amdt No: 29/1]

[Amdt No: 29/2]

[Amdt No: 29/5]

AMC 29.1587(c) Performance Information

ED Decision 2018/007/R

This AMC supplements FAA AC 29.1587, AC 29.1587A and AC 29.1587B.

a. Explanation

The rotorcraft flight manual (RFM) is an important element in the certification process of the rotorcraft for approval with ditching or emergency flotation provisions. The material may be presented in the form of a supplement or a revision to the basic manual. This material should include:

- (1) A statement in the 'Limitations' section stating that the rotorcraft is approved for ditching or emergency flotation, as appropriate.

If certification with ditching provisions is obtained in a segmented fashion (i.e. one applicant performing the safety equipment installation and operations portion and another designing and substantiating the safety equipment's performance and deployment facilities), the RFM limitations should state that the ditching provisions are not approved until all the segments are completed. The outstanding ditching provisions for a complete certification should be identified in the 'Limitations' section.

- (2) Procedures and limitations for the inflation of a flotation device.
- (3) A statement in the performance information section of the RFM, identifying the substantiated sea conditions and any other pertinent information. If substantiation was performed using the default North Sea wave climate (JONSWAP), the maximum substantiated significant wave height (H_s) should be stated. If extended testing was performed in accordance with the [AMC to 29.801\(e\) and 29.802\(c\)](#) to demonstrate that the target level of capsize probability can be reached without any operational limitations, this should also be stated. If substantiation was performed for other sea conditions, the maximum substantiated significant wave height (H_s) and the limits of the geographical area represented should be stated.
- (4) Recommended rotorcraft water entry attitude and speed.
- (5) Procedures for the use of safety equipment.
- (6) Egress and life raft entry procedures.

[Amdt No: 29/5]

CS 29.1589 Loading information

ED Decision 2003/16/RM

There must be loading instructions for each possible loading condition between the maximum and minimum weights determined under [CS 29.25](#) that can result in a centre of gravity beyond any extreme prescribed in [CS 29.27](#), assuming any probable occupant weights.

CS 29.1593 Exposure to volcanic cloud hazards

ED Decision 2016/025/R

If required by an operating rule, the susceptibility of rotorcraft features to the effects of volcanic cloud hazards must be established.

[Amdt 29/4]

AMC 29.1593 Exposure to volcanic cloud hazards

ED Decision 2016/025/R

The aim of [CS 29.1593](#) is to support commercial and non-commercial operators operating complex motor-powered rotorcraft by identifying and assessing airworthiness hazards associated with operations in contaminated airspace. Providing such data to operators will enable those hazards to be properly managed as part of an established management system.

Acceptable means of establishing the susceptibility of rotorcraft features to the effects of volcanic clouds should include a combination of experience, studies, analysis, and/or testing of parts or sub-assemblies.

Information necessary for safe operation should be contained in the unapproved part of the flight manual or other appropriate manual, and should be readily usable by operators in preparing a safety risk assessment as part of their overall management system.

A volcanic cloud comprises volcanic ash together with gases and other chemicals. Although the primary hazard is volcanic ash itself, other elements of the volcanic cloud may also be undesirable to operate through, thus their effect on airworthiness should be assessed.

In determining the susceptibility of rotorcraft features to the effects of volcanic clouds as well as the necessary information to be provided to operators, the following points should be considered:

- (a) Identify the features of the rotorcraft that are susceptible to airworthiness effects of volcanic clouds. These may include but are not limited to the following:
 - (1) malfunction or failure of one or more engines, leading not only to reduction or complete loss of thrust but also to failures of electrical, pneumatic and hydraulic systems;
 - (2) blockage of pitot and static sensors, resulting in unreliable airspeed indications and erroneous warnings;
 - (3) windscreen abrasion, resulting in windscreens rendered partially or completely opaque;
 - (4) fuel contamination;
 - (5) volcanic ash and/or toxic chemical contamination of cabin air-conditioning packs, possibly leading to loss of cabin pressurisation or noxious fumes in the cockpit and/or cabin;
 - (6) erosion, blockage or malfunction of external and internal rotorcraft components;
 - (7) volcanic cloud static discharge, leading to prolonged loss of communications; and

- (8) reduced cooling efficiency of electronic components, leading to a wide range of rotorcraft system failures.
- (b) The nature and severity of effects.
- (c) Details of any device or system installed on the rotorcraft that can detect the presence of volcanic cloud hazards (e.g. volcanic ash (particulate) sensors or volcanic gas sensors)
- (d) The effect of volcanic ash on operations arriving to or departing from contaminated aerodromes.
- (e) The related pre-flight, in-flight and post-flight precautions to be taken by the operator including any necessary amendments to Aircraft Operating Manuals, Aircraft Maintenance Manuals, Master Minimum Equipment List/Dispatch Deviation or equivalents, required to support the operator. Pre-flight precautions should include clearly defined procedures for the removal of any volcanic ash detected on parked rotorcraft.
- (f) The recommended continuing-airworthiness inspections associated with operations in airspace contaminated by volcanic cloud(s) and arriving to or departing from aerodromes contaminated by volcanic ash; this may take the form of Instructions for Continued Airworthiness (ICA) or other advice.

[Amdt 29/4]

MISCELLANEOUS GUIDANCE

MG 1 Certification procedure for rotorcraft avionics equipment

ED Decision 2018/015/R15/R

This AMC provides further guidance and acceptable means of compliance to supplement FAA AC 29-2C Change 7 MG 1, which is the EASA acceptable means of compliance, as provided for in [AMC 29 General](#). Specifically, this AMC addresses aspects where the FAA AC has been deemed by EASA to be at variance with EASA's interpretation or its regulatory system. These aspects are as follows and the remaining paragraphs of FAA AC 29-2C Change 7 MG 1 that are not amended below are considered to be EASA acceptable means of compliance.

a. Pre-test Requirements

[...]

(4)

- (i) Environment. An appropriate means for environmental testing is set forth in Radio Technical Commission for Aeronautics (RTCA) Document DO-160. Applicants should submit test reports showing that the laboratory-tested categories, such as temperature, vibration, altitude, etc., are compatible with the environmental demands placed on the rotorcraft. This can be achieved by determining the specific local environmental conditions in which the equipment will be installed and establishing the compatibility with the required DO-160 environmental condition.

[...]

b. Test Procedures.

[...]

(4)

[...]

- (v) Localiser performance should be checked for rotor modulation in approach while varying the rotor RPM throughout its normal range.
- (A) Localiser intercept. In the approach configuration and a distance of at least 10 NM from the localiser facility, fly toward the localiser front course, inbound, at an angle of at least 50 degrees. Perform this manoeuvre from both left and right of the localiser beam. No flags should appear during the period of time in which the deviation indicator moves from full deflection to on course. If the total antenna pattern has not been shown to be adequate by ground checks or by VOR flight evaluation, additional intercepts should be made. The low limits of interception should be determined.

- (B) Localiser tracking. While flying the localiser inbound and not more than 5 miles before reaching the outer marker, change the heading of the rotorcraft to obtain full needle deflection. Then fly the rotorcraft to establish localiser on course operation. The localiser deviation indicators should direct the rotorcraft to the localiser on course. Perform this manoeuvre with both a left and a right needle deflection. Continue tracking the localiser until over the transmitter. Conduct at least three acceptable front, and if applicable, back course flights to 200 feet or less above the threshold.
- (5)
- [...]
- (ii) Glideslope Intercept. The glideslope should be intercepted at both short and long distances in order to ensure correct functioning. Observe the glideslope deviation indicator for proper crossover as the aircraft flies through the glide path. No flags should appear between the times when the needle leaves the full-scale fly-up position and when it reaches the full-scale fly-down position.
- [...]
- (v) Glideslope performance should be sampled for rotor modulation during the approach, while varying the rotor RPM throughout its normal range.
- (6)
- [...]
- (iii) Technical. Approach the markers at a reasonable ground speed and at an altitude of 1 000 feet above ground level. While passing over the outer and middle markers with the localiser deviation indicator centred, the annunciators should illuminate for an appropriate duration. Check that the intensity of the indicator lights is acceptable in bright sunlight and at night. For slower rotorcraft, the duration should be proportionately longer.
- [...]
- (12) Inertial Navigation. AC 20-138 (current version) contains the basic criteria for the engineering evaluation of an inertial navigation system (INS). Further tailoring and refinement of the guidance contained within AC 20-138 may be required by the applicant in order to make it fully applicable to the rotorcraft domain.
- [...]
- (18)
- [...]
- (iv) Flight Test.
- [...]
- (B) The suitable glide path angles at low speed (< 70 kt KIAS) should be evaluated for IFR certificated aircraft.
- (1) Evaluate:
- [...]
- (ix) If the glide path angle for IFR aircraft has not been evaluated, then a limitation should be included in the rotorcraft flight manual or rotorcraft flight manual

supplement. This limitation should limit IFR coupled RNAV approach operations to an appropriate and justifiably conservative glide path angle and the minimum approach airspeed that meet flight manual limitations. This is necessary until evaluations are accomplished and the determination is made that the autopilot-GPS integration supports steep-angle, low speed operations.

[Amdt No: 29/6]

MG4 Full Authority Digital Electronic Controls (FADEC)

ED Decision 2008/010/R

Note: Certification procedures identified in MG4 refer specifically to the FAA regulatory system. For guidance on EASA procedures, reference should be made to Commission Regulation (EC) No 1702/2003 (as amended) (Part-21), AMC-20 (and specifically AMC 20-1 and 20-3) and to EASA internal working procedures, all of which are available on EASA's web site: <http://www.easa.europa.eu/>

[Amdt. No. 29/2]

MG5 Agricultural dispensing equipment installation

ED Decision 2016/025/R

Certification procedures identified in MG5 refer specifically to the FAA regulatory system and are not fully applicable to the EASA regulatory system due to the different applicability of restricted certification. The EASA regulatory system does not encompass a restricted certification category for design changes or Supplemental Type Certificates.

The certification basis of design changes or Supplemental Type Certificates for agricultural dispensing is to be established in accordance with 21.A.101 of Annex I to Regulation (EU) No 748/2012, on a case-by-case basis through compliance with the applicable airworthiness requirements contained in MG5, supplemented by any special conditions in accordance with 21.A.16B of Regulation (EU) No 748/2012 that are appropriate to the application and specific operating limitations and conditions. If appropriate to the proposed design, compliance with the above could be achieved through the provisions contained in 21.A.103(a)2(ii) or 21.A.115(b)2 of Regulation (EU) No 748/2012.

[Amdt 29/4]

MG 6 Emergency Medical Service (EMS) systems installations, including interior arrangements, equipment, Helicopter Terrain Awareness and Warning System (HTAWS), radio altimeter, and Flight Data Monitoring System (FDMS)

ED Decision 2018/015/R

This AMC provides further guidance and acceptable means of compliance to supplement the FAA AC 29-2C Change 7 MG 6, which is the EASA acceptable means of compliance, as provided for in [AMC 29 General](#). However, some aspects of the FAA AC are deemed by EASA to be at variance with EASA's interpretation or its regulatory system. EASA's interpretation of these aspects is described below. Paragraphs of FAA AC 29-2C Change 7 MG 6 that are not amended below are considered to be EASA acceptable means of compliance:

- a. Explanation. This AMC pertains to EMS configurations and associated rotorcraft airworthiness standards. EMS configurations are usually unique interior arrangements that are subject to the appropriate airworthiness standards (CS-29 or other applicable standards) to which the rotorcraft was certified. No relief from the standards is intended except through the procedures contained in Regulation (EU) No 748/2012 (namely Part-21 point 21.A.21(c)). EMS configurations are seldom, if ever, done by the original manufacturer.
- (1) Regulation (EU) No 965/2012 specifies the minimum equipment required to operate as a helicopter air ambulance service provider. This equipment, as well as all other equipment presented for evaluation and approval, is subject to compliance with airworthiness standards. Any equipment not essential to the safe operation of the rotorcraft may be approved provided the use, operation, and possible failure modes of the equipment are not hazardous to the rotorcraft. Safe flight, safe landing, and prompt evacuation of the rotorcraft, in the event of a minor crash landing, for any reason, are the objectives of the EASA's evaluation of interiors and equipment unique to EMS.
 - i. For example, a rotorcraft equipped only for transportation of a non-ambulatory person (e.g. a police rotorcraft with one litter) as well as a rotorcraft equipped with multiple litters and complete life support systems and two or more attendants or medical personnel may be submitted for approval. These configurations will be evaluated to the airworthiness standards appropriate to the rotorcraft certification basis.
 - ii. Large category rotorcraft should comply with flight crew and passenger safety standards, which will result in the need to re-evaluate certain features of the baseline existing type certified rotorcraft related to the EMS arrangement, such as doors and emergency exits, and occupant protection. Compliance with airworthiness standards results in the following features that should be retained as part of the rotorcraft's baseline type design: an emergency interior lighting system, placards or markings for doors and exits, exit size, exit quantity and location, exit access, safety belts and possibly shoulder harnesses or other restraint or passenger protection means. The features, placards, markings, and 'emergency' systems required as part of the rotorcraft's baseline type design should be retained unless specific replacements or alternate designs are necessary for the EMS configuration to comply with airworthiness standards.
 - (2) Many EMS configurations of large rotorcraft are typically equipped with the following:
 - i. attendant and medical personnel seats, which may swivel;
 - ii. multiple litters, some of which may tilt;
 - iii. medical equipment stowage compartments;
 - iv. life support and other complex medical equipment;
 - v. human infant incubator ('isolette');
 - vi. curtains or other interior light shielding for the flight crew compartment;
 - vii. external loudspeakers and search lights;
 - viii. special internal and external communication radio equipment;
 - ix. FDMS;
 - x. radio altimeter;

- xi. HTAWS.
 - (3) All helicopter air ambulance service providers are required to operate at all times in accordance with Regulation (EU) No 965/2012, which also defines the equipment required for an operational approval to be obtained.
- b. Procedures
- (2) Evacuation and interior arrangements
 - iii. When an evacuation demonstration is determined to be appropriate for compliance, 90 seconds should be used as the time interval for evacuation of the rotorcraft. Attendants and flight crew, trained in the evacuation procedures, may be used to remove the litter patient(s). It is preferable for the patient(s) to remain in the litter; however, the patient(s) may be removed from the litter to facilitate rapid evacuation through the exit. The patient(s) is (are) not ambulatory during the demonstration. Evacuation procedures should be included if isolettes are part of the interior. The demonstration may be conducted in daylight with the dark of the night simulated and the rotorcraft in a normal attitude with the landing gear extended. For the purpose of the demonstration, exits on one side (critical side) should be used. Exits on the opposite side are blocked and not accessible for the demonstration.
 - (3) Restraint of occupants and equipment

The emergency landing conditions specified in [29.561\(b\)](#) dictate the design load conditions. See FAA AC 29-2, sections 29.561 and 29.785, for further information.

 - i. Whether seated or recumbent, the occupants must be protected from serious injury as prescribed in [CS 29.785](#). Swivel seats and tilt litters may be used provided they are substantiated for the appropriate loads for the position selected for approval. Placards or markings may be used to ensure proper orientation for flight, take-off, or landing and emergency landing conditions. The seats and litters should be listed in the type design data for the configuration. See paragraph b.(17) for substitutions.
 - (6) Interior or 'medical' lights

The view of the flight crew must be free from glare and reflections that could cause interference. Curtains that meet flammability standards may be used. Complete partition or separation of the flight crew and passenger compartment is not prudent. Means for visual and verbal communication are usually necessary. Refer to FAA AC 29-2, section 29.773, which addresses pilot visibility aspects.

[Amdt No: 29/4]

[Amdt No: 29/6]

MG 16 Certification guidance for rotorcraft Night Vision Imaging System (NVIS) aircraft lighting systems

ED Decision 2018/015/R

This AMC provides further guidance and acceptable means of compliance to supplement FAA AC 29-2C Change 7 MG 16, which is the EASA acceptable means of compliance, as provided for in [AMC 29 General](#). However, some aspects of the FAA AC are deemed by EASA to be at variance with EASA's interpretation or its regulatory system. EASA's interpretation of these aspects is described below. Paragraphs of FAA AC 29-2C Change 7 MG 16 that are not amended below are considered to be EASA acceptable means of compliance.

[...]

d. References (use the current versions of the following references).

(1) Regulatory (CS-29 paragraphs).

21.93	29.1321	29.1401
29.1	29.1322	29.1413
29.21	29.1331(a)(3)	29.1501
29.141(c)	29.1333	29.1523
29.561	29.1351	29.1525
29.771	29.1355	29.1529
29.773	29.1357	29.1541
29.777	29.1359	29.1543
29.779	29.1381	29.1545
29.785	29.1383	29.1549
29.803	29.1385	29.1553
29.811	29.1387	29.1555
29.812	29.1389	29.1557
29.853	29.1391	29.1559
29.1301	29.1393	29.1561
29.1303	29.1395	29.1581
29.1305	29.1397	29.1583
29.1307	29.1399	29.1585
29.1309		

(2) Other references.

Document	Title
FAA AC 25-11B	Electronic Flight Displays
FAA AC 20-74	Aircraft Position and Anticollision Light Measurements
FAA AC 20-88A	Guidelines on the Marking of Aircraft Powerplant Instruments (Displays)
FAA AC 20-152	RTCA, Inc., Document RTCA/DO-254, Design Assurance Guidance for Airborne Electronic Hardware
RTCA DO-268	Concept of Operations, Night Vision Imaging System for Civil Operators
RTCA DO-275	Minimum Operational Performance Standards for Integrated Night Vision Imaging System Equipment
SAE ARP 4754A	Certification considerations for highly-integrated or complex aircraft systems

Document	Title
SAE ARP 4761	Guidelines and Methods for Conducting the Safety Assessment Process on Civil Airborne Systems and Equipment
SAE ARP 5825A	Design Requirements and Test Procedures for Dual Mode Exterior Lights
ETSO-C4c	Bank and Pitch Instruments
ETSO-C8e	Vertical Velocity Instrument (Rate-of-Climb)
ETSO-C87a	Airborne Low-Range Radio Altimeter
ETSO-C164	Night Vision Goggles (NVG)

[...]

e. Background.

[...]

- (7) Night vision goggles (NVGs) enhance a pilot's night vision by amplifying certain energy frequencies. The NVGs for civil use are based on performance criteria in ETSO-C164 and RTCA Document DO-275. These NVGs are known as 'Class B NVG' because they have filters applied to the objective lenses that block energy below the wavelength of 665 nanometres (nm). The Class B objective lens filter allows more use of colour in the cockpit, with truer reds and ambers. The ETSO specifies Class B NVGs for civil use. Because NVGs will amplify energy that is not within the range of the filter, it is important that the NVIS lighting system keeps those incompatible frequencies out of the cockpit. However, there are NVGs in civil use that do not conform to the ETSO-C164 standard because they have Class A filters on their objective lenses. Class A filters block energy below the wavelength of 625 nm. As a result, Class A NVGs amplify more wavelengths of visible light, so they require special care in the use of colour in the cockpit. Applicants are advised that Class A NVGs are deemed to be not acceptable for certification by EASA.

[...]

- (9) Point 21.A.91 of Annex I to Regulation (EU) No 748/2012 contains the criteria for the classification of changes to a type certificate. For NVIS approved rotorcraft, experience has shown that some changes, which are classified as being minor according to the AMC to 21.A.91 for unaided flight, may have an appreciable effect on the cockpit/cabin lighting characteristics, and thus on crew vision through the NVGs. Therefore, the classification of design changes of NVIS approved rotorcraft should take into account the effects on cockpit/cabin lighting characteristics and the NVIS.

[...]

f. Procedures.

[...]

- (6) Required equipment, instrument arrangement and visibility.
- (i) In addition to the instruments and equipment required for flight at night, the following additional instruments and equipment will typically be necessary for NVG operations (to be defined for each helicopter). The applicable operational regulations that specify aircraft equipment required for night and NVG operations should be reviewed.
- (A) NVIS lighting.

- (B) A helmet with suitable NVG mount for each pilot and crew member required to use NVGs.
- (C) NVGs for each pilot and crew members required to use NVGs.
- (D) Point SPA.NVIS.110(b) of Annex V (Part-SPA) to Regulation (EU) 965/2012 on air operations, and the associated AMC and GM, requires a radio altimeter with analogue representation. It is recommended that an applicant carries out a careful evaluation of the radio altimeter human-machine interface (including the presentation of height and the possibility of selecting the DH) to establish that it is able to provide the crew with the necessary information.
- (E) A slip/skid indicator.
- (F) A gyroscopic attitude indicator.
- (G) A gyroscopic direction indicator or equivalent.
- (H) Vertical speed indicator or its equivalent.
- (I) Communications and navigation equipment necessary for the successful completion of an inadvertent IMC procedure in the intended area of operations.
- (J) Any other aircraft or personal equipment required for the operation (e.g., curtains, NVG stowage, extra batteries for NVGs).

[Amdt No: 29/6]

MG 17 Guidance on analysing an Advanced Flight Controls (AdFC) System

ED Decision 2018/015/R

The guidance contained within FAA AC 29-2C Change 7 MG 17 has been deemed by EASA to be at variance with EASA's interpretation or its regulatory system and therefore should not be considered to be EASA acceptable means of compliance.

[Amdt No: 29/6]

MG 21 Guidance on creating a system level Functional Hazard Assessment (FHA)

ED Decision 2018/015/R

The guidance contained within FAA AC 29-2C Change 7 MG 21 has been deemed by EASA to be at variance with EASA's interpretation or its regulatory system and therefore should not be considered to be EASA acceptable means of compliance.

[Amdt No: 29/6]

MG 23 Automatic Flight Guidance and Control Systems (AFGCS) installation in CS-29 Rotorcraft

ED Decision 2018/015/R

This AMC provides further guidance and acceptable means of compliance to supplement FAA AC 29-2C Change 7 MG 23, which is the EASA acceptable means of compliance, as provided for in [AMC 29 General](#). However, some aspects of the FAA AC are deemed by EASA to be at variance with EASA's interpretation or its regulatory system. EASA's interpretation of these aspects is described below. Paragraphs of FAA AC 29-2C Change 7 MG 23 that are not amended below are considered to be EASA acceptable means of compliance.

a. Purpose.

- (1) The following Radio Technical Commission for Aeronautics (RTCA) documents are considered to be guidance for showing compliance with the relevant certification specifications for the installation of automatic flight control guidance and control systems (AFGCS).
 - (i) RTCA Document DO-325, *Minimum Operational Performance Standards (MOPS) for Automatic Flight Guidance and Control Systems and Equipment*, issued 8 December 2010.
 - (ii) RTCA Document DO-336, *Guidance for Certification of Installed Automatic Flight Guidance and Control Systems (AFGCS) for Part 27/29 Rotorcraft*, issued 21 March 2012.
- (2) RTCA Document DO-325 contains the minimum operational performance standards (MOPS) for AFGCS equipment. DO-336 provides guidance on obtaining installation approval of AFGCS in rotorcraft. It invokes parts of DO-325 as the performance standards that are applicable for the installation of AFGCS equipment in rotorcraft. It provides guidance on conducting a safety assessment. Lastly, DO-336 provides lists of the regulations that can be applicable to an AFGCS installation and potential methods of compliance with those regulations.
- (3) The guidance contained in DO-336 and DO-325 is not mandatory and provides guidance for showing compliance with the applicable provisions of CS-29.

Note: following this guidance alone does not guarantee acceptance by EASA. EASA may require additional substantiation or design changes as a basis for finding compliance.

b. Guidance for the use of RTCA Documents DO-325 and DO-336.

RTCA Document DO-336 has two primary focus items: to highlight the requirements for a proper safety assessment (Chapter 8) and the compliance demonstration (Chapter 9).

Note: each of these should be discussed with EASA very early in the certification programme, and included in the certification plan.

c. References.

- (1) CS-29 provisions

Paragraph	Title
29.671	General. (Control Systems)
29.672	Stability augmentation, automatic, and power-operated systems.
29.1309	Equipment, systems, and installations.
29.1329	Automatic pilot system.

Paragraph	Title
29.1335	Flight director systems.
Appendix B to CS-29	Airworthiness Criteria for Helicopter Instrument flight

- (2) AMC/ACs (available at <http://rgl.faa.gov/>) or <https://www.easa.europa.eu/document-library/certification-specifications/group/amc-20-general-acceptable-means-of-compliance-for-airworthiness-of-products-parts-and-appliances#group-table>)

AMC/AC	Title
20-115D	Airborne Software Development Assurance Using EUROCAE ED-12 and RTCA DO-178
20-138	Airworthiness Approval of Positioning and Navigation Systems
20-152	RTCA, Inc., Document RTCA/DO-254, Design Assurance Guidance for Airborne Electronic Hardware.
21-50	Installation of TSOA Articles and LODA Appliances
29-2C, Section 29.671	Control Systems - General.
29-2C, Section 29.672	Stability Augmentation, Automatic, and Power-Operated Systems.
29-2C, Section 29.1309	Equipment, Systems, and Installations.
29-2C, Section 29.1329	Automatic Pilot System.
29-2C, Section 29.1335	Flight Director Systems.

- (3) Industry standards (RTCA documents are available at www.rtca.org and SAE international documents are available at www.sae.org):

Document	Title
RTCA/ DO-178	Software Considerations in Airborne Systems and Equipment Certification
RTCA/ DO-254	Design Assurance Guidance for Airborne Electronic Hardware
RTCA/ DO-325	Minimum Operational Performance Standards (MOPS) for Automatic Flight Guidance and Control Systems and Equipment, issued December 8, 2010.
RTCA/ DO-336	Guidance for Certification of Installed Automatic Flight Guidance and Control Systems (AFGCS) for Part 27/29 Rotorcraft, issued March 21, 2012.
SAE, International ARP 4754A	Guidelines for Development of Civil Aircraft and Systems
SAE, International ARP 4761	Guidelines and Methods for Conducting the Safety Assessment Process on Civil Airborne Systems and Equipment

[Amdt No: 29/6]